



















THOMPSON TRADERS









2020 Pricelist









Kitchen Sinks











Apron Front



| Former Name | New Name | Item Code | Finish | Dimensions (OD) | Dimensions (ID) | Image | MSRP | COO | Freight USA | Freight Canada |
|------------------------------|----------------|-------------|---|-----------------|-----------------------------------|---|----------|-------|-------------|----------------|
| Petit Lucca | Quiroga | KSA-2522AH | Antique Copper (formally medium antique) | 25" x 22" x 9" | 22" x 19" x 9" |  | \$ 1,281 | India | G | H |
| Lucca | Quiroga | KSA-3322AH | Antique Copper (formally medium antique) | 33" x 22" x 9" | 30" x 19" x 9" |  | \$ 1,399 | India | G | H |
| Corniglia | Quiroga | KDA-3322AH | Antique Copper (formally medium antique) | 33" x 22" x 9" | Bowl Dimensions 14" x 19" x 9" |  | \$ 1,517 | India | G | H |
| Hammered Stainless Lucca | Quiroga | KSA-3322HSS | Stainless Steel | 33" x 22" x 9" | 30" x 19" x 9" |  | \$ 1,537 | India | G | H |
| Hammered Stainless Corniglia | Quiroga | KDA-3322HSS | Stainless Steel | 33" x 22" x 9" | Bowl Dimensions 14" x 19" x 9" |  | \$ 1,630 | India | G | H |
| Hammered Brass Lucca | Quiroga | KSA-3322HPB | Brass | 33" x 22" x 9" | 30" x 19" x 9" |  | \$ 1,589 | India | G | H |

| Former Name | New Name | Item Code | Finish | Dimensions (OD) | Dimensions (ID) | Image | MSRP | COO | Freight USA | Freight Canada |
|---------------------|-----------------|------------|-------------------------------------|-----------------|-----------------|---|-----------------|---------------|-------------|----------------|
| Toscana | Cardenas | 2KS | Aged Copper (formally black copper) | 33" x 22" x 10" | 30" x 19" x 10" |  | \$ 2,255 | Mexico | I | J |
| Petite Toscana | Cardenas | KSA-2522BC | Aged Copper (formally black copper) | 25" x 22" x 10" | 23" x 22" x 10" |  | \$ 1,814 | Mexico | G | H |
| Former Name | New Name | Item Code | Finish | Dimensions (OD) | Dimensions (ID) | Image | MSRP | COO | Freight USA | Freight Canada |
| Tiered Lucca | Kahlo | 2KS-T | Rose Gold | 33" x 22" x 9" | 30" x 19" x 9" |  | \$ 2,563 | Mexico | I | J |
| Gari | Kahlo | 2KS-RG | Rose Gold | 33" x 22" x 9" | 30" x 19" x 9" |  | \$ 2,153 | Mexico | I | J |
| Silver Line | Kahlo | 2KS-SL | Aged Copper | 33" x 22" x 9" | 30" x 19" x 9" |  | \$ 2,153 | Mexico | I | J |
| Mini Toscana | Kahlo | KPA-1715BC | Aged Copper | 17" x 15" x 8" | 14" x 13" x 8" |  | \$ 1,332 | Mexico | D | E |
| Cordate Petit Lucca | Kahlo | KPA-1715C | Rose Gold/Black Nickel | 17" x 15" x 8" | 15" x 13" x 8" |  | \$ 1,650 | Mexico | D | E |
| Tiered Petit Lucca | Kahlo | KPA-1715T | Rose Gold | 17" x 15" x 8" | 15" x 13" x 8" |  | \$ 1,363 | Mexico | D | E |
| Custom Toscana | Kahlo | 2KS-AD-1 | Aged Copper (formally black copper) | 33" x 22" x 10" | 30" x 19" |  | \$ 2,392 | Mexico | I | J |
| Custom Toscana | Kahlo | 2KS-AD-2 | Aged Copper (formally black copper) | 33" x 22" x 10" | 30" x 19" |  | \$ 2,392 | Mexico | I | J |

| Custom Toscana | Kahlo | 2KS-AD-3 | Aged Copper (formally black copper) | 33" x 22" x 10" | 30" x 19" |  | \$ 2,332 | Mexico | I | J |
|-------------------------------|-----------------|------------------|---|------------------------|------------------------|---|-----------------|---------------|--------------------|-----------------------|
| Custom Toscana | Kahlo | 2KS-AD-4 | Aged Copper (formally black copper) | 33" x 22" x 10" | 30" x 19" |  | \$ 2,392 | Mexico | I | J |
| Custom Toscana | Kahlo | 2KS-AD-5 | Aged Copper (formally black copper) | 33" x 22" x 10" | 30" x 19" |  | \$ 2,392 | Mexico | I | J |
| Under Mount - Drop In | | | | | | | | | | |
| Former Name | New Name | Item Code | Finish | Dimensions (OD) | Dimensions (ID) | Image | MSRP | | Freight USA | Freight Canada |
| Pisa | Villa | KSU-3020AH | Antique Copper (formally medium antique) | 30" x 20" x 9" | 27" x 17" x 9" |  | \$ 1,164 | India | G | H |
| Monterosso | Villa | KDU-3120AH | Antique Copper (formally medium antique) | 31" x 20" x 9" | 28" x 18" x 9" |  | \$ 1,230 | India | G | H |
| Hammered Stainless Pisa | Villa | KSU-3020HSS | Stainless Steel | 30" x 20" x 9" | 27" x 17" x 9" |  | \$ 1,281 | India | G | H |
| Hammered Stainless Monterosso | Villa | KDU-3120HSS | Stainless Steel | 31" x 20" x 9" | 28" x 18" x 9" |  | \$ 1,368 | India | G | H |
| | Villa | KSU-3118HSS | Stainless Steel | 31" x 18" x 9" | 28" x 15" x 9" |  | \$ 1,281 | India | G | H |

| Other | | | | | | | | | | |
|-------------------------|----------------|-------------|--|-------------------------|----------------------|---|----------|---------------|-------------|----------------|
| Former Name | New Name | Item Code | Finish | Dimensions (OD) | Dimensions (ID) | Image | MSRP | | Freight USA | Freight Canada |
| 60/40 | Hidalgo | KDU-6040BC | Aged Copper (formally black copper) | 31" x 20" x 10" | 29" x 28" x 10" |  | \$ 2,153 | Mexico | G | H |
| Former Name | New Name | Item Code | Finish | Dimensions (OD) | Dimensions (ID) | Image | MSRP | | Freight USA | Freight Canada |
| Country Toscana | Diaz | KSD-3022BC | Aged Copper (formally black copper) | 30" x 22" x 10-15" | 26.5" x 18" x 10-15" |  | \$ 2,102 | Mexico | I | J |
| Bar Prep Sinks | | | | | | | | | | |
| Former Name | New Name | Item Code | Finish | Dimensions (OD) | Dimensions (ID) | Image | MSRP | | Freight USA | Freight Canada |
| Vernazza | Rivera | NS25033H | Antique Copper (formally medium antique) | 21 1/2" x 19 1/2" x 10" | 18" x 16" x 10" |  | \$ 717 | India | D | E |
| Hammered Stainless Como | Rivera | KPU-1715HSS | Stainless Steel | 17" x 15" x 8" | 15" x 13" x 8" |  | \$ 512 | India | D | E |
| Hammered Nickel Como | Rivera | KPU-1715BRN | Nickel | 17" x 15" x 8" | 15" x 13" x 8" |  | \$ 461 | India | D | E |
| Hammered Brass Como | Rivera | KPU-1715HPB | Brass | 17" x 15" x 8" | 15" x 13" x 8" |  | \$ 543 | India | D | E |
| Black Copper Como | Rivera | KPU-1715BC | Aged Copper (formally black copper) | 17" x 15" x 8" | 15" x 13" x 8" |  | \$ 512 | India | D | E |
| Medium Antique Como | Rivera | KPU-1715HA | Antique Copper (formally medium antique) | 17" x 15" x 8" | 15" x 13" x 8" |  | \$ 419 | India | D | E |

| Former Name | New Name | Item Code | Finish | Dimensions (OD) | Dimensions (ID) | Image | MSRP | Freight USA | Freight Canada | |
|----------------------------|-------------------|------------|--|------------------------|------------------------|---|--------|-------------|----------------|---|
| Antique Copper Picasso | Tamayo | 1SAC | Antique Copper (formally medium antique) | 15 5/8" x 15 5/8" x 7" | 13 5/8" x 13 5/8" x 7" |  | \$ 419 | India | D | E |
| Hammered Nickel Picasso | Tamayo | 1S-BRN | Nickel | 15 5/8" x 15 5/8" x 7" | 14 5/8" x 14 5/8" x 7" |  | \$ 461 | India | D | E |
| Hammered Stainless Picasso | Tamayo | 1S-HSS | Stainless Steel | 15 5/8" x 15 5/8" x 7" | 14 5/8" x 14 5/8" x 7" |  | \$ 409 | India | D | E |
| Palla | Tamayo | 1SPC-LA | Rose Gold | 15 5/8" x 15 5/8" x 7" | 13 5/8" x 13 5/8" x 7" |  | \$ 512 | Mexico | D | E |
| Picasso II | Tamayo | 3PSS | Fired Copper | 12" x 5" | 10" x 5" |  | \$ 307 | Mexico | D | E |
| Picasso | Tamayo | 3SBC | Aged Copper (formally black copper) | 12" x 5" | 10" x 5" |  | \$ 307 | Mexico | D | E |
| Former Name | New Name | Item Code | Finish | Dimensions (OD) | Dimensions (ID) | Image | MSRP | Freight USA | Freight Canada | |
| Antique Copper Napoli | De la Cruz | PU-1708MA | Antique Copper (formally medium antique) | 17" x 8" | 15" x 8" |  | \$ 461 | India | D | E |
| Hammered Nickel Napoli | De la Cruz | PU-1708BRN | Nickel | 17" x 8" | 15" x 8" |  | \$ 635 | India | D | E |
| Hammered Stainless Napoli | De la Cruz | PU-1708HSS | Stainless Steel | 17" x 8" | 15" x 8" |  | \$ 532 | India | D | E |
| Petit Napoli | De la Cruz | KPD-1207BC | Aged Copper (formally black copper) | 12 1/2" x 7" | 11" x 7" |  | \$ 378 | Mexico | D | E |









| Napoli | De la Cruz | KPU-1708BC | Aged Copper (formally black copper) | 17" x 8" | 15" x 8" |  | \$ 532 | Mexico | D | E |
|-------------|-------------------|------------|--|------------------------|----------------------|---|-----------------|---------------|----------------|---|
| Former Name | New Name | Item Code | Finish | Dimensions (OD) | Dimensions (ID) | Image | MSRP | Freight USA | Freight Canada | |
| D-Bowl | Oroz | KSU-2321BC | Black Copper | 23 1/2" x 21 1/2" x 9" | 21" x 18 1/2" x 9" |  | \$ 1,250 | Mexico | G | H |
| Former Name | New Name | Item Code | Finish | Dimensions (OD) | Dimensions (ID) | Image | MSRP | Freight USA | Freight Canada | |
| Sorento | Paz | KRM-BC | Black Copper | 28" x 10" x 6 1/2"-4" | 25" x 7" x 6 1/2"-4" |  | \$ 973 | Mexico | D | E |



THOMPSON TRADERS





Bathroom Sinks

Under Mount/Drop In





| Former Name | New Name | Item Code | Finish | Dimensions (OD) | Dimensions (ID) | Image | MSRP | COO | Freight USA | Freight Canada |
|----------------------------|------------------|------------|--|------------------------|---------------------------|---|--------|--------|-------------|----------------|
| Fired Copper Matisse | Huacana | 2OP | Fired Copper | 19" x 13 3/4" x 5" | 17" x 11 3/4" x 5" |  | \$ 348 | Mexico | D | F |
| Matisse | Huacana | 2OBC | Aged Copper (formally black copper) | 19" x 13 3/4" x 5" | 17" x 11 3/4" x 5" |  | \$ 348 | Mexico | D | F |
| Brushed Nickel Matisse | Huacana | 2OBC-BRN | Nickel | 19" x 13 3/4" x 5" | 17" x 11 3/4" x 5" |  | \$ 348 | India | D | F |
| Black Nickel Matisse | Huacana | 2OBC-BN | Black Nickel | 19" x 13 3/4" x 5" | 17" x 11 3/4" x 5" |  | \$ 522 | Mexico | D | F |
| Petit Matisse | Huacana | BOU-1209BC | Aged Copper (formally black copper) | 12" x 9" x 3 3/4" | 10 1/4" x 7 1/2" x 3 3/4" |  | \$ 235 | Mexico | D | F |
| Diamond Quilt Matisse | Huacana | 2OBN-DQ | Black Nickel | 19" x 17 3/4" x 6 1/2" | 17" x 11 3/4" x 6 1/2" |  | \$ 718 | Mexico | D | F |
| Antique Satin Gold Matisse | Huacana | 2OASG | Antique Satin Gold | 19" x 13 3/4" x 5" | 17" x 11 3/4" x 5" |  | \$ 522 | Mexico | D | F |
| Former Name | New Name | Item Code | Finish | Dimensions (OD) | Dimensions (ID) | Image | MSRP | COO | Freight USA | Freight Canada |
| Alder II | Tacambaro | 2RP | Fired Copper | 15 1/2" x 5" | 13 1/2" x 5" |  | \$ 327 | Mexico | D | F |
| Medium Antique Alder | Tacambaro | 2RP-AC | Antique Copper (formally medium antique) | 15 1/2" x 5" | 13 1/2" x 5" |  | \$ 327 | India | D | F |

| | | | | | | | | | | |
|------------------------------|------------------|-------------|-------------------------------------|--------------|--------------|---|--------|--------|---|---|
| Black Copper Alder | Tacambaro | 2RP-BC | Aged Copper (formally black copper) | 15 1/2" x 5" | 13 1/2" x 5" |  | \$ 327 | Mexico | D | F |
| Brushed Nickel Alder | Tacambaro | 2RP-BRN | Nickel | 15 1/2" x 5" | 13 1/2" x 5" |  | \$ 327 | India | D | F |
| Black Nickel Hawthorne | Tacambaro | BNRWR | Black Nickel | 15 1/2" x 5" | 13 1/2" x 5" |  | \$ 522 | Mexico | D | F |
| Milagro II | Tacambaro | BRD-1555ASG | Antique Satin Gold | 15 1/2" x 5" | 13 1/2" x 5" |  | \$ 454 | Mexico | D | F |
| Pavone Alder | Tacambaro | 2RP-P | Brass and Nickel | 15 1/2" x 5" | 13 1/2" x 5" |  | \$ 797 | Mexico | D | F |
| Antique Satin Gold Hawthorne | Tacambaro | ASGRWR | Antique Satin Gold | 15 1/2" x 5" | 13 1/2" x 5" |  | \$ 454 | Mexico | D | F |



Drop In









| Former Name | New Name | Item Code | Finish | Dimensions (OD) | Dimensions (ID) | Image | MSRP | Freight USA | Freight Canada | |
|---------------------------|----------------|-------------|-------------------------------------|--------------------|--------------------|---|--------|-------------|----------------|---|
| Pavone Nantucket | Morelia | BOD-1914P | Brass and Nickel | 19" x 14" x 4 1/2" | 13" x 10" x 4 1/2" |  | \$ 911 | Mexico | D | F |
| Nantucket Black Copper | Morelia | BOD-1914BC | Aged Copper (formally black copper) | 19" x 14" x 4 1/2" | 13" x 10" x 4 1/2" |  | \$ 686 | Mexico | D | F |
| Nantucket Polished Nickel | Morelia | BOD-1914PN | Nickel | 19" x 14" x 4 1/2" | 13" x 10" x 4 1/2" |  | \$ 686 | India | D | F |
| Nantucket Gold | Morelia | BOD-1914ASG | Antique Satin Gold | 19" x 14" x 4 1/2" | 13" x 10" x 4 1/2" |  | \$ 686 | Mexico | D | F |









Drop In/Undermount w/Overflow









| Former Name | New Name | Item Code | Finish | Dimensions (OD) | Dimensions (ID) | Image | MSRP | Freight USA | Freight Canada |
|-----------------------|----------------|-------------|-------------------------------------|----------------------------|----------------------------|--|--------|-------------|----------------|
| Black Copper Farley | Uruapan | BOU-1915BC | Aged Copper (formally black copper) | 19 1/4" x 15 1/4" x 6 1/2" | 17 1/4" x 14 1/4" x 6 1/2" |  | \$ 337 | India | D F |
| Brushed Nickel Farley | Uruapan | BOU-1915BRN | Nickel | 19 1/4" x 15 1/4" x 6 1/2" | 17 1/4" x 14 1/4" x 6 1/2" |  | \$ 399 | India | D F |
| Former Name | New Name | Item Code | Finish | Dimensions (OD) | Dimensions (ID) | Image | MSRP | Freight USA | Freight Canada |
| Black Copper Starr | Taxco | BRU-2115BC | Aged Copper (formally black copper) | 21" x 14.5" x 6.5" | 19" x 12.5" x 6.5" |  | \$ 466 | India | D F |
| Starr | Taxco | BRU-2115BRN | Nickel | 21" x 14.5" x 6.5" | 19" x 12.5" x 6.5" |  | \$ 466 | India | D F |
| Hammered Brass Starr | Taxco | BRU-2115HMB | Brass | 21" x 14.5" x 6.5" | 19" x 12.5" x 6.5" |  | \$ 489 | India | D F |



Drop In/Undermount



| Former Name | New Name | Item Code | Finish | Dimensions (OD) | Dimensions (ID) | Image | MSRP | Freight USA | Freight Canada |
|-----------------------|---------------|-------------|-------------------------------------|-----------------|-----------------|---|----------|-------------|----------------|
| Diego | Tonala | BPU-1914BC | Aged Copper (formally black copper) | 19" x 14" x 5" | 17" x 12" x 5" |  | \$ 584 | Mexico | D F |
| Hammered Nickel Diego | Tonala | BPU-1914BRN | Nickel | 19" x 14" x 5" | 17" x 12" x 5" |  | \$ 584 | India | D F |
| Argyle Diego | Tonala | BPU-1914PQ | Antique Satin Gold | 18" x 14" x 5" | 16" x 12" x 5" |  | \$ 1,025 | Mexico | D F |





| Antique Satin Gold Diego | Tonala | BPU-1914ASG | Antique Satin Gold | 19" x 14" x 5" | 17" x 12" x 5" |  | \$ 751 | Mexico | D | F |
|--------------------------|-------------------|--------------|-------------------------------------|--------------------|----------------------------|---|----------|-------------|----------------|---|
| Brass Diego | Tonala | BPU-1914PB | Polished Brass | 19" x 14" x 5" | 17" x 12" x 5" |  | \$ 819 | Mexico | D | F |
| Diego II | Tonala | BPV-1914BC | Aged Copper (formally black copper) | 19" x 14" x 5" | 17" x 12" x 5" |  | \$ 724 | Mexico | D | F |
| Former Name | New Name | Item Code | Finish | Dimensions (OD) | Dimensions (ID) | Image | MSRP | Freight USA | Freight Canada | |
| Rivera | San Miguel | BSU-20ASG | Antique Stain Gold | 20" x 17" x 5 1/2" | 17 3/4" x 14 3/4" x 5 1/2" |  | \$ 1,138 | Mexico | D | F |
| Vessel Mount | | | | | | | | | | |
| Former Name | New Name | Item Code | Finish | Dimensions (OD) | Dimensions (ID) | Image | MSRP | Freight USA | Freight Canada | |
| Black Copper Beech | Leon | 2RW/OR-BC | Aged Copper (formally black copper) | 16" x 6" | 15 1/4" x 6" |  | \$ 348 | Mexico | D | F |
| Black Nickel Beech | Leon | 2RW/OR-BN | Black Nickel | 16" x 6" | 15 1/4" x 6" |  | \$ 522 | Mexico | D | F |
| Palla | Leon | BRV-14ASG | Antique Satin Gold | 13 1/3" x 5" | 13 1/3" x 5" |  | \$ 683 | Mexico | D | F |
| Petit Manet | Leon | P-23-1223-A | Nickel | 14" x 5 1/2" | 13 1/2" x 5 1/2" |  | \$ 233 | India | D | F |
| Petit Manet Black Copper | Leon | P-23-1223-BC | Aged Copper (formally black copper) | 14" x 5 1/2" | 13 1/2" x 5 1/2" |  | \$ 233 | India | D | F |







| Roma | Leon | BRV-15625BC | Aged Copper (formally black copper) | 15" x 6" | 14 1/4" x 6" |  | \$ 546 | Mexico | D | F |
|---------------------------------|--------------------|--------------|---|----------------------------|----------------------------|---|----------|-------------|----------------|---|
| Former Name | New Name | Item Code | Finish | Dimensions (OD) | Dimensions (ID) | Image | MSRP | Freight USA | Freight Canada | |
| Milagro | Guadalupe | BRV-1506ASG | Antique Satin Gold | 15 1/2" x 5 1/2" | 13 1/2" x 5 1/2" |  | \$ 911 | Mexico | D | F |
| FLW | Guadalupe | NS25029-A | Antique Copper (formally medium antique) | 18" x 6.5" | 15 1/2" x 6.5" |  | \$ 584 | Mexico | D | F |
| FLW II | Guadalupe | FLW-S | Stainless Interior & Antique Copper Exterior (formally medium antique) | 16" x 6" | 14" x 6" |  | \$ 490 | India | D | F |
| Former Name | New Name | Item Code | Finish | Dimensions (OD) | Dimensions (ID) | Image | MSRP | Freight USA | Freight Canada | |
| Beaker | Santa Clara | BOV-2016BC | Smooth Aged Copper (formally black copper) | 20 1/8" x 16 5/8" x 4 1/8" | 20 1/8" x 16 5/8" x 4 1/8" |  | \$ 850 | Mexico | D | F |
| Beaker Verde | Santa Clara | BOV-2016VTP | Smooth Aged Copper (formally black copper) Interior with Verde Exterior | 20 1/8" x 16 5/8" x 4 1/8" | 20 1/8" x 16 5/8" x 4 1/8" |  | \$ 912 | Mexico | D | F |
| Former Name | New Name | Item Code | Finish | Dimensions (OD) | Dimensions (ID) | Image | MSRP | Freight USA | Freight Canada | |
| Chakra Double Wall Black Nickel | Puebla | BRV-1916BLKN | Black Nickel | 19" x 17" x 4 1/2" | 17" x 15" x 4 1/2" |  | \$ 1,168 | Mexico | D | F |
| Chakra | Puebla | CASG | Antique Satin Gold | 19" x 16 x 4" | 19" x 16" x 4" |  | \$ 642 | Mexico | D | F |
| Diamond Quilt | Puebla | CASG-DQ | Antique Satin Gold | 19" x 16" x 4" | 19" x 16" x 4" |  | \$ 1,025 | Mexico | D | F |







| Hammered Nickel Chakra | Puebla | CASG-BRN | Nickel | 19" x 16 3/4" x 4" | 19" x 16 3/4" x 4" |  | \$ 584 | India | D | F |
|------------------------|----------------|--------------|--|------------------------|------------------------|---|--------|---------------|-------------|----------------|
| Chakra Cordate | Puebla | CASG-C | Rose Gold | 19" x 16" x 4" | 19" x 16" x 4" |  | \$ 797 | Mexico | D | F |
| Pavone | Puebla | BOV-1917P | Brass and Nickel | 19" x 16" x 4" | 19" x 16" x 4" |  | \$ 933 | Mexico | D | F |
| Former Name | New Name | Item Code | Finish | Dimensions (OD) | Dimensions (ID) | Image | MSRP | | Freight USA | Freight Canada |
| Karma | Cordoba | KBC | Aged Copper (formally black copper) | 21"x 12" x 5" | 21"x 12" x 5" |  | \$ 546 | Mexico | D | F |
| Gold Karma | Cordoba | KBC-ASG | Antique Satin Gold | 21"x 12" x 5" | 21"x 12" x 5" |  | \$ 717 | Mexico | D | F |
| Former Name | New Name | Item Code | Finish | Dimensions (OD) | Dimensions (ID) | Image | MSRP | | Freight USA | Freight Canada |
| Calder | Ocampo | NS25036 | Antique Copper (formally medium antique) | 18 1/2" x 12" x 5 1/2" | 17" x 10 1/4" x 5 1/2" |  | \$ 349 | India | D | F |
| Brushed Nickel Calder | Ocampo | NS25036-BRN | Nickel | 18 1/2" x 12" x 5 1/2" | 17" x 10 1/4" x 5 1/2" |  | \$ 349 | India | D | F |
| Former Name | New Name | Item Code | Finish | Dimensions (OD) | Dimensions (ID) | Image | MSRP | | Freight USA | Freight Canada |
| Chelsea II | Coroneo | BSV-1212BC | Aged Copper (formally black copper) | 12" x 3" | 12" x 3" |  | \$ 592 | Mexico | D | F |
| Chelsea | Coroneo | BSDC-1203ASG | Antique Satin Gold | 12" x 3" | 12" x 3" |  | \$ 831 | Mexico | D | F |



| | | | | | | | | | | |
|---------|----------------|-------------|--|----------------|----------------|---|----------|--------|---|---|
| Tribeca | Coroneo | BSDC-1212BC | Aged Copper (formally black copper) | 12.5" x 5" | 12.5" x 5" |  | \$ 1,025 | Mexico | D | F |
| Milan | Coroneo | MBN | Black Nickel | 22" x 16" x 6" | 20" x 14" x 6" |  | \$ 1,399 | Mexico | D | F |



| Former Name | New Name | Item Code | Finish | Dimensions (OD) | Dimensions (ID) | Image | MSRP | Freight USA | Freight Canada | |
|-----------------|-----------------|-----------|--|-----------------|-----------------|---|----------|-------------|----------------|---|
| Metropoli | Cortazar | MP | Nickel | 15" x 6" | 13 1/2" x 6" |  | \$ 653 | India | D | F |
| Baccus | Cortazar | RCDW | Aged Copper (formally black copper) | 17" x 6 1/2" | 15" x 6 1/2" |  | \$ 568 | Mexico | D | F |
| Baccus Tornasol | Cortazar | RTW | Mult-Colored | 17" x 6 1/2" | 15" x 6 1/2" |  | \$ 1,982 | Mexico | D | F |

| Former Name | New Name | Item Code | Finish | Dimensions (OD) | Dimensions (ID) | Image | MSRP | Freight USA | Freight Canada | |
|----------------------|----------------|-----------|--|------------------------|------------------------|---|----------|-------------|----------------|---|
| Black Nirvana | Arandas | NSP-BC | Aged Copper (formally black copper) | 18" x 15" x 5 3/4" | 18" x 15" x 5 3/4" |  | \$ 911 | Mexico | D | F |
| Nirvana | Arandas | NSP | Nickel | 18" x 15" x 5 3/4" | 18" x 15" x 5 3/4" |  | \$ 1,399 | India | D | F |
| Nirvana Palla | Arandas | NSP-LA | Rose Gold | 18" x 15" x 5 3/4" | 18" x 15" x 5 3/4" |  | \$ 1,229 | Mexico | D | F |
| Solid Copper Nirvana | Arandas | NSC-RG | Rose Gold | 18" x 15 3/4" x 5 3/4" | 18" x 15 3/4" x 5 3/4" |  | \$ 2,502 | Mexico | G | H |

| Former Name | New Name | Item Code | Finish | Dimensions (OD) | Dimensions (ID) | Image | MSRP | Freight USA | Freight Canada |
|-------------|-------------------|--------------|---|----------------------------|----------------------------|---|----------|-------------|----------------|
| Prana | Altamira | PBC | Aged Copper (formally black copper) | 17" x 14" x 6" | 15" x 12" x 6" |  | \$ 653 | Mexico | D F |
| Oceanus II | Altamira | PBC-ASG | Antique Satin Gold with Nickel Accents | 17" x 14" x 6" | 15" x 12" x 6" |  | \$ 1,159 | Mexico | D F |
| Former Name | New Name | Item Code | Finish | Dimensions (OD) | Dimensions (ID) | Image | MSRP | Freight USA | Freight Canada |
| Otono II | Teopantlan | OLBC-HW | Aged Copper (formally black copper) | 25" x 15" x 3 1/2" | 20" x 14 1/4" x 3 1/2" |  | \$ 1,047 | Mexico | D F |
| Former Name | New Name | Item Code | Finish | Dimensions (OD) | Dimensions (ID) | Image | MSRP | Freight USA | Freight Canada |
| Zuma | Villamar | BSV-1516SBC | Aged Copper (formally black copper) | 15 5/8" x 16 5/8" x 4" | 15 5/8" x 16 5/8" x 4" |  | \$ 2,554 | Mexico | D F |
| Former Name | New Name | Item Code | Finish | Dimensions (OD) | Dimensions (ID) | Image | MSRP | Freight USA | Freight Canada |
| Naples | Vallarta | BSV-1915SASG | Antique Satin Gold | 19 7/8" x 15 1/2" x 4 1/4" | 19 7/8" x 15 1/2" x 4 1/4" |  | \$ 1,999 | Mexico | D F |
| Former Name | New Name | Item Code | Finish | Dimensions (OD) | Dimensions (ID) | Image | MSRP | Freight USA | Freight Canada |
| Marco | Acapulco | BSV-2211ASG | Antique Satin Gold | 22 1/2" x 11" x 6" | 22 1/2" x 11" x 6" |  | \$ 1,999 | Mexico | D F |
| Former Name | New Name | Item Code | Finish | Dimensions (OD) | Dimensions (ID) | Image | MSRP | Freight USA | Freight Canada |
| Laguna | Acatlan | BRV-13ASG | Rose Gold Interior/ White Enamel Exterior | 13 7/8" x 5 1/8" | 13 7/8" x 5 1/8" |  | \$ 621 | Mexico | D F |
| Former Name | New Name | Item Code | Finish | Dimensions (OD) | Dimensions (ID) | Image | MSRP | Freight USA | Freight Canada |

| Ibiza | Patzcuaro | BOV-2907ASG | Rose Gold | 29" x 7 1/2" x 6" | 10 1/2" x 7 1/2" x 6" |  | \$ 2,999 | Mexico | D | F |
|-------------|--------------------|--------------|-------------------------------------|----------------------------|----------------------------|---|----------|-------------|----------------|---|
| Former Name | New Name | Item Code | Finish | Dimensions (OD) | Dimensions (ID) | Image | MSRP | Freight USA | Freight Canada | |
| Ovalo | Otomi | BRV-1914TT | Rose Gold Interior/Nickel Exterior | 19" x 6 1/2" x 6 1/2" | 18 3/4" x 6 1/4" x 6 1/2" |  | \$ 1,138 | Mexico | D | F |
| Former Name | New Name | Item Code | Finish | Dimensions (OD) | Dimensions (ID) | Image | MSRP | Freight USA | Freight Canada | |
| Moon Wrasse | Zihuatanejo | 23-1221-C | Nickel | 17 3/4" x 15 1/4" x 6 1/2" | 15 3/4" x 13 1/4" x 6 1/2" |  | \$ 409 | India | D | F |
| Former Name | New Name | Item Code | Finish | Dimensions (OD) | Dimensions (ID) | Image | MSRP | Freight USA | Freight Canada | |
| Murano | Campeche | 23-1222-C | Rose Gold and Oil Rubbed Bronze | 16 1/4" x 7 1/2" | 14 1/4" x 7 1/2" |  | \$ 409 | Mexico | D | F |
| Former Name | New Name | Item Code | Finish | Dimensions (OD) | Dimensions (ID) | Image | MSRP | Freight USA | Freight Canada | |
| Antibes | Tehuacan | 2RBC-W | Aged Copper (formally black copper) | 19" x 14" x 4 1/2" | 17" x 12" x 4 1/2" |  | \$ 1,014 | Mexico | D | F |
| Former Name | New Name | Item Code | Finish | Dimensions (OD) | Dimensions (ID) | Image | MSRP | Freight USA | Freight Canada | |
| Soho | Texcoco | BPCD-1812BC | Aged Copper (formally black copper) | 18" x 12" x 3" | 18" x 12" x 3" |  | \$ 911 | Mexico | D | F |
| Former Name | New Name | Item Code | Finish | Dimensions (OD) | Dimensions (ID) | Image | MSRP | Freight USA | Freight Canada | |
| San Tropez | Soltepec | BRSD-1914ASG | Antique Satin Gold | 19" x 14" x 4 1/2" | 13 1/2" x 11" x 4 1/2" |  | \$ 1,172 | Mexico | D | F |
| Former Name | New Name | Item Code | Finish | Dimensions (OD) | Dimensions (ID) | Image | MSRP | Freight USA | Freight Canada | |

| Fiore | Chapala | BRV-19ASG | Antique Satin Gold | 19" x 3 1/2" | 19" x 3 1/2" |  | \$ 1,499 | Mexico | D | F |
|-------------|----------------|-----------|--|-----------------|------------------|---|----------|-------------|----------------|---|
| Former Name | New Name | Item Code | Finish | Dimensions (OD) | Dimensions (ID) | Image | MSRP | Freight USA | Freight Canada | |
| Arbolo | Tila | BRV-19VTP | Rose Gold Interior with Verde Exterior | 16" x 6 1/2" | 13 5/8" x 6 1/2" |  | \$ 899 | Mexico | D | F |





| Former Name | New Name | Item Code | Finish | Dimensions (OD) | Dimensions (ID) | Image | MSRP | Freight USA | Freight Canada | |
|-------------------|-------------------|-----------|--|---------------------------------|-------------------------------|---|----------|-------------|----------------|---|
| Nest II | Manzanillo | NPCS-BC | Aged Copper (formally black copper) and Silver | 16" x 5 3/4" | 14" x 5 3/4" |  | \$ 999 | Mexico | D | F |
| Former Name | New Name | Item Code | Finish | Dimensions (OD) | Dimensions (ID) | Image | MSRP | Freight USA | Freight Canada | |
| Nuvo Frida Vessel | Silao | 1915-V | Rose Gold | 19 1/2" x 16" x 3 1/4" - 6 1/4" | 19 1/2" x 16" x 3 1/4" - 1/4" | 6  | \$ 1,221 | Mexico | D | F |









THOMPSON TRADERS

Vanities and Pedestals

Vanity

| Former Name | New Name | Item Code | Finish | Dimensions | Image | MSRP | COO | Freight USA | Freight Canada |
|-----------------------|----------------------|-----------|---|--|---|----------|--|-------------|----------------|
| Provence | Laja | BV-3424 | Sink: Aged Copper (formally black copper) Vanity: Wood with Wheatfield Granite | Sink: 15 1/2" x 5" Vanity: 24" W x 22" L x 34" H |  | \$ 912 | Vanity: Vietnam Top: China Sink: Mexico | I | L |
| Former Name | New Name | Item Code | Finish | Dimensions (OD) | Image | MSRP | COO | Freight USA | Freight Canada |
| Sheffield | Balsas White Granite | BV-3430 | Sink: Aged Copper (formally black copper) Vanity: Wood with Kashmir White Granite | Sink: 19" x 13 3/4" x 5" Vanity: 30" L x 22" W x 34"H |  | \$ 1,025 | Vanity: Vietnam Top: China Sink: Mexico | I | L |
| Verisimo | Balsas Aged Copper | VT-BC | Sink: Aged Copper (formally black copper) Vanity: Wood with Integrated Aged Copper Countertop and Sink | Sink: 19" x 13 3/4" x 5" Vanity: 30" L x 22" W x 34"H |  | \$ 1,559 | Vanity: Vietnam Sink/top: Mexico | I | L |
| Black Nickel Verisimo | Balsas Black Nickel | VT-BN | Sink: Black Nickel Vanity: Wood with Integrated Black Nickel Countertop and Sink | Sink: 19" x 13 3/4" x 5" Vanity: 30" L x 22" W x 34"H |  | \$ 1,889 | Vanity: Vietnam Sink/top: Mexico | I | L |

| Former Name | New Name | Item Code | Finish | Dimensions (OD) | Image | MSRP | Freight USA | Freight Canada |
|---------------|---------------------|------------|---|---|---|----------|---|----------------|
| Petit Rustic | Lerma Chica | VTS | Sink: Aged Copper (formally black copper) Vanity: Wood with Integrated Aged Copper Countertop and Sink | Sink: 16" x 17" Vanity: 17" L x 22" W x 34" H |  | \$ 1,373 | Mexico | I L |
| Grande Rustic | Lerma Grande | VTL | Sink: Aged Copper (formally black copper) Vanity: Wood with Integrated Aged Copper Countertop and Sink | Sink: 31 7/8" x 11" Vanity: 17" L x 42"W x 34" H |  | \$ 2,286 | Mexico | I L |
| Pedestal | | | | | | | | |
| Former Name | New Name | Item Code | Finish | Dimensions (OD) | Image | MSRP | Freight USA | Freight Canada |
| Frida | Ameca | CSW/P | Aged Copper (formally black copper) | Sink: 24" x 7 1/2" depth Pedestal: 24" W x 34" H |  | \$ 3,076 | Mexico | I L |
| Former Name | New Name | Item Code | Finish | Dimensions (OD) | Image | MSRP | Freight USA | Freight Canada |
| Nuvo Frida | Tuxpan | 1915 | Rose Gold | Sink: 19 1/2" x 15" x 6" depth Pedestal: 15" W x 39" H |  | \$ 3,425 | Mexico | I L |
| Former Name | New Name | Item Code | Finish | Dimensions (OD) | Image | MSRP | Freight USA | Freight Canada |
| Palmer Vanity | Zacatecas | PV-3420ASG | Sink: Antique Stain Gold Vanity: Brass with Glass Shelf | Sink: 18" x 18 3/4" x 6" Vanity: 20" L x 20" W x 34"H |  | \$ 4,399 | Sink: Mexico Legs: USA | I L |





| Former Name | New Name | Item Code | Finish | Dimensions (OD) | Image | MSRP | Freight USA | Freight Canada |
|--------------|--------------|-----------|--|-----------------------------------|---|-----------------|---|----------------|
| Orell Vanity | Bravo | BVW-30 | Sink: Nickel Vanity: Lucite | Vanity: 34"L x 21"W x 15"H |  | \$ 5,924 | Vanity: USA Sink: Mexico | I L |



THOMPSON TRADERS









Bath Tubs





Vanity

| Former Name | New Name | Item Code | Finish | Dimensions (OD) | Dimensions (ID) | Image | MSRP | COO | Freight USA | Freight Canada |
|-------------|-------------------|-------------|---|---------------------|-------------------------|---|-----------------|---------------|-------------|----------------|
| Caladonia | Cuitzeo | TBT-6960-DW | Antique Copper | 69" x 36" x 25 1/4" | 62" x 30 1/4" x 25 1/4" |  | \$ 7,350 | India | K | L |
| Britannia | Coba | TBT-6828-MF | Rose Gold Exterior, Nickel Interior | 68" x 28" x 28" | 57" x 24 1/2" x 28" |  | \$ 5,299 | India | K | L |
| Hibernia | Cupatitzio | TBT-7030-CL | Antique Copper Exterior, Rose Gold Interior | 70" x 30" x 29" | 65" x 25" x 29" |  | \$ 4,549 | India | K | L |
| Nuvo Frida | Baccarac | TBT-5828PC | Rose Gold | 58" x 28" x 23" | 58" x 28" x 23" |  | \$ 7,899 | Mexico | K | L |



THOMPSON TRADERS

| Accessories | | | | | | | | | |
|-----------------------------------|-----------|--------------|--------------------------------|---|-----------|--------|-------------|----------------|--|
| Name | Item Code | Finish | Dimensions | Image | MSRP | COO | Freight USA | Freight Canada | |
| Pavone Cup | AP1 | Pavone | 3" W x 5 3/4" H |  | \$ 112.00 | Mexico | B | C | |
| Pavone Tissue | AP2 | Pavone | 5 1/4" L x 5 1/4" W x 5 3/4" H |  | \$ 225.00 | Mexico | B | C | |
| Pavone Wastebasket | AP3 | Pavone | 8" W x 9 1/2" H |  | \$ 261.00 | Mexico | B | C | |
| Black Copper Tray | AHBC1 | Black Copper | 7 1/2" W x 18" L x 1" H |  | \$ 112.00 | Mexico | B | C | |
| Black Copper Cup | AHBC2 | Black Copper | 5 1/4" L x 5 1/4" W x 5 3/4" H |  | \$ 112.00 | Mexico | B | C | |
| Black Copper Tissue Holder | AHBC3 | Black Copper | 3 3/4" W x 5" H |  | \$ 112.00 | Mexico | B | C | |
| Black Copper Soap Holder | AHBC4 | Black Copper | 6 1/2" L x 4" W x 1 1/2" H |  | \$ 112.00 | Mexico | B | C | |
| Black Copper Wastebasket | AHBC5 | Black Copper | 11 1/4" L x 7" W x 11" H |  | \$ 317.00 | Mexico | B | C | |









| | | | | | | | | | |
|---------------------------------------|-------|--------------------|--------------------------------|---|----|---------------|---------------|---|---|
| Smooth Rose Gold Soap Holder | ASRG1 | Smooth Rose Gold | 5" L X 3 1/2" W x 1 1/2" H |  | \$ | 109.00 | Mexico | B | C |
| Smooth Rose Gold Tissue Holder | ASRG2 | Smooth Rose Gold | 5 1/4" L x 5 1/4" W x 5 3/4" H |  | \$ | 112.00 | Mexico | B | C |
| Smooth Rose Gold Wastebasket | ASRG3 | Smooth Rose Gold | 8" W x 9 1/2" H |  | \$ | 214.00 | Mexico | B | C |
| Hammered Rose Gold Wastebasket | AHRG1 | Hammered Rose Gold | 10" W x 14" H |  | \$ | 348.00 | Mexico | B | C |
| Hammered Rose Gold Tray | AHRG2 | Hammered Rose Gold | 29 1/2" L x 7" W x 1 1/2" H |  | \$ | 302.00 | Mexico | B | C |

















THOMPSON TRADERS





Drains

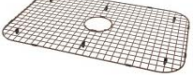

Bath Sink Drains

| Name | Item Code | Finish | Dimensions (ID) | Image | MSRP | COO | Freight USA | Freight Canada |
|--------------------------|-----------|--------------------------|-----------------|---|-----------|-------|-------------|----------------|
| Flower Style Grid | TDG15-OB | Oil-Rubbed Bronze Finish | 1 1/2" |  | \$ 110.00 | China | A | B |
| Soft Touch Pop Up | TDP15-OB | Oil-Rubbed Bronze Finish | 1 1/2" |  | \$ 110.00 | China | A | B |
| Flower Style Grid | TDG15-AC | Antique Copper | 1 1/2" |  | \$ 110.00 | China | A | B |
| Soft Touch Pop Up | TDP15-AC | Antique Copper | 1 1/2" |  | \$ 110.00 | China | A | B |
| Flower Style Grid | TDG15-BRN | Nickel Finish | 1 1/2" |  | \$ 110.00 | China | A | B |
| Soft Touch Pop Up | TDP15-BRN | Nickel Finish | 1 1/2" |  | \$ 110.00 | China | A | B |
| Flower Style Grid | TDG15-PC | Rose Gold | 1 1/2" |  | \$ 110.00 | China | A | B |
| Soft Touch Pop Up | TDP15-PC | Rose Gold | 1 1/2" |  | \$ 110.00 | China | A | B |
| Flower Style Grid | TDG15-ASG | Antique Satin Gold | 1 1/2" |  | \$ 110.00 | China | A | B |

| Soft Touch Pop Up | TDP15-ASG | Antique Satin Gold | 1 1/2" |  | \$ | 110.00 | China | A | B |
|--------------------------------------|------------------|--------------------|------------------------|---|-------------|---------------|--------------|--------------------|-----------------------|
| Kitchen Sink Drains | | | | | | | | | |
| Name | Item Code | Finish | Dimensions (ID) | Image | MSRP | | | Freight USA | Freight Canada |
| Disposal Flange & Stopper | TDD35-AC | Antique Copper | 3.5" |  | \$ | 66.00 | China | A | B |
| Basket Strainer | TDB35-AC | Antique Copper | 3.5" |  | \$ | 105.00 | China | A | B |
| Disposal Flange & Stopper | TDD35-OB | Oil-Rubbed Bronze | 3.5" |  | \$ | 66.00 | China | A | B |
| Basket Strainer | TDB35-OB | Oil-Rubbed Bronze | 3.5" |  | \$ | 105.00 | China | A | B |
| Disposal Flange & Stopper | TDD35-BRN | Nickel | 3.5" |  | \$ | 66.00 | China | A | B |
| Basket Strainer | TDB35-BRN | Nickel | 3.5" |  | \$ | 105.00 | China | A | B |
| Disposal Flange & Stopper | TDD35-PC | Rose Gold | 3.5" |  | \$ | 66.00 | China | A | B |
| Basket Strainer | TDB35-PC | Rose Gold | 3.5" |  | \$ | 105.00 | China | A | B |
| Disposal Flange & Stopper | TDD35-PB | Brass | 3.5" |  | \$ | 66.00 | China | A | B |
| Basket Strainer | TDB35-PB | Brass | 3.5" |  | \$ | 105.00 | China | A | B |

| Kitchen Sink Drains | | | | | | | | | |
|-----------------------------------|-------------|--|-----------------|---|-----------|-------|-------------|----------------|--|
| Name | Item Code | Finish | Dimensions (ID) | Image | MSRP | | Freight USA | Freight Canada | |
| Tub drain and overflow kit | TDBTWO-PC | Rose Gold | 2.5" |  | \$ 245.00 | China | A | B | |
| Tub drain and overflow kit | TDBTWO-TTPC | Rose Gold and Nickel (designed to match the Britannia) | 2.5" |  | \$ 245.00 | China | A | B | |
| Tub drain and overflow kit | TDBTWO-BRN | Nickel | 2.5" |  | \$ 245.00 | China | A | B | |
| Tub drain and overflow kit | TDBTWO-DW | Oil-Rubbed Bronze | 2.5" |  | \$ 245.00 | China | A | B | |

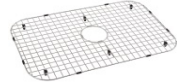
| Kitchen Sink Drains | | | | | | | | | |
|--------------------------|------------|--|-----------------|---|-----------|-----|-------------|----------------|--|
| Name | Item Code | Finish | Dimensions (ID) | Image | MSRP | | Freight USA | Freight Canada | |
| Small Bottom Grid | BG1612-HA | Fits Kitchen Sinks: KDU-3120AH, KDA-3322AH | 16" x 12" |  | \$ 109.00 | USA | A | B | |
| Large Bottom Grid | BG2616-HA | Fits Kitchen Sink: KSU-3020AH | 26" x 16" |  | \$ 124.00 | USA | A | B | |
| Small Bottom Grid | BG1712-HA | Fits Prep/Bar Sinks: KPU-1715HA | 17" x 12" |  | \$ 109.00 | USA | A | B | |
| Large Bottom Grid | BG2817-HA | Fits Kitchen Sink: KSA-3322AH | 28" x 17" |  | \$ 124.00 | USA | A | B | |
| Small Bottom Grid | BG1712-HSS | Fits Kitchen Sink: KPU-1715BRN | 17" x 12" |  | \$ 109.00 | USA | A | B | |

| | | | | | | | | | |
|--------------------------|------------|--|-----------|---|----|---------------|------------|---|---|
| Large Bottom Grid | BG1612-HSS | Fits Kitchen Sinks: KDU-3120AH, KDA-3322AH, KDU-3120HSS, KDA-3322HSS | 16" x 12" |  | \$ | 109.00 | USA | A | B |
| Small Bottom Grid | BG2616-HSS | Fits Kitchen Sink: KSU-3020AH, KSU-3020HSS | 26" x 16" |  | \$ | 124.00 | USA | A | B |
| Large Bottom Grid | BG2817-HSS | Fits Kitchen Sink: KSA-3322-HSS | 28" x 17" |  | \$ | 169.00 | USA | A | B |

| Category | Freight |
|----------|----------------|
| A | \$11.00 |
| B | \$16.00 |
| C | \$24.00 |
| D | \$26.00 |
| E | \$36.00 |
| F | \$38.00 |
| G | \$53.00 |
| H | \$68.00 |
| I | \$195.00 |
| J | \$235.00 |
| K | \$280.00 |
| L | Call for Quote |

For Canadian Dealers only

Canada Customs & Duties

| Invoice Value | | Brokerage | |
|---------------|-------------|-----------|----------|
| | | CAD | USD |
| \$0 | \$ 500.00 | \$ 18.00 | \$ 13.53 |
| \$ 500.01 | \$ 1,000.00 | \$ 24.25 | \$ 18.23 |
| \$ 1,000.01 | \$ 1,500.00 | \$ 30.50 | \$ 22.93 |
| \$ 1,500.01 | \$ 2,000.00 | \$ 37.00 | \$ 27.82 |
| \$ 2,000.01 | \$ 2,500.00 | \$ 46.25 | \$ 34.77 |
| 2500.01 + | + | \$ 78.75 | \$ 59.21 |

Taxes

| | | |
|--------------------|-----------------------|----|
| HST GST | based on product cost | 5% |
|--------------------|-----------------------|----|

| Product Duty | Duty |
|--------------------------------|------|
| India Copper Sinks & Bath tubs | 3% |
| Hammered Stainless Steel | 7% |