

DRAW

50

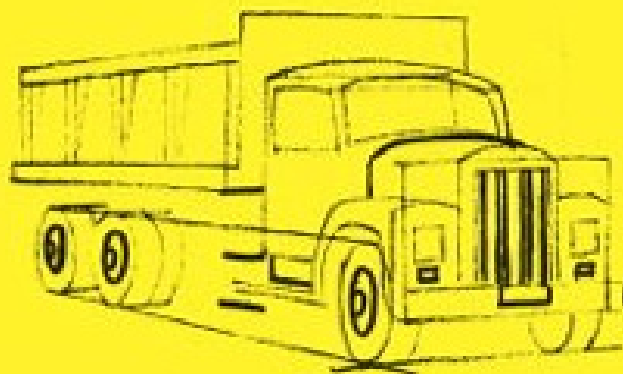
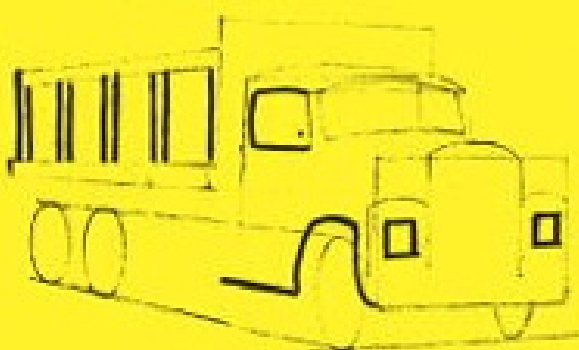

DRAW
50

VEHICLES

*The Step-by-Step Way to Draw Speedboats,
Spaceships, Fire Trucks, and Many More*

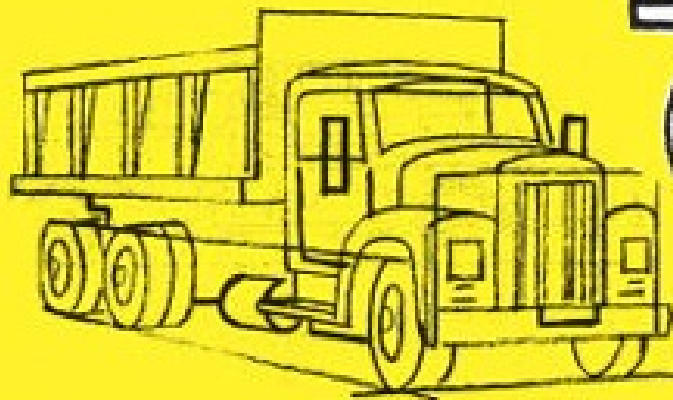

LEE J. AMES

BOOKS IN THIS SERIES

- *Draw 50 Airplanes, Aircraft, and Spacecraft* • *Draw 50 Aliens*
- *Draw 50 Animal Toons*
- *Draw 50 Animals*
- *Draw 50 Athletes*
- *Draw 50 Baby Animals*
- *Draw 50 Beasties*
- *Draw 50 Birds*
- *Draw 50 Boats, Ships, Trucks, and Trains* • *Draw 50 Buildings and Other Structures* • *Draw 50 Cars, Trucks, and Motorcycles* • *Draw 50 Cats*
- *Draw 50 Creepy Crawlies*
- *Draw 50 Dinosaurs and Other Prehistoric Animals* • *Draw 50 Dogs*
- *Draw 50 Endangered Animals* • *Draw 50 Famous Cartoons*
- *Draw 50 Flowers, Trees, and Other Plants* • *Draw 50 Horses*
- *Draw 50 Magical Creatures* • *Draw 50 Monsters*
- *Draw 50 People*
- *Draw 50 Princesses*
- *Draw 50 Sharks, Whales, and Other Sea Creatures* • *Draw 50 Vehicles*
- *Draw the Draw 50 Way*



DRAW
50

VEHICLES

*The Step-by-Step Way to Draw Speedboats,
Spaceships, Fire Trucks, and Many More . . .*



LEE J. AMES

Watson-Guptill Publications, New York

Copyright © 1976, 1977 by Jocelyn S. Ames

All rights reserved.

Published in the United States by Watson-Guption Publications, an imprint of the Crown Publishing Group, a division of Random House, Inc., New York, in 2012.

www.crownpublishing.com

WATSON-GUPTION and the WG and Horse designs are registered trademarks of Random House, Inc.

Originally published in hardcover in the United States by Doubleday, a division of Random House, Inc., New York, in 1976.

Library of Congress Cataloging-in-Publication Data

Ames, Lee.

Draw 50 Vehicles/Lee J. Ames

p. cm.

NC 825.V4A46

UNK82002766

eISBN: 978-0-77043295-9

v3.1

Contents

Cover

Other Books by This Author

Title Page

Copyright

To the Reader

To the Parent or Teacher

First Page

About the Author

Draw 50 Vehicles

To the Reader

This book will show you a way to draw boats, ships, trucks, trains, airplanes, aircraft, and spacecraft. You need not start with the first illustration. Choose whichever you wish. When you have decided, follow the step-by-step method shown. Very lightly and carefully, sketch out step number one. However, this step, which is the easiest, should be done most carefully. Step number two is added right to step number one, also lightly and also very carefully. Step number three is sketched right on top of numbers one and two. Continue this way to the last step.

It may seem strange to ask you to be extra careful when you are drawing what seem to be the easiest first steps, but this is most important because a careless mistake at the beginning may spoil the whole picture at the end. As you sketch out each step, watch the spaces between the lines, as well as the lines, and see that they are the same. After each step, you may want to lighten your work by pressing it with a kneaded eraser (available at art supply stores).

When you have finished, you may want to redo the final step in India ink with a fine brush or pen. When the ink is dry, use the kneaded eraser to clean off the pencil lines. The eraser will not affect the India ink.

Here are some suggestions: In the first few steps, even when all seems quite correct, you might do well to hold your work up to a mirror. Sometimes the mirror shows that you've twisted the drawing off to one side without being aware of it. At first you may find it difficult to draw the boxes, triangles, or circles, or to just make the pencil go where you wish. Don't be discouraged. The more you practice, the more you will develop control. Use a compass or a ruler if you wish; professional artists do! The only equipment you'll need will be a medium or soft pencil, paper, the kneaded eraser and, if you wish, a compass, ruler, pen, or brush.

The first steps in this book are shown darker than necessary so that they can be clearly seen. (Keep your work very light.)

Remember, there are many other ways and methods to make drawings. This book shows just one method. Why don't you seek out other ways and

methods to make drawings—from teachers, from libraries and, most important ... from inside yourself?

LEE J. AMES

To the Parent or Teacher

"David can draw a jet plane better than anybody else!" Such peer acclaim and encouragement generate incentive. Contemporary methods of art instruction (freedom of expression, experimentation, self-evaluation of competence and growth) provide a vigorous, fresh-air approach for which we must all be grateful.

New ideas need not, however, totally exclude the old. One such is the "follow me, step-by-step" approach. In my young learning days this method was so common, and frequently so exclusive, that the student became nothing more than a pantographic extension of the teacher. In those days it was excessively overworked.

This does not mean that the young hand is never to be guided. Rather, specific guiding is fundamental. Step-by-step guiding that produces satisfactory results is valuable even when the means of accomplishment are not fully understood by the student.

The novice with a musical instrument is frequently taught to play simple melodies as quickly as possible, well before he learns the most elemental scratchings at the surface of music theory. The resultant self-satisfaction, pride in accomplishment, can be a significant means of providing motivation. And all from mimicking an instructor's "Do-as-I-do ..."

Mimicry is prerequisite for developing creativity. We learn the use of tools by mimicry. Then we can use those tools for creativity. To this end I would offer the budding artist the opportunity to memorize or mimic (rotelike, if you wish) the making of "pictures." "Pictures" he has been anxious to be able to draw.

The use of this book should be available to anyone who wants to try another way of flapping his wings. Perhaps he will then get off the ground when his friend says, "David can draw a jet plane better than anybody else!"



Cabin cruiser



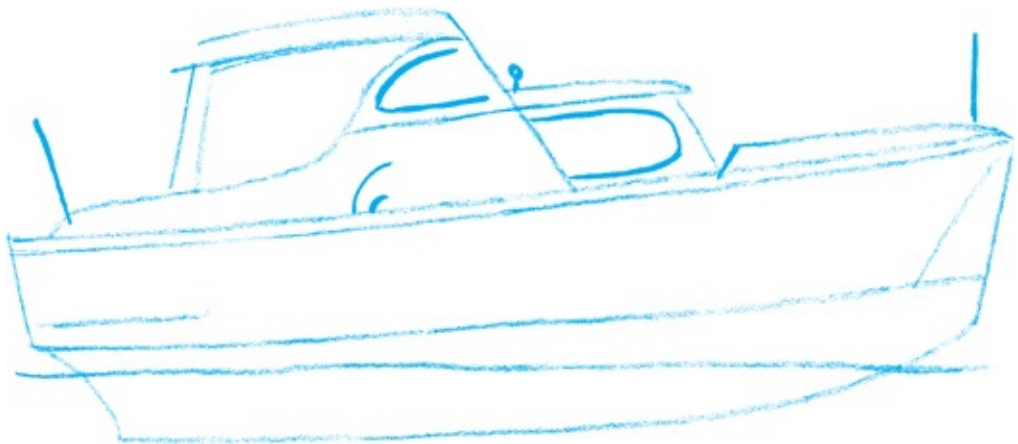
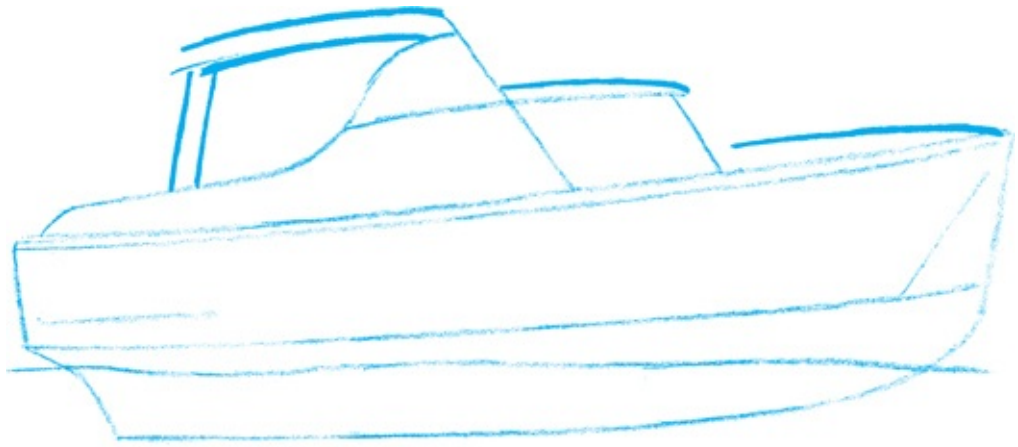

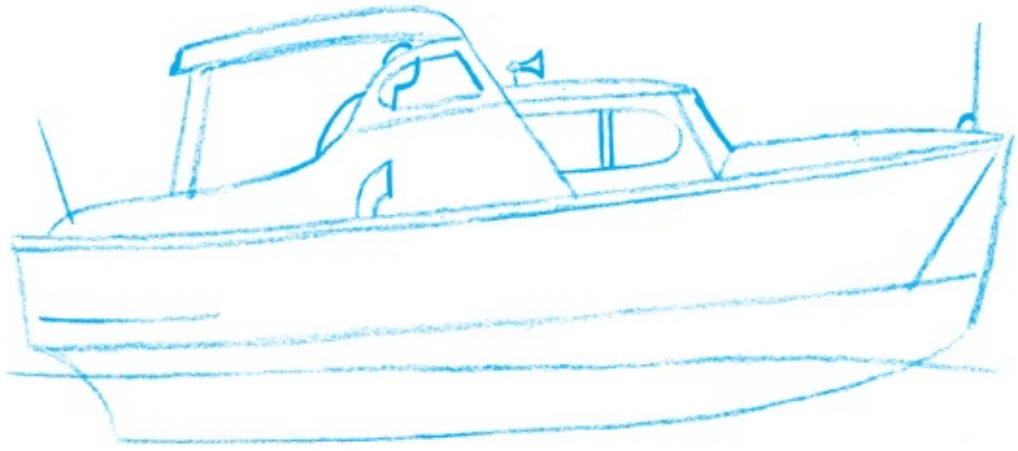

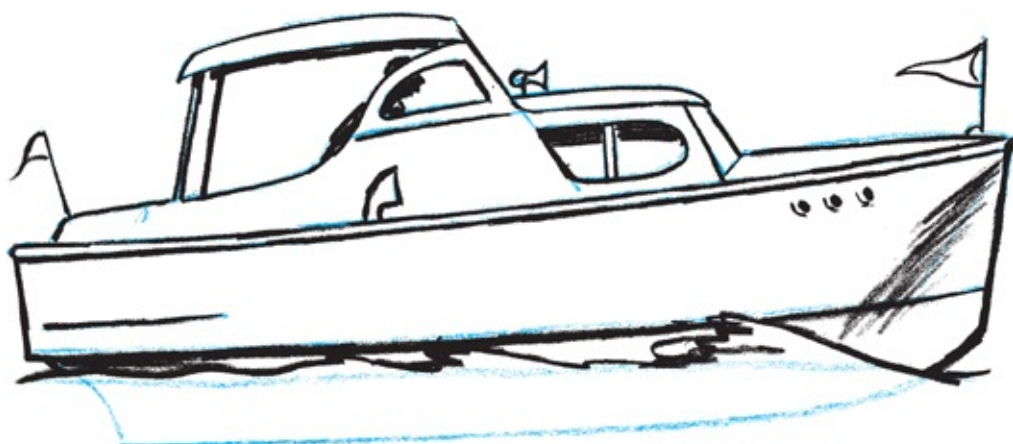



Paddle-wheel houseboat

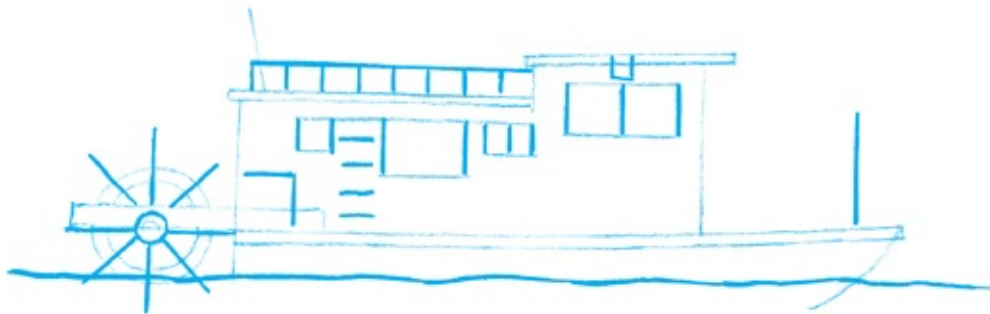

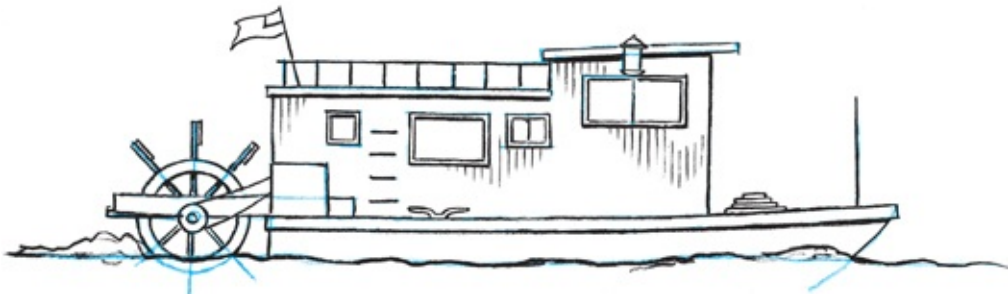



Outboard speedboat

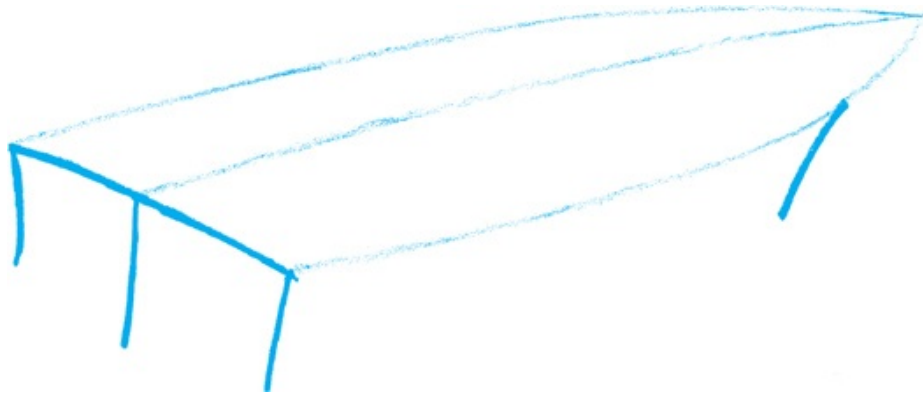

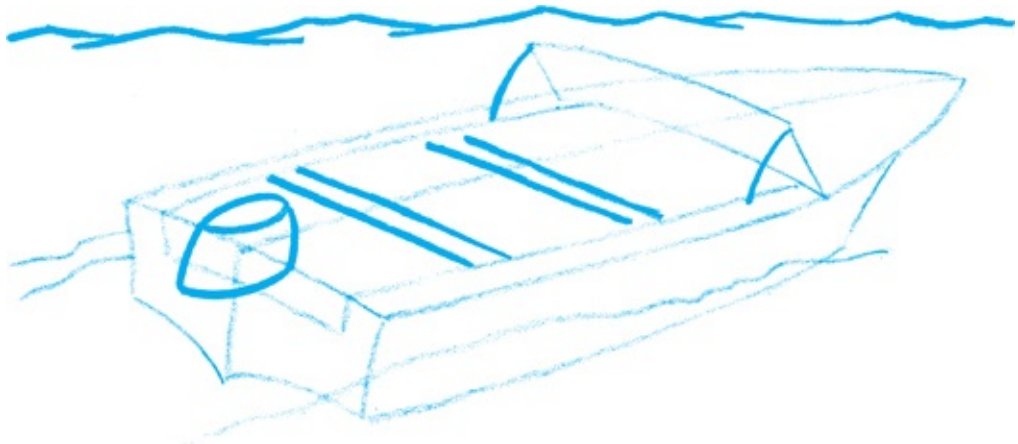
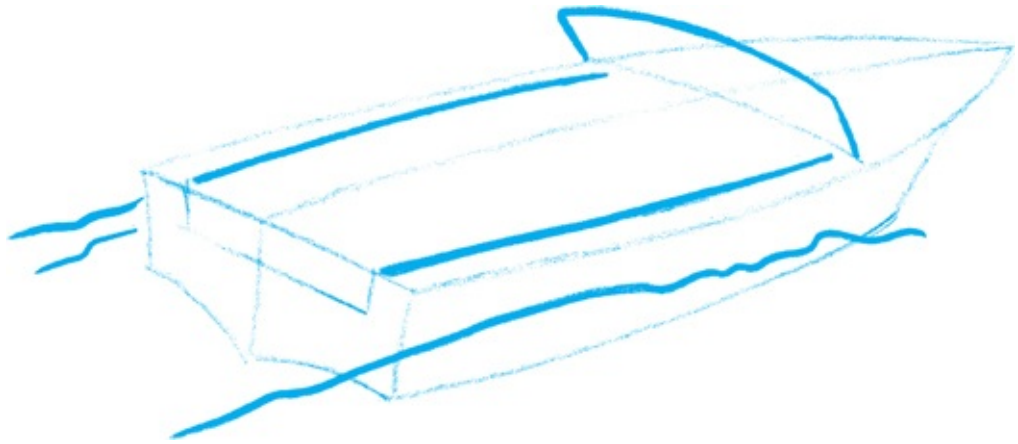
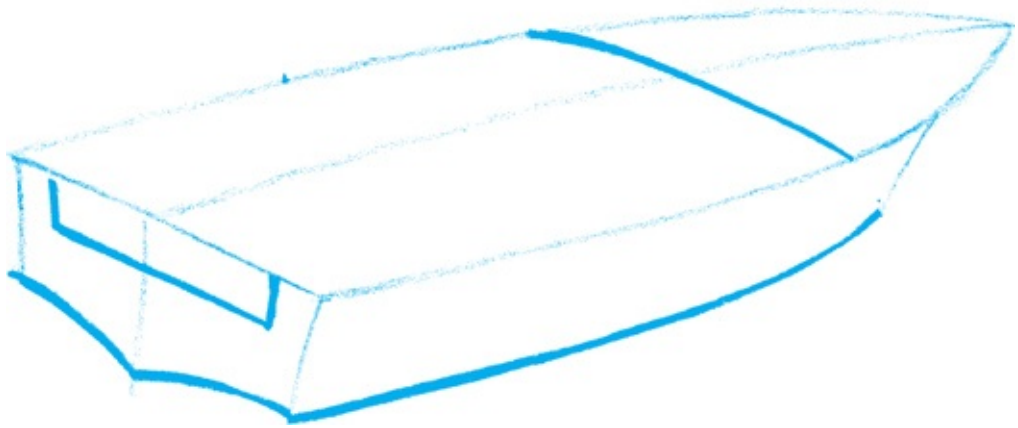

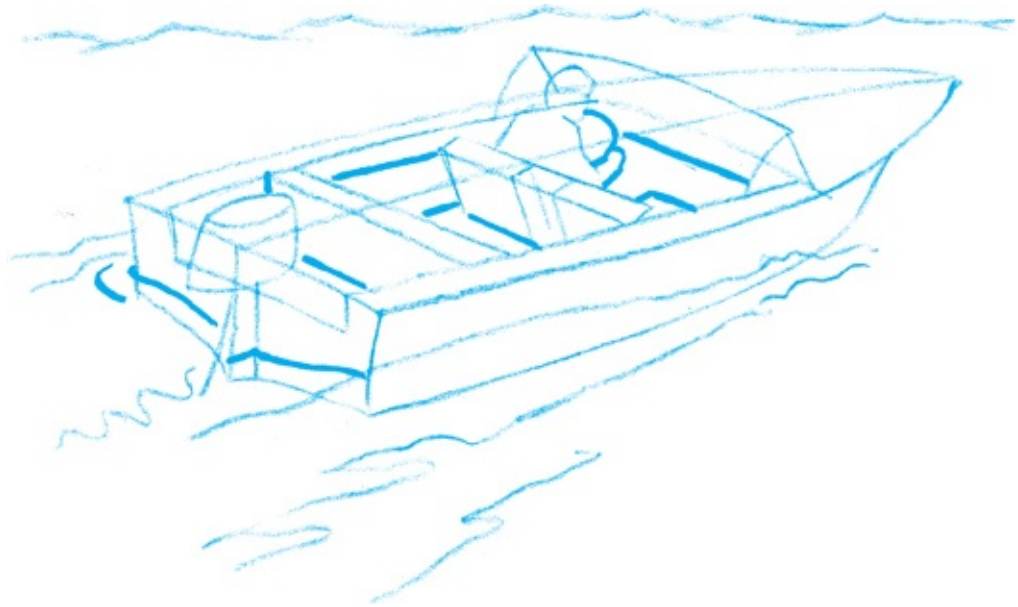

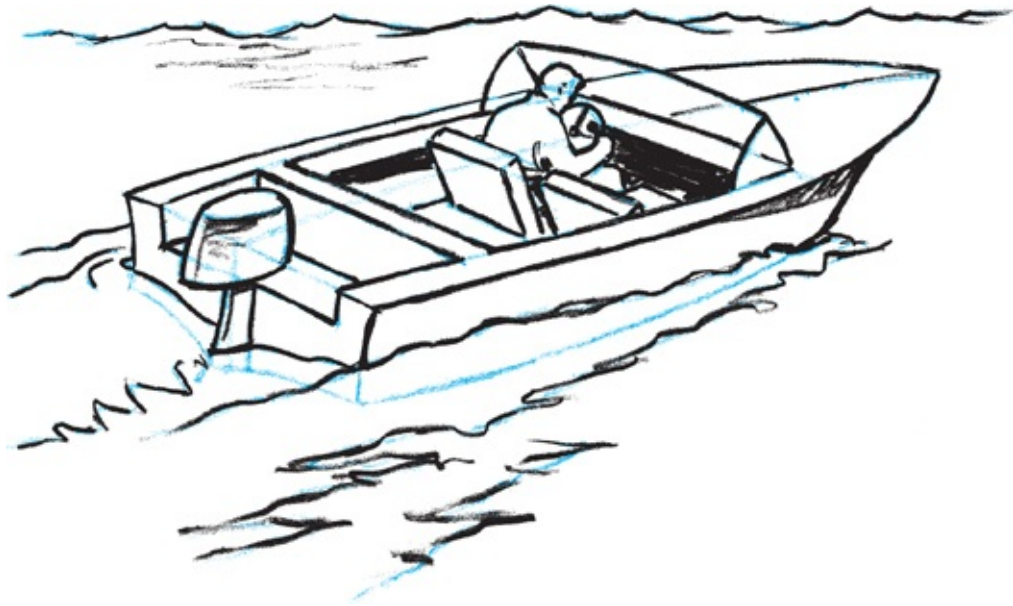



Fishing boat (liner)



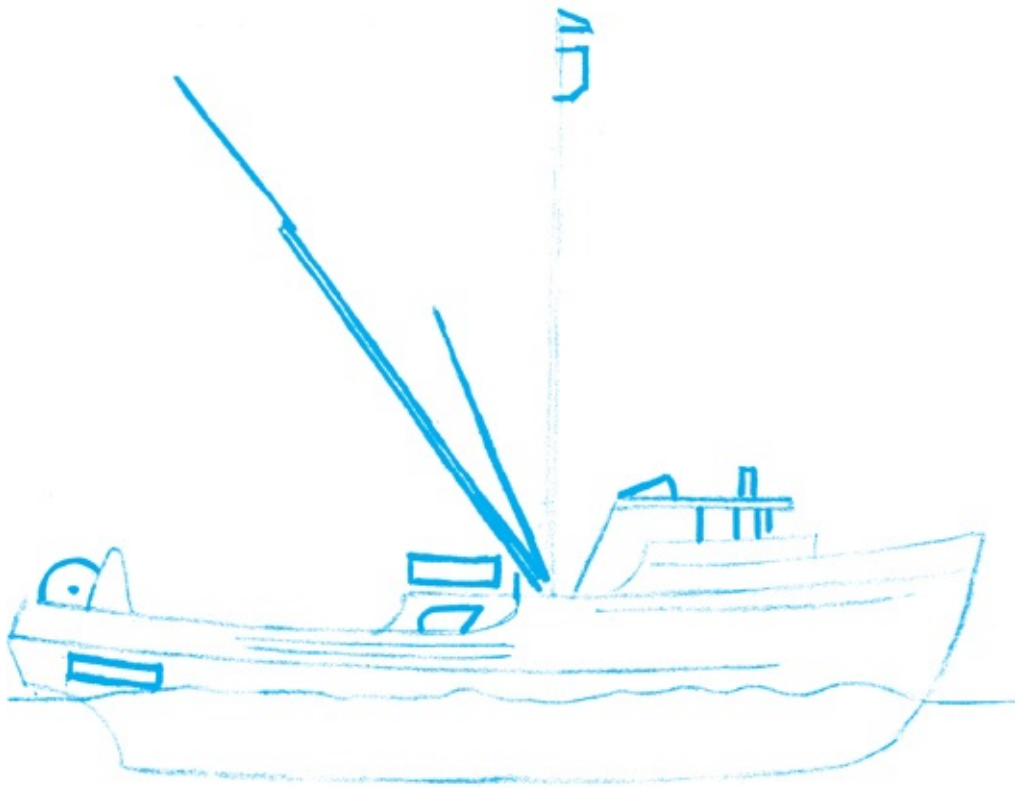
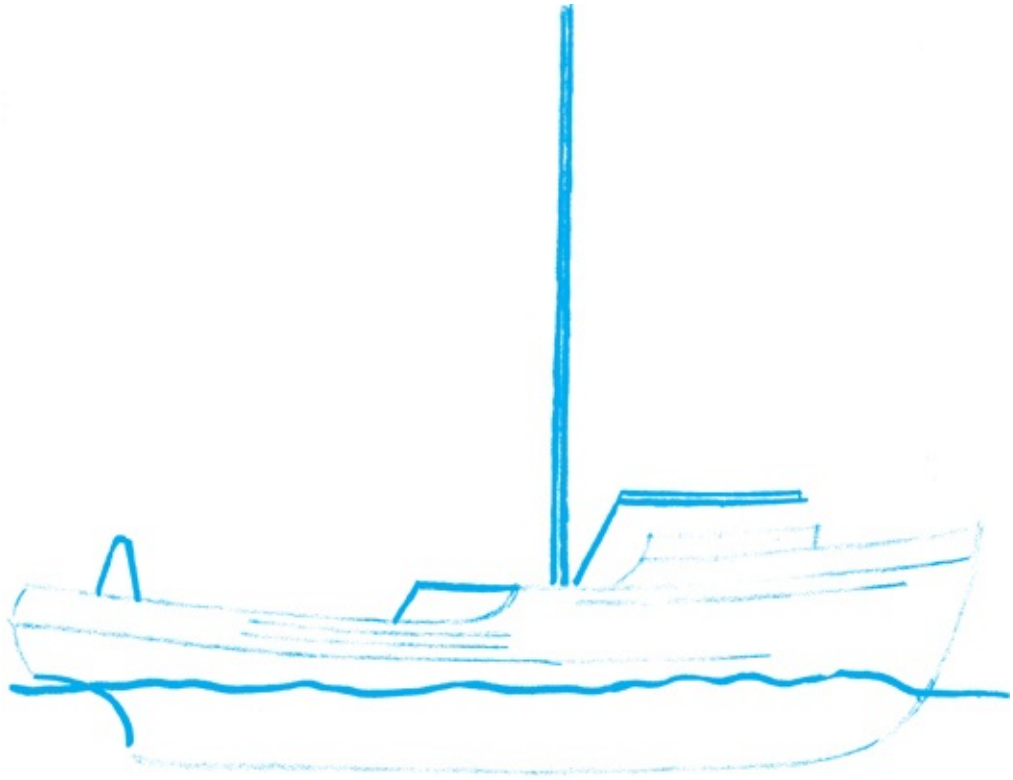

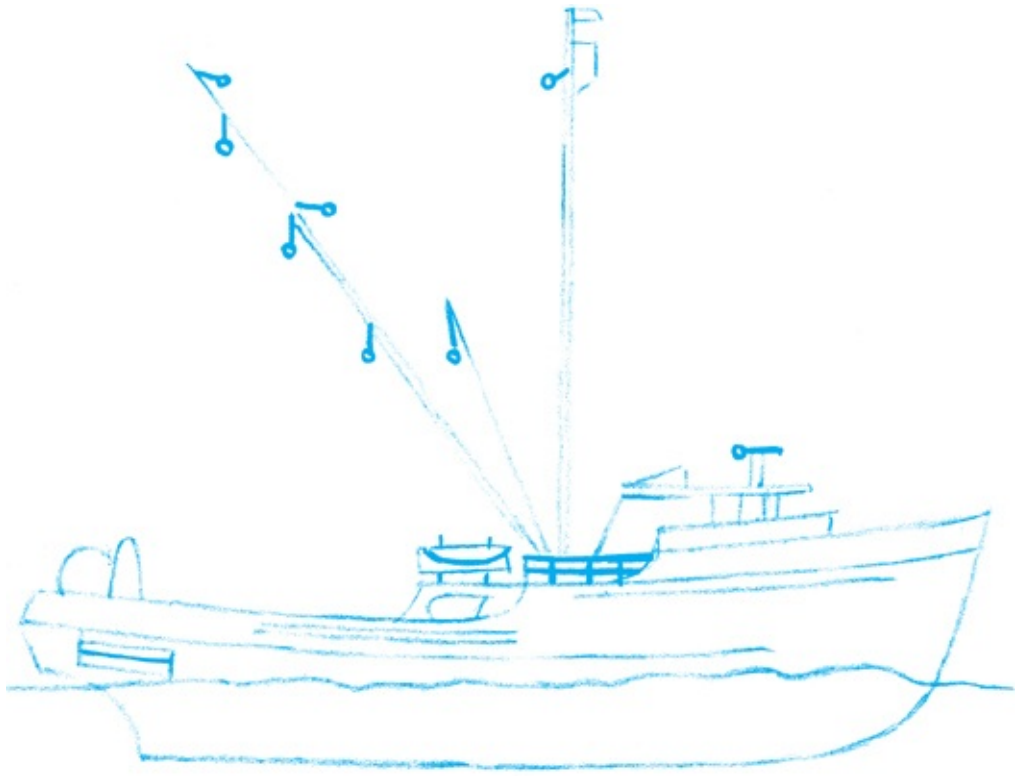

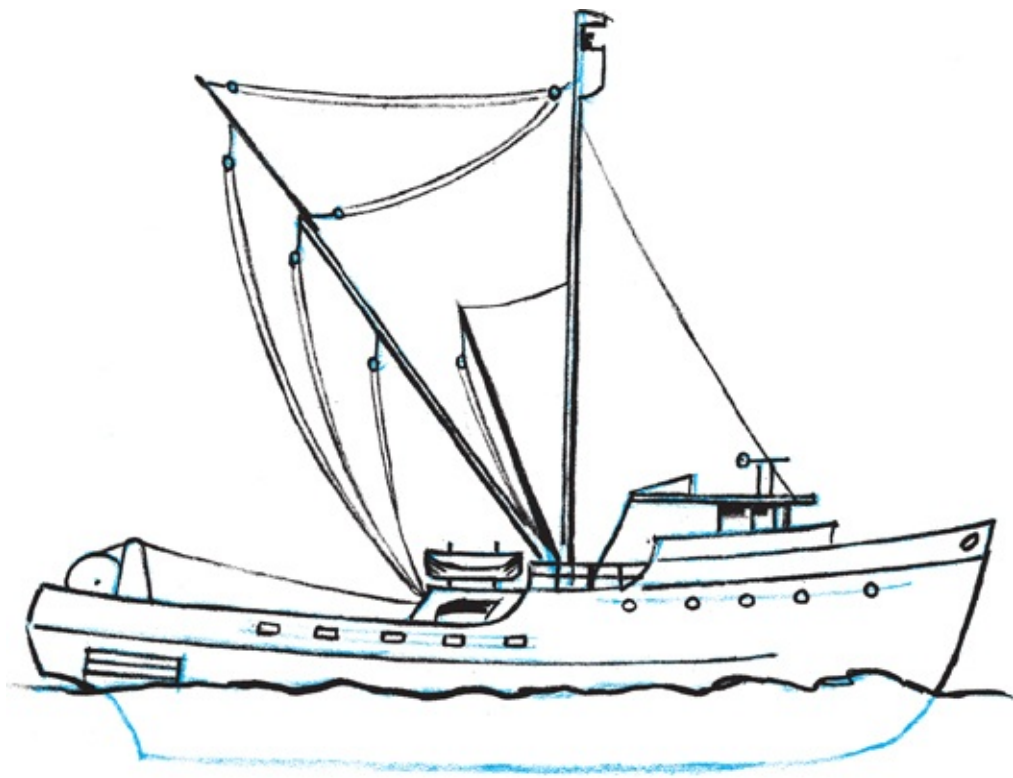



Tugboat



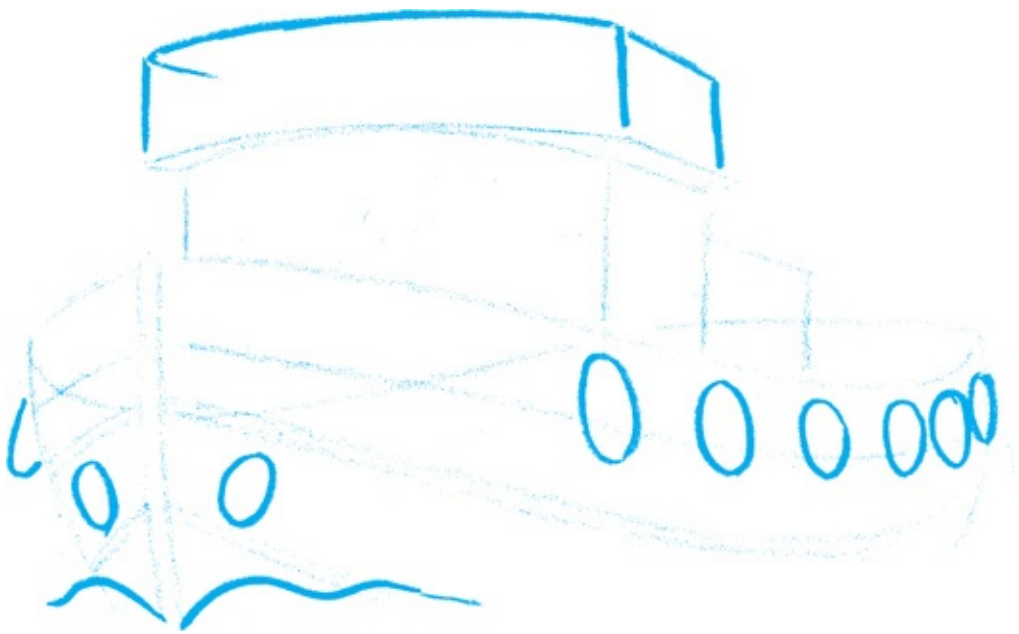

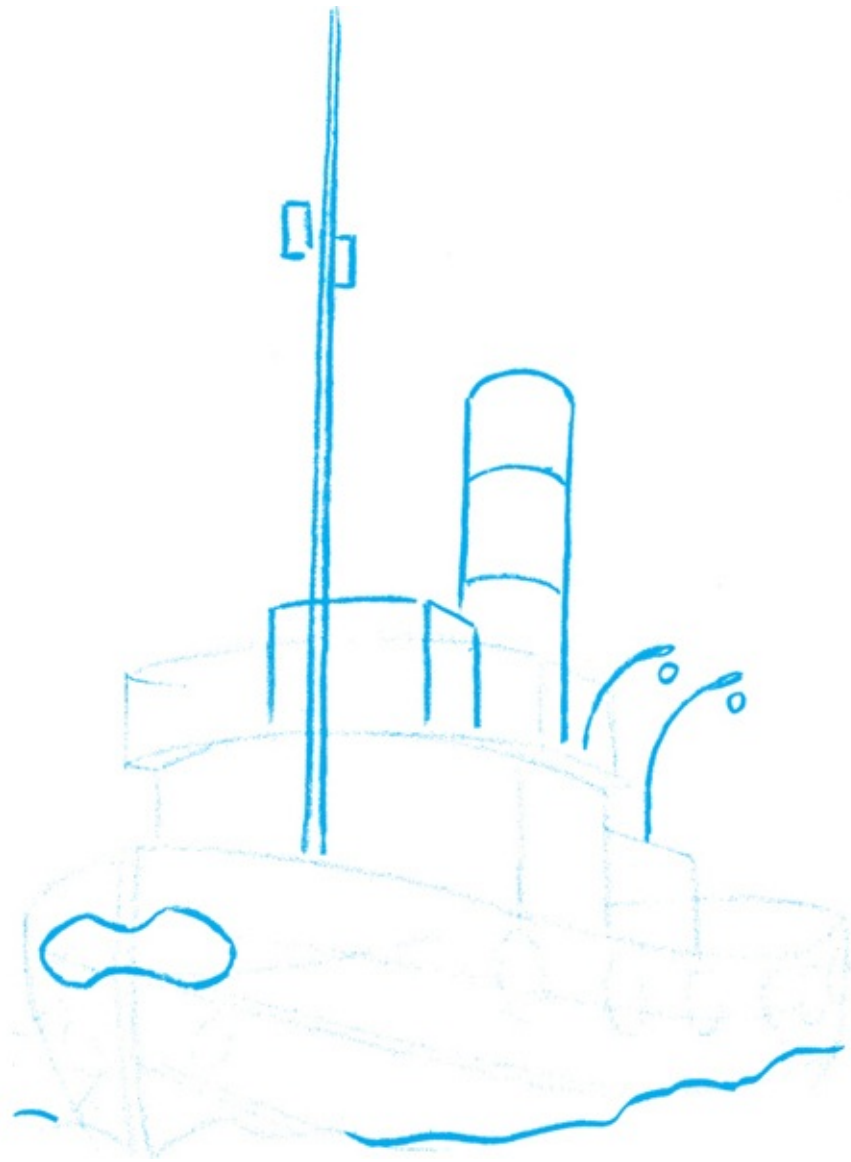

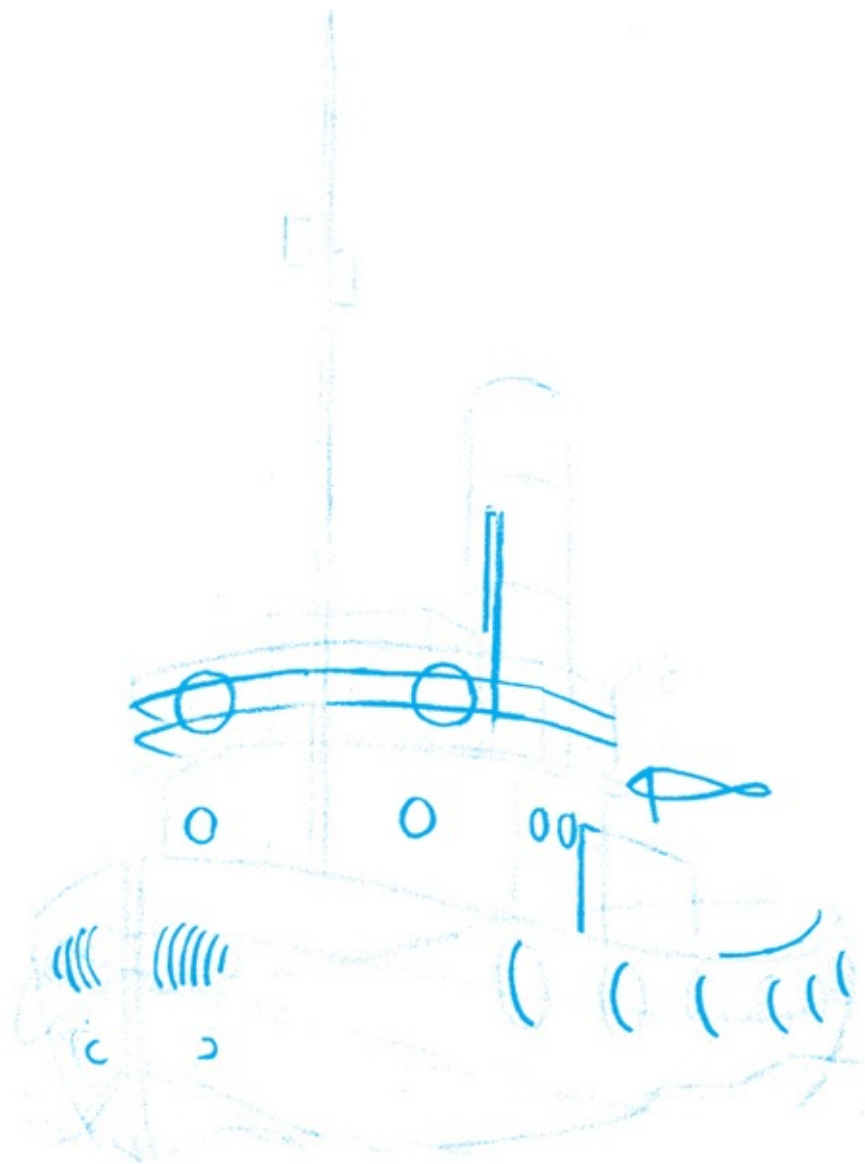

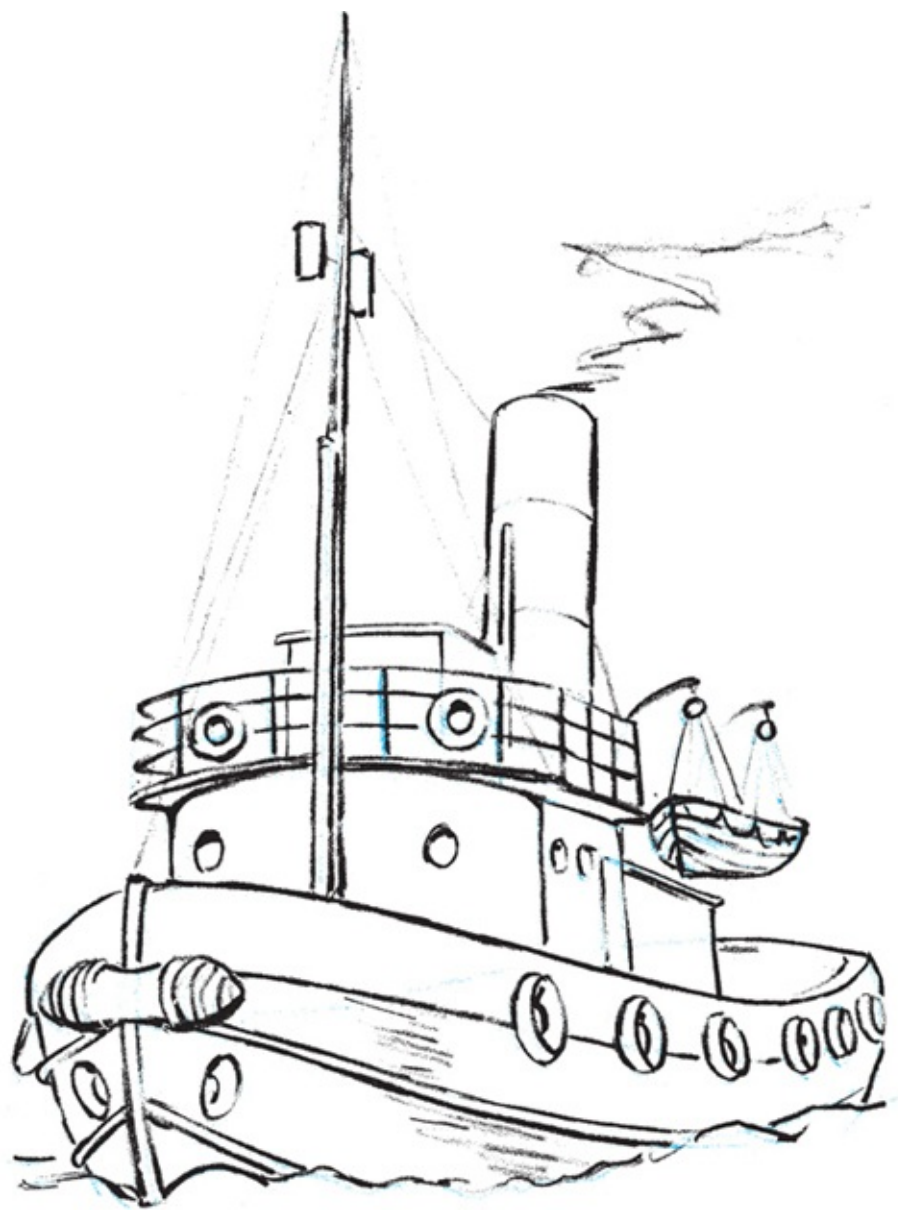



Ocean liner

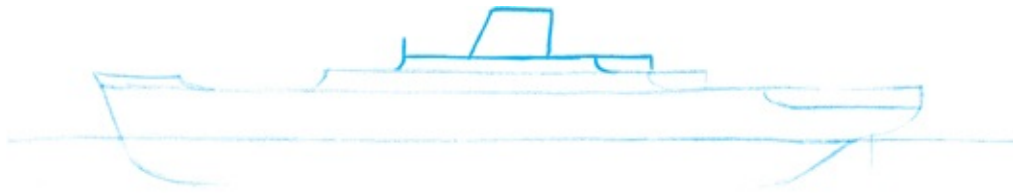

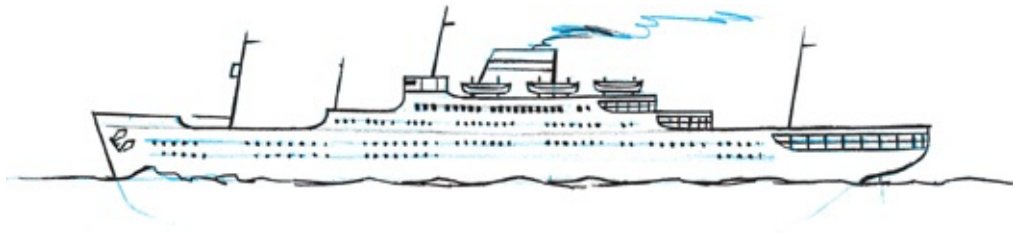



Ocean liner (early twentieth century)

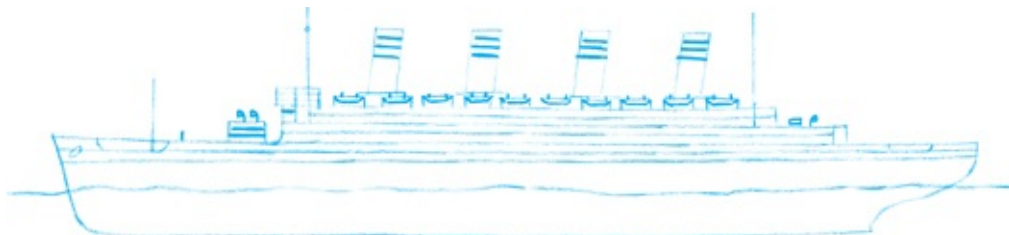
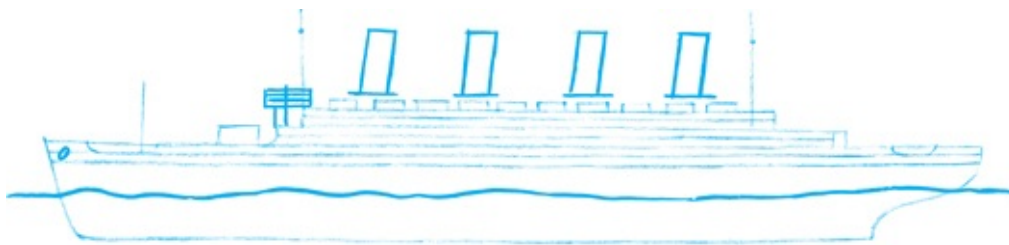

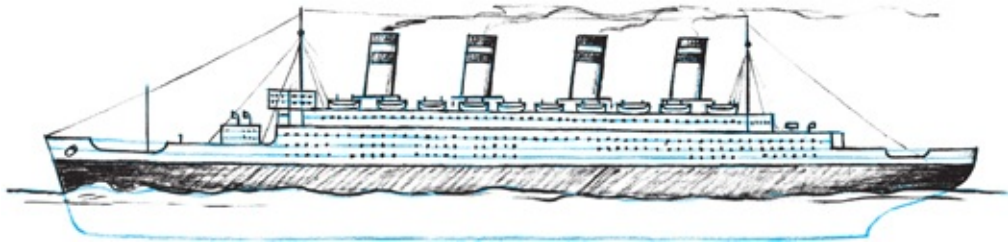



Submarine (U.S.S. Nautilus)

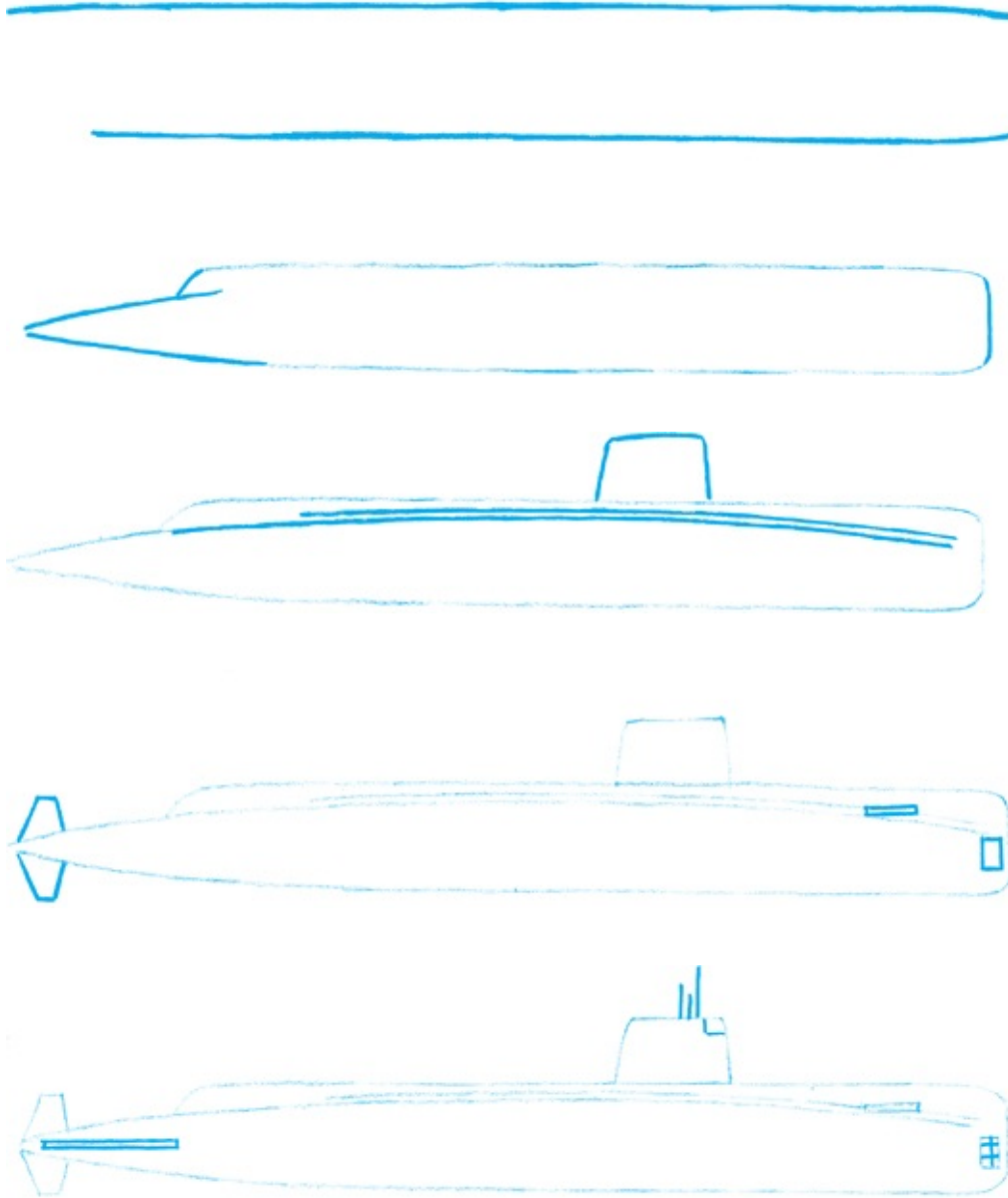

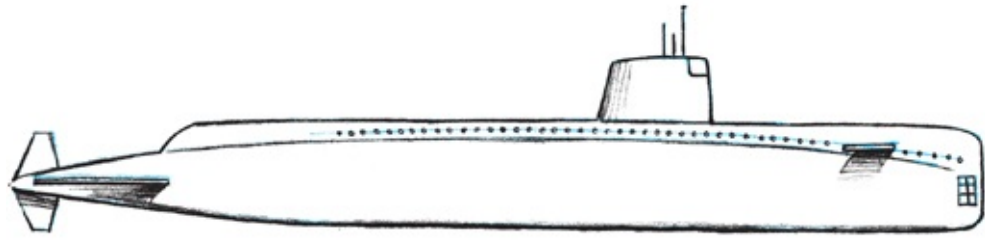



Canoe

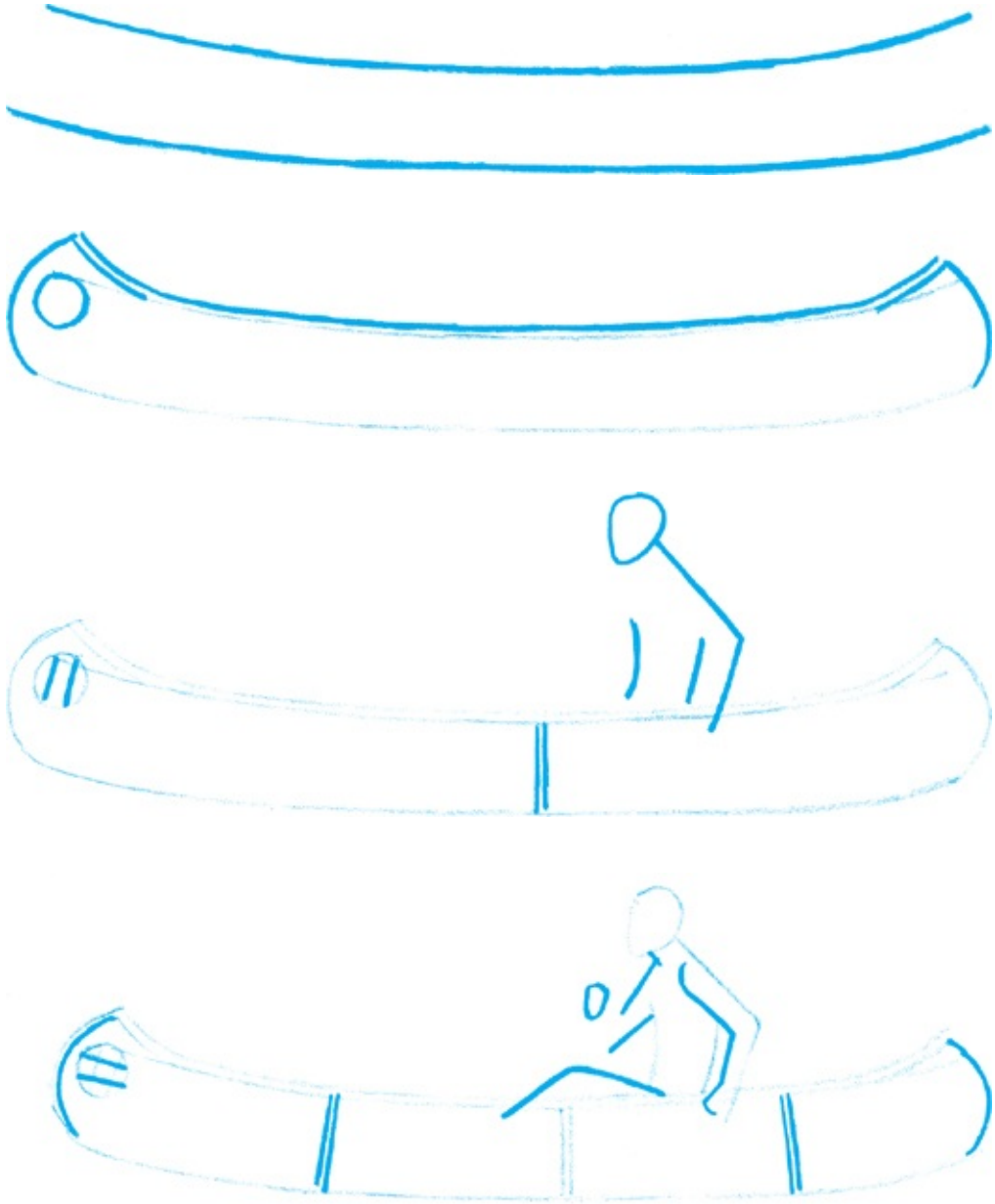







Dory

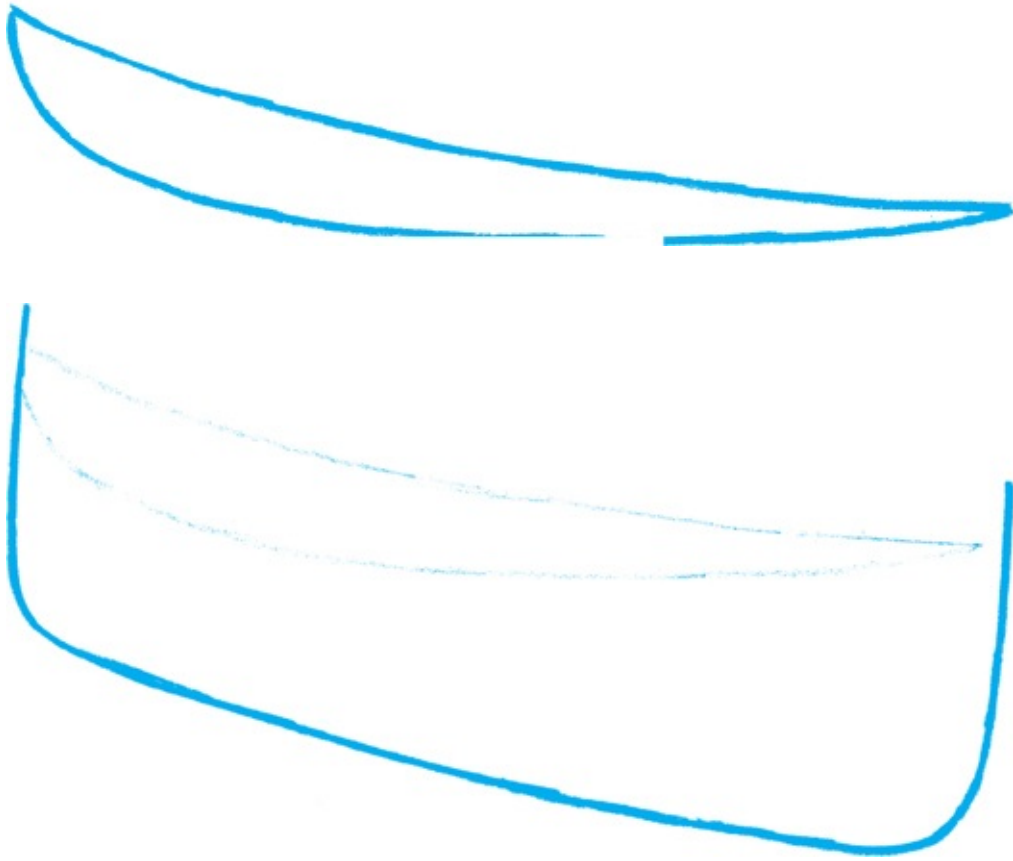

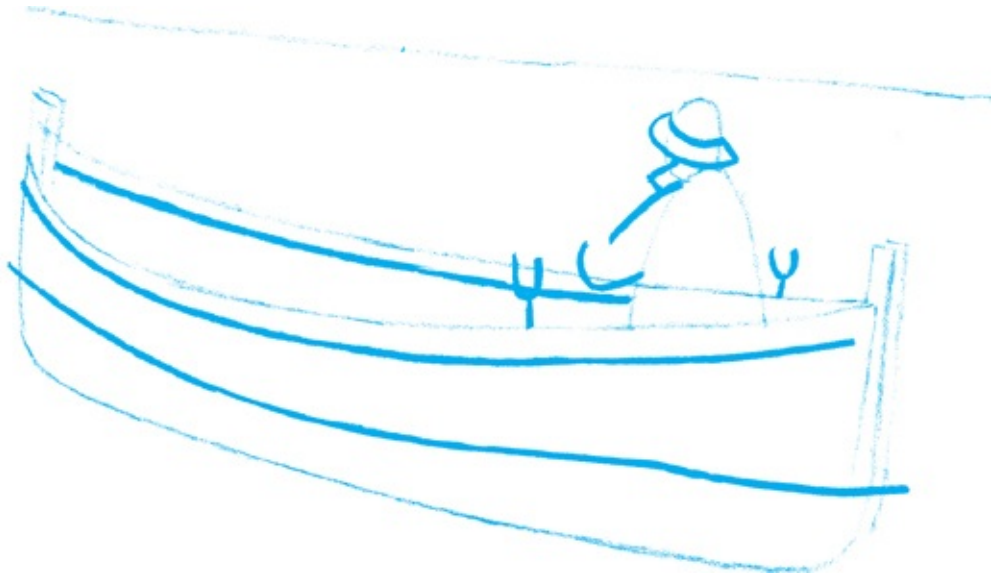
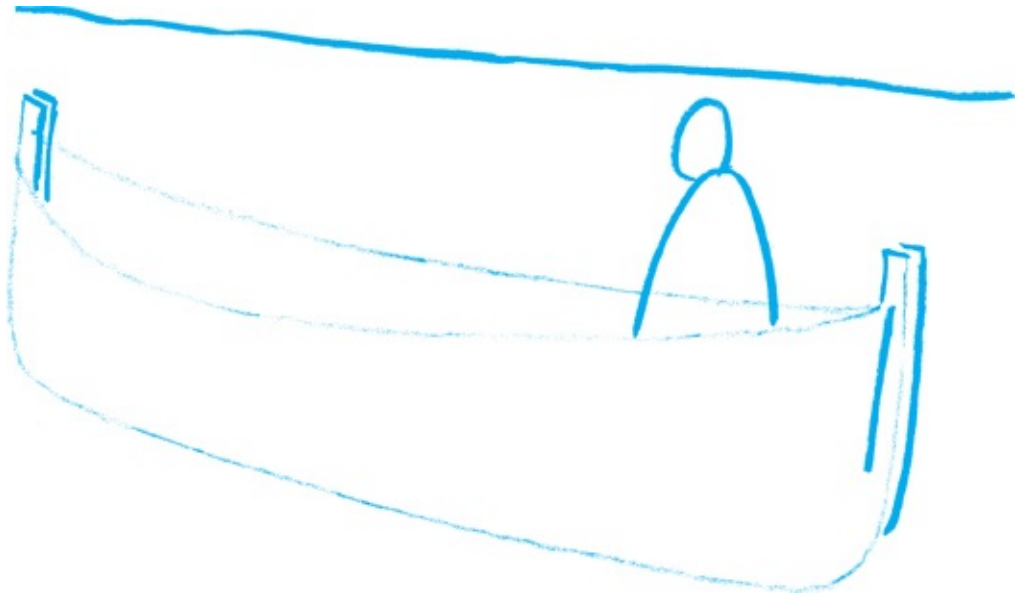







Sloop

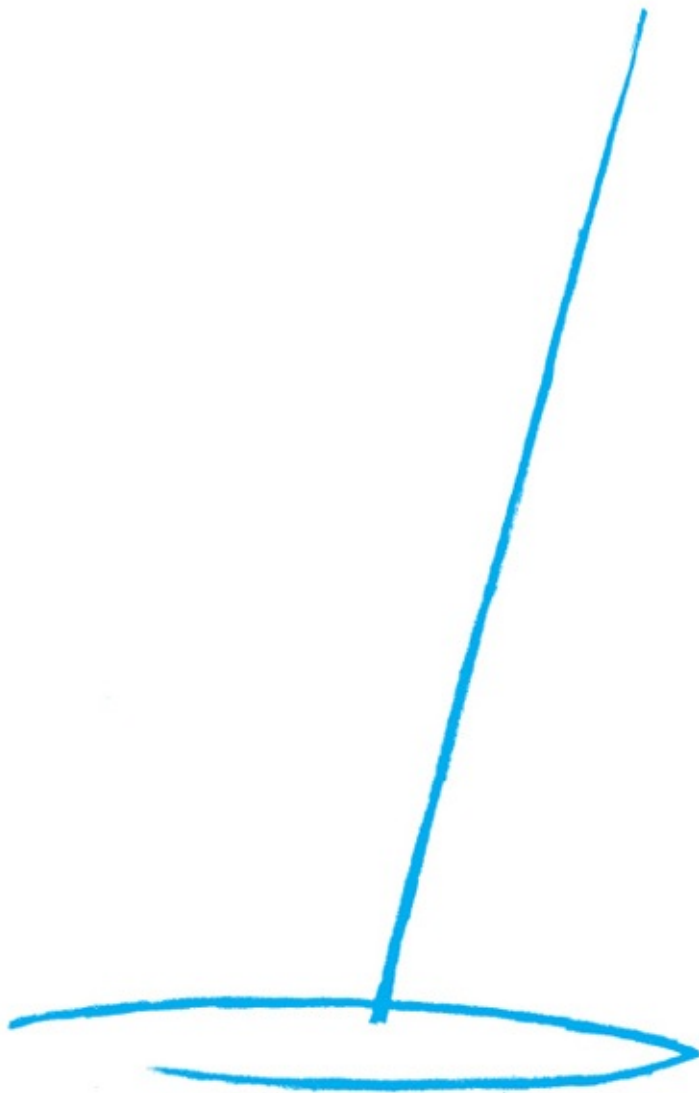





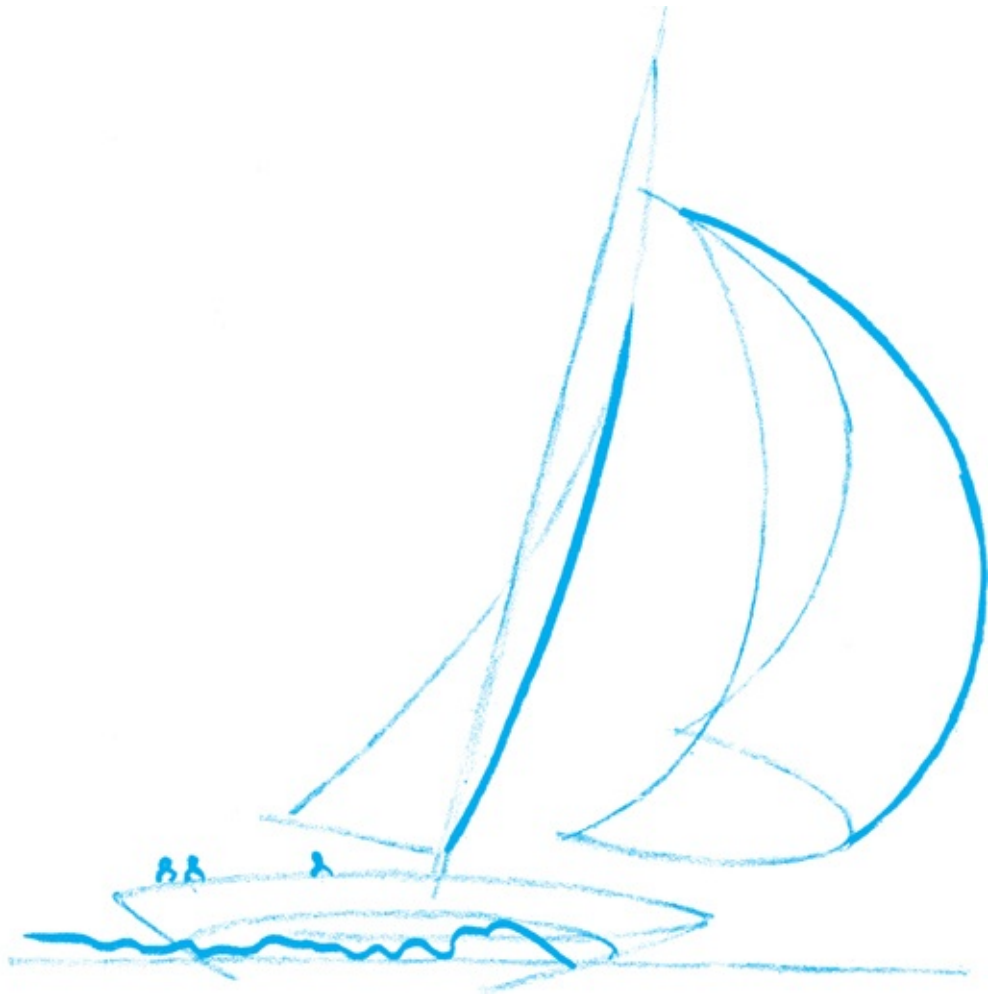







Square-rigged sailing ship

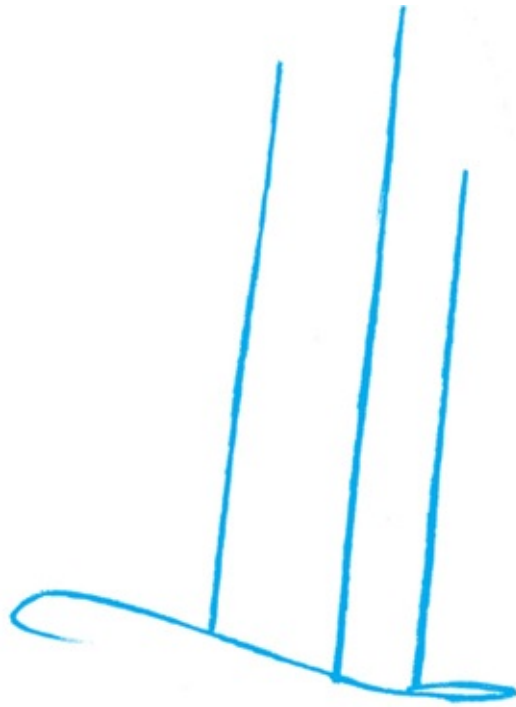

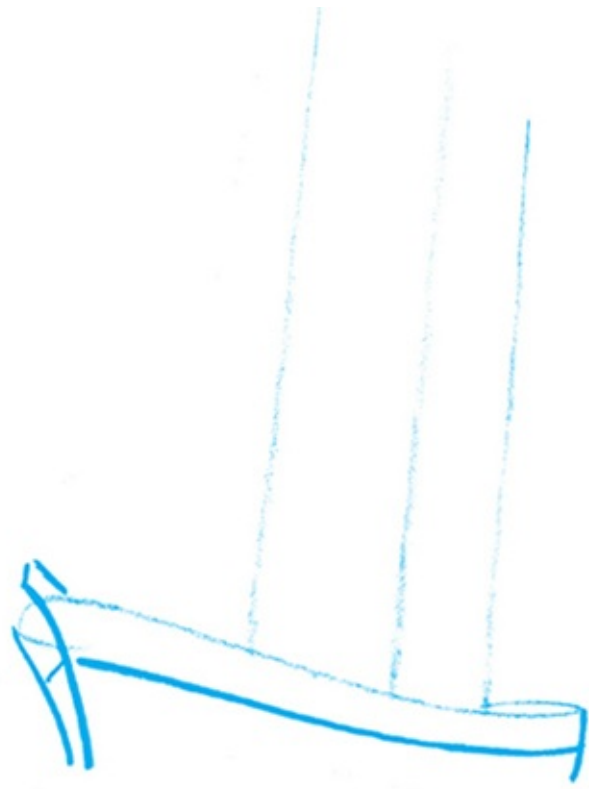





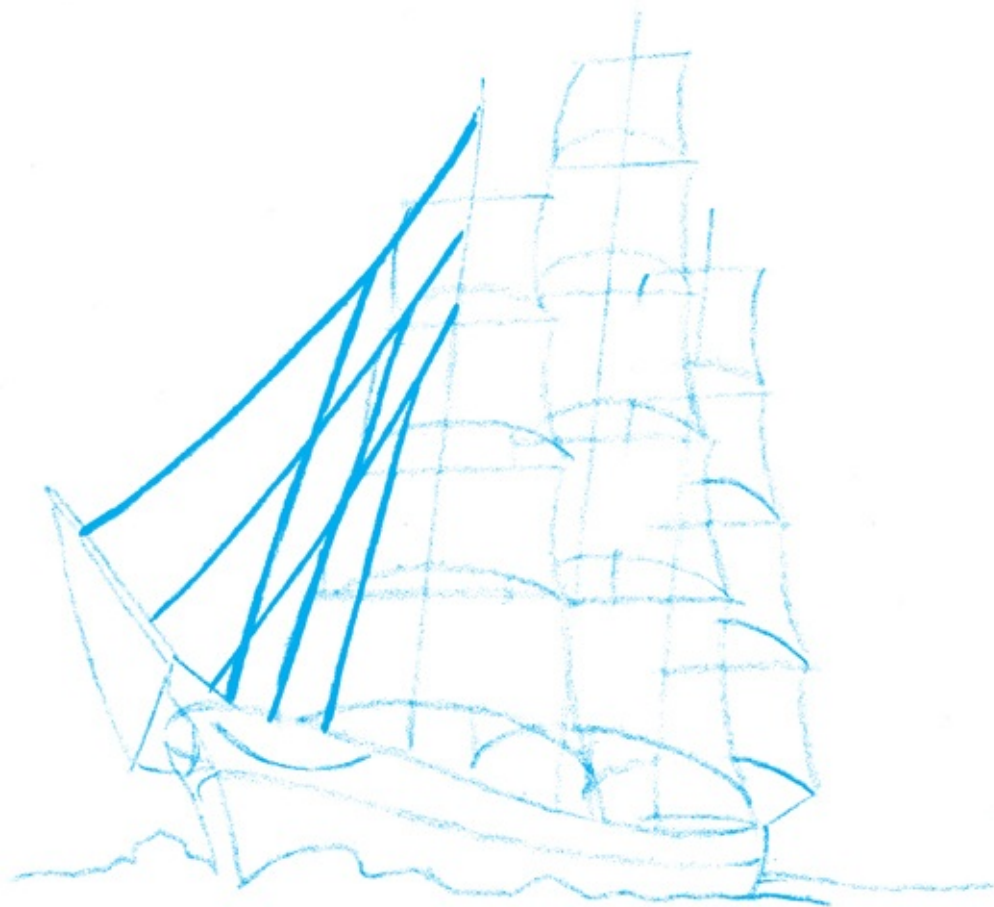

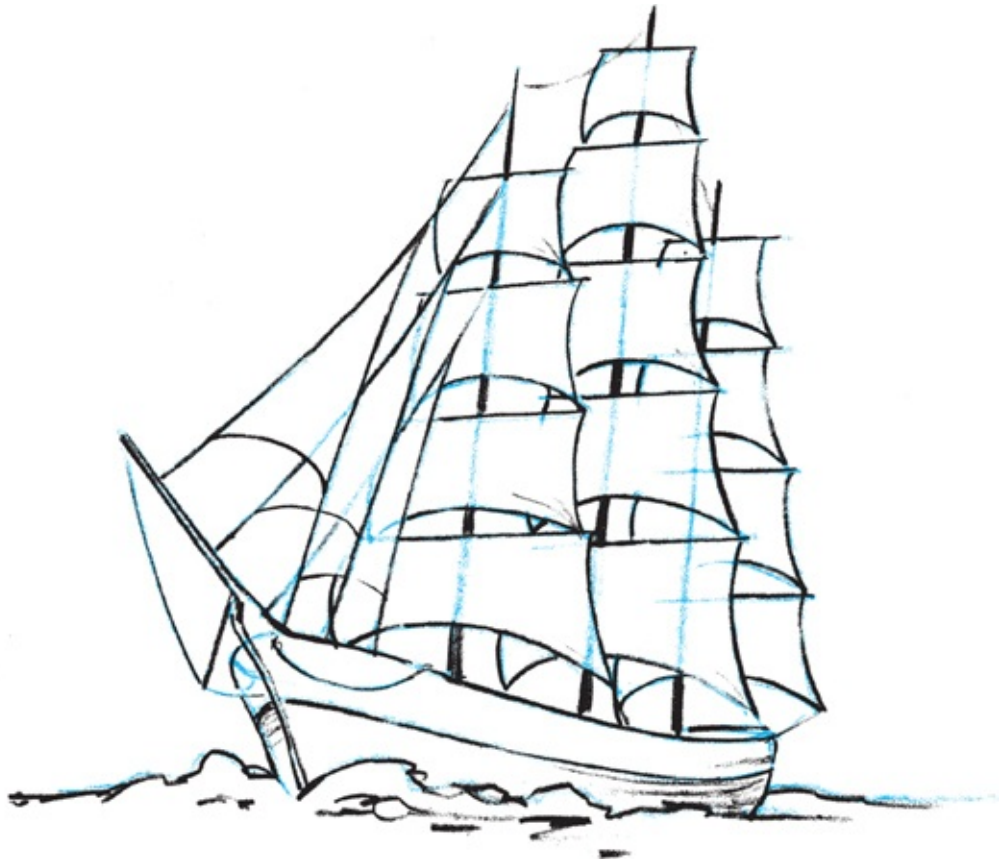



Viking ship



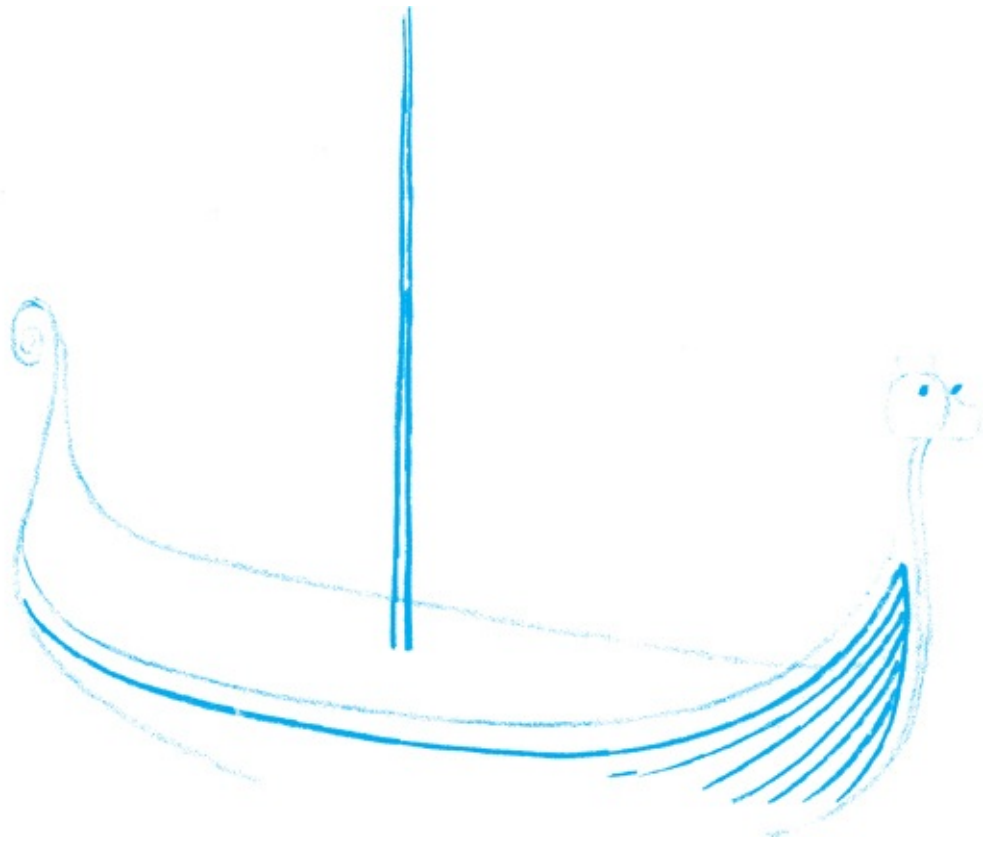

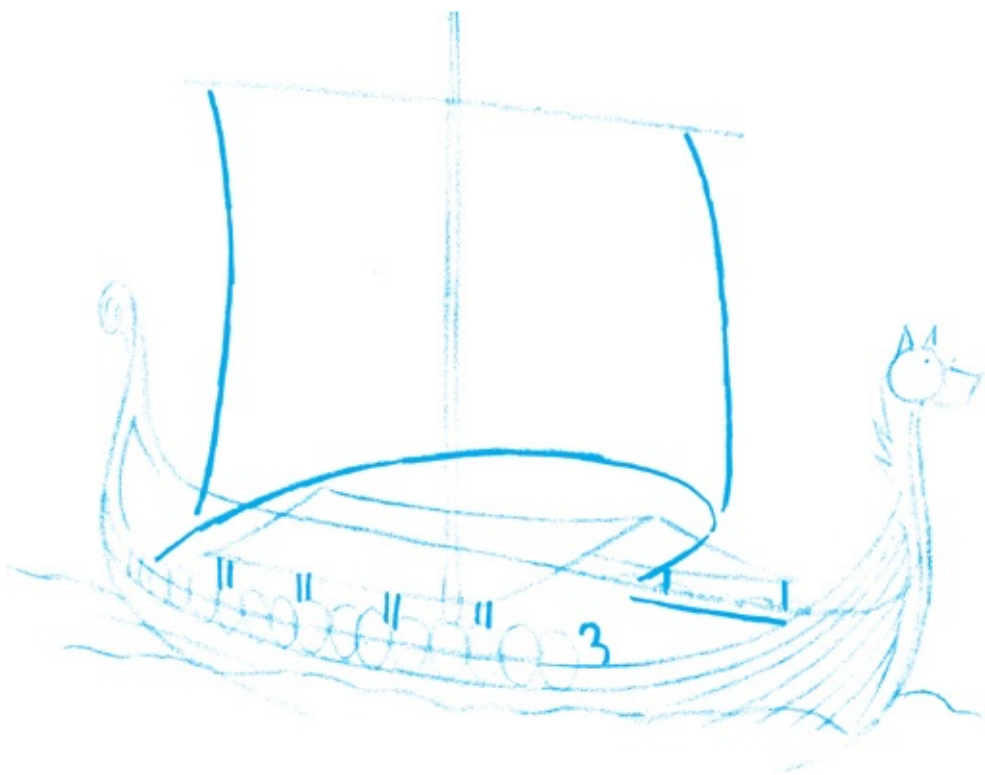
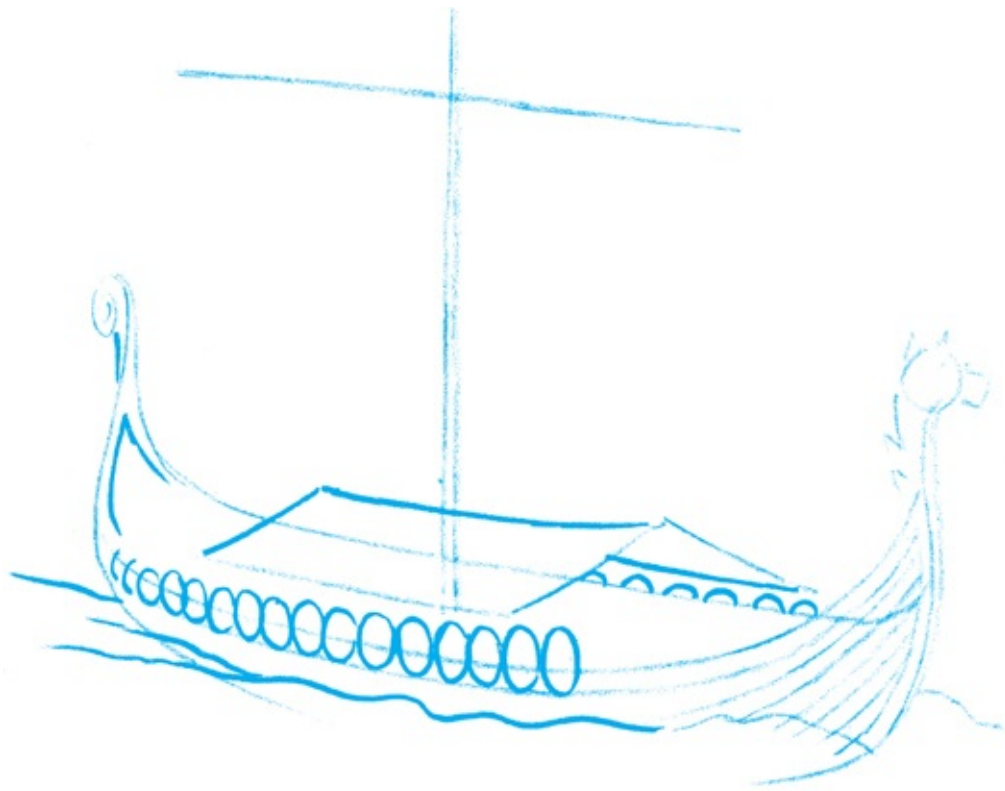

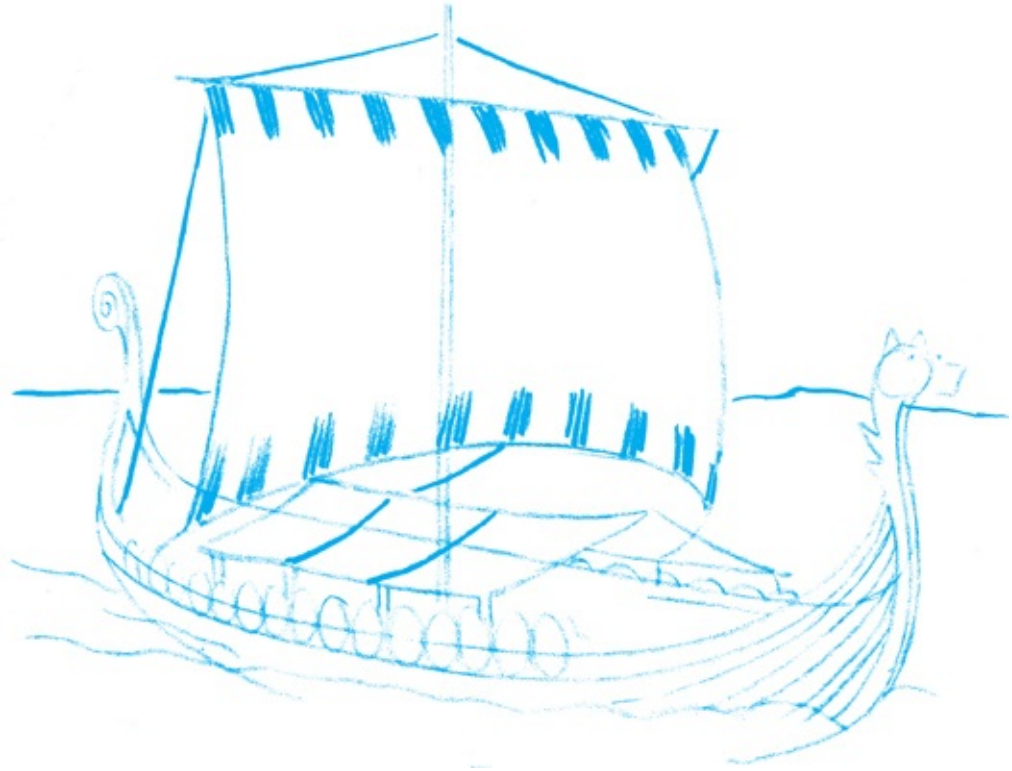

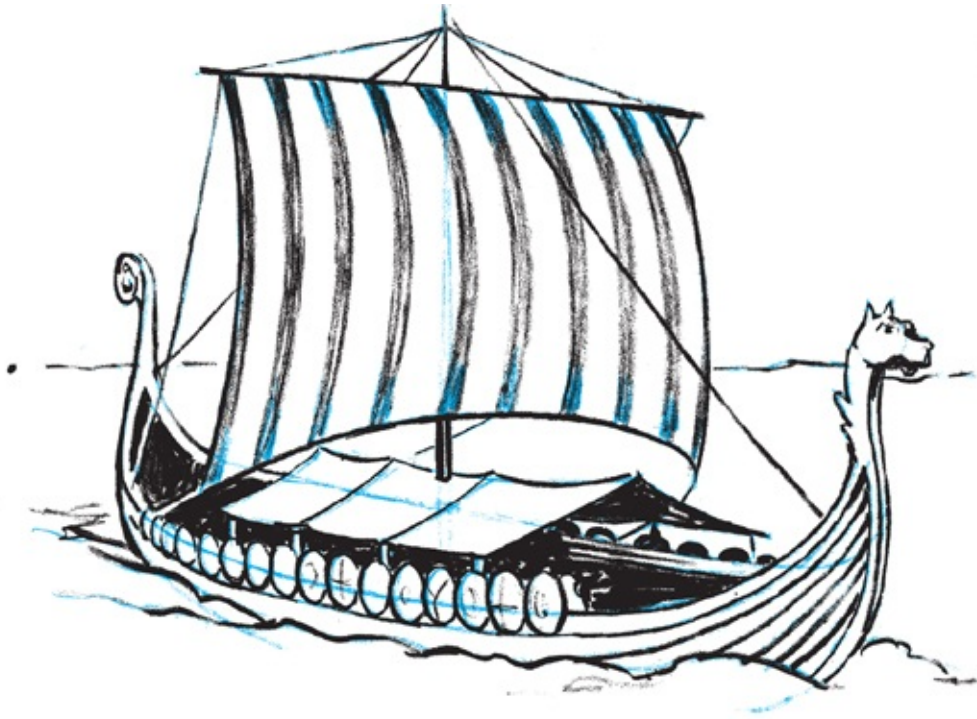



Santa Maria (1492)

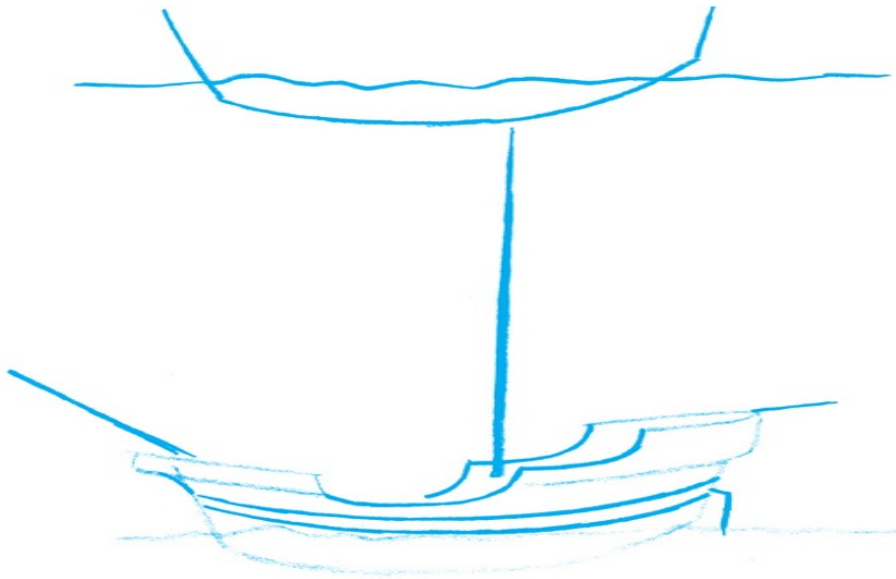

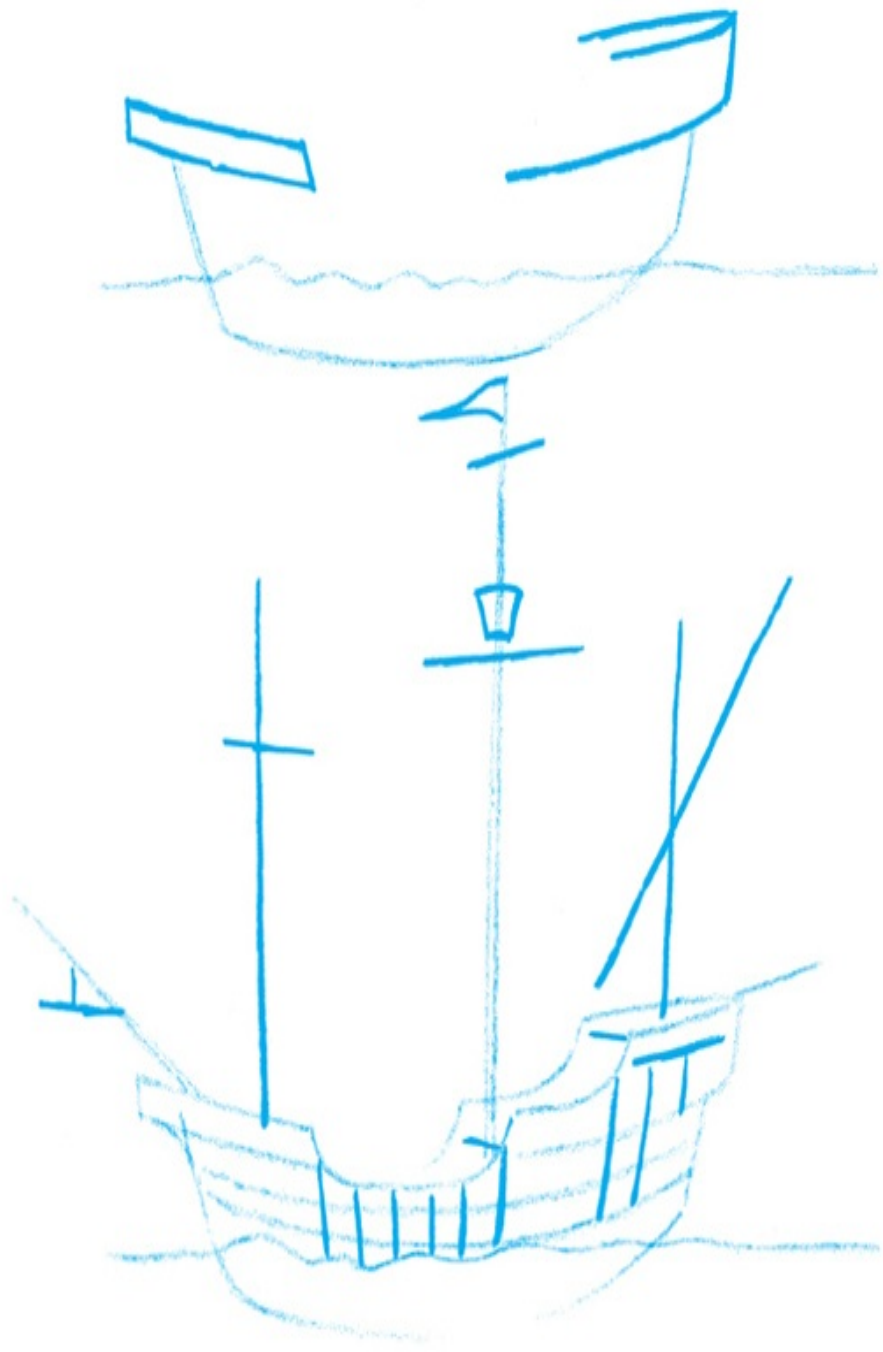



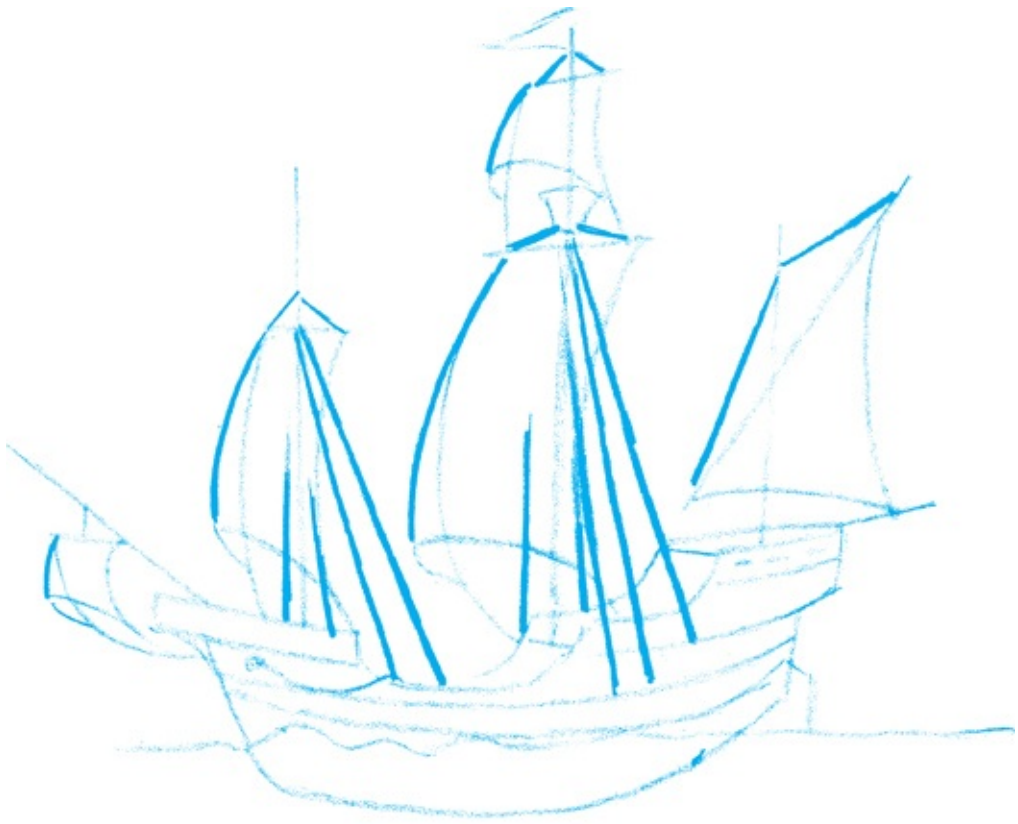

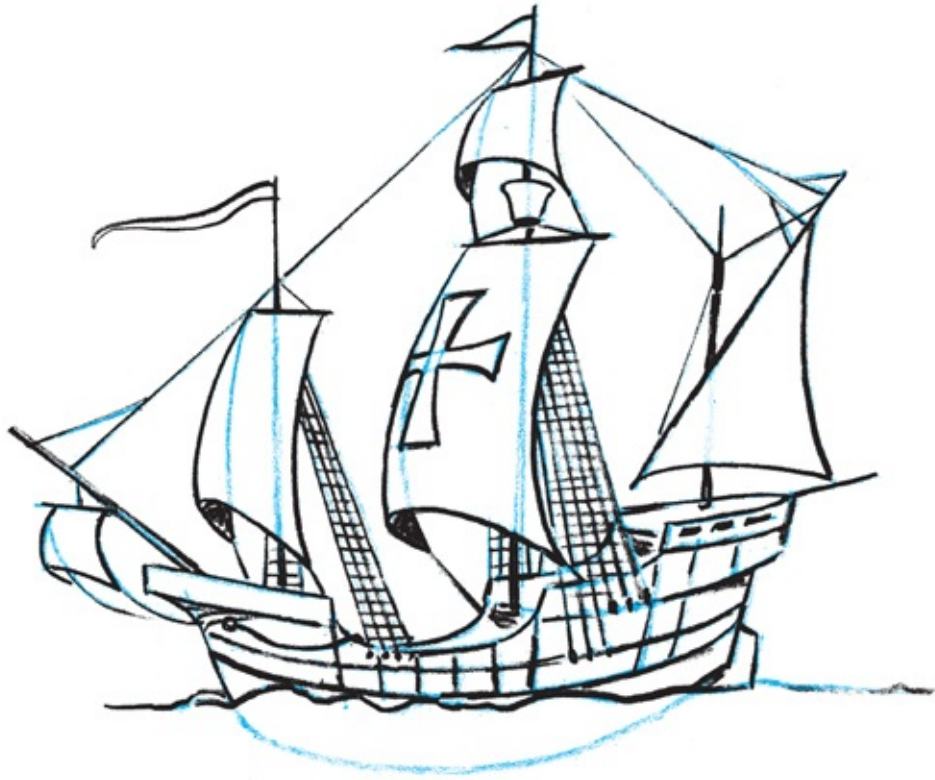



Chinese junk



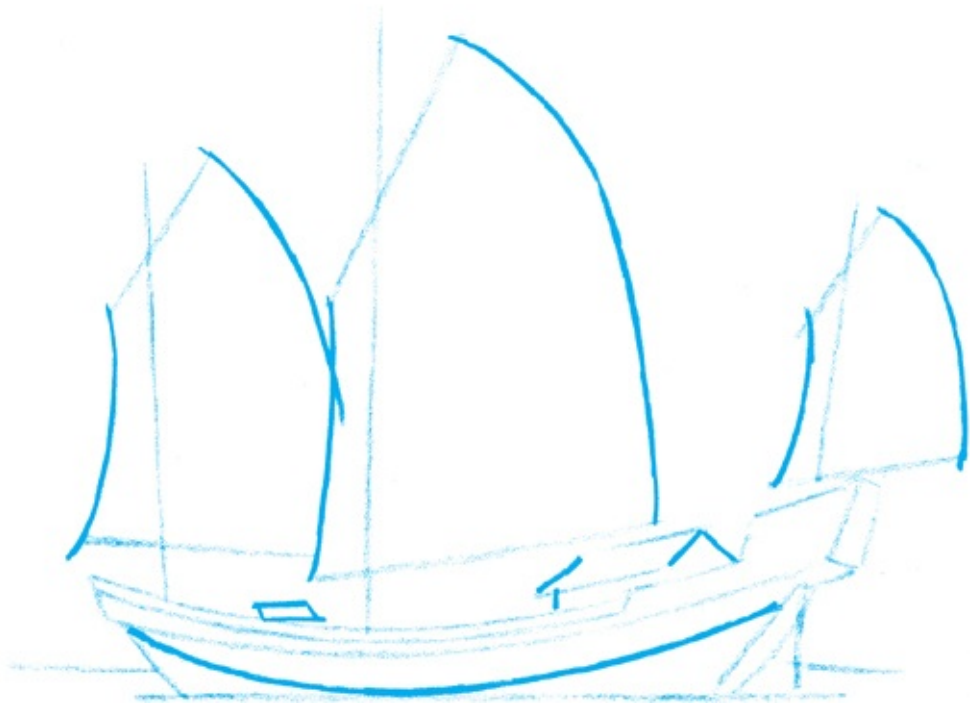
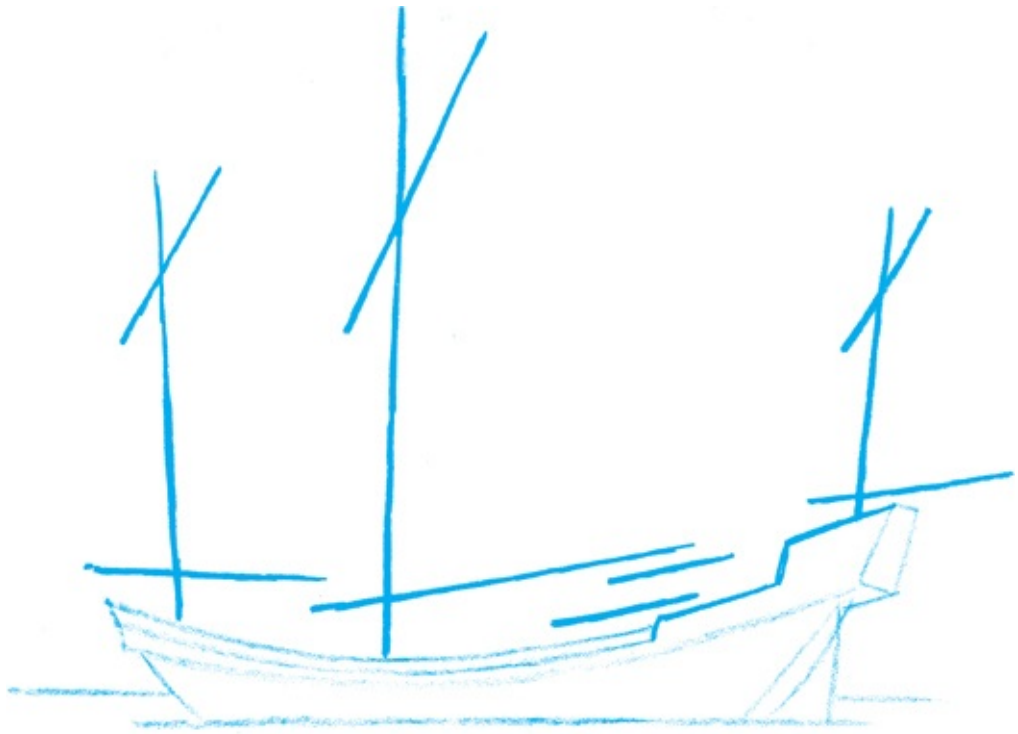

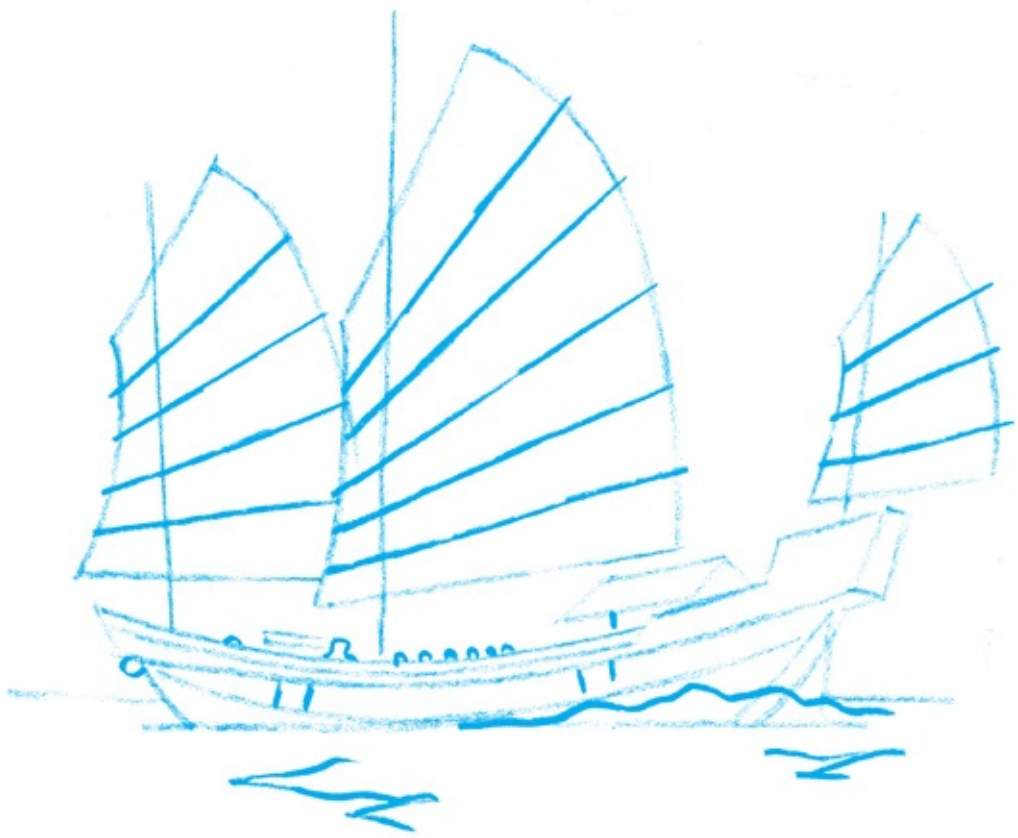

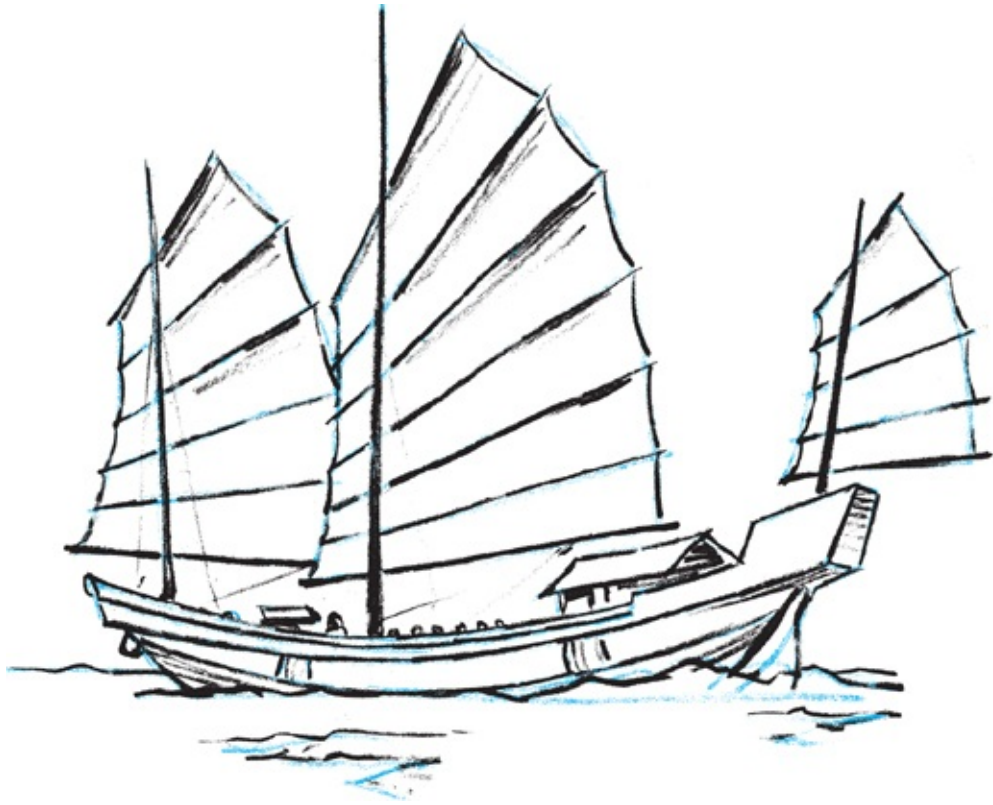



Dump truck

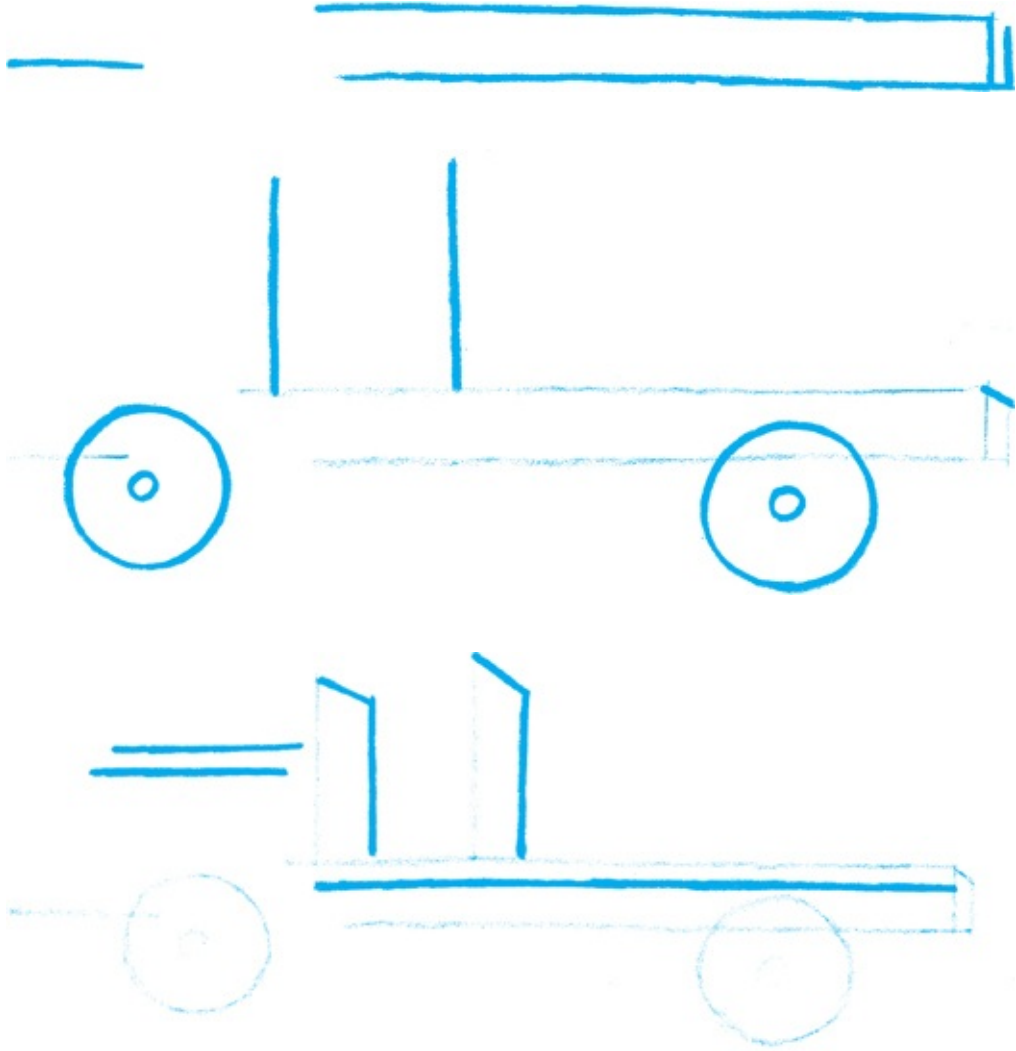

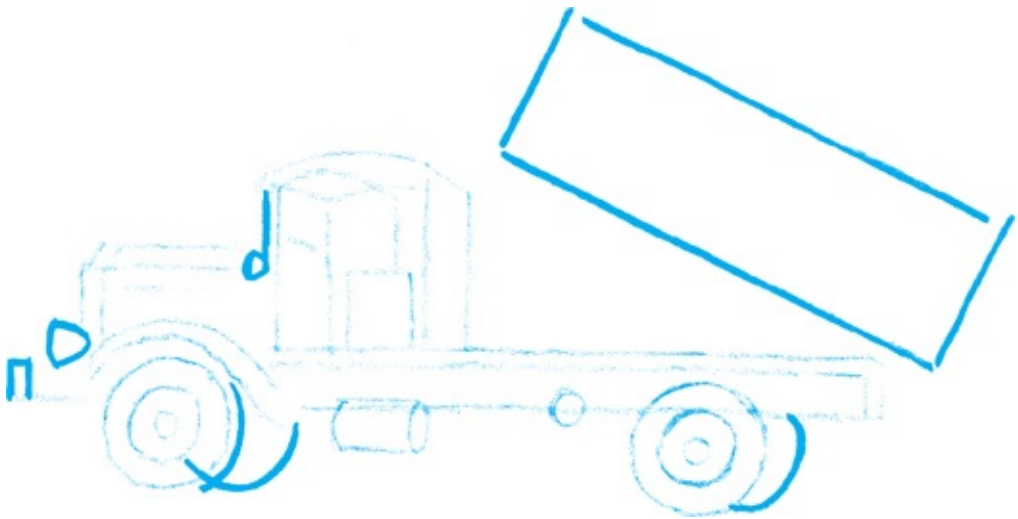
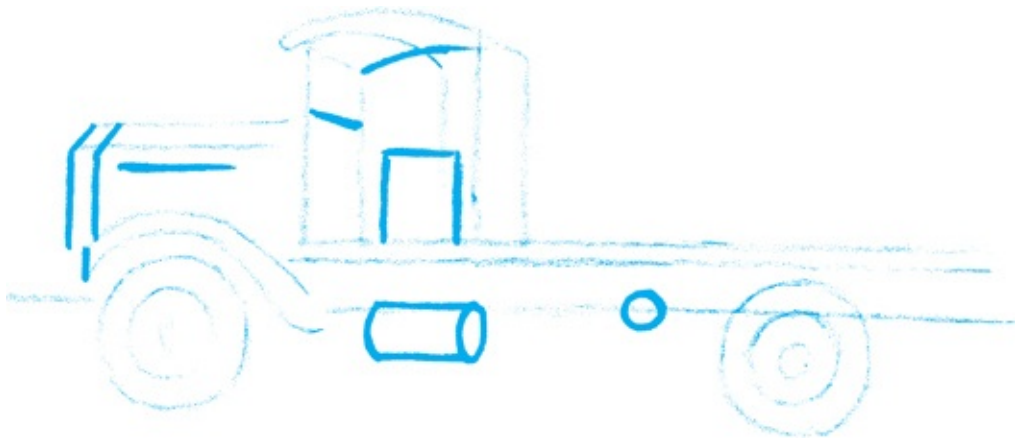

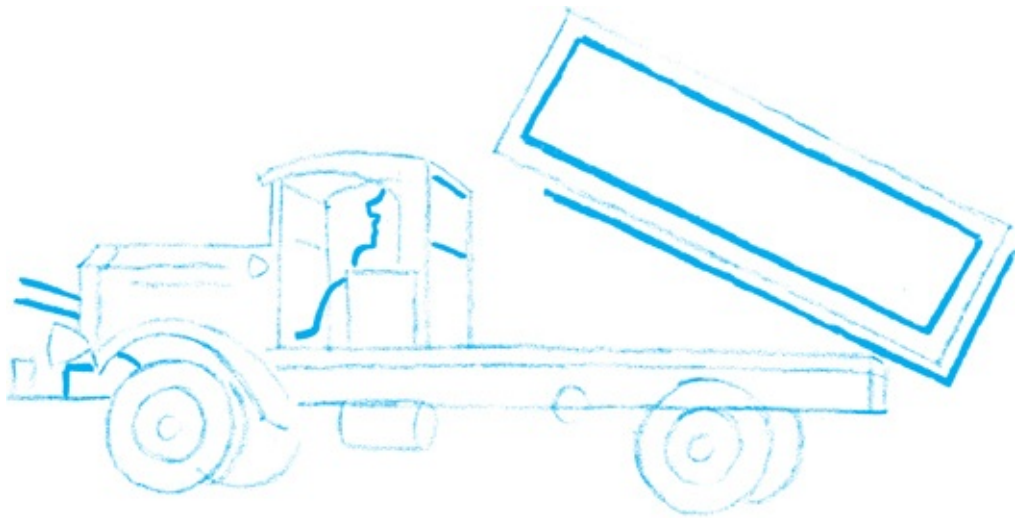

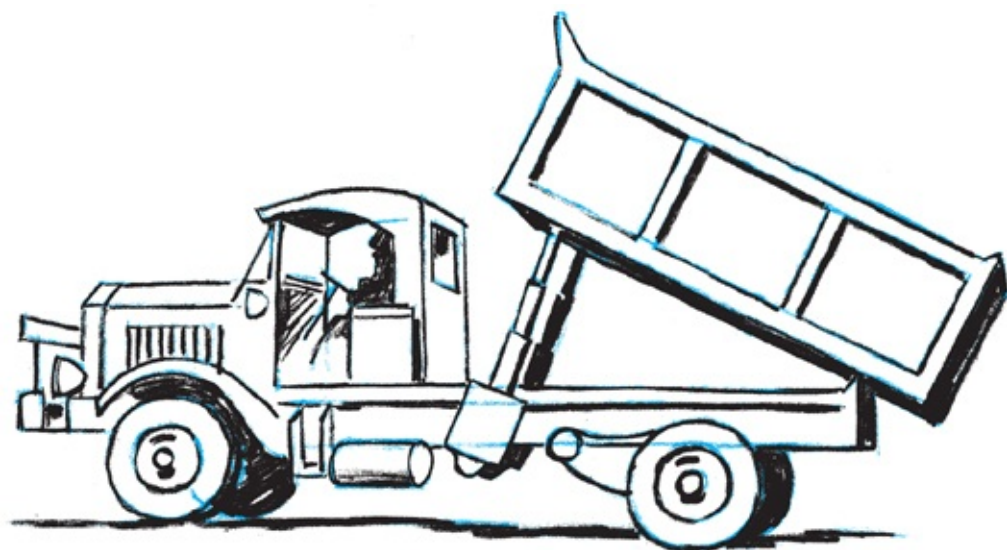



Heavy-duty truck

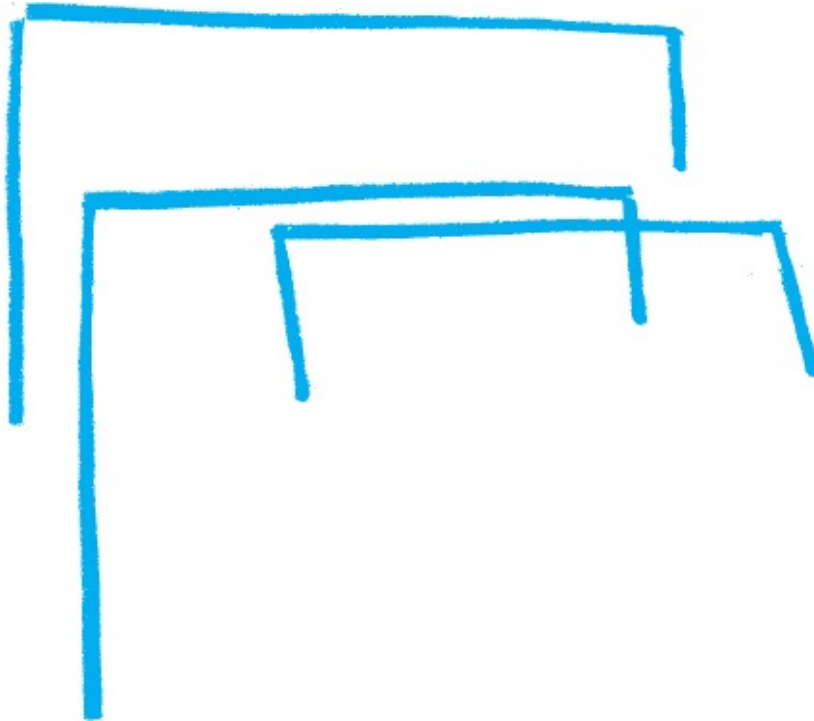

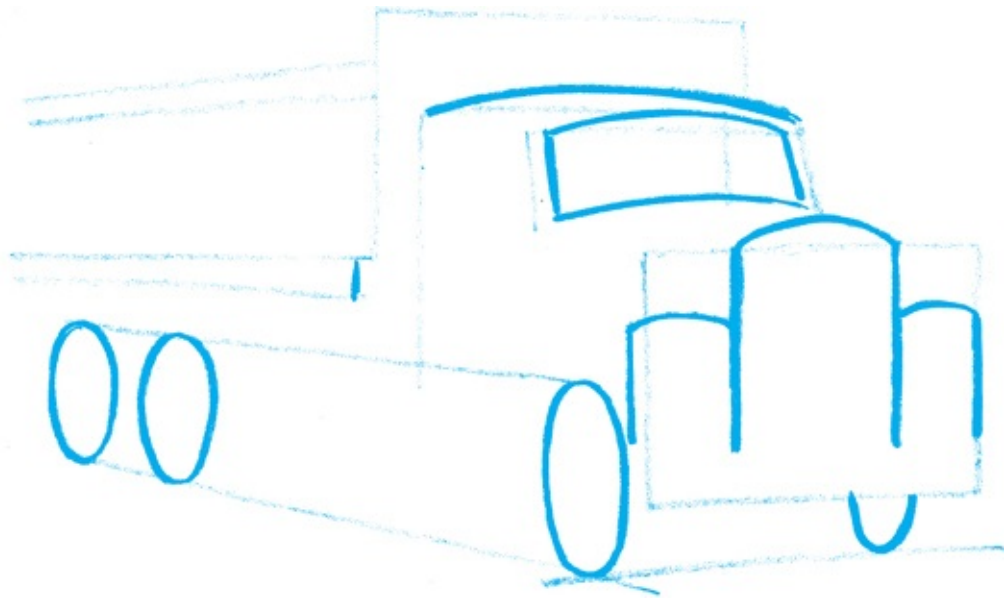
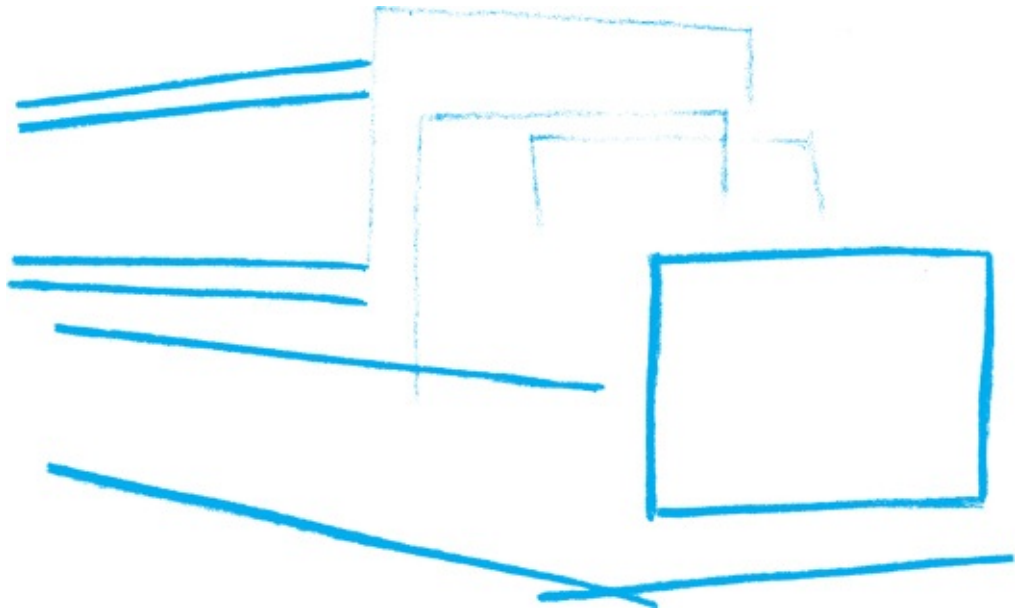

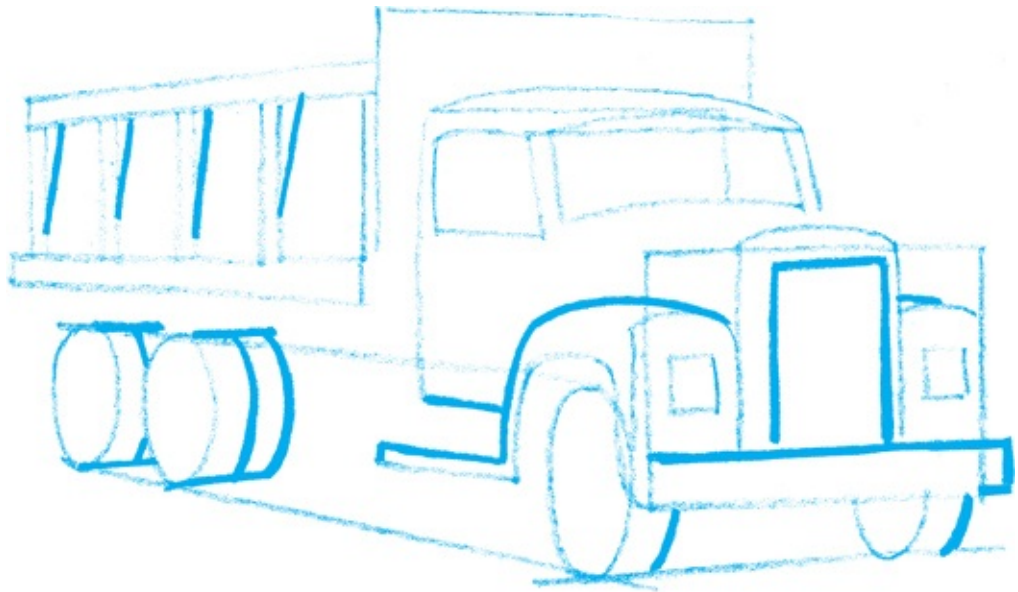
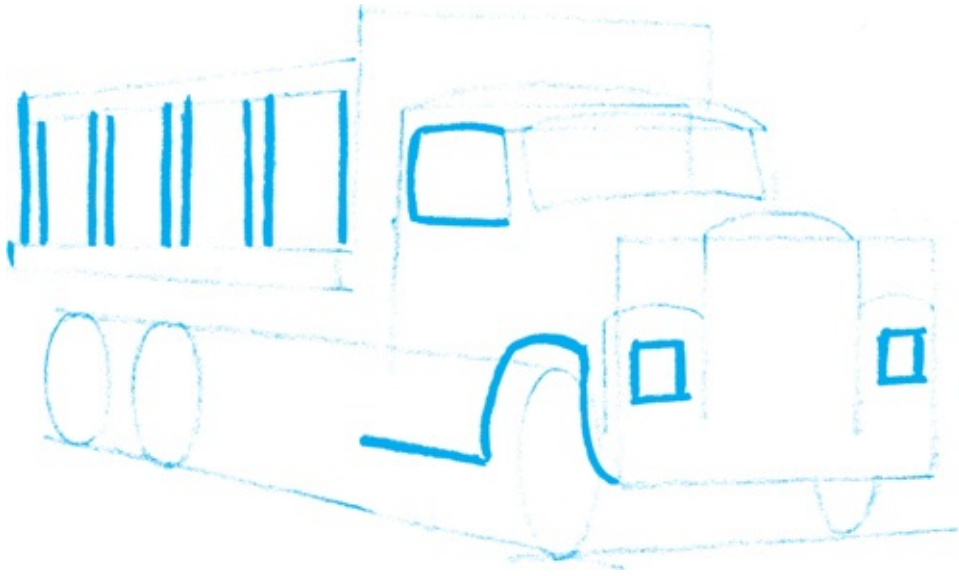

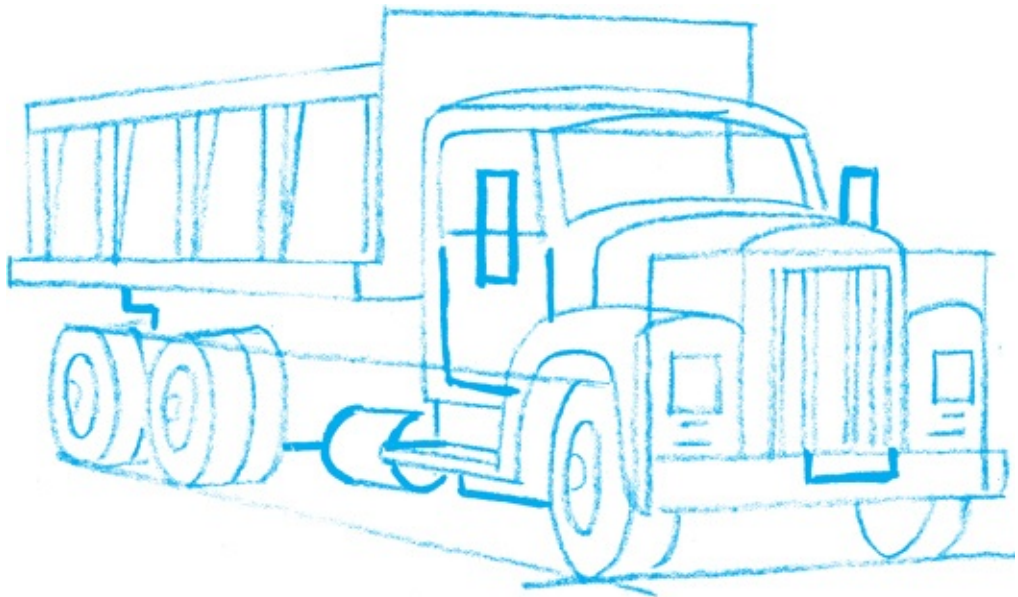
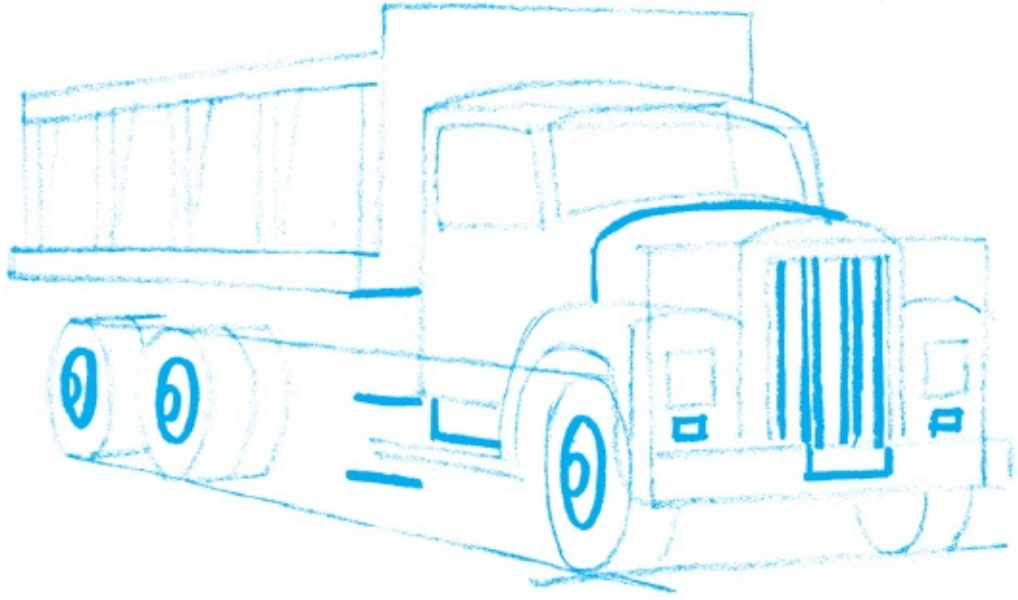

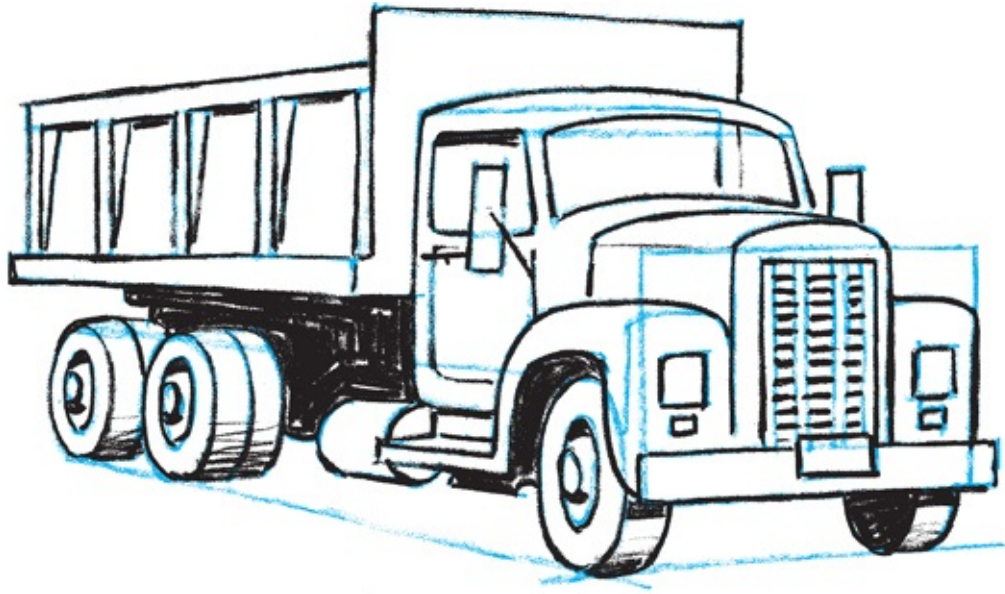



Fire truck



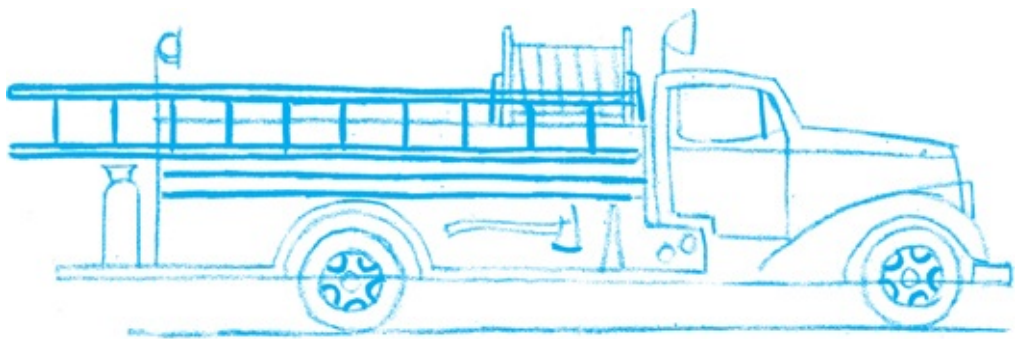
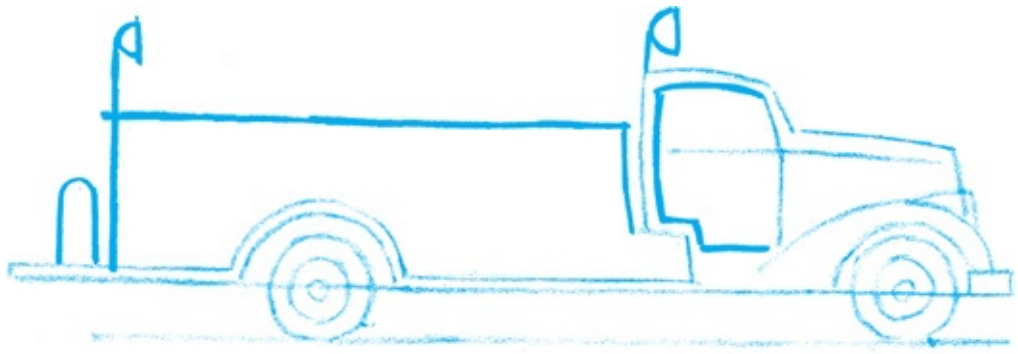

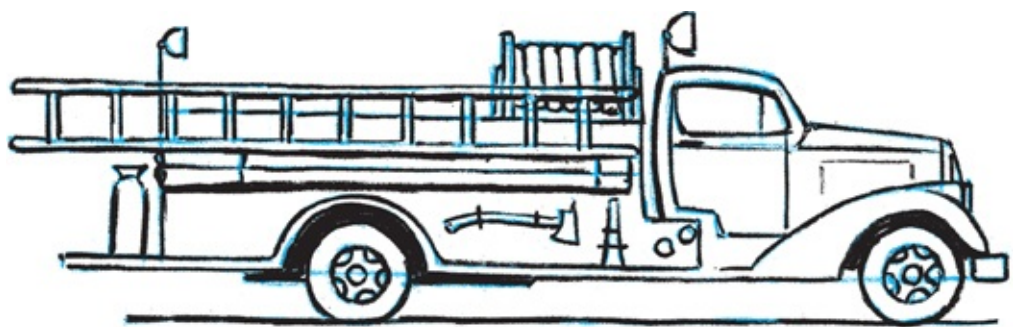



Tank tractor-trailer

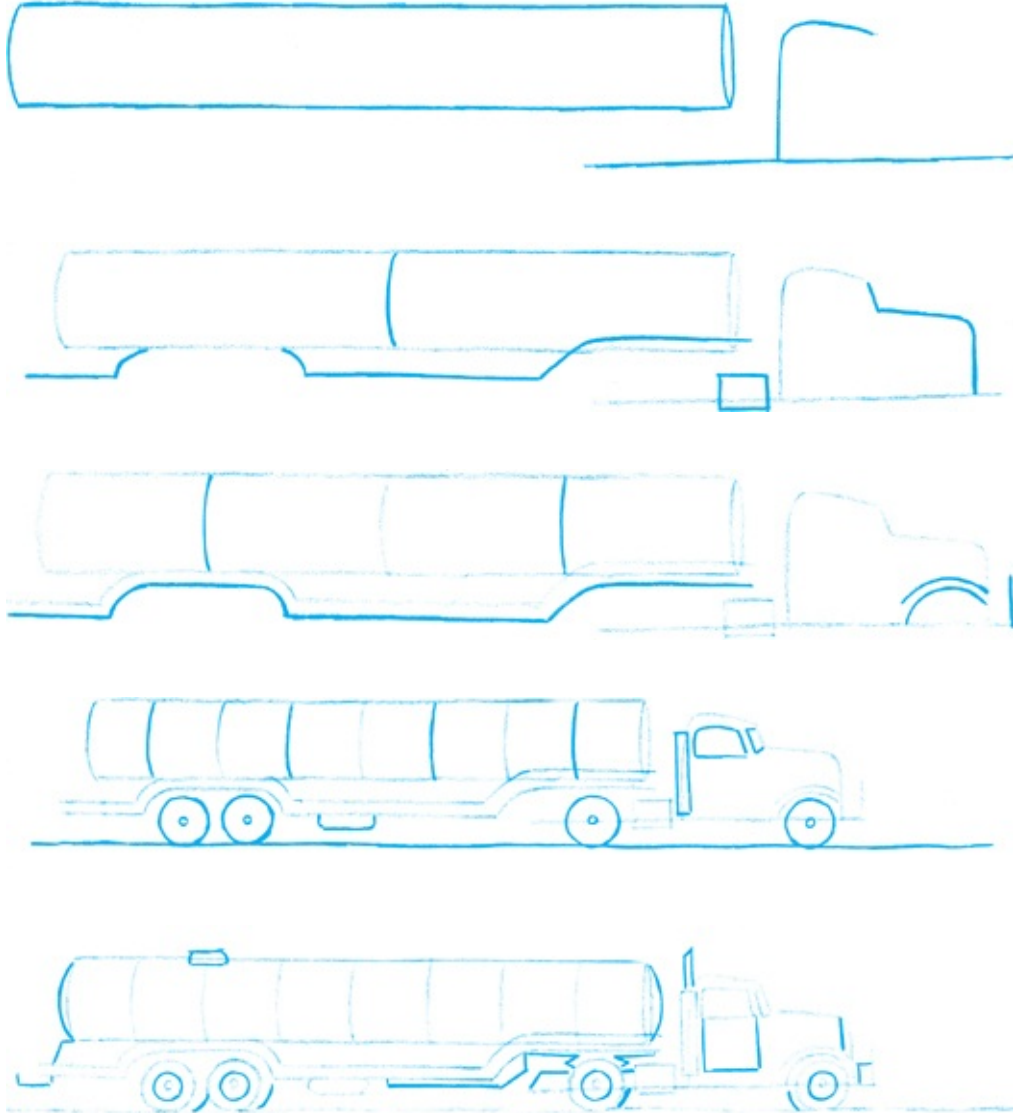

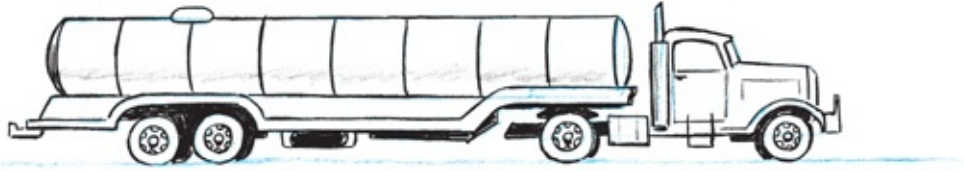



Moving van

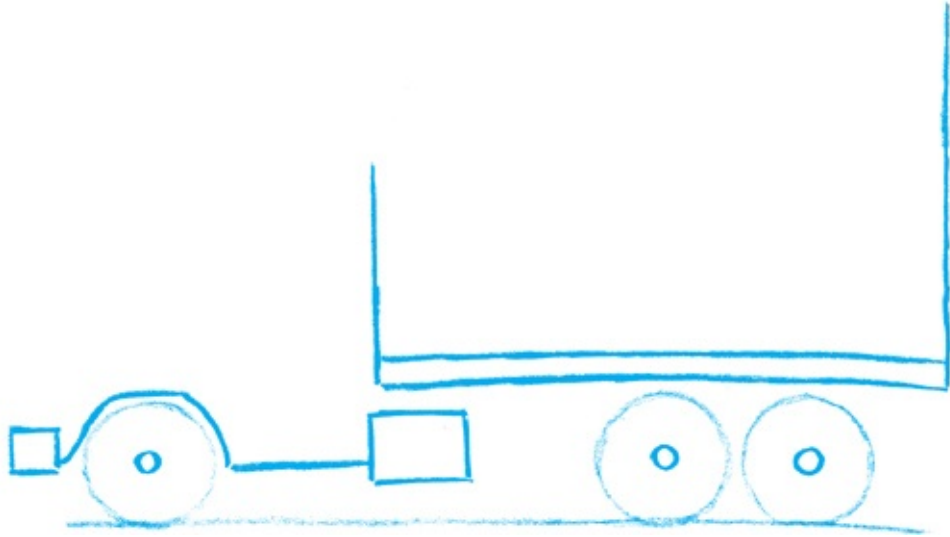

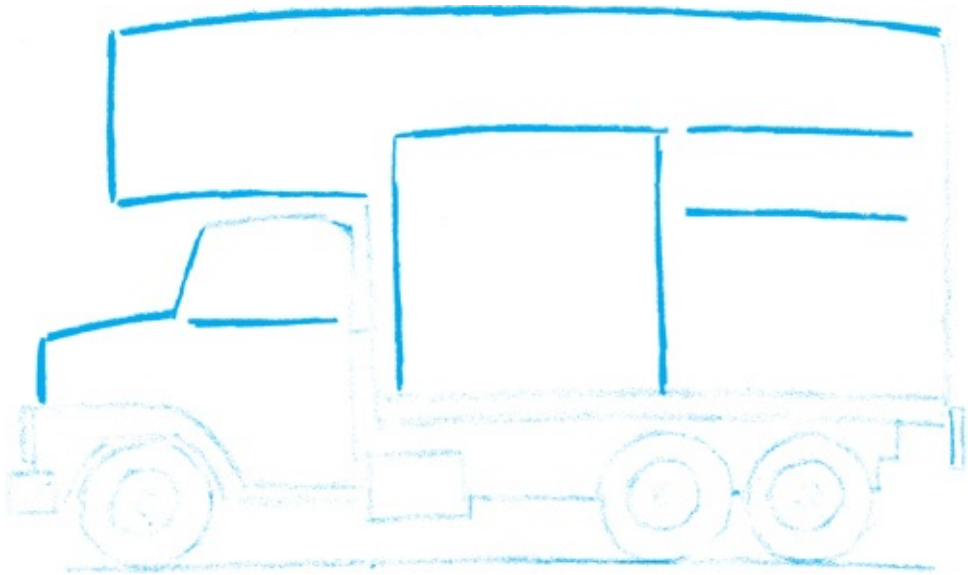
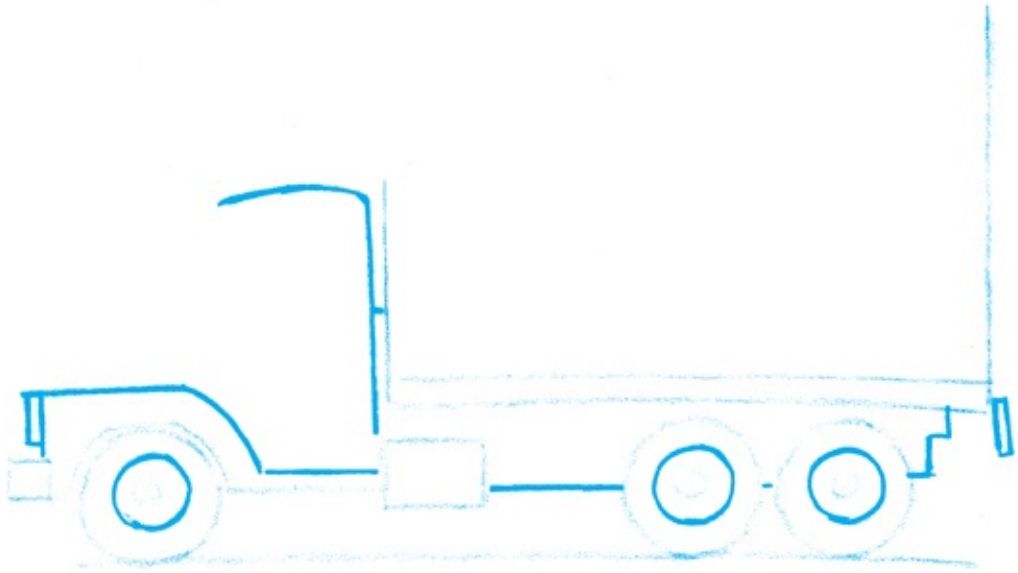

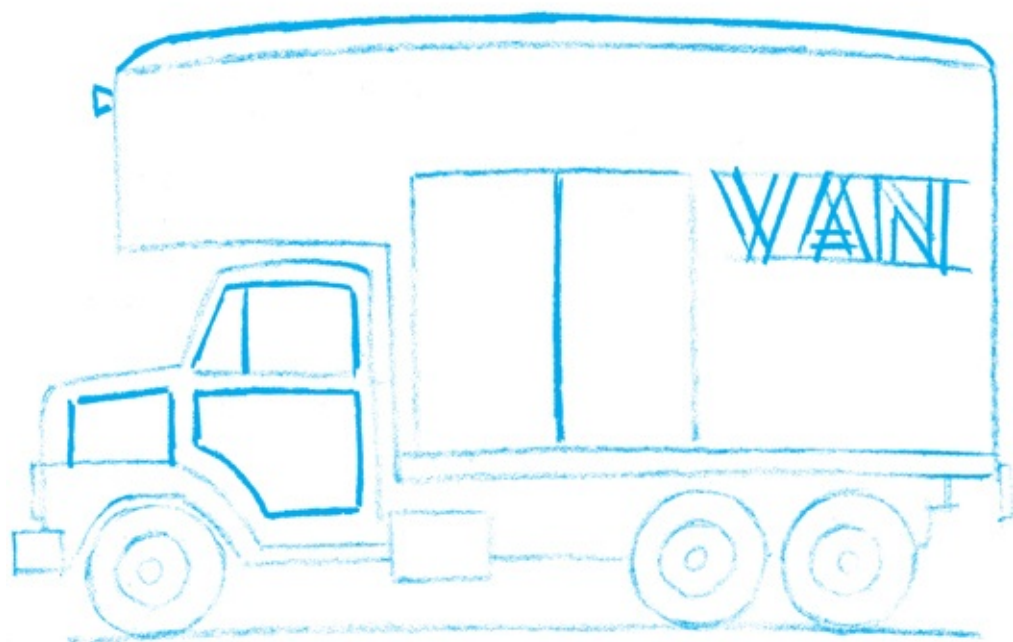

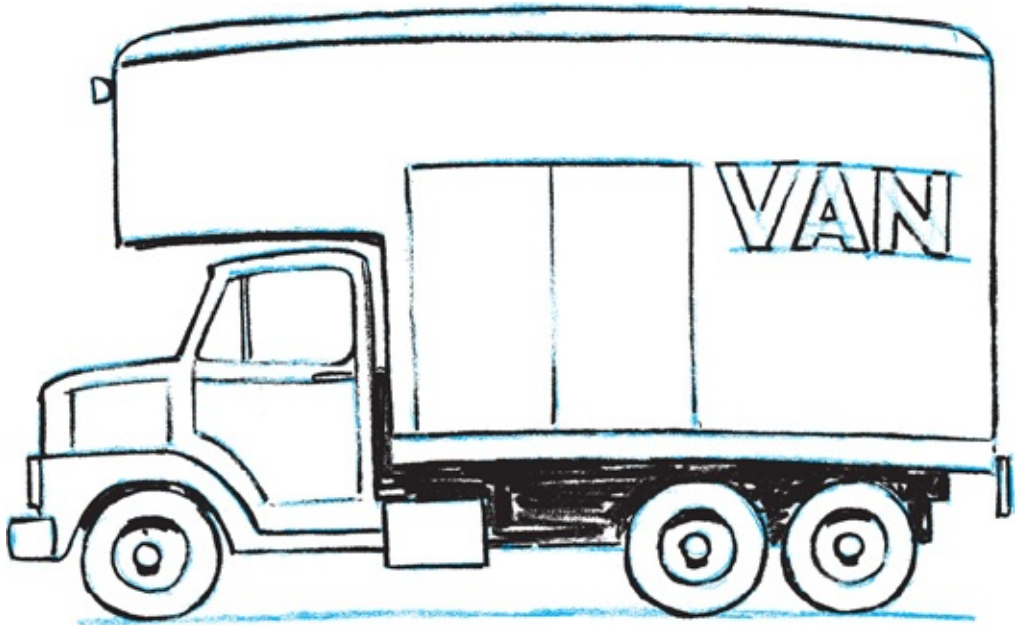

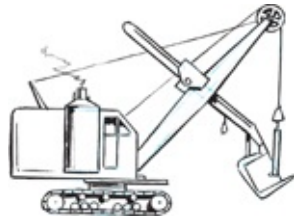

Steam shovel

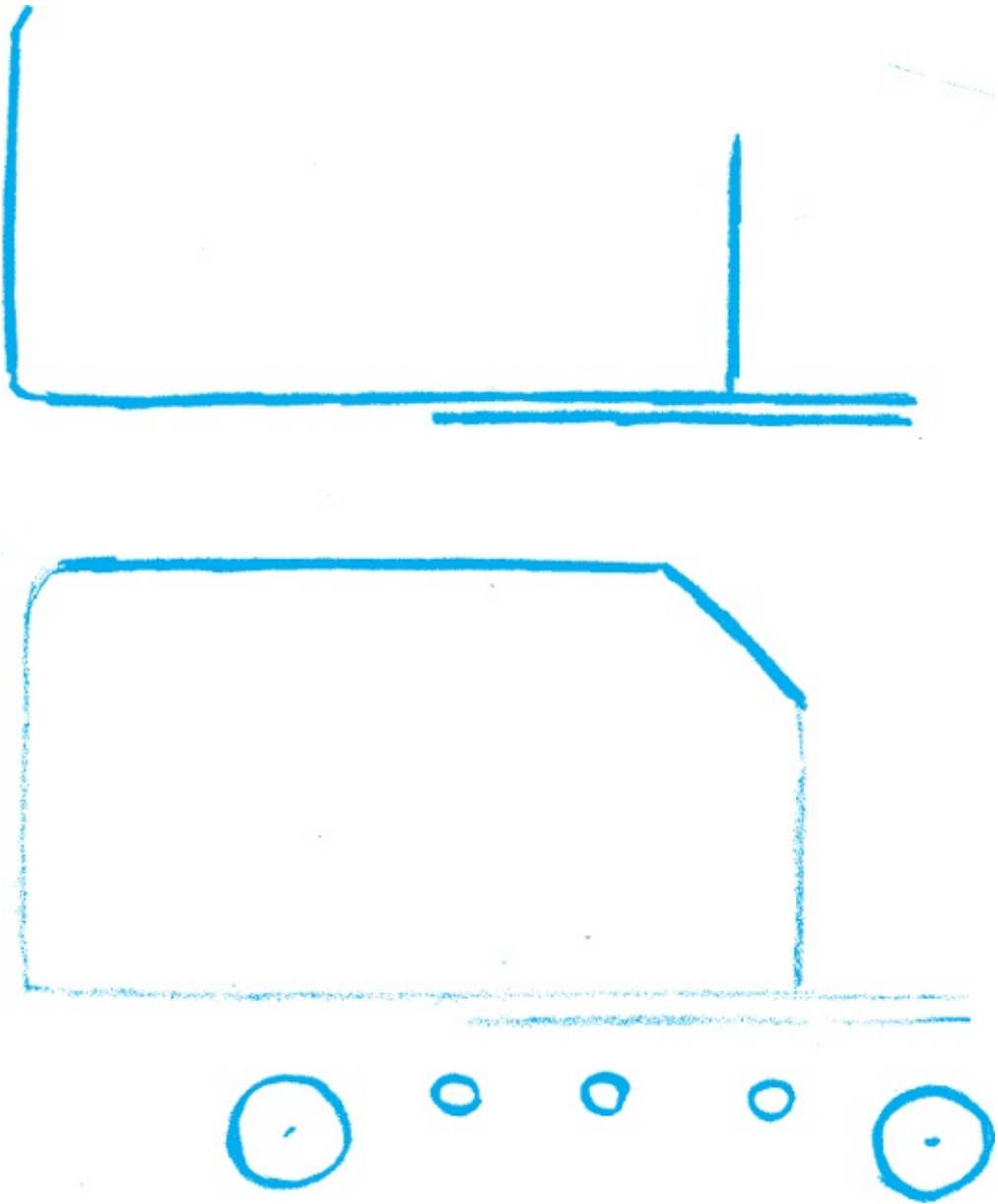

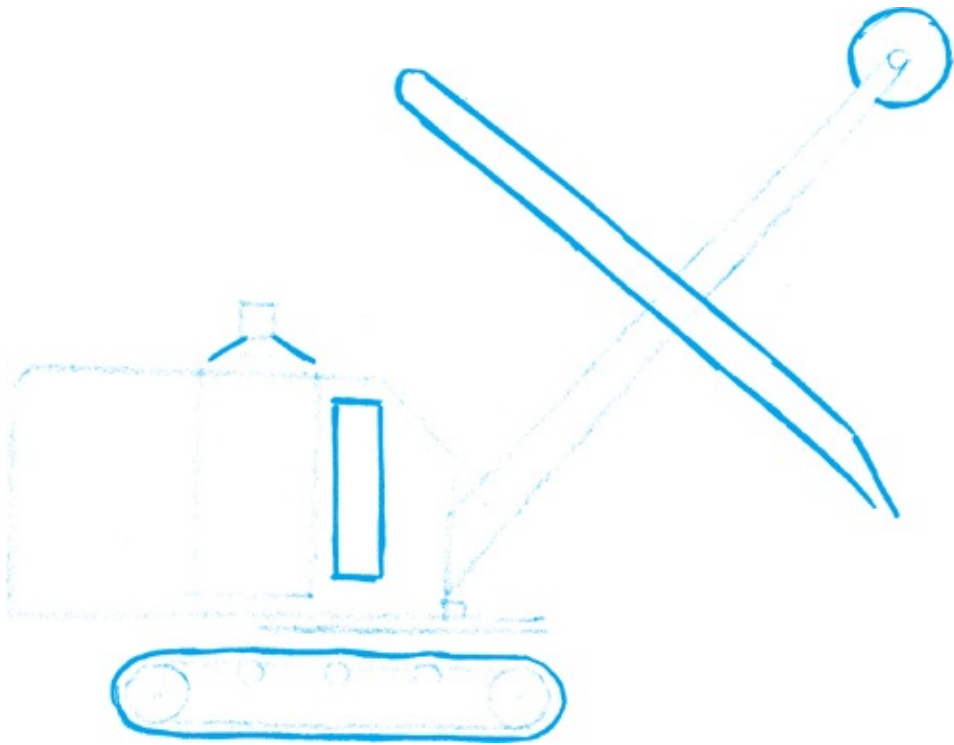
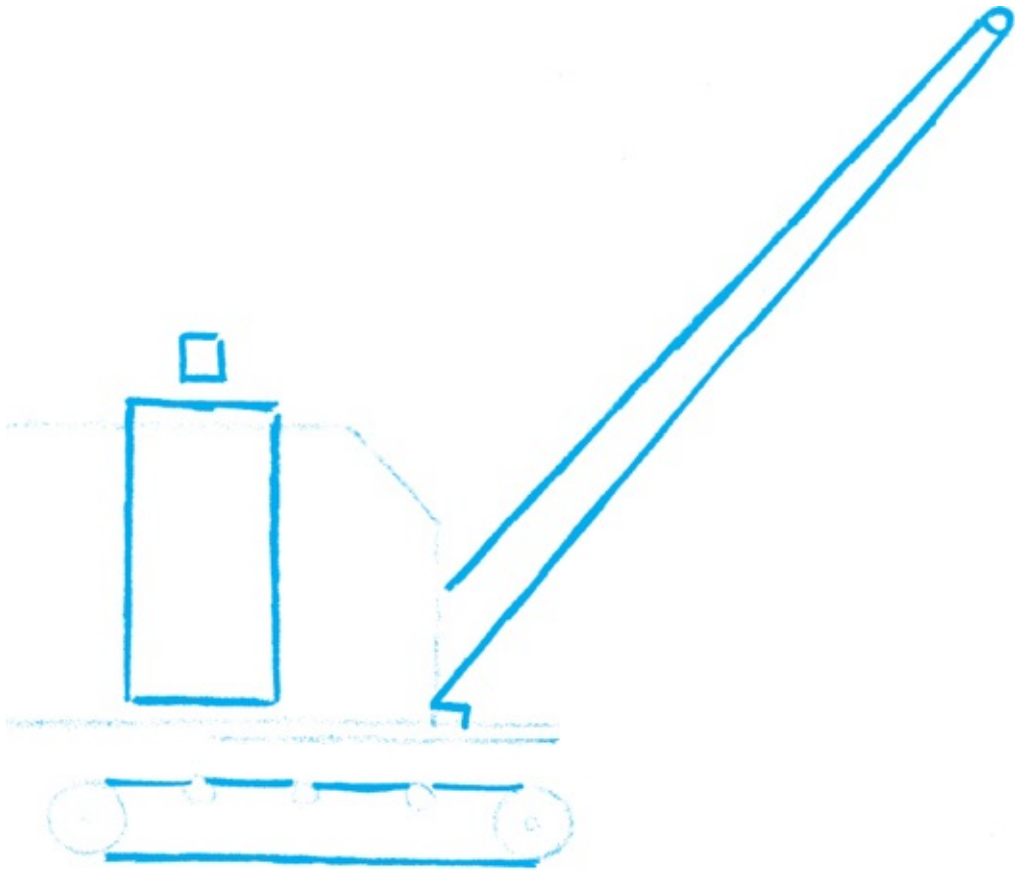

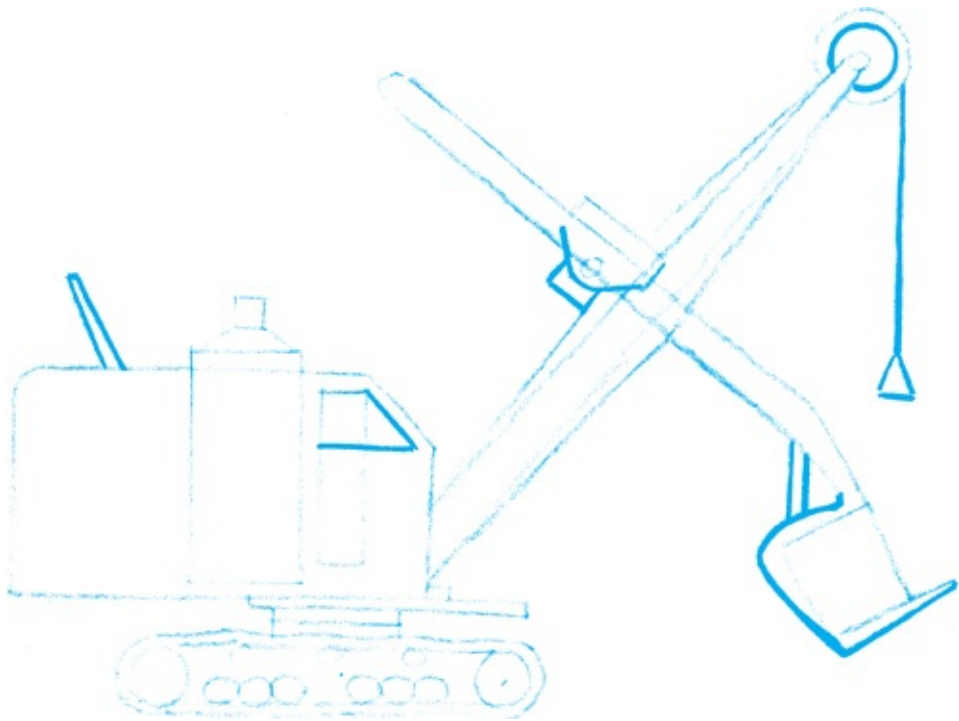
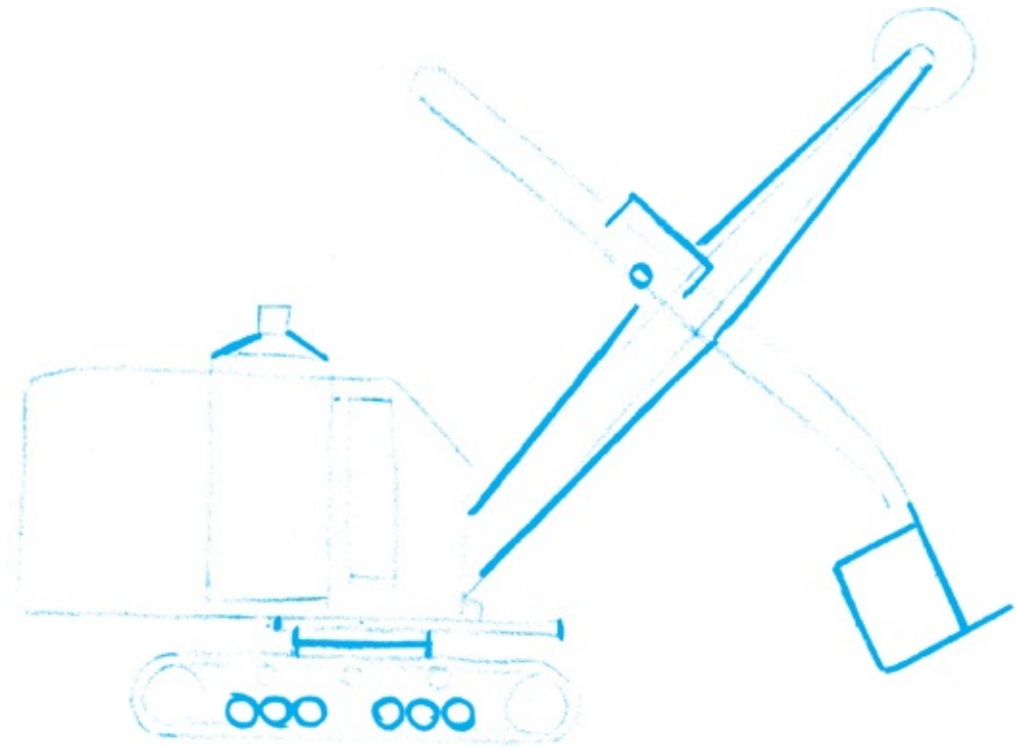

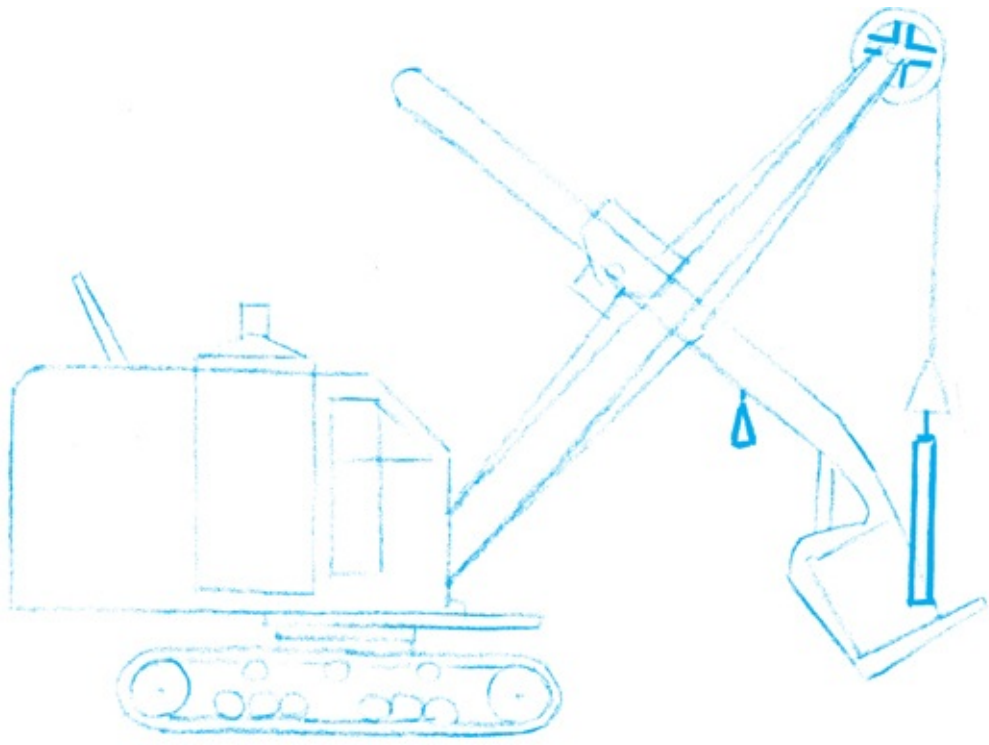

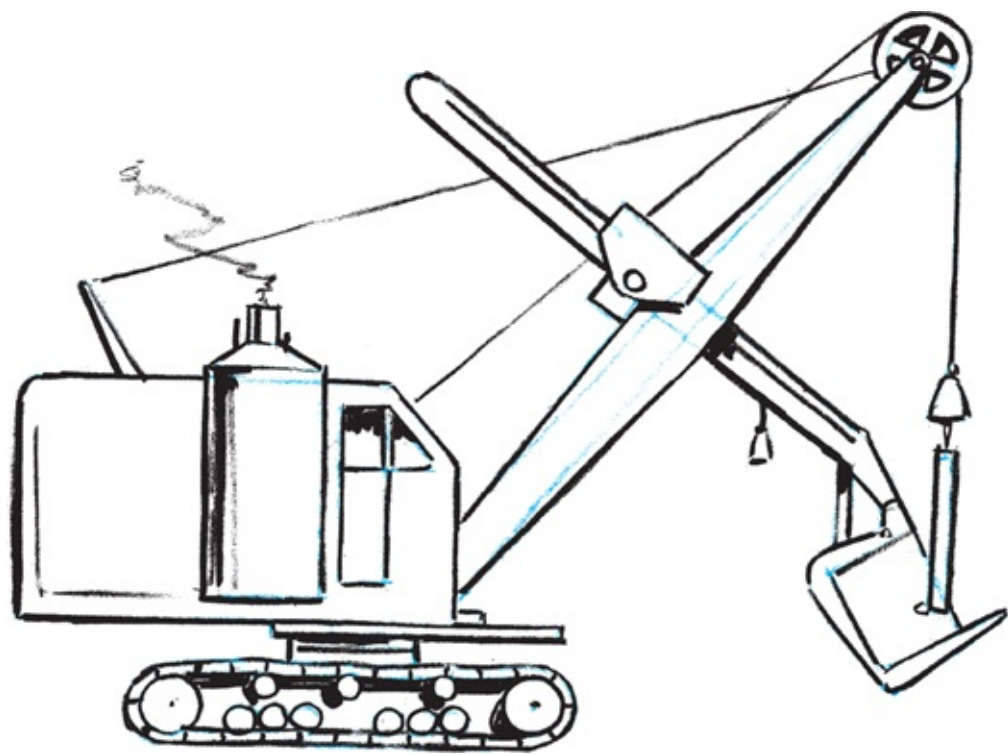



Military tank

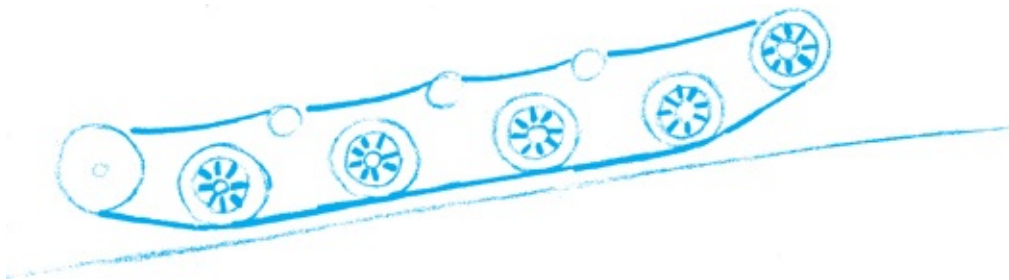
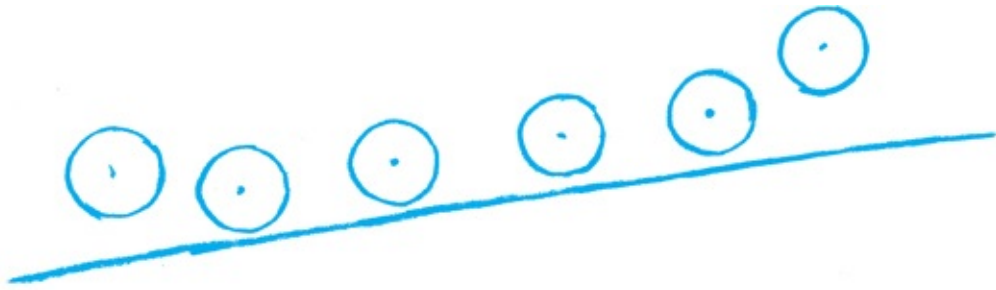

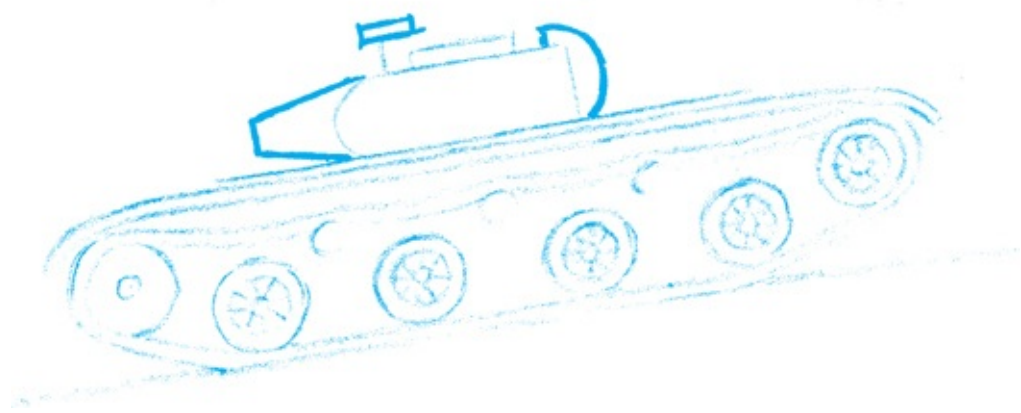
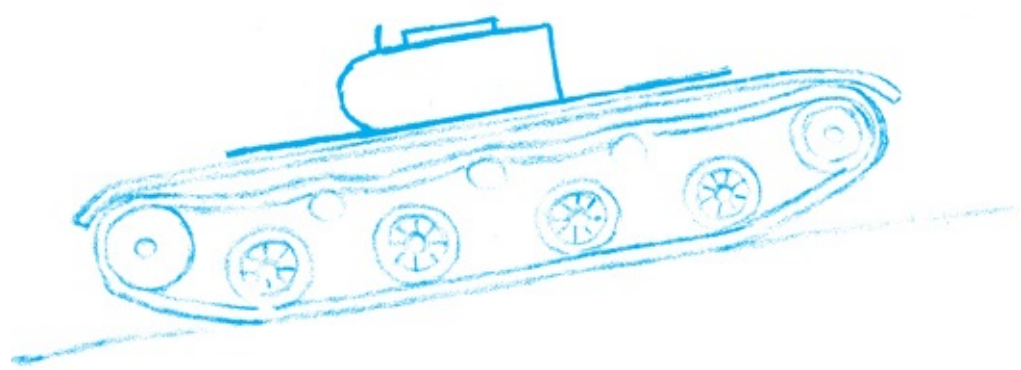
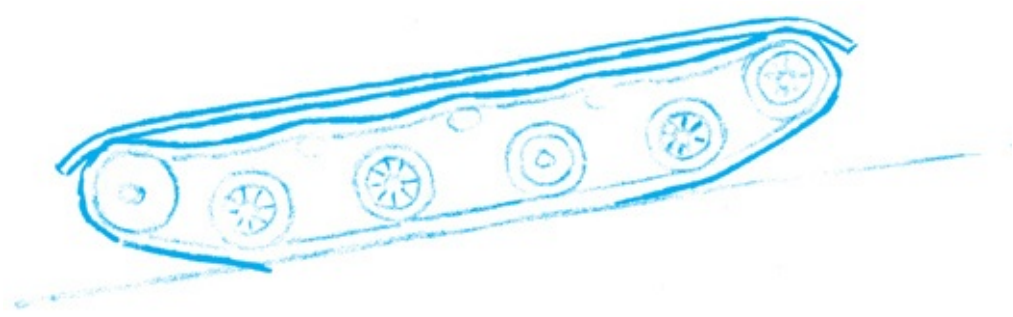

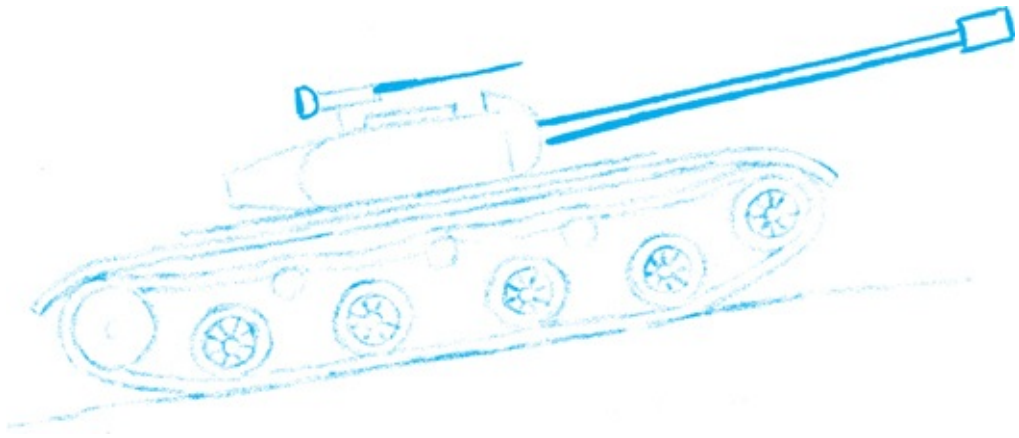

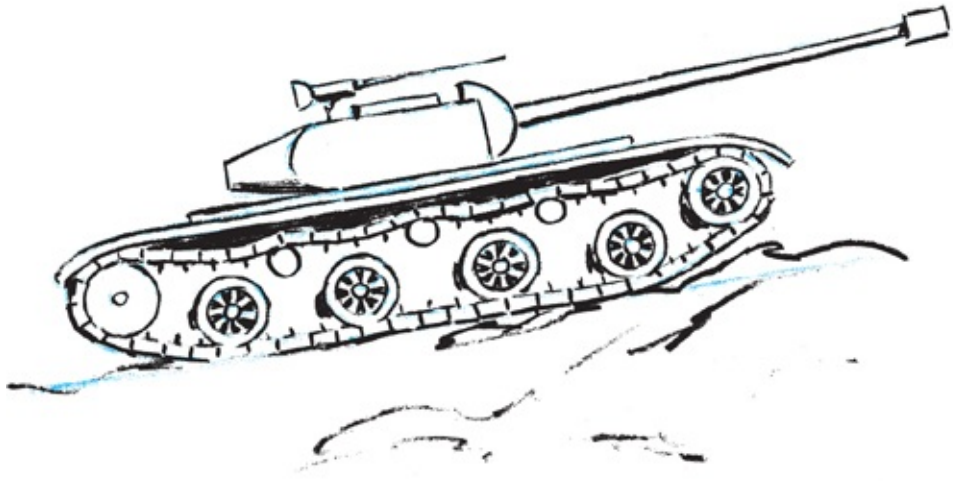



Early steam locomotive

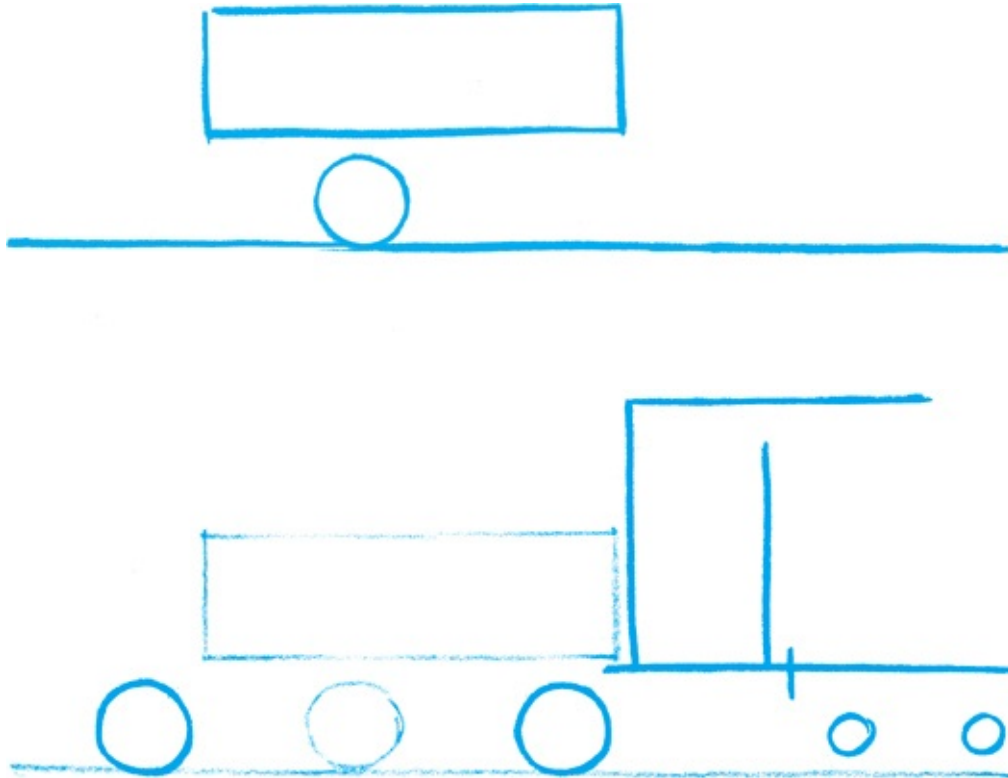

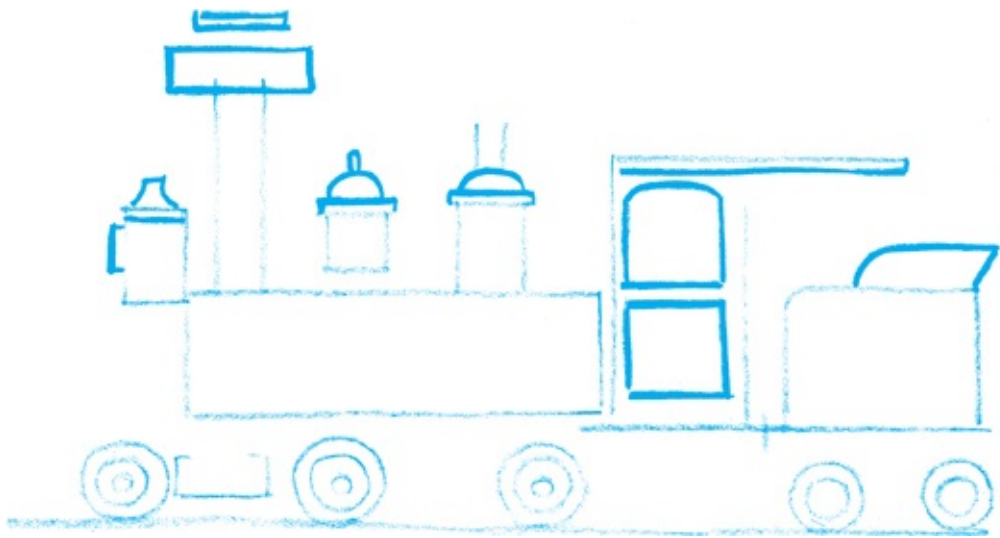
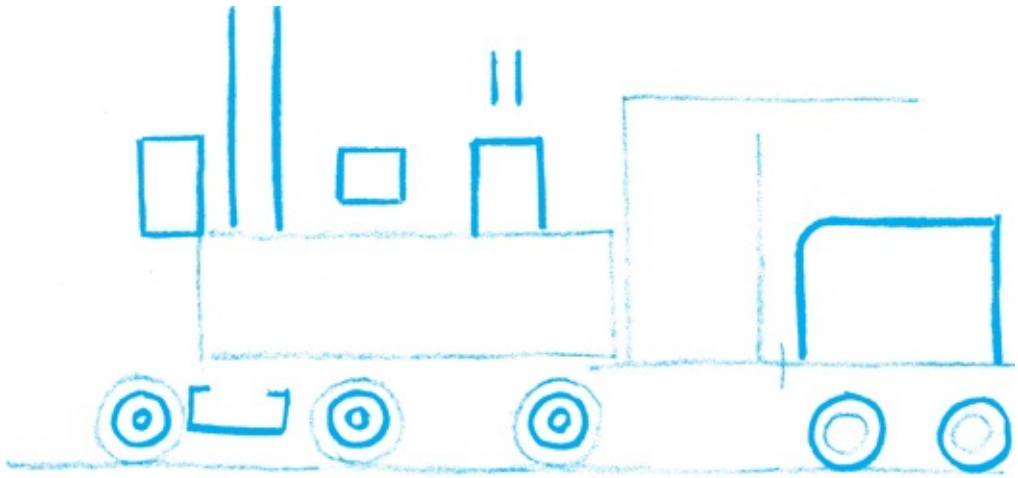

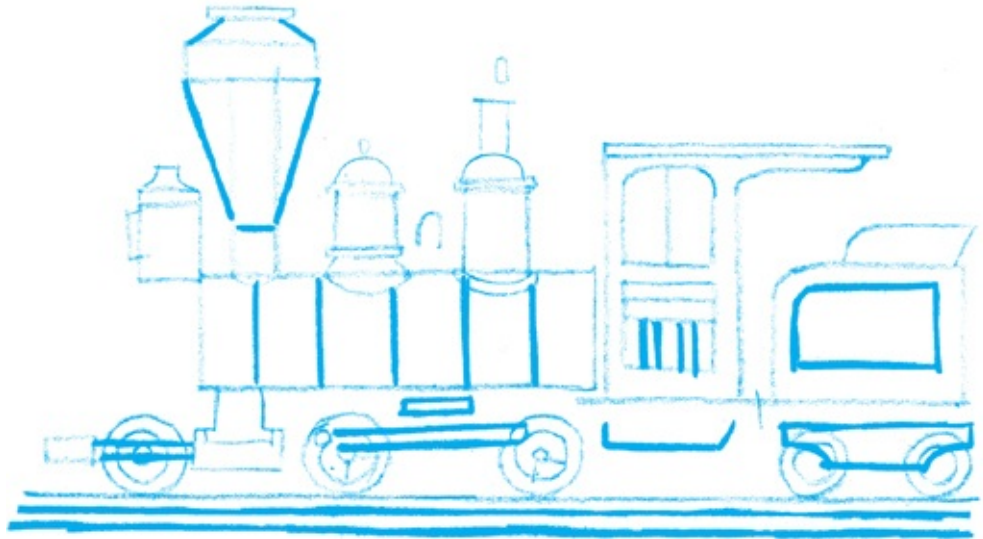
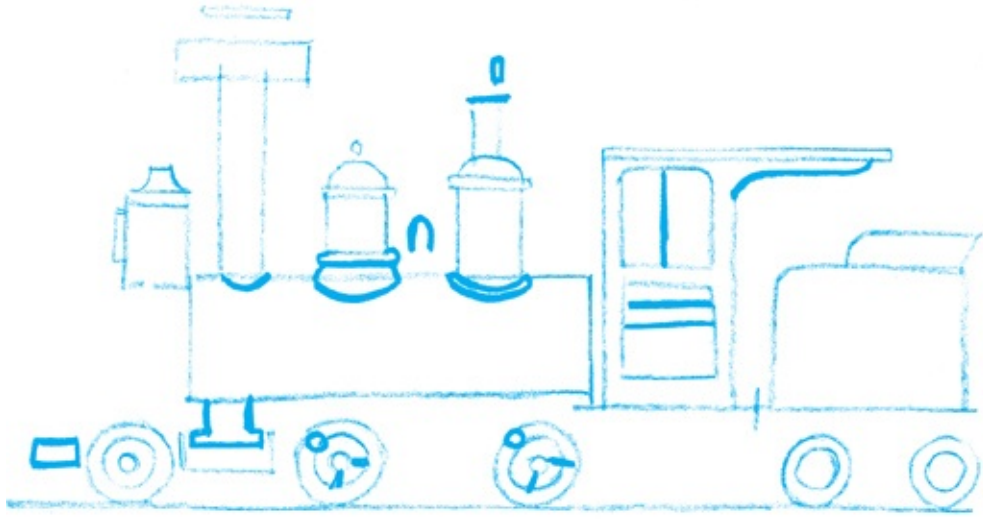

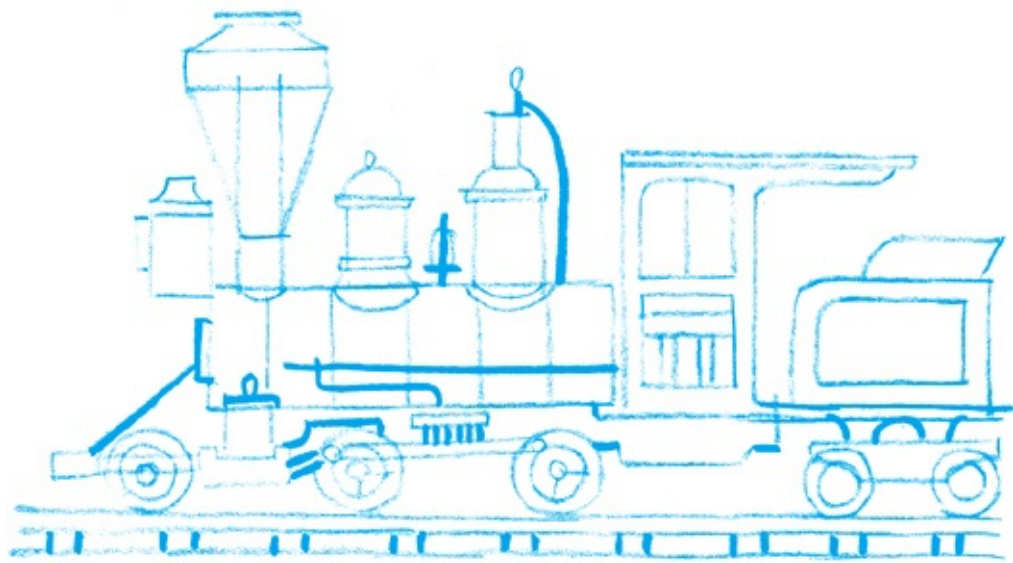

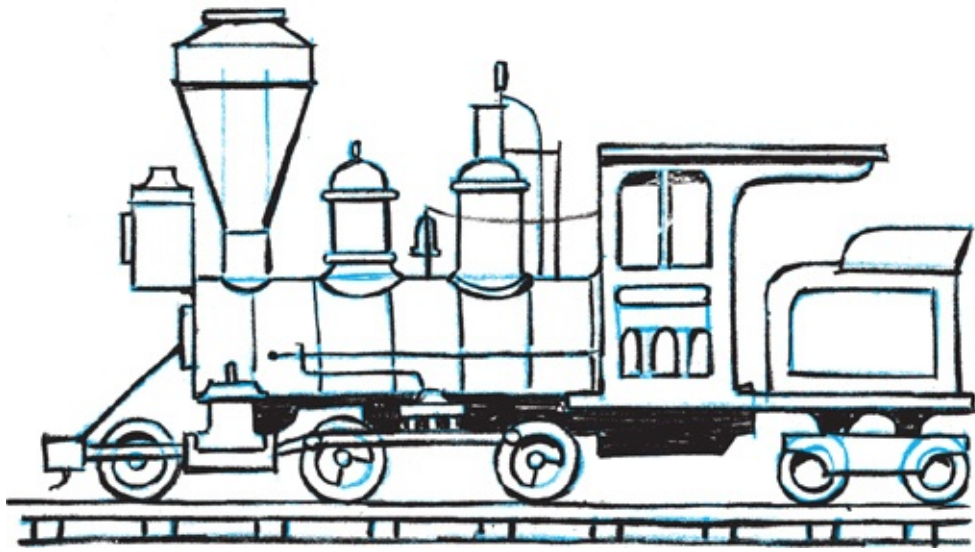



Steam locomotive

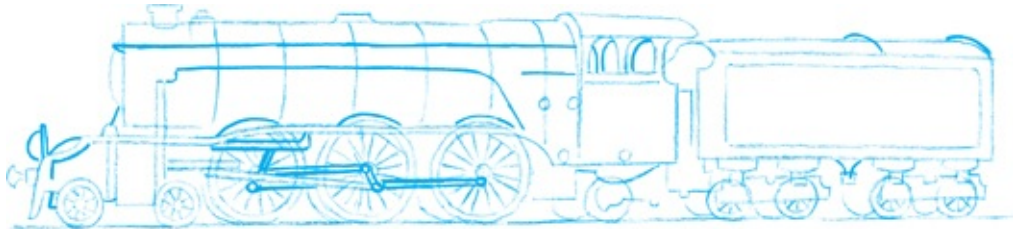
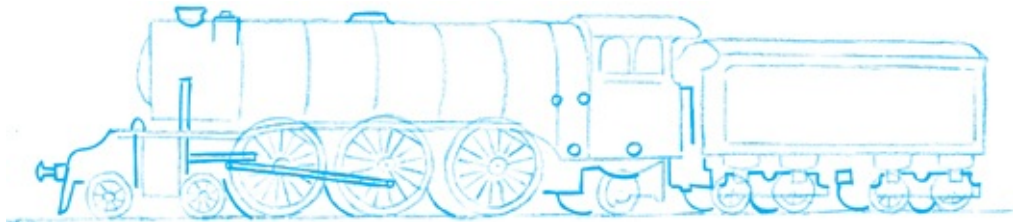
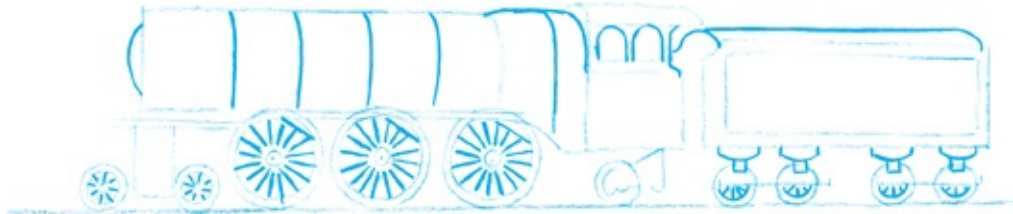
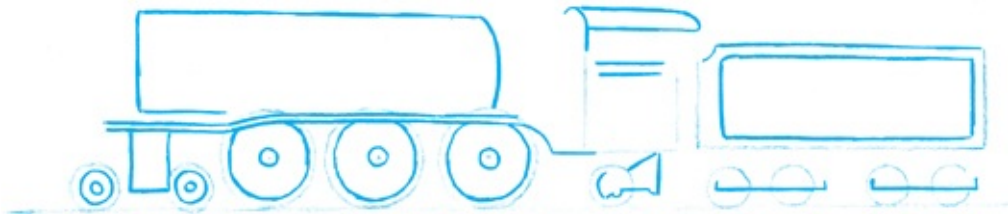

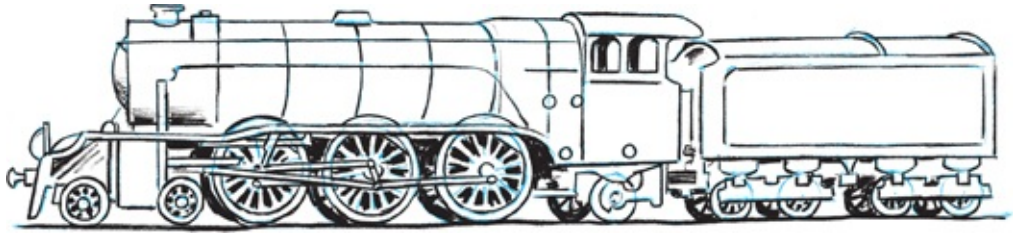



Diesel streamliner

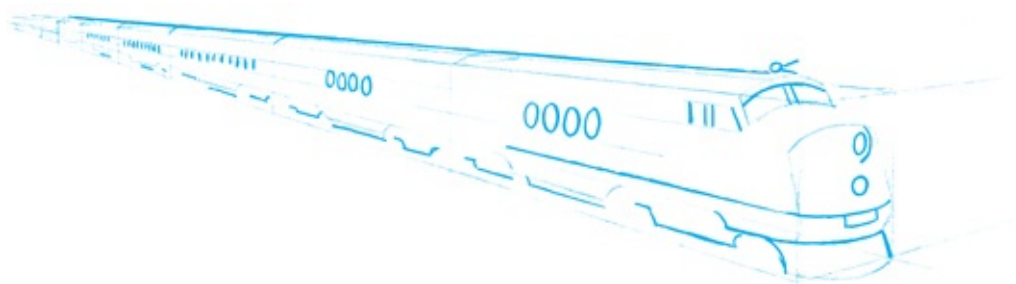
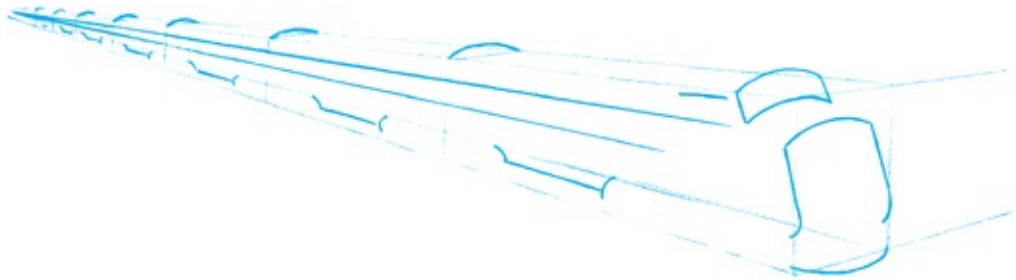
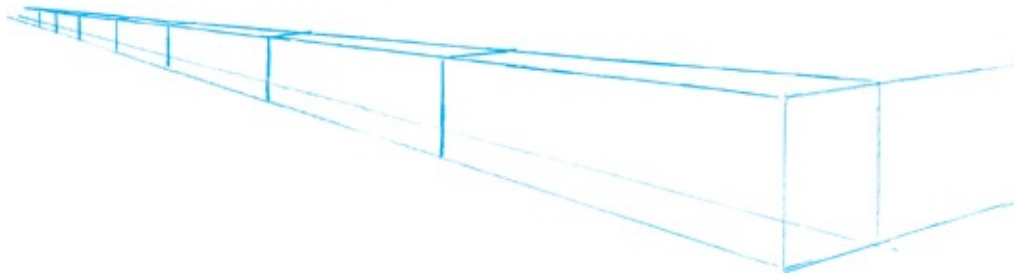
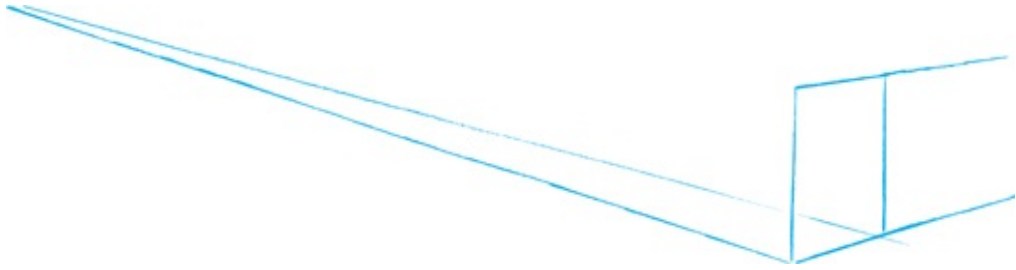

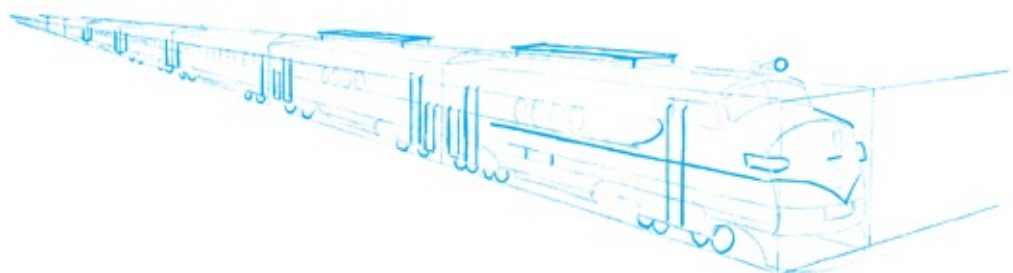

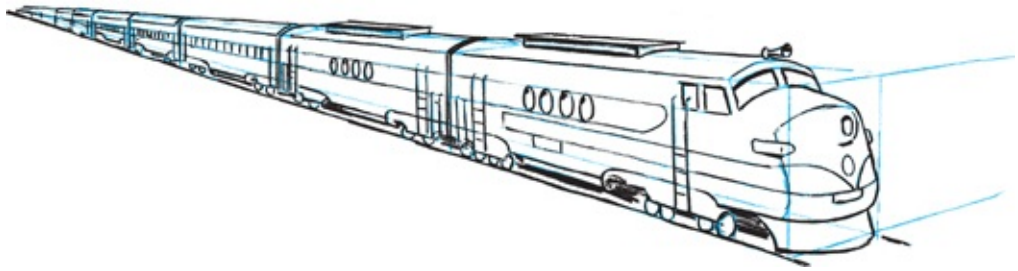



Concorde SST (Britain-France)

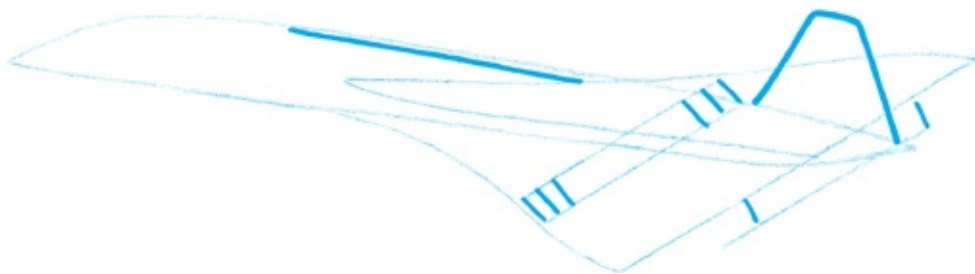
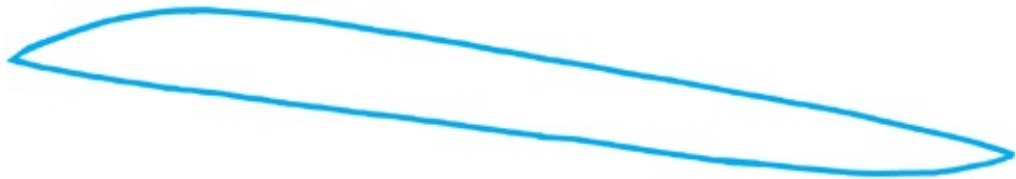

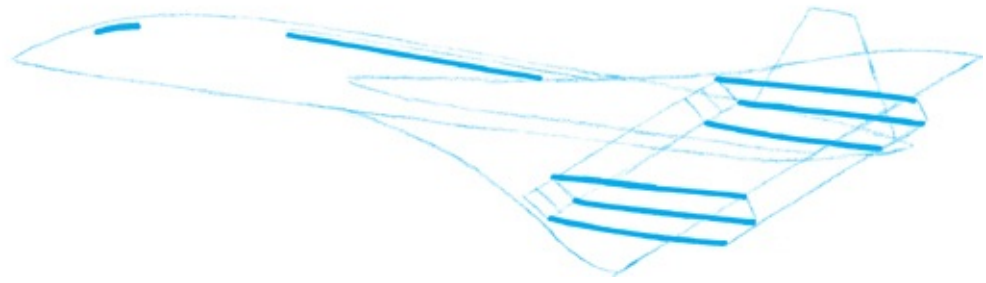

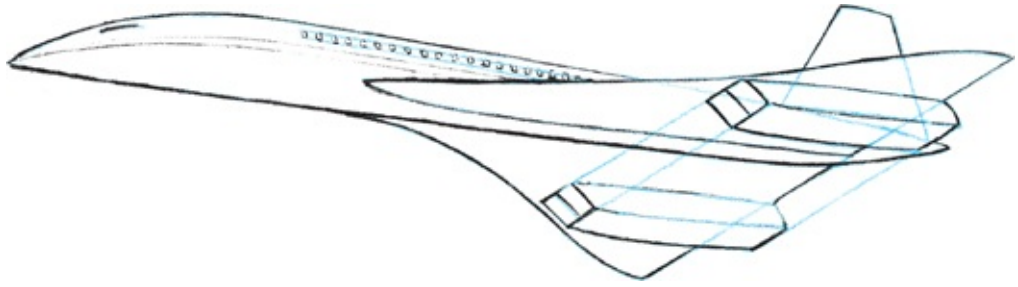



Boeing 747 (USA)

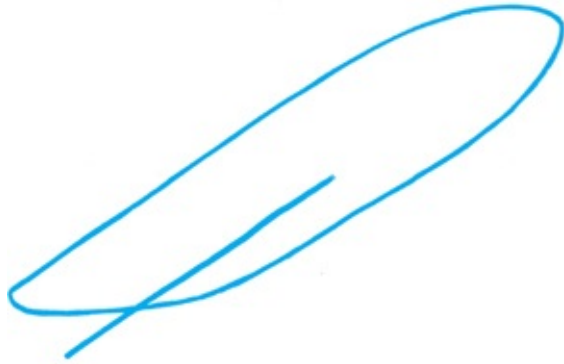



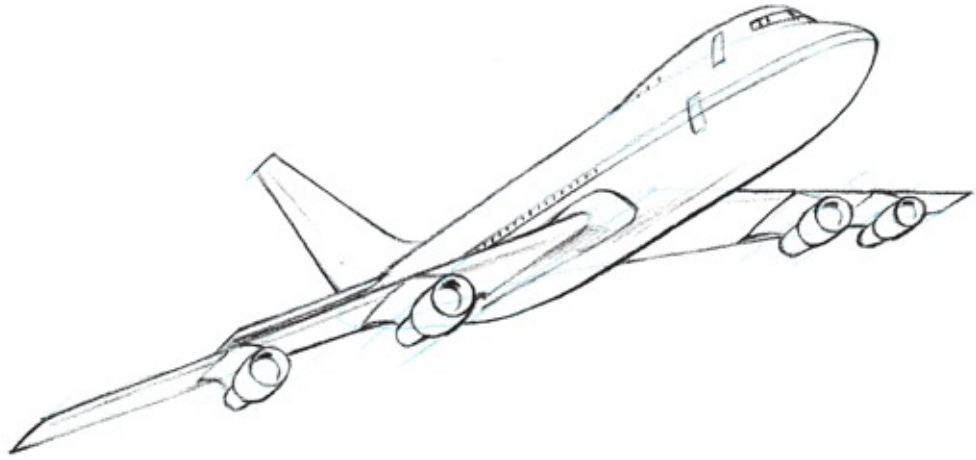



Boeing 727 (USA)

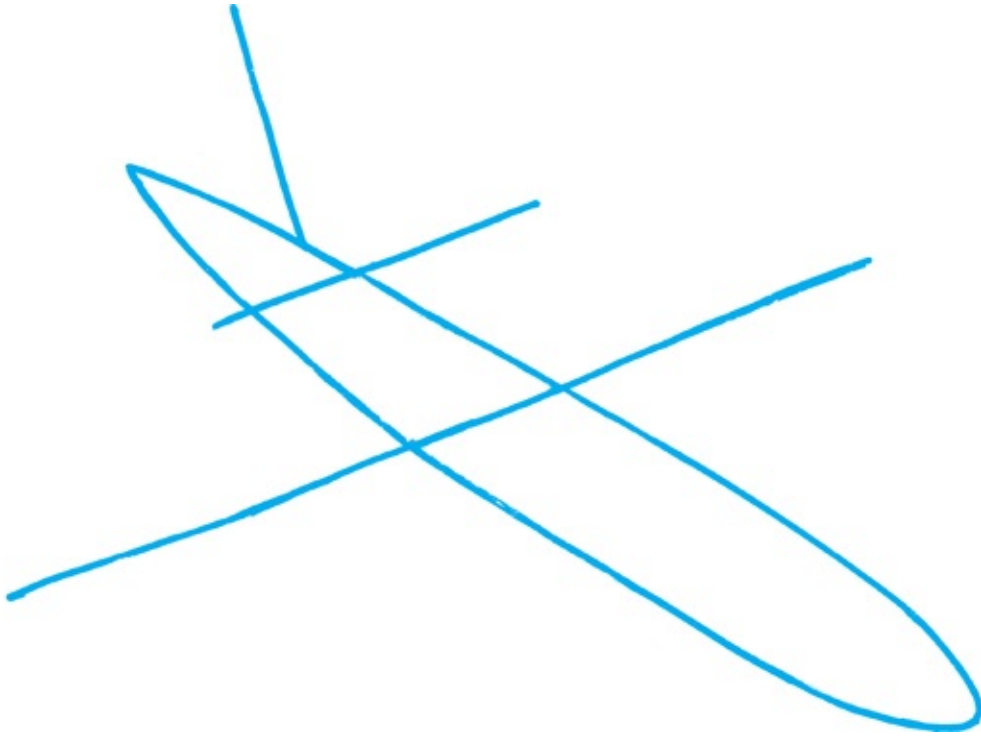

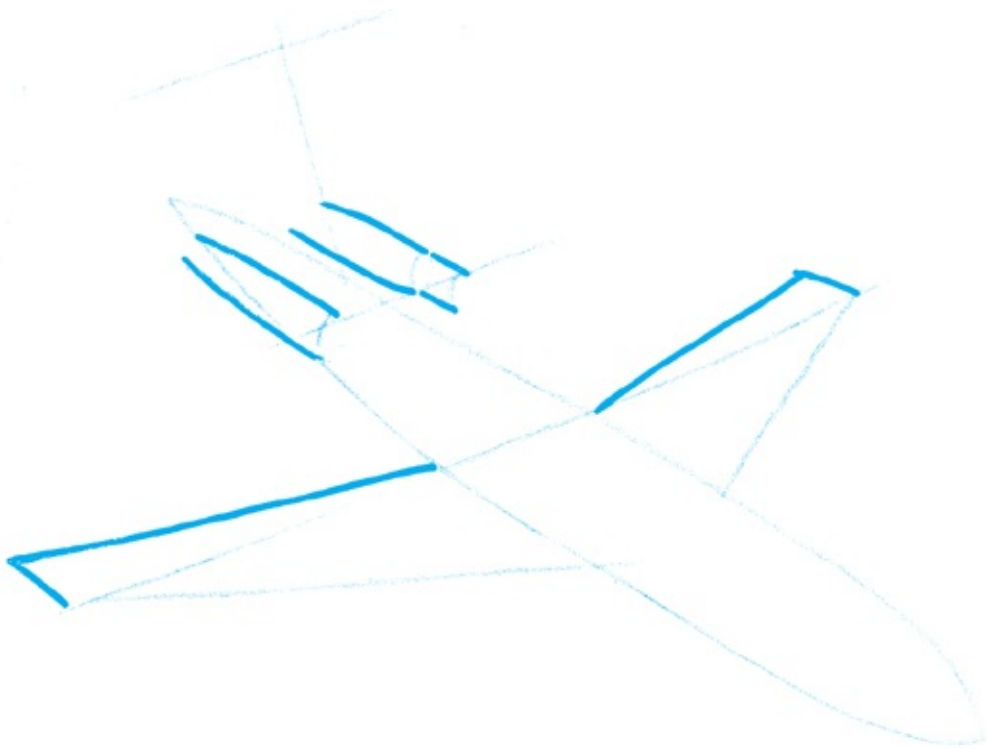
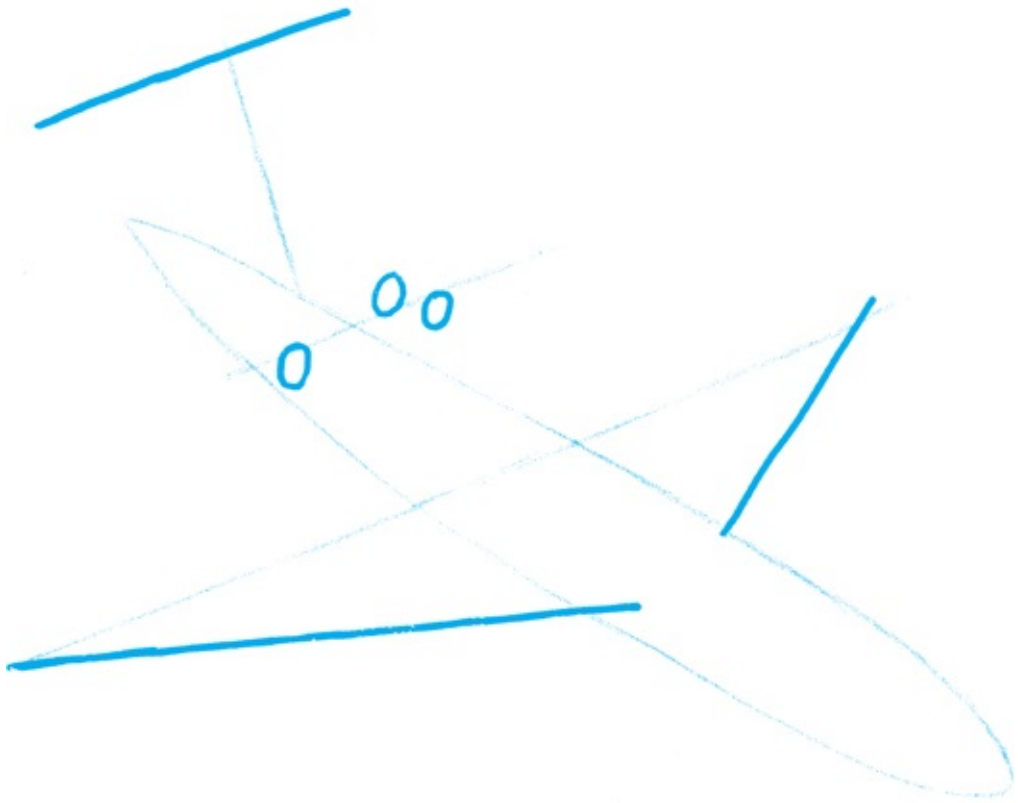

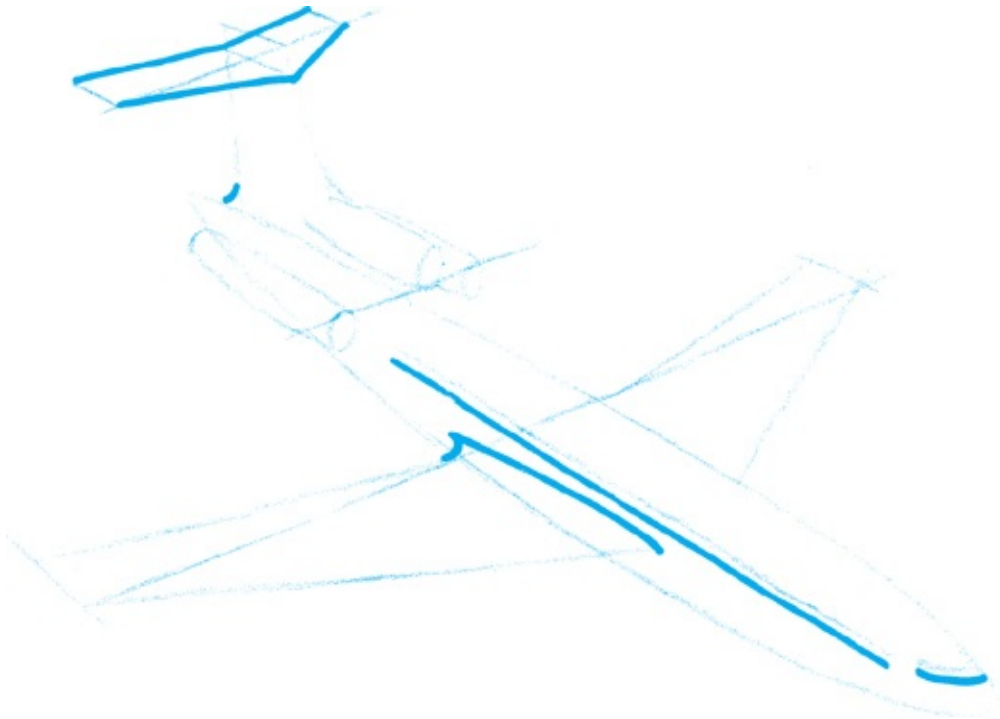
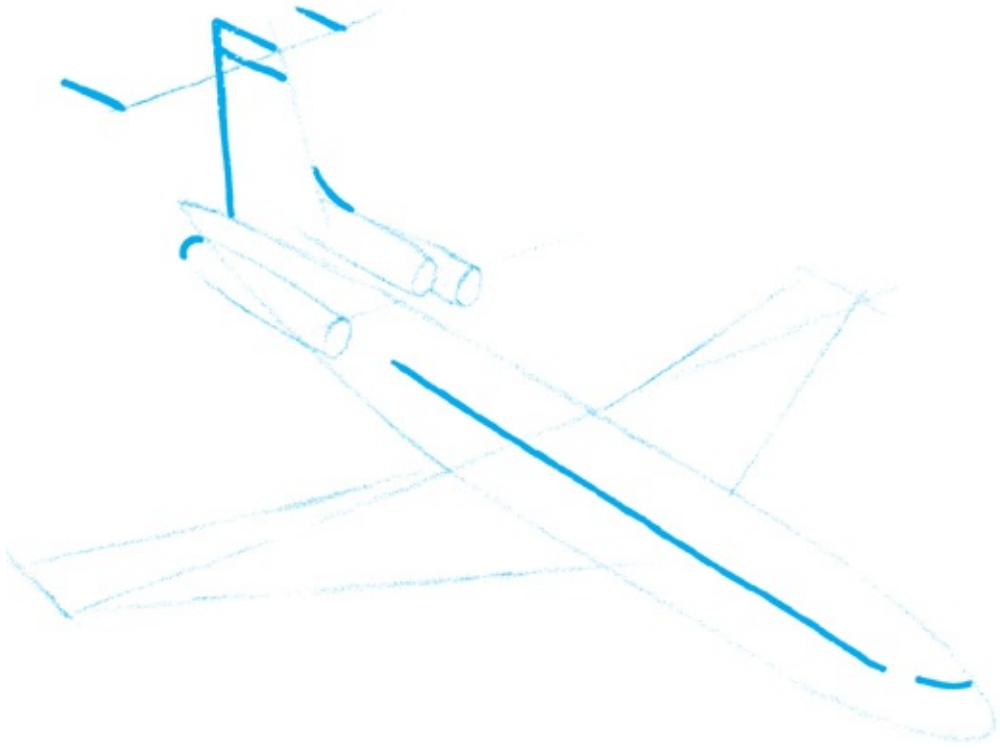

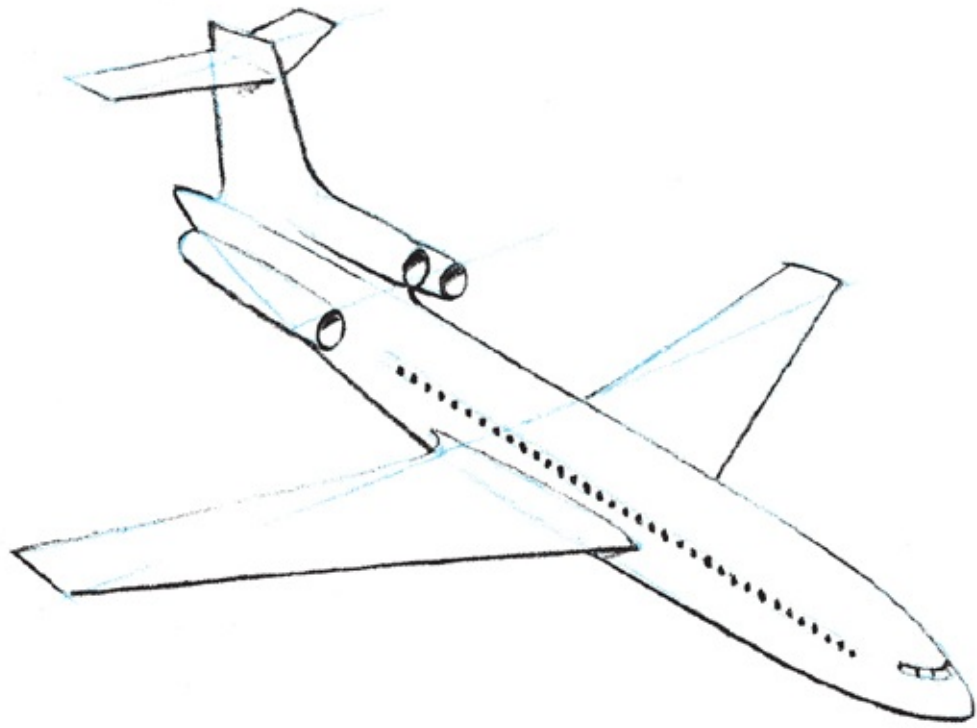



Boeing 707 (USA)

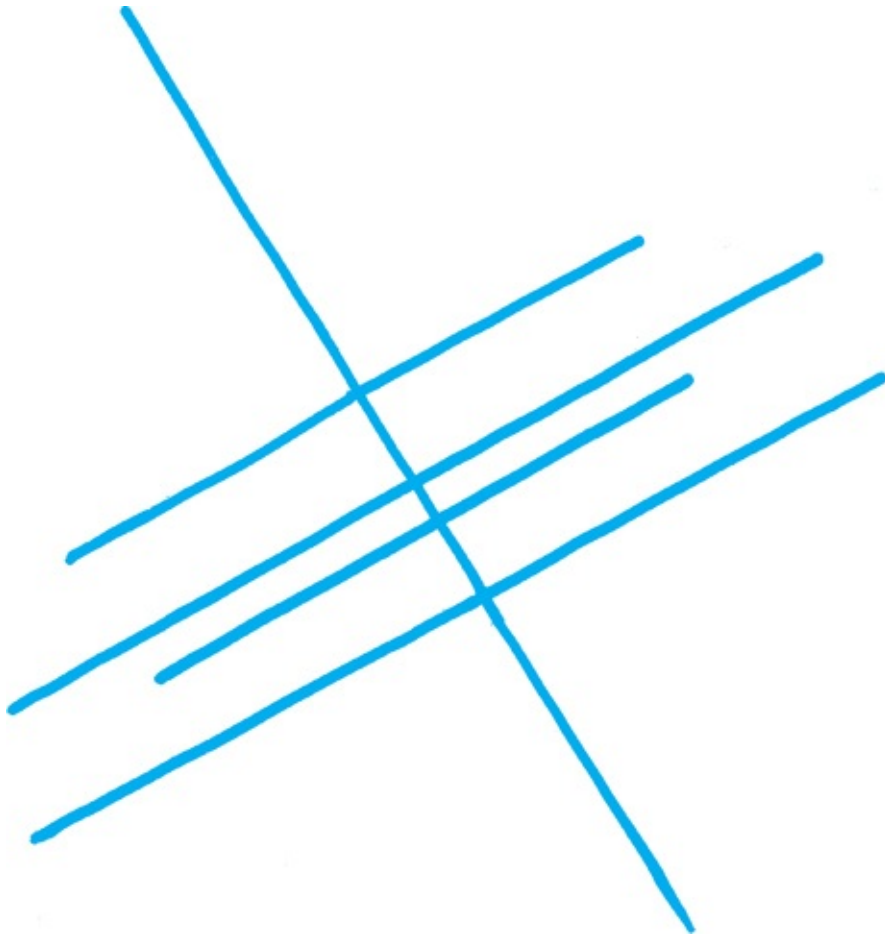

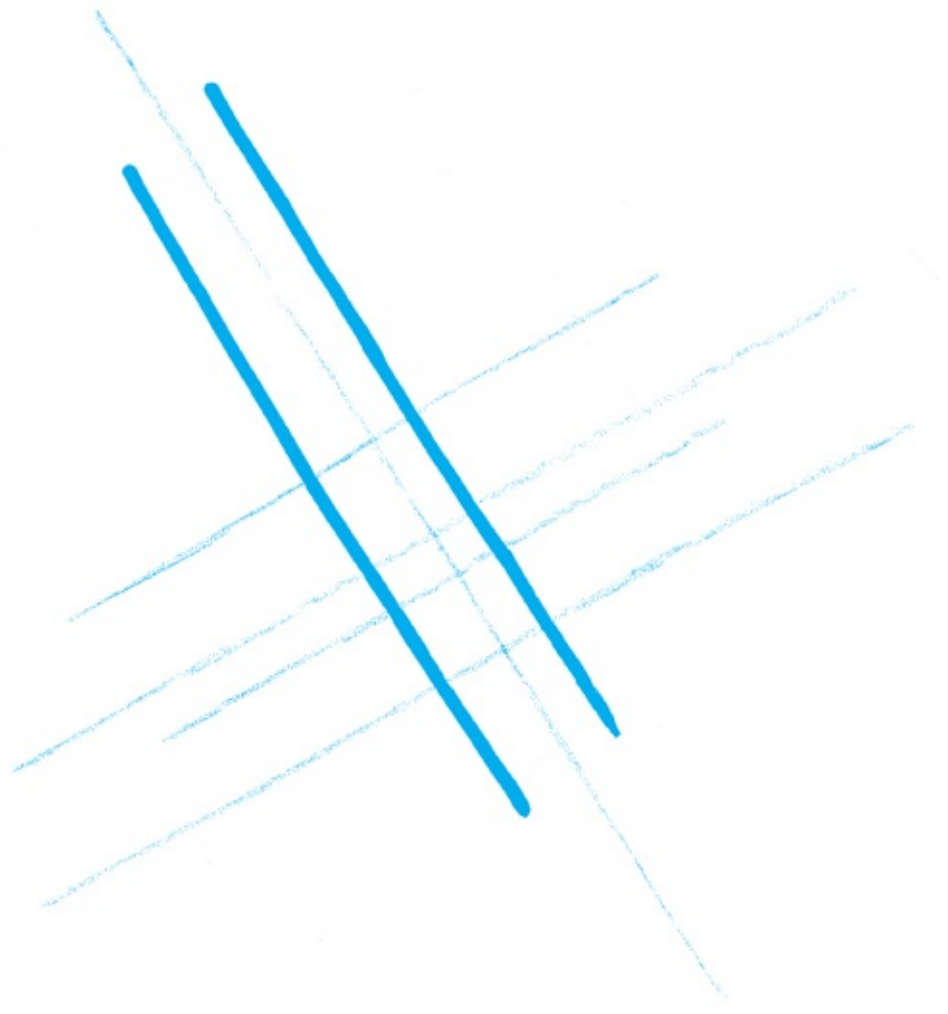

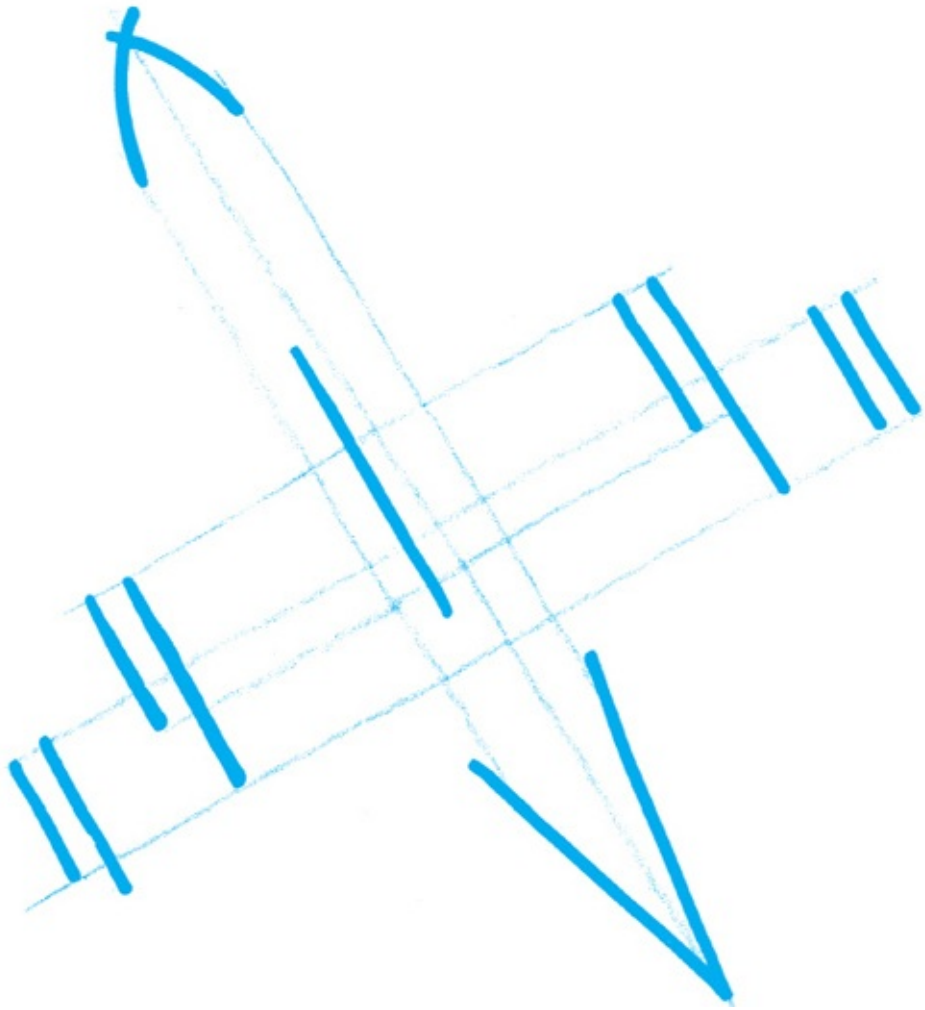

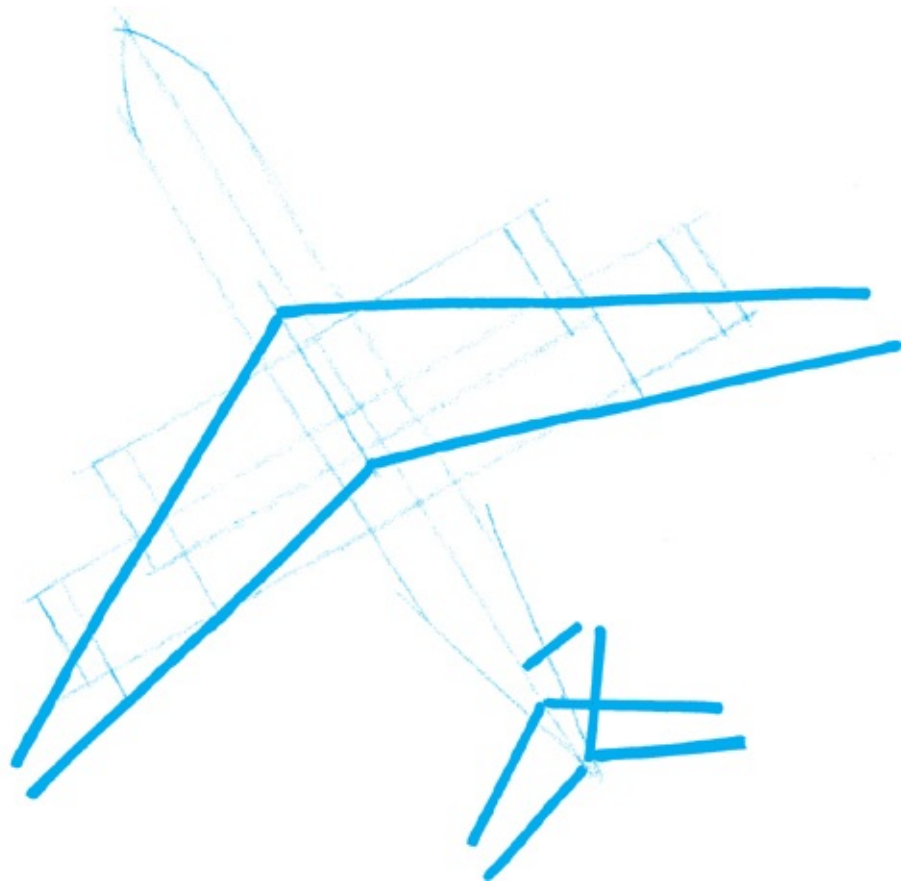

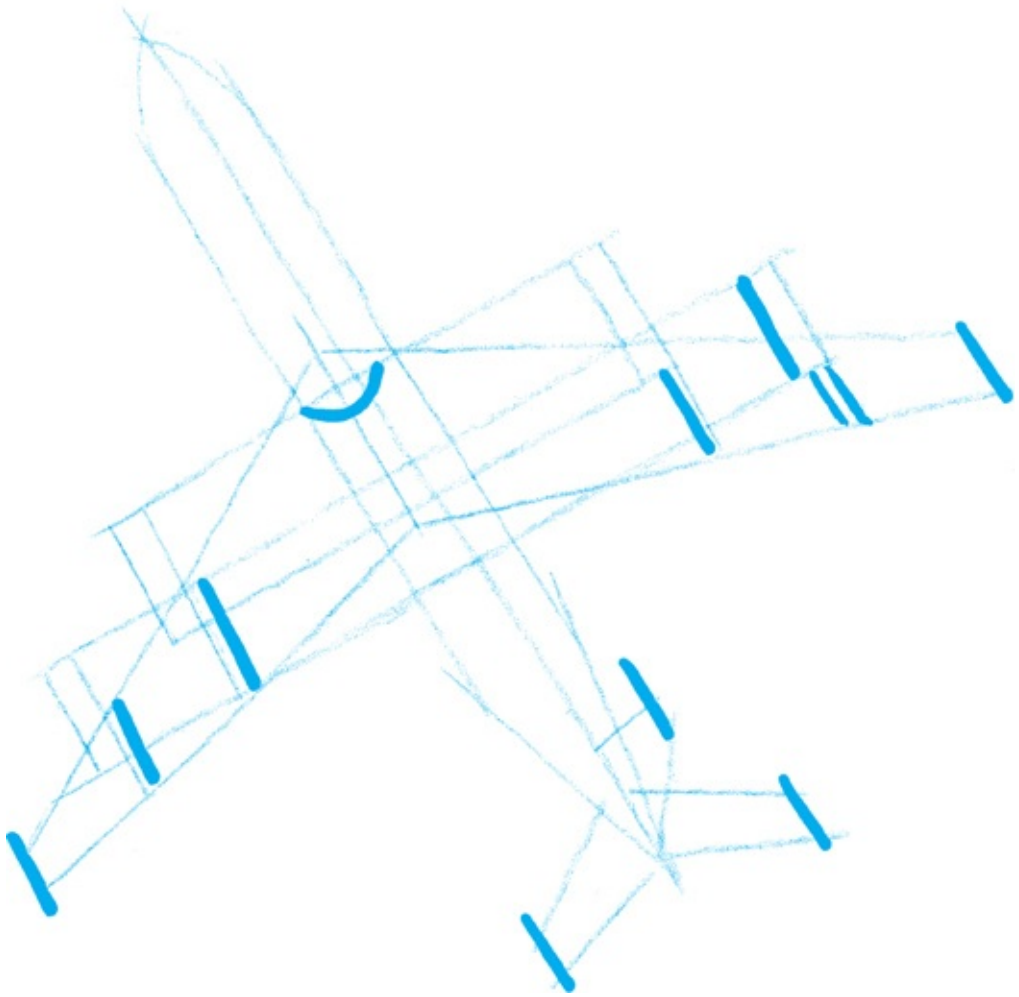

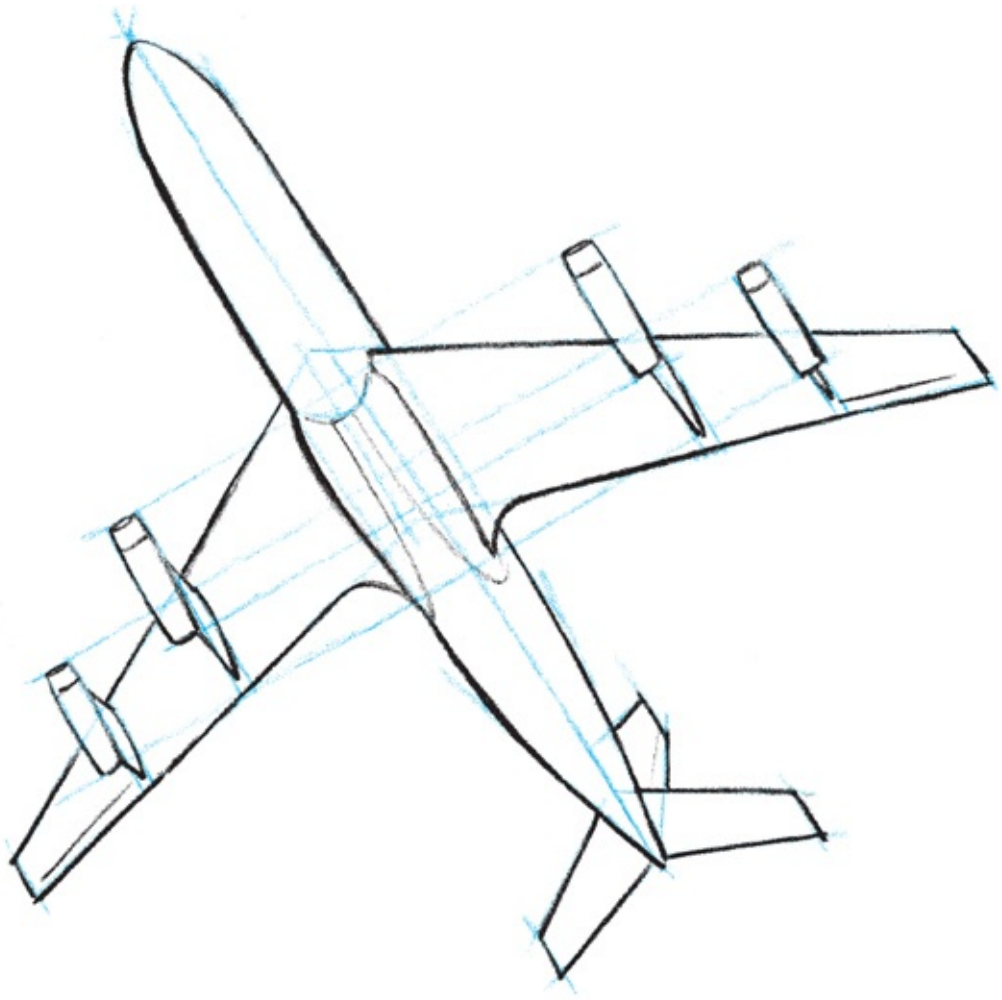



Lochheed Constellation (USA)

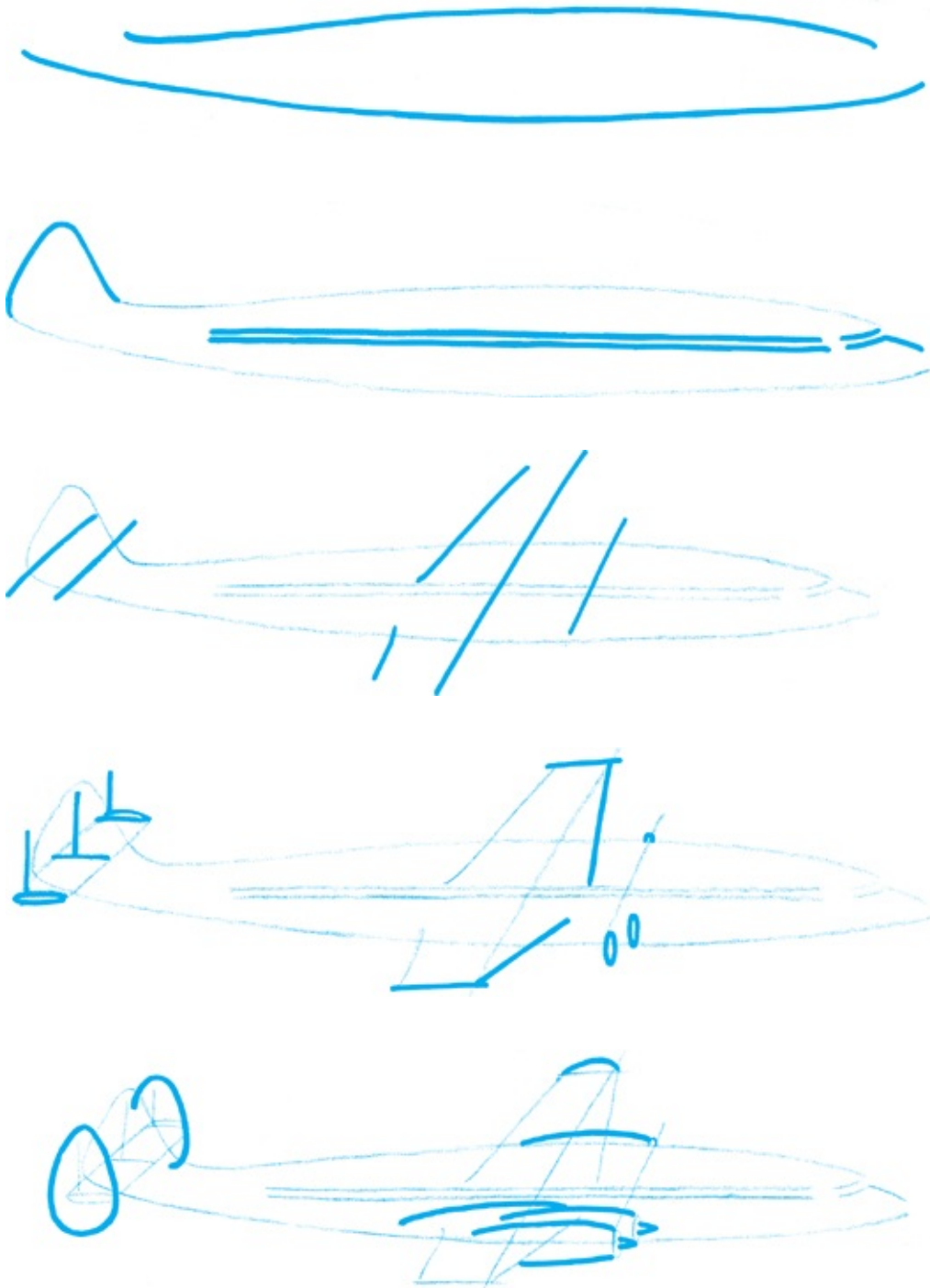

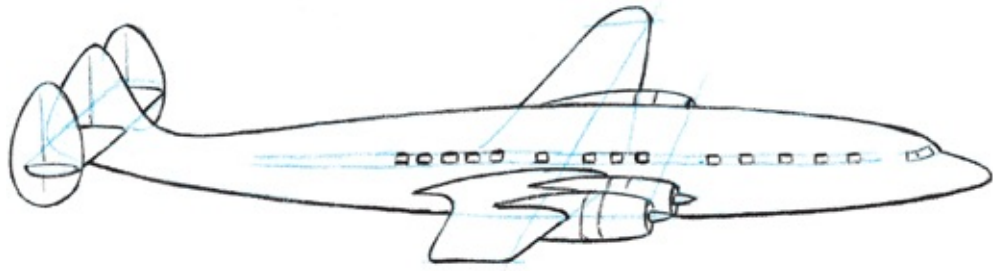



B-52 bomber (USA)

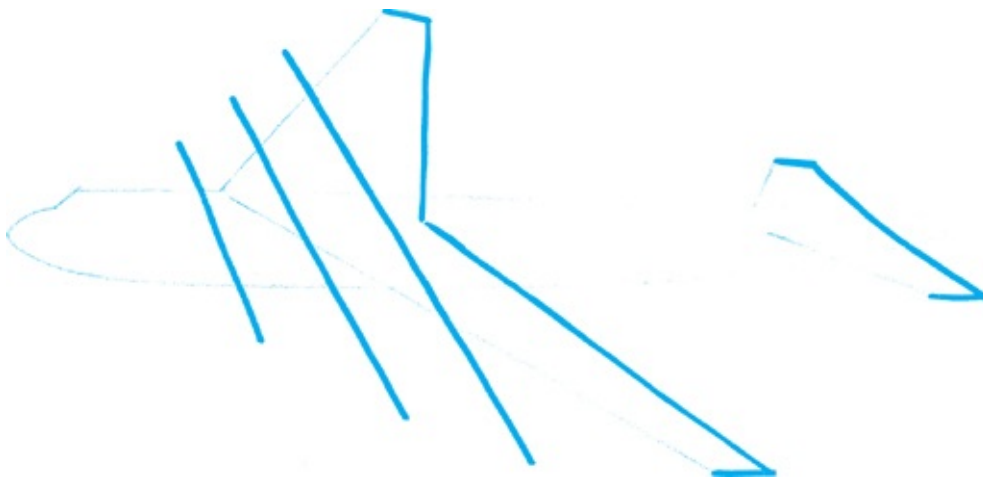
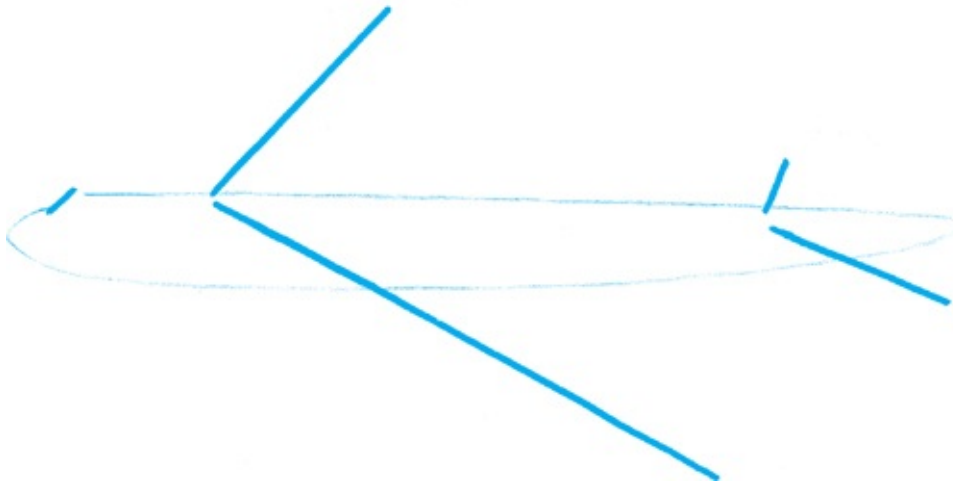

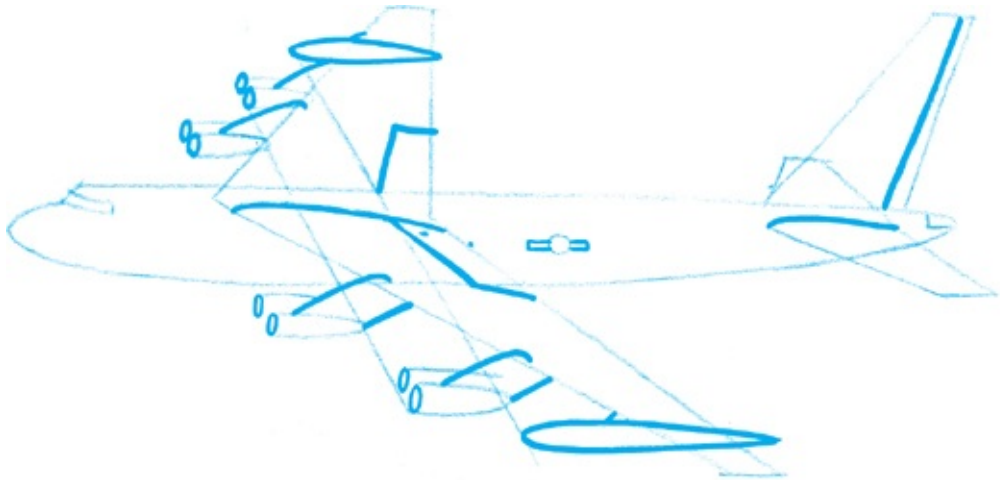
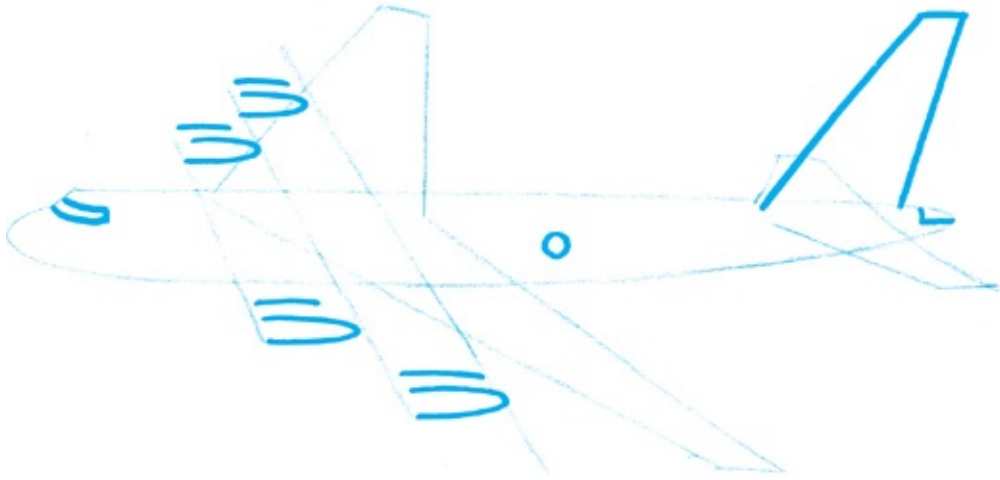

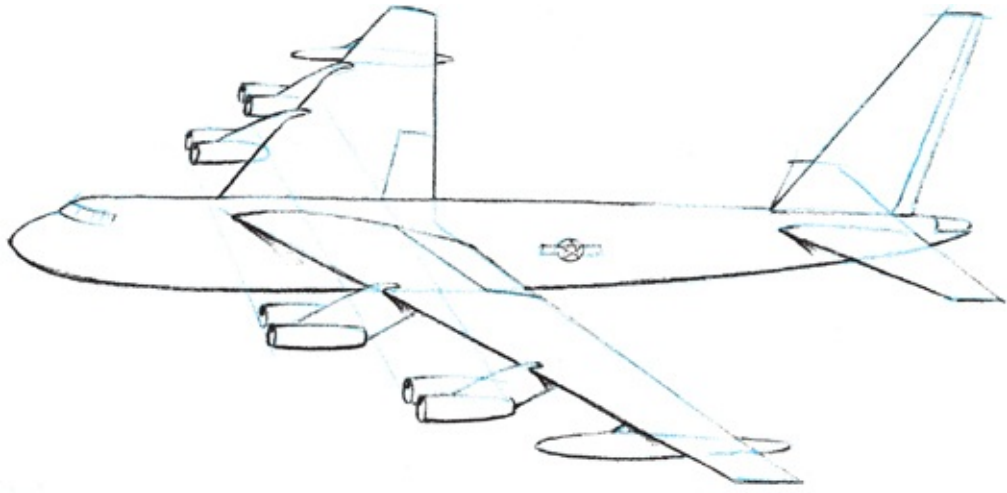



B-17 Flying Fortress (USA)

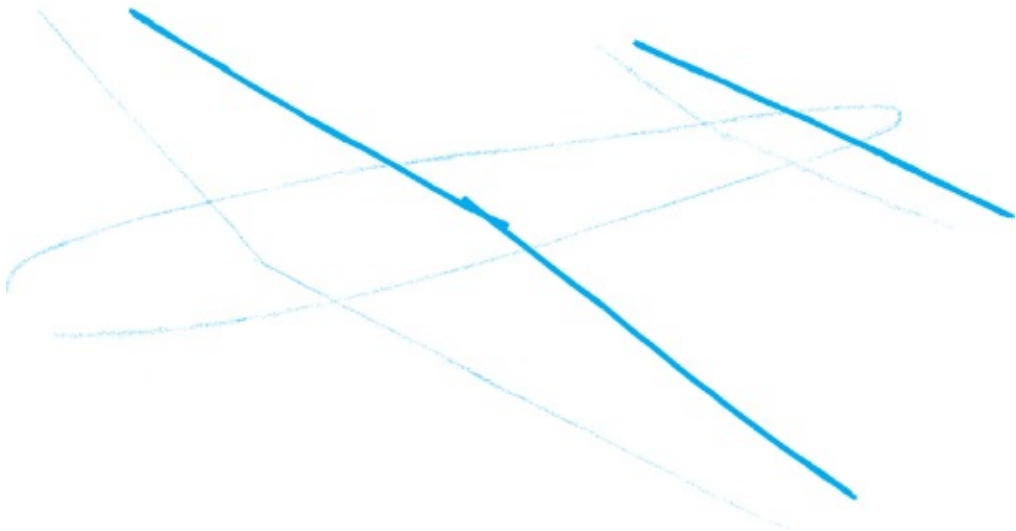
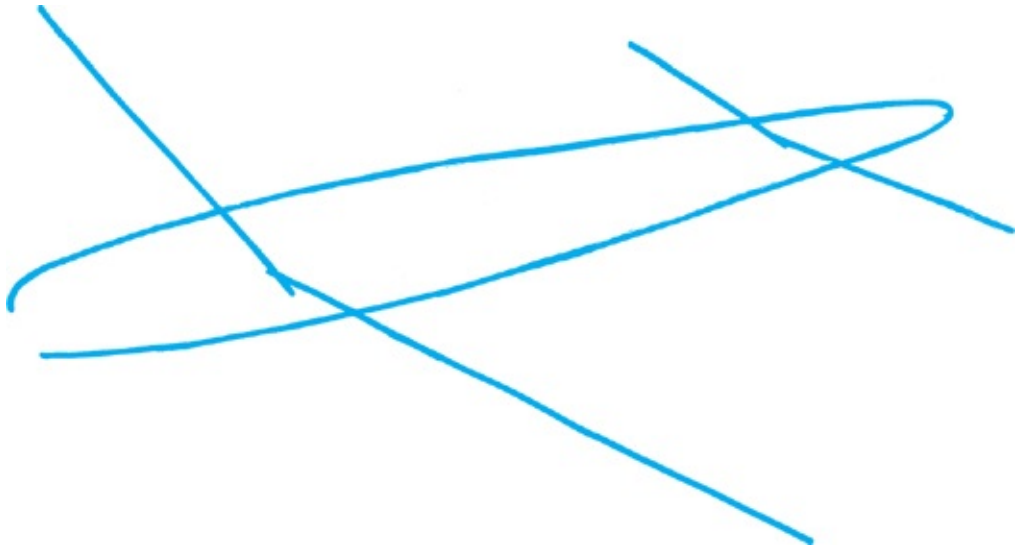

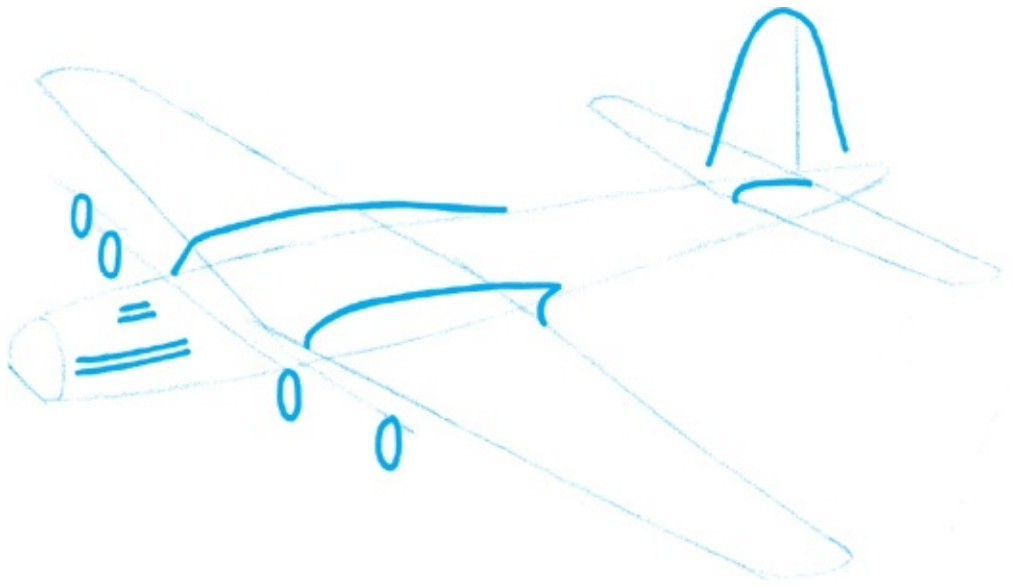
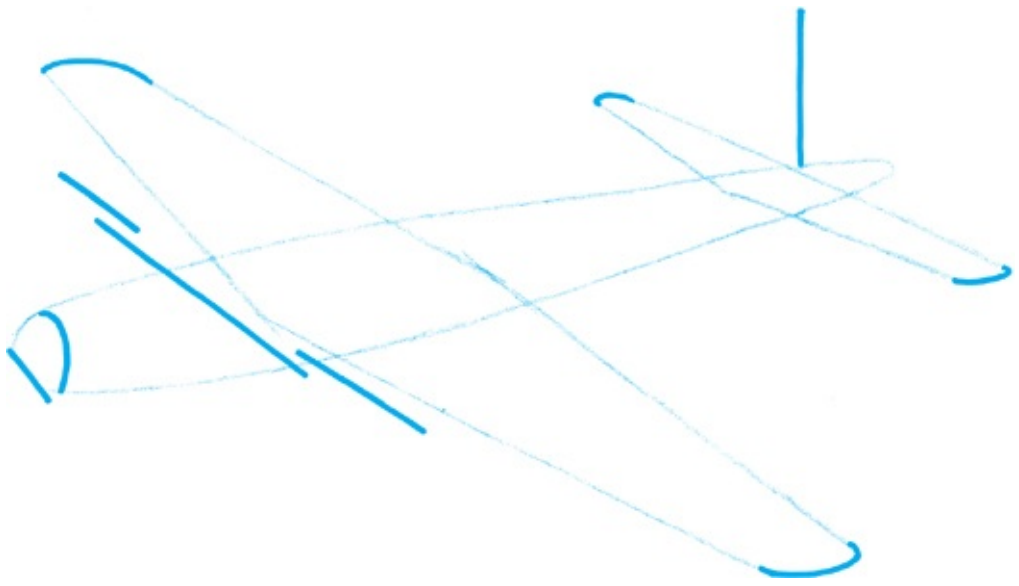



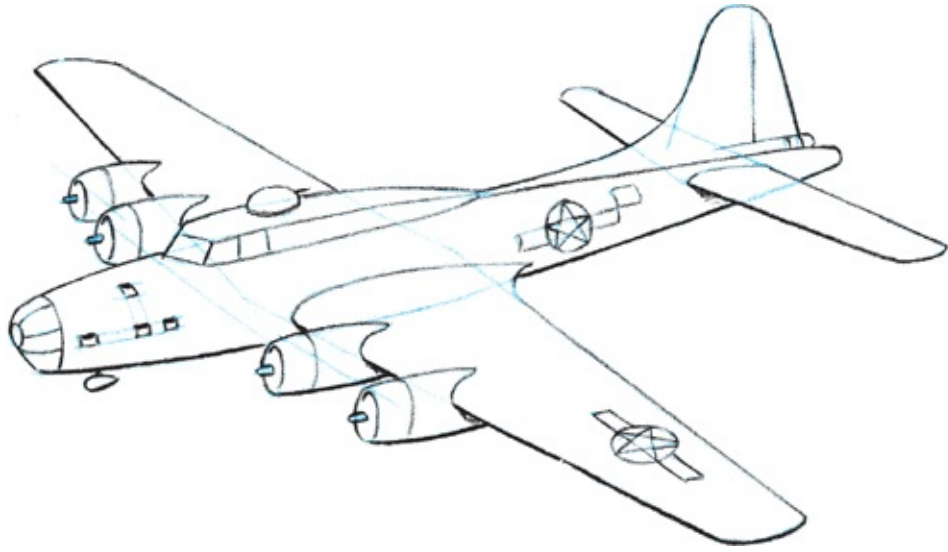



Aero 2 (Yugoslavia)

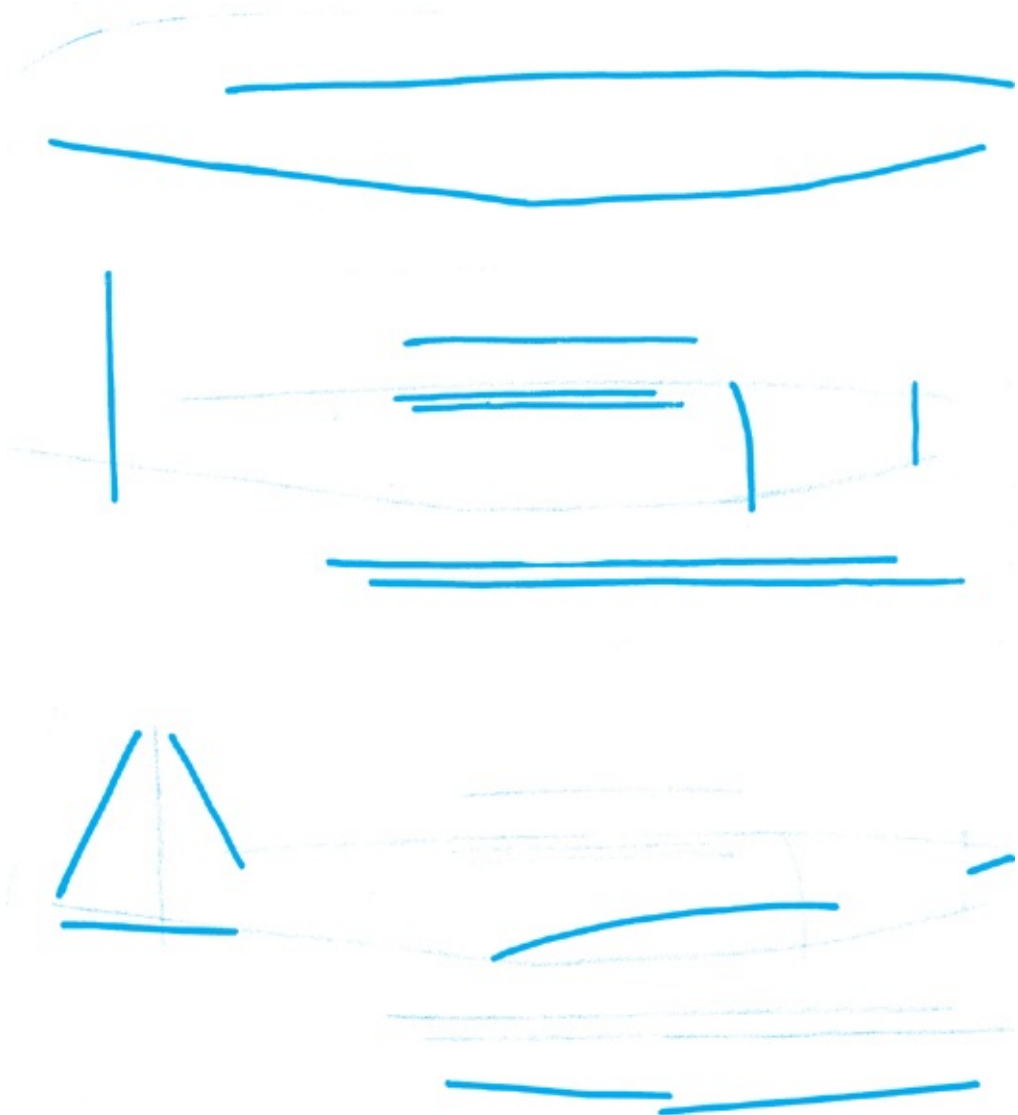

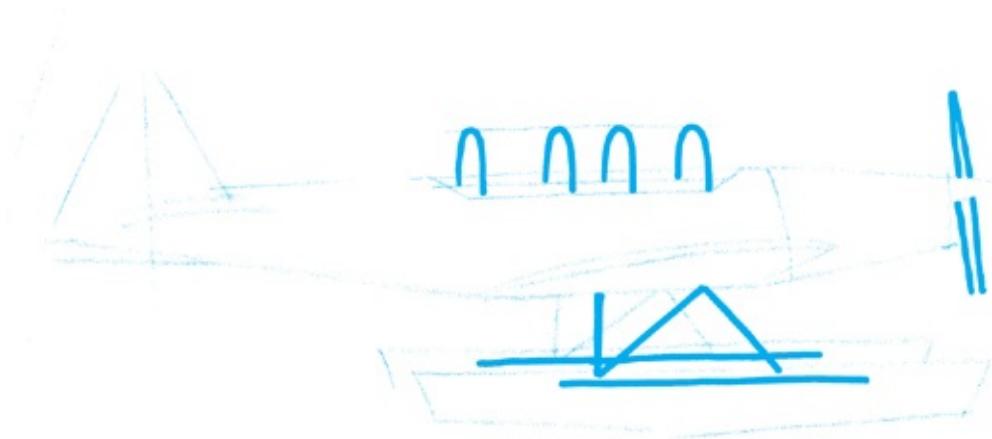

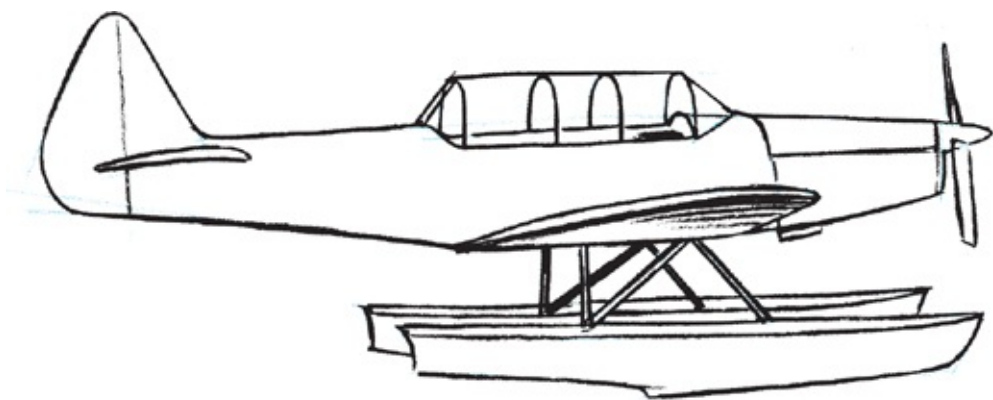



Cessna OE-2 (USA)



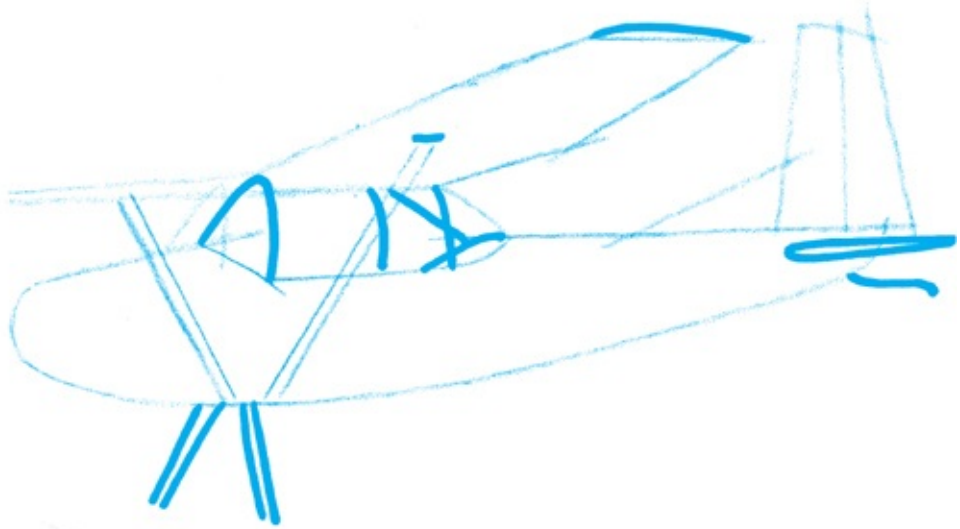
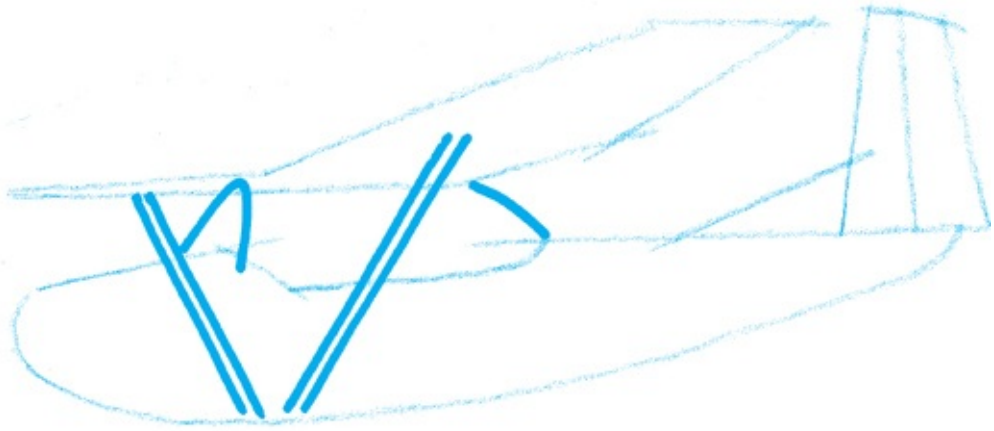
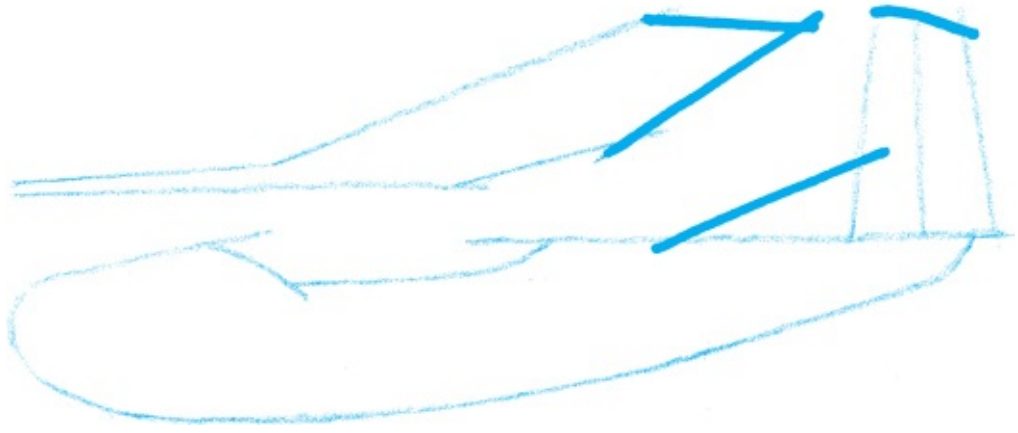

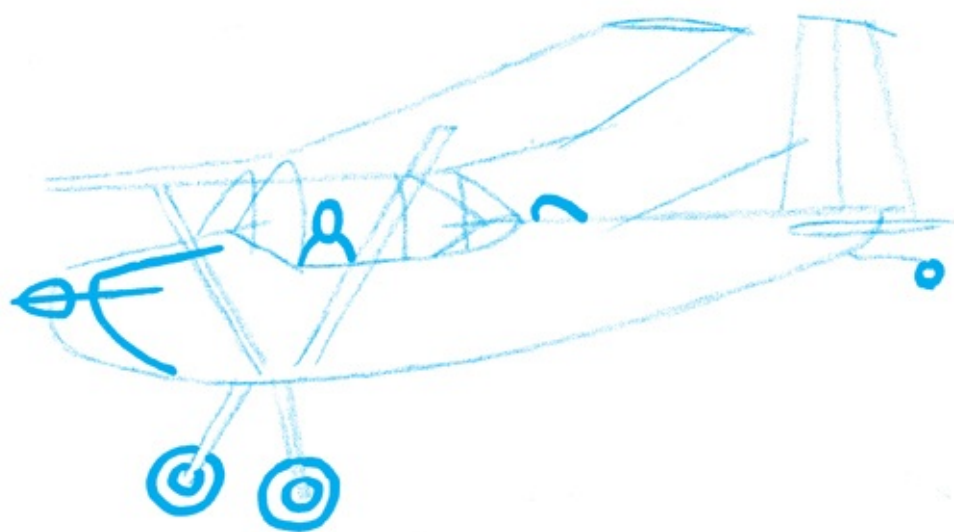

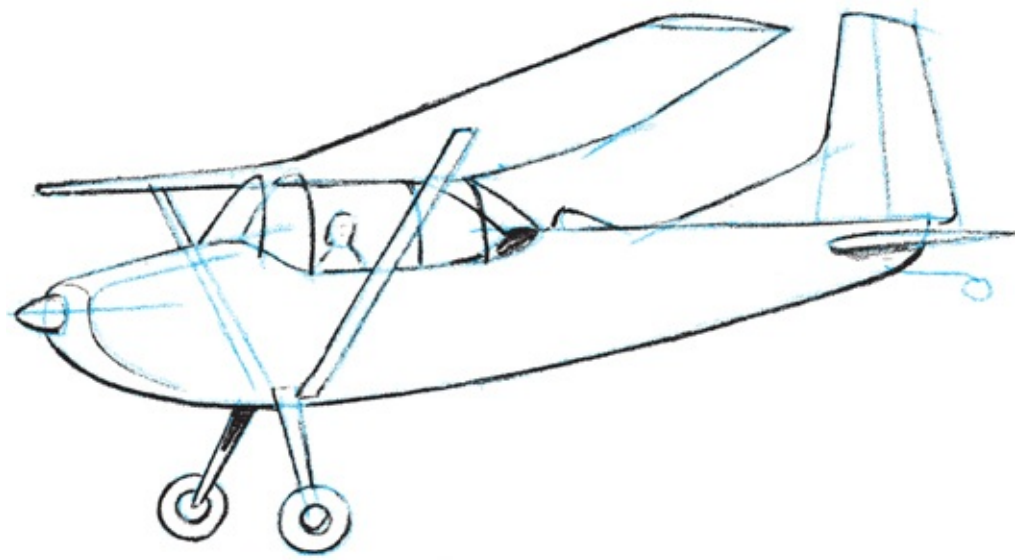



Charles A. Lindbergh's plane—The Spirit of St. Louis (USA)



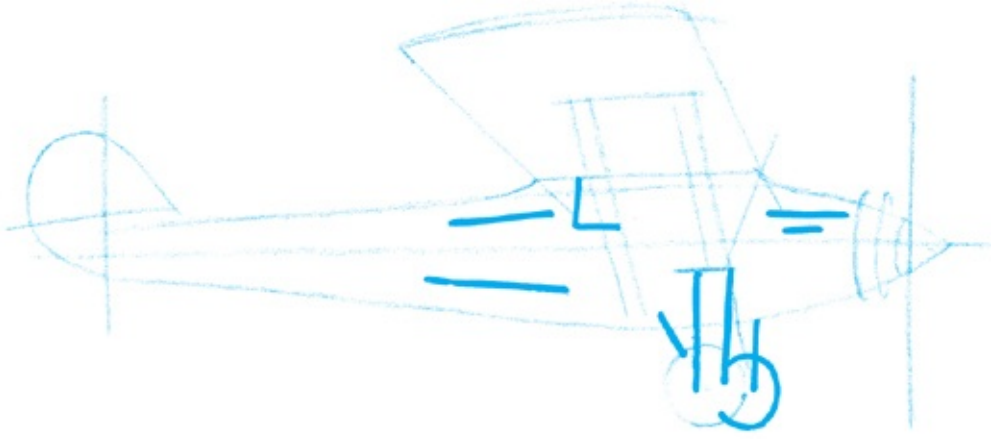
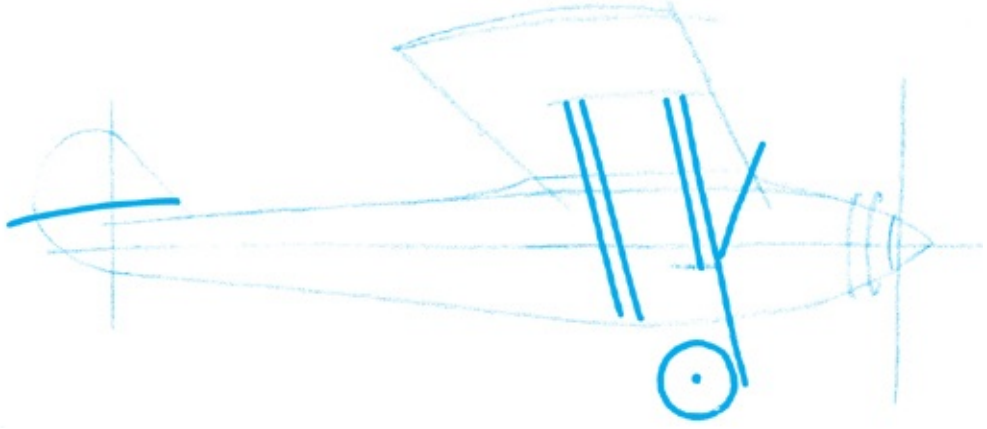

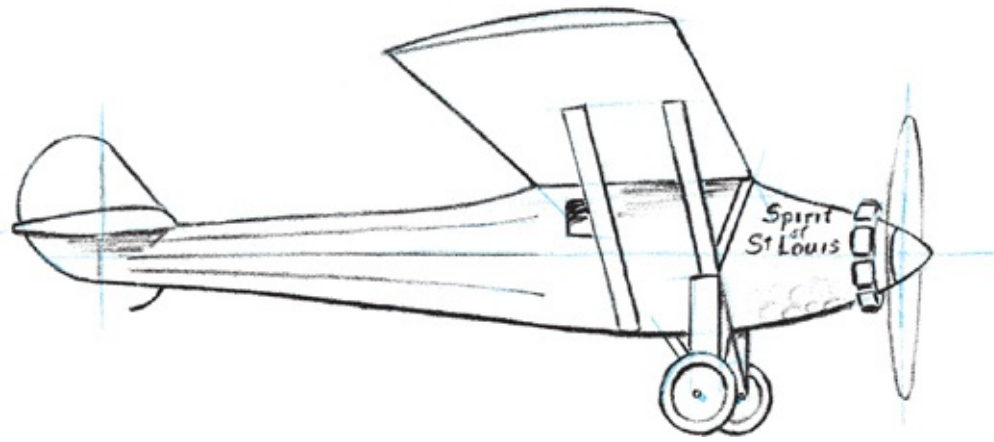

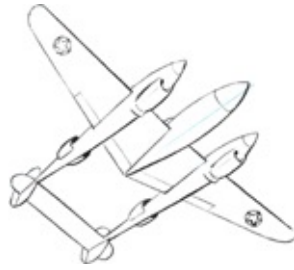

P-38 (USA)



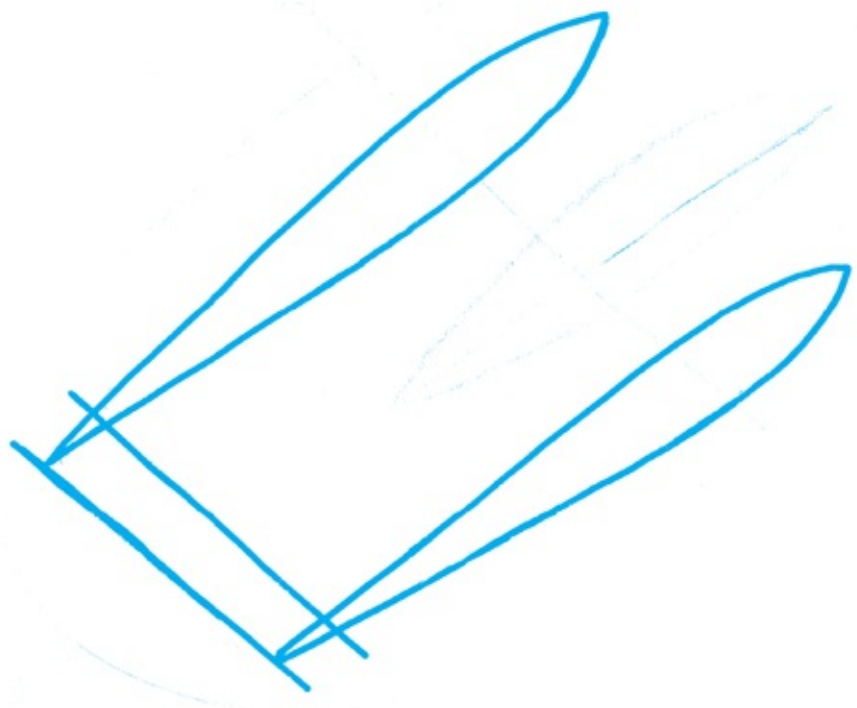
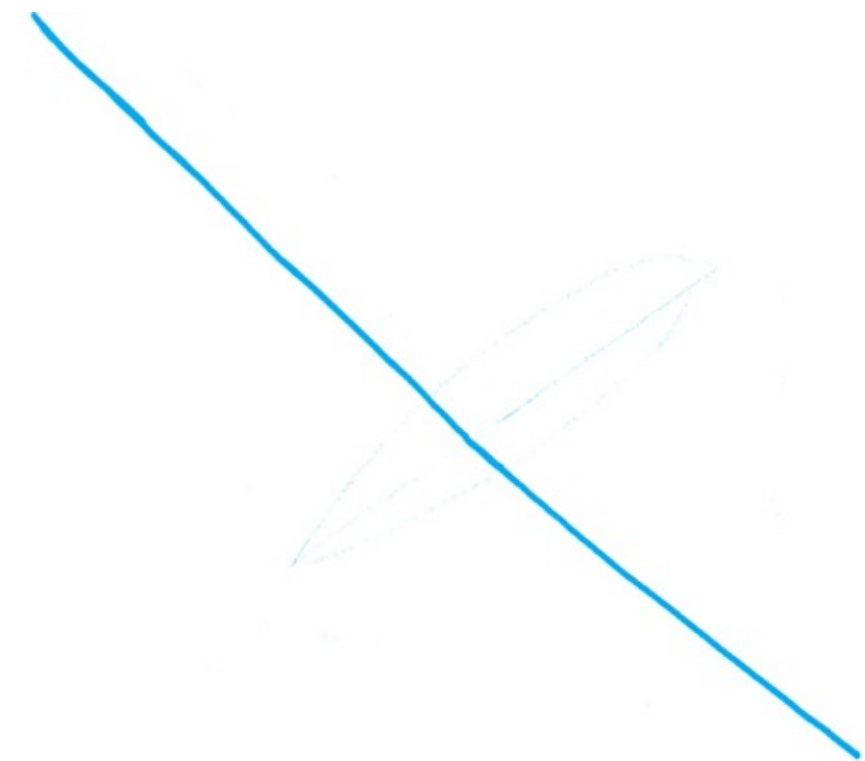





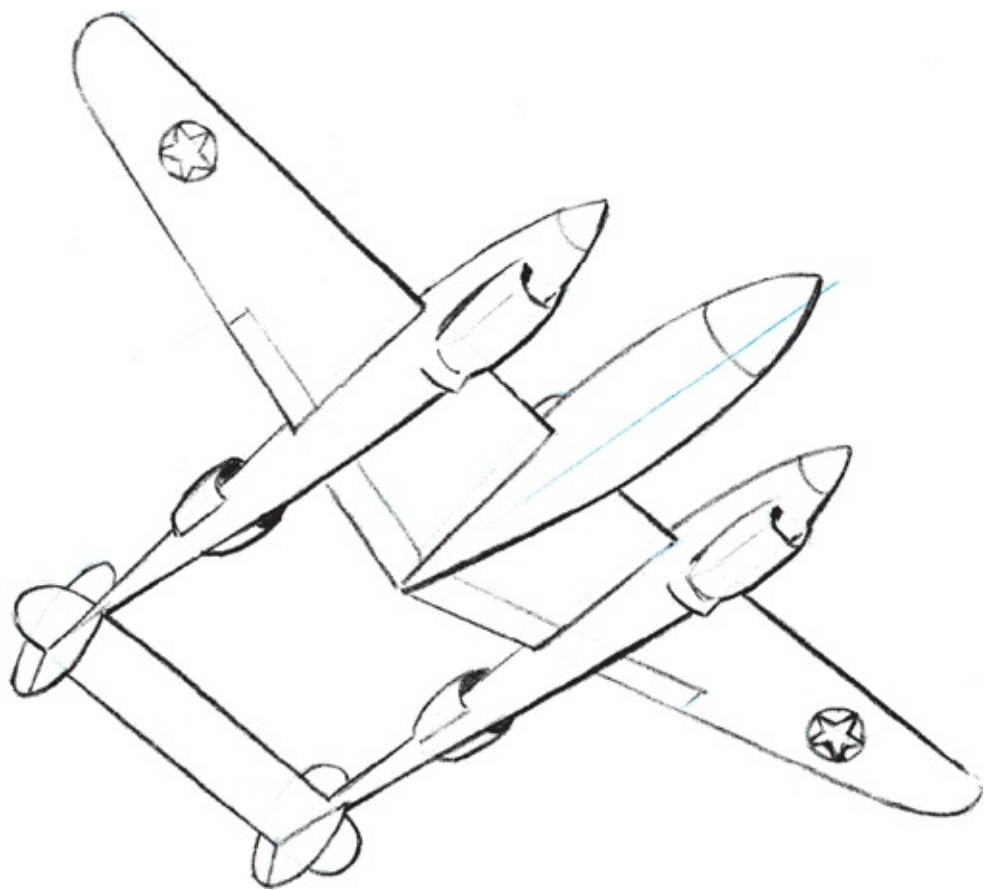



P-40 (USA)



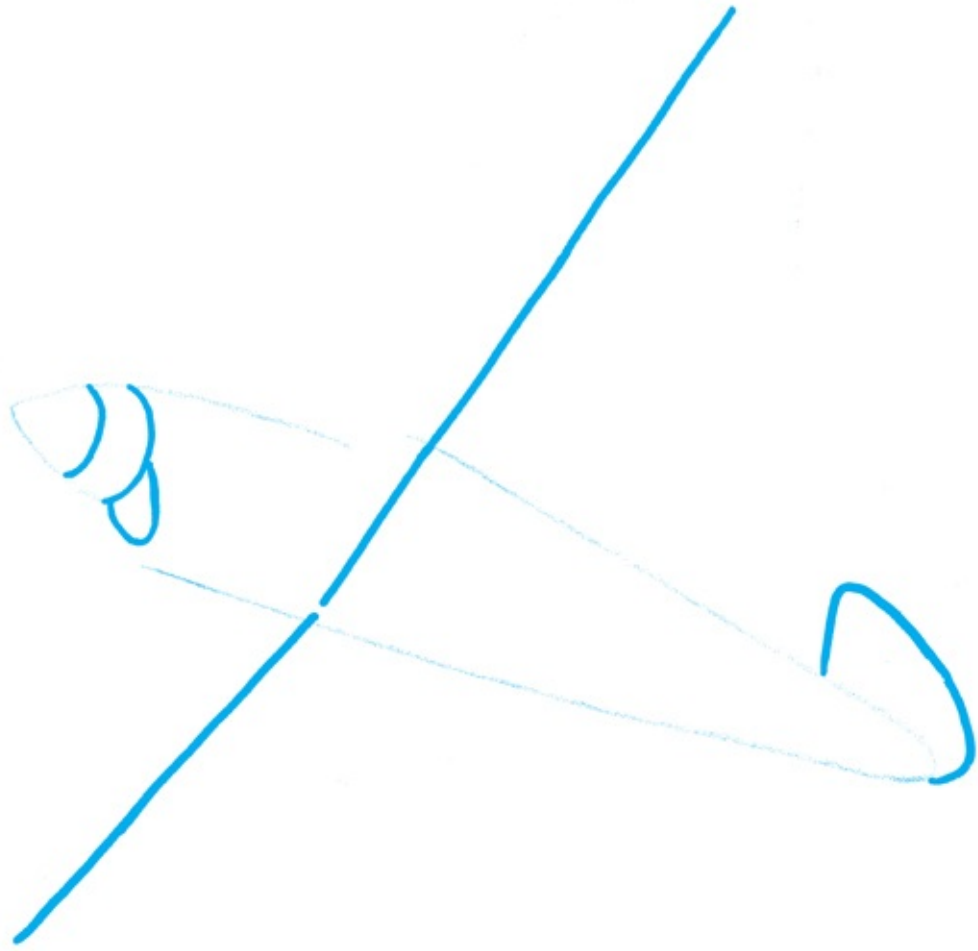



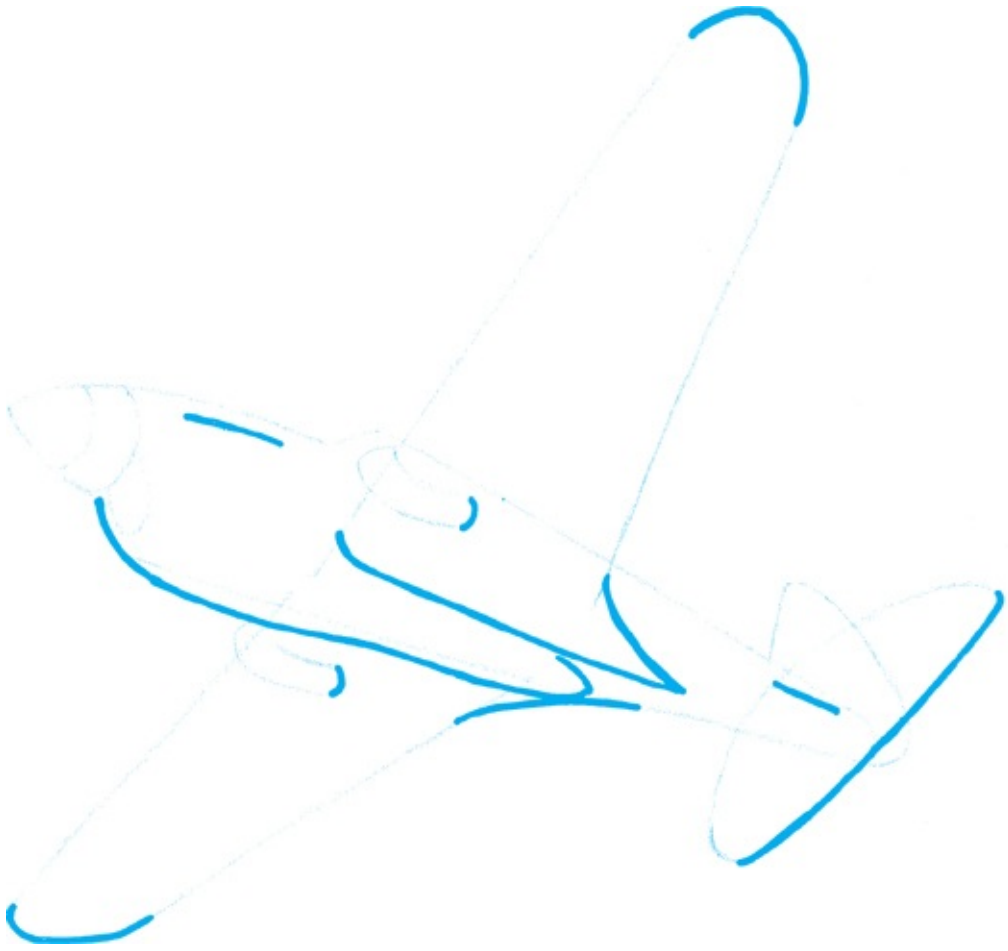

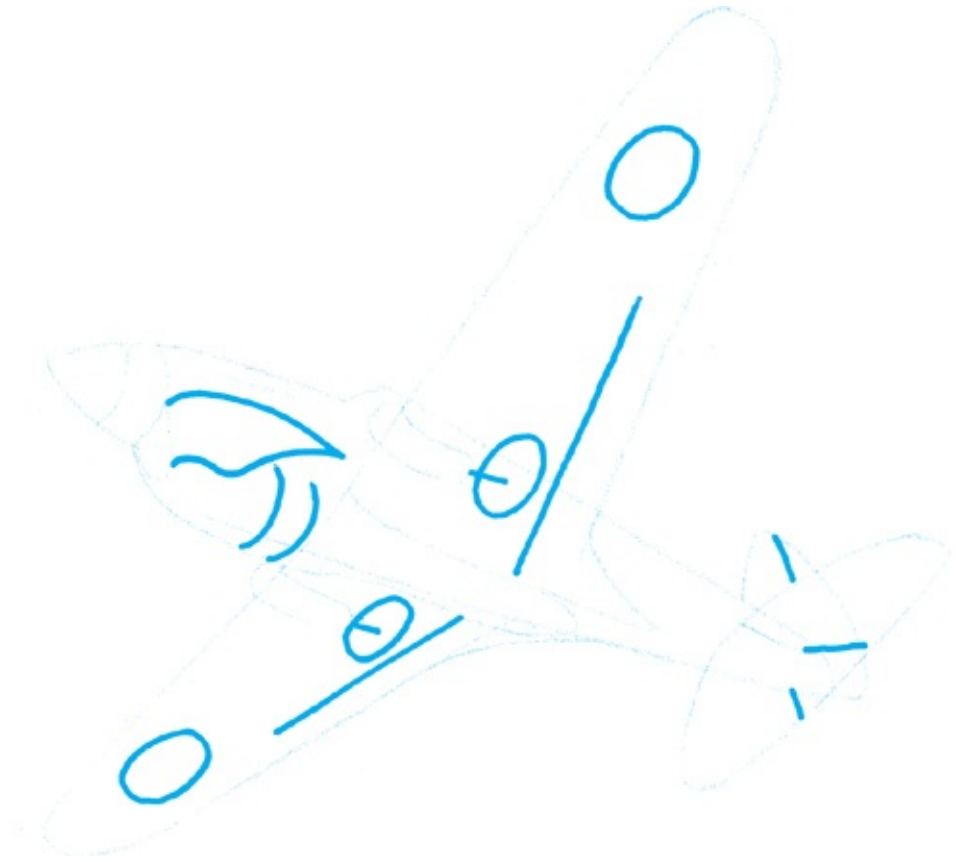

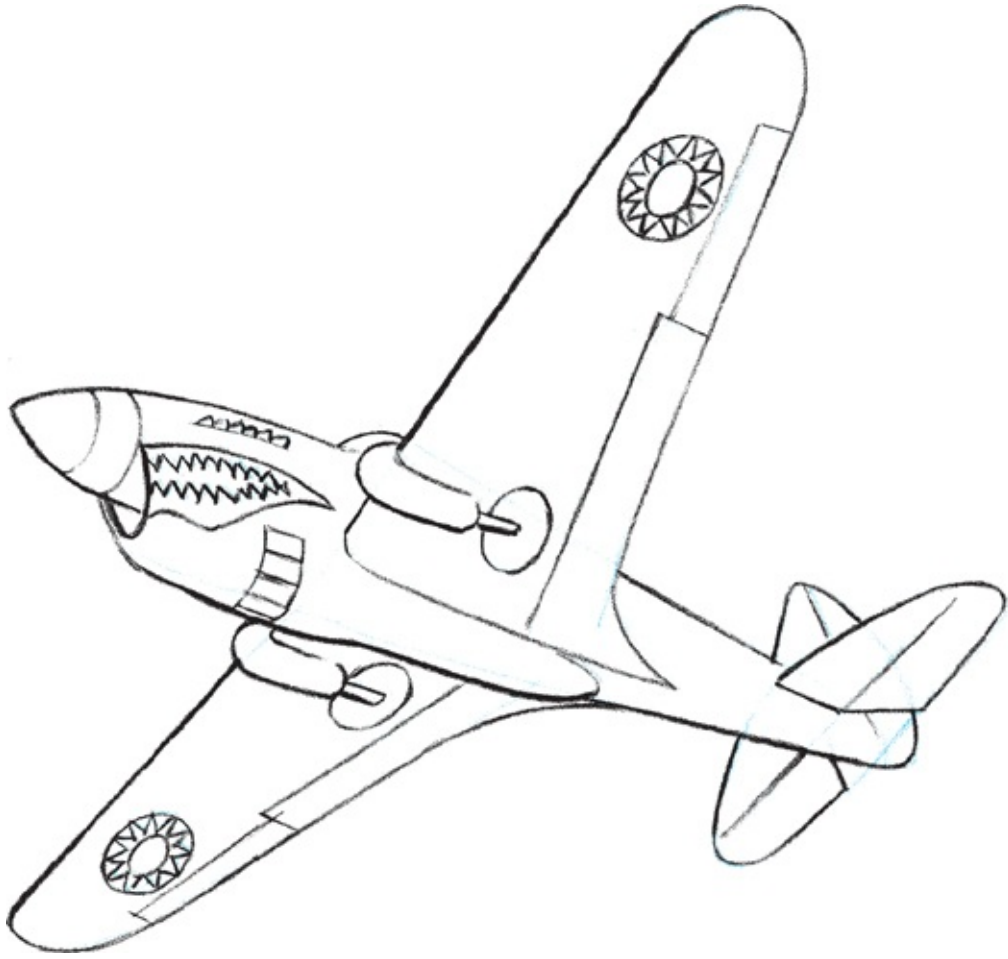



Spitfire (Britain)

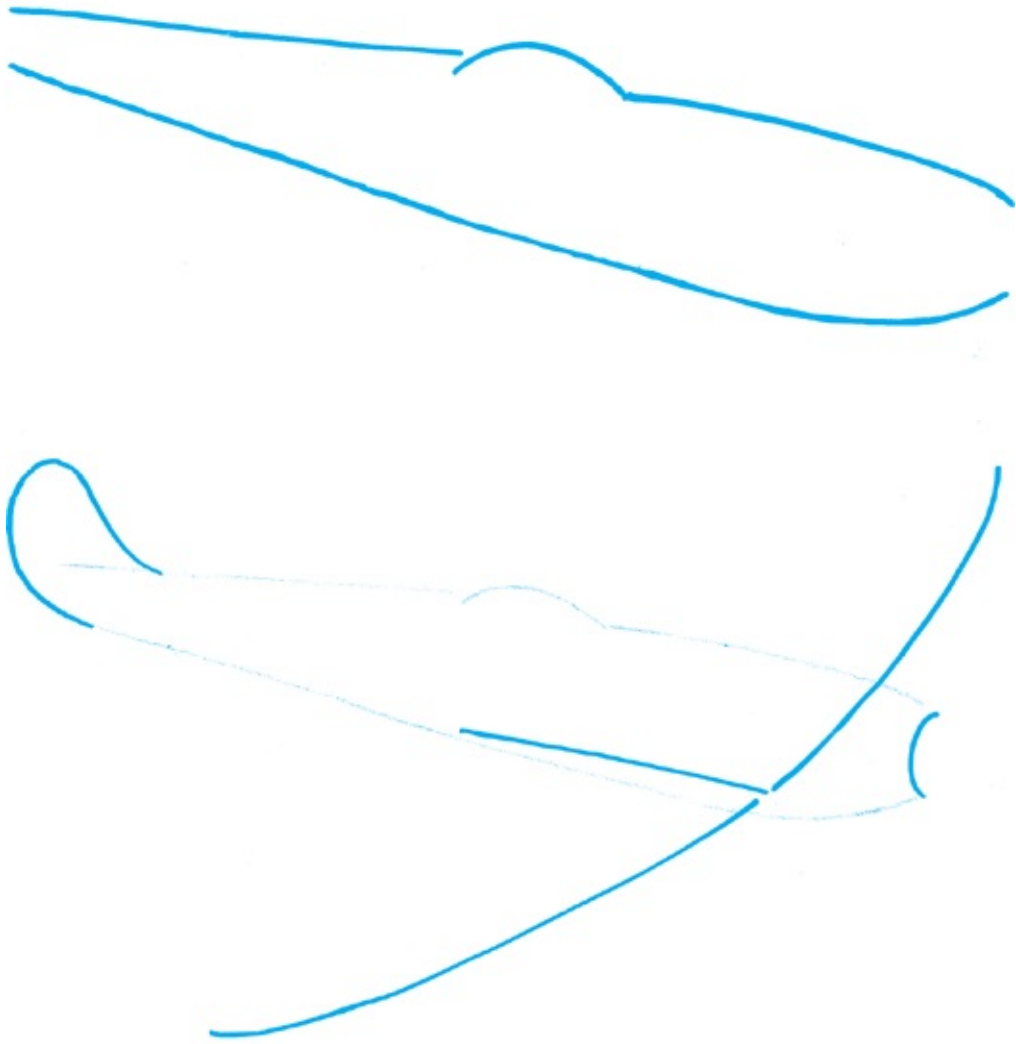





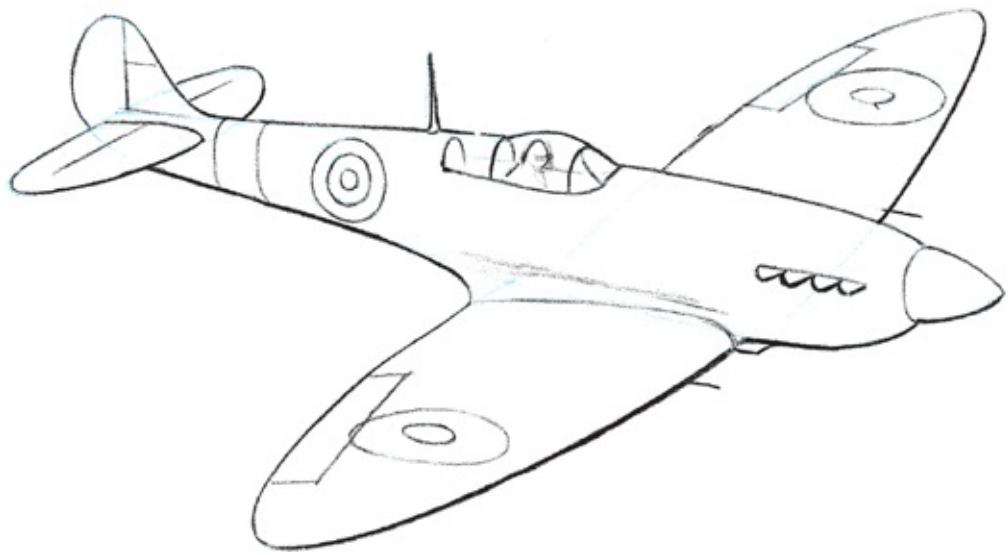



Zero (Japan)

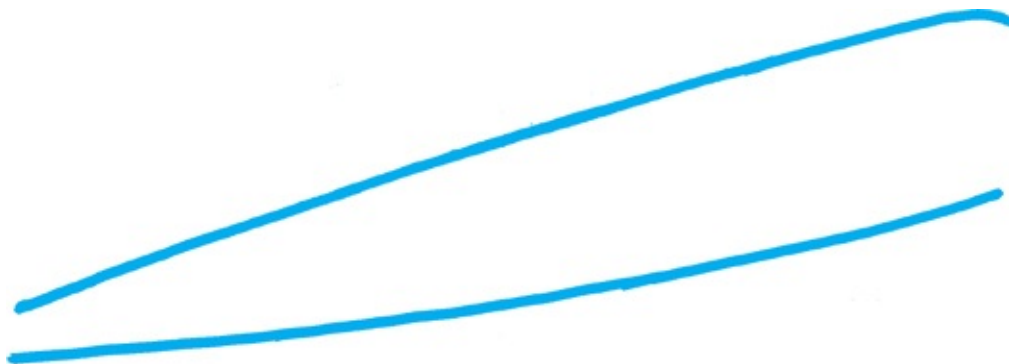

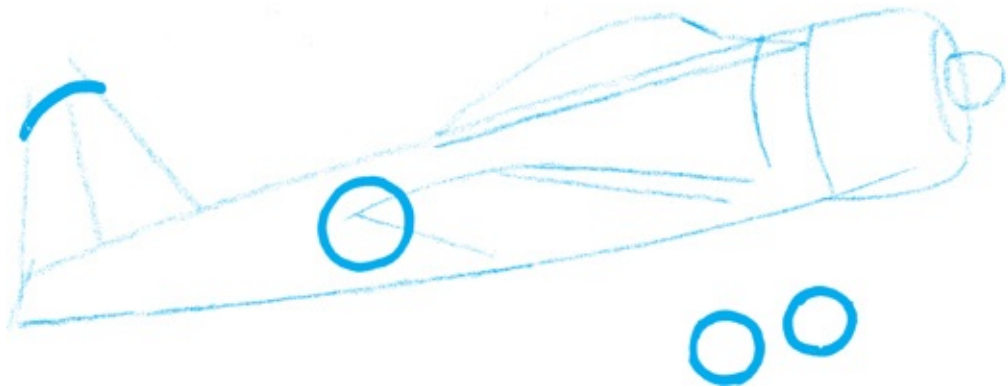
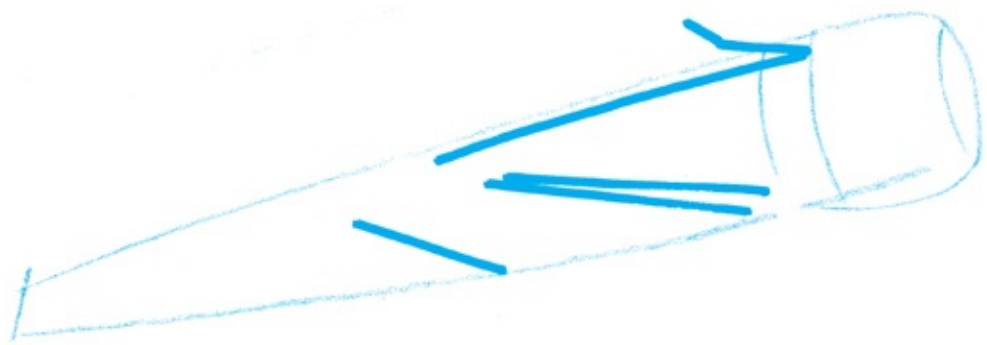

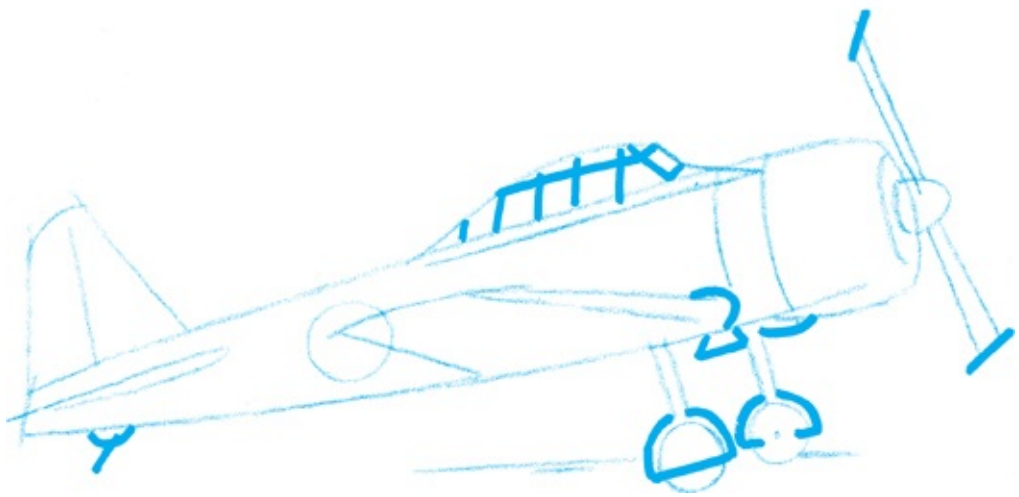
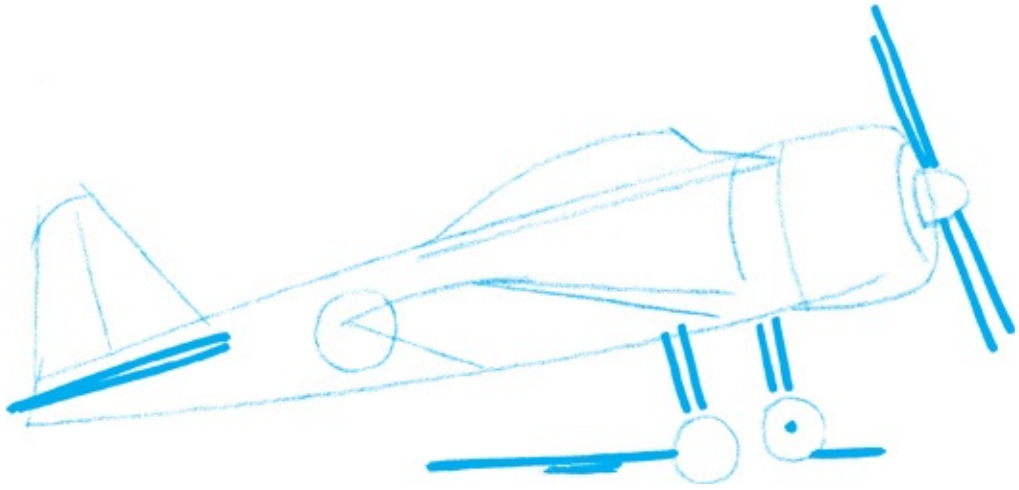

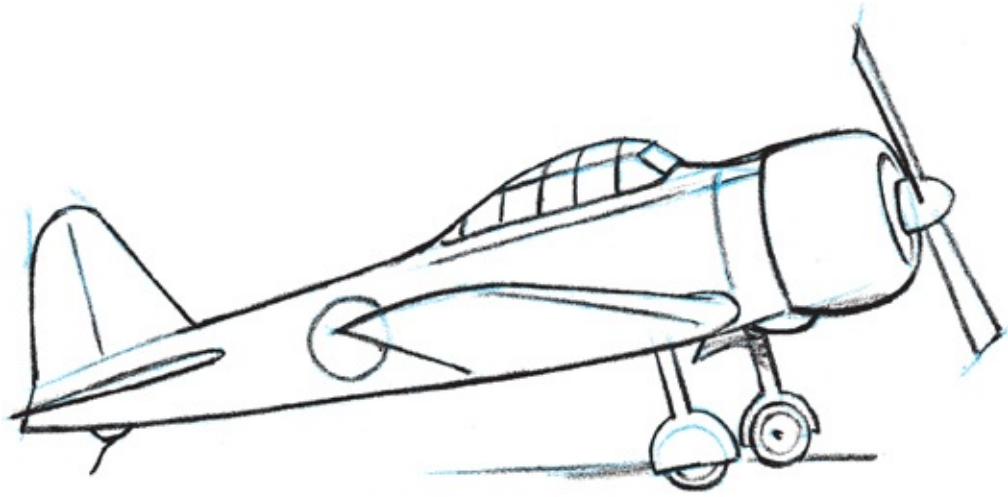



Sopwith Snipe (Britain)

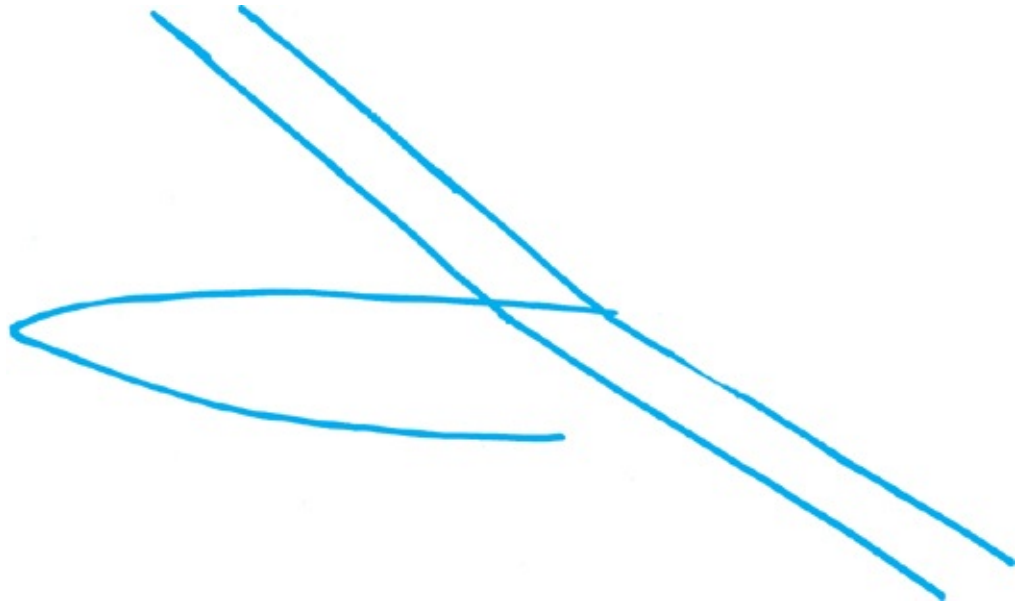

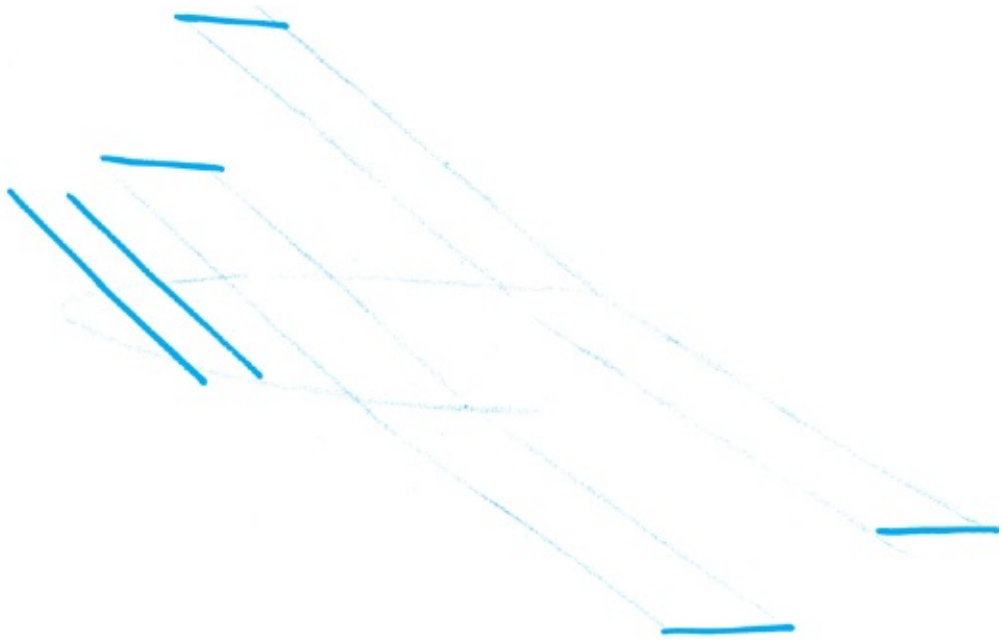
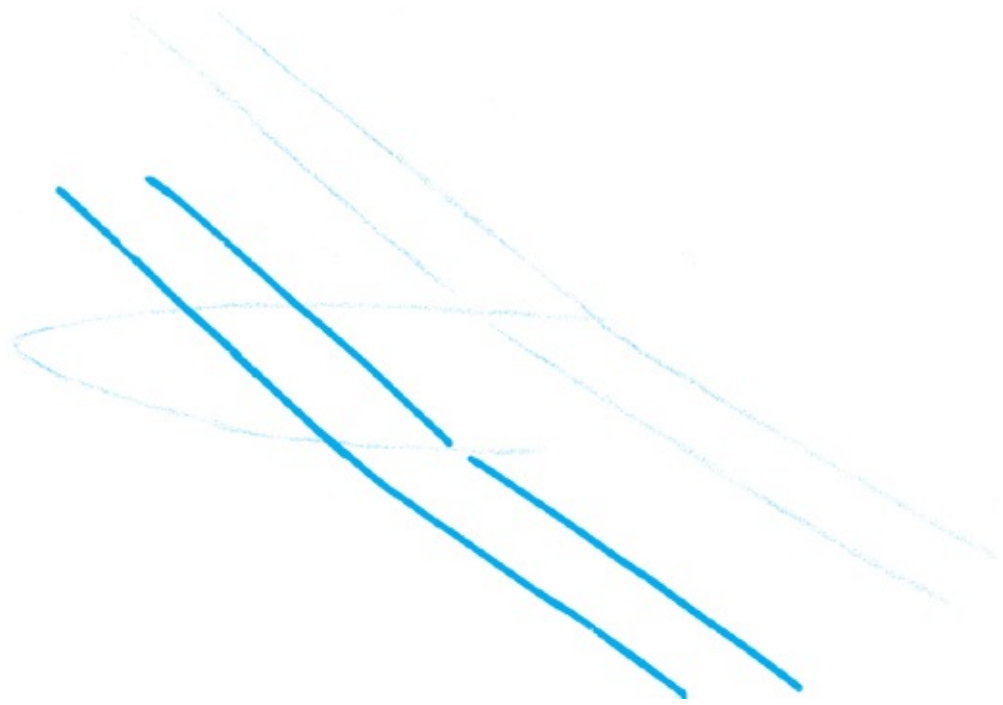

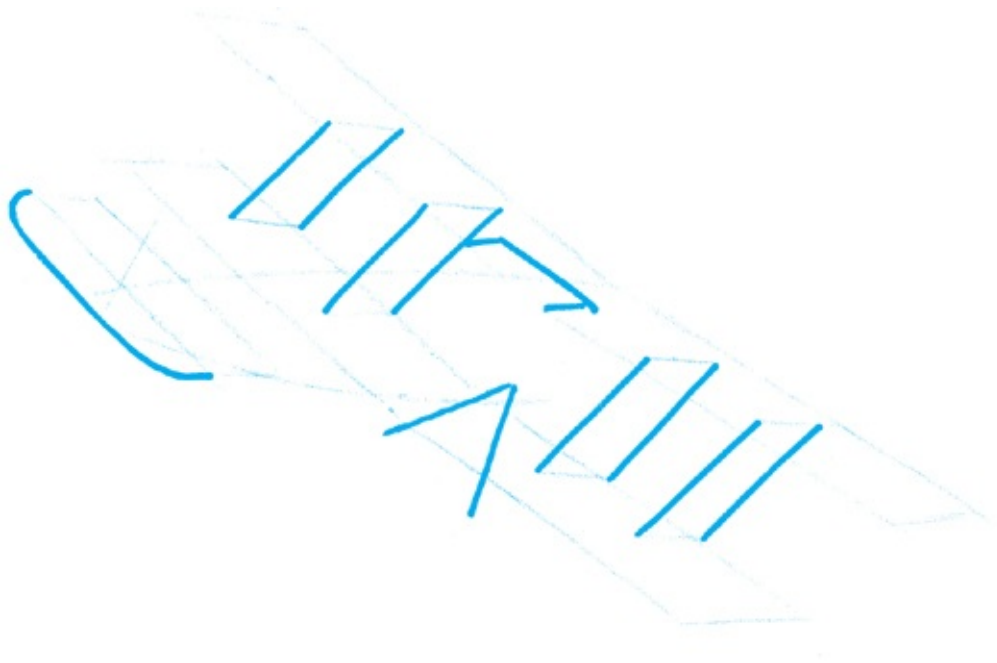
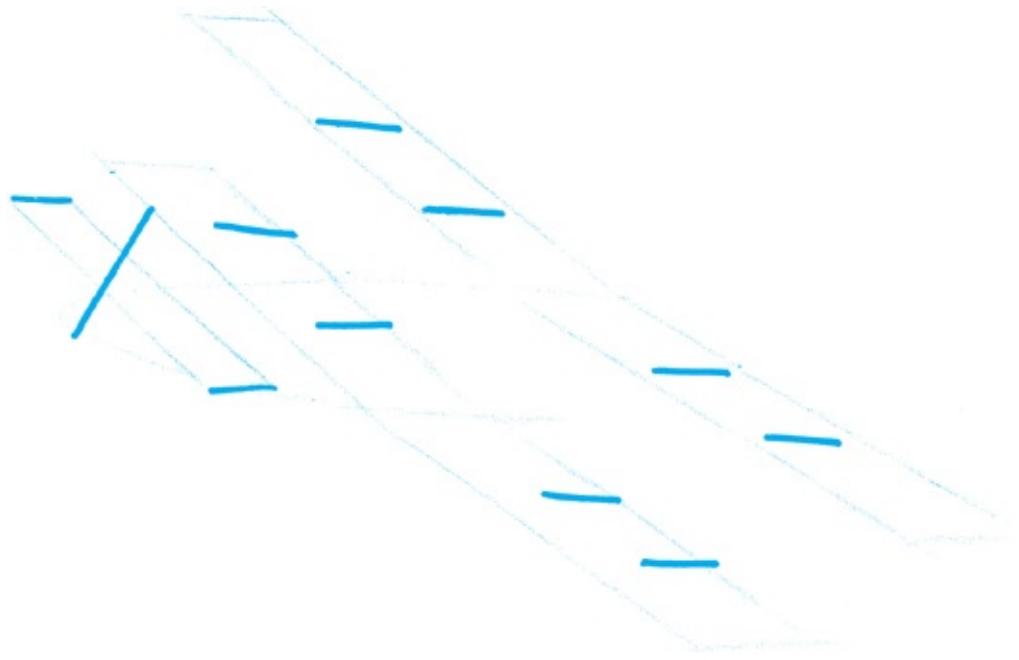

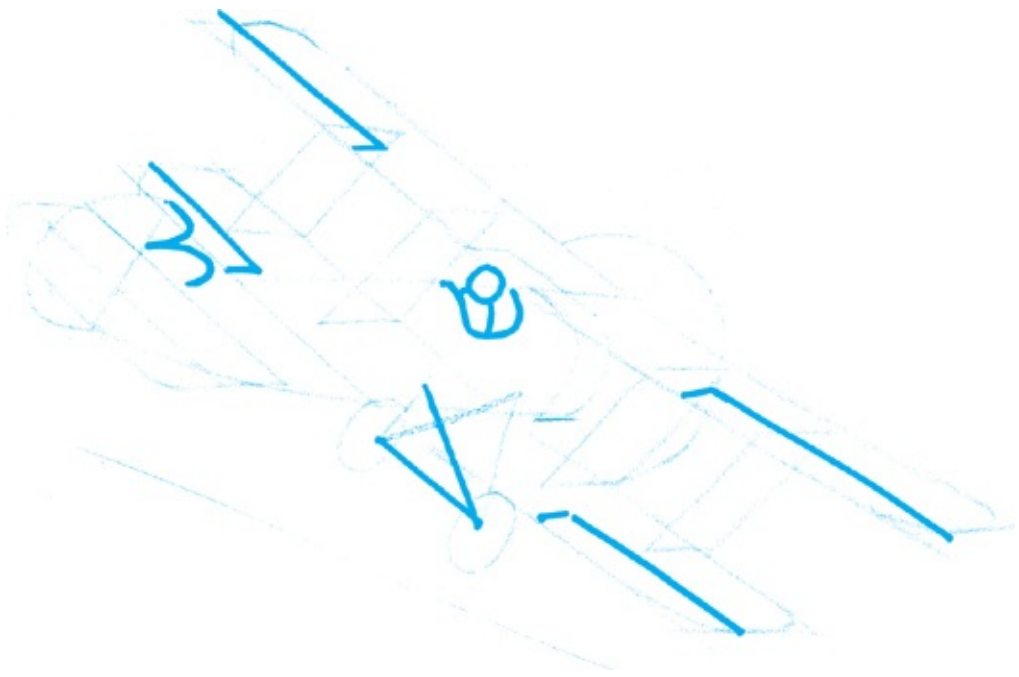
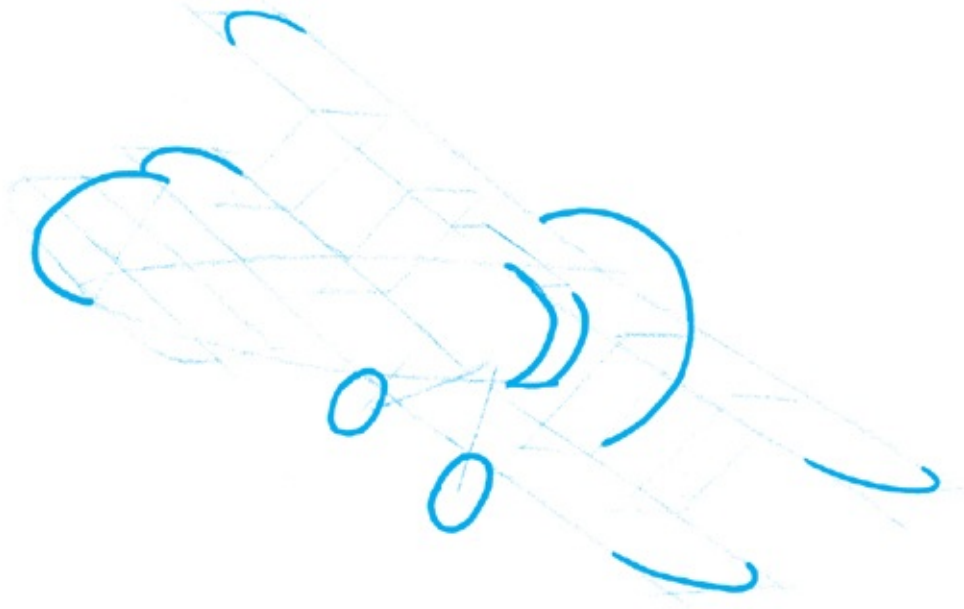

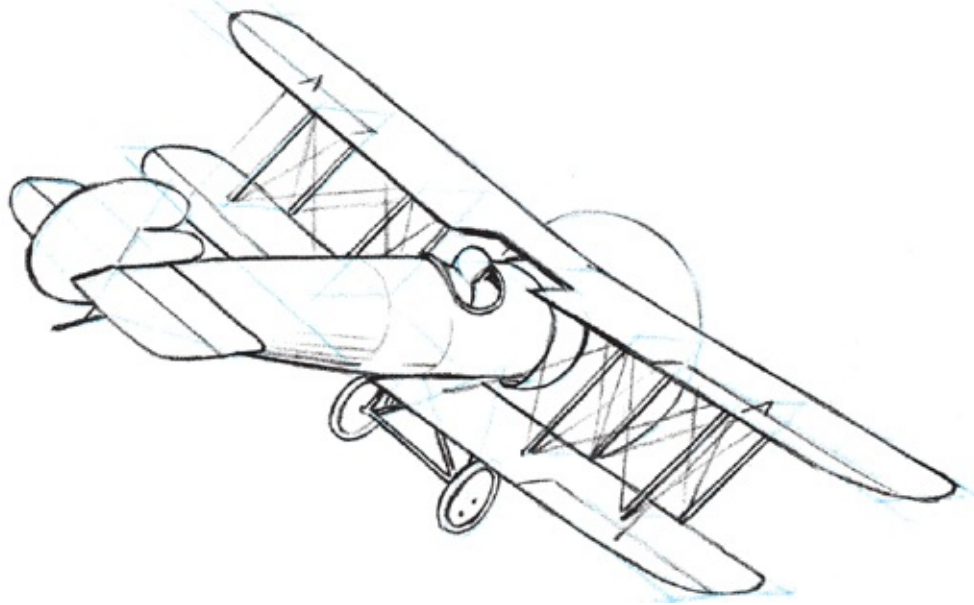



Spad (France)

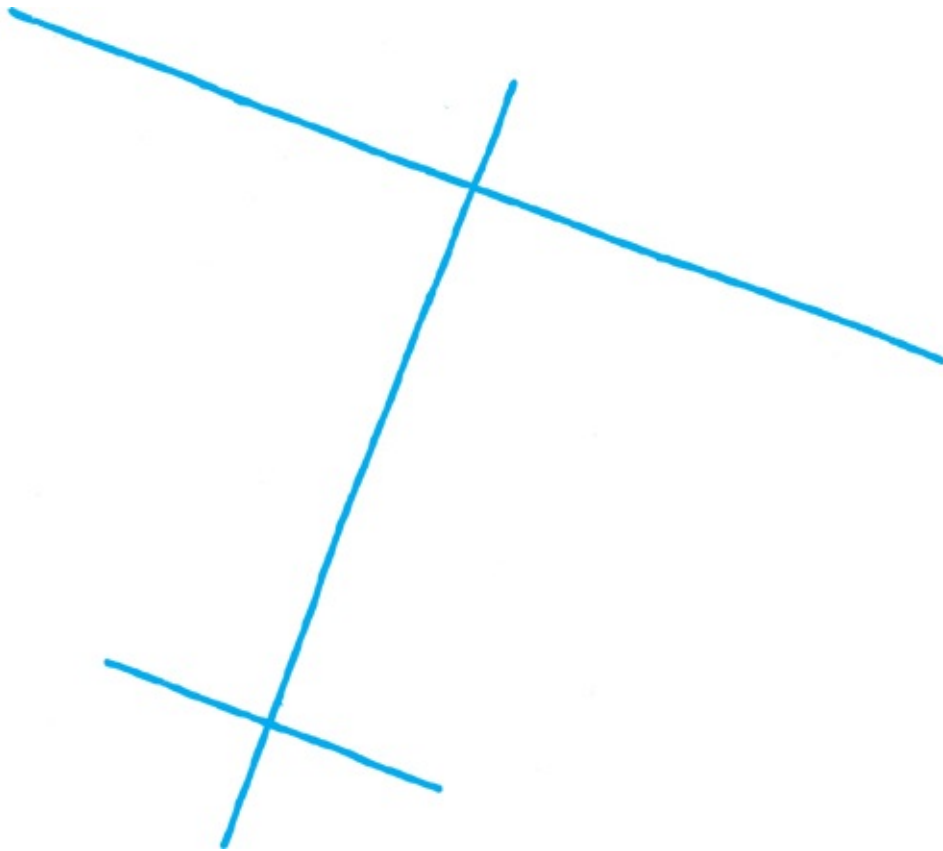

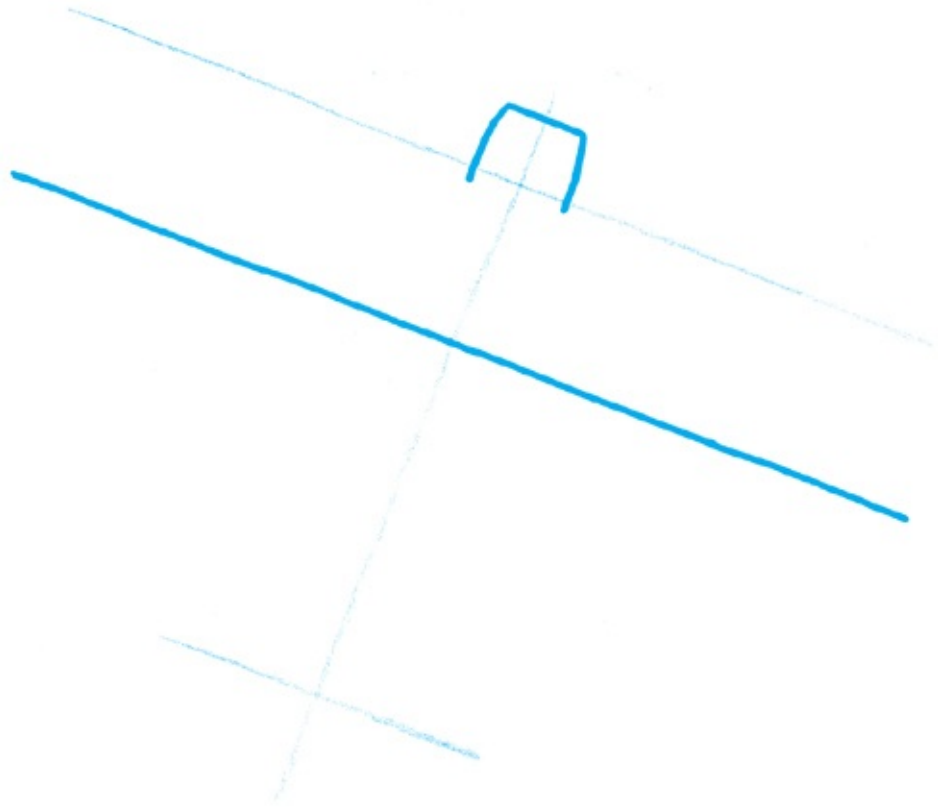

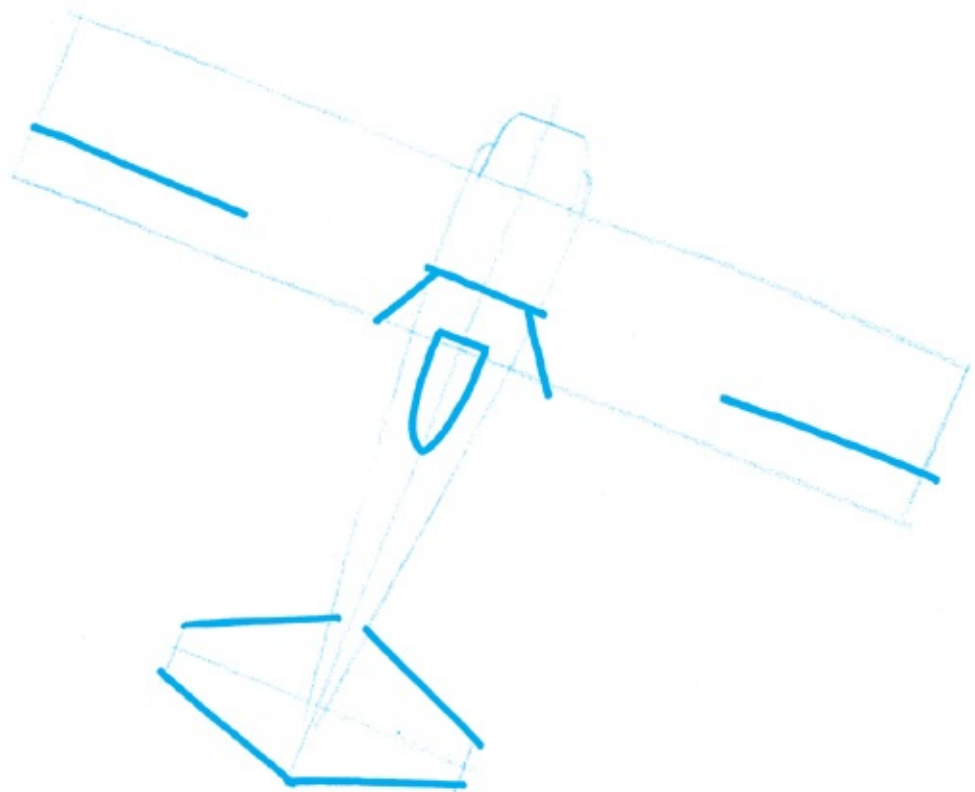
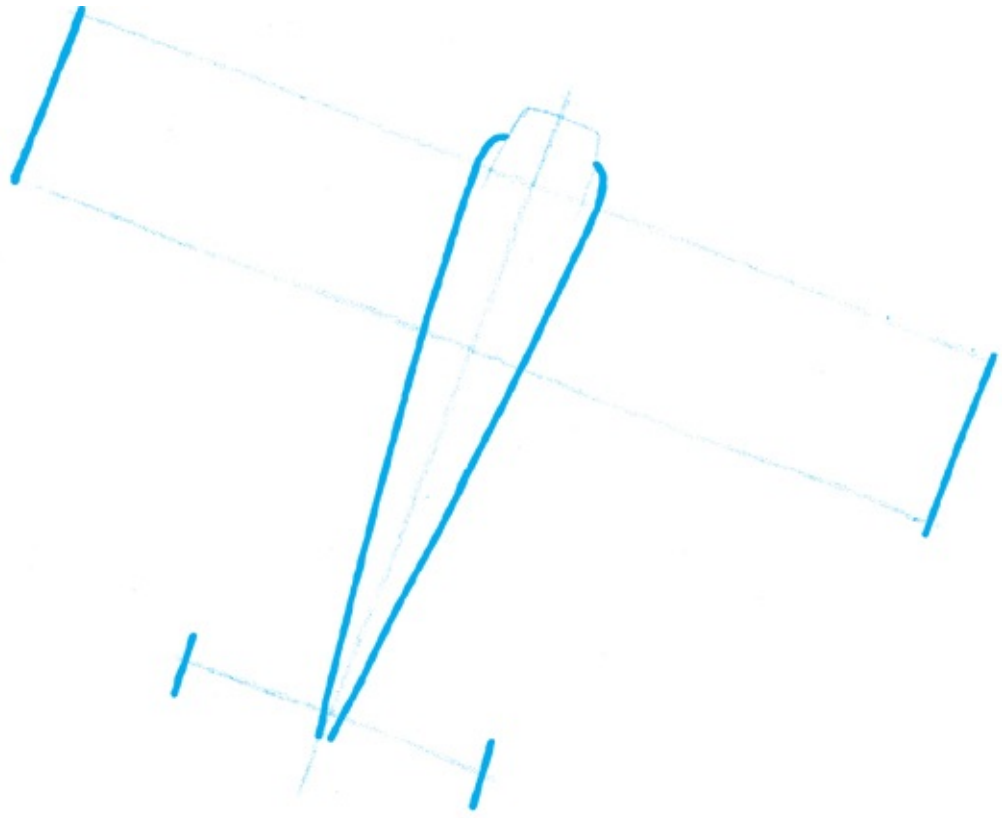

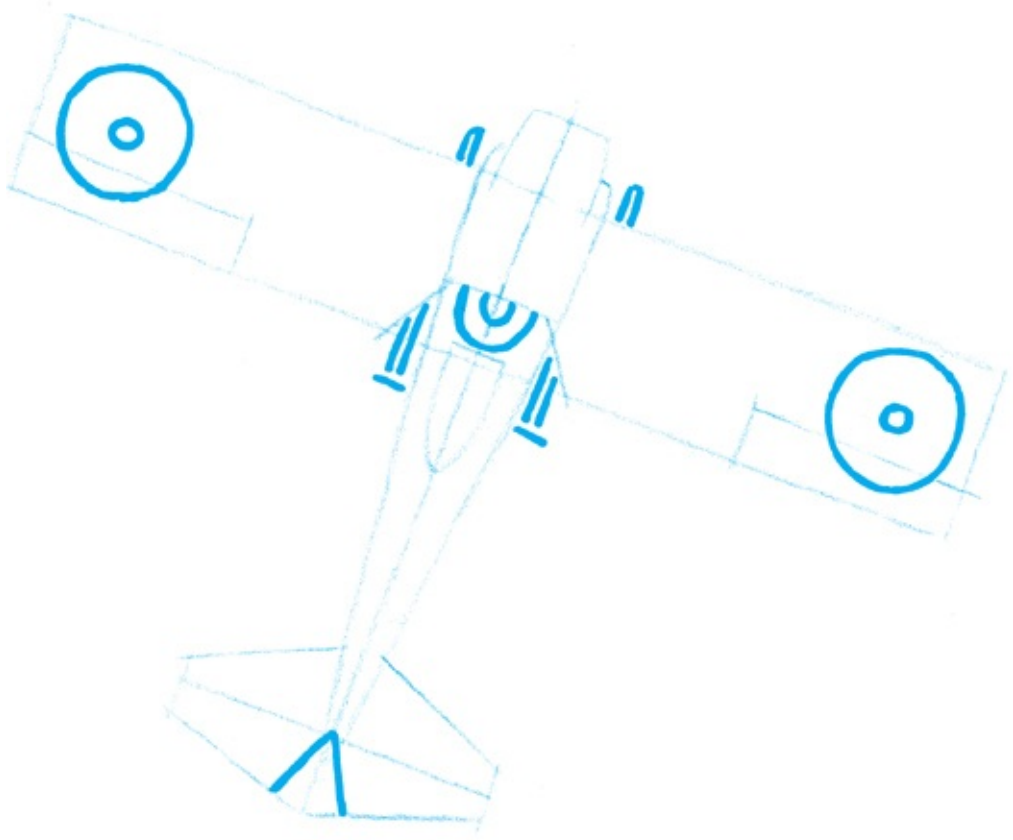

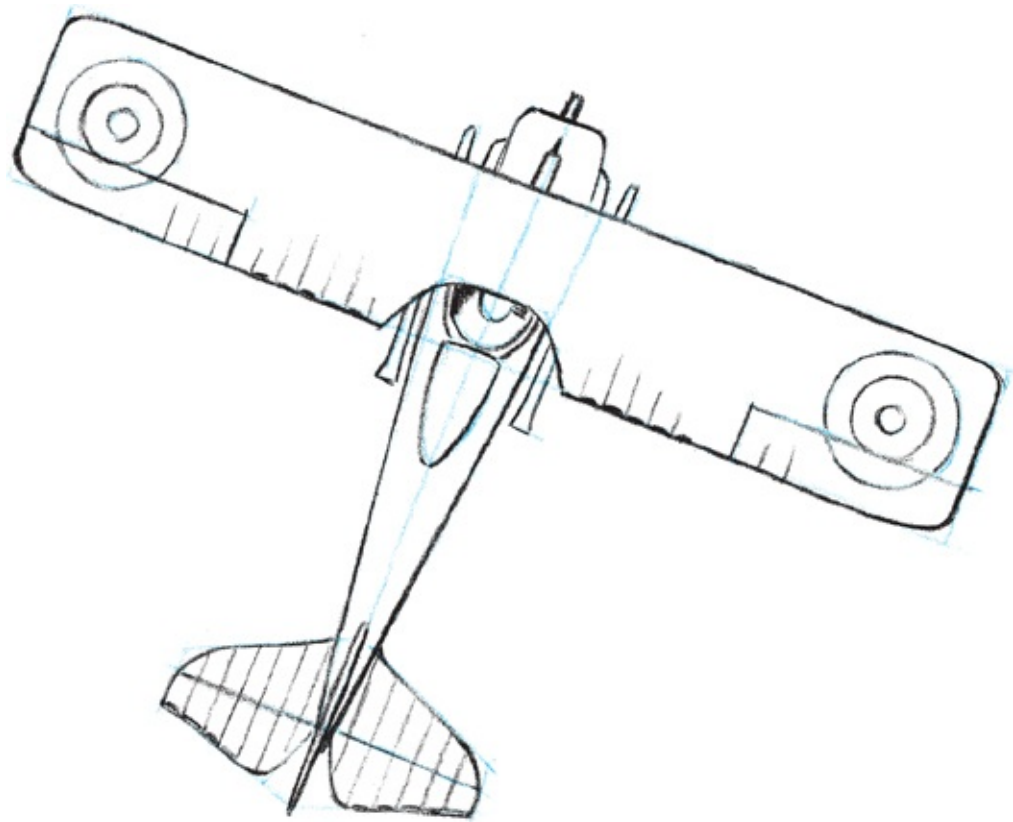



X-3 (USA)



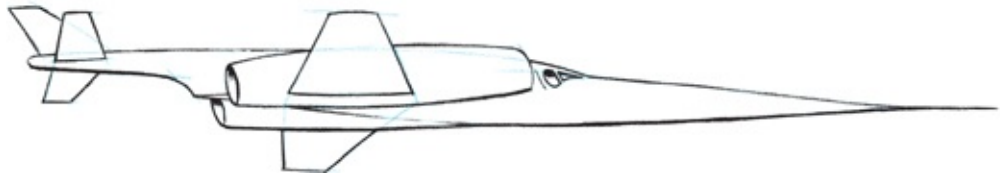



F-86F Sabre (USA)

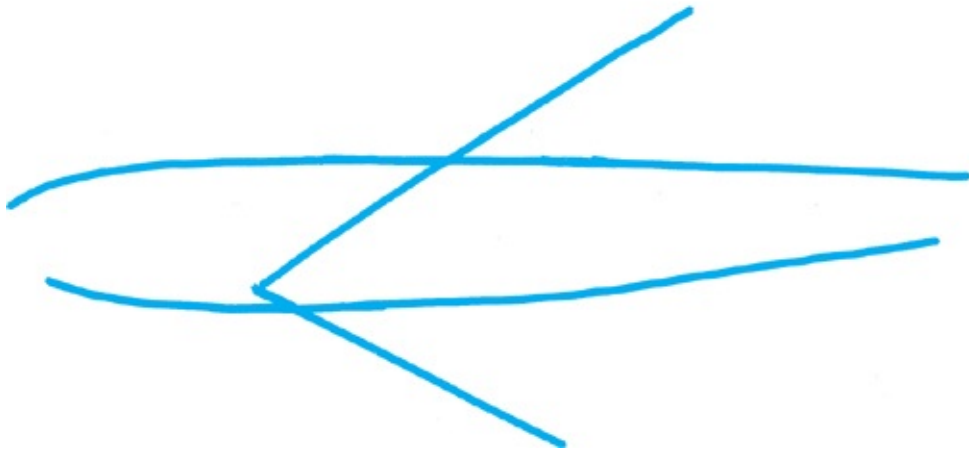

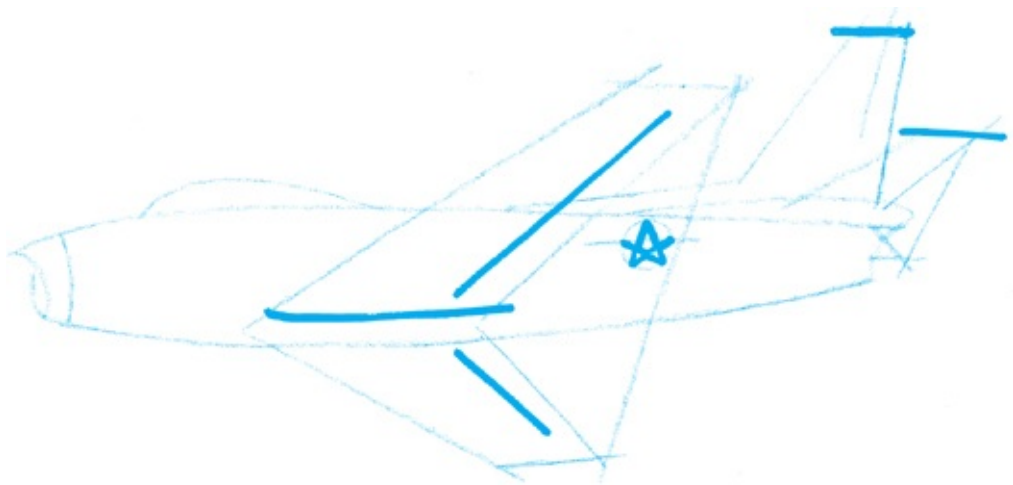
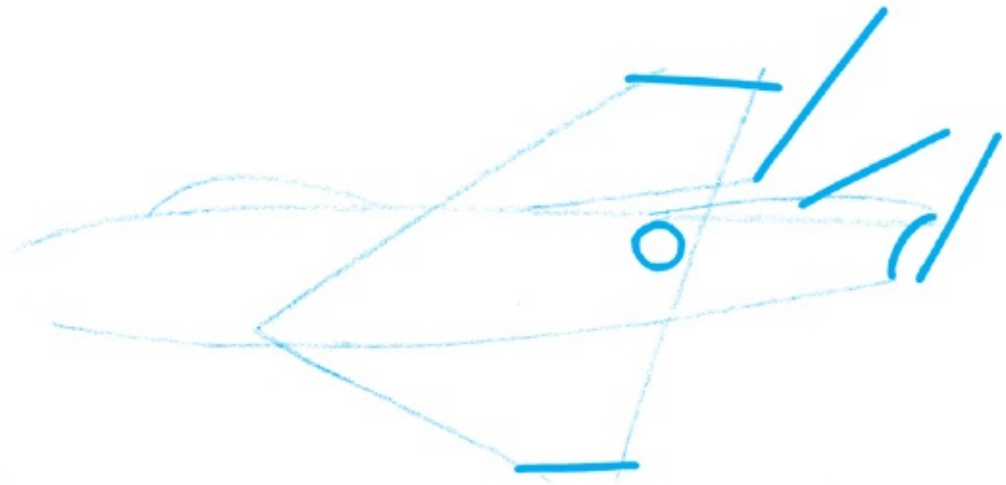

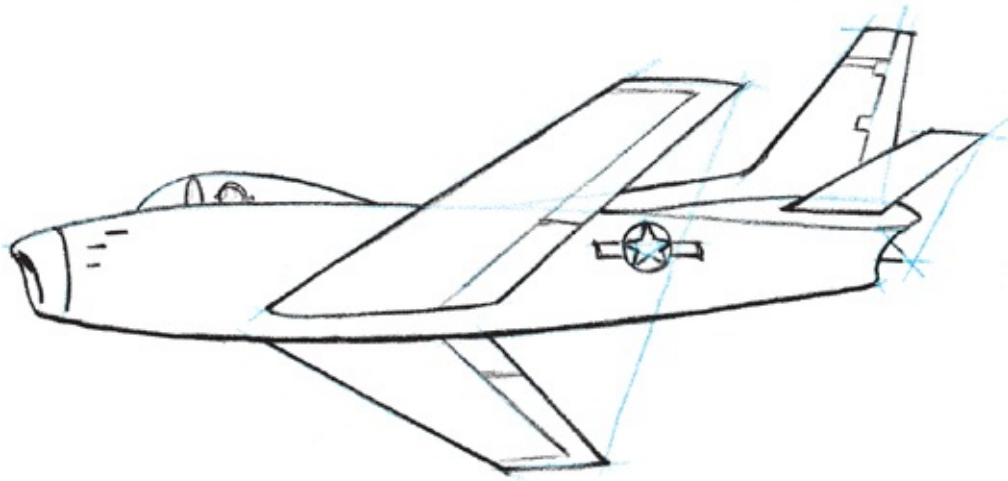

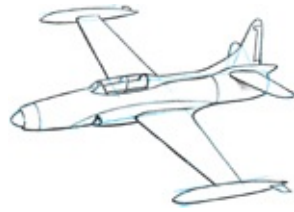

Lockheed F-94C Starfire (USA)

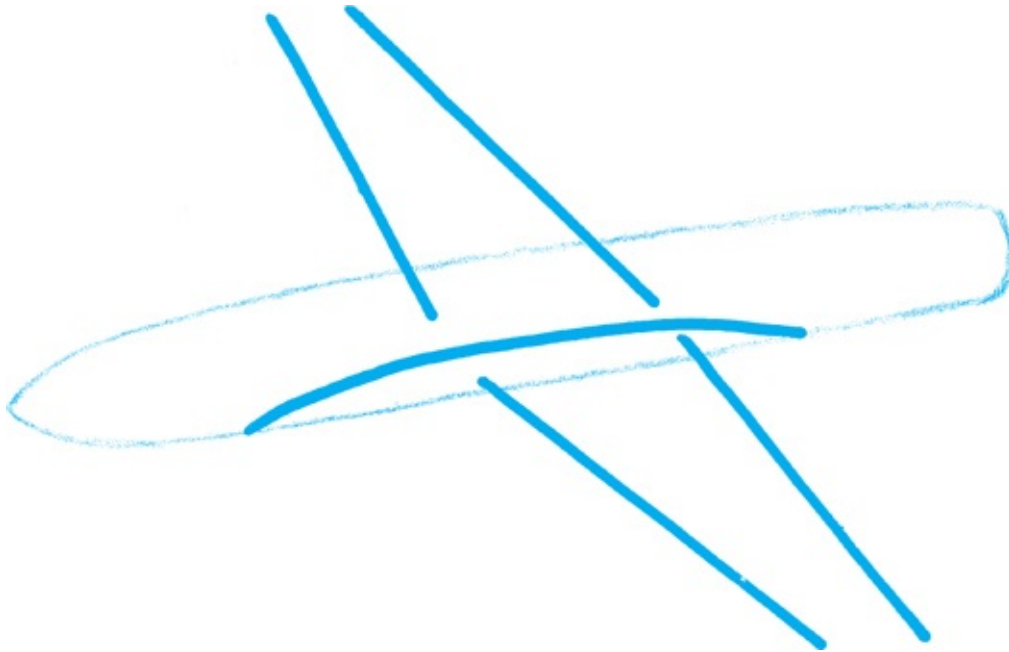
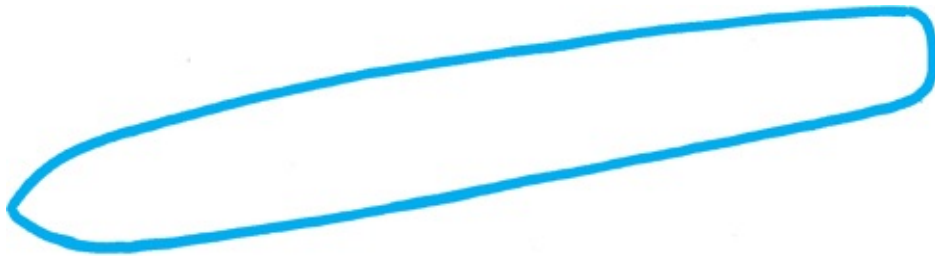

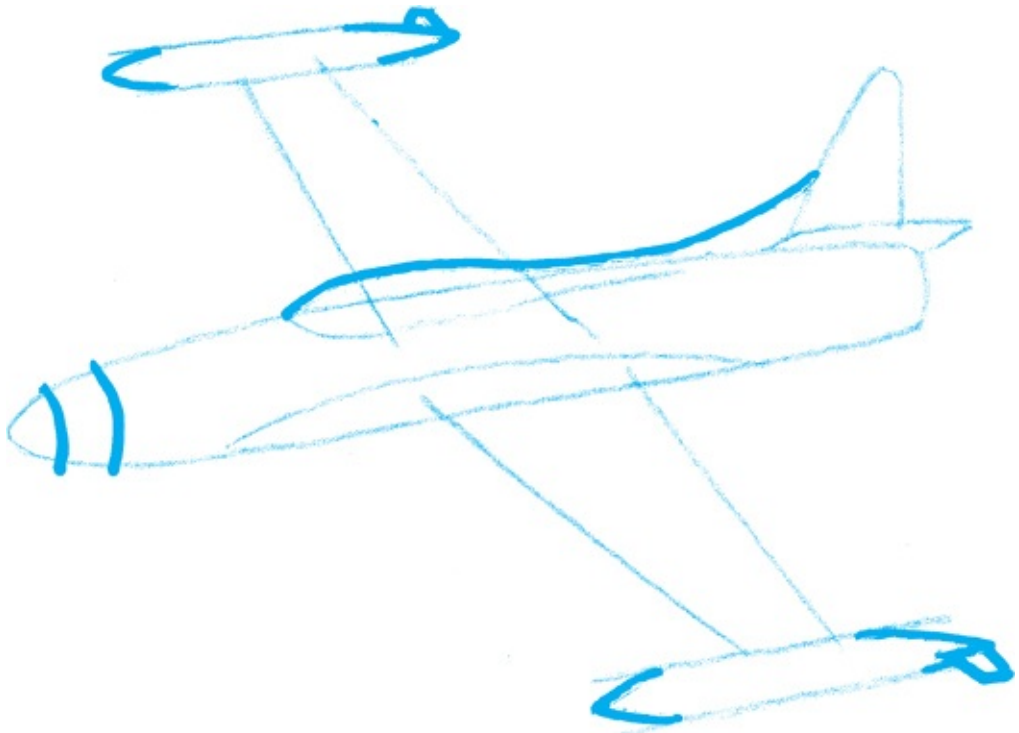
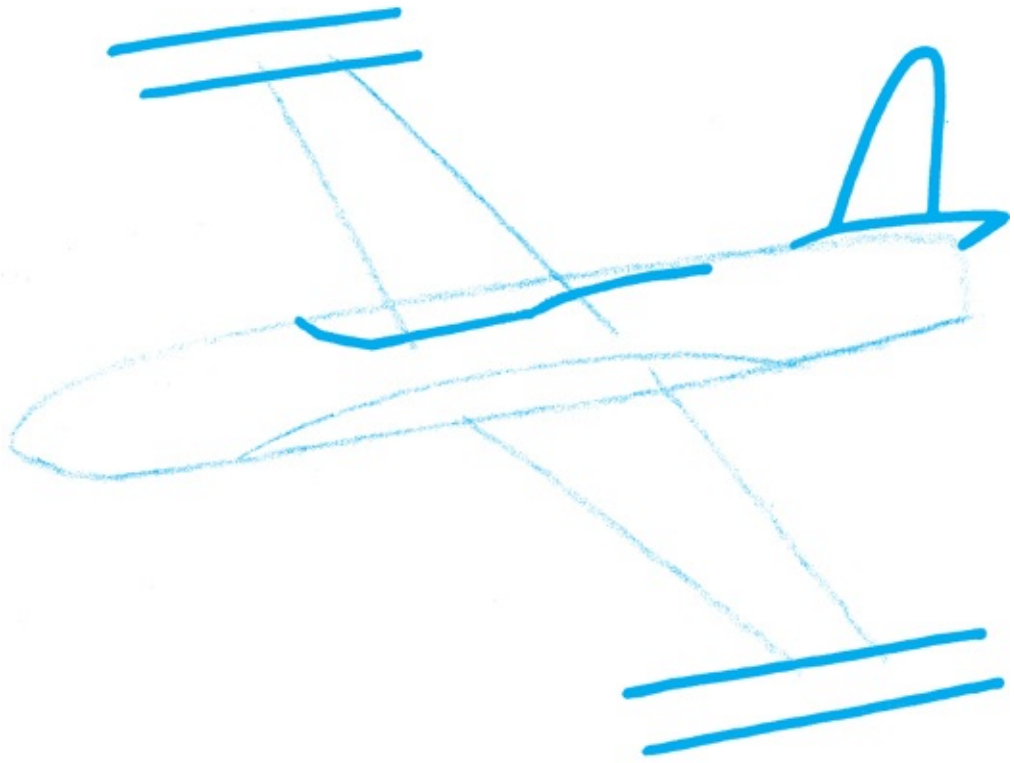

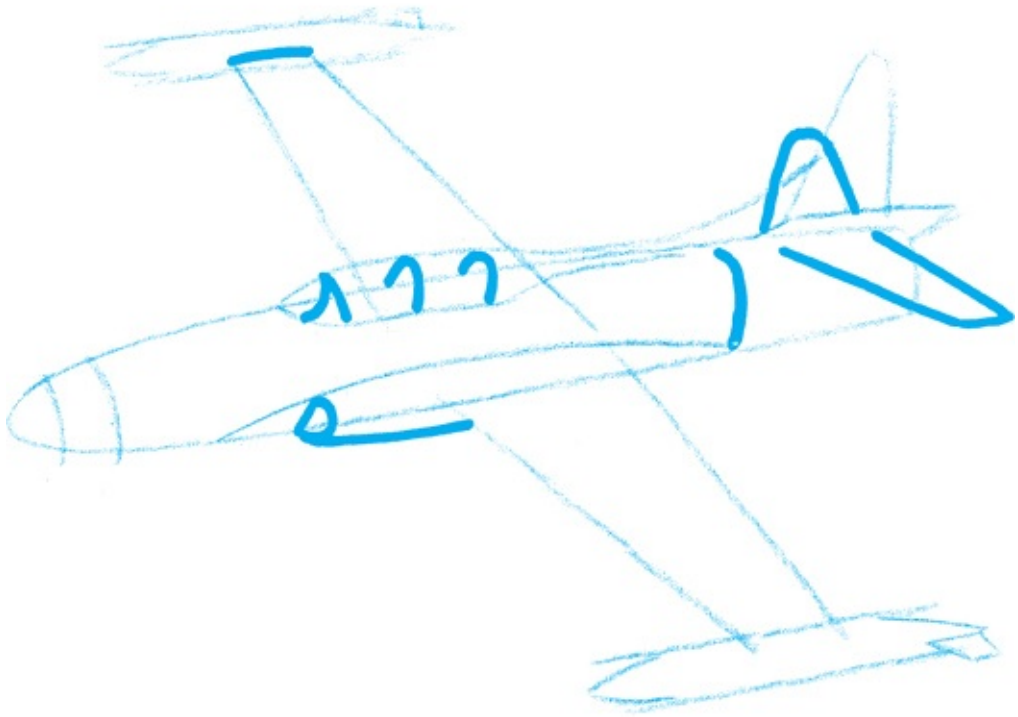

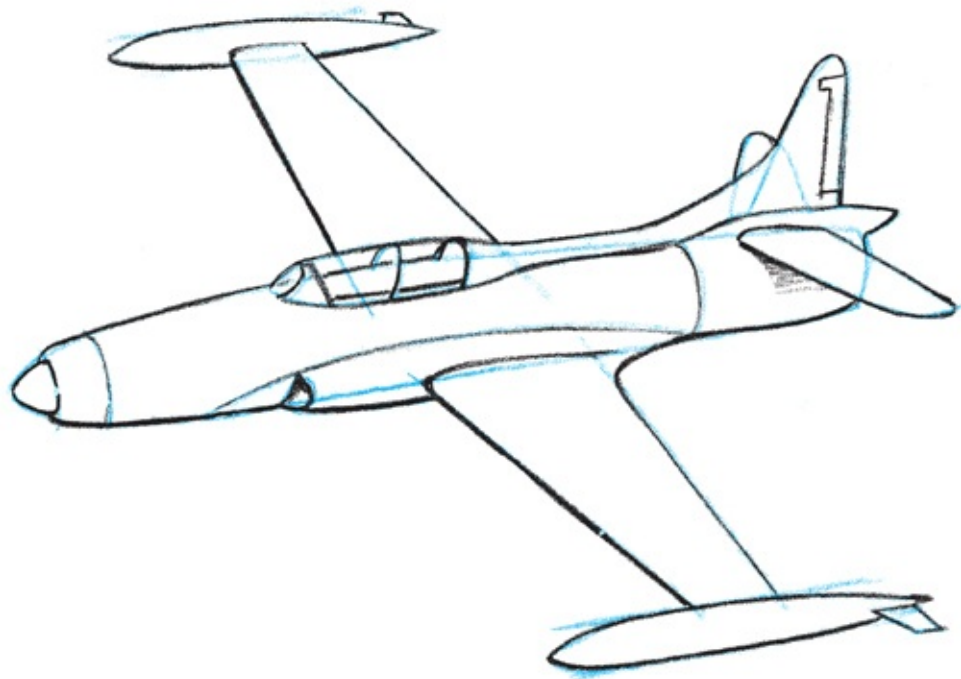



Helicopter



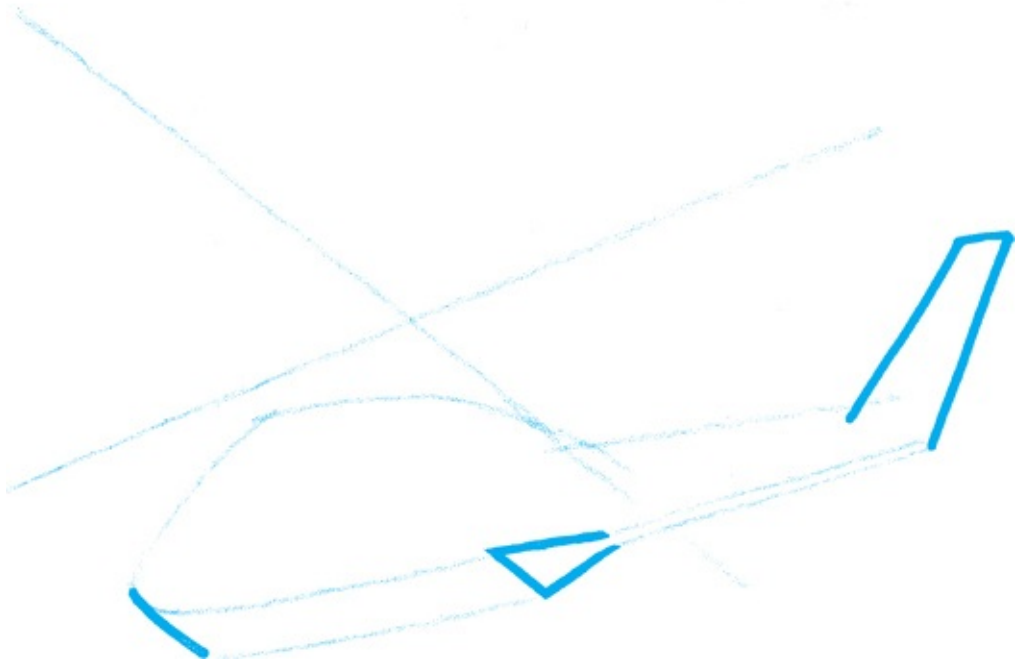
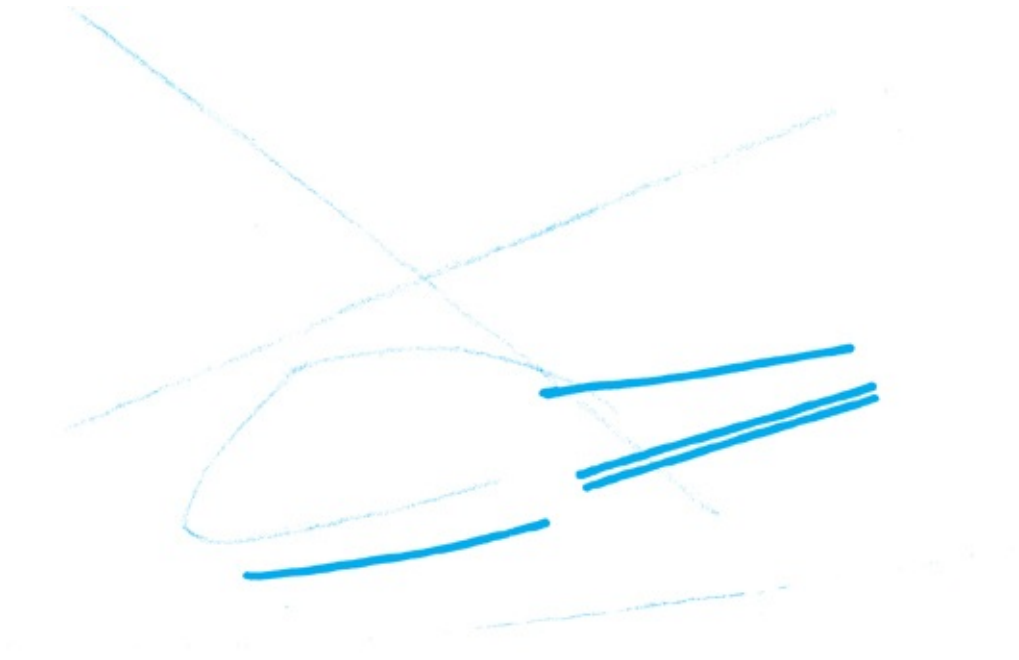

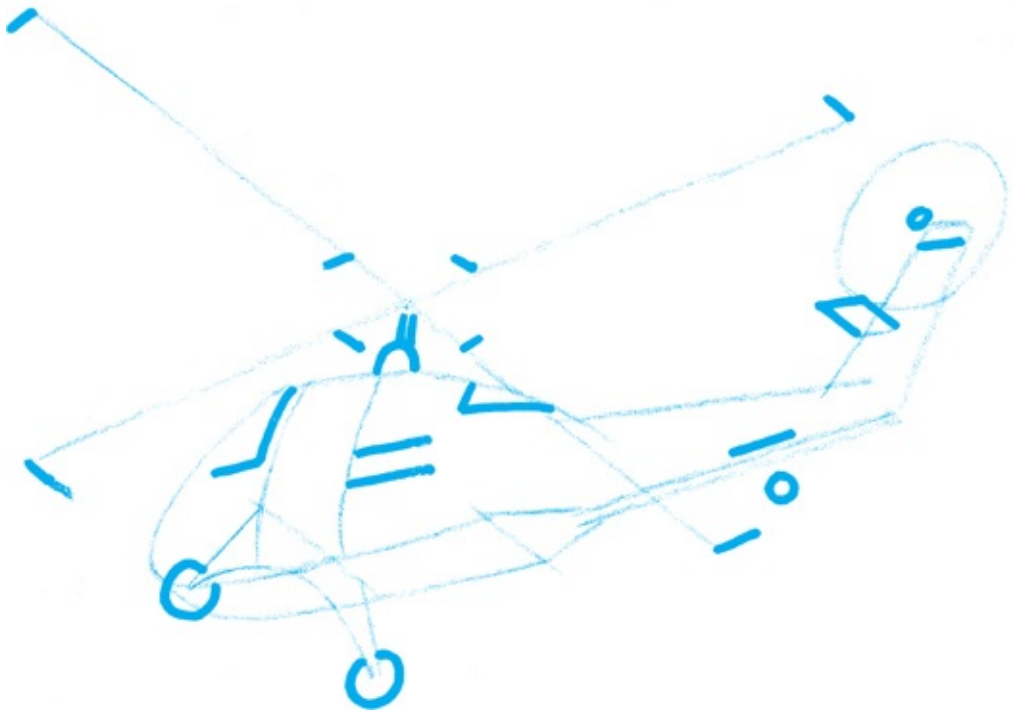
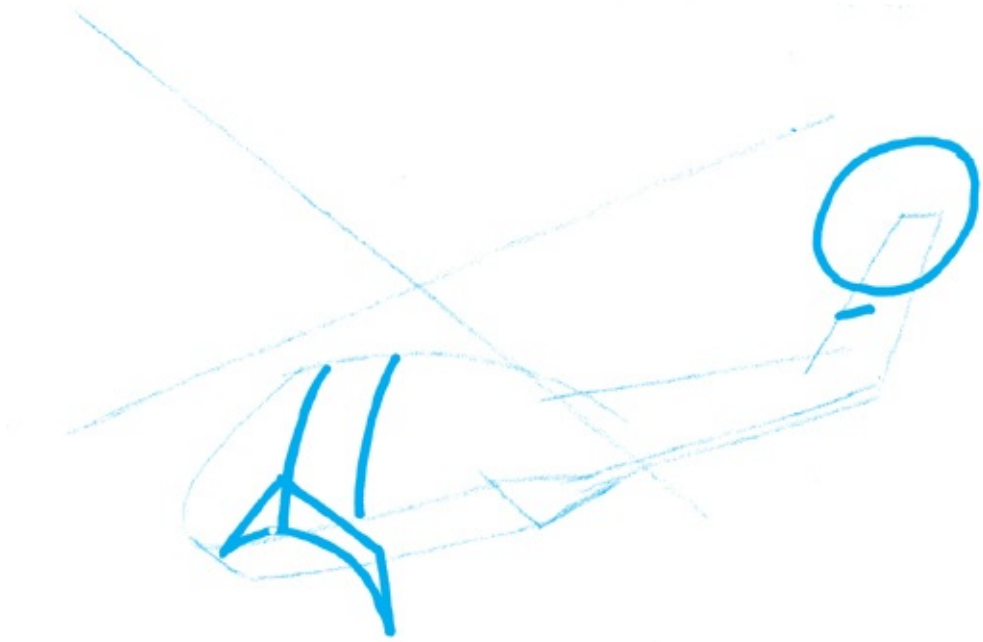

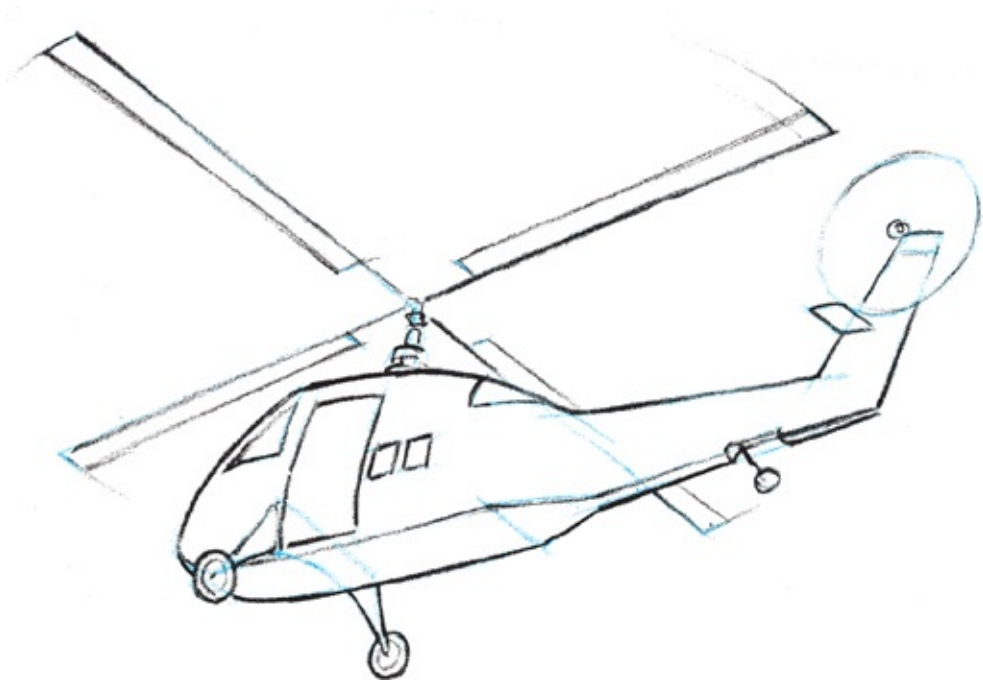



Hang glider



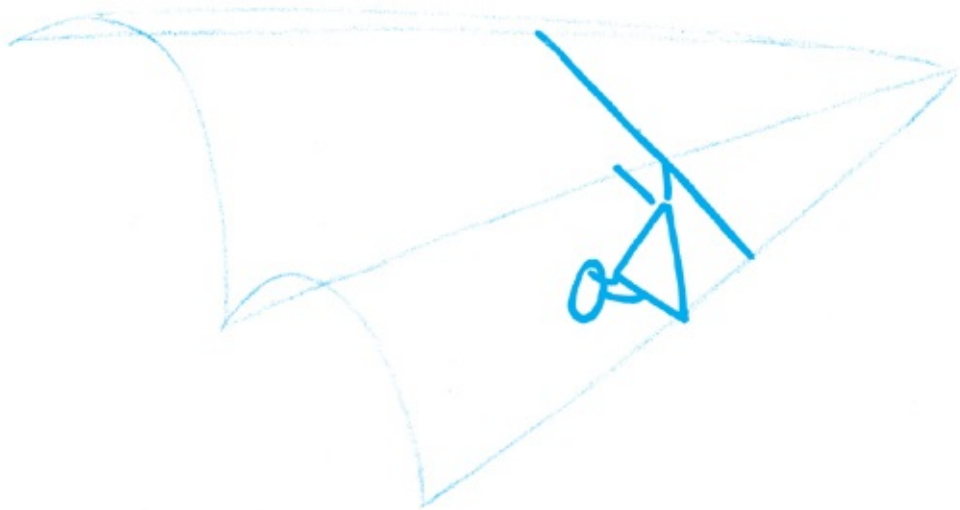
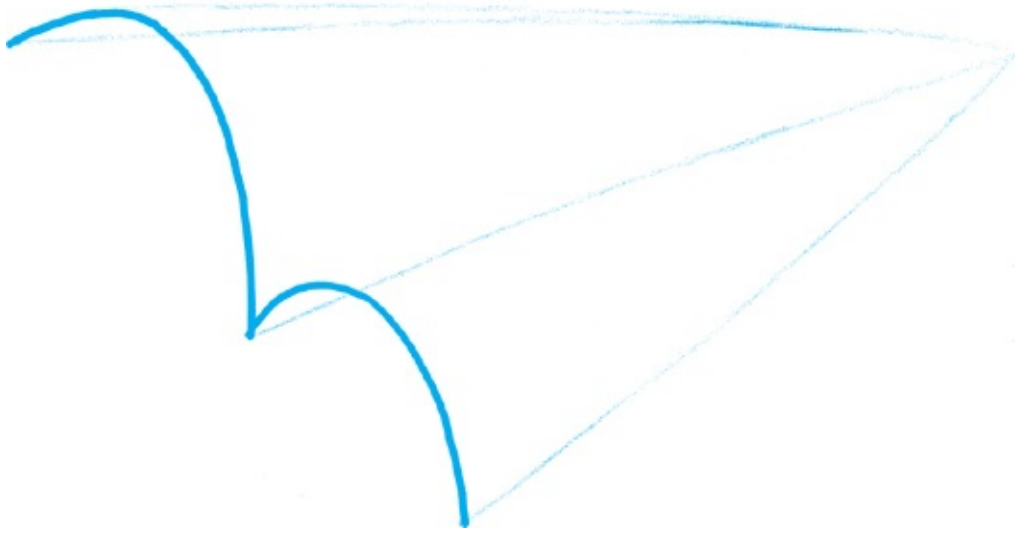

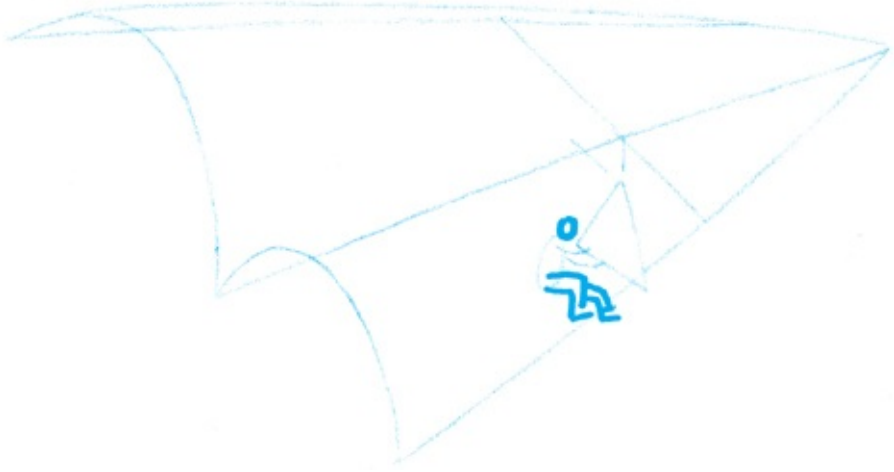

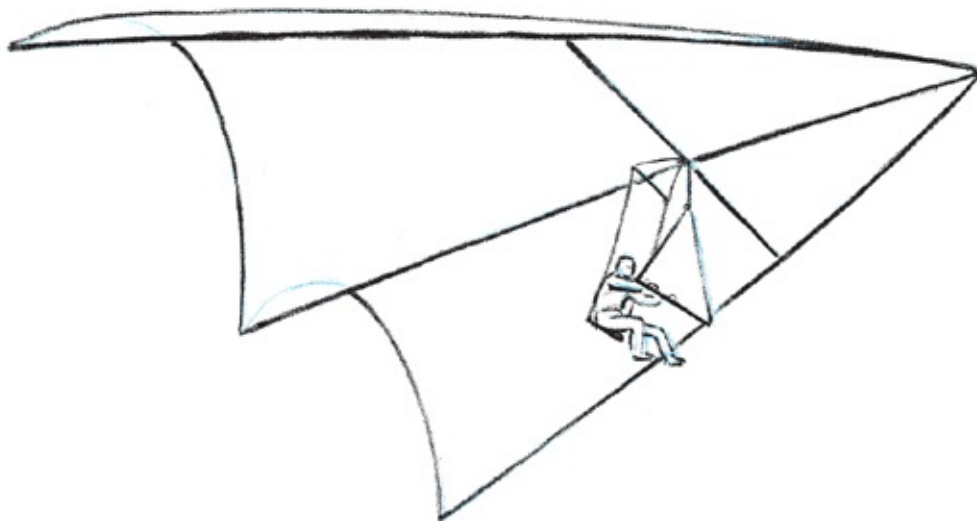

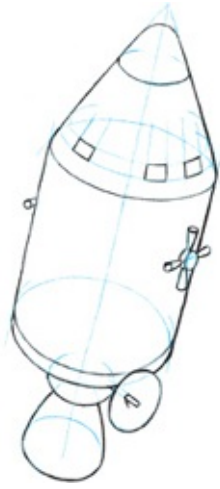

Apollo command module (USA)



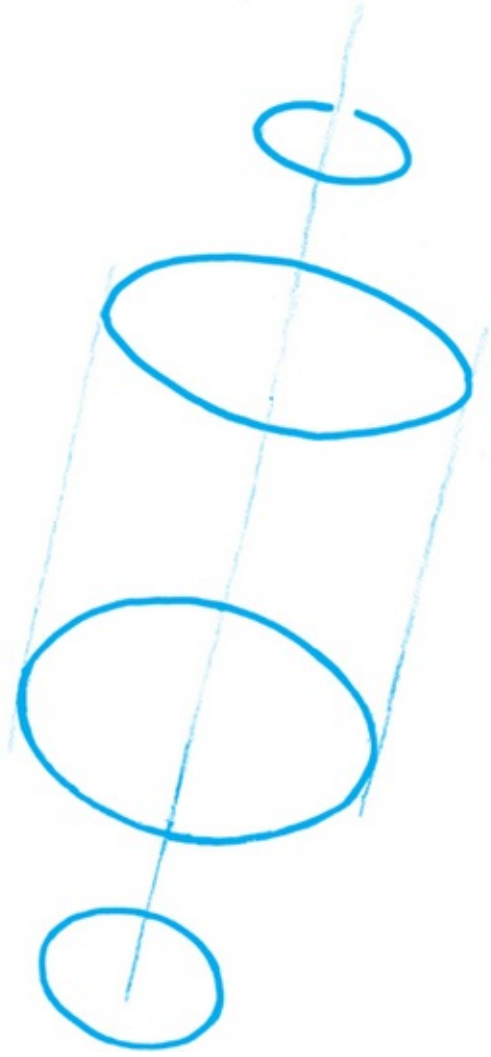

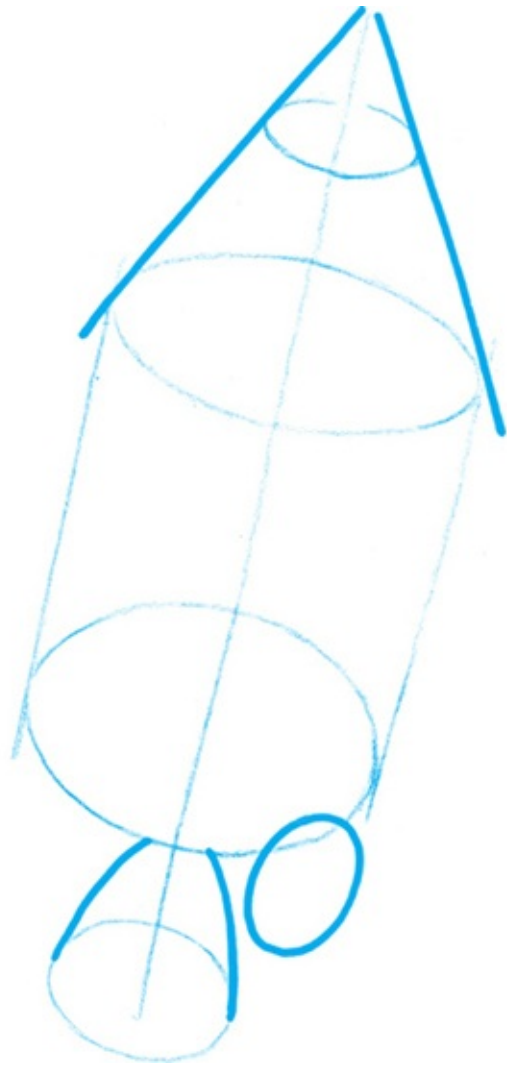

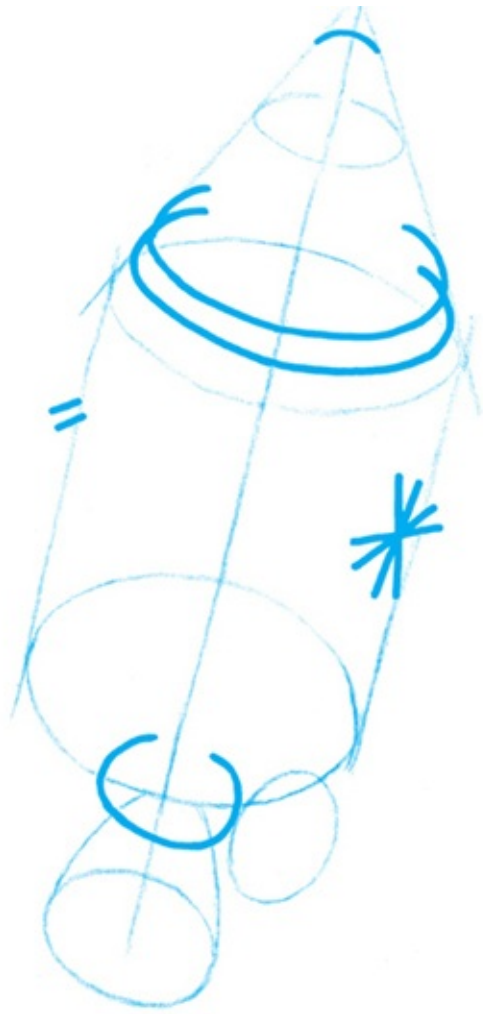



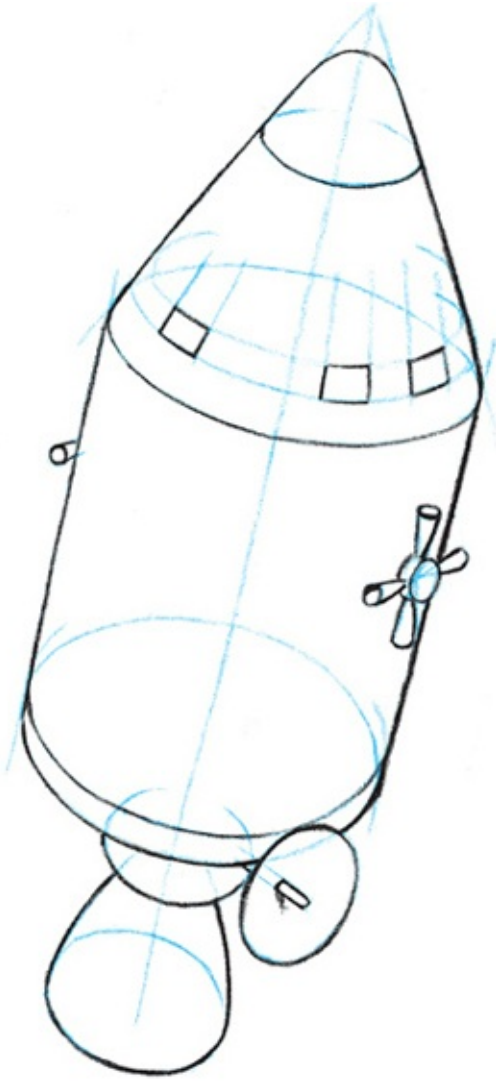

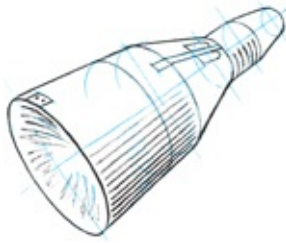

Gemini capsule (USA)

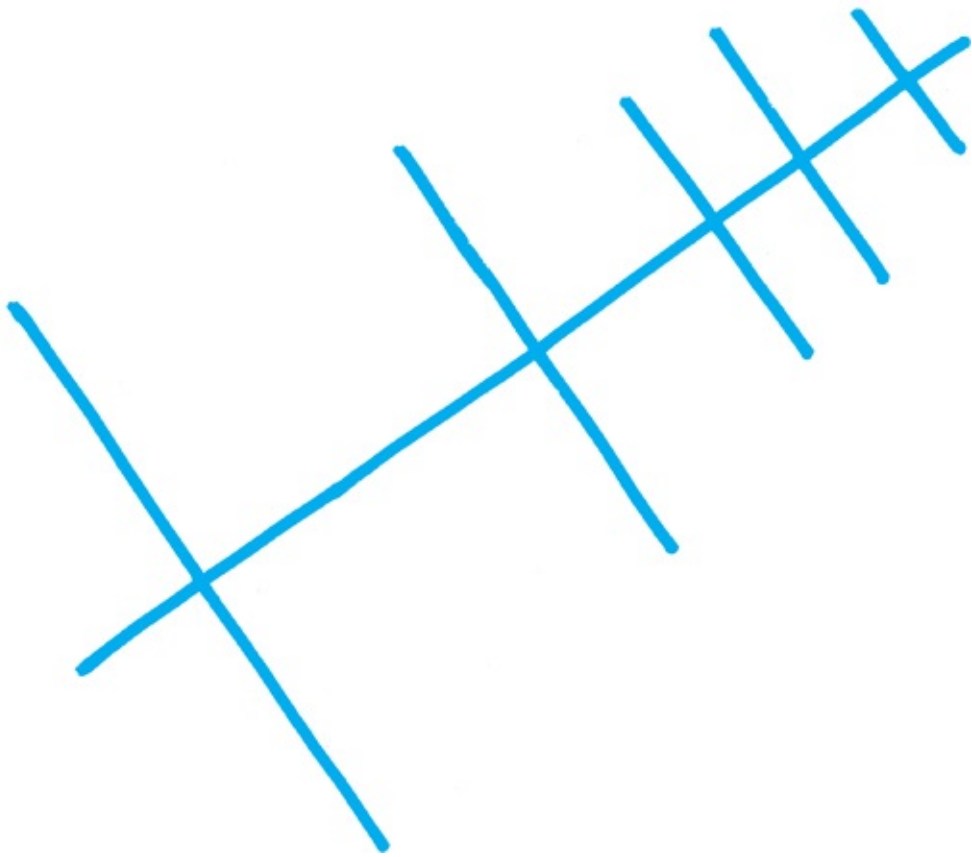

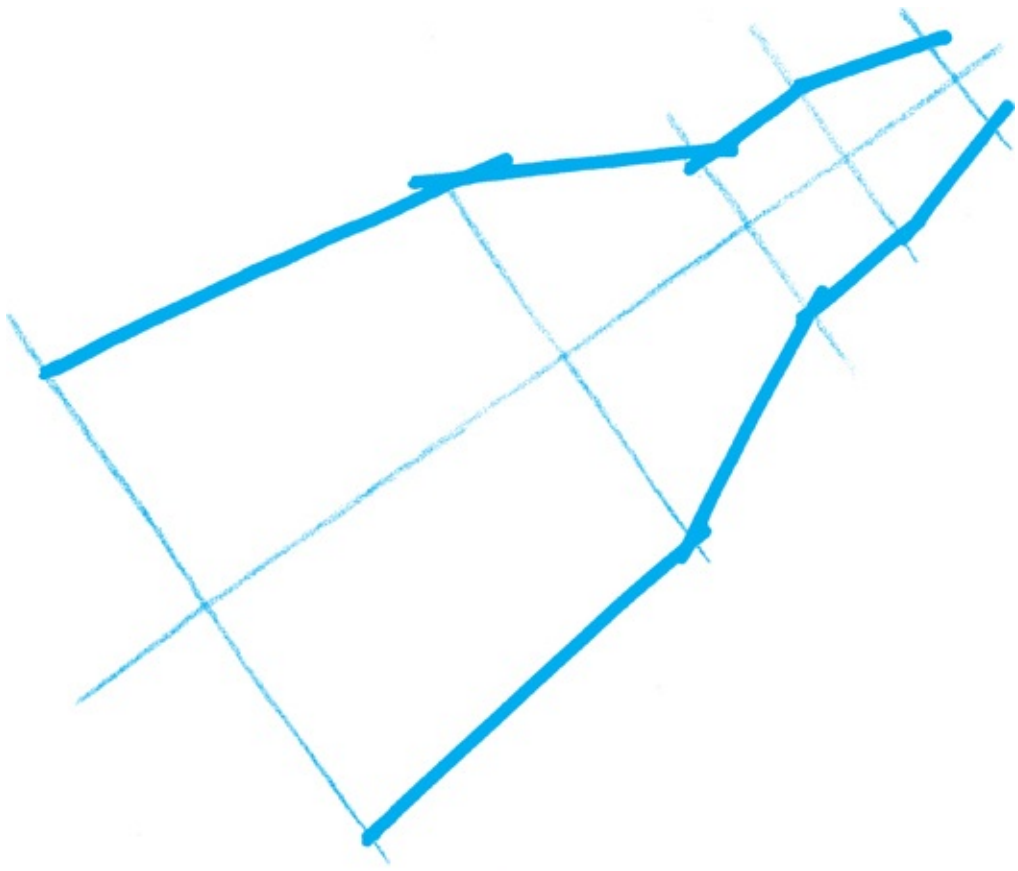

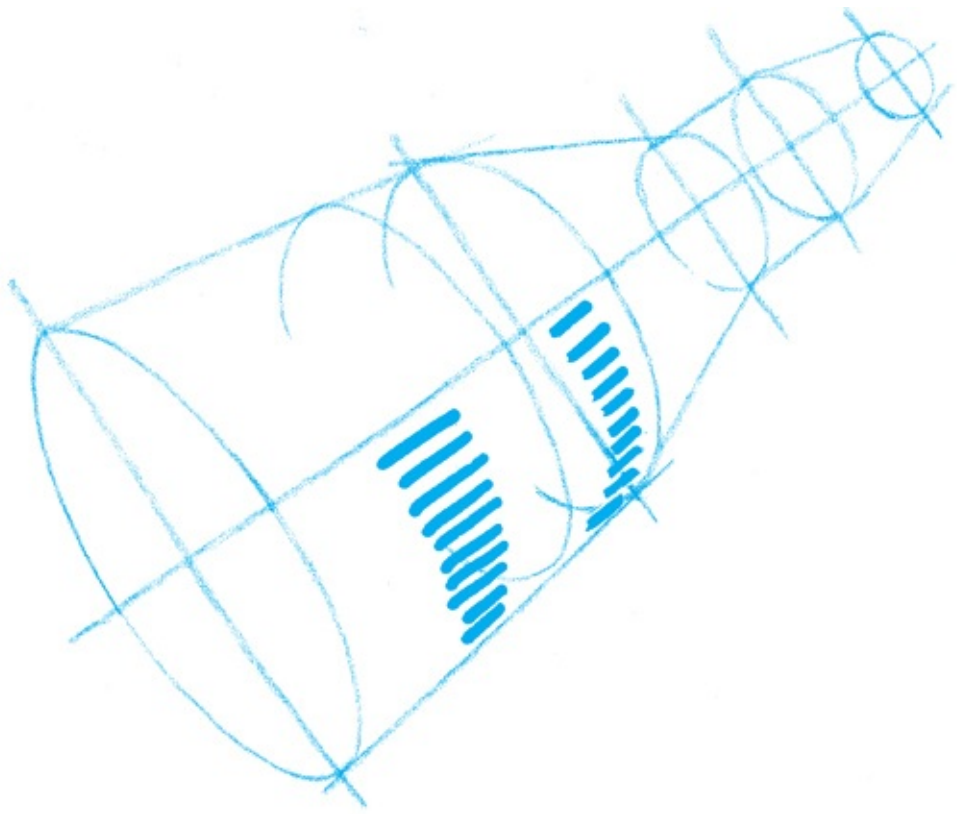
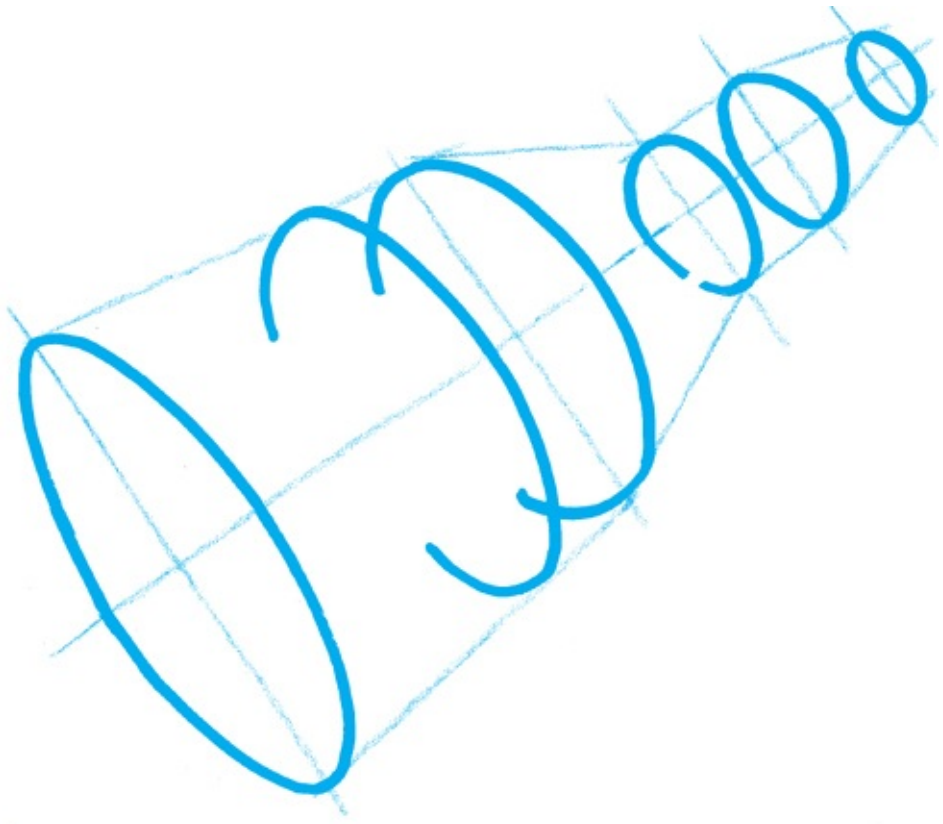

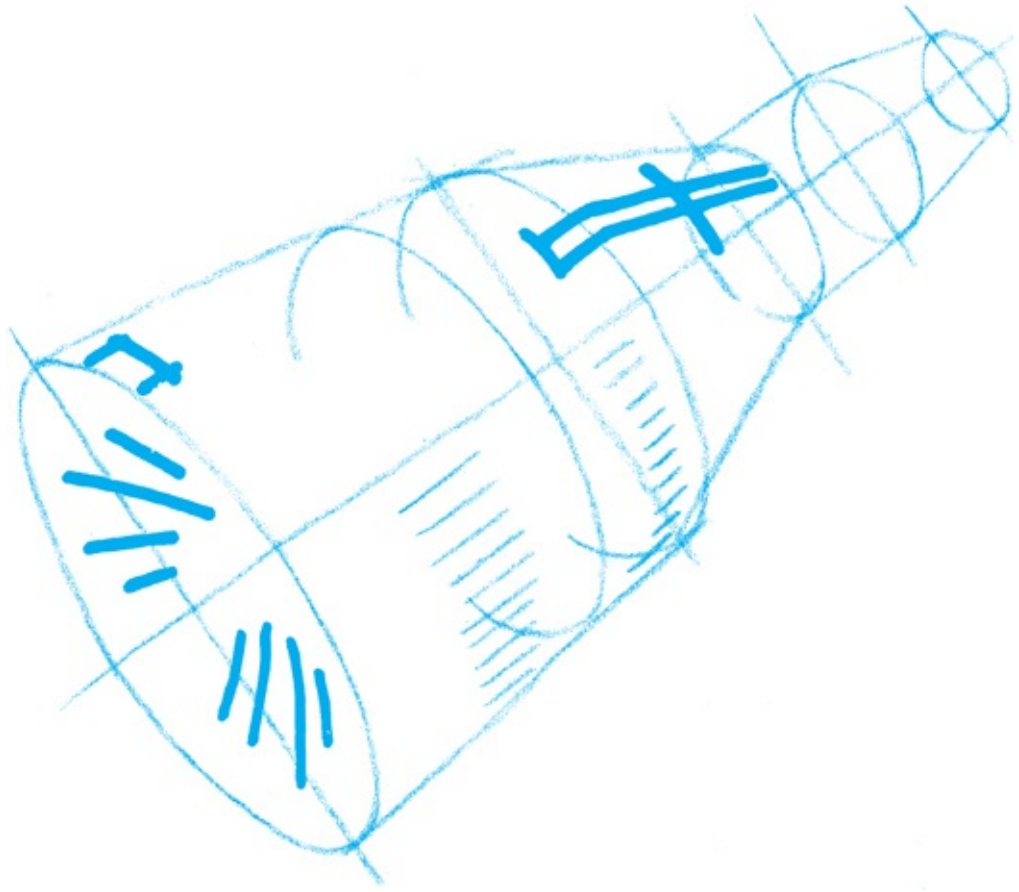

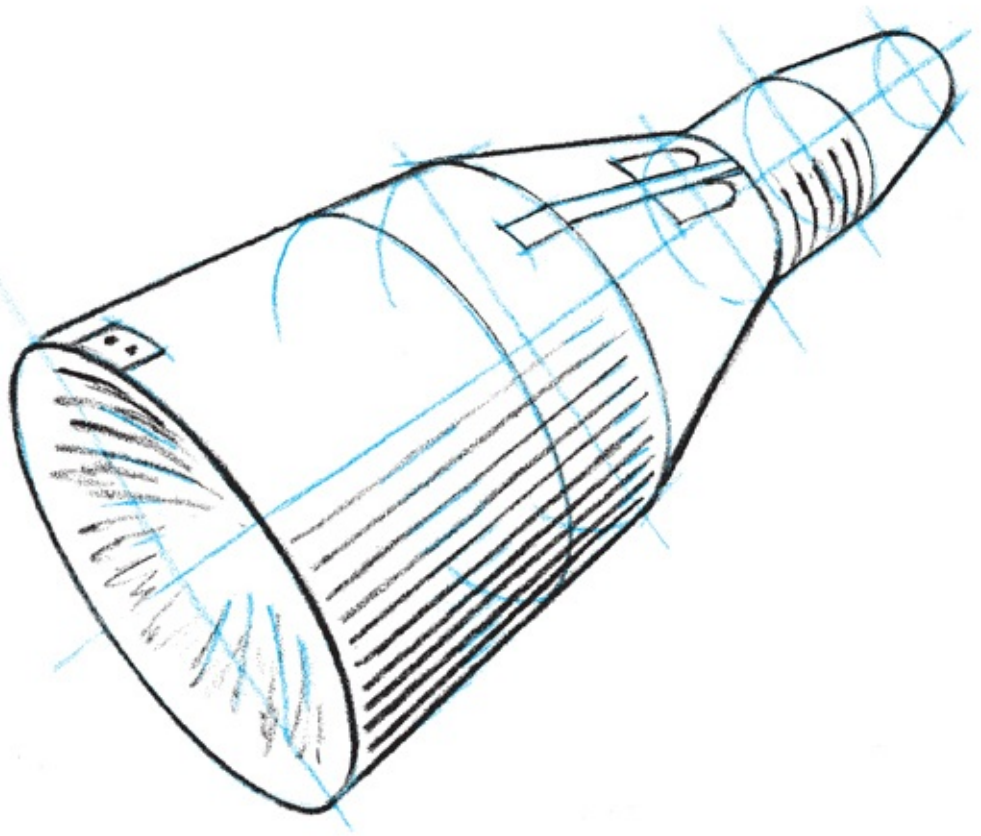



Saturn V rocket (USA)









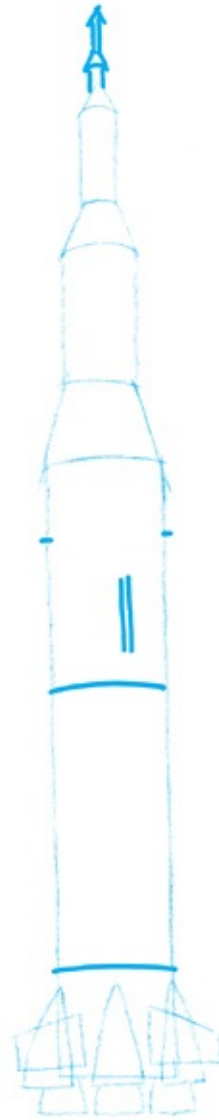

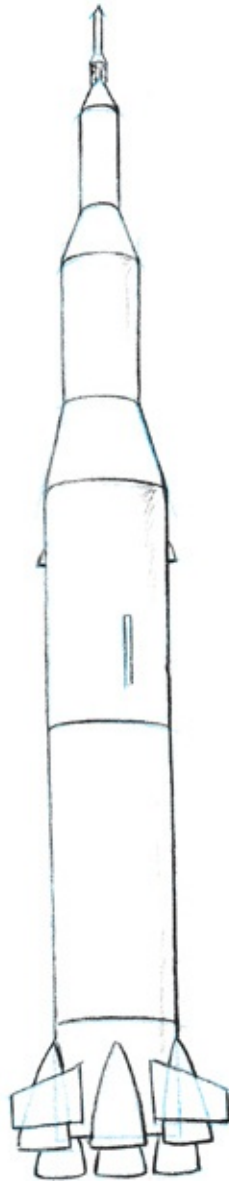

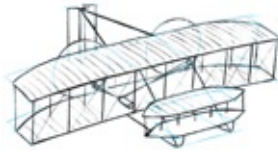

The Wright brothers' first airplane

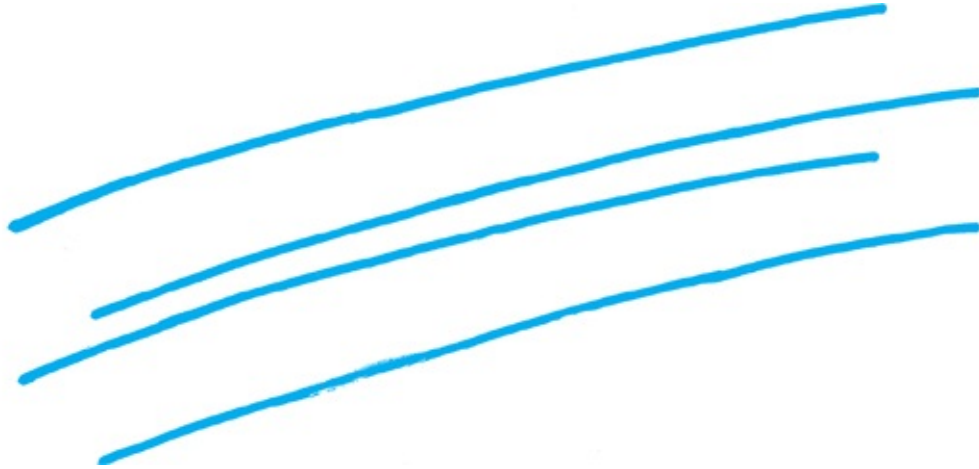

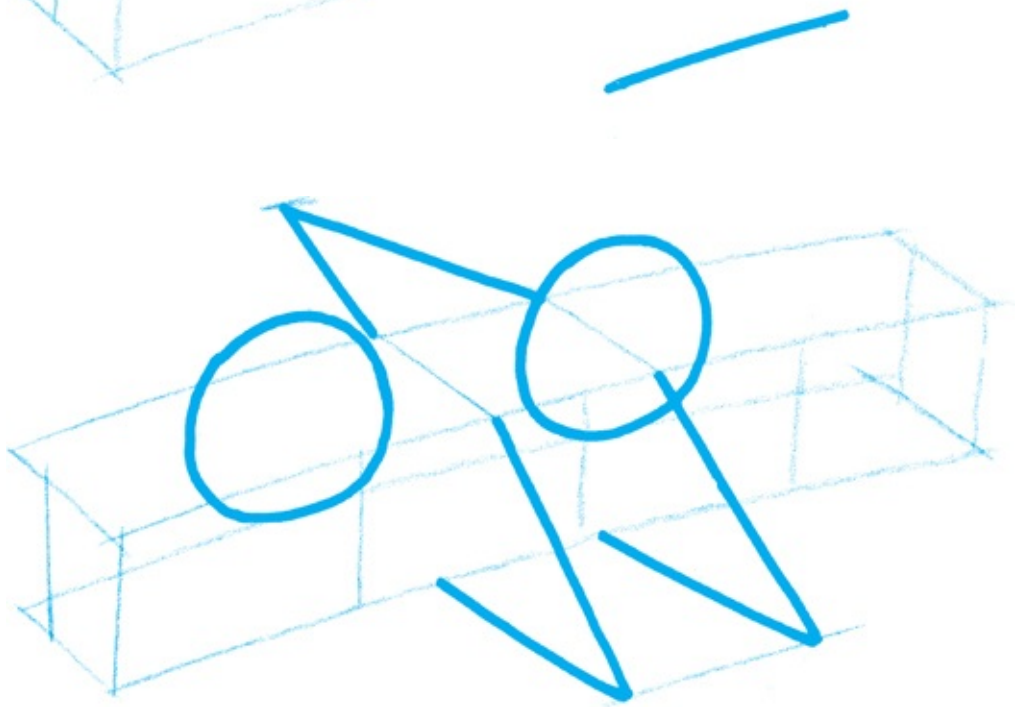
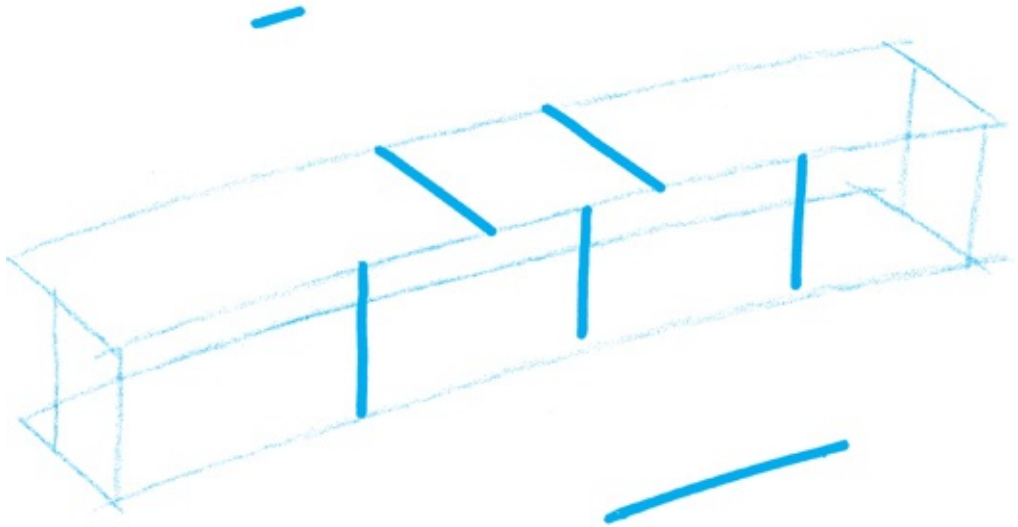

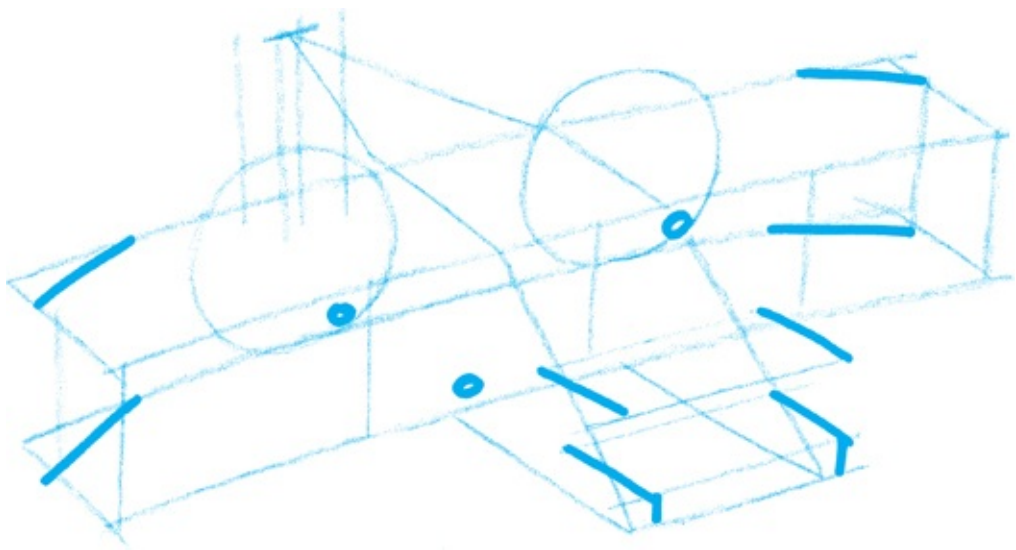
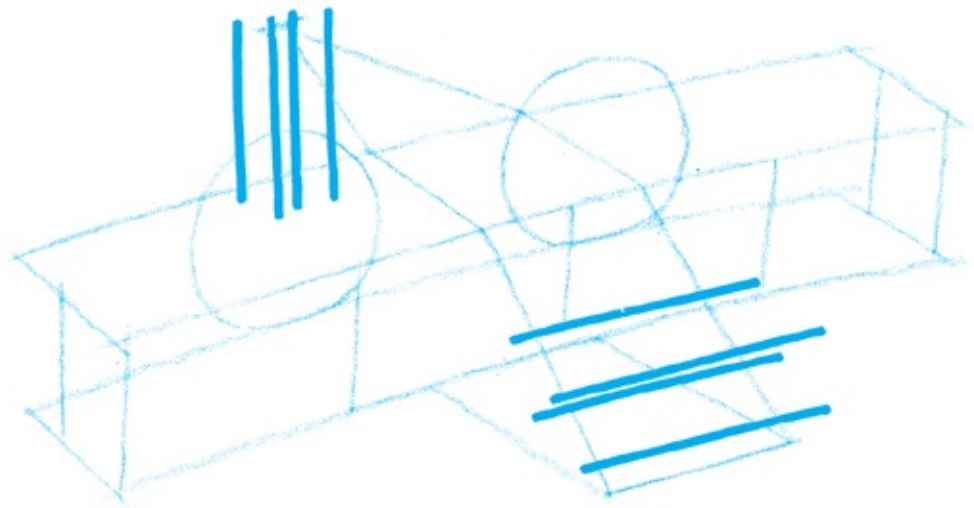

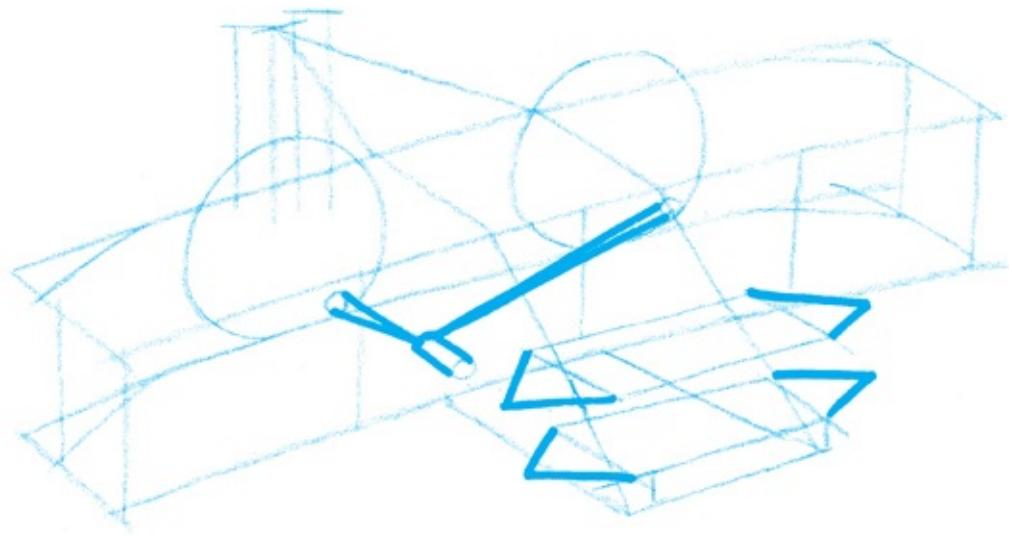

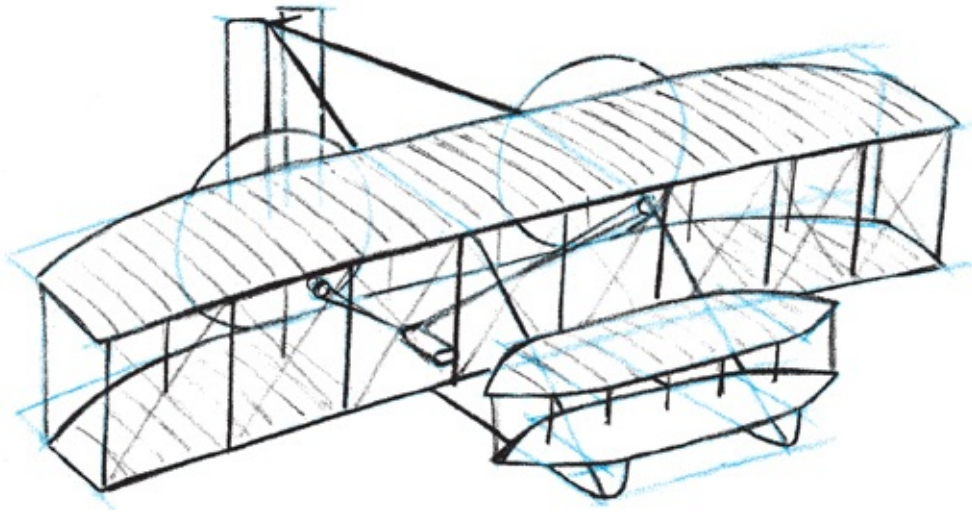

Lee J. Ames began his career at the Walt Disney Studios, working on films that included Fantasia and Pinocchio. He taught at the School of Visual Arts in Manhattan, and at Dowling College on Long Island, New York. An avid worker, Ames directed his own advertising agency, illustrated for several magazines, and illustrated approximately 150 books that range from picture books to postgraduate texts. He resided in Dix Hills, Long Island, with his wife, Jocelyn, until his death in June 2011.

DRAW 50 VEHICLES

Experience All That the Draw 50 Series Has to Offer!

With this proven, step-by-step method, Lee J. Ames has taught millions how to draw everything from amphibians to automobiles. Now it's your turn! Pick up the pencil, get out some paper, and learn how to draw everything under the sun with the Draw 50 series.

Also Available:

- *Draw 50 Airplanes, Aircraft, and Spacecraft* • *Draw 50 Animals*
- *Draw 50 Athletes*
- *Draw 50 Baby Animals*
- *Draw 50 Cars, Trucks, and Motorcycles* • *Draw 50 Flowers, Trees, and Other Plants* • *Draw 50 Sharks, Whales, and Other Sea Creatures*