

tennsco®

Storage Made Easy

Price List

Effective April 2023

Quick ship temporarily unavailable for some items.



PROUDLY MADE IN THE U.S.A.

Quality Built Since 1962

Tennsco, LLC is a family-owned company located in Dickson, TN. Founded in 1962, Tennsco is an industry leader in steel storage solutions. Tennsco is proud to manufacture its products in the USA.

Environmentally Friendly Products

Certified SCS Indoor Advantage Gold for indoor air quality and low VOC emissions.

Tennsco products allow our customers to apply LEED credits as described below:

- MR Credit 4.1 and 4.2 - Recycled Content
- MR Credit 5.1 - Manufactured Regionally
- MR Credit 5.2 - Extracted and Manufactured Regionally
- EQ Credit 4.2 - Low Emitting Materials, Paints



Available Colors

Tennsco products have a tough, long lasting powder coated or electrocoated paint finish. Available standard colors vary by product line. All standard color options are listed at the bottom portion of each page, unless otherwise specified.

Standard Colors are available at no additional charge. Premium and Special Matched Colors are available for an upcharge. Finishes shown are representative of the actual finishes. Please contact your local Tennsco dealer for more precise color swatches.



Items with one of these symbols are part of Tennsco's quick ship program and ship within 2-3 days. Quick ship is subject to maximum order quantities.

Quickship Legend	
◆	- All 5 Standard Colors
♠	- Sand, Medium Grey & Black
♣	- Medium Grey
●	- Black
■	- Sand
▲	- Sand & Medium Grey
§	- Black & Light Grey
▶	- Sand & Light Grey
Ω	- Light Grey
◻	Unfinished
▼	Zinc Plated



Table of Contents

COMMERCIAL

Storage Cabinets	4-10
Bookcases	11
Lateral Files	12-13
Card & Multimedia, Literature Sorters, 30 Drawer Organizers, Fixed Shelf Lateral Files & Fixed Shelf Filing Units	14
Imperial Shelving & Doors	15
Regal, Capstone & Commercial Clip Shelving	16

INDUSTRIAL

Lockers	17-33
Z-Line Boltless Shelving	34-43
Bulk Storage	44-48
Q-Line Industrial Clip Shelving	49-55
L&T Shelving	56-65
Workbenches	66-75
Packing Tables	76

Product dimensions listed throughout are nominal, actual dimensions may vary. For detailed specifications, contact Tennsco. Freight Classifications listed throughout this price list are subject to change.

POLICY AND SERVICES

PRICING: All prices are F.O.B. Tennsco, LLC's Facility in Dickson, Tennessee. All orders are subject to final acceptance at the Home Office, Dickson, Tennessee. Prices subject to change without notice. Tennsco has the right to make product design changes at any time. Tennsco's prices do not include sales, use, excise or similar taxes. Consequently, in addition to the prices specified herein, the amount of any present or future sales, use, excise or similar tax applicable to the manufacture, sale, purchase or use of the goods sold hereunder shall be paid by Buyer. In lieu thereof, Buyer shall provide Tennsco with a tax exemption certificate acceptable to the applicable taxing authorities.

TERMS OF PAYMENT: Terms are Net 30 Days from date of shipment. A service charge of 1 1/2% per month will be charged for overdue invoices.

MINIMUM ORDERS: Minimum order is \$15.00.

SPECIFICATIONS: Tennsco reserves the right to change any product specifications contained in this price list.

FREIGHT CHARGES: All shipments will be made freight collect unless otherwise specified. If freight is paid by Tennsco, it will be added to the invoice or billed separately, depending on arrangements. On shipments by parcel post, the postage will be added to the invoice. All routing will be done solely by the Home Office. If purchaser does not accept delivery of merchandise when ready for shipment, storage fees will be charged to the purchaser.

WEIGHT: Shipping weights shown are approximate.

FREIGHT CLAIMS: Claims for shortages must be made in writing to the Home Office within 5 business days from receipt of shipment. Claims for damaged or lost material must be filed with the carrier.

CAUTION: When you give delivering carrier a clear receipt for a shipment in which there is damaged merchandise or a shortage, the carrier is relieved of further responsibility. Claims for damage or shortage must be filed by you with the delivering carrier. Tennsco will not accept return of merchandise damaged in transit. Your claim is with the delivering carrier.

CANCELLATIONS & RETURNS: No return merchandise will be accepted or approved, based on product, color and quantity, without written consent of the Tennsco General Office, Dickson, Tennessee. If return is approved, all returned shipments are subject to a handling charge of 25% plus all transportation charges incurred by Tennsco unless Tennsco is at fault. Orders for "Special" items are not subject to change, cancellation or return. Once production of "Special" items has begun, cancellation of order is subject to Tennsco approval. A 15% surcharge will be assessed to approved cancelled items.

LIMITED WARRANTY

Tennsco warrants goods purchased hereunder to be free of defects in materials and workmanship for a period of one (1) year from the date of shipment, hereunder. Tennsco's warranty shall not apply in the event goods are damaged as a result of misuse, abuse, neglect, accident, improper application, modification or repair by persons not authorized by Tennsco, where goods are damaged during shipment. UNLESS CONSIDERED UNENFORCEABLE OR UNLAWFUL UNDER APPLICABLE LAW:

- a. ALL IMPLIED WARRANTIES, INCLUDING BUT NOT LIMITED TO WARRANTIES OR MERCHANTABILITY AND FITNESS FOR A PARTICULAR PURPOSE ARE HEREBY EXCLUDED.
- b. BUYERS REMEDY, IF ANY, FOR ANY DEFECTIVE GOODS SHALL BE LIMITED TO A REFUND BY TENNSCO OR REPLACEMENT OF THE GOODS AT TENNSCO'S OPTION AND SHALL IN NO EVENT INCLUDE DAMAGES OF ANY KIND, WHETHER INCIDENTAL, CONSEQUENTIAL OR OTHERWISE.

NO GOODS ACCEPTED FOR RETURN WITHOUT PRIOR APPROVAL. Tennsco shall have the right to inspect any goods claimed to be defective at Buyer's place of business or require Buyer to return the goods to Tennsco for inspection on Tennsco's premises. Transportation charges covering returned goods will be borne by Tennsco only if such goods are proven to be defective, are covered by this warranty and are returned within the warranty period stated above.

Jumbo Cabinets

JUMBO TRADITIONAL CABINETS



J1878SU
Solid Doors



CVDJ2478SU
Clear View Doors



JSD1878SU
Sliding Doors

W	D	H	Shelf Load Cap.*	# of Openings	WELDED			UNASSEMBLED		
					CAT. NO.	WT.	PRICE	CAT. NO.	WT.	PRICE
SOLID DOORS										
48	18	30	400	2	J1830SU	103.0	\$897.00	-	-	-
48	18	42	400	2	J1842SU	121.0	954.00	J1842A	113.0	\$798.00
48	24	42	400	2	J2442SU	135.0	1,002.00	J2442A	121.0	814.00
48	18	78	400	5	J1878SU	203.0	1,366.00	J1878A-N	180.0	1,103.00
48	24	78	400	5	J2478SU	233.0	1,485.00	J2478A-N	208.0	1,185.00
C-THRU DOORS (Electronic Lock Not Available)										
48	18	42	400	2	CVDJ1842SU	121.0	\$1,074.00	-	-	-
48	18	78	400	5	CVDJ1878SU	207.0	1,546.00	CVDJ1878A-N	187.0	\$1,283.00
48	24	78	400	5	CVDJ2478SU	230.0	1,665.00	CVDJ2478A-N	215.0	1,365.00
SLIDING DOORS (Optional Locks/Padlock Hasp Not Available)										
48	21 1/4	78	400	5	JSD1878SU	228.0	\$1,842.00	-	-	-
48	27 1/4	78	400	5	JSD2478SU	258.0	1,960.00	-	-	-

Accessories							
Description	W	D	H	Load Cap.	CAT. NO.	WT.	PRICE
EXTRA SHELVES							
Full Width Shelf	48	18	1 5/16	400	306	10.6	\$69.00
Full Width Shelf	48	24	1 5/16	400	307	14.0	77.00
CASTER KITS							
Fits 48"W x 24"D	48	24	6 11/16	1,000	CK-4824	24.0	\$213.00

*Load Capacities are lbs. per shelf, evenly distributed.

For optional security lock (\$60 List), add suffix "HL" to catalog number.
 For optional electronic lock (\$160 List), add suffix "EL" to catalog number. Only available on select welded units.
 For optional keyed alike lock (\$25 List), add suffix "KA" to catalog number.
 For optional padlock hasp (\$26 List), add suffix "-HSP" to catalog number for welded units. Padlock hasp must be ordered separately under HSP for KD units. Padlock hasp can only be used with solid, double handled doors.

National Motor Freight Class: Welded 175, Unassembled 85

JUMBO WARDROBE CABINETS



J1878SUW
Solid Doors

W	D	H	Shelf Load Cap.*	# of Openings	WELDED			UNASSEMBLED		
					CAT. NO.	WT.	PRICE	CAT. NO.	WT.	PRICE
SOLID DOORS										
48	18	78	400	2	J1878SUW	191.0	\$1,235.00	J1878A-N-W	173.0	\$999.00
48	24	78	400	2	J2478SUW	212.0	1,340.00	J2478A-N-W	199.0	1,058.00

Accessories							
Description	W	D	H	Load Cap.	CAT. NO.	WT.	PRICE
EXTRA SHELVES							
Full Width Shelf	48	18	1 5/16	400	306	10.6	\$69.00
Full Width Shelf	48	24	1 5/16	400	307	14.0	77.00
CASTER KITS							
Fits 48"W x 24"D	48	24	6 11/16	1,000	CK-4824	24.0	\$213.00

*Load Capacities are lbs. per shelf, evenly distributed.

For optional security lock (\$60 List), add suffix "HL" to catalog number.
 For optional electronic lock (\$160 List), add suffix "EL" to catalog number. Only available on select welded units.
 For optional keyed alike lock (\$25 List), add suffix "KA" to catalog number.
 For optional padlock hasp (\$26 List), add suffix "-HSP" to catalog number for welded units. Padlock hasp must be ordered separately under HSP for KD units. Padlock hasp can only be used with solid, double handled doors.



CK-4824
Caster Kit

National Motor Freight Class: Welded 175, Unassembled 85

Standard Colors



Items with these symbols are available to ship in 2-3 days. Limited quantities and select colors.

◆	◆	◆	◆	◆
(SND)	(CPY)	(LGY)	(MGY)	(BLK)
◆	◆	◆	◆	◆
(SND)	(MGY)	(BLK)		

Jumbo and Deluxe Cabinets

JUMBO COMBINATION CABINETS

W	D	H	SHELF CAPACITY*		# of Openings	WELDED			UNASSEMBLED		
			Full Width	Half Width		CAT. NO.	WT.	PRICE	CAT. NO.	WT.	PRICE
SOLID DOORS											
48	18	78	400	75	7	J1878SUC	203.0	\$1,427.00	J1878C-N	193.0	\$1,183.00
48	24	78	400	75	7	J2478SUC ♦	230.0	1,559.00	J2478C-N	213.0	1,271.00

Accessories							
Description	W	D	H	Load Cap.	CAT. NO.	WT.	PRICE
EXTRA SHELVES							
Full Width Shelf	48	18	1 5/16	400	306 ♦	10.6	\$69.00
Full Width Shelf	48	24	1 5/16	400	307 ♦	14.0	77.00
Half Width Shelf	24	16	3/4	75	JPS18	3.9	48.00
Half Width Shelf	24	22	3/4	75	JPS24	5.2	51.00
CASTER KITS							
Fits 48"W x 24"D	48	24	6 11/16	1,000	CK-4824 ♦	24.0	\$213.00

*Load Capacities are lbs. per shelf, evenly distributed.

For optional security lock (\$60 List), add suffix "HL" to catalog number.
 For optional electronic lock (\$160 List), add suffix "EL" to catalog number. Only available on select welded units.
 For optional keyed alike lock (\$25 List), add suffix "KA" to catalog number.
 For optional padlock hasp (\$26 List), add suffix "-HSP" to catalog number for welded units. Padlock hasp must be ordered separately under HSP for KD units. Padlock hasp can only be used with solid, double handled doors.



J1878SUC
Solid Doors

National Motor Freight Class: Welded 175, Unassembled 85

DELUXE TRADITIONAL CABINETS

W	D	H	Shelf Load Cap.*	# of Openings	WELDED			UNASSEMBLED		
					CAT. NO.	WT.	PRICE	CAT. NO.	WT.	PRICE
SOLID DOORS										
36	18	42	200	3	4218DLX •	90.0	\$805.00	1842 ♦	90.0	\$638.00
36	24	42	200	3	4224DLX •	103.0	894.00	2442 ♦	103.0	704.00
36	18	72	200	5	7218DLX ♦	145.0	1,010.00	-	-	-
36	18	78	200	5	7818 ♦	157.0	1,042.00	1870 ♦	154.0	909.00
36	24	78	200	5	7824 ♦	178.0	1,159.00	2470 ♦	168.0	999.00
SOLID DOORS WITH RECESSED HANDLES (Padlock Hasp Not Available)										
36	18	78	200	5	7818RH	157.0	\$1,052.00	1870RH	154.0	\$919.00
36	24	78	200	5	7824RH	175.0	1,169.00	2470RH	168.0	1,009.00
C-THRU DOORS (Electronic Lock Not Available)										
36	18	42	200	3	-	-	-	CVD1842	90.0	\$758.00
36	24	42	200	3	-	-	-	CVD2442	103.0	824.00
36	18	78	200	5	CVD7818	162.0	\$1,192.00	CVD1870	154.0	1,059.00
36	24	78	200	5	CVD7824	194.0	1,309.00	CVD2470	183.0	1,149.00

Accessories							
Description	W	D	H	Load Cap.	CAT. NO.	WT.	PRICE
EXTRA SHELVES							
Full Width Shelf	36	18	1 1/8	200	301 ♦	8.2	\$43.00
Full Width Shelf	36	24	1 1/8	200	302 ♦	10.5	58.00
CASTER KITS							
Fits 36"W x 18"D	36	18	6 11/16	1,000	CK18 ♦	21.0	\$175.00
Fits 36"W x 24"D	36	24	6 11/16	1,000	CK24 ♦	23.0	184.00

*Load Capacities are lbs. per shelf, evenly distributed.

For optional security lock (\$60 List), add suffix "HL" to catalog number.
 For optional electronic lock (\$160 List), add suffix "EL" to catalog number. Only available on select welded units.
 For optional keyed alike lock (\$25 List), add suffix "KA" to catalog number.
 For optional padlock hasp (\$26 List), add suffix "-HSP" to catalog number for welded units. Padlock hasp must be ordered separately under HSP for KD units. Padlock hasp can only be used with solid, double handled doors.



7818
Solid Doors



7824RH
Solid Doors with Recessed Handles



CVD7824
Clear View Doors

National Motor Freight Class: Welded 175, Unassembled 85

Standard Colors



♦ •
 Items with these symbols are available to ship in 2-3 days. Limited quantities and select colors.

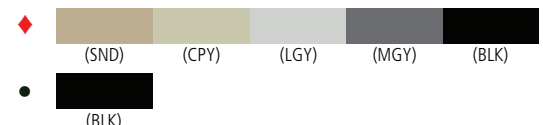

Deluxe Cabinets

DELUXE WARDROBE CABINETS



7818W
Solid Doors

W	D	H	Shelf Load Cap.*	# of Openings	WELDED			UNASSEMBLED		
					CAT. NO.	WT.	PRICE	CAT. NO.	WT.	PRICE
SOLID DOORS										
36	18	78	200	2	7818W ♣	134.0	\$958.00	1871 ♣	140.0	\$810.00
36	24	78	200	2	7824W ♣	154.0	1,041.00	2471 ♣	155.0	965.00
C-THRU DOORS (Electronic Lock Not Available)										
36	18	78	200	2	CVD7818W	140.0	\$1,108.00	CVD1871	140.0	\$960.00
36	24	78	200	2	CVD7824W	164.0	1,191.00	CVD2471	155.0	1,115.00



Accessories							
Description	W	D	H	Load Cap.	CAT. NO.	WT.	PRICE
EXTRA SHELVES							
Full Width Shelf	36	18	1 1/8	200	301♦	8.2	\$43.00
Full Width Shelf	36	24	1 1/8	200	302♦	10.5	58.00
CASTER KITS							
Fits 36"W x 18"D	36	18	6 11/16	1,000	CK18♦	21.0	\$175.00
Fits 36"W x 24"D	36	24	6 11/16	1,000	CK24♦	23.0	184.00

*Load Capacities are lbs. per shelf, evenly distributed.

For optional security lock (\$60 List), add suffix "HL" to catalog number.

For optional electronic lock (\$160 List), add suffix "EL" to catalog number. Only available on select welded units.

For optional keyed alike lock (\$25 List), add suffix "KA" to catalog number.

For optional padlock hasp (\$26 List), add suffix "-HSP" to catalog number for welded units. Padlock hasp must be ordered separately under HSP for KD units. Padlock hasp can only be used with solid, double handled doors.

National Motor Freight Class: Welded 175, Unassembled 85

DELUXE COMBINATION CABINETS



7814
Solid Doors

W	D	H	SHELF CAPACITY*		# of Openings	WELDED			UNASSEMBLED		
			Full Width	Half Width		Cat. No.	Wt.	Price	CAT. NO.	WT.	PRICE
SOLID DOORS											
36	18	78	200	75	7	7814♦	156.0	\$1,112.00	1872♦	152.0	\$960.00
36	24	78	200	75	7	7820♦	178.0	1,219.00	2472♦	181.0	1,038.00
C-THRU DOORS (Electronic Lock Not Available)											
36	18	78	200	75	7	CVD7814	160.0	\$1,262.00	CVD1872	152.0	\$1,110.00
36	24	78	200	75	7	CVD7820	192.0	1,369.00	CVD2472	181.0	1,188.00

Accessories							
Description	W	D	H	Load Cap.	CAT. NO.	WT.	PRICE
EXTRA SHELVES							
Full Width Shelf	36	18	1 1/8	200	301♦	8.2	\$43.00
Full Width Shelf	36	24	1 1/8	200	302♦	10.5	58.00
Half Width Shelf	19	16	3/4	75	304♦	4.0	27.00
Half Width Shelf	19	22	3/4	75	305♦	5.8	33.00
CASTER KITS							
Fits 36"W x 18"D	36	18	6 11/16	1,000	CK18♦	21.0	\$175.00
Fits 36"W x 24"D	36	24	6 11/16	1,000	CK24♦	23.0	184.00

*Load Capacities are lbs. per shelf, evenly distributed.

For optional security lock (\$60 List), add suffix "HL" to catalog number.

For optional electronic lock (\$160 List), add suffix "EL" to catalog number. Only available on select welded units.

For optional keyed alike lock (\$25 List), add suffix "KA" to catalog number.

For optional padlock hasp (\$26 List), add suffix "-HSP" to catalog number for welded units. Padlock hasp must be ordered separately under HSP for KD units. Padlock hasp can only be used with solid, double handled doors.

National Motor Freight Class: Welded 175, Unassembled 85

Standard Colors



♦ ♣
Items with these symbols are available to ship in 2-3 days. Limited quantities and select colors.

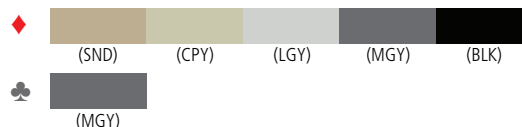

Standard Cabinets

STANDARD TRADITIONAL CABINETS

W	D	H	Shelf Load Cap.*	# of Openings	WELDED			UNASSEMBLED			
					CAT. NO.	WT.	PRICE	CAT. NO.	WT.	PRICE	
SOLID DOORS											
36	18	30	200	2	3018 ♦	58.0	\$530.00	1430 ♦	51.0	\$421.00	
NEW	36	18	36	200	2	3618	70.5	580.00	1436	68.0	494.00
	36	24	36	200	2	3624	72.0	660.00	2436	78.0	538.00
	36	18	42	200	3	4218 ♦	79.0	606.00	1442 ♦	74.0	508.00
	36	24	42	200	3	4224	88.0	679.00	1420	85.0	607.00
	36	18	60	200	5	6018DH ♣	107.0	813.00	-	-	-
	36	24	60	200	5	6024DH ♣	126.0	893.00	-	-	-
	30	15	66	150	5	6615 •	126.0	914.00	-	-	-
	36	18	66	200	5	6618DH ♣	120.0	863.00	-	-	-
	36	24	66	200	5	6624DH ♣	136.0	976.00	-	-	-
NEW	30	15	72	150	5	7215	116.0	737.00	-	-	-
	30	18	72	150	5	721830	123.5	785.00	3070	121.5	729.00
	36	18	72	200	5	7218 ♦	126.0	813.00	1470 ♦	122.0	738.00
	36	24	72	200	5	7224 ♦	143.0	927.00	1480 ♦	139.0	842.00
SOLID DOORS WITH RECESSED HANDLES (Padlock Hasp Not Available)											
	36	18	72	200	5	7218RH	126.0	\$833.00	1470RH	122.0	\$758.00
	36	24	72	200	5	7224RH	143.0	947.00	1480RH	139.0	862.00
C-THRU DOORS (Electronic Lock Not Available)											
	36	18	42	200	3	CVD4218 ♣	82.0	\$726.00	CVD1442	69.0	\$628.00
	36	24	42	200	3	CVD4224	97.0	799.00	CVD1420	84.0	727.00
	36	18	72	200	5	CVD7218 ♣	136.0	943.00	CVD1470	113.0	868.00
	36	24	72	200	5	CVD7224 ♣	153.0	1,057.00	CVD1480	136.0	972.00



7218
Solid Doors



7218RH
Solid Doors with Recessed Handles



CVD4218
Clear View Doors

Accessories							
Description	W	D	H	Load Cap.	CAT. NO.	WT.	PRICE
EXTRA SHELVES							
Full Width Shelf	30	15	1 1/8	150	315	6.1	\$32.00
Full Width Shelf	30	18	1 1/8	150	318	6.8	39.00
Full Width Shelf	36	18	1 1/8	200	301 ♦	8.2	43.00
Full Width Shelf	36	24	1 1/8	200	302 ♦	10.5	58.00
CASTER KITS							
Fits 36"W x 18"D	36	18	6 11/16	1,000	CK18 ♦	21.0	\$175.00
Fits 36"W x 24"D	36	24	6 11/16	1,000	CK24 ♦	23.0	184.00

*Load Capacities are lbs. per shelf, evenly distributed.

For optional security lock (\$60 List), add suffix "HL" to catalog number.

For optional electronic lock (\$160 List), add suffix "EL" to catalog number. Only available on select welded units.

For optional keyed alike lock (\$25 List), add suffix "KA" to catalog number.

National Motor Freight Class: Welded 175, Unassembled 85

STANDARD WARDROBE CABINETS

W	D	H	Shelf Load Cap.*	# of Openings	WELDED			UNASSEMBLED		
					CAT. NO.	WT.	PRICE	CAT. NO.	WT.	PRICE
SOLID DOORS										
36	18	72	200	2	7114 ♣	107.0	\$744.00	1471 ♣	100.0	\$661.00
36	24	72	200	2	7124 ♣	138.0	834.00	-	-	-
C-THRU DOORS (Electronic Lock Not Available)										
36	18	72	200	2	CVD7114	111.0	\$874.00	CVD1471	99.0	\$791.00



7114
Solid Doors

Accessories							
Description	W	D	H	Load Cap.	CAT. NO.	WT.	PRICE
EXTRA SHELVES							
Full Width Shelf	36	18	1 1/8	200	301 ♦	8.2	\$43.00
Full Width Shelf	36	24	1 1/8	200	302 ♦	10.5	58.00
CASTER KITS							
Fits 36"W x 18"D	36	18	6 11/16	1,000	CK18 ♦	21.0	\$175.00
Fits 36"W x 24"D	36	24	6 11/16	1,000	CK24 ♦	23.0	184.00

*Load Capacities are lbs. per shelf, evenly distributed.

For optional security lock (\$60 List), add suffix "HL" to catalog number.

For optional electronic lock (\$160 List), add suffix "EL" to catalog number. Only available on select welded units.

For optional keyed alike lock (\$25 List), add suffix "KA" to catalog number.



CK-18
Caster Kit

National Motor Freight Class: Welded 175, Unassembled 85

Standard Colors



♦ ♣
Items with these symbols are available to ship in 2-3 days. Limited quantities and select colors.

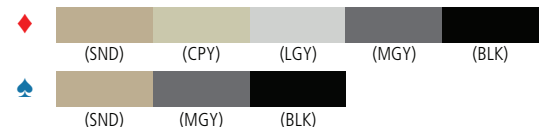

Standard & Specialty Cabinets

STANDARD COMBINATION CABINETS

W	D	H	SHELF CAPACITY*		# of Openings	WELDED			UNASSEMBLED		
			Full Width	Half Width		CAT. NO.	WT.	PRICE	CAT. NO.	WT.	PRICE
SOLID DOORS											
36	24	66	200	75	7	6620DH	135.0	\$1,010.00	-	-	-
36	18	72	200	75	7	7214♦	125.0	861.00	1472♦	123.0	\$774.00
36	24	72	200	75	7	7220♦	143.0	1,013.00	1482♣	149.0	865.00
C-THRU DOORS (Electronic Lock Not Available)											
36	18	72	200	75	7	CVD7214	132.0	\$991.00	CVD1472	112.0	\$904.00
36	24	72	200	75	7	CVD7220	155.0	1,143.00	-	-	-

 7220
 Solid Doors

Accessories							
Description	W	D	H	Load Cap.	CAT. NO.	WT.	PRICE
EXTRA SHELVES							
Full Width Shelf	36	18	1 1/8	200	301♦	8.2	\$43.00
Full Width Shelf	36	24	1 1/8	200	302♦	10.5	58.00
Half Width Shelf	19	16	3/4	75	304♦	4.0	27.00
Half Width Shelf	19	22	3/4	75	305♦	5.8	33.00
CASTER KITS							
Fits 36"W x 18"D	36	18	6 11/16	1,000	CK18♦	21.0	\$175.00
Fits 36"W x 24"D	36	24	6 11/16	1,000	CK24♦	23.0	184.00

*Load Capacities are lbs. per shelf, evenly distributed.

For optional security lock (\$60 List), add suffix "HL" to catalog number.

For optional electronic lock (\$160 List), add suffix "EL" to catalog number. Only available on select welded units.

For optional keyed alike lock (\$25 List), add suffix "KA" to catalog number.

National Motor Freight Class: Welded 175, Unassembled 85

CANTILEVERED BIN STORAGE CABINETS



W	D	H	Bin Rails Included	WELDED		
				CAT. NO.	WT.	PRICE
36	18	78	8	7818BC	216.0	\$1,613.00
36	24	78	8	7824BC	240.0	1,628.00

Accessories						
Description	W	D	H	CAT. NO.	WT.	PRICE
Additional Bin Rails	36	3/4	1 1/2	CBR-36	2.0	\$24.00

Storage bins are not included and are not sold by Tennsco.

Bins may be up to 15" deep in 18"d cabinets, and up to 18" deep in 24"d cabinets.

Bin loaded weights must not exceed 30 lbs per rail.

National Motor Freight Class: 175

SINGLE DOOR CABINET



W	D	H	Load Cap.*	# of Openings	WELDED		
					CAT. NO.	WT.	PRICE
Single Door Cabinet							
19	24	30	75	2	1824♣	53.0	\$545.00
Extra Shelf							
19	24	3/4	75	-	309	5.9	\$47.00

*Load Capacities are lbs. per shelf, evenly distributed.

National Motor Freight Class: 175

Standard Colors



♦ ♣ ♠
 Items with this symbol are available to ship in 2-3 days. Limited quantities and select colors.

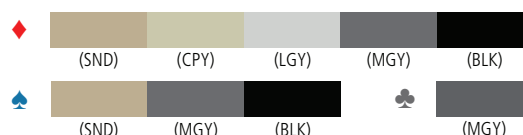

Specialty Cabinets

MOBILE TRADITIONAL CABINETS

WELDED								
W	D	H	Load Cap.*	# of Openings	CAT. NO.	WT.	PRICE	
36	18	36 3/4	200	2	CK3018	79.0	\$643.00	
36	24	36 3/4	200	2	CK3024	85.0	728.00	
36	18	78 3/4	200	5	CK7218	141.0	926.00	
36	24	78 3/4	200	5	CK7224	158.0	1,045.00	
36	18	84 3/4	200	5	CK7818	171.0	1,155.00	
36	24	84 3/4	200	5	CK7824	190.0	1,277.00	

Accessories								
Description	W	D	H	Load Cap.*	CAT. NO.	WT.	PRICE	
EXTRA SHELVES								
Full Width Shelf	36	18	1 1/8	200	301♦	8.2	\$43.00	
Full Width Shelf	36	24	1 1/8	200	302♦	10.5	58.00	

*Load Capacities are lbs. per shelf, evenly distributed.

National Motor Freight Class: 175



LAPTOP/TABLET CHARGING STATIONS

WELDED								
W	D	H	Mobile?	# of Openings	CAT. NO.	WT.	PRICE	
42" HIGH CABINET WITH 16 CHARGING STATIONS								
36	24	42	No	17	4224-CMP	97.0	\$1,710.00	
36	24	48 3/4	Yes	17	4224-CMPM	118.0	1,926.00	
72" HIGH CABINET WITH 32 CHARGING STATIONS								
36	24	72	No	33	7224-CMP	282.0	\$3,099.00	
36	24	78 3/4	Yes	33	7224-CMPM	303.0	3,319.00	

Power outlets must only be used for charging low-amperage devices (such as laptop computers, notebooks, tablets, etc.) to prevent power overload. Maximum amp load is 15 amps per 16-outlet strip.

Welded, set-up units. 72" high units include a center pull-out reference shelf.

Mobile units include two swivel and two fixed casters.

National Motor Freight Class: 175



CABINETS WITH PERFORATED DOORS

WELDED								
W	D	H	Shelf Load Cap.*	# of Openings	CAT. NO.	WT.	PRICE	
STANDARD CABINETS WITH PERFORATED DOORS								
36	18	72	200	5	7218-PD	125.0	\$833.00	
36	24	72	200	5	7224-PD	142.0	947.00	
JUMBO CABINETS WITH PERFORATED DOORS								
48	18	78	400	5	J1878SU-PD	201.0	\$1,386.00	
48	24	78	400	5	J2478SU-PD	231.0	1,505.00	

*Load Capacities are lbs. per shelf, evenly distributed.

National Motor Freight Class: 175



Standard Colors



♦ Items with this symbol are available to ship in 2-3 days. Limited quantities and select colors.

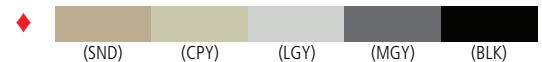

Specialty Cabinets

JANITORIAL CABINET



W	D	H	Shelf Load Cap.*	# of Openings	WELDED		
					CAT. NO.	WT.	PRICE
36	18	64	75	4	JAN6618DH♦	99.0	\$891.00

*Load Capacities are lbs. per shelf, evenly distributed.
Cabinet is fully welded. Shelves do not adjust.

For optional security lock (\$60 List), add suffix "HL" to catalog number.
For optional electronic lock (\$160 List), add suffix "EL" to catalog number. Only available on select welded units.
For optional keyed alike lock (\$25 List), add suffix "KA" to catalog number.
For optional padlock hasp (\$26 List), add suffix "-HSP" to catalog number for welded units. Padlock hasp must be ordered separately under HSP for KD units. Padlock hasp can only be used with solid, double handled doors.

National Motor Freight Class: 175

STORAGE CABINET/BOOKCASE COMBINATION



W	D	H	Shelf Load Cap.*	# of Openings	WELDED		
					CAT. NO.	WT.	PRICE
36	18	72	200	5	BCD18-72♦	122.0	\$875.00
EXTRA SHELF							
36	18	1 1/8	200	-	301♦	8.2	\$43.00

*Load Capacities are lbs. per shelf, evenly distributed.

National Motor Freight Class: 175

STORAGE CABINET WITH FILE DRAWERS



W	D	H	Shelf Load Cap.*	# of Openings	WELDED		
					CAT. NO.	WT.	PRICE
WITH ONE BOTTOM FILE DRAWER							
36	18	42	200	2	DWR-4218♣	94.0	\$978.00
36	18	66	200	4	DWR-6618♣	135.0	1,183.00
WITH TWO BOTTOM FILE DRAWERS							
36	18	72	200	3	DWR-7218-2	150.0	\$1,713.00

Accessories**							
Description	W	D	H	CAT. NO.	WT.	PRICE	
Cross Rods (Pair)	15 3/4	1 7/16	7/8	15CR	1.0	\$13.00	

*Load Capacities are lbs. per shelf, evenly distributed.

**Cross Rods (15CR) only available in Black.

Load capacities up to 120 lbs. per drawer.

All units are setup. Lateral drawers ship standard with file rods for side-to-side filing applications. For front-to-back filing, drawers will accommodate two rows of letter-sized or legal-sized files. This requires one pair of cross rods (15CR) per drawer.

Same key opens both the cabinet lock and the drawer lock.

Can not be used with caster kits.

National Motor Freight Class: 175

Standard Colors



♦ ♣
Items with these symbols are available to ship in 2-3 days. Limited quantities and select colors.

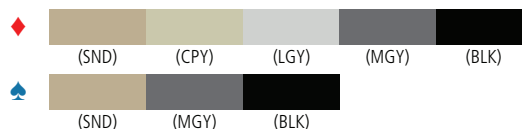

Welded Bookcases

WELDED BOOKCASES — 13 1/2" DEEP

CAT. NO.	NO. OF OPENINGS	W	D	H	WT.	PRICE
34 1/2" Wide Bookcases						
B-30♦	2	34 1/2	13 1/2	28	40.0	\$291.00
B-42♦	3	34 1/2	13 1/2	40	57.0	358.00
B-53♦	4	34 1/2	13 1/2	52	70.0	458.00
B-66♦	5	34 1/2	13 1/2	66	90.0	539.00
B-78♦	6	34 1/2	13 1/2	78	105.0	605.00
Extra Shelf for 34 1/2" Wide						
B-345♦	—	34 1/2	13 1/2	1	7.6	\$41.00



National Motor Freight Class: 175

13 1/2" depth is ideal for storing books and standard sized binders.
Shelf capacities up to 130 lbs. per shelf, evenly distributed

WELDED BOOKCASES — 18" DEEP

CAT. NO.	NO. OF OPENINGS	W	D	H	WT.	PRICE
18" Deep Bookcases						
BC18-30●	2	36	18	30	47.0	\$451.00
BC18-42●	3	36	18	43	66.0	511.00
BC18-52●	4	36	18	55	80.0	692.00
BC18-72●	5	36	18	72	107.0	792.00
BC18-84●	6	36	18	84	122.0	819.00
Extra Shelf						
BC18-SHELF♦	—	36	18	1 1/8	8.2	\$43.00
18" Deep Mobile Bookcases						
BC18-30M	2	36	18	36 1/2	68.0	\$564.00
BC18-42M	3	36	18	49 1/2	81.0	625.00
BC18-52M	4	36	18	61 1/2	101.0	805.00
BC18-72M	5	36	18	78 1/2	118.0	906.00
Laminate Top*						
LT-3618		36	18	5/8	15.0	\$106.00

*Laminate Top available in Sable Oak finish.



National Motor Freight Class: 175

Great for storing items with a larger profile; also has a raised base and can be fitted with casters for mobility.
Shelf capacities up to 150 lbs. per shelf, evenly distributed

BOOK SUPPORTS

CAT. NO.	W	D	H	WT.	PRICE
BSN6	4 1/2	1 3/4	6	0.6	\$11.50
BSN9	4 1/2	1 3/4	9	1.1	14.00

Sold individually, not as pairs.

National Motor Freight Class: 85

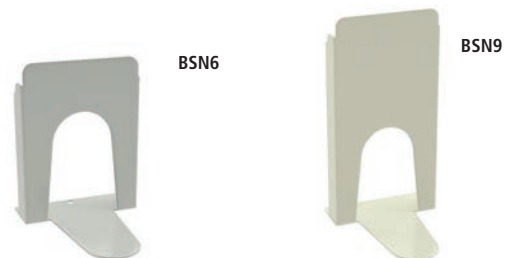

Standard Colors



♦ ●
Items with these symbols are available to ship in 2-3 days. Limited quantities and select colors.

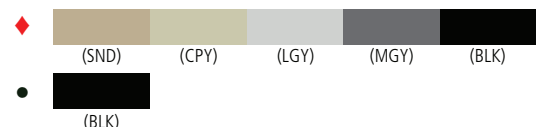

Product Specifications

- Full suspension drawers feature three-member, steel ball-bearing suspensions with a limited lifetime warranty.
- Standard dual-point gang lock with safety interlock system.
- One label holder per drawer.
- Four adjustable steel leveling glides.
- All drawers and shelves equipped with standard hanging folder rods for side-to-side letter or legal filing. For filing front-to-back, order cross rods (15CR).

TWO DRAWER LATERAL FILES



National Motor Freight Class: 175

CAT. NO.	DESCRIPTION	W	D	H	WT.	PRICE
LPL3624L20	• 36" File, Fixed Drawer Fronts	36	17 15/16	27 9/16	108.0	\$1,109.00
LPL3624L21	36" File, Retractable Doors	36	17 15/16	27 9/16	112.0	1,250.00
LPL4224L20	• 42" File, Fixed Drawer Fronts	42	17 15/16	27 9/16	120.0	1,214.00
LPL4224L21	42" File, Retractable Doors	42	17 15/16	27 9/16	124.0	1,369.00

NOTE: Tennsco recommends the use of a counterweight (to counterbalance the weight of an open drawer) in all free-standing two-drawer files. To order a counterweight on any lateral file, add a "W" to the model number. Example: LPL3624L20W. Price listed on page 17.

THREE DRAWER LATERAL FILES



National Motor Freight Class: 175

CAT. NO.	DESCRIPTION	W	D	H	WT.	PRICE
LPL3636L30	• 36" File, Fixed Drawer Fronts	36	17 15/16	39 3/8	145.0	\$1,462.00
LPL3636L31	36" File, Retractable Doors	36	17 15/16	39 3/8	151.0	1,688.00
LPL4236L30	42" File, Fixed Drawer Fronts	42	17 15/16	39 3/8	160.0	1,616.00
LPL4236L31	42" File, Retractable Doors	42	17 15/16	39 3/8	166.0	1,848.00

FOUR DRAWER LATERAL FILES



National Motor Freight Class: 175

CAT. NO.	DESCRIPTION	W	D	H	WT.	PRICE
LPL3648L40	36" File, Fixed Drawer Fronts	36	17 15/16	51 1/4	184.0	\$1,826.00
LPL3648L41	36" File, Retractable Doors	36	17 15/16	51 1/4	192.0	2,125.00
LPL4248L40	• 42" File, Fixed Drawer Fronts	42	17 15/16	51 1/4	206.0	1,952.00
LPL4248L41	42" File, Retractable Doors	42	17 15/16	51 1/4	215.0	2,295.00

FIVE DRAWER LATERAL FILES



National Motor Freight Class: 175

CAT. NO.	DESCRIPTION	W	D	H	WT.	PRICE
LPL3660L50	• 36" File, Combination Unit*	36	17 15/16	65	227.0	\$2,297.00
LPL3660L51	36" File, Retractable Doors	36	17 15/16	65	239.0	2,597.00
LPL4260L50	42" File, Combination Unit*	42	17 15/16	65	262.0	2,457.00
LPL4260L51	42" File, Retractable Doors	42	17 15/16	65	270.0	2,800.00

*Top openings is a retractable roll-out drawer; four bottom openings are solid-front doors. For optional Posting Shelf, located 36" from the floor, add a "P" to the end of the model number and add \$85 to the list price. Example: L4260L50P.

Standard Colors



• Items with this symbol are available to ship in 2-3 days. Limited quantities and select colors.

• (BLK)

FILING SYSTEMS

Lateral Files, Overfiles & Accessories

Inside Drawer Dimensions	File	Width	Depth	Height
12" high drawer with retractable door	30"	27 ¹ / ₄ "	15 ⁷ / ₁₆ "	10 ⁷ / ₁₆ "
	36"	33 ¹ / ₄ "	15 ⁷ / ₁₆ "	10 ⁷ / ₁₆ "
	42"	39 ¹ / ₄ "	15 ⁷ / ₁₆ "	10 ⁷ / ₁₆ "
12" high drawer with fixed front	30"	27 ¹ / ₄ "	15 ⁷ / ₁₆ "	11 ¹ / ₈ "
	36"	33 ¹ / ₄ "	15 ⁷ / ₁₆ "	11 ¹ / ₈ "
	42"	39 ¹ / ₄ "	15 ⁷ / ₁₆ "	11 ¹ / ₈ "

- Locks**
- One key unlocks all drawers at once.
 - Locks are core-removable.
 - Locks are keyed randomly. For keyed alike, add suffix "-KA" to model number.
 - Lateral Files and Card Files can be keyed alike if desired.

Installation guidelines
Installation and safety instructions are located in top drawer of all lateral files.

Counterweights: To order a factory installed counterweight on any lateral file, add a "W" to the model number. Refer to "Counterweights" chart on p.17 for added cost.

SIX DRAWER LATERAL FILES

CAT. NO.	DESCRIPTION	W	D	H	WT.	PRICE
LPL3672L60	36" File, Combination Units*	36	17 15 ¹ / ₁₆	76 7 ⁷ / ₈	227.0	\$2,729.00
LPL3672L61	36" File, Retractable Doors	36	17 15 ¹ / ₁₆	76 7 ⁷ / ₈	286.0	3,009.00
LPL4272L60	42" File, Combination Units*	42	17 15 ¹ / ₁₆	76 7 ⁷ / ₈	293.0	2,960.00
LPL4272L61	42" File, Retractable Doors	42	17 15 ¹ / ₁₆	76 7 ⁷ / ₈	325.0	3,298.00

*Top two openings are retractable roll-out drawers; four bottom openings are solid-front doors.



FILING SYSTEMS

National Motor Freight Class: 175

OVERFILES

CAT. NO.	W	D	H	WT.	PRICE
Double Level					
L3620F	36	18	27 1/2	76.0	\$928.00
L4220F	42	18	27 1/2	89.0	1,067.00

Can be attached to top of lateral files.



L3620F

National Motor Freight Class: 175

LAMINATE TOPS

CAT. NO.	W	D	H	WT.	PRICE
T1836♥	36	18	1 1/16	23.0	\$329.00
T1842♥	42	18	1 1/16	26.0	421.00

When ordering laminate tops, specify Oak (L006), Mahogany (L005) or Titanium (TTM).



National Motor Freight Class: 70

COUNTERWEIGHTS

CAT. NO.	W	D	H	WT.	PRICE
For 2-Drawer Files					
T36CW-4	34 5/8	—	10 1/2	41.0	\$167.00
T42CW-4	40 5/8	—	10 1/2	47.0	195.00
For 3, 4 and 5-Drawer Files					
T36CW-2	34 5/8	—	10 1/2	20.0	\$91.00
T42CW-2	40 5/8	—	10 1/2	24.0	104.00

Used to counterbalance the weight of an open drawer. Attaches to bottom rear of cabinet. Recommended for use with all free standing two-drawer files.



May be pre-installed at factory.

Available in black only. National Motor Freight Class: 70

CROSS RODS & DIVIDERS

CAT. NO.	W	D	H	WT.	PRICE
Cross Rods (pair)					
15CR●	15 3/4	1 7/8	7/8	1.0	\$13.00
Dividers					
5AD●	—	13 1/2	6 3/16	0.7	\$7.40

Cross rods are used in conjunction with hanging folder rods to file front-to-back. Dividers are used to separate file folders when hanging folder rods are not used.



Available in black only. National Motor Freight Class: 70

Standard Colors (Unless Otherwise Specified)



Items with these symbols are available to ship in 2-3 days. Limited quantities and select colors.

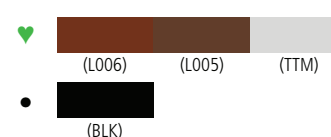

CARD & MULTIMEDIA FILES



CF-669

CF-758

CF-846

Card files come standard with one center partition and two follower blocks. Units come standard with four levelers for uneven floors.

National Motor Freight Class: 175

CAT. NO.	NO. OF DRAWERS	W	D	H	WT.	PRICE
Card Files						
CF-669	6	21	28	52 3/8	214.0	\$2,246.00
CF-758	7	19	28	52 3/8	220.0	2,337.00
CF-846	8	15	28	52 3/8	216.0	2,444.00
Extra Center Partition						
CF-DIV	(Available in Black Only)				1.0	\$25.00
Extra Follower Block						
CF-BLK1	(For all sizes except CF-669)				0.5	\$5.30
CF-BLK2	(For CF-669 only)				0.5	7.60

STORAGE CAPACITIES FOR VARIOUS MEDIA					
CAT. NO.	CARDS (Sizes)	CDs (Cap.)	CDs (Standard)	CDs (Slimline)	DVD/Blu-Rays (Movie Case)
CF-669	6x9	32,600			504**
CF-758	5x8	38,100	896*	1680*	588
CF-846	3x5; 4x6	43,400	1024	1920	

*Removing center partition increases this number by 1/3.

**DVD/Blu-Rays fit securely when a second center partition (CF-DIV) is inserted.

LITERATURE SORTERS



Letter Size (4075)

Legal Size (5075)

National Motor Freight Class: 100

CAT. NO.	W	D	H	WT.	PRICE
Letter Size					
4075♦	30 5/8	11 5/8	33	70.0	\$697.00
Extra Shelf (Pack of 5)					
4005♦	9	11	—	6.4	\$32.00
Legal Size					
5075♦	30 5/8	14 5/8	33	89.0	\$767.00
Extra Shelf (Pack of 5)					
5005♦	9	14	—	8.1	\$39.00

Comes standard with 18 shelves (to make 21 openings).

Shelves are adjustable on 1-1/2" centers. Same-depth units can be double-stacked.

THIRTY DRAWER ORGANIZERS

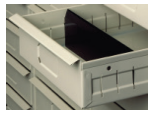

Drawer with
Optional Divider

*Dividers available in Black only.



Letter Size (2085)



Legal Size (3085)

CAT. NO.	W	D	H	WT.	PRICE
Letter Size					
2085♦	30 5/8	11 5/8	33	95.0	\$998.00
Legal Size					
3085♦	30 5/8	14 5/8	33	112.0	\$1,067.00
Optional Dividers (Pack of 30)*					
30AD●	9 1/16	—	2 11/32	6.7	\$80.00

Inside Drawer Dimensions (WxDxH): Letter Size: 9 x 11 1/4 x 2 3/4 Legal Size: 9 x 14 1/4 x 2 3/4

Same-depth units can be double-stacked.

National Motor Freight Class: 100

FIXED SHELF LATERAL FILES



Closed Unit

Open Unit

All closed units have doors with long-pull handles and single lock secures all doors.
National Motor Freight Class: 100

CAT. NO.	NO. OF OPENINGS	W	D	H	WT.	PRICE
Open Units						
FS350\$	5	36	17	63 1/2	124.0	\$1,305.00
FS360\$	6	36	17	75 1/4	150.0	1,429.00
FS370\$	7	36	17	87	175.0	1,613.00
Closed Units						
FS351L\$	5	36	17	63 1/2	180.0	\$2,204.00
FS361L\$	6	36	17	75 1/4	218.0	2,559.00
FS371L\$	7	36	17	87	242.0	2,873.00
Extra Divider						
FD-1108\$	—	—	11	8	0.8	\$5.00

Comes standard with four steel dividers per shelf level; dividers match cabinet color.
Equipped with shelf-modifier rod to accommodate both letter and legal filing.

FIXED SHELF FILE



Optional Posting Shelf

CAT. NO.	NO. OF OPENINGS	W	D	H	WT.	PRICE
Open Units						
FSF-78♦	7	34 1/2	13 1/2	78	117.0	\$994.00
Optional Posting Shelf						
FSFRS-1	—	30	12	1 1/2	8.6	\$108.00
Extra Divider						
PD-1108\$	—	—	11	8	0.4	\$5.00

Comes standard with four plastic dividers per shelf level.

National Motor Freight Class: 85

Standard Colors



♦ ● §
Items with these symbols are available to ship in 2-3 days. Limited quantities and select colors.

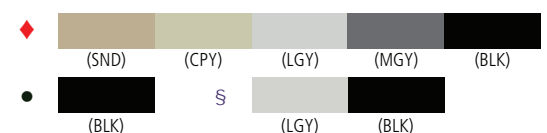

CAT. NO.	NO. OF OPENINGS	W	D	H	WT.	PRICE
Single Entry Units						
Starter Units						
1276PC	6	36	12	76	117.0	\$714.00
127648PC	6	48	12	76	140.0	818.00
1576PC	6	36	15	76	125.0	799.00
1288PC	7	36	12	88	133.0	816.00
128848PC	7	48	12	88	156.0	918.00
1588PC	7	36	15	88	145.0	911.00
Adder Units						
1276AC	6	36	12	76	108.0	\$666.00
127648AC	6	48	12	76	130.0	755.00
1576AC	6	36	15	76	114.0	746.00
1288AC	7	36	12	88	125.0	743.00
128848AC	7	48	12	88	147.0	853.00
1588AC	7	36	15	88	132.0	841.00
Double Entry Units						
Starter Units						
2476PC	12	36	24	76	199.0	\$1,076.00
247648PC	12	48	24	76	247.0	1,257.00
3076PC	12	36	30	76	220.0	1,190.00
2488PC	14	36	24	88	229.0	1,202.00
248848PC	14	48	24	88	286.0	1,431.00
3088PC	14	36	30	88	256.0	1,335.00
Adder Units						
2476AC	12	36	24	76	177.0	\$985.00
247648AC	12	48	24	76	222.0	1,180.00
3076AC	12	36	30	76	205.0	1,148.00
2488AC	14	36	24	88	203.0	1,113.00
248848AC	14	48	24	88	257.0	1,347.00
3088AC	14	36	30	88	225.0	1,230.00
Reference Shelf						
RSMB-12	—	30	12	5/8	9.3	\$98.00
RSMB-15	—	30	15	5/8	9.7	100.00
RSMB-24	—	30	24	5/8	10.8	108.00
RSMB-30	—	30	30	5/8	11.6	112.00
Extra Shelf Kit						
ISK-3612	—	36	12	—	13.0	\$77.00
ISK-3615	—	36	15	—	14.1	88.00
ISK-4812	—	48	12	—	18.8	92.00
ISK-3624	—	36	24	—	24.0	109.00
ISK-3630	—	36	30	—	25.0	133.00
ISK-4824	—	48	24	—	30.0	150.00

National Motor Freight Class: 70

IMPERIAL SHELVING



Single Entry Unit, 88" Tall



Single Entry Unit, 76" Tall

Single entry units include 5 dividers and one backstop per level



Double Entry Unit, 88" Tall



Double Entry Unit, 76" Tall

Double entry units include 10 dividers and one center stop per level

Double entry units shipped in two cartons. All units have closed upright panels. Plastic feet included to protect carpet. No special tools required for assembly.

National Motor Freight Class: 70

DOORS & BACKS FOR IMPERIAL SHELVING



Hinged Door

(adds 2 3/4" to outside depth of unit, including handles; frame uses 1/2" vertical filing space)

CAT. NO.	W	D	H	WT.	PRICE
Hinged Doors With Extended Frames					
LTHD-3676RHD	36	2 1/4	76	60.0	\$865.00
LTHD-4876RHD	48	2 1/4	76	86.0	1,113.00
LTHD-3688RHD	36	2 1/4	88	68.0	838.00
LTHD-4888RHD	48	2 1/4	88	89.0	1,189.00
Two Piece Back (to enclose units with doors)					
LTBP-3676-2	36	—	76	18.6	\$227.00
LTBP-4876-2	48	—	76	21.0	291.00
LTBP-3688-2	36	—	88	25.0	251.00
LTBP-4888-2	48	—	88	29.0	322.00

† All doors come standard with lock, in compliance with Health Insurance Portability and Accountability Act of 1996 (HIPAA) regulations.

National Motor Freight Class: 70

Standard Colors



Items with these symbols are available to ship in 2-3 days. Limited quantities and select colors.



REGAL SHELVING



CAT. NO.	NO. OF OPENINGS	W	D	H	SHELF CAPACITY	WT.	PRICE
Starter Units							
RGL-1836S	5	36	18	76	500	104.0	\$458.00
Adder Units							
RGL-1836A	5	36	18	76	500	100.0	\$413.00

Color: Sand only with Oak woodgrain particleboard shelf.
Completely boltless assembly; only rubber mallet needed for assembly.
Plastic feet included to protect carpets.
National Motor Freight Class: 70

CAPSTONE SHELVING



Color: Medium Grey only.
National Motor Freight Class: 70

CAT. NO.	NO. OF OPENINGS	W	D	H	WT.	PRICE	CAT. NO.	SHELF CAPACITY	WT.	PRICE
Starter Units						Extra Shelves				
CS187636-MGY	4	36	18	76	105.0	\$606.00	CESL-3618-MGY	500	12.0	\$84.00
CS187642-MGY	4	42	18	76	114.0	\$655.00	CESL-4218-MGY	500	13.0	\$91.00
CS187648-MGY	4	48	18	76	122.0	\$697.00	CESL-4818-MGY	350	17.0	\$98.00
CS247636-MGY	4	36	24	76	123.0	\$636.00	CESL-3624-MGY	400	14.0	\$85.00
CS247642-MGY	4	42	24	76	134.0	\$717.00	CESL-4224-MGY	500	16.0	\$104.00
CS247648-MGY	4	48	24	76	144.0	\$745.00	CESL-4824-MGY	450	20.0	\$127.00
CS188836-MGY	5	36	18	88	110.0	\$613.00	CESL-3618-MGY	500	12.0	\$84.00
CS188842-MGY	5	42	18	88	119.0	\$657.00	CESL-4218-MGY	500	13.0	\$91.00
CS188848-MGY	5	48	18	88	127.0	\$704.00	CESL-4818-MGY	350	17.0	\$98.00
CS248836-MGY	5	36	24	88	130.0	\$685.00	CESL-3624-MGY	400	14.0	\$85.00
CS248842-MGY	5	42	24	88	141.0	\$777.00	CESL-4224-MGY	500	16.0	\$104.00
CS248848-MGY	5	48	24	88	151.0	\$806.00	CESL-4824-MGY	450	20.0	\$127.00
Adder Units						Extra Shelves				
CA187636-MGY	4	36	18	76	85.0	\$515.00	CESL-3618-MGY	500	12.0	\$84.00
CA187642-MGY	4	42	18	76	94.0	\$559.00	CESL-4218-MGY	500	13.0	\$91.00
CA187648-MGY	4	48	18	76	102.0	\$599.00	CESL-4818-MGY	350	17.0	\$98.00
CA247636-MGY	4	36	24	76	100.0	\$560.00	CESL-3624-MGY	400	14.0	\$85.00
CA247642-MGY	4	42	24	76	111.0	\$634.00	CESL-4224-MGY	500	16.0	\$104.00
CA247648-MGY	4	48	24	76	121.0	\$672.00	CESL-4824-MGY	450	20.0	\$127.00
CA188836-MGY	5	36	18	88	95.0	\$531.00	CESL-3618-MGY	500	12.0	\$84.00
CA188842-MGY	5	42	18	88	104.0	\$574.00	CESL-4218-MGY	500	13.0	\$91.00
CA188848-MGY	5	48	18	88	112.0	\$616.00	CESL-4818-MGY	350	17.0	\$98.00
CA248836-MGY	5	36	24	88	111.0	\$602.00	CESL-3624-MGY	400	14.0	\$85.00
CA248842-MGY	5	42	24	88	122.0	\$694.00	CESL-4224-MGY	500	16.0	\$104.00
CA248848-MGY	5	48	24	88	132.0	\$720.00	CESL-4824-MGY	450	20.0	\$127.00

COMMERCIAL CLIP SHELVING PACKAGE



Open-Style



Closed-Style

Color: Medium Grey only.
Individually cartoned.
National Motor Freight classification: Class 70

CAT. NO.	NO. OF OPENINGS	W	D	H	SHELF CAPACITY	WT.	PRICE
Open-Style Shelving Units							
ESP-1236♣	4	36	12	75	250	48.0	\$287.00
ESP-1836♣	4	36	18	75	250	61.0	\$342.00
ESP-2436♣	4	36	24	75	250	73.0	\$430.00
ESP-6-1236♣	5	36	12	75	250	53.0	\$316.00
ESP-6-1836♣	5	36	18	75	250	68.0	\$377.00
ESP-6-2436♣	5	36	24	75	250	77.0	\$462.00
Closed-Style Shelving Units							
ESPC-1236♣	4	36	12	75	250	72.0	\$483.00
ESPC-1836♣	4	36	18	75	250	94.0	\$512.00
ESPC-2436♣	4	36	24	75	250	112.0	\$606.00
ESPC-6-1236♣	5	36	12	75	250	78.0	\$505.00
ESPC-6-1836♣	5	36	18	75	250	108.0	\$557.00
ESPC-6-2436♣	5	36	24	75	250	121.0	\$650.00
Extra Shelves*							
ES-12♣	-	36	12	1	250	6.0	\$35.00
ES-18♣	-	36	18	1	250	8.2	\$42.00
ES-24♣	-	36	24	1	250	10.8	\$53.00

*Shelves packaged as pairs; priced per shelf.

Standard Colors (Unless Otherwise Specified)

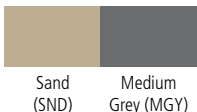

Items with these symbols are available to ship in 2-3 days. Limited quantities and select colors.

Single Tier Lockers

† Welded frames are riveted to welded locker body.

SINGLE TIER LOCKERS WITH LEGS

WELDED†			UNASSEMBLED			DIMENSIONS						
CATALOG NUMBER	UNIT WEIGHT	UNIT PRICE	CATALOG NUMBER	UNIT WEIGHT	UNIT PRICE	OPEN-INGS	OPENING			OVERALL UNIT		
							W	D	H	W	D	H
STS-121260-1	52	\$539.00	STK-121260-1	51	\$452.00	1	12	12	60	12	12	66
STS-121260-3	132	1,266.00	STK-121260-3	130	1,142.00	3	12	12	60	36	12	66
STS-121560-1	55	562.00	STK-121560-1	54	480.00	1	12	15	60	12	15	66
STS-121560-3	140	1,302.00	STK-121560-3	137	1,193.00	3	12	15	60	36	15	66
STS-121860-1	59	586.00	STK-121860-1	58	511.00	1	12	18	60	12	18	66
STS-121860-3	150	1,393.00	STK-121860-3	147	1,248.00	3	12	18	60	36	18	66
STS-151560-1	55	619.00	-	-	-	1	15	15	60	15	15	66
STS-151560-3	140	1,444.00	-	-	-	3	15	15	60	45	15	66
STS-151860-1	60	641.00	-	-	-	1	15	18	60	15	18	66
STS-151860-3	150	1,515.00	-	-	-	3	15	18	60	45	18	66
STS-121272-1	61	\$589.00	STK-121272-1	60	\$507.00	1	12	12	72	12	12	78
STS-121272-3	156	1,384.00	STK-121272-3	153	1,213.00	3	12	12	72	36	12	78
STS-121572-1▲	65	615.00	STK-121572-1	63	494.00	1	12	15	72	12	15	78
STS-121572-3▲	164	1,410.00	STK-121572-3	161	1,232.00	3	12	15	72	36	15	78
STS-121872-1▲	69	634.00	STK-121872-1♣	68	509.00	1	12	18	72	12	18	78
STS-121872-3▲	173	1,463.00	STK-121872-3♣	170	1,300.00	3	12	18	72	36	18	78
STS-151572-1▲	70	679.00	STK-151572-1	69	592.00	1	15	15	72	15	15	78
STS-151572-3▲	179	1,563.00	STK-151572-3	176	1,424.00	3	15	15	72	45	15	78
STS-151872-1▲	76	679.00	STK-151872-1♣	74	544.00	1	15	18	72	15	18	78
STS-151872-3▲	196	1,588.00	STK-151872-3♣	192	1,424.00	3	15	18	72	45	18	78
STS-152172-1	81	766.00	STK-152172-1	80	729.00	1	15	21	72	15	21	78
STS-152172-3	207	1,692.00	STK-152172-3	203	1,572.00	3	15	21	72	45	21	78
STS-181872-1♣	82	758.00	-	-	-	1	18	18	72	18	18	78
STS-182172-1♣	92	808.00	STK-182172-1	90	709.00	1	18	21	72	18	21	78
STS-182172-2	161	1,443.00	-	-	-	2	18	21	72	36	21	78
-	-	-	STK-182172-3	277	1,729.00	3	18	21	72	54	21	78
STS-242472-1♣	113	940.00	-	-	-	1	24	24	72	24	24	78



STS-121872-3



STS-121872-1

Other sizes available. Call factory for prices and delivery.
National Motor Freight Class:
Welded, 175;
Unassembled, 85
National Motor Freight Class

SINGLE TIER LOCKERS WITHOUT LEGS

WELDED†			UNASSEMBLED			DIMENSIONS						
CATALOG NUMBER	UNIT WEIGHT	UNIT PRICE	CATALOG NUMBER	UNIT WEIGHT	UNIT PRICE	OPEN-INGS	OPENING			OVERALL UNIT		
							W	D	H	W	D	H
STS-121260-A	50	\$526.00	STK-121260-A	49	\$537.00	1	12	12	60	12	12	60
STS-121260-C	127	1,254.00	STK-121260-C	125	1,189.00	3	12	12	60	36	12	60
STS-121560-A	53	560.00	STK-121560-A	52	499.00	1	12	15	60	12	15	60
STS-121560-C	135	1,246.00	STK-121560-C	133	1,223.00	3	12	15	60	36	15	60
STS-121860-A	57	615.00	STK-121860-A	56	562.00	1	12	18	60	12	18	60
STS-121860-C	145	1,399.00	STK-121860-C	142	1,287.00	3	12	18	60	36	18	60
STS-151560-A	53	636.00	STK-151560-A*	52	529.00	1	15	15	60	15	15	60
STS-151560-C	135	1,394.00	-	-	-	3	15	15	60	45	15	60
STS-151860-A	55	661.00	STK-151860-A	54	617.00	1	15	18	60	15	18	60
STS-151860-C	145	1,496.00	STK-151860-C	142	1,461.00	3	15	18	60	45	18	60
STS-181860-A	69	767.00	-	-	-	1	18	18	60	18	18	60
STS-121272-A	59	559.00	STK-121272-A	58	552.00	1	12	12	72	12	12	72
STS-121272-C	147	1,348.00	STK-121272-C	145	1,265.00	3	12	12	72	36	12	72
STS-121572-A	64	592.00	STK-121572-A	62	570.00	1	12	15	72	12	15	72
STS-121572-C	159	1,367.00	STK-121572-C	156	1,303.00	3	12	15	72	36	15	72
STS-121872-A▲	68	607.00	STK-121872-A	66	549.00	1	12	18	72	12	18	72
STS-121872-C▲	169	1,410.00	STK-121872-C	166	1,402.00	3	12	18	72	36	18	72
STS-151572-A	73	647.00	-	-	-	1	15	15	72	15	15	72
STS-151572-C	182	1,535.00	-	-	-	3	15	15	72	45	15	72
STS-151872-A	76	650.00	STK-151872-A♣	75	602.00	1	15	18	72	15	18	72
STS-151872-C	191	1,559.00	STK-151872-C♣	187	1,408.00	3	15	18	72	45	18	72
STS-152172-A	81	770.00	STK-152172-A	80	730.00	1	15	21	72	15	21	72
STS-152172-C	202	1,656.00	STK-152172-C	199	1,557.00	3	15	21	72	45	21	72
STS-182172-A	86	786.00	STK-182172-A	84	696.00	1	18	21	72	18	21	72
STS-182172-B	151	1,393.00	-	-	-	2	18	21	72	36	21	72
-	-	-	STK-182172-C	105	1,692.00	3	18	21	72	54	21	72
STS-242472-A♣	107	892.00	-	-	-	1	24	24	72	24	24	72



STS-121872-C



STS-121872-A

Other sizes available. Call factory for prices and delivery.
National Motor Freight Class:
Welded, 175;
Unassembled, 85

*Set-up charge of \$300 on marked units

Standard Colors



▲ ♣
Items with these symbols are available to ship in 2-3 days. Limited quantities and select colors.

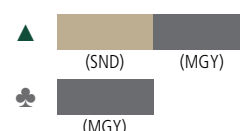

Double Tier Lockers

† Welded frames are riveted to welded locker body.

DOUBLE TIER LOCKERS WITH LEGS



DTS-121836-3



DTS-121836-1

Other sizes available. Call factory for prices and delivery.

National Motor Freight Class:

Welded, 175;

Unassembled, 85

WELDED†			UNASSEMBLED			DIMENSIONS						
CATALOG NUMBER	UNIT WEIGHT	UNIT PRICE	CATALOG NUMBER	UNIT WEIGHT	UNIT PRICE	OPENINGS	OPENING			OVERALL UNIT		
							W	D	H	W	D	H
DTS-121230-1	54	\$564.00	DTK-121230-1	53	\$505.00	2	12	12	30	12	12	66
DTS-121230-3	134	1,389.00	DTK-121230-3	132	1,292.00	6	12	12	30	36	12	66
DTS-121530-1	59	645.00	DTK-121530-1	58	510.00	2	12	15	30	12	15	66
DTS-121530-3	148	1,472.00	DTK-121530-3	145	1,272.00	6	12	15	30	36	15	66
DTS-121830-1	64	660.00	DTK-121830-1	63	513.00	2	12	18	30	12	18	66
DTS-121830-3	160	1,459.00	DTK-121830-3	157	1,304.00	6	12	18	30	36	18	66
DTS-151530-1	64	692.00	DTK-151530-1	63	613.00	2	15	15	30	15	15	66
DTS-151530-3	160	1,643.00	DTK-151530-3	157	1,531.00	6	15	15	30	45	15	66
DTS-151830-1	69	714.00	DTK-151830-1	68	626.00	2	15	18	30	15	18	66
DTS-151830-3	173	1,686.00	DTK-151830-3	169	1,535.00	6	15	18	30	45	18	66
DTS-121236-1▲	63	622.00	DTK-121236-1♣	61	500.00	2	12	12	36	12	12	78
DTS-121236-3▲	156	1,469.00	DTK-121236-3♣	153	1,302.00	6	12	12	36	36	12	78
DTS-121536-1▲	66	645.00	DTK-121536-1♣	65	522.00	2	12	15	36	12	15	78
DTS-121536-3▲	164	1,500.00	DTK-121536-3♣	161	1,322.00	6	12	15	36	36	15	78
DTS-121836-1▲	70	660.00	DTK-121836-1♣	69	532.00	2	12	18	36	12	18	78
DTS-121836-3▲	175	1,531.00	DTK-121836-3♣	172	1,367.00	6	12	18	36	36	18	78
DTS-151536-1	75	698.00	DTK-151536-1	74	613.00	2	15	15	36	15	15	78
DTS-151536-3	187	1,705.00	DTK-151536-3	184	1,542.00	6	15	15	36	45	15	78
DTS-151836-1▲	77	724.00	DTK-151836-1	75	594.00	2	15	18	36	15	18	78
DTS-151836-3▲	196	1,739.00	DTK-151836-3	193	1,506.00	6	15	18	36	45	18	78

DOUBLE TIER LOCKERS WITHOUT LEGS



DTS-121836-C



DTS-121836-A

Other sizes available. Call factory for prices and delivery.

National Motor Freight Class:

Welded, 175;

Unassembled, 85

WELDED†			UNASSEMBLED			DIMENSIONS						
CATALOG NUMBER	UNIT WEIGHT	UNIT PRICE	CATALOG NUMBER	UNIT WEIGHT	UNIT PRICE	OPENINGS	OPENING			OVERALL UNIT		
							W	D	H	W	D	H
DTS-121230-A	48	\$549.00	DTK-121230-A	47	\$458.00	2	12	12	30	12	12	60
DTS-121230-C	120	1,308.00	DTK-121230-C	118	1,265.00	6	12	12	30	36	12	60
DTS-121530-A	52	586.00	DTK-121530-A	51	481.00	2	12	15	30	12	15	60
DTS-121530-C	130	1,414.00	DTK-121530-C	128	1,206.00	6	12	15	30	36	15	60
DTS-121830-A	57	589.00	DTK-121830-A	56	499.00	2	12	18	30	12	18	60
DTS-121830-C	145	1,443.00	DTK-121830-C	142	1,331.00	6	12	18	30	36	18	60
DTS-151530-A	62	650.00	-	-	-	2	15	15	30	15	15	60
DTS-151530-C	155	1,602.00	DTK-151530-C*	152	1,518.00	6	15	15	30	45	15	60
DTS-151830-A	67	662.00	DTK-151830-A	66	623.00	2	15	18	30	15	18	60
DTS-151830-C	167	1,667.00	DTK-151830-C	164	1,473.00	6	15	18	30	45	18	60
DTS-121236-A	60	597.00	DTK-121236-A	59	537.00	2	12	12	36	12	12	72
DTS-121236-C▲	153	1,442.00	DTK-121236-C	150	1,272.00	6	12	12	36	36	12	72
DTS-121536-A	63	622.00	DTK-121536-A	62	518.00	2	12	15	36	12	15	72
DTS-121536-C▲	160	1,477.00	DTK-121536-C	158	1,329.00	6	12	15	36	36	15	72
DTS-121836-A▲	68	630.00	DTK-121836-A	66	529.00	2	12	18	36	12	18	72
DTS-121836-C▲	171	1,481.00	DTK-121836-C	168	1,375.00	6	12	18	36	36	18	72
DTS-151536-A	73	683.00	DTK-151536-A*	72	547.00	2	15	15	36	15	15	72
DTS-151536-C	183	1,667.00	DTK-151536-C	180	1,405.00	6	15	15	36	45	15	72
DTS-151836-A	77	707.00	DTK-151836-A	76	605.00	2	15	18	36	15	18	72
DTS-151836-C	193	1,701.00	DTK-151836-C	189	1,489.00	6	15	18	36	45	18	72

*Set-up charge of \$300 on marked units

Standard Colors



Sand (SND) Champagne/Putty (CPY) Light Grey (LGY) Medium Grey (MGY) Black (BLK)

▲ ♣
Items with these symbols are available to ship in 2-3 days. Limited quantities and select colors.

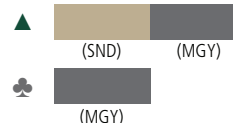

Triple Tier Lockers

† Welded frames are riveted to welded locker body.

TRIPLE TIER LOCKERS WITH LEGS

WELDED†			DIMENSIONS						
CATALOG NUMBER	UNIT WEIGHT	UNIT PRICE	# OF OPENINGS	OPENING			OVERALL UNIT		
				W	D	H	W	D	H
TTS-121224-1	61	\$696.00	3	12	12	24	12	12	78
TTS-121224-3	153	1,729.00	9	12	12	24	36	12	78
TTS-121524-1	68	729.00	3	12	15	24	12	15	78
TTS-121524-3	173	1,825.00	9	12	15	24	36	15	78
TTS-121824-1	72	747.00	3	12	18	24	12	18	78
TTS-121824-3	184	1,852.00	9	12	18	24	36	18	78
TTS-151524-1	66	819.00	3	15	15	24	15	15	78
TTS-151524-3	165	2,003.00	9	15	15	24	45	15	78
TTS-151824-1	71	812.00	3	15	18	24	15	18	78
TTS-151824-3	178	2,066.00	9	15	18	24	45	18	78



TTS-121824-3

TTS-121824-1

Other sizes available. Call factory for prices and delivery.

National Motor Freight Class:
Welded, 175;
Unassembled, 85

TRIPLE TIER LOCKERS WITHOUT LEGS

WELDED†			DIMENSIONS						
CATALOG NUMBER	UNIT WEIGHT	UNIT PRICE	# OF OPENINGS	OPENING			OVERALL UNIT		
				W	D	H	W	D	H
TTS-121224-A	63	\$725.00	3	12	12	24	12	12	72
TTS-121224-C	159	1,719.00	9	12	12	24	36	12	72
TTS-121524-A	66	707.00	3	12	15	24	12	15	72
TTS-121524-C	166	1,787.00	9	12	15	24	36	15	72
TTS-121824-A	71	737.00	3	12	18	24	12	18	72
TTS-121824-C	179	1,840.00	9	12	18	24	36	18	72
TTS-151524-A	67	775.00	3	15	15	24	15	15	72
TTS-151524-C	168	1,991.00	9	15	15	24	45	15	72
TTS-151824-A	72	801.00	3	15	18	24	15	18	72
TTS-151824-C	180	1,982.00	9	15	18	24	45	18	72



TTS-121824-C

TTS-121824-A

Other sizes available. Call factory for prices and delivery.

National Motor Freight Class:
Welded, 175;
Unassembled, 85

Standard Colors



Sand (SND) Champagne/ Putty (CPY) Light Grey (LGY) Medium Grey (MGY) Black (BLK)

Box Lockers

† Welded frames are riveted to welded locker body.

5-TIER BOX LOCKERS WITH LEGS



WELDED†			UNASSEMBLED			DIMENSIONS						
CATALOG NUMBER	UNIT WEIGHT	UNIT PRICE	CATALOG NUMBER	UNIT WEIGHT	UNIT PRICE	OPEN-INGS	OPENING			OVERALL UNIT		
							W	D	H	W	D	H
BS5-121212-1	52	\$556.00	--	--	--	5	12	12	12	12	12	66
BS5-121212-3	131	1,202.00	--	--	--	15	12	12	12	36	12	66
BS5-121512-1▲	56	590.00	--	--	--	5	12	15	12	12	15	66
BS5-121512-3▲	141	1,331.00	--	--	--	15	12	15	12	36	15	66
BS5-121812-1	61	613.00	--	--	--	5	12	18	12	12	18	66
BS5-121812-3	152	1,394.00	--	--	--	15	12	18	12	36	18	66
BS5-151512-1	64	721.00	--	--	--	5	15	15	12	15	15	66
BS5-151512-3	161	1,557.00	--	--	--	15	15	15	12	45	15	66
BS5-151812-1	67	707.00	--	--	--	5	15	18	12	15	18	66
BS5-151812-3	167	1,640.00	--	--	--	15	15	18	12	45	18	66

National Motor Freight Class: Welded, 175. Other sizes available. Call factory for pricing.

5-TIER BOX LOCKERS WITHOUT LEGS



WELDED†			UNASSEMBLED			DIMENSIONS						
CATALOG NUMBER	UNIT WEIGHT	UNIT PRICE	CATALOG NUMBER	UNIT WEIGHT	UNIT PRICE	OPEN-INGS	OPENING			OVERALL UNIT		
							W	D	H	W	D	H
BS5-121212-A	50	\$547.00	--	--	--	5	12	12	12	12	12	60
BS5-121212-C	126	1,214.00	--	--	--	15	12	12	12	36	12	60
BS5-121512-A	54	583.00	--	--	--	5	12	15	12	12	15	60
BS5-121512-C	136	1,246.00	--	--	--	15	12	15	12	36	15	60
BS5-121812-A	59	592.00	--	--	--	5	12	18	12	12	18	60
BS5-121812-C	147	1,331.00	--	--	--	15	12	18	12	36	18	60
BS5-151512-A	62	741.00	--	--	--	5	15	15	12	15	15	60
BS5-151512-C	156	1,548.00	--	--	--	15	15	15	12	45	15	60
BS5-151812-A	65	725.00	--	--	--	5	15	18	12	15	18	60
BS5-151812-C	162	1,593.00	--	--	--	15	15	18	12	45	18	60

National Motor Freight Class: Welded, 175. Other sizes available. Call factory for pricing.

6-TIER BOX LOCKERS WITH LEGS



WELDED†			UNASSEMBLED			DIMENSIONS						
CATALOG NUMBER	UNIT WEIGHT	UNIT PRICE	CATALOG NUMBER	UNIT WEIGHT	UNIT PRICE	OPEN-INGS	OPENING			OVERALL UNIT		
							W	D	H	W	D	H
BS6-121212-1▲	61	\$634.00	BK6-121212-1♣	60	\$515.00	6	12	12	12	12	12	78
BS6-121212-3▲	154	1,480.00	BK6-121212-3♣	151	1,281.00	18	12	12	12	36	12	78
BS6-121512-1▲	66	661.00	BK6-121512-1♣	65	528.00	6	12	15	12	12	15	78
BS6-121512-3▲	167	1,610.00	BK6-121512-3♣	164	1,327.00	18	12	15	12	36	15	78
BS6-121812-1▲	71	704.00	BK6-121812-1♣	70	545.00	6	12	18	12	12	18	78
BS6-121812-3▲	180	1,697.00	BK6-121812-3♣	177	1,389.00	18	12	18	12	36	18	78
BS6-151512-1	76	779.00	BK6-151512-1	75	649.00	6	15	15	12	15	15	78
BS6-151512-3	190	1,903.00	BK6-151512-3	187	1,622.00	18	15	15	12	45	15	78
BS6-151812-1♣	79	778.00	BK6-151812-1	78	627.00	6	15	18	12	15	18	78
BS6-151812-3♣	198	1,950.00	BK6-151812-3	194	1,651.00	18	15	18	12	45	18	78

National Motor Freight Class: Welded, 175; Unassembled, 85. Other sizes available. Call factory for pricing.

6-TIER BOX LOCKERS WITHOUT LEGS



WELDED†			UNASSEMBLED			DIMENSIONS						
CATALOG NUMBER	UNIT WEIGHT	UNIT PRICE	CATALOG NUMBER	UNIT WEIGHT	UNIT PRICE	OPEN-INGS	OPENING			OVERALL UNIT		
							W	D	H	W	D	H
BS6-121212-A♣	59	\$617.00	BK6-121212-A	58	\$563.00	6	12	12	12	12	12	72
BS6-121212-C♣	149	1,499.00	BK6-121212-C	146	1,302.00	18	12	12	12	36	12	72
BS6-121512-A	64	645.00	BK6-121512-A	63	588.00	6	12	15	12	12	15	72
BS6-121512-C	161	1,561.00	BK6-121512-C	158	1,380.00	18	12	15	12	36	15	72
BS6-121812-A▲	69	670.00	BK6-121812-A	67	578.00	6	12	18	12	12	18	72
BS6-121812-C▲	175	1,670.00	BK6-121812-C	172	1,446.00	18	12	18	12	36	18	72
BS6-151512-A	74	749.00	BK6-151512-A	73	650.00	6	15	15	12	15	15	72
BS6-151512-C	185	1,860.00	BK6-151512-C	182	1,625.00	18	15	15	12	45	15	72
BS6-151812-A	79	801.00	BK6-151812-A	78	650.00	6	15	18	12	15	18	72
BS6-151812-C	198	1,927.00	BK6-151812-C	194	1,677.00	18	15	18	12	45	18	72

National Motor Freight Class: Welded, 175; Unassembled, 85. Other sizes available. Call factory for pricing.

Standard Colors



▲ ♣
Items with these symbols are available to ship in 2-3 days. Limited quantities and select colors.

▲ (SND) (MGY)
♣ (MGY)

Heavy-Duty Lockers

† Welded frames are riveted to welded locker body.

WELDED† HEAVY-DUTY SINGLE TIER LOCKERS

CATALOG NUMBER	NO. OF COMPARTMENTS	OPENING			OVERALL UNIT			WEIGHT	PRICE
		W	D	H	W	D	H		
WITH LEGS									
HSL-121872-1	1	12	18	72	12	18	78	109	\$777.00
HSL-121872-3	3	12	18	72	36	18	78	280	1,836.00
HSL-151872-1	1	15	18	72	15	18	78	120	884.00
HSL-151872-3	3	15	18	72	45	18	78	313	2,039.00
HSL-181872-1	1	18	18	72	18	18	78	144	910.00
HSL-181872-2	2	18	18	72	36	18	78	263	1,489.00
WITHOUT LEGS									
HSL-121872-A	1	12	18	72	12	18	72	107	\$820.00
HSL-121872-C	3	12	18	72	36	18	72	277	1,741.00
HSL-151872-A	1	15	18	72	15	18	72	119	813.00
HSL-151872-C	3	15	18	72	45	18	72	311	2,020.00
HSL-181872-A	1	18	18	72	18	18	72	142	850.00
HSL-181872-B	2	18	18	72	36	18	72	260	1,639.00



HSL-121872-C



HSL-121872-1

Locker body and shelf constructed of 16 gauge steel. Shipped assembled. National Motor Freight Class: 175

WELDED† HEAVY-DUTY DOUBLE TIER LOCKERS

CATALOG NUMBER	NO. OF COMPARTMENTS	OPENING			OVERALL UNIT			WEIGHT	PRICE
		W	D	H	W	D	H		
WITH LEGS									
HDL-121836-1	2	12	18	36	12	18	78	111	\$926.00
HDL-121836-3	6	12	18	36	36	18	78	285	1,968.00
HDL-151836-1	2	15	18	36	15	18	78	135	948.00
HDL-151836-3	6	15	18	36	45	18	78	331	2,263.00
WITHOUT LEGS									
HDL-121836-A	2	12	18	36	12	18	72	109	\$884.00
HDL-121836-C	6	12	18	36	36	18	72	282	1,846.00
HDL-151836-A	2	15	18	36	15	18	72	133	932.00
HDL-151836-C	6	15	18	36	45	18	72	327	1,961.00



HDL-121836-3



HDL-121836-A

Locker body and shelf constructed of 16 gauge steel. Shipped assembled. National Motor Freight Class: 175

WELDED† HEAVY-DUTY 6-TIER BOX LOCKERS

CATALOG NUMBER	NO. OF COMPARTMENTS	OPENING			OVERALL UNIT			WEIGHT	PRICE
		W	D	H	W	D	H		
WITH LEGS									
HBL6-1218-1	6	12	18	12	12	18	78	126	\$1,122.00
HBL6-1218-3	18	12	18	12	36	18	78	332	2,377.00
WITHOUT LEGS									
HBL6-1218-A	6	12	18	12	12	18	72	124	\$1,044.00
HBL6-1218-C	18	12	18	12	36	18	72	328	2,354.00



HBL6-1218-C



HBL6-1218-A

Locker body and shelf constructed of 16 gauge steel. Shipped assembled. National Motor Freight Class: 175

Standard Colors



LOCKERS

Specialty Lockers

†Welded frames are riveted to welded locker body.

WELDED† COMBINATION LOCKERS



CMS-242172-A

CATALOG NUMBER	NO. OF COMPARTMENTS	OPENING			OVERALL UNIT			WEIGHT	PRICE
		W	D	H	W	D	H		
WITH LEGS									
CMS-182172-1	7	18	21	72	18	21	78	121	\$1,015.00
CMS-242172-1♣	7	24	21	72	24	21	78	126	1,125.00
WITHOUT LEGS									
CMS-182172-A	7	18	21	72	18	21	72	119	\$983.00
CMS-242172-A♣	7	24	21	72	24	21	72	124	1,093.00

Shipped assembled.
National Motor Freight Class: 175

WELDED† HALF-HEIGHT LOCKERS



STS-121836-A

CATALOG NUMBER	NO. OF COMPARTMENTS	OPENING			OVERALL UNIT			WEIGHT	PRICE
		W	D	H	W	D	H		
WITH LEGS									
STS-121236-1	1	12	12	36	12	12	42	37	\$418.00
STS-121836-1	1	12	18	36	12	18	42	42	475.00
WITHOUT LEGS									
STS-121236-A	1	12	12	36	12	12	36	35	\$412.00
STS-121836-A	1	12	18	36	12	18	36	40	454.00

Shipped assembled.
National Motor Freight Class: 175

WELDED† WALL MOUNTED LOCKERS



BS1-121812-3



BS1-121812-4

CATALOG NUMBER	NO. OF COMPARTMENTS	OPENING			OVERALL UNIT			WEIGHT	PRICE
		W	D	H	W	D	H		
3-PERSON LOCKER									
BS1-121812-3*♣	3	12	18	12	36	18	12	43	\$604.00
4-PERSON LOCKER									
BS1-121812-4*♣	4	12	18	12	48	18	12	55	660.00

*Wall mounted lockers are shipped assembled only. Coat rods are installed in field.
Coat rod and brackets included with all 3-person and 4-person lockers.
National Motor Freight Class: 175

WELDED† WALL MOUNTED C-THRU LOCKERS



CBS1-121812-4

CATALOG NUMBER	NO. OF COMPARTMENTS	OPENING			OVERALL UNIT			WEIGHT	PRICE
		W	D	H	W	D	H		
4-PERSON LOCKER									
CBS1-121812-4*	4	12	18	12	48	18	12	53	\$738.00

*Shipped assembled. Coat rod and brackets included. Coat rods are installed in field.
National Motor Freight Class: 175

Standard Colors



♣ Items with this symbol are available to ship in 2-3 days. Limited quantities and select colors.



15 & 16 Person Lockers

† Welded frames are riveted to welded locker body.

15 PERSON LOCKERS

CATALOG NUMBER	NO. OF COMPARTMENTS	OPENING			OVERALL UNIT			WEIGHT	PRICE
		W	D	H	W	D	H		
WELDED† WITH LEGS									
SRS-601878-1*	15	12	18	12	60	18	78	182	\$1,855.00
UNASSEMBLED WITH LEGS									
SRK-601878-1	15	12	18	12	60	18	78	179	1,545.00
WELDED† WITHOUT LEGS									
SRS-601872-A*	15	12	18	12	60	18	72	180	1,835.00
UNASSEMBLED WITHOUT LEGS									
SRK-601872-A	15	12	18	12	60	18	72	177	1,527.00



SRS-601878-1

*Shipped assembled. Coat rod and brackets included. Center section and coat rods are installed in field. National Motor Freight Class: Assembled, 175; Unassembled, 85

16 PERSON LOCKERS

CATALOG NUMBER	NO. OF COMPARTMENTS	OPENING			OVERALL UNIT			WEIGHT	PRICE
		W	D	H	W	D	H		
WELDED† WITH LEGS									
SRS-721878-1*♣	16	12	18	12	72	18	78	190	\$1,952.00
UNASSEMBLED WITH LEGS									
SRK-721878-1♣	16	12	18	12	72	18	78	187	1,537.00
WELDED† WITHOUT LEGS									
SRS-721872-A*♣	16	12	18	12	72	18	72	184	1,946.00
UNASSEMBLED WITHOUT LEGS									
SRK-721872-A	16	12	18	12	72	18	72	181	1,659.00



SRS-721878-1

*Shipped assembled. Coat rod and brackets included. Center section and coat rods are installed in field. National Motor Freight Class: Assembled, 175; Unassembled, 85

16 PERSON LOCKER WITH C-THRU DOORS

CATALOG NUMBER	NO. OF COMPARTMENTS	OPENING			OVERALL UNIT			WEIGHT	PRICE
		W	D	H	W	D	H		
ASSEMBLED WITH LEGS									
CSRS-721878-1*	16	12	18	12	72	18	78	180	\$2,088.00
ASSEMBLED WITHOUT LEGS									
CSRS-721872-A*	16	12	18	12	72	18	72	175	2,052.00



CSRS-721872-A

*Shipped assembled. Coat rod and brackets included. Center section and coat rods are installed in field. National Motor Freight Class: Assembled, 175

Standard Colors



♣ Items with this symbol are available to ship in 2-3 days. Limited quantities and select colors.



LOCKERS

C-Thru Lockers

† Welded frames are riveted to welded locker body.

WELDED† SINGLE TIER C-THRU LOCKERS



CSL-121872-3

CSL-121872-1

Shipped assembled.
National Motor Freight Class: 175

CATALOG NUMBER	NO. OF COMPARTMENTS	OPENING			OVERALL UNIT			WEIGHT	PRICE
		W	D	H	W	D	H		
WITH LEGS									
CSL-121272-1	1	12	12	72	12	12	78	61	\$808.00
CSL-121272-3	3	12	12	72	36	12	78	156	1,990.00
CSL-121572-1	1	12	15	72	12	15	78	65	811.00
CSL-121572-3	3	12	15	72	36	15	78	164	2,032.00
CSL-121872-1	1	12	18	72	12	18	78	69	828.00
CSL-121872-3	3	12	18	72	36	18	78	173	2,088.00
CSL-151872-1	1	15	18	72	15	18	78	96	849.00
CSL-151872-3	3	15	18	72	45	18	78	196	2,092.00
WITHOUT LEGS									
CSL-121572-C	3	12	15	72	36	15	72	159	\$2,014.00
CSL-121872-A	1	12	18	72	12	18	72	67	881.00
CSL-121872-C	3	12	18	72	36	18	72	168	2,059.00
CSL-151872-A	1	15	18	72	15	18	72	74	831.00
CSL-151872-C	3	15	18	72	45	18	72	191	2,029.00

WELDED† DOUBLE TIER C-THRU LOCKERS



CDL-121836-3

CDL-121836-1

Shipped assembled.
National Motor Freight Class: 175

CATALOG NUMBER	NO. OF COMPARTMENTS	OPENING			OVERALL UNIT			WEIGHT	PRICE
		W	D	H	W	D	H		
WITH LEGS									
CDL-121236-1	2	12	12	36	12	12	78	59	\$787.00
CDL-121236-3	6	12	12	36	36	12	78	151	2,194.00
CDL-121536-1	2	12	15	36	12	15	78	63	874.00
CDL-121536-3	6	12	15	36	36	15	78	159	2,248.00
CDL-121836-1	2	12	18	36	12	18	78	67	1,031.00
CDL-121836-3	6	12	18	36	36	18	78	168	2,234.00
CDL-151836-1	2	15	18	36	15	18	78	74	929.00
CDL-151836-3	6	15	18	36	45	18	78	191	2,539.00
WITHOUT LEGS									
CDL-121236-A	2	12	12	36	12	12	72	57	\$925.00
CDL-121236-C	6	12	12	36	36	12	72	146	2,184.00
CDL-121536-C	6	12	15	36	36	15	72	154	2,137.00
CDL-121836-A	2	12	18	36	12	18	72	65	948.00
CDL-121836-C	6	12	18	36	36	18	72	163	2,234.00
CDL-151836-C	6	15	18	36	45	18	72	183	2,538.00

WELDED† 6-TIER C-THRU BOX LOCKERS



CBL6-121812-3

CBL6-121812-A

Shipped assembled.
National Motor Freight Class: 175

CATALOG NUMBER	NO. OF COMPARTMENTS	OPENING			OVERALL UNIT			WEIGHT	PRICE
		W	D	H	W	D	H		
WITH LEGS									
CBL6-121212-1	6	12	12	12	12	12	78	53	\$664.00
CBL6-121212-3	18	12	12	12	36	12	78	131	1,765.00
CBL6-121512-1	6	12	15	12	12	15	78	58	719.00
CBL6-121512-3	18	12	15	12	36	15	78	145	1,769.00
CBL6-121812-1	6	12	18	12	12	18	78	63	710.00
CBL6-121812-3	18	12	18	12	36	18	78	157	1,810.00
WITHOUT LEGS									
CBL6-121212-A	6	12	12	12	12	12	72	51	\$660.00
CBL6-121212-C	18	12	12	12	36	12	72	126	1,708.00
CBL6-121512-A	6	12	15	12	12	15	72	56	745.00
CBL6-121512-C	18	12	15	12	36	15	72	140	1,779.00
CBL6-121812-A	6	12	18	12	12	18	72	61	777.00
CBL6-121812-C	18	12	18	12	36	18	72	152	1,851.00

Standard Colors



Heavy-Duty Ventilated Lockers

† Welded frames are riveted to welded locker body.

WELDED VENTILATED SINGLE TIER LOCKERS

CATALOG NUMBER	NO. OF COMPARTMENTS	OPENING			OVERALL UNIT			WEIGHT	PRICE
		W	D	H	W	D	H		
WITH LEGS									
VSL-121872-1	1	12	18	72	12	18	78	88	\$839.00
VSL-121872-3♣	3	12	18	72	36	18	78	219	1,958.00
VSL-151872-1	1	15	18	72	15	18	78	93	944.00
VSL-151872-3	3	15	18	72	45	18	78	233	2,210.00
VSL-181872-1	1	18	18	72	18	18	78	98	982.00
VSL-181872-2	2	18	18	72	36	18	78	245	1,818.00
WITHOUT LEGS									
VSL-121872-A	1	12	18	72	12	18	72	86	\$870.00
VSL-121872-C	3	12	18	72	36	18	72	214	1,907.00
VSL-151872-A	1	15	18	72	15	18	72	91	899.00
VSL-151872-C	3	15	18	72	45	18	72	228	2,226.00
VSL-181872-A	1	18	18	72	18	18	72	96	972.00
VSL-181872-B	2	18	18	72	36	18	72	241	1,806.00

Shipped assembled.

National Motor Freight Class: 175



VSL-121872-1

VSL-121872-3

WELDED VENTILATED DOUBLE TIER LOCKERS

CATALOG NUMBER	NO. OF COMPARTMENTS	OPENING			OVERALL UNIT			WEIGHT	PRICE
		W	D	H	W	D	H		
WITH LEGS									
VDL-121836-1	2	12	18	36	12	18	78	88	\$895.00
VDL-121836-3♣	6	12	18	36	36	18	78	223	2,119.00
VDL-151836-1	2	15	18	36	15	18	78	93	991.00
VDL-151836-3	6	15	18	36	45	18	78	233	2,464.00
WITHOUT LEGS									
VDL-121836-A	2	12	18	36	12	18	72	84	\$906.00
VDL-121836-C	6	12	18	36	36	18	72	209	2,069.00
VDL-151836-A	2	15	18	36	15	18	72	89	1,004.00
VDL-151836-C	6	15	18	36	45	18	72	223	2,415.00

Shipped assembled.

National Motor Freight Class: 175



VDL-121836-1

VDL-121836-3

LOCKERS

WELDED VENTILATED 6-TIER BOX LOCKERS

CATALOG NUMBER	NO. OF COMPARTMENTS	OPENING			OVERALL UNIT			WEIGHT	PRICE
		W	D	H	W	D	H		
WITH LEGS									
VBL6-1218-1♣	6	12	18	12	12	18	78	104	\$1,000.00
VBL6-1218-3♣	18	12	18	12	36	18	78	274	2,477.00
WITHOUT LEGS									
VBL6-1218-A	6	12	18	12	12	18	72	102	\$990.00
VBL6-1218-C	18	12	18	12	36	18	72	270	2,432.00

Shipped assembled.

National Motor Freight Class: 175



VBL6-1218-1

VBL6-1218-3

Standard Colors



♣ Items with this symbol are available to ship in 2-3 days. Limited quantities and select colors.



COST FOR PERFORATION ON DOORS

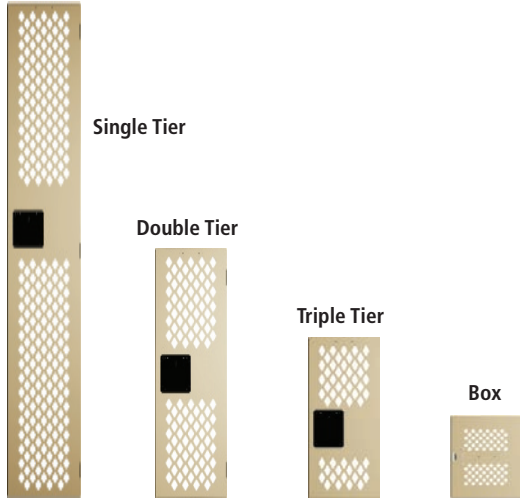

CAT. NO.	DESCRIPTION	PERFORATION COST*
LPDS-12	SINGLE TIER DOOR 12" WIDE	\$35.00
LPDS-15	SINGLE TIER DOOR 15" WIDE	35.00
LPDD-12	DOUBLE TIER DOOR 12" WIDE	35.00
LPDD-15	DOUBLE TIER DOOR 15" WIDE	35.00
LPDT-12	TRIPLE TIER DOOR 12" WIDE	35.00
LPDT-15	TRIPLE TIER DOOR 15" WIDE	35.00
LPDB-12	BOX DOOR 12" WIDE	35.00
LPDB-15	BOX DOOR 15" WIDE	35.00

*Cost listed is the additional cost for the door to be perforated. Lockers or Doors must be ordered separately. Perforation is available on all Tennsco lockers with solid doors. For sizes not listed, call factory for pricing.

National Motor Freight Class: 85

REPLACEMENT DOORS

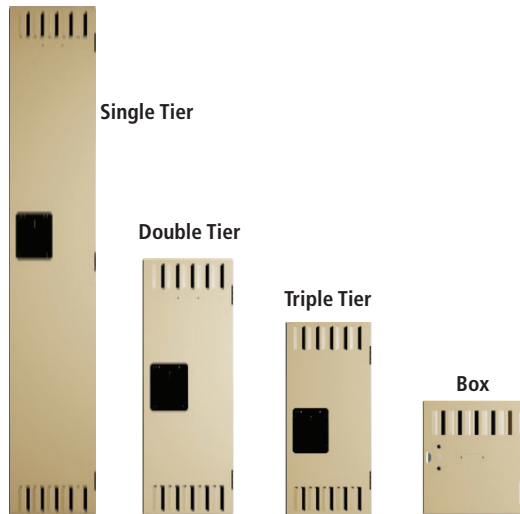

CAT. NO.	DOOR TYPE	W	H	WT.	PRICE
LSTD-1260	SINGLE TIER	12	60	20.0	\$257.00
LSTD-1560	SINGLE TIER	15	60	23.0	268.00
LSTD-1272	SINGLE TIER	12	72	23.0	216.00
LSTD-1572	SINGLE TIER	15	72	27.0	258.00
LSTD-1872	SINGLE TIER	18	72	31.0	287.00
LDTD-1230	DOUBLE TIER	12	30	9.3	122.00
LDTD-1236	DOUBLE TIER	12	36	11.0	125.00
LDTD-1536	DOUBLE TIER	15	36	12.8	144.00
LTTD-1224	TRIPLE TIER	12	24	5.0	124.00
LBD-1212	BOX	12	12	3.1	22.00
LBD-1512	BOX	15	12	3.6	61.00

Lockbar and recessed cup included.

National Motor Freight Class: 85

REPLACEMENT DOOR FRAME ASSEMBLIES

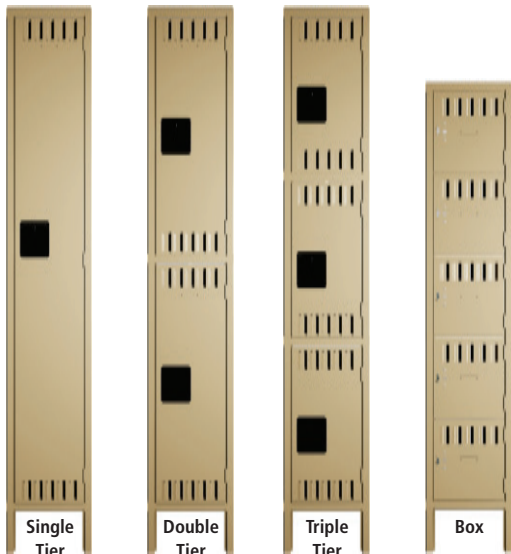

CAT. NO.	DOOR TYPE	W	H	WT.	PRICE
LSFA-1260	SINGLE TIER	12	60	35.0	\$337.00
LSFA-1560	SINGLE TIER	15	60	34.0	350.00
LSFA-1272	SINGLE TIER	12	72	36.0	329.00
LSFA-1572	SINGLE TIER	15	72	40.0	340.00
LSFA-1872	SINGLE TIER	18	72	45.0	377.00
LSFA-2472	SINGLE TIER	24	72	60.0	514.00
LDFA-1260	DOUBLE TIER	12	60	34.0	340.00
LDFA-1272	DOUBLE TIER	12	72	37.0	358.00
LDFA-1572	DOUBLE TIER	15	72	42.0	390.00
LTFA-1272	TRIPLE TIER	12	72	35.0	496.00
LTFA-1572	TRIPLE TIER	12	72	38.0	532.00
LBFA-1260	BOX	12	60	29.0	268.00
LBFA-1272	BOX	12	72	24.0	298.00

Lockbar and recessed cup included.

Catalog numbers shown are for frames without legs.

For frames with legs, add the suffix "-1".

National Motor Freight Class: 85

Standard Colors



Sand (SND) Champagne/ Putty (CPY) Light Grey (LGY) Medium Grey (MGY) Black (BLK)

FRONT AND END BASES

FRONT BASES					
CAT. NO.	W	D	H	WT.	PRICE
FB-12 ▲	12	—	6	1.2	\$9.50
FB-15 ▲	15	—	6	1.7	10.30
FB-18 ▲	18	—	6	2.0	12.20
FB-24	24	—	6	2.8	20.00

END BASES					
CAT. NO.	W	D	H	WT.	PRICE
EB-12 ▲	—	12	6	1.2	\$15.50
EB-15 ▲	—	15	6	1.4	16.90
EB-18 ▲	—	18	6	1.7	17.00
EB-21	—	21	6	2.4	33.00
EB-24	—	24	6	2.6	33.00



National Motor Freight Class: 85

CLOSED BASES

ONE-WIDE BASES					
CAT. NO.	W	D	H	WT.	PRICE
CLB-1212	12	12	6	7.4	\$63.00
CLB-1215	12	15	6	7.3	68.00
CLB-1218 ▲	12	18	6	7.7	65.00
CLB-1518 ▲	15	18	6	8.5	80.00
CLB-1521	15	21	6	11.0	91.00

THREE-WIDE BASES					
CAT. NO.	W	D	H	WT.	PRICE
CLB-3612 ▲	36	12	6	13.1	\$126.00
CLB-3615 ▲	36	15	6	16.3	132.00
CLB-3618 ▲	36	18	6	19.6	128.00
CLB-4512	45	12	6	16.3	144.00
CLB-4515	45	15	6	20.4	151.00
CLB-4518	45	18	6	17.0	154.00



National Motor Freight Class: 85

Z-BASES

CAT. NO.	W	D	H	WT.	PRICE
Z-BASE FRONT					
LZBA-12	12	1 5/8	4	1.7	\$31.00
LZBA-36	36	1 5/8	4	5.5	46.00
LZBA-72	72	1 5/8	4	12.0	71.00
Z-BASE SIDE					
LZBS-18	—	18	4	4.8	\$23.00
SPLICE PLATE					
LZBSPL	3 1/2	—	3 3/4	0.8	\$3.90



The shape of the Z-Base provides a recessed front base and toe-plate.

NOTE: Z-Base only supports front of locker, creating a 4" space beneath the locker. Locker must be anchored to a wall or back-to-back.

National Motor Freight Class: 85

CAT. NO.	W	D	H	WT.	PRICE
HMLB-36	36	9 1/2	1 1/4	10.0	\$186.00
HMLB-48	48	9 1/2	1 1/4	16.0	237.00
HMLB-60	60	9 1/2	1 1/4	20.0	279.00
HMLB-72	72	9 1/2	1 1/4	20.0	340.00
HMLB-84	84	9 1/2	1 1/4	28.0	390.00
HMLB-96	96	9 1/2	1 1/4	32.0	457.00
HMLB-108*	108	9 1/2	1 1/4	36.0	518.00
HMLB-120*	120	9 1/2	1 1/4	40.0	583.00
HMLB-132*	132	9 1/2	1 1/4	44.0	642.00
HMLB-144*	144	9 1/2	1 1/4	48.0	725.00
LBP-1 (BENCH PEDESTAL) ▲			16 1/4	7.0	\$72.00

Color options not available for HMLB-vvv.

National Motor Freight Class: 85

LAMINATE HARD MAPLE BENCHES & BENCH PEDESTALS



NOTE: Pedestals must be ordered separately.

*Use three pedestals for benches 108" to 144".

SHELVES FOR STANDARD LOCKERS

CAT. NO.	W	D	H	WT.	PRICE
ESL-1212	12	12	3/4	1.3	\$33.00
ESL-1215	12	15	3/4	1.9	33.00
ESL-1218	12	18	3/4	2.2	37.00
ESL-1518	15	18	3/4	2.4	37.00
ESL-1521	15	21	3/4	3.3	56.00
ESL-1821	18	21	3/4	3.8	58.00
ESL-2424	24	24	3/4	4.6	57.00

National Motor Freight Class: 85



Standard Colors



▲ Items with this symbol are available to ship in 2-3 days. Limited quantities and select colors.



Locker Accessories

COAT RODS & COAT HOOKS



*Coat rods are available in Medium Grey only.
**Double Coat Hook can not be used with coat rod.
Double Coat Hooks are available in Chrome only.

CAT. NO.	W	D	H	WT.	PRICE
COAT RODS*					
LCR-12	12	—	—	0.4	\$23.00
LCR-15	15	—	—	0.4	26.00
LCR-18	18	—	—	0.5	31.00
LCR-21	21	—	—	0.6	35.00
LCR-24	24	—	—	0.7	35.00
COAT HOOKS					
LCH-1	SINGLE COAT HOOK			0.1	\$3.50
LCH-2	DOUBLE COAT HOOK**			0.2	5.20

National Motor Freight Class: 85

LOCKING CHANNELS



Locking Channels are a vertical product, but shown horizontal for clarity of detail. Available in Medium Grey only.

CAT. NO.	DESCRIPTION	WT.	PRICE
LLCA-1	FOR SINGLE TIER	1.0	\$15.90
LLCA-2	FOR DOUBLE TIER	0.5	13.20
LLCA-3	FOR TRIPLE TIER	0.4	12.50

National Motor Freight Class: 85

RECESSED HANDLES



CAT. NO.	DESCRIPTION	WT.	PRICE
LRH-2	PAINTED STEEL	0.7	\$10.50
LRH-3	STAINLESS STEEL	0.7	22.00

Color options not available.

National Motor Freight Class: 85

MISCELLANEOUS REPLACEMENT PARTS

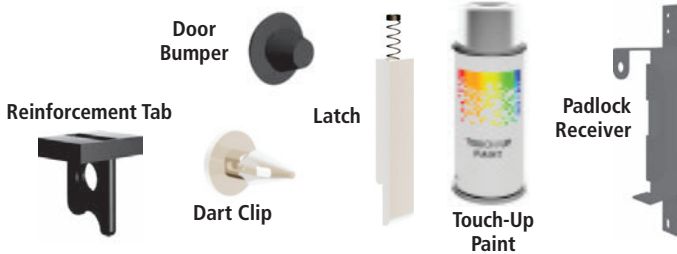

CAT. NO.	DESCRIPTION	WT.	PRICE
LL-3	LATCH AND SPRING	0.1	\$2.30
LPR-2	PADLOCK RECEIVER	0.3	5.40
LB-1	DOOR BUMPER	0.1	2.40
LDC-1	DART CLIP	0.1	2.50
LRT-1	REINFORCEMENT TAB	0.2	3.50
LTUP-1	TOUCH-UP PAINT	0.3	19.80

Color options not available, except for Touch-Up Paint.

National Motor Freight Class: 85

LOCKS BY MASTER LOCK

All locks can be used on any Tennsco locker except where noted.

GROOVED KEY LOCK



COMBINATION LOCKS



DEAD BOLT SPRING BOLT GRAVITY LIFT

COMBINATION PADLOCKS



MASTER KEYED NO KEY

KEYS



CAT. NO.	DESCRIPTION	WT.	PRICE*
GROOVED KEY LOCK			
MAS-1710MK	GROOVED KEY LOCK (DEAD BOLT)	0.4	\$65.00
COMBINATION LOCKS			
MAS-1670	DEAD BOLT (MASTER KEYED)	0.5	\$78.00
MAS-1654	SPRING BOLT (MASTER KEYED)	0.5	76.00
MAS-1630*	GRAVITY LIFT LOCK (MASTER KEYED)	0.5	68.00
COMBINATION PADLOCKS			
MAS-1525	COMBINATION (MASTER KEYED)	0.5	\$35.00
MAS-1502	COMBINATION (NO KEY)	0.5	27.00

Master keyed locks are shipped with two master keys per order. To order additional master keys, see "Keys" (below).

*NOTE: Gravity Lift Locks do not work on box lockers.

Color options not available.

CAT. NO.	KEY TYPE	FITS LOCK TYPE	PRICE*
LMCK-1	MASTER KEY (FITS ALL LOCKS IN A SERIES)	COMBINATION LOCK	\$25.00
LMPK-1	MASTER KEY (FITS ALL LOCKS IN A SERIES)	COMBINATION PADLOCK	29.00
LMGK-1	MASTER KEY (FITS ALL LOCKS IN A SERIES)	GROOVED KEY	55.00

National Motor Freight Class: 85

Color options not available.

LOCKERS

Locker Accessories

CAT. NO.	DESCRIPTION	WT.	PRICE
NUMBER PLATES*			
LNP-A	ALUMINUM NUMBER PLATES (25)	2.5	\$57.00
NAME PLATE			
LNP-2	TENNSCO NAME PLATE	0.1	\$2.20

*Available only in series of 25 (example: 1-25, 26-50, 51-75, etc.) ranging from 1 through 1000. Must specify number groups when ordering. A pop rivet gun is needed for installation.

NUMBER PLATES & NAME PLATES



LNP-A



LNP-2

National Motor Freight Class: 85

Color options not available.

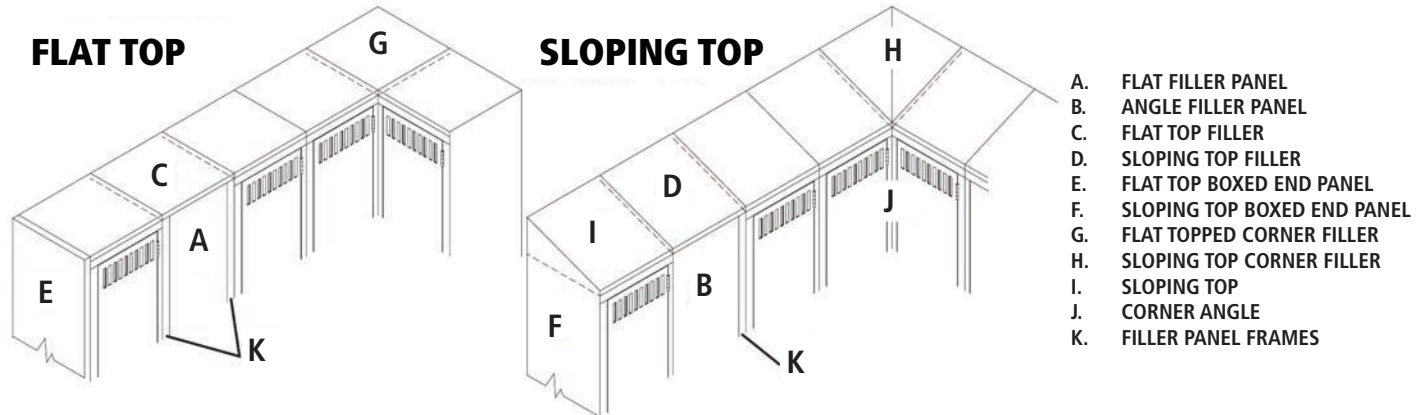

FLAT AND ANGLE FILLER PANELS

FLAT FILLER PANELS (A)					
CAT. NO.	W	D	H	WT.	PRICE
LFF-360	3	—	60	11.2	\$107.00
LFF-366	3	—	66	11.4	101.00
LFF-372	3	—	72	11.6	103.00
LFF-378	3	—	78	11.8	97.00
LFF-960	9	—	60	14.8	124.00
LFF-966	9	—	66	15.4	122.00
LFF-972	9	—	72	15.9	124.00
LFF-978	9	—	78	16.4	126.00
LFF-1760	17	—	60	19.8	152.00
LFF-1766	17	—	66	21.0	159.00
LFF-1772	17	—	72	22.0	163.00
LFF-1778	17	—	78	23.0	197.00



Flat Filler Panel

ANGLE FILLER PANELS (B)					
CAT. NO.	W	D	H	WT.	PRICE
LAF-360	3	—	60	12.3	\$188.00
LAF-366	3	—	66	12.5	167.00
LAF-372	3	—	72	12.8	169.00
LAF-378	3	—	78	13.1	190.00
LAF-960	9	—	60	16.0	205.00
LAF-966	9	—	66	16.7	201.00
LAF-972	9	—	72	17.3	193.00
LAF-978	9	—	78	18.0	214.00
LAF-1760	17	—	60	21.0	226.00
LAF-1766	17	—	66	22.0	218.00
LAF-1772	17	—	72	23.0	186.00
LAF-1778	17	—	78	25.0	241.00



Angle Filler Panel

LOCKERS

TWO FILLER PANEL FRAMES MUST BE USED

ONE FILLER PANEL FRAME MUST BE USED

National Motor Freight Class: 85

FLAT AND SLOPING TOP FILLERS

FLAT TOP FILLERS (C)					
CAT. NO.	W	D	H	WT.	PRICE
LFTF-312	3	12	—	2.0	\$73.00
LFTF-315	3	15	—	2.1	75.00
LFTF-318	3	18	—	2.2	82.00
LFTF-321	3	21	—	2.4	82.00
LFTF-324	3	24	—	2.6	86.00
LFTF-912	9	12	—	2.7	86.00
LFTF-915	9	15	—	2.9	79.00
LFTF-918	9	18	—	3.2	80.00
LFTF-921	9	21	—	3.5	90.00
LFTF-924	9	24	—	3.8	79.00
LFTF-1712	17	12	—	3.6	90.00
LFTF-1715	17	15	—	4.0	95.00
LFTF-1718	17	18	—	4.5	95.00
LFTF-1721	17	21	—	5.0	98.00
LFTF-1724	17	24	—	5.5	99.00



SLOPING TOP FILLERS (D)					
CAT. NO.	W	D	H	WT.	PRICE
LSTF-312	3	12	—	2.0	\$83.00
LSTF-315	3	15	—	2.1	83.00
LSTF-318	3	18	—	2.2	71.00
LSTF-321	3	21	—	2.4	86.00
LSTF-324	3	24	—	2.5	86.00
LSTF-912	9	12	—	2.7	80.00
LSTF-915	9	15	—	2.9	88.00
LSTF-918	9	18	—	3.2	73.00
LSTF-921	9	21	—	3.5	91.00
LSTF-1712	17	12	—	3.6	91.00
LSTF-1715	17	15	—	4.1	95.00
LSTF-1718	17	18	—	4.0	87.00
LSTF-1721	17	21	—	5.0	99.00
LSTF-1724	17	24	—	5.5	101.00

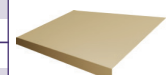

National Motor Freight Class: 85

Standard Colors



BOXED END PANELS



FLAT TOP BOXED END PANELS (E)						
CAT. NO.	W	D	H	WT.	PRICE	
LFTBE-1260	—	12	60	28	\$193.00	
LFTBE-1560	—	15	60	31	208.00	
LFTBE-1860	—	18	60	34	223.00	
LFTBE-2160	—	21	60	38	238.00	
LFTBE-1266	—	12	66	30	200.00	
LFTBE-1566	—	15	66	33	218.00	
LFTBE-1866	—	18	66	37	230.00	
LFTBE-2166	—	21	66	40	249.00	
LFTBE-1272	—	12	72	32	208.00	
LFTBE-1572	—	15	72	35	226.00	
LFTBE-1872	—	18	72	39	243.00	
LFTBE-2172	—	21	72	43	260.00	
LFTBE-1278	—	12	78	33	211.00	
LFTBE-1578	—	15	78	37	234.00	
LFTBE-1878	—	18	78	41	254.00	
LFTBE-2178	—	21	78	46	273.00	



SLOPING TOP BOXED END PANELS (F)						
CAT. NO.	W	D	H	WT.	PRICE	
LSTBE-1260	—	12	60	29	\$271.00	
LSTBE-1560	—	15	60	33	288.00	
LSTBE-1860	—	18	60	37	298.00	
LSTBE-2160	—	21	60	41	333.00	
LSTBE-1266	—	12	66	31	279.00	
LSTBE-1566	—	15	66	35	271.00	
LSTBE-1866	—	18	66	40	326.00	
LSTBE-1272	—	12	72	33	292.00	
LSTBE-1572	—	15	72	37	280.00	
LSTBE-1872	—	18	72	41	336.00	
LSTBE-2172	—	21	72	46	358.00	
LSTBE-1278	—	12	78	34	301.00	
LSTBE-1578	—	15	78	39	309.00	
LSTBE-1878	—	18	78	44	301.00	
LSTBE-2178	—	21	78	49	369.00	

NOTE: For left sloping panels, add -L to the catalog number; for right sloping panels, add -R to the catalog number.

National Motor Freight Class: 85

CORNER FILLERS



FLAT TOP CORNER FILLERS (G)						
CAT. NO.	W	D	H	WT.	PRICE	
LFCF-12	—	12	—	3.5	\$88.00	
LFCF-15	—	15	—	4.5	90.00	
LFCF-18	—	18	—	5.3	80.00	
LFCF-21	—	21	—	6.2	97.00	
LFCF-24	—	24	—	7.2	95.00	



SLOPING TOP CORNER FILLERS (H)						
CAT. NO.	W	D	H	WT.	PRICE	
LSCF-12	—	12	—	3.5	\$86.00	
LSCF-15	—	15	—	4.4	98.00	
LSCF-18	—	18	—	5.5	98.00	
LSCF-21	—	21	—	6.7	117.00	
LSCF-24	—	24	—	7.7	124.00	

National Motor Freight Class: 85

SLOPING TOPS*



SLOPING TOP — ONE WIDE (I)						
CAT. NO.	W	D	H	WT.	PRICE	
KST-1212▲	12	12	—	3.6	\$61.00	
KST-1215▲	12	15	—	4.3	73.00	
KST-1218▲	12	18	—	5.0	72.00	
KST-1518▲	15	18	—	5.5	82.00	
KST-1521	15	21	—	7.6	129.00	
KST-1821	18	21	—	7.9	113.00	
KST-2424	24	24	—	9.1	165.00	



SLOPING TOP — THREE WIDE (I)						
CAT. NO.	W	D	H	WT.	PRICE	
KST-3612▲	36	12	—	7.7	\$87.00	
KST-3615▲	36	15	—	9.0	91.00	
KST-3618▲	36	18	—	10.1	99.00	
KST-4518▲	45	18	—	13.4	112.00	
KST-4521	45	21	—	15.0	185.00	

*All sloping tops are shipped unassembled only.

National Motor Freight Class: 85

CORNER ANGLES



Corner Angles are a vertical product, but shown horizontal for clarity of detail.

National Motor Freight Class: 85

CORNER ANGLE (J)						
CAT. NO.	W	D	H	WT.	PRICE	
LCAF-60	—	—	60	3.9	\$58.00	
LCAF-66	—	—	66	4.2	61.00	
LCAF-72	—	—	72	4.6	57.00	
LCAF-78	—	—	78	4.8	63.00	

FILLER PANEL FRAMES



Filler Panel Frames are a vertical product, but shown horizontal for clarity of detail.

National Motor Freight Class: 85

FILLER PANEL FRAMES (K)						
CAT. NO.	W	D	H	WT.	PRICE	
LFPF-60	—	—	60	3.4	\$79.00	
LFPF-66	—	—	66	3.7	80.00	
LFPF-72	—	—	72	4.0	82.00	
LFPF-78	—	—	78	4.4	83.00	

Standard Colors



▲ Items with these symbols are available to ship in 2-3 days. Limited quantities and select colors.



Locker Accessories

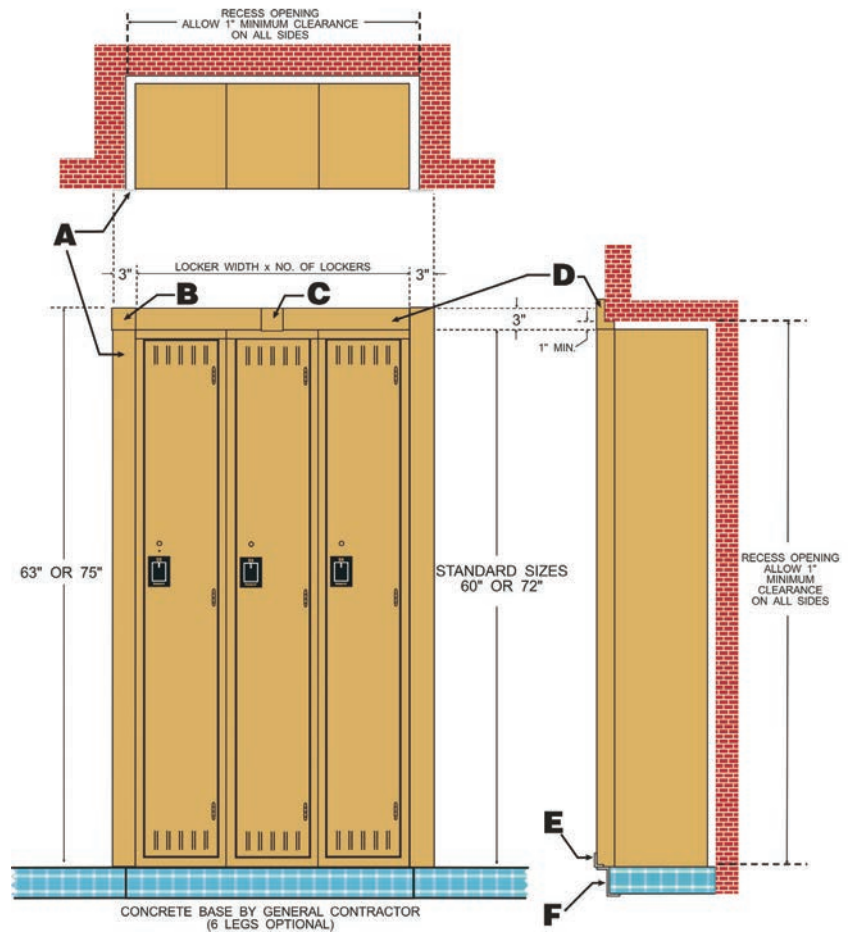

- A. VERTICAL TRIM
- B. CORNER SPLICE CAP
- C. SPLICE CAP
- D. HORIZONTAL TRIM
- E. BOTTOM ANGLE
- F. Z-BRACE

CAT. NO.	DESCRIPTION	W	D	H	WT.	PRICE
LHT-72	HORIZONTAL TRIM	72	—	3	5.6	\$79.00
LVT-60L	VERTICAL TRIM	3	—	60	6.2	82.00
LVT-60R	VERTICAL TRIM	3	—	60	6.2	82.00
LVT-72L	VERTICAL TRIM	3	—	72	7.4	82.00
LVT-72R	VERTICAL TRIM	3	—	72	7.4	82.00

National Motor Freight Class: 85

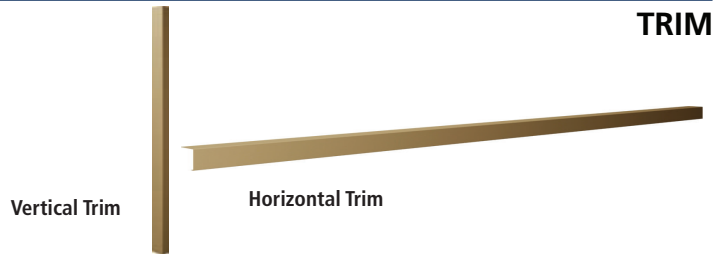

CAT. NO.	DESCRIPTION	W	D	H	WT.	PRICE
LSC-1	SPLICE CAP	3	—	3	0.2	\$37.00
LCSC-1	CORNER SPLICE CAP	4	—	4	0.3	48.00
LOCC-1	OUTSIDE CORNER CAP	3	—	6	0.3	35.00

National Motor Freight Class: 85



BRACES & COVERS

CAT. NO.	DESCRIPTION	W	D	H	WT.	PRICE
LZB-12	Z-BRACE	—	12	3	1.5	\$34.00
LZB-15	Z-BRACE	—	15	3	1.9	49.00
LZB-18	Z-BRACE	—	18	3	2.2	50.00
LBA-12	BOTTOM ANGLE	2	12	—	1.3	35.00
LBA-15	BOTTOM ANGLE	2	15	—	1.6	48.00
LBA-18	BOTTOM ANGLE	2	18	—	1.9	49.00

National Motor Freight Class: 85

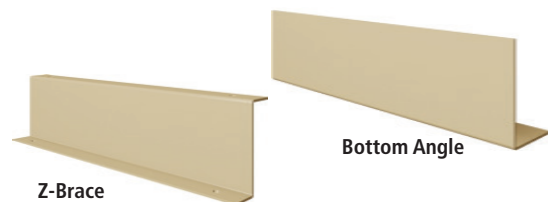

Standard Colors



LOCKERS

Locker Accessories

ADA COMPLIANT LOCKERS



Tennsco ADA Compliant Lockers are specifically designed to provide easier access to contents from a seated position. This is achieved through your choice of a bottom riser to raise the lower shelf, an ADA compliant keyless lock, and reduced-height upper shelf and coat hooks.

The special ADA compliant lock allows the locker to be opened by simply inserting the key. No turning of the key is required, allowing for single-handed operation.

The bottom riser raises items stored on the bottom shelf to a more reachable level.

The reduced height upper shelf and coat hooks bring items normally stored high in the locker down to a reachable level.

Tennsco will modify several of our standard lockers, offering a variety of choices. ADA Compliant Lockers are available for single tier, double tier (bottom locker only), and triple tier (bottom two lockers only) lockers, and can be custom ordered with the ADA features below. Call factory for details. You may also convert your existing lockers to be ADA compliant by ordering the options below.

All ADA Compliant Lockers are shipped with the universal handicap symbol.

Call factory for ADA Lock options.

ADA REDUCED HEIGHT UPPER SHELVES



CAT. NO.	W	D	H	WT.	PRICE
ADALS-1212	12	12	—	2.9	\$37.00
ADALS-1215	12	15	—	3.3	34.00
ADALS-1218	12	18	—	3.9	35.00
ADALS-1518	15	18	—	4.6	45.00
ADALS-1521	15	21	—	5.2	58.00

Shelf includes three coat hooks. May require drilling for installation.

National Motor Freight Class: 85

ADA BOTTOM RISERS



CAT. NO.	W	D	H	WT.	PRICE
ADALSI-1212	12	12	—	2.9	\$37.00
ADALSI-1215	12	15	—	3.3	34.00
ADALSI-1218	12	18	—	3.8	35.00
ADALSI-1518	15	18	—	4.6	45.00
ADALSI-1521	15	21	—	5.2	58.00

For adequate height, must be used only with lockers with legs, or with no-leg lockers installed on a closed base.

National Motor Freight Class: 85

ADA STICKER



CAT. NO.	W	D	H	WT.	PRICE
ADA-STK	2	—	2	0.1	\$7.60

Color options not available.

National Motor Freight Class: 85

Standard Colors (Unless Otherwise Specified)



Sand (SND) Champagne/ Putty (CPY) Light Grey (LGY) Medium Grey (MGY) Black (BLK)

Specialty Lockers

CUBBIES

CAT. NO.	# OF OPENINGS	W	D	H	WT.	PRICE
CC-30	6	34 1/2	13 1/2	30	56.0	\$745.00
CC-40	9	34 1/2	13 1/2	40	76.0	907.00
CC-52	12	34 1/2	13 1/2	52	97.0	1,121.00
CC-66	15	34 1/2	13 1/2	66	120.0	1,310.00
CC-78	18	34 1/2	13 1/2	78	140.0	1,436.00
CLEAR BINS FOR CUBBIES						
CCB-2	-	10 3/32	13 3/4	2 1/4	3.8	\$60.00
CCB-4	-	10 3/32	13 3/4	4 1/4	4.2	65.00
CCB-6	-	10 3/32	13 3/4	6 1/4	4.5	73.00
CCB-8	-	10 3/32	13 3/4	8 1/4	4.8	78.00
EXTRA CUBBY SHELF WITH 4 SHELF CLIPS						
ECS-1	-	10	12 3/4	3/4	1.6	\$19.40
EXTRA SHELF CLIP						
CCC-1	-	-	-	-	0.1	\$1.10
EXTRA COAT HOOK						
LCH-2	-	-	-	-	0.2	\$5.20

3 coat hooks included per unit. Shipped assembled.

National Motor Freight Class: 175



CC-78 with eight CCB-4



CC-66 with three CCB-6

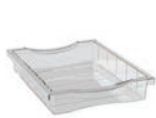

CCB-2



CCB-4



CCB-6



CCB-8



CC-30

LOCKERS

CELL PHONE LOCKERS

CATALOG NUMBER	NO. OF COMPARTMENTS	OPENING			OVERALL UNIT			WEIGHT	PRICE	
		W	D	H	W	D	H			
10 DOORS HIGH										
CP10-091572-A	10	9	15	7	9	15	83	107	\$1,568.00	
CP10-091572-D	40	9	15	7	36	15	83	246	4,415.00	
12 DOORS HIGH										
CP12-091572-A	12	9	15	6	9	15	83	112	\$1,567.00	
CP12-091572-D	48	9	15	6	36	15	83	264	4,605.00	
NUMBER PLATES*										
LNP-A		ALUMINUM NUMBER PLATES (25)						2.5	\$57.00	

*Available only in series of 25 (example: 1-25, 26-50, 51-75, etc.) ranging from 1 through 1000. Must specify number groups when ordering. A pop rivet gun is needed for installation.

Shipped Assembled.

National Motor Freight Class: 175



CP10-091572-D



CP12-091572-A

Standard Colors (Unless Otherwise Specified)



Z-Line Low Profile & Long Span Units

LOW PROFILE SHELVING



- Assembly required.
National Motor Freight Class: 70

Starter units use four EUR uprights and six DRS end supports; adder units use two ZTP uprights and three DRS end supports. Particle board shelves are supported, on front and rear only, by low profile shelf supports (DRS-ww). 36" deep shelves are supported on all four sides.

UNIT SIZE			SHELF LOAD CAPACITY*	STARTER UNITS			ADDER UNITS			EXTRA SHELF LEVEL		
W	D	H		CAT NO.	WT.	PRICE	CAT NO.	WT.	PRICE	CAT NO.	WT.	PRICE
36	12	84	600	ZA7-3612S-4D ▲	65.0	\$263.00	ZA7-3612A-4D ▲	63.0	\$246.00	ZAES-3612D ▲	10.9	\$34.00
42	12	84	550	ZA7-4212S-4D ▲	73.0	289.00	ZA7-4212A-4D ▲	71.0	272.00	ZAES-4212D ▲	12.8	41.00
48	12	84	500	ZA7-4812S-4D ▲	80.0	304.00	ZA7-4812A-4D ▲	78.0	287.00	ZAES-4812D ▲	14.6	44.00
36	18	84	600	ZA7-3618S-4D ▲	83.0	302.00	ZA7-3618A-4D ▲	80.0	280.00	ZAES-3618D ▲	14.7	42.00
42	18	84	550	ZA7-4218S-4D ▲	93.0	332.00	ZA7-4218A-4D ▲	89.0	310.00	ZAES-4218D ▲	17.1	49.00
48	18	84	500	ZA7-4818S-4D ▲	103.0	349.00	ZA7-4818A-4D ▲	99.0	327.00	ZAES-4818D ▲	19.6	53.00
36	24	84	600	ZA7-3624S-4D ▲	99.0	334.00	ZA7-3624A-4D ▲	95.0	312.00	ZAES-3624D ▲	18.4	50.00
42	24	84	550	ZA7-4224S-4D ▲	111.0	372.00	ZA7-4224A-4D ▲	107.0	350.00	ZAES-4224D ▲	22.0	59.00
48	24	84	500	ZA7-4824S-4D ▲	124.0	389.00	ZA7-4824A-4D ▲	120.0	367.00	ZAES-4824D ▲	25.0	63.00
36	36	84	600	ZA7-3636S-4D ▲	136.0	425.00	ZA7-3636A-4D ▲	135.0	423.00	ZAES-3636D ▲	29.0	87.00
42	36	84	550	ZA7-4236S-4D ▲	154.0	462.00	ZA7-4236A-4D ▲	153.0	460.00	ZAES-4236D ▲	34.0	96.00
48	36	84	500	ZA7-4836S-4D ▲	175.0	500.00	ZA7-4836A-4D ▲	174.0	498.00	ZAES-4836D ▲	38.0	106.00

*Load capacity in pounds per shelf level, evenly distributed. Total unit capacity, using four uprights, not to exceed 8,000 lbs., based on 24" centers or less.

LONG SPAN SHELVING



- Assembly required.
National Motor Freight Class: 70

Heavy duty long span units include 3 shelf levels. Units use SUR uprights. Shelves supported on all four sides with heavy duty profile shelf supports (LRA-xx).

UNIT SIZE			SHELF LOAD CAPACITY*	REINFORCEMENTS PER LEVEL	UNITS WITH DECKING			EXTRA SHELF LEVEL		
W	D	H			CAT NO.	WT.	PRICE	CAT NO.	WT.	PRICE
48	24	84	2,250	1	ZL7-4824-3D ▲	125.0	\$466.00	ZLES-4824D ▲	33.0	\$110.00
60	24	84	2,000	1	ZL7-6024-3D ▲	146.0	521.00	ZLES-6024D ▲	40.0	128.00
72	24	84	1,750	2	ZL7-7224-3D ▲	173.0	635.00	ZLES-7224D ▲	49.0	166.00
96	24	84	900	3	ZL7-9624-3D ▲	220.0	782.00	ZLES-9624D ▲	65.0	215.00
48	30	84	2,250	1	ZL7-4830-3D ▲	144.0	513.00	ZLES-4830D ▲	39.0	126.00
60	30	84	2,000	1	ZL7-6030-3D ▲	169.0	577.00	ZLES-6030D ▲	48.0	147.00
72	30	84	1,750	2	ZL7-7230-3D ▲	201.0	700.00	ZLES-7230D ▲	58.0	188.00
96	30	84	900	3	ZL7-9630-3D ▲	256.0	859.00	ZLES-9630D ▲	77.0	241.00
48	36	84	2,250	1	ZL7-4836-3D ▲	166.0	559.00	ZLES-4836D ▲	47.0	141.00
60	36	84	2,000	1	ZL7-6036-3D ▲	192.0	644.00	ZLES-6036D ▲	55.0	169.00
72	36	84	1,750	2	ZL7-7236-3D ▲	229.0	757.00	ZLES-7236D ▲	68.0	207.00
96	36	84	900	3	ZL7-9636-3D ▲	293.0	954.00	ZLES-9636D ▲	89.0	273.00
48	48	84	2,250	1	ZL7-4848-3D ▲	202.0		ZLES-4848D ▲	59.0	
60	48	84	2,000	1	ZL7-6048-3D ▲	238.0	727.00	ZLES-6048D ▲	71.0	197.00
72	48	84	1,750	2	ZL7-7248-3D ▲	285.0	890.00	ZLES-7248D ▲	86.0	251.00
96	48	84	900	3	ZL7-9648-3D ▲	367.0	1,128.00	ZLES-9648D ▲	114.0	331.00

*Load capacity in pounds per shelf level, evenly distributed. Total unit capacity not to exceed 13,000 lbs. per unit (3,250 lbs. per post) based on 24" centers or less.

Standard Colors



▲ Items with these symbols are available to ship in 2-3 days. Limited quantities and select colors.



Steel Shelf Units



SOLID STEEL SHELF UNITS

- Assembly required.
National Motor Freight Class: 70

Starter and adder units include 5 shelf levels. Starter units use 4 EUR uprights; adder units use 2 ZTP uprights. Each unit is stabilized by VDRS shelf supports at both top and bottom. Intermediate shelves are attached by 4 ZSC-1 shelf clips. No sway braces required, allowing access from all 4 sides.

UNIT SIZE			SHELF LOAD CAPACITY*	STARTER UNITS			ADDER UNITS			EXTRA SHELF LEVEL		
W	D	H		CAT NO.	WT.	PRICE	CAT NO.	WT.	PRICE	CAT NO.	WT.	PRICE
36	12	84	750	ZM7-3612S-5D ♣	61.0	\$371.00	ZM7-3612A-5D ♣	59.0	\$359.00	ZMS-3612 ♣	6.7	\$44.00
42	12	84	600	ZM7-4212S-5D ♣	68.0	428.00	ZM7-4212A-5D ♣	66.0	416.00	ZMS-4212 ♣	7.7	54.00
48	12	84	500	ZM7-4812S-5D ♣	74.0	422.00	ZM7-4812A-5D ♣	72.0	410.00	ZMS-4812 ♣	8.7	52.00
36	18	84	750	ZM7-3618S-5D ♣	73.0	426.00	ZM7-3618A-5D ♣	70.0	411.00	ZMS-3618 ♣	8.8	54.00
42	18	84	600	ZM7-4218S-5D ♣	81.0	474.00	ZM7-4218A-5D ♣	78.0	459.00	ZMS-4218 ♣	10.1	62.00
48	18	84	500	ZM7-4818S-5D ♣	89.0	503.00	ZM7-4818A-5D ♣	86.0	488.00	ZMS-4818 ♣	11.4	67.00
36	24	84	700	ZM7-3624S-5D ♣	85.0	482.00	ZM7-3624A-5D ♣	81.0	464.00	ZMS-3624 ♣	10.9	64.00
42	24	84	550	ZM7-4224S-5D ♣	95.0	539.00	ZM7-4224A-5D ♣	91.0	522.00	ZMS-4224 ♣	12.5	74.00
48	24	84	450	ZM7-4824S-5D ♣	104.0	563.00	ZM7-4824A-5D ♣	100.0	545.00	ZMS-4824 ♣	14.1	78.00
36	36	84	600	ZM7-3636S-5D ♣	122.0	772.00	ZM7-3636A-5D ♣	118.0	747.00	ZMS-3636 ♣	17.9	119.00
42	36	84	550	ZM7-4236S-5D ♣	137.0	843.00	ZM7-4236A-5D ♣	132.0	809.00	ZMS-4236 ♣	21.0	130.00
48	36	84	450	ZM7-4836S-5D ♣	150.0	903.00	ZM7-4836A-5D ♣	146.0	878.00	ZMS-4836 ♣	23.0	143.00

*Load capacity figures are calculated in pounds per shelf level, evenly distributed. Total unit capacity, using four EUR uprights, not to exceed 8,000 lbs., based on 24" centers or less.



PERFORATED STEEL SHELF UNITS

- Assembly required.
National Motor Freight Class: 70

SHELVING

Starter and adder units include 5 shelf levels. Starter units use 4 EUR uprights; adder units use 2 ZTP uprights. Each unit is stabilized by VDRS shelf supports at both top and bottom. Intermediate shelves are attached by 4 ZSC-1 shelf clips. No sway braces required, allowing access from all 4 sides.

UNIT SIZE			SHELF LOAD CAPACITY*	STARTER UNITS			ADDER UNITS			EXTRA SHELF LEVEL			
W	D	H		CAT NO.	WT.	PRICE	CAT NO.	WT.	PRICE	CAT NO.	WT.	PRICE	
NEW	36	12	84	450	ZM7-3612S-5PD ♣	61.0		ZM7-3612A-5PD ♣	59.0		ZMPS-3612 ♣	6.7	\$48.00
	48	12	84	300	ZM7-4812S-5PD ♣	74.0	452.00	ZM7-4812A-5PD ♣	72.0	479.00	ZMPS-4812 ♣	8.7	66.00
	36	18	84	450	ZM7-3618S-5PD ♣	73.0	491.00	ZM7-3618A-5PD ♣	70.0		ZMPS-3618 ♣	8.8	67.00
NEW	42	18	84	375	ZM7-4218S-5PD ♣	81.0	494.00	ZM7-4218A-5PD ♣	78.0		ZMPS-4218 ♣	10.1	57.00
	48	18	84	300	ZM7-4818S-5PD ♣	89.0	533.00	ZM7-4818A-5PD ♣	86.0		ZMPS-4818 ♣	11.4	73.00
	36	24	84	450	ZM7-3624S-5PD ♣	85.0	532.00	ZM7-3624A-5PD ♣	81.0	514.00	ZMPS-3624 ♣	10.9	74.00
NEW	42	24	84	325	ZM7-4224S-5PD ♣	95.0		ZM7-4224A-5PD ♣	91.0		ZMPS-4224 ♣	12.5	75.00
	48	24	84	250	ZM7-4824S-5PD ♣	104.0	613.00	ZM7-4824A-5PD ♣	100.0		ZMPS-4824 ♣	14.1	88.00
	36	36	84	400	ZM7-3636S-5PD ♣	122.0		ZM7-3636A-5PD ♣	118.0		ZMPS-3636 ♣	17.9	
NEW	42	36	84	250	ZM7-4236S-5PD ♣	137.0		ZM7-4236A-5PD ♣	132.0		ZMPS-4236 ♣	21.0	
	48	36	84	175	ZM7-4836S-5PD ♣	150.0	818.00	ZM7-4836A-5PD ♣	146.0		ZMPS-4836 ♣	23.0	126.00

*Load capacity figures are calculated in pounds per shelf level, evenly distributed. Total unit capacity, using four EUR uprights, not to exceed 8,000 lbs., based on 24" centers or less.

Standard Colors



♣ Items with these symbols are available to ship in 2-3 days. Limited quantities and select colors.



RECORD ARCHIVE STORAGE RACKS

UNIT SIZE			NO. OF OPENINGS	SHELF LOAD CAPACITY*	SHELVING UNITS		
W	D	H			CAT NO.	WT.	PRICE
42	15	60	2	2,250	ZA421560-3D ▲	73.0	\$286.00
69	15	60	2	1,800	ZA691560-3D ▲	111.0	416.00
42	15	84	3	2,250	ZA421584-4D ▲	98.0	384.00
69	15	84	3	1,800	ZA691584-4D ▲	148.0	558.00
42	30	60	2	2,250	ZA423060-3D ▲	113.0	367.00
69	30	60	2	1,800	ZA693060-3D ▲	175.0	582.00
42	30	84	3	2,250	ZA423084-4D ▲	151.0	492.00
69	30	84	3	1,800	ZA693084-4D ▲	234.0	780.00

*Load capacity figures are calculated in pounds per shelf level, evenly distributed. Total unit capacity, using four EUR uprights, not to exceed 8,000 lbs., based on 24" centers or less.



ZA423084-4D

National Motor Freight Class: 70

- Assembly required.

HEAVY-DUTY REINFORCED SHELVING (DIE RACK UNIT)



RXHS-602484

Die rack units include 5 shelf levels.

Available in Medium Grey only.

- Assembly required.

National Motor Freight Class: 70



RXHS-962484

UNIT SIZE			SHELF LOAD CAPACITY*	REINFORCEMENTS PER LEVEL	SHELVING UNITS			EXTRA SHELF LEVEL		
W	D	H			CAT NO.	WT.	PRICE	CAT NO.	WT.	PRICE
36	18	72	4,000	1	RXHS-361872 ♣	147.0	\$860.00	RXHS-3618 ♣	25.0	\$162.00
48	18	72	4,000	1	RXHS-481872 ♣	181.0	1,053.00	RXHS-4818 ♣	32.0	187.00
36	18	84	4,000	1	RXHS-361884 ♣	151.0	884.00	RXHS-3618 ♣	25.0	162.00
48	18	84	4,000	1	RXHS-481884 ♣	185.0	1,077.00	RXHS-4818 ♣	32.0	187.00
36	18	96	4,000	1	RXHS-361896 ♣	155.0	904.00	RXHS-3618 ♣	25.0	162.00
48	18	96	4,000	1	RXHS-481896 ♣	189.0	1,097.00	RXHS-4818 ♣	32.0	187.00
36	24	72	4,000	1	RXHS-362472 ♣	202.0	988.00	RXHS-3624 ♣	32.0	174.00
48	24	72	4,000	1	RXHS-482472 ♣	214.0	1,153.00	RXHS-4824 ♣	40.0	212.00
60	24	72	3,250	1	RXHS-602472 ♣	255.0	1,374.00	RXHS-6024 ♣	47.0	273.00
72	24	72	2,750	2	RXHS-722472 ♣	305.0	1,627.00	RXHS-7224 ♣	57.0	330.00
36	24	84	4,000	1	RXHS-362484 ♣	206.0	1,012.00	RXHS-3624 ♣	32.0	174.00
48	24	84	4,000	1	RXHS-482484 ♣	218.0	1,177.00	RXHS-4824 ♣	40.0	212.00
60	24	84	3,250	1	RXHS-602484 ♣	259.0	1,398.00	RXHS-6024 ♣	47.0	273.00
72	24	84	2,750	2	RXHS-722484 ♣	309.0	1,651.00	RXHS-7224 ♣	57.0	330.00
96	24	84	2,600	3	RXHS-962484 ♣	413.0	2,263.00	RXHS-9624 ♣	78.0	432.00
36	24	96	4,000	1	RXHS-362496 ♣	210.0	1,032.00	RXHS-3624 ♣	32.0	174.00
48	24	96	4,000	1	RXHS-482496 ♣	222.0	1,197.00	RXHS-4824 ♣	40.0	212.00
60	24	96	3,250	1	RXHS-602496 ♣	263.0	1,418.00	RXHS-6024 ♣	47.0	273.00
72	24	96	2,750	2	RXHS-722496 ♣	313.0	1,671.00	RXHS-7224 ♣	57.0	330.00
96	24	96	2,600	3	RXHS-962496 ♣	417.0	2,283.00	RXHS-9624 ♣	78.0	432.00
72	36	84	2,750	2	RXHS-723684 ♣	419.0	2,222.00	RXHS-7236 ♣	79.0	423.00
96	36	84	2,600	3	RXHS-963684 ♣	560.0	2,804.00	RXHS-9636 ♣	108.0	541.00
72	36	96	2,750	2	RXHS-723696 ♣	424.0	2,242.00	RXHS-7236 ♣	79.0	423.00
96	36	96	2,600	3	RXHS-963696 ♣	565.0	2,824.00	RXHS-9636 ♣	108.0	541.00

*Load capacities are per shelf, evenly distributed. Weight not to exceed a total of 13,000 lbs. per unit and based on shelves spaced on 24" centers. Other heights are available; call factory for pricing.

Standard Colors



▲ ♣
Items with these symbols are available to ship in 2-3 days. Limited quantities and select colors.

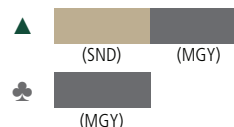

SHELVING

Z-Line Sloping Shelf & Tire Rack Units

SLOPING SHELF UNITS (FLAT SLOPE STYLE)



Includes 5 sloped shelves and one top shelf.



Units can be placed back to back for double entry (shown).

- Assembly required.
National Motor Freight Class: 70

UNIT SIZE			SHELF LOAD CAPACITY*	STARTER UNITS			ADDER UNITS			EXTRA SHELF LEVEL		
W	D	H		CAT NO.	WT.	PRICE	CAT NO.	WT.	PRICE	CAT NO.	WT.	PRICE
36	18	84	450	ZT7-3618S-5♣	137.0	\$931.00	ZT7-3618A-5♣	136.0	\$929.00	ZSSS-3618	17.9	\$142.00
48	18	84	350	ZT7-4818S-5♣	187.0	1,185.00	ZT7-4818A-5♣	186.0	1,183.00	ZSSS-4818	27.0	182.00
36	24	84	450	ZT7-3624S-5♣	160.0	1,046.00	ZT7-3624A-5♣	159.0	1,044.00	ZSSS-3624	23.0	165.00
48	24	84	350	ZT7-4824S-5♣	217.0	1,305.00	ZT7-4824A-5♣	217.0	1,303.00	ZSSS-4824	33.0	201.00

*Load capacities are per shelf, evenly distributed and based on shelves spaced on 24" centers. Weight not to exceed a total of 1,500 lbs. per unit.

TIRE RACK



ZST-6084S



ZDT-6084S

NOT FOR USE WITH TIRES MOUNTED ON WHEELS

NOTE: Single Entry units must be tied to wall.

Single Entry units include one 12" deep unit and one 9" wall tie.

Double Entry units include two 12" deep units and one 18" deep cross aisle tie.

- Assembly required.

National Motor Freight Class: 70

UNIT SIZE			# OF OPENINGS	TIRE CAP.	STARTER UNITS			ADDER UNITS		
W	D	H			CAT NO.	WT.	PRICE	CAT NO.	WT.	PRICE
SINGLE ENTRY										
60	21*	60	2	16	ZST-6060S▲	38.0	\$219.00	ZST-6060A▲	34.0	\$199.00
60	21*	84	3	24	ZST-6084S▲	53.0	293.00	ZST-6084A▲	48.0	265.00
60	21*	120	4	32	ZST-60120S▲	74.0	422.00	ZST-60120A▲	67.0	371.00
60	21*	144	5	40	ZST-60144S▲	91.0	515.00	ZST-60144A▲	82.0	463.00
DOUBLE ENTRY										
60	42**	60	4	32	ZDT-6060S▲	80.0	\$475.00	ZDT-6060A▲	70.0	\$416.00
60	42**	84	6	48	ZDT-6084S▲	108.0	624.00	ZDT-6084A▲	98.0	548.00
60	42**	120	8	64	ZDT-60120S▲	146.0	826.00	ZDT-60120A▲	133.0	733.00
60	42**	144	10	80	ZDT-60144S▲	178.0	1,012.00	ZDT-60144A▲	172.0	984.00

*Single Entry units include one 12" deep unit and necessary 9" deep wall tie(s). Quantity depends on height.

**Double Entry units include two 12" deep units and necessary 18" deep cross aisle tie(s). Quantity depends on height.

Standard Colors



Sand (SND) Light Grey (LGY) Medium Grey (MGY)

▲ ♣
Items with these symbols are available to ship in 2-3 days. Limited quantities and select colors.

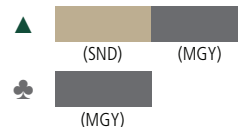

(SND) (MGY)
(MGY)

HORIZONTAL BAR RACK

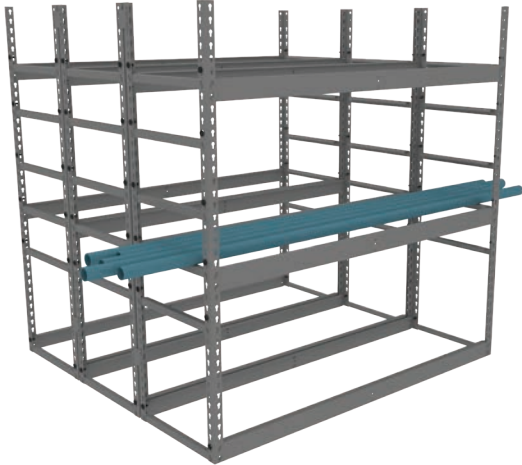

UNIT SIZE			NO. OF BAYS	BAY CAPACITY	CAT NO.	SHELVING UNITS	
W	D	H				WT.	PRICE
56	60	60	15	500*	PR-601860-6	160.0	

*Load capacity per bay is based on evenly distributed loads. Overall unit capacity not to exceed 8,000 lbs.

Storage bays snap into place and adjust at 1 1/2" increments.

Available in Medium Grey only.

National Motor Freight Class: 70

- Assembly required.

REEL RACK



UNIT SIZE			ROD CAPACITY	UNIT CAPACITY	CAT NO.	WT.	PRICE
W	D	H					
36	24	84	150*	2,000	REEL-362484-6-MGY	84.0	
48	24	84	100*	2,000	REEL-482484-6-MGY	93.0	
EXTRA RODS							
36	5/8	--	150*	--	045CR-MGY	0.9	
48	5/8	--	100*	--	055CR-MGY	1.3	

Levels adjust vertically in 1 1/2" increments to customize storage. Each level can hold up to 3 rods. Reel rack unit includes 6 rods.

*Rod capacity is based on evenly distributed loads.

Available in Medium Grey only.

National Motor Freight Class: 70

- Assembly required.

STUR-D-STOR SHELVING



May be configured as a five-shelf shelving unit or as a work table.



CAT. NO.	SHELF LEV. CAP.	NO. OF OPENINGS	W	D	H	WT.	PRICE
SHELVING PACKAGE							
LSS-361872	1,000	4	36 1/2	18 1/2	72	88.0	\$397.00
LSS-482484	850	4	48 1/2	24 1/2	84	142.0	\$513.00
HARD NYLON PROTECTIVE FOOT CAP							
EURNF	—	—	1 1/2	1 1/2	3/4	0.1	\$1.40

Includes 1/2" thick particleboard shelves and 8 plastic post caps. Ships in one pre-packaged box.

Shelving available in Sand only. Protective foot caps are available in Black only.

- Assembly required.

National Motor Freight Class: 70



EURNF

Standard Colors (Unless Otherwise Specified)



Items with these symbols are available to ship in 2-3 days. Limited quantities and select colors.

Z-Line Components: Posts & Supports

UPRIGHT POSTS

CAT. NO.	W	D	LENGTH	WT.	PRICE
STANDARD ANGLE POST					
EUR-36 ▲	1 15/32	1 15/32	36	2.0	\$11.70
EUR-48 ▲	1 15/32	1 15/32	48	2.7	15.10
EUR-60 ▲	1 15/32	1 15/32	60	3.4	17.40
EUR-72 ▲	1 15/32	1 15/32	72	4.0	20.00
EUR-84 ▲	1 15/32	1 15/32	84	4.7	24.00
EUR-96 ▲	1 15/32	1 15/32	96	5.4	27.00
EUR-108 ▲	1 15/32	1 15/32	108	6.0	31.00
EUR-120 ▲	1 15/32	1 15/32	120	6.7	34.00
EUR-132	1 15/32	1 15/32	132	7.4	39.00
EUR-144 ▲	1 15/32	1 15/32	144	8.1	42.00
INTERMEDIATE "T" POST					
ZTP-36	3 3/8	1 15/32	36	3.9	\$22.00
ZTP-48 ▲	3 3/8	1 15/32	48	5.1	30.00
ZTP-60 ▲	3 3/8	1 15/32	60	6.4	38.00
ZTP-72 ▲	3 3/8	1 15/32	72	7.7	43.00
ZTP-84 ▲	3 3/8	1 15/32	84	9.0	47.00
ZTP-96 ▲	3 3/8	1 15/32	96	10.3	57.00
ZTP-108 ▲	3 3/8	1 15/32	108	11.6	59.00
ZTP-120 ▲	3 3/8	1 15/32	120	12.8	66.00
ZTP-132	3 3/8	1 15/32	132	14.1	78.00
ZTP-144 ▲	3 3/8	1 15/32	144	15.4	85.00
HIGH CAPACITY ANGLE POST					
SUR-36	2 1/16	2 1/16	36	2.8	\$15.90
SUR-48	2 1/16	2 1/16	48	3.7	21.00
SUR-60 ▲	2 1/16	2 1/16	60	4.7	25.00
SUR-72 ▲	2 1/16	2 1/16	72	5.4	28.00
SUR-84 ▲	2 1/16	2 1/16	84	6.5	34.00
SUR-96 ▲	2 1/16	2 1/16	96	7.6	39.00
SUR-108	2 1/16	2 1/16	108	8.5	45.00
SUR-120 ▲	2 1/16	2 1/16	120	9.2	47.00
SUR-132	2 1/16	2 1/16	132	10.4	54.00
SUR-144 ▲	2 1/16	2 1/16	144	11.4	58.00
SUR-168	2 1/16	2 1/16	168	13.3	68.00
SUR-181.5	2 1/16	2 1/16	181.5	14.3	74.00



STANDARD ANGLE POST (EUR)

Total weight capacity not to exceed 8,000 lbs. per unit (2,000 lbs. per post), based on 24" shelf centers or less.

INTERMEDIATE "T" POST (ZTP)

Total weight capacity not to exceed 11,000 lbs. per unit (5,500 lbs. per post), based on 24" shelf centers or less.



HIGH CAPACITY ANGLE POST (SUR)

Total weight capacity not to exceed 13,000 lbs. per unit (3,250 lbs. per post), based on 24" shelf centers or less.

All posts slotted for shelf adjustment on 1/2" centers.

National Motor Freight Class: 50

CAT. NO.	LOAD CAP.*	GA.	LENGTH	WT.	PRICE
LOW PROFILE SHELF SUPPORTS					
DRS-1214 ▲	600	14	11.5	0.5	\$5.10
DRS-1514 ▲	600	14	14.5	0.7	5.80
DRS-1814 ▲	600	14	17.5	0.8	6.60
DRS-2414 ▲	600	14	23.5	1.1	6.60
DRS-3014 ▲	600	14	29.5	1.4	8.00
DRS-3611 ▲	850	11	35.5	2.8	15.70
DRS-3614 ▲	600	14	35.5	1.7	9.30
DRS-4211 ▲	800	11	41.5	3.2	16.90
DRS-4214 ▲	550	14	41.5	2.0	10.50
DRS-4811 ▲	750	11	47.5	3.7	18.20
DRS-4814 ▲	500	14	47.5	2.3	11.70

SHELF SUPPORTS

LOW PROFILE SHELF SUPPORTS



Profile View



Shelf supports are 27/32" d x 11/8" h.

*Load capacities are based on evenly distributed loads.

National Motor Freight Class: 70

CAT. NO.	LOAD CAP.*	RECOMMENDED # REINFORCEMENTS	GA.	LENGTH	WT.	PRICE
MEDIUM DUTY SHELF SUPPORTS						
VDRS-1216	1,000	—	16	11.5	0.6	\$5.10
VDRS-1516	1,000	—	16	14.5	0.8	5.90
VDRS-1816 ▲	1,000	—	16	17.5	0.9	6.50
VDRS-2416 ▲	1,000	—	16	23.5	1.3	7.80
VDRS-3016 ▲	1,000	—	16	29.5	1.5	10.40
VDRS-3616 ▲	1,000	1	16	35.5	1.8	11.60
VDRS-4216 ▲	900	1	16	41.5	2.2	13.50
VDRS-4814	1,000	1	14	47.5	3.6	23.00
VDRS-4816 ▲	850	1	16	47.5	2.5	14.40
VDRS-6014 ▲	750	1	14	59.5	4.6	27.00
VDRS-6614	700	1	14	65.5	5.0	28.00
VDRS-6914 ▲	650	2	14	68.5	5.2	30.00
VDRS-7214 ▲	600	2	14	71.5	5.4	31.00

MEDIUM DUTY SHELF SUPPORTS



14 Gauge Profile View



16 Gauge Profile View



Supports slotted for optional FBSV-dd front-to-back deck supports. Load capacities are based on recommended number of deck supports.

National Motor Freight Class: 70

Standard Colors

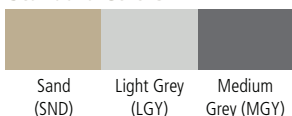

▲ Items with this symbol are available to ship in 2-3 days. Limited quantities and select colors.



SHELF SUPPORTS

HEAVY-DUTY SHELF SUPPORTS

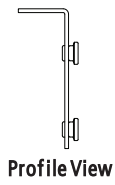

Profile View



Front-to-back shelf supports are 1" d x 2 3/4" h. Load capacities are based on width of shelf. Front-to-back deck supports do not have center rivets for shelf reinforcements.

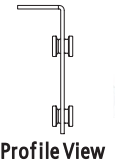

Profile View



Left-to-right shelf supports are 1" d x 2 3/4" h.

EXTRA HEAVY-DUTY SHELF SUPPORTS

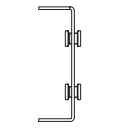

Profile View

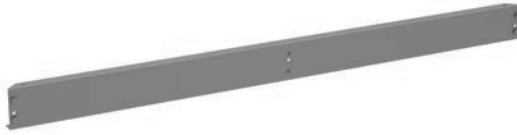

Shelf supports are 1" d x 3 1/4" h.

Use left to right only; not to be used front to back. Cannot be installed in bottom two keyholes of uprights; Will not sit flush on the floor.

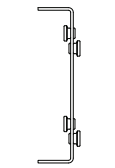

Profile View

SEISMIC SUPPORT CHANNEL



Shelf supports are 1 1/2" d x 4 13/32" h.

Allows unit to be secured to floor in order to meet seismic requirements.

CAT. NO.	LOAD CAP.*	RECOMMENDED # REINFORCEMENTS	GA.	LENGTH	WT.	PRICE
HEAVY-DUTY SHELF SUPPORTS (Front-to-Back)						
LRA-12 ▲	—	—	14	11.5	0.9	\$6.60
LRA-15 ▲	—	—	14	14.5	1.2	8.40
LRA-16	—	—	14	15.5	1.3	8.50
LRA-18 ▲	—	—	14	17.5	1.4	8.50
LRA-24 ▲	—	—	14	23.5	1.9	10.70
LRA-30 ▲	—	—	14	29.5	2.3	12.40
LRA-32	—	—	14	31.5	2.5	15.10
LRA-36G	—	—	14	35.5	2.8	14.90
LRA-42G	—	—	14	41.5	3.3	16.60
LRA-48G	—	—	14	47.5	3.7	18.80
HEAVY-DUTY SHELF SUPPORTS (Left-to-Right)						
LRA-36 ▲	2,250	1	14	35.5	2.8	\$15.10
LRA-42 ▲	2,250	1	14	41.5	3.3	17.70
LRA-48 ▲	2,250	1	14	47.5	3.7	19.80
LRA-60 ▲	2,000	1	14	59.5	4.7	24.00
LRA-69 ▲	1,800	1	14	68.5	5.4	27.00
LRA-72 ▲	1,750	2	14	71.5	5.7	31.00
LRA-84 ▲	1,500	3	14	83.5	6.6	39.00
LRA-96 ▲	900	3	14	95.5	7.5	43.00
EXTRA HEAVY-DUTY SHELF SUPPORTS						
LRC-48 ▲	2,500	1	14	47.5	5.2	\$25.00
LRC-60	2,250	1	14	59.5	6.2	32.00
LRC-72 ▲	2,000	2	14	71.5	7.4	38.00
LRC-84 ▲	1,750	3	14	83.5	8.7	46.00
LRC-96 ▲	1,600	3	14	95.5	9.9	50.00
SEISMIC SHELF SUPPORTS						
SSC-36	2,750	1	14	35.5	4.7	\$30.00
SSC-48	2,500	1	14	47.5	6.3	36.00
SSC-60	2,250	1	14	59.5	7.9	46.00
SSC-72	2,000	2	14	71.5	9.5	51.00
SSC-84	1,750	3	14	83.5	11.1	59.00
SSC-96	1,600	3	14	95.5	12.7	69.00

*Load capacities are based on evenly distributed loads with the recommended number of SDS-dd front-to-back deck reinforcements.

National Motor Freight Class: 70

DECK REINFORCEMENTS

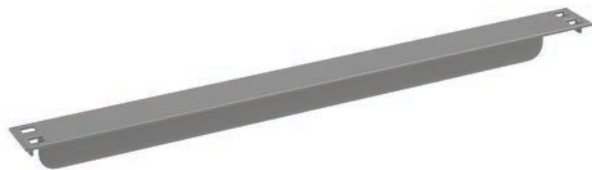

Medium duty provides center reinforcement for decking. Use with VDRS supports.



Heavy duty provides center reinforcement for decking. Use with LRA, LRC or SSC supports.

CAT. NO.	W	D	H	WT.	PRICE
MEDIUM DUTY DECK REINFORCEMENTS					
FBSV-12	1 5/8	12	1 5/8	0.6	\$6.60
FBSV-15 ▲	1 5/8	15	1 5/8	0.8	7.00
FBSV-18 ▲	1 5/8	18	1 5/8	0.9	7.40
FBSV-24 ▲	1 5/8	24	1 5/8	1.3	8.50
FBSV-30 ▲	1 5/8	30	1 5/8	1.6	9.70
FBSV-36 ▲	1 5/8	36	1 5/8	1.9	11.20
FBSV-42	1 5/8	42	1 5/8	2.2	16.20
FBSV-48 ▲	1 5/8	48	1 5/8	2.5	18.10
HEAVY DUTY DECK REINFORCEMENTS					
SDS-12 ▲	7/8	12	2 11/16	1.0	\$5.40
SDS-15 ▲	7/8	15	2 11/16	1.2	6.60
SDS-16	7/8	16	2 11/16	1.3	7.40
SDS-18 ▲	7/8	18	2 11/16	1.4	7.40
SDS-24 ▲	7/8	24	2 11/16	1.9	9.00
SDS-30 ▲	7/8	30	2 11/16	2.4	11.10
SDS-32	7/8	32	2 11/16	2.5	12.60
SDS-36 ▲	7/8	36	2 11/16	2.8	12.60
SDS-42	7/8	42	2 11/16	3.3	16.50
SDS-48 ▲	7/8	48	2 11/16	3.8	16.30

National Motor Freight Class: 70

Standard Colors



▲ Items with this symbol are available to ship in 2-3 days. Limited quantities and select colors.



Z-Line Components: Decking Options

PARTICLEBOARD DECKING



Industrial grade 5/8" thick particleboard provides a sturdy work surface that is both strong and economical.

CAT. NO.	W	D	H	WT.	PRICE
PB-3612	36	12	5/8	7.5	\$15.50
PB-3615	36	15	5/8	9.4	17.60
PB-3618	36	18	5/8	11.3	23.00
PB-3624	36	24	5/8	15.0	31.00
PB-3630	36	30	5/8	18.8	38.00
PB-3636	36	36	5/8	22.5	45.00
PB-4212	42	12	5/8	8.8	19.60
PB-4215	42	15	5/8	10.9	22.00
PB-4218	42	18	5/8	13.1	28.00
PB-4224	42	24	5/8	17.5	38.00
PB-4230	42	30	5/8	21.9	41.00
PB-4236	42	36	5/8	26.3	52.00
PB-4812	48	12	5/8	10.0	21.00
PB-4815	48	15	5/8	12.5	26.00
PB-4818	48	18	5/8	15.0	30.00
PB-4824	48	24	5/8	20.0	40.00
PB-4830	48	30	5/8	25.0	50.00
PB-4836	48	36	5/8	31.0	59.00
PB-4842	48	42	5/8	35.0	97.00
PB-4848	48	48	5/8	40.0	81.00
PB-6024	60	24	5/8	25.0	50.00
PB-6030	60	30	5/8	31.3	63.00
PB-6036	60	36	5/8	37.5	79.00
PB-6048	60	48	5/8	50.0	95.00
PB-6915	69	15	5/8	18.0	38.00
PB-6930	69	30	5/8	35.9	81.00
PB-7224	72	24	5/8	30.0	65.00
PB-7230	72	30	5/8	37.5	79.00
PB-7236	72	36	5/8	45.0	90.00
PB-7248	72	48	5/8	60.0	119.00
PB-8424	84	24	5/8	35.0	81.00
PB-8430	84	30	5/8	50.0	97.00
PB-8436	84	36	5/8	52.5	119.00
PB-8448	84	48	5/8	70.0	158.00
PB-9624	96	24	5/8	40.0	81.00
PB-9630	96	30	5/8	50.0	97.00
PB-9636	96	36	5/8	60.0	119.00
PB-9648	96	48	5/8	80.0	158.00

Available in Natural only.
National Motor Freight Class: 55

STEEL SHELVES

Attaches to upright posts with four shelf clips per shelf (included). Shelf clips allow for access from all four sides of the unit.

NOTE: When building your own unit with steel shelves, you MUST use VDRS supports at the top and bottom of the unit, on all four sides for stabilization. Shelf clips alone are NOT sufficient to stabilize unit.

In addition, units 96" and taller must use VDRS supports in the center of the unit, on all four sides.

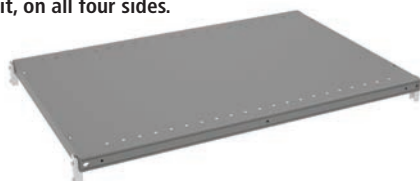

Shelf Clip

Standard Colors (Unless Otherwise Specified)



WIRE DECKING

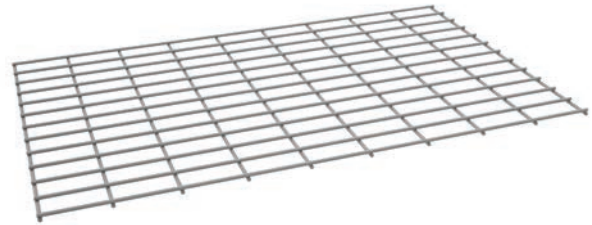

Wire decking uses 5 gauge wire & consists of a 2" x 4" mesh pattern. Additional sizes are available; contact factory for pricing. Wire decking is subject to longer than normal lead times; contact factory for specifics.

Not recommended for shelf levels with DRS supports deeper than 24".

CAT. NO.	W	D	H	WT.	PRICE
ZWD-3612	36	12	5/16	4.0	\$54.00
ZWD-3618	36	18	5/16	6.0	65.00
ZWD-3624	36	24	5/16	8.0	73.00
ZWD-3636	36	36	5/16	12.0	89.00
ZWD-4218	42	18	5/16	7.1	89.00
ZWD-4224	42	24	5/16	9.3	90.00
ZWD-4230	42	30	5/16	11.7	112.00
ZWD-4236	42	36	5/16	14.2	107.00
ZWD-4812	48	12	5/16	5.4	57.00
ZWD-4815	48	15	5/16	7.0	85.00
ZWD-4818	48	18	5/16	8.0	70.00
ZWD-4824	48	24	5/16	10.7	85.00
ZWD-4836	48	36	5/16	16.0	116.00
ZWD-4848	48	48	5/16	21.0	149.00
ZWD-6030	60	30	5/16	13.3	153.00
ZWD-6036	60	36	5/16	20.0	153.00
ZWD-6048	60	48	5/16	27.0	211.00
ZWD-6930	69	30	5/16	19.2	132.00
ZWD-7224	72	24	5/16	16.0	131.00
ZWD-7236	72	36	5/16	24.0	161.00
ZWD-7248	72	48	5/16	32.0	190.00
ZWD-8424*	84	24	5/16	19.0	154.00
ZWD-8436*	84	36	5/16	28.0	193.00
ZWD-8448*	84	48	5/16	37.0	230.00
ZWD-9624*	96	24	5/16	21.0	170.00
ZWD-9636*	96	36	5/16	32.0	232.00
ZWD-9648*	96	48	5/16	42.0	298.00

*84" w and 96" w are shipped as two pieces and should be tied together with zip ties.

NOTE: Price shown is for Medium Grey. For price of Sand or Light Grey, add a 10% upcharge.

National Motor Freight Class: 70

CAT. NO.	Load Cap.	W	D	H	WT.	PRICE
22 Gauge						
ZMS-3612	750	36	12	1 5/16	6.7	\$44.00
ZMS-3618	750	36	18	1 5/16	8.8	54.00
ZMS-3624	700	36	24	1 5/16	10.9	64.00
ZMS-4212	600	42	12	1 5/16	7.7	54.00
ZMS-4218	600	42	18	1 5/16	7.7	62.00
ZMS-4224	550	42	24	1 5/16	10.1	74.00
ZMS-4812	500	48	12	1 5/16	8.7	52.00
ZMS-4818	500	48	18	1 5/16	11.4	67.00
ZMS-4824	450	48	24	1 5/16	14.1	78.00
20 Gauge						
ZMS-3636	600	36	36	1 5/16	17.9	\$119.00
ZMS-4236	550	42	36	1 5/16	21.0	130.00
ZMS-4836	450	48	36	1 5/16	23.0	143.00
REPLACEMENT SHELF CLIPS						
ZSC-1	—	—	—	—	0.1	\$1.50

National Motor Freight Class: 70

■ ♣ ▼
 Items with these symbols are available to ship in 2-3 days. Limited quantities and select colors.



SHELVING

Z-Line Components: Accessories

SIDE AND BACK PANELS

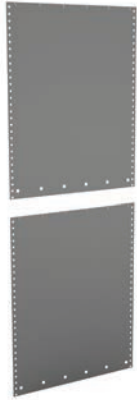

BACK PANEL
Back panels fit units with EUR and ZTP posts. Back consists of two pieces. Includes 10 attachment clips. Other sizes available; contact factory.



SIDE PANEL
Side panels fit starter units with EUR posts only. Side consists of two pieces. Includes 10 attachment clips. Other sizes available; contact factory.

CAT. NO.	W	D	H	WT.	PRICE
SIDE PANELS					
ZLEP-1284	—	12	84	11.5	\$110.00
ZLEP-1584	—	15	84	14.0	114.00
ZLEP-1884	—	18	84	16.6	127.00
ZLEP-2484	—	24	84	22.0	150.00
ZLEP-3084	—	30	84	27.0	291.00
BACK PANELS					
ZLBP-3684	36	—	84	35.0	\$225.00
ZLBP-4284	42	—	84	42.0	239.00
ZLBP-4884	48	—	84	48.0	260.00
CLIPS FOR PANELS					
Z-CLIP*	—	—	—	0.1	\$2.40

*Zinc plated.

National Motor Freight Class: 70

SHELF DIVIDER

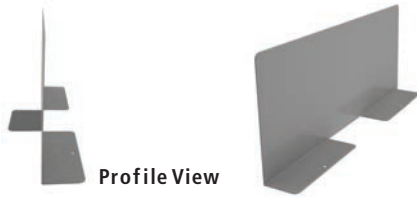

Profile View

CAT. NO.	W	D	H	WT.	PRICE
DIV2410	—	24	10	4.4	\$31.00

Use on particleboard, front-to-back, to subdivide shelf into several storage areas.

National Motor Freight Class: 70

CASTER KITS

Load capacity for caster kit is 1,000 lbs. Casters should not be used with units over 96" tall, or on units less than 18" deep. Maximum unit size is 60" wide by 30" deep.



CAT. NO.	CASTERS	W	D	H	WT.	PRICE
ZLCK-1	2 Fixed, 2 Swivel	1 1/2	1 1/2	7/16	12.8	\$231.00
ZLCK-2	4 Swivel	3 7/16	2	7/16	13.0	235.00

National Motor Freight Class: 70

HANG RODS

Used for hanging items left-to-right on a Z-Line unit. Attaches between two LRA shelf supports.



CAT. NO.	LOAD CAP.	W	D	H	WT.	PRICE
FOR LRA OR LRC SUPPORTS						
Channel-Shaped Hang Rods						
PHR-36♣	150	36 1/4	1 5/16	1 1/16	2.9	\$14.60
PHR-48♣	150	48 1/4	1 5/16	1 1/16	3.8	18.50

National Motor Freight Class: 70

PROTECTIVE CAPS

Place top edge caps over top of uprights to protect from sharp edges. Place foot caps beneath uprights as a floor protector.



Hard Nylon Foot Caps

Soft Top Edge Caps

CAT. NO.	Use With	W	D	H	WT.	PRICE
SOFT TOP EDGE CAPS						
EURPC •	EUR Uprights	1 1/2	1 1/2	7/16	0.1	\$1.50
ZTPPC •	ZTP Uprights	3 7/16	2	7/16	0.1	2.40
SURPC •	SUR Uprights	2 3/4	2 3/4	7/16	0.1	1.10
HARD NYLON FOOT CAPS						
EURNF •	EUR Uprights	1 1/2	1 1/2	3/4	0.1	\$1.40
ZTPNF •	ZTP Uprights	3 7/16	2	3/4	0.2	2.70
SURNF •	SUR Uprights	2 1/4	2 1/4	3/4	0.2	2.00

Available in Black only.

National Motor Freight Class: 70

Standard Colors (Unless Otherwise Specified)



♣ •
Items with these symbols are available to ship in 2-3 days. Limited quantities and select colors.

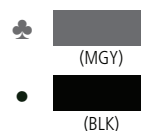

Z-Line Components: Accessories

CROSS AISLE TIES

CAT. NO.	W	D	H	WT.	PRICE
CAT-18♣	1 3/8	18	2 3/8	1.4	\$16.10
CAT-24	1 3/8	24	2 3/8	1.9	19.70
CAT-30	1 3/8	30	2 3/8	2.4	23.00
CAT-36♣	1 3/8	36	2 3/8	2.8	23.00
CAT-42	1 3/8	42	2 3/8	3.3	27.00
CAT-48	1 3/8	48	2 3/8	3.8	34.00

Used to link across an aisle for extra stability.
National Motor Freight Class: 70

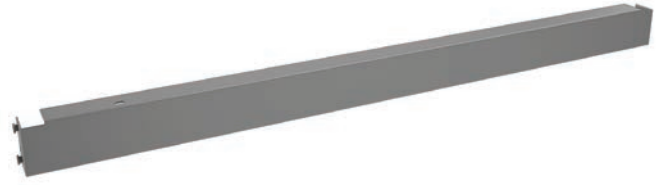

ADJUSTABLE AISLE TIE

CAT. NO.	W	D	H	WT.	PRICE
KCAT-1	3	*	1	6.0	\$53.00

*Depth adjusts from 36" to 60"

Links units across an aisle at adjustable distances.
National Motor Freight Class: 70



POST SPLICE ANGLE

CAT. NO.	W	D	H	WT.	PRICE
PSA-2	1 9/16	1 9/16	6 1/2	1.1	\$14.60

National Motor Freight Class: 70



Includes hardware. Used for splicing EUR, SUR and ZTP upright posts. When splicing ZTP uprights, two post splice angles are required per post.

WALL TIE

CAT. NO.	W	D	H	WT.	PRICE
WT-9♣	9 1/4	1 3/8	2 3/8	.7	\$6.80

National Motor Freight Class: 70



Used to secure a unit to a wall, with a 9" gap between the unit and the wall.

TIE PLATE

CAT. NO.	W	D	H	WT.	PRICE
TP-1▲	3	—	2 3/4	.2	\$2.70

National Motor Freight Class: 70

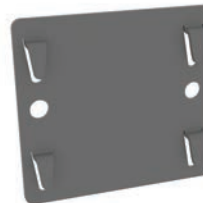

Used to secure two angle posts together front-to-back or side-by-side.

ANCHOR PLATE

CAT. NO.	W	D	H	WT.	PRICE
ZFA-1▲	1 3/8	1 1/2	2 3/8	.2	\$4.70

National Motor Freight Class: 70



Attaches to uprights to allow anchoring uprights to the floor.

FOOT PLATES

CAT. NO.	W	D	H	WT.	PRICE
ZFP-L♣	1 3/8	1 1/2	2 3/8	.2	\$3.20
ZFP-R♣	1 3/8	1 1/2	2 3/8	.2	\$3.20
DZFP♣	2 3/4	1 1/2	2 3/8	.5	\$6.60

National Motor Freight Class: 70



ZFP-L



DZFP

Attaches to uprights to allow anchoring uprights to the floor.

Standard Colors



♣ ▲
Items with these symbols are available to ship in 2-3 days. Limited quantities and select colors.

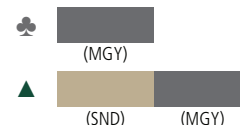

Bulk Storage Racks

BULK STORAGE RACKS - 24" DEEP

*Load capacities are based on evenly distributed loads.



STARTER



ADDER

**Wire Decking available in Medium Grey only.

National Motor Freight Class: 70

Units are intended to be hand loaded only.

UNIT SIZE			SHELF LOAD CAPACITY*	REINFORCEMENTS PER LEVEL	STARTER UNITS			ADDER UNITS			EXTRA SHELF LEVEL		
W	D	H			CAT NO.	WT.	PRICE	CAT NO.	WT.	PRICE	CAT NO.	WT.	PRICE
Particleboard Decking													
48	24	72	4,150	2	BU-482472PS♣	154	\$660.00	BU-482472PA♣	134	\$537.00	BU-4824P♣	38.0	\$138.00
72	24	72	2,750	3	BU-722472PS♣	205	837.00	BU-722472PA♣	185	714.00	BU-7224P♣	55.0	197.00
96	24	72	2,150	4	BU-962472PS♣	262	993.00	BU-962472PA♣	242	870.00	BU-9624P♣	74.0	249.00
48	24	84	4,150	2	BU-482484PS♣	162	750.00	BU-482484PA♣	138	582.00	BU-4824P♣	38.0	138.00
72	24	84	2,750	3	BU-722484PS♣	213	927.00	BU-722484PA♣	189	759.00	BU-7224P♣	55.0	197.00
96	24	84	2,150	4	BU-962484PS♣	270	1,083.00	BU-962484PA♣	246	915.00	BU-9624P♣	74.0	249.00
48	24	96	4,150	2	BU-482496PS♣	170	742.00	BU-482496PA♣	142	578.00	BU-4824P♣	38.0	138.00
72	24	96	2,750	3	BU-722496PS♣	221	919.00	BU-722496PA♣	193	755.00	BU-7224P♣	55.0	197.00
96	24	96	2,150	4	BU-962496PS♣	278	1,075.00	BU-962496PA♣	250	911.00	BU-9624P♣	74.0	249.00
48	24	120	4,150	2	BU-4824120PS♣	180	814.00	BU-4824120PA♣	147	614.00	BU-4824P♣	38.0	138.00
72	24	120	2,750	3	BU-7224120PS♣	231	991.00	BU-7224120PA♣	198	791.00	BU-7224P♣	55.0	197.00
96	24	120	2,150	4	BU-9624120PS♣	288	1,147.00	BU-9624120PA♣	255	947.00	BU-9624P♣	74.0	249.00
Corrugated Decking													
48	24	72	4,150	2	BU-482472CS♣	136	\$795.00	BU-482472CA♣	116	\$672.00	BU-4824C♣	32.0	\$183.00
72	24	72	2,750	3	BU-722472CS♣	178	1,011.00	BU-722472CA♣	158	888.00	BU-7224C♣	46.0	255.00
96	24	72	2,150	4	BU-962472CS♣	226	1,224.00	BU-962472CA♣	206	1,101.00	BU-9624C♣	62.0	326.00
48	24	84	4,150	2	BU-482484CS♣	144	885.00	BU-482484CA♣	120	717.00	BU-4824C♣	32.0	183.00
72	24	84	2,750	3	BU-722484CS♣	186	1,101.00	BU-722484CA♣	162	933.00	BU-7224C♣	46.0	255.00
96	24	84	2,150	4	BU-962484CS♣	234	1,314.00	BU-962484CA♣	210	1,146.00	BU-9624C♣	62.0	326.00
48	24	96	4,150	2	BU-482496CS♣	152	877.00	BU-482496CA♣	124	713.00	BU-4824C♣	32.0	183.00
72	24	96	2,750	3	BU-722496CS♣	194	1,093.00	BU-722496CA♣	166	929.00	BU-7224C♣	46.0	255.00
96	24	96	2,150	4	BU-962496CS♣	242	1,306.00	BU-962496CA♣	214	1,142.00	BU-9624C♣	62.0	326.00
48	24	120	4,150	2	BU-4824120CS♣	162	949.00	BU-4824120CA♣	129	749.00	BU-4824C♣	32.0	183.00
72	24	120	2,750	3	BU-7224120CS♣	204	1,165.00	BU-7224120CA♣	171	965.00	BU-7224C♣	46.0	255.00
96	24	120	2,150	4	BU-9624120CS♣	252	1,378.00	BU-9624120CA♣	219	1,178.00	BU-9624C♣	62.0	326.00
Wire Decking**													
48	24	72	4,150	2	BU-482472WS♣	126	\$795.00	BU-482472WA♣	106	\$672.00	BU-4824W♣	29.0	\$183.00
72	24	72	2,750	3	BU-722472WS♣	163	1,035.00	BU-722472WA♣	143	912.00	BU-7224W♣	41.0	263.00
96	24	72	2,150	4	BU-962472WS♣	206	1,260.00	BU-962472WA♣	186	1,137.00	BU-9624W♣	55.0	338.00
48	24	84	4,150	2	BU-482484WS♣	134	885.00	BU-482484WA♣	110	717.00	BU-4824W♣	29.0	183.00
72	24	84	2,750	3	BU-722484WS♣	171	1,125.00	BU-722484WA♣	147	959.00	BU-7224W♣	41.0	263.00
96	24	84	2,150	4	BU-962484WS♣	213	1,350.00	BU-962484WA♣	189	1,182.00	BU-9624W♣	55.0	338.00
48	24	96	4,150	2	BU-482496WS♣	142	877.00	BU-482496WA♣	114	713.00	BU-4824W♣	29.0	183.00
72	24	96	2,750	3	BU-722496WS♣	179	1,117.00	BU-722496WA♣	151	953.00	BU-7224W♣	41.0	263.00
96	24	96	2,150	4	BU-962496WS♣	222	1,342.00	BU-962496WA♣	194	1,178.00	BU-9624W♣	55.0	338.00
48	24	120	4,150	2	BU-4824120WS♣	152	949.00	BU-4824120WA♣	119	749.00	BU-4824W♣	29.0	183.00
72	24	120	2,750	3	BU-7224120WS♣	189	1,189.00	BU-7224120WA♣	156	989.00	BU-7224W♣	41.0	263.00
96	24	120	2,150	4	BU-9624120WS♣	232	1,414.00	BU-9624120WA♣	199	1,178.00	BU-9624W♣	55.0	338.00

- Assembly required.

Standard Colors (Unless Otherwise Specified)



♣ Items with this symbol are available to ship in 2-3 days. Limited quantities and select colors. (MGY)

Bulk Storage Racks

BULK STORAGE RACKS - 36" DEEP

*Load capacities are based on evenly distributed loads.

**Wire Decking available in Medium Grey only.

National Motor Freight Class: 70

Units are intended to be hand loaded only.

To reach 4,150 lbs. shelf level capacity on 48" wide units, two additional BPS are required. Must be purchased separately.



STARTER



ADDER

UNIT SIZE W D H	SHELF LOAD CAPACITY*	REINFORCEMENTS PER LEVEL	STARTER UNITS			ADDER UNITS			EXTRA SHELF LEVEL		
			CAT NO.	WT.	PRICE	CAT NO.	WT.	PRICE	CAT NO.	WT.	PRICE
Particleboard Decking											
48 36 72	3,000	2	BU-483672PS♣	193	\$758.00	BU-483672PA♣	171	\$625.00	BU-4836P♣	50.0	\$164.00
72 36 72	2,750	3	BU-723672PS♣	260	953.00	BU-723672PA♣	238	820.00	BU-7236P♣	72.0	229.00
96 36 72	2,150	4	BU-963672PS♣	335	1,160.00	BU-963672PA♣	313	1,027.00	BU-9636P♣	97.0	298.00
48 36 84	3,000	2	BU-483684PS♣	198	850.00	BU-483684PA♣	173	701.00	BU-4836P♣	50.0	164.00
72 36 84	2,750	3	BU-723684PS♣	266	1,045.00	BU-723684PA♣	241	866.00	BU-7236P♣	72.0	229.00
96 36 84	2,150	4	BU-963684PS♣	341	1,252.00	BU-963684PA♣	316	1,073.00	BU-9636P♣	97.0	298.00
48 36 96	3,000	2	BU-483696PS♣	209	858.00	BU-483696PA♣	179	675.00	BU-4836P♣	50.0	164.00
72 36 96	2,750	3	BU-723696PS♣	276	1,053.00	BU-723696PA♣	246	870.00	BU-7236P♣	72.0	229.00
96 36 96	2,150	4	BU-963696PS♣	351	1,260.00	BU-963696PA♣	321	1,077.00	BU-9636P♣	97.0	298.00
48 36 120	3,000	2	BU-4836120PS♣	221	924.00	BU-4836120PA♣	185	708.00	BU-4836P♣	50.0	164.00
72 36 120	2,750	3	BU-7236120PS♣	288	1,119.00	BU-7236120PA♣	252	903.00	BU-7236P♣	72.0	229.00
96 36 120	2,150	4	BU-9636120PS♣	363	1,326.00	BU-9636120PA♣	327	1,110.00	BU-9636P♣	97.0	298.00
Corrugated Decking											
48 36 72	3,000	2	BU-483672CS♣	163	\$956.00	BU-483672CA♣	141	\$823.00	BU-4836C♣	40.0	\$230.00
72 36 72	2,750	3	BU-723672CS♣	218	1,217.00	BU-723672CA♣	196	1,084.00	BU-7236C♣	58.0	317.00
96 36 72	2,150	4	BU-963672CS♣	275	1,493.00	BU-963672CA♣	253	1,360.00	BU-9636C♣	77.0	409.00
48 36 84	3,000	2	BU-483684CS♣	168	1,106.00	BU-483684CA♣	143	869.00	BU-4836C♣	40.0	230.00
72 36 84	2,750	3	BU-723684CS♣	224	1,309.00	BU-723684CA♣	199	1,130.00	BU-7236C♣	58.0	317.00
96 36 84	2,150	4	BU-963684CS♣	281	1,585.00	BU-963684CA♣	256	1,406.00	BU-9636C♣	77.0	409.00
48 36 96	3,000	2	BU-483696CS♣	179	1,056.00	BU-483696CA♣	149	873.00	BU-4836C♣	40.0	230.00
72 36 96	2,750	3	BU-723696CS♣	234	1,317.00	BU-723696CA♣	204	1,134.00	BU-7236C♣	58.0	317.00
96 36 96	2,150	4	BU-963696CS♣	291	1,593.00	BU-963696CA♣	261	1,410.00	BU-9636C♣	77.0	409.00
48 36 120	3,000	2	BU-4836120CS♣	191	1,122.00	BU-4836120CA♣	155	906.00	BU-4836C♣	40.0	230.00
72 36 120	2,750	3	BU-7236120CS♣	246	1,383.00	BU-7236120CA♣	210	1,167.00	BU-7236C♣	58.0	317.00
96 36 120	2,150	4	BU-9636120CS♣	303	1,659.00	BU-9636120CA♣	267	1,443.00	BU-9636C♣	77.0	409.00
Wire Decking**											
48 36 72	3,000	2	BU-483672WS♣	148	\$929.00	BU-483672WA♣	126	\$796.00	BU-4836W♣	35.0	\$221.00
72 36 72	2,750	3	BU-723672WS♣	197	1,166.00	BU-723672WA♣	175	1,033.00	BU-7236W♣	51.0	300.00
96 36 72	2,150	4	BU-963672WS♣	251	1,499.00	BU-963672WA♣	229	1,366.00	BU-9636W♣	69.0	411.00
48 36 84	3,000	2	BU-483684WS♣	153	1,021.00	BU-483684WA♣	128	842.00	BU-4836W♣	35.0	221.00
72 36 84	2,750	3	BU-723684WS♣	203	1,258.00	BU-723684WA♣	178	1,079.00	BU-7236W♣	51.0	300.00
96 36 84	2,150	4	BU-963684WS♣	257	1,591.00	BU-963684WA♣	232		BU-9636W♣	69.0	411.00
48 36 96	3,000	2	BU-483696WS♣	164	1,029.00	BU-483696WA♣	134	846.00	BU-4836W♣	35.0	221.00
72 36 96	2,750	3	BU-723696WS♣	213	1,266.00	BU-723696WA♣	183	1,083.00	BU-7236W♣	51.0	300.00
96 36 96	2,150	4	BU-963696WS♣	267	1,599.00	BU-963696WA♣	237	1,416.00	BU-9636W♣	69.0	411.00
48 36 120	3,000	2	BU-4836120WS♣	176	1,095.00	BU-4836120WA♣	140	879.00	BU-4836W♣	35.0	221.00
72 36 120	2,750	3	BU-7236120WS♣	225	1,332.00	BU-7236120WA♣	189	1,116.00	BU-7236W♣	51.0	300.00
96 36 120	2,150	4	BU-9636120WS♣	279	1,665.00	BU-9636120WA♣	243	1,449.00	BU-9636W♣	69.0	411.00

- Assembly required.

Standard Colors (Unless Otherwise Specified)



♣ Items with this symbol are available to ship in 2-3 days. Limited quantities and select colors. (MGY)

Bulk Storage Racks

BULK STORAGE RACKS - 48" DEEP

*Load capacities are based on evenly distributed loads.



STARTER



ADDER

**Wire Decking available in Medium Grey only.

National Motor Freight Class: 70

Units are intended to be hand loaded only.

To reach 4,150 lbs. shelf level capacity on 48" wide units, two additional BPS are required. Must be purchased separately.

UNIT SIZE		SHELF LOAD CAPACITY*	REINFORCEMENTS PER LEVEL	STARTER UNITS			ADDER UNITS			EXTRA SHELF LEVEL		
W	D H			CAT NO.	WT.	PRICE	CAT NO.	WT.	PRICE	CAT NO.	WT.	PRICE
Particleboard Decking												
48	48	72	1,500	2	BU-484872PS♣	229	\$873.00	BU-484872PA♣	206	\$726.00	BU-4848P♣	61.0 \$193.00
72	48	72	2,750	3	BU-724872PS♣	319	1,110.00	BU-724872PA♣	296	963.00	BU-7248P♣	91.0 272.00
96	48	72	2,150	4	BU-964872PS♣	397	1,359.00	BU-964872PA♣	374		BU-9648P♣	117.0 355.00
48	48	84	1,500	2	BU-484884PS♣	237		BU-484884PA♣	210	788.00	BU-4848P♣	61.0 193.00
72	48	84	2,750	3	BU-724884PS♣	327	1,234.00	BU-724884PA♣	300		BU-7248P♣	91.0 272.00
96	48	84	2,150	4	BU-964884PS♣	405	1,483.00	BU-964884PA♣	378	1,274.00	BU-9648P♣	117.0 355.00
48	48	96	1,500	2	BU-484896PS♣	249	979.00	BU-484896PA♣	216		BU-4848P♣	61.0 193.00
72	48	96	2,750	3	BU-724896PS♣	339	1,216.00	BU-724896PA♣	306		BU-7248P♣	91.0 272.00
96	48	96	2,150	4	BU-964896PS♣	417	1,465.00	BU-964896PA♣	384	1,265.00	BU-9648P♣	117.0 355.00
48	48	120	1,500	2	BU-4848120PS♣	259		BU-4848120PA♣	221	813.00	BU-4848P♣	61.0 193.00
72	48	120	2,750	3	BU-7248120PS♣	349		BU-7248120PA♣	311	1,050.00	BU-7248P♣	91.0 272.00
96	48	120	2,150	4	BU-9648120PS♣	427	1,533.00	BU-9648120PA♣	389	1,299.00	BU-9648P♣	117.0 355.00
Corrugated Decking												
48	48	72	1,500	2	BU-484872CS♣	193	\$1,092.00	BU-484872CA♣	170		BU-4848C♣	49.0 \$266.00
72	48	72	2,750	3	BU-724872CS♣	265	1,422.00	BU-724872CA♣	242	1,275.00	BU-7248C♣	73.0 376.00
96	48	72	2,150	4	BU-964872CS♣	331	1,764.00	BU-964872CA♣	308	1,617.00	BU-9648C♣	95.0 490.00
48	48	84	1,500	2	BU-484884CS♣	201	1,216.00	BU-484884CA♣	174	1,007.00	BU-4848C♣	49.0 266.00
72	48	84	2,750	3	BU-724884CS♣	246	1,546.00	BU-724884CA♣	273	1,337.00	BU-7248C♣	73.0 376.00
96	48	84	2,150	4	BU-964884CS♣	339	1,888.00	BU-964884CA♣	312		BU-9648C♣	95.0 490.00
48	48	96	1,500	2	BU-484896CS♣	213		BU-484896CA♣	180		BU-4848C♣	49.0 266.00
72	48	96	2,750	3	BU-724896CS♣	285	1,528.00	BU-724896CA♣	252	1,328.00	BU-7248C♣	73.0 376.00
96	48	96	2,150	4	BU-964896CS♣	351	1,870.00	BU-964896CA♣	318	1,670.00	BU-9648C♣	95.0 490.00
48	48	120	1,500	2	BU-4848120CS♣	223		BU-4848120CA♣	185		BU-4848C♣	49.0 266.00
72	48	120	2,750	3	BU-7248120CS♣	295	1,596.00	BU-7248120CA♣	257		BU-7248C♣	73.0 376.00
96	48	120	2,150	4	BU-9648120CS♣	361	1,938.00	BU-9648120CA♣	323	1,704.00	BU-9648C♣	95.0 490.00
Wire Decking**												
48	48	72	1,500	2	BU-484872WS♣	172	\$1,077.00	BU-484872WA♣	149	\$930.00	BU-4848W♣	42.0 \$261.00
72	48	72	2,750	3	BU-724872WS♣	235	1,323.00	BU-724872WA♣	212	1,176.00	BU-7248W♣	63.0 343.00
96	48	72	2,150	4	BU-964872WS♣	283	1,779.00	BU-964872WA♣	260	1,632.00	BU-9648W♣	79.0 495.00
48	48	84	1,500	2	BU-484884WS♣	180		BU-484884WA♣	153		BU-4848W♣	42.0 261.00
72	48	84	2,750	3	BU-724884WS♣	243	1,447.00	BU-724884WA♣	216	1,238.00	BU-7248W♣	63.0 343.00
96	48	84	2,150	4	BU-964884WS♣	291	1,903.00	BU-964884WA♣	264	1,694.00	BU-9648W♣	79.0 495.00
48	48	96	1,500	2	BU-484896WS♣	192	1,183.00	BU-484896WA♣	159		BU-4848W♣	42.0 261.00
72	48	96	2,750	3	BU-724896WS♣	255	1,429.00	BU-724896WA♣	222	1,229.00	BU-7248W♣	63.0 343.00
96	48	96	2,150	4	BU-964896WS♣	303	1,885.00	BU-964896WA♣	270	1,685.00	BU-9648W♣	79.0 495.00
48	48	120	1,500	2	BU-4848120WS♣	202	1,251.00	BU-4848120WA♣	164		BU-4848W♣	42.0 261.00
72	48	120	2,750	3	BU-7248120WS♣	265	1,497.00	BU-7248120WA♣	227		BU-7248W♣	63.0 343.00
96	48	120	2,150	4	BU-9648120WS♣	313	1,953.00	BU-9648120WA♣	275	1,719.00	BU-9648W♣	79.0 495.00

- Assembly required.

Standard Colors (Unless Otherwise Specified)



♣ Items with this symbol are available to ship in 2-3 days. Limited quantities and select colors. ♣ (MGY)

Bulk Storage: Components

BULK UPRIGHTS

CAT. NO.	W	D	H	WT.	PRICE
72" High					
BUF-2472♣	1 3/4	24	72	20	\$123.00
BUF-3672♣	1 3/4	36	72	22	133.00
BUF-4272*	1 3/4	42	72	22	192.00
BUF-4872♣	1 3/4	48	72	23	147.00
84" High					
BUF-2484♣	1 3/4	24	84	24	\$168.00
BUF-3684♣	1 3/4	36	84	25	179.00
BUF-4884♣	1 3/4	48	84	27	209.00
96" High					
BUF-2496♣	1 3/4	24	96	28	\$164.00
BUF-3696♣	1 3/4	36	96	30	183.00
BUF-4296*	1 3/4	42	96	32	225.00
BUF-4896♣	1 3/4	48	96	33	200.00
120" High					
BUF-24120♣	1 3/4	24	120	33	\$200.00
BUF-36120♣	1 3/4	36	120	36	216.00
BUF-42120*	1 3/4	42	120	37	305.00
BUF-48120♣	1 3/4	48	120	38	234.00
144" High					
BUF-24144*	1 3/4	24	144	40	\$305.00
BUF-36144*	1 3/4	36	144	43	319.00
BUF-48144*	1 3/4	48	144	46	319.00
168" High					
BUF-24168*	1 3/4	24	168	46	\$379.00
BUF-36168*	1 3/4	36	168	50	371.00
BUF-48168*	1 3/4	48	168	53	402.00
192" High					
BUF-24192*	1 3/4	24	192	53	\$385.00
BUF-36192*	1 3/4	36	192	57	395.00
BUF-48192*	1 3/4	48	192	64	414.00

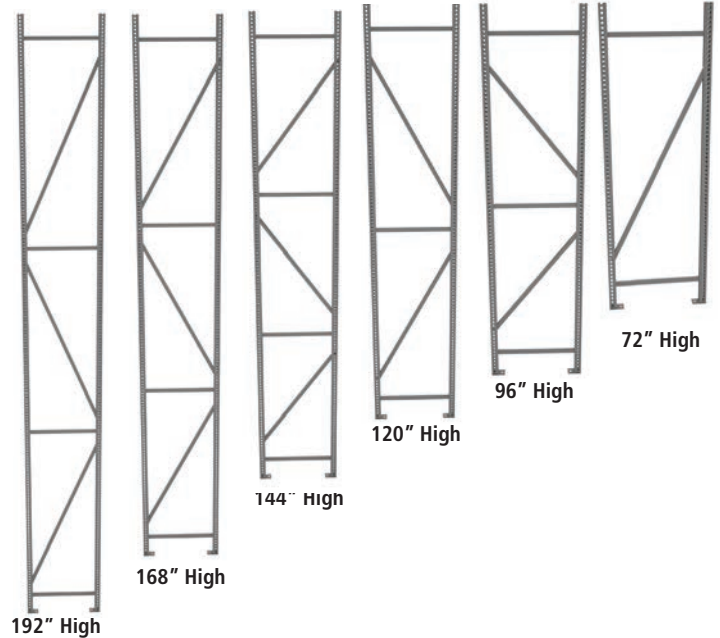

For uprights without feet, add "NFP" to the catalog number, i.e. BUF-2472NFP.
17,000 lbs. capacity based on maximum vertical distance of 24" between any two beams on floor.

National Motor Freight Class: 70

*Note: Quantities less than 50 uprights, please add \$250 Net set-up charge. Other sizes available, contact factory for pricing.

RACK SPACER

CAT. NO.	W	D	H	WT.	PRICE
BRS-6	8 29/32	1	5 13/16	1.0	\$13.90

Mounting hardware is included with part.

National Motor Freight Class: 70

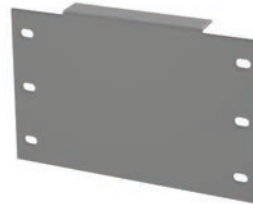

Used to attach back-to-back units. Maintains a 6" gap to meet fire codes.

BULK UPRIGHT EXTENSION

CAT. NO.	W	D	H	WT.	PRICE
SPBUF-10	8 29/32	1 1/2	5 13/16	3.3	\$22.00

National Motor Freight Class: 70



Used to splice two bulk frames together for additional height.

Top upright must be ordered without welded feet.

SAFETY PLUGS

CAT. NO.	W	D	H	WT.	PRICE
BSP-4*	—	—	—	0.4	\$2.70

*Plastic plugs come in a pack of 4.

National Motor Freight Class: 70

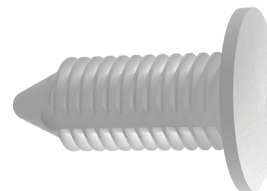

Standard Colors (Unless Otherwise Specified)



♣ Items with these symbols are available to ship in 2-3 days. Limited quantities and select colors.



DECKING TYPES



Units are intended to be hand loaded only.

*Wire decking uses 5 gauge wire and consists of a 2" x 4" mesh pattern. Price shown for wire decking is for Medium Grey. For price of Sand or Light Grey, add a 10% upcharge.

**All corrugated decking comes in 12" wide sections

National Motor Freight Class: 70

CAT. NO.	W	D	H	WT.	PRICE
Wire Decking*					
ZWD-4824♣	48	24	5/16	10.7	\$85.00
ZWD-4836♣	48	36	5/16	16.0	116.00
ZWD-4848♣	48	48	5/16	21.0	149.00
ZWD-6024	60	24	5/16	13.3	139.00
ZWD-6036♣	60	36	5/16	20.0	153.00
ZWD-6048	60	48	5/16	27.0	211.00
ZWD-7224♣	72	24	5/16	16.0	131.00
ZWD-7236♣	72	36	5/16	24.0	161.00
ZWD-7248♣	72	48	5/16	32.0	190.00
ZWD-9624♣♣	96	24	5/16	21.0	170.00
ZWD-9636♣♣	96	36	5/16	32.0	232.00
ZWD-9648♣♣	96	48	5/16	42.0	298.00
Corrugated Steel Decking**					
BSD-4824♣	48	24	9/16	14.0	\$85.00
BSD-4836♣	48	36	9/16	21.0	125.00
BSD-4848♣	48	48	9/16	28.0	154.00
BSD-6024♣	60	24	9/16	17.9	105.00
BSD-6036♣	60	36	9/16	26.0	151.00
BSD-6048♣	60	48	9/16	36.0	189.00
BSD-7224♣	72	24	9/16	21.0	123.00
BSD-7236♣	72	36	9/16	31.0	178.00
BSD-7248♣	72	48	9/16	42.0	223.00
BSD-9624♣	96	24	9/16	28.0	158.00
BSD-9636♣	96	36	9/16	40.0	230.00
BSD-9648♣	96	48	9/16	58.0	293.00
Particleboard Decking					
PB-4824▣	48	24	5/8	20.0	\$40.00
PB-4836▣	48	36	5/8	31.0	59.00
PB-4848▣	48	48	5/8	40.0	81.00
PB-6024▣	60	24	5/8	25.0	50.00
PB-6036▣	60	36	5/8	37.5	79.00
PB-6048▣	60	48	5/8	50.0	95.00
PB-7224▣	72	24	5/8	30.0	65.00
PB-7236▣	72	36	5/8	45.0	90.00
PB-7248▣	72	48	5/8	60.0	119.00
PB-9624▣	96	24	5/8	40.0	81.00
PB-9636▣	96	36	5/8	60.0	119.00
PB-9648▣	96	48	5/8	80.0	158.00

†Comes in two 48" wide sections.

DECK LEVELS

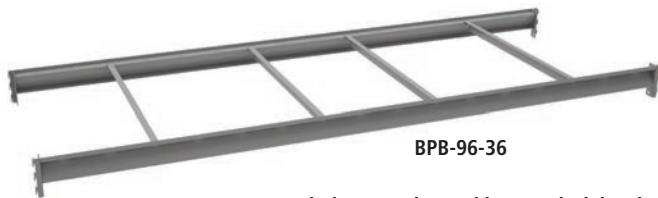

Includes two plywood beams, deck level reinforcements and safety plugs.

Additional Deck Level Reinforcements (BPS-dd) can be added for extra deck support and weight capacity.

National Motor Freight Class: 70

CAT. NO.	Reinforcements Included	Load Cap.	WT.	PRICE
BPB-48-24♣	2	4,150	18.1	\$98.00
BPB-48-36♣	2	3,000	18.5	105.00
BPB-48-48♣	2	1,500	21.0	112.00
BPB-60-24♣	2	3,800	21.0	111.00
BPB-60-36♣	2	3,800	23.0	116.00
BPB-60-48♣	2	3,800	23.0	125.00
BPB-72-24♣	3	2,750	25.0	132.00
BPB-72-36♣	3	2,750	27.0	139.00
BPB-72-48♣	3	2,750	31.0	153.00
BPB-96-24♣	4	2,150	34.0	168.00
BPB-96-36♣	4	2,150	37.0	179.00
BPB-96-48♣	4	2,150	37.0	197.00

DECK LEVEL REINFORCEMENTS



National Motor Freight Class: 70

CAT. NO.	W	D	H	WT.	PRICE
BPS-24♣	1	24	1 15/16	1.3	\$8.10
BPS-36♣	1	36	1 15/16	2.1	10.90
BPS-48♣	1	48	1 15/16	2.7	15.00

Standard Colors (Unless Otherwise Specified)



Items with these symbols are available to ship in 2-3 days. Limited quantities and select colors.



Q-Line Industrial Clip Shelving

*Load capacities are based on evenly distributed loads.

OPEN STYLE SHELVING



Starter Units Include:

- 4 Offset Angle Posts
- 2 Sets of Side Sway Braces
- 1 Set of Back Sway Braces
- 5 Steel Shelves

National Motor
Freight Class: 70

- Assembly required.

QOH5-36185



"AB" Adder Units Include:

- 2 Offset Angle Posts
- 1 Beaded Post
- 1 Set of Side Sway Braces
- 1 Set of Back Sway Braces
- 5 Steel Shelves

National Motor
Freight Class: 70

- Assembly required.

QOH5-3618AB



"A" Adder Units Include:

- 4 Offset Angle Posts
- 1 Set of Side Sway Braces
- 1 Set of Back Sway Braces
- 5 Steel Shelves

National Motor
Freight Class: 70

- Assembly required.

QOH5-3618A

UNIT SIZE			SHELF CAP.*	STARTER UNITS			ADDER UNITS			EXTRA SHELF					
W	D	H		CAT. NO.	WT.	PRICE	CAT. NO.	WT.	PRICE	CAT. NO.	WT.	PRICE			
20 Gauge, 5 Shelves															
36	12	87	1,000	QOH5-3612S	69	\$387.00	QOH5-3612AB	62	\$360.00	QOH5-3612A	66	\$376.00	Q-3612	8.0	\$49.00
48	12	87	650	QOH5-4812S	82	464.00	QOH5-4812AB	75	437.00	QOH5-4812A	79	453.00	Q-4812	10.4	64.00
36	18	87	850	QOH5-3618S	82	447.00	QOH5-3618AB	75	420.00	QOH5-3618A	79	436.00	Q-3618	10.5	61.00
48	18	87	550	QOH5-4818S	98	554.00	QOH5-4818AB	91	527.00	QOH5-4818A	95	543.00	Q-4818	13.6	82.00
36	24	87	800	QOH5-3624S	94	522.00	QOH5-3624AB	87	495.00	QOH5-3624A	91	500.00	Q-3624	13.0	76.00
48	24	87	550	QOH5-4824S	114	589.00	QOH5-4824AB	107	562.00	QOH5-4824A	111	578.00	Q-4824	16.8	89.00
22 Gauge, 5 Shelves															
36	12	87	750	QO5-3612S	63	\$347.00	QO5-3612AB	56	\$320.00	QO5-3612A	60	\$333.00	Q2-3612	6.7	\$41.00
48	12	87	500	QO5-4812S	73	389.00	QO5-4812AB	66	362.00	QO5-4812A	71	375.00	Q2-4812	8.7	49.00
36	18	87	750	QO5-3618S	73	397.00	QO5-3618AB	66	370.00	QO5-3618A	71	383.00	Q2-3618	8.8	51.00
48	18	87	500	QO5-4818S	87	464.00	QO5-4818AB	80	437.00	QO5-4818A	84	450.00	Q2-4818	11.4	64.00
36	24	87	700	QO5-3624S	84	447.00	QO5-3624AB	77	420.00	QO5-3624A	81	433.00	Q2-3624	10.9	61.00
48	24	87	450	QO5-4824S	100	519.00	QO5-4824AB	93	492.00	QO5-4824A	98	505.00	Q2-4824	14.1	75.00

*Load capacities are based on evenly distributed loads.

CLOSED STYLE SHELVING



Starter Units Include:

- 4 Offset Angle Posts
- 2 Side Panels
- 1 Back Panel
- 5 Steel Shelves

National Motor
Freight Class: 70

- Assembly required.

QCH5-36185



"AB" Adder Units Include:

- 2 Offset Angle Posts
- 1 Beaded Post
- 1 Side Panel
- 1 Back Panel
- 5 Steel Shelves

National Motor
Freight Class: 70

- Assembly required.

QCH5-3618AB



"A" Adder Units Include:

- 4 Offset Angle Posts
- 1 Side Panel
- 1 Back Panel
- 5 Steel Shelves

National Motor
Freight Class: 70

- Assembly required.

QCH5-3618A

UNIT SIZE			SHELF CAP.*	STARTER UNITS			ADDER UNITS			EXTRA SHELF					
W	D	H		CAT. NO.	WT.	PRICE	CAT. NO.	WT.	PRICE	CAT. NO.	WT.	PRICE			
20 Gauge, 5 Shelves															
36	12	87	1,000	QCH5-3612S	95	\$573.00	QCH5-3612AB	85	\$518.00	QCH5-3612A	90	\$534.00	Q-3612	8.0	\$49.00
48	12	87	650	QCH5-4812S	116	691.00	QCH5-4812AB	106	636.00	QCH5-4812A	111	652.00	Q-4812	10.4	64.00
36	18	87	850	QCH5-3618S	116	675.00	QCH5-3618AB	101	599.00	QCH5-3618A	111	610.00	Q-3618	10.5	61.00
48	18	87	550	QCH5-4818S	140	823.00	QCH5-4818AB	126	747.00	QCH5-4818A	132	769.00	Q-4818	13.6	82.00
36	24	87	800	QCH5-3624S	135	788.00	QCH5-3624AB	117	693.00	QCH5-3624A	123	710.00	Q-3624	13.0	76.00
48	24	87	550	QCH5-4824S	163	896.00	QCH5-4824AB	145	801.00	QCH5-4824A	152	823.00	Q-4824	16.8	89.00
22 Gauge, 5 Shelves															
36	12	87	750	QC5-3612S	89	\$533.00	QC5-3612AB	78	\$478.00	QC5-3612A	83	\$491.00	Q2-3612	6.7	\$41.00
48	12	87	500	QC5-4812S	108	616.00	QC5-4812AB	97	561.00	QC5-4812A	102	574.00	Q2-4812	8.7	49.00
36	18	87	750	QC5-3618S	107	625.00	QC5-3618AB	93	549.00	QC5-3618A	97	562.00	Q2-3618	8.8	51.00
48	18	87	500	QC5-4818S	129	733.00	QC5-4818AB	115	657.00	QC5-4818A	119	670.00	Q2-4818	11.4	64.00
36	24	87	700	QC5-3624S	125	713.00	QC5-3624AB	107	618.00	QC5-3624A	111	631.00	Q2-3624	10.9	61.00
48	24	87	450	QC5-4824S	150	826.00	QC5-4824AB	132	731.00	QC5-4824A	136	744.00	Q2-4824	14.1	75.00

Standard Colors



Items with this symbol are available to ship in 2-3 days. Limited quantities and select colors. (MGY)

Q-Line Shelving: Components

UPRIGHT POSTS



OFFSET
ANGLE POST



INTERMEDIATE
BEADED POST



HEAVY-DUTY
INTERMEDIATE
BEADED POST

Post slotted for shelf adjustment on 1" centers. Total weight capacity not to exceed 5,000 lbs. per unit for OAP and HBP posts. Weight capacity not to exceed 3,500 lbs per unit for BTP posts. Capacities based upon 24" shelf centers or less.

National Motor Freight Class: 70

CAT. NO.	W	D	H	WT.	PRICE
Offset Angle Post					
OAP-39	1	1 7/8	39	2.4	\$11.00
OAP-48	1	1 7/8	48	2.9	13.30
OAP-51	1	1 7/8	51	3.1	14.40
OAP-75♣	1	1 7/8	75	4.6	20.00
OAP-84♣	1	1 7/8	84	5.1	23.00
OAP-87♣	1	1 7/8	87	5.3	24.00
OAP-96	1	1 7/8	96	5.9	27.00
OAP-99	1	1 7/8	99	6.0	29.00
OAP-108	1	1 7/8	108	6.8	31.00
OAP-111	1	1 7/8	111	6.8	31.00
OAP-123	1	1 7/8	123	7.5	35.00
Beaded T-Post					
BTP-39*	3/8	1 7/8	39	2.7	\$24.00
BTP-48*	3/8	1 7/8	48	3.4	29.00
BTP-51*	3/8	1 7/8	51	3.6	30.00
BTP-75♣	3/8	1 7/8	75	5.3	31.00
BTP-84♣	3/8	1 7/8	84	5.9	35.00
BTP-87♣	3/8	1 7/8	87	6.1	35.00
Heavy Duty Beaded T-Post					
HBP-39*	3/4	2 7/8	39	4.4	\$54.00
HBP-48*	3/4	2 7/8	48	5.4	57.00
HBP-51*	3/4	2 7/8	51	5.7	68.00
HBP-75*	3/4	2 7/8	75	8.4	80.00
HBP-84*	3/4	2 7/8	84	9.4	85.00
HBP-87♣	3/4	2 7/8	87	9.8	85.00
HBP-99*	3/4	2 7/8	99	11.1	90.00
HBP-111*	3/4	2 7/8	111	12.5	75.00
HBP-123*	3/4	2 7/8	123	13.9	87.00

*Add \$600 Net set-up charge.

WELDED UPRIGHTS



These are panels welded to OAP style posts. For quantities of less than 50 pieces, add \$100 Net set-up charge. Contact factory for pricing on intermediate welded uprights.

DEPTH	CAT. NO.	H	WT.	PRICE
12" DEEP	WU-1239	39	7.1	\$68.00
	WU-1251	51	9.3	80.00
	WU-1275	75	13.7	95.00
	WU-1284	84	15.3	102.00
	WU-1287	87	15.8	107.00
15" DEEP	WU-1539	39	8.0	68.00
	WU-1551	51	10.5	80.00
	WU-1575	75	15.5	102.00
	WU-1584	84	17.3	113.00
18" DEEP	WU-1587	87	17.9	114.00
	WU-1839	39	9.1	75.00
	WU-1851	51	11.9	92.00
24" DEEP	WU-1875	75	17.3	107.00
	WU-1884	84	19.6	128.00
	WU-1887	87	20.3	124.00
	WU-2439	39	10.3	83.00
30" DEEP	WU-2451	51	13.4	102.00
	WU-2475	75	19.7	131.00
	WU-2484	84	22.1	151.00
	WU-2487	87	22.9	150.00
36" DEEP	WU-3039	39	11.5	90.00
	WU-3051	51	15.1	110.00
	WU-3075	75	22.1	159.00
	WU-3084	84	24.8	173.00
36" DEEP	WU-3087	87	25.7	177.00
	WU-3639	39	13.0	101.00
	WU-3651	51	17.0	121.00
	WU-3675	75	25.0	175.00
36" DEEP	WU-3684	84	28.0	190.00
	WU-3687	87	29.0	197.00

National Motor Freight Class: 70

Standard Colors



Items with this symbol are available to ship in 2-3 days. Limited quantities and select colors.



Q-Line Shelving: Components

BACK PANELS







CAT. NO.	H	WT.	PRICE
36" Wide			
BP-3639	39	9.8	\$75.00
BP-3648	48	12.1	88.00
BP-3651	51	12.9	94.00
BP-3675♣	75	18.9	129.00
BP-3684♣	84	21.0	140.00
BP-3687♣	87	22.0	147.00
42" Wide*			
BP-4239	39	11.8	\$95.00
BP-4248	48	14.5	109.00
BP-4251	51	15.4	117.00
BP-4275	75	23.0	155.00
BP-4284	84	25.0	170.00
BP-4287	87	26.0	171.00
48" Wide*			
BP-4839	39	14.0	\$106.00
BP-4848	48	17.0	120.00
BP-4851	51	18.1	128.00
BP-4875	75	27.0	171.00
BP-4884	84	30.0	188.00
BP-4887♣	87	31.0	190.00

*NOTE: 42" & 48" backs consist of two pieces.

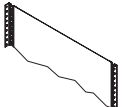

National Motor Freight Class: 70

END PANELS

DEPTH	CAT. NO.	H	WT.	PRICE
12" DEEP 	EP-1239	39	2.7	\$30.00
	EP-1248	48	3.3	32.00
	EP-1251	51	3.5	33.00
	EP-1275	75	5.1	42.00
	EP-1284	84	5.7	45.00
	EP-1287♣	87	6.0	42.00
15" DEEP 	EP-1539	39	3.7	34.00
	EP-1548	48	4.5	38.00
	EP-1551	51	4.8	39.00
	EP-1575	75	7.1	52.00
	EP-1584	84	7.9	56.00
	EP-1587	87	8.2	56.00
18" DEEP 	EP-1839	39	4.5	38.00
	EP-1848	48	5.5	41.00
	EP-1851	51	5.9	45.00
	EP-1875♣	75	8.6	60.00
	EP-1884♣	84	9.6	61.00
	EP-1887♣	87	10.0	63.00
24" DEEP 	EP-2439	39	6.8	46.00
	EP-2448	48	7.5	53.00
	EP-2451	51	8.0	54.00
	EP-2475	75	11.7	75.00
	EP-2484	84	13.1	80.00
	EP-2487♣	87	13.6	82.00
30" DEEP 	EP-3039	39	7.9	53.00
	EP-3048	48	9.7	65.00
	EP-3051	51	10.3	69.00
	EP-3075	75	15.2	94.00
	EP-3084	84	17.0	102.00
	EP-3087	87	17.6	105.00
36" DEEP 	EP-3639	39	9.8	67.00
	EP-3648	48	12.1	75.00
	EP-3651	51	12.9	83.00
	EP-3675	75	18.9	114.00
	EP-3684	84	21.0	124.00
	EP-3687	87	22.0	126.00

National Motor Freight Class: 70



Standard Colors



♣
Items with these symbols are available to ship in 2-3 days. Limited quantities and select colors.



Q-Line Shelving: Components

SHELVES

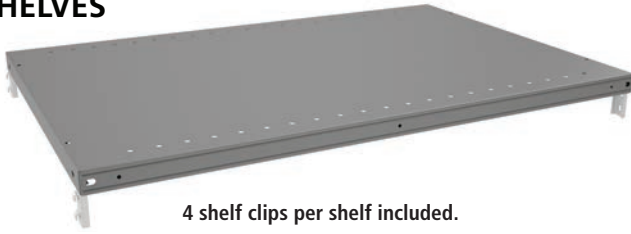

4 shelf clips per shelf included.



Shelves have a welded box formed construction with lapped and welded corners.

CAT. NO.	Load Cap.	W	D	H	WT.	PRICE
20 Gauge With Stiffeners**						
Q-3624-S*	1,000	36	24	1 5/16	15.4	\$106.00
Q-3630-S*	1,000	36	30	1 5/16	18.1	\$129.00
Q-3636-S*	750	36	36	1 5/16	21.0	\$129.00
Q-4224-S*	800	42	24	1 5/16	17.6	\$117.00
Q-4230-S*	750	42	30	1 5/16	21.0	
Q-4236-S*	700	42	36	1 5/16	24.0	
Q-4824-S*	700	48	24	1 5/16	19.8	\$129.00
Q-4830-S*	650	48	30	1 5/16	23.0	\$159.00
Q-4836-S*	600	48	36	1 5/16	27.0	\$181.00

*For quantities less than 250, add \$300 Net set-up charge.

**Bin dividers cannot be used on shelves with stiffeners.

National Motor Freight Class: 70

CAT. NO.	Load Cap.	W	D	H	WT.	PRICE
22 Gauge						
Q2-3612♣	750	36	12	1 5/16	6.7	\$41.00
Q2-3615♣	750	36	15	1 5/16	7.8	\$49.00
Q2-3618♣	750	36	18	1 5/16	8.8	\$51.00
Q2-3624♣	700	36	24	1 5/16	10.9	\$61.00
Q2-3630*♣	600	36	30	1 5/16	12.9	\$78.00
Q2-4212♣	600	42	12	1 5/16	7.7	\$51.00
Q2-4215♣	600	42	15	1 5/16	8.9	\$57.00
Q2-4218♣	600	42	18	1 5/16	10.1	\$58.00
Q2-4224♣	550	42	24	1 5/16	12.5	\$71.00
Q2-4230*♣	500	42	30	1 5/16	14.8	\$86.00
Q2-4812♣	500	48	12	1 5/16	8.7	\$49.00
Q2-4815♣	500	48	15	1 5/16	10.1	\$63.00
Q2-4818♣	500	48	18	1 5/16	11.4	\$64.00
Q2-4824♣	450	48	24	1 5/16	14.1	\$75.00
Q2-4830*♣	400	48	30	1 5/16	16.7	\$102.00

CAT. NO.	Load Cap.	W	D	H	WT.	PRICE
20 Gauge						
Q-3612♣	1,000	36	12	1 5/16	8.0	\$49.00
Q-3615*	900	36	15	1 5/16	9.3	\$55.00
Q-3618♣	850	36	18	1 5/16	10.5	\$61.00
Q-3624♣	800	36	24	1 5/16	13.0	\$76.00
Q-3630*	800	36	30	1 5/16	15.4	\$98.00
Q-3636*	600	36	36	1 5/16	17.9	\$116.00
Q-4212*	800	42	12	1 5/16	9.2	\$57.00
Q-4215*	700	42	15	1 5/16	10.6	
Q-4218	650	42	18	1 5/16	12.0	\$71.00
Q-4224	650	42	24	1 5/16	14.9	\$83.00
Q-4230*	600	42	30	1 5/16	17.7	\$109.00
Q-4236*	550	42	36	1 5/16	20.5	\$127.00
Q-4812♣	650	48	12	1 5/16	10.4	\$64.00
Q-4815*	600	48	15	1 5/16	12.0	
Q-4818♣	550	48	18	1 5/16	13.6	\$82.00
Q-4824♣	550	48	24	1 5/16	16.8	\$89.00
Q-4830*	500	48	30	1 5/16	19.9	\$123.00
Q-4836*	450	48	36	1 5/16	23.0	\$140.00

PERFORATED SHELVES



4 shelf clips per shelf included.

National Motor Freight Class: 70

CAT. NO.	Load Cap.	W	D	H	WT.	PRICE
PQ2-3612P	450	36	12	1 5/16	5.8	\$45.00
PQ2-3615P	450	36	15	1 5/16	6.7	\$63.00
PQ2-3618P	450	36	18	1 5/16	7.5	\$64.00
PQ2-3624P	450	36	24	1 5/16	9.2	\$71.00
PQ2-3630P	450	36	30	1 5/16	9.4	\$78.00
PQ2-4215P	375	42	15	1 5/16	7.6	\$56.00
PQ2-4224P	325	42	24	1 5/16	10.5	\$72.00
PQ2-4230P	275	42	30	1 5/16	12.9	\$95.00
PQ2-4812P	300	48	12	1 5/16	7.4	\$55.00
PQ2-4815P	300	48	15	1 5/16	8.5	\$61.00
PQ2-4818P	300	48	18	1 5/16	9.6	\$70.00
PQ2-4824P	250	48	24	1 5/16	11.7	\$85.00
PQ2-4830P	200	48	30	1 5/16	13.9	\$95.00
PQ2-4836P	175	48	36	1 5/16	16.2	\$123.00

SHELF LABEL HOLDERS



Attachment plugs included.

National Motor Freight Class: 70

CAT. NO.	W	D	H	WT.	PRICE
LH-36♣	36	3/16	7/8	0.3	\$4.60
LH-42	42	3/16	7/8	0.4	\$4.80
LH-48♣	48	3/16	7/8	0.5	\$5.30

REPLACEMENT SHELF CLIPS

Attaches shelves to uprights. Shelf clips are Zinc Plated.

National Motor Freight Class: 70



CAT. NO.	W	D	H	WT.	PRICE
T-1	1	1/2	2 3/4	0.1	\$0.78

Standard Colors (Unless Otherwise Specified)



♣ Items with these symbols are available to ship in 2-3 days. Limited quantities and select colors.



Q-Line Shelving: Components

BIN DIVIDERS

CAT. NO.	W	D	H	WT.	PRICE
12" Deep					
BD-1206	7/32	12	6	0.6	\$11.50
BD-1209	7/32	12	9	1.0	13.40
BD-1212	7/32	12	12	1.3	15.90
BD-1215*	7/32	12	15	1.6	17.70
BD-1218	7/32	12	18	1.9	19.00
15" Deep					
BD-1506*	7/32	15	6	1.0	\$14.40
BD-1509*	7/32	15	9	1.3	16.50
BD-1512*	7/32	15	12	1.8	20.00
BD-1515*	7/32	15	15	2.0	22.00
BD-1518*	7/32	15	18	2.7	24.00
18" Deep					
BD-1806	7/32	18	6	1.2	\$14.40
BD-1809	7/32	18	9	1.5	16.50
BD-1812♣	7/32	18	12	2.0	20.00
BD-1815	7/32	18	15	2.5	22.00
BD-1818	7/32	18	18	3.0	24.00

National Motor Freight Class: 70



*For quantities of less than 250 pieces, add \$300 Net set-up charge.

BIN FRONTS

CAT. NO.	W	D	H	WT.	PRICE
BF-362♣	36	3/64	2	1.3	\$14.30
BF-422♣	42	3/64	2	1.5	16.90
BF-482♣	48	3/64	2	1.7	17.50

National Motor Freight Class: 70

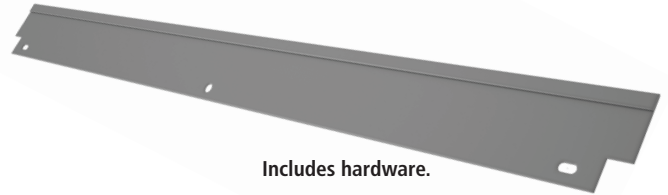

Includes hardware.

END SWAY PLATES

CAT. NO.	W	D	H	WT.	PRICE
ESP-12	—	12 5/8	5	1.2	\$12.00
ESP-18	—	18 5/8	5	2.0	15.40
ESP-24	—	24 5/8	5	2.8	18.60

National Motor Freight Class: 70
Available in Medium Grey only.

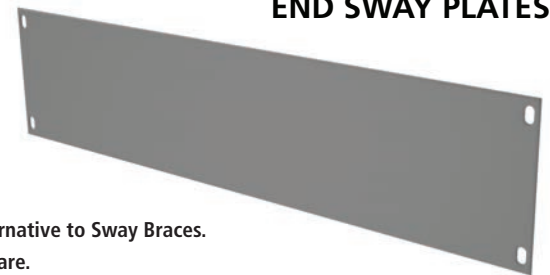

Used as an alternative to Sway Braces.
Includes hardware.

FOOT PLATE

CAT. NO.	W	D	H	WT.	PRICE
FP-1	1 1/2	1/16	2 1/4	0.1	\$1.30

National Motor Freight Class: 70

Used to secure uprights to the floor.
For units 120" and under in height.



SEISMIC FOOT PLATE

CAT. NO.	W	D	H	WT.	PRICE
IFP-1	3 1/4	1 5/8	2 1/2	0.4	\$6.30

For units over 120" in height.
Order one foot plate for each OAP upright and two foot plates back-to-back for each HBP upright, as shown.
When seismic foot is used, bottom shelf is 6 9/32" above floor.
National Motor Freight Class: 70



Single Foot Plate for OAP



Two Foot Plates for HBP

Standard Colors



♣ Items with these symbols are available to ship in 2-3 days. Limited quantities and select colors.



Q-Line Shelving: Components

SLIDING DIVIDERS



CAT. NO.	H	WT.	PRICE
12" Deep			
SD-1230	3	0.7	\$13.50
SD-1245	4 1/2	0.9	14.70
SD-1260	6	1.0	15.60
18" Deep			
SD-1830	3	1.1	\$16.50
SD-1845	4 1/2	1.4	18.00
SD-1860	6	1.6	19.60
24" Deep			
SD-2430	3	1.5	\$18.10
SD-2445	4 1/2	1.8	20.00
SD-2460	6	2.0	22.00

National Motor Freight Class: 70

FRONT BASE STRIPS



CAT. NO.	W	D	H	WT.	PRICE
FBS-362 ♣	36	1/2	1 7/8	1.2	\$16.50
FBS-422	42	1/2	1 7/8	1.5	22.00
FBS-482 ♣	48	1/2	1 7/8	1.7	20.00

National Motor Freight Class: 70

MEZZANINE BRACKETS



MB-3



BMB-3

Includes hardware.

CAT. NO.	W	D	H	WT.	PRICE
For Offset Angle Post					
MB-3	1 1/16	2 1/4	3	0.5	\$6.30
For Heavy Duty Beaded Post					
BMB-3	15/32	3 13/16	3	0.5	\$7.60

National Motor Freight Class: 70

SPLICE PLATES

Includes hardware.



SPOA-4



SPBT-5

CAT. NO.	W	D	H	WT.	PRICE
For Offset Angle Post					
SPOA-4	27/32	1 1/8	4	0.3	\$6.50
For Heavy Duty Beaded Post					
SPBT-5	5/8	2 7/16	5	0.5	\$16.50

National Motor Freight Class: 70

SHELF BOXES



*Dividers are galvanized, not painted.

**Guides are priced per pair. Includes hardware.

CAT. NO.	W	D	H	WT.	PRICE
Shelf Boxes					
BX-512	5 5/8	11	4 9/16	2.5	\$26.00
BX-518	5 5/8	17	4 9/16	3.3	30.00
BX-812	8 3/8	11	4 9/16	3.5	30.00
BX-818	8 3/8	17	4 9/16	4.3	38.00
BX-1112	11 1/4	11	4 9/16	4.5	41.00
BX-1118	11 1/4	17	4 9/16	5.3	45.00
Shelf Box Dividers*					
BXD-5	5 3/16	1/32	4 1/2	0.2	\$1.60
BXD-8	8	1/32	4 1/2	0.3	2.00
BXD-11	10 7/8	1/32	4 1/2	0.4	3.10

National Motor Freight Class: 70

Standard Colors (Unless Otherwise Specified)



Sand (SND) Light Grey (LGY) Medium Grey (MGY)



Items with these symbols are available to ship in 2-3 days. Limited quantities and select colors.



(MGY)

Sway Braces & Hinged Doors

END SWAY BRACES (Sold in Pairs)

CAT. NO.	Shelf Depth	WT.	PRICE
ESB-1224♣	12" to 24"	2.4	\$14.10
ESB-3036♣	30" to 36"	3.1	16.30

NOTE: Use two pair for uprights 96"-137"
and three pair for uprights 138" and higher.

National Motor Freight Class: 70

Includes hardware.

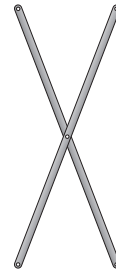

REAR SWAY BRACES (Sold in Pairs)

CAT. NO.	Unit Length	WT.	PRICE
RSBU♣	36" to 42"	3.2	\$17.50
RSB-48♣	48"	3.7	19.50

NOTE: Use two pair for uprights 96"-137"
and three pair for uprights 138" and higher.

National Motor Freight Class: 70

Includes hardware.

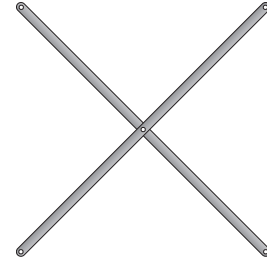

HINGED DOOR SHELVING UNITS (8 Shelves, 7 Openings)

CAT. NO.	W	D	H	WT.	PRICE
HDS-8712RH♣	36	12*	87	172	\$1,224.00
HDS-8718RH♣	36	18*	87	197	1,346.00
HDS-8724RH♣	36	24*	87	221	1,464.00

*Unit depth does not include 1 1/4" depth
of door frame or 1/2" depth of handle.

NOTE: Hinged door shelving units available in Medium Grey only.

Hinged doors come standard with one recessed handle.

- Assembly required.

National Motor Freight Class: 70



HINGED DOORS

CAT. NO.	W	D	H	WT.	PRICE
Full-Height Hinged Doors					
HD-3687RH♣	36	1 1/4*	87	63	\$568.00

* Depth does not include 1/2" depth of handle.

NOTE: Hinged doors available in medium grey only.

Hinged doors come standard with one recessed handle.

Assembly Required.

National Motor Freight Class: 70



SHELVING

Standard Colors (Unless Otherwise Specified)



♣
Items with this symbol are
available to ship in 2-3 days.
Limited quantities
and select colors.



L&T Preconfigured Units - 76" High

8 SHELVES, 7 OPENINGS

- Includes: Uprights (Two Closed "L" for Starter Units)
OR (One Open "T" for Adder Units)
Slotted steel shelves (22 gauge)
Plain top shelf (22 gauge)
Shelf supports
Reinforcements (where noted)
Backstops or centerstops
Adjustable dividers
Front base(s)
Optional back available on page 90



Height to top of bottom shelf: 3"; shelf spaced 10 1/2" on center with 9 3/4" vertical filing space/opening.

- Assembly required.

UNIT SIZE			REINFORCEMENTS PER LEVEL	SHELF LOAD CAPACITY	NO. OF DIVIDERS/ OPENINGS	TOTAL FILING INCHES	STARTER UNITS			ADDER UNITS		
W	D	H					CAT NO.	WT.	PRICE	CAT NO.	WT.	PRICE
Single Entry												
30	12	76 1/4	—	600	4	196	LCT-8-3012-6	110	\$807.00	TOT-8-3012-6	97	\$711.00
36	12	76 1/4	—	600	4	238	LCT-8-3612-6	122	809.00	TOT-8-3612-6	109	713.00
42	12	76 1/4	—	600	4	280	LCT-8-4212-6	151	991.00	TOT-8-4212-6	138	895.00
48	12	76 1/4	—	550	5	322	LCT-8-4812-6	170	1,077.00	TOT-8-4812-6	157	981.00
30	15	76 1/4	—	500	4	196	LCT-8-3015-6	120	877.00	TOT-8-3015-6	104	763.00
36	15	76 1/4	—	500	4	238	LCT-8-3615-6	132	879.00	TOT-8-3615-6	116	765.00
42	15	76 1/4	—	500	4	280	LCT-8-4215-6	162	1,073.00	TOT-8-4215-6	146	959.00
48	15	76 1/4	—	400	5	322	LCT-8-4815-6	183	1,168.00	TOT-8-4815-6	167	1,054.00
Double Entry												
30	24	76 1/4	1	400	8	392	LCT-8-3024-6	187		TOT-8-3024-6	161	\$1,137.00
36	24	76 1/4	1	400	8	476	LCT-8-3624-6	205	1,313.00	TOT-8-3624-6	179	1,139.00
42	24	76 1/4	2	500	8	560	LCT-8-4224-6	247	1,580.00	TOT-8-4224-6	221	1,406.00
48	24	76 1/4	2	450	10	644	LCT-8-4824-6	278	1,723.00	TOT-8-4824-6	252	1,549.00
30	30	76 1/4	2	400	8	392	LCT-8-3030-6	217		TOT-8-3030-6	186	
36	30	76 1/4	2	400	8	476	LCT-8-3630-6	239	1,558.00	TOT-8-3630-6	208	1,358.00
42	30	76 1/4	2	450	8	560	LCT-8-4230-6	275	1,757.00	TOT-8-4230-6	245	
48	30	76 1/4	2	400	10	644	LCT-8-4830-6	310	1,942.00	TOT-8-4830-6	279	1,712.00

No reinforcements are used on the top shelf.

7 SHELVES, 6 OPENINGS

- Includes: Uprights (Two Closed "L" for Starter Units)
OR (One Open "T" for Adder Units)
Slotted steel shelves (22 gauge)
Plain top shelf (22 gauge)
Shelf supports
Reinforcements (where noted)
Backstops or centerstops
Adjustable dividers
Front base(s)
Optional back available on page 90

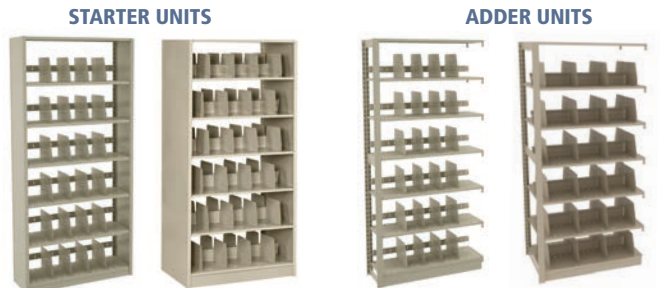

Height to top of bottom shelf: 4 1/2"; shelf spaced 12" on center with 11 1/4" vertical filing space/opening.

- Assembly required.

UNIT SIZE			REINFORCEMENTS PER LEVEL	SHELF LOAD CAPACITY	NO. OF DIVIDERS/ OPENINGS	TOTAL FILING INCHES	STARTER UNITS			ADDER UNITS		
W	D	H					CAT NO.	WT.	PRICE	CAT NO.	WT.	PRICE
Single Entry												
30	12	76 1/4	—	600	4	168	LCT-7-3012-6	100	\$733.00	TOT-7-3012-6	86	\$637.00
36	12	76 1/4	—	600	4	204	LCT-7-3612-6	111	734.00	TOT-7-3612-6	97	638.00
42	12	76 1/4	—	600	4	240	LCT-7-4212-6	136	893.00	TOT-7-4212-6	122	797.00
48	12	76 1/4	—	550	5	276	LCT-7-4812-6	152	972.00	TOT-7-4812-6	139	876.00
30	15	76 1/4	—	500	4	168	LCT-7-3015-6	109	797.00	TOT-7-3015-6	92	
36	15	76 1/4	—	500	4	204	LCT-7-3615-6	120	798.00	TOT-7-3615-6	103	684.00
42	15	76 1/4	—	500	4	240	LCT-7-4215-6	146	967.00	TOT-7-4215-6	130	853.00
48	15	76 1/4	—	400	5	276	LCT-7-4815-6	164	1,054.00	TOT-7-4815-6	148	940.00
Double Entry												
30	24	76 1/4	1	400	8	336	LCT-7-3024-6	169		TOT-7-3024-6	143	
36	24	76 1/4	1	400	8	408	LCT-7-3624-6	185	1,188.00	TOT-7-3624-6	159	1,014.00
42	24	76 1/4	2	500	8	480	LCT-7-4224-6	221		TOT-7-4224-6	195	
48	24	76 1/4	2	450	10	552	LCT-7-4824-6	249	1,552.00	TOT-7-4824-6	223	
30	30	76 1/4	2	400	8	336	LCT-7-3030-6	195	1,404.00	TOT-7-3030-6	165	
36	30	76 1/4	2	400	8	408	LCT-7-3630-6	215	1,406.00	TOT-7-3630-6	184	1,206.00
42	30	76 1/4	2	450	8	480	LCT-7-4230-6	247	1,579.00	TOT-7-4230-6	216	1,379.00
48	30	76 1/4	2	400	10	552	LCT-7-4830-6	277	1,688.00	TOT-7-4830-6	246	

No reinforcements are used on the top shelf.

Standard Colors

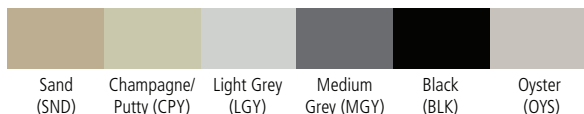

Mobile Ready Units - Any unit can be converted by substituting an "M" for the final dash in the catalog number. Example: LCT-8-3012-6 becomes LCT-8-3012M6. Pricing is identical; weight may vary slightly

SHELVING

L&T Preconfigured Units - 88" High

STARTER UNITS



ADDER UNITS



9 SHELVES, 8 OPENINGS

- Includes:
- Uprights (Two Closed "L" for Starter Units)
OR (One Open "T" for Adder Units)
 - Slotted steel shelves (22 gauge)
 - Plain top shelf (22 gauge)
 - Shelf supports
 - Reinforcements (where noted)
 - Backstops or centerstops
 - Adjustable dividers
 - Front base(s)
 - Optional back available on page 90

Height to top of bottom shelf: 4 1/2"; shelf spaced 10 1/2" on center with 9 3/4" vertical filing space/opening. - Assembly required.

UNIT SIZE		REINFORCEMENTS PER LEVEL	SHELF LOAD CAPACITY	NO. OF DIVIDERS/ OPENINGS	TOTAL FILING INCHES	STARTER UNITS			ADDER UNITS			
W	D					H	CAT NO.	WT.	PRICE	CAT NO.	WT.	PRICE
Single Entry												
30	12	88 1/4	—	600	4	224	LCT-9-3012-7	126	\$921.00	TOT-9-3012-7	109	\$803.00
36	12	88 1/4	—	600	4	272	LCT-9-3612-7	140	923.00	TOT-9-3612-7	123	805.00
42	12	88 1/4	—	600	4	320	LCT-9-4212-7	172	1,126.00	TOT-9-4212-7	155	1,008.00
48	12	88 1/4	—	550	5	368	LCT-9-4812-7	194	1,228.00	TOT-9-4812-7	177	1,110.00
30	15	88 1/4	—	500	4	224	LCT-9-3015-7	136	1,007.00	TOT-9-3015-7	118	871.00
36	15	88 1/4	—	500	4	272	LCT-9-3615-7	150	1,009.00	TOT-9-3615-7	132	873.00
42	15	88 1/4	—	500	4	320	LCT-9-4215-7	184	1,226.00	TOT-9-4215-7	166	1,090.00
48	15	88 1/4	—	400	5	368	LCT-9-4815-7	208	1,338.00	TOT-9-4815-7	190	1,202.00
Double Entry												
30	24	88 1/4	1	400	8	448	LCT-9-3024-7	213	\$1,491.00	TOT-9-3024-7	183	
36	24	88 1/4	1	400	8	544	LCT-9-3624-7	233	1,492.00	TOT-9-3624-7	203	1,297.00
42	24	88 1/4	2	500	8	640	LCT-9-4224-7	281	1,791.00	TOT-9-4224-7	251	1,596.00
48	24	88 1/4	2	450	10	736	LCT-9-4824-7	316	1,964.00	TOT-9-4824-7	286	1,769.00
30	30	88 1/4	2	400	8	448	LCT-9-3030-7	245	1,773.00	TOT-9-3030-7	212	1,536.00
36	30	88 1/4	2	400	8	544	LCT-9-3630-7	270	1,775.00	TOT-9-3630-7	237	1,538.00
42	30	88 1/4	2	450	8	640	LCT-9-4230-7	311	1,996.00	TOT-9-4230-7	278	1,759.00
48	30	88 1/4	2	400	10	736	LCT-9-4830-7	350	2,216.00	TOT-9-4830-7	317	1,979.00

No reinforcements are used on the top shelf.

8 SHELVES, 7 OPENINGS

STARTER UNITS



ADDER UNITS

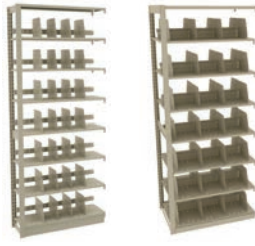

- Includes:
- Uprights (Two Closed "L" for Starter Units)
OR (One Open "T" for Adder Units)
 - Slotted steel shelves (22 gauge)
 - Plain top shelf (22 gauge)
 - Shelf supports
 - Reinforcements (where noted)
 - Backstops or centerstops
 - Adjustable dividers
 - Front base(s)
 - Optional back available on page 90

Height to top of bottom shelf: 4 1/2"; shelf spaced 12" on center with 11 1/4" vertical filing space/opening. - Assembly required.

UNIT SIZE		REINFORCEMENTS PER LEVEL	SHELF LOAD CAPACITY	NO. OF DIVIDERS/ OPENINGS	TOTAL FILING INCHES	STARTER UNITS			ADDER UNITS			
W	D					H	CAT NO.	WT.	PRICE	CAT NO.	WT.	PRICE
Single Entry												
30	12	88 1/4	—	600	4	196	LCT-8-3012-7	115	\$843.00	TOT-8-3012-7	98	\$725.00
36	12	88 1/4	—	600	4	238	LCT-8-3612-7	128	845.00	TOT-8-3612-7	111	727.00
42	12	88 1/4	—	600	4	280	LCT-8-4212-7	156	1,026.00	TOT-8-4212-7	139	908.00
48	12	88 1/4	—	550	5	322	LCT-8-4812-7	175	1,116.00	TOT-8-4812-7	158	998.00
30	15	88 1/4	—	500	4	196	LCT-8-3015-7	124	923.00	TOT-8-3015-7	106	787.00
36	15	88 1/4	—	500	4	238	LCT-8-3615-7	137	925.00	TOT-8-3615-7	119	789.00
42	15	88 1/4	—	500	4	280	LCT-8-4215-7	167	1,118.00	TOT-8-4215-7	149	982.00
48	15	88 1/4	—	400	5	322	LCT-8-4815-7	188	1,217.00	TOT-8-4815-7	170	1,081.00
Double Entry												
30	24	88 1/4	1	400	8	392	LCT-8-3024-7	194		TOT-8-3024-7	164	
36	24	88 1/4	1	400	8	476	LCT-8-3624-7	212	1,360.00	TOT-8-3624-7	182	1,165.00
42	24	88 1/4	2	500	8	560	LCT-8-4224-7	254	1,626.00	TOT-8-4224-7	224	1,431.00
48	24	88 1/4	2	450	10	644	LCT-8-4824-7	285	1,778.00	TOT-8-4824-7	255	1,583.00
30	30	88 1/4	2	400	8	392	LCT-8-3030-7	223		TOT-8-3030-7	190	
36	30	88 1/4	2	400	8	476	LCT-8-3630-7	245	1,615.00	TOT-8-3630-7	212	1,378.00
42	30	88 1/4	2	450	8	560	LCT-8-4230-7	282	1,813.00	TOT-8-4230-7	249	1,576.00
48	30	88 1/4	2	400	10	644	LCT-8-4830-7	316	2,007.00	TOT-8-4830-7	283	1,770.00

No reinforcements are used on the top shelf.

Standard Colors

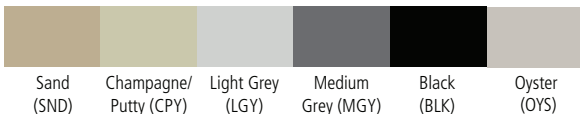

Mobile Ready Units - Any unit can be converted by substituting an "M" for the final dash in the catalog number. Example: LCT-8-3012-6 becomes LCT-8-3012M6. Pricing is identical; weight may vary slightly

Open Uprights

USE FOR ROW ENDS

USE FOR INTERMEDIATE POSTS

All open "L" uprights are 1 1/8" wide.

All open "T" uprights are 2" wide.



CAT. NO.	PCS/CTN	D	H	WT.	PRICE
1240LO	4	12	40 1/4	5.8	\$67.00
1540LO	4	15	40 1/4	6.4	67.00
0964LO	6	9	64 1/4	8.5	84.00
1264LO	4	12	64 1/4	8.9	84.00
1564LO	4	15	64 1/4	9.7	89.00
1864LO	4	18	64 1/4	10.0	89.00
2464LO	4	24	64 1/4	11.0	92.00
3064LO	4	30	64 1/4	12.0	91.00
3664LO	4	36	64 1/4	13.0	97.00
0976LO	4	9	76 1/4	9.6	91.00
1076LO	4	10	76 1/4	9.7	92.00
1276LO	6	12	76 1/4	9.9	92.00
1376LO	4	13	76 1/4	9.9	92.00
1576LO	6	15	76 1/4	10.0	92.00
1676LO	4	16	76 1/4	10.3	95.00
1876LO	4	18	76 1/4	11.0	95.00
2076LO	4	20	76 1/4	11.3	99.00
2476LO	4	24	76 1/4	12.0	99.00
2676LO	4	26	76 1/4	12.4	111.00
3076LO	4	30	76 1/4	13.3	111.00
3276LO	4	32	76 1/4	14.0	119.00
3676LO	4	36	76 1/4	14.0	119.00
0985LO	4	9	85 1/4	10.0	108.00
1085LO	4	10	85 1/4	10.3	102.00
1285LO	6	12	85 1/4	11.0	102.00
1385LO	4	13	85 1/4	11.0	102.00
1585LO	6	15	85 1/4	11.0	102.00
1685LO	4	16	85 1/4	11.3	108.00
1885LO	4	18	85 1/4	12.0	108.00
2085LO	4	20	85 1/4	12.3	116.00
2485LO	4	24	85 1/4	13.0	116.00
2685LO	4	26	85 1/4	13.3	124.00
3085LO	4	30	85 1/4	14.0	124.00
3285LO	4	32	85 1/4	14.3	154.00
3685LO	4	36	85 1/4	15.0	154.00
0988LO	4	9	88 1/4	11.0	102.00
1088LO	4	10	88 1/4	11.0	102.00
1288LO	6	12	88 1/4	11.0	102.00
1388LO	4	13	88 1/4	11.0	104.00
1588LO	6	15	88 1/4	11.0	104.00
1688LO	4	16	88 1/4	13.0	105.00
1888LO	4	18	88 1/4	13.0	105.00
2088LO	4	20	88 1/4	13.3	115.00
2488LO	4	24	88 1/4	14.0	115.00
2688LO	4	26	88 1/4	14.3	122.00
3088LO	4	30	88 1/4	15.0	122.00
3288LO	4	32	88 1/4	16.0	136.00
3688LO	4	36	88 1/4	16.0	136.00
0997LO	4	9	97 1/4	12.0	115.00
1297LO	4	12	97 1/4	13.0	111.00
1597LO	4	15	97 1/4	14.0	124.00
1897LO	4	18	97 1/4	15.0	131.00
2497LO	4	24	97 1/4	17.0	132.00
3097LO	4	30	97 1/4	17.0	148.00
3697LO	4	36	97 1/4	18.0	165.00

CAT. NO.	PCS/CTN	D	H	WT.	PRICE
1240TO	3	12	40 1/4	7.9	\$80.00
1540TO	3	15	40 1/4	8.6	82.00
0964TO	6	9	64 1/4	11.0	99.00
1264TO	3	12	64 1/4	12.0	102.00
1564TO	3	15	64 1/4	13.0	108.00
1864TO	3	18	64 1/4	14.0	109.00
2464TO	3	24	64 1/4	14.7	118.00
3064TO	3	30	64 1/4	15.0	122.00
3664TO	3	36	64 1/4	16.0	114.00
0976TO	6	9	76 1/4	13.4	104.00
1076TO	4	10	76 1/4	13.6	108.00
1276TO	4	12	76 1/4	14.0	108.00
1376TO	4	13	76 1/4	13.7	108.00
1576TO	4	15	76 1/4	13.7	108.00
1676TO	3	16	76 1/4	14.2	112.00
1876TO	3	18	76 1/4	16.0	112.00
2076TO	3	20	76 1/4	16.0	124.00
2476TO	3	24	76 1/4	16.0	124.00
2676TO	3	26	76 1/4	16.7	136.00
3076TO	3	30	76 1/4	18.0	136.00
3276TO	3	32	76 1/4	16.0	151.00
3676TO	3	36	76 1/4	18.0	151.00
0985TO	6	9	85 1/4	12.1	119.00
1085TO	4	10	85 1/4	13.1	118.00
1285TO	4	12	85 1/4	15.0	118.00
1385TO	4	13	85 1/4	15.3	124.00
1585TO	4	15	85 1/4	16.0	124.00
1685TO	3	16	85 1/4	16.3	129.00
1885TO	3	18	85 1/4	17.0	129.00
2085TO	3	20	85 1/4	17.7	141.00
2485TO	3	24	85 1/4	19.0	141.00
2685TO	3	26	85 1/4	19.1	151.00
3085TO	3	30	85 1/4	19.3	151.00
3285TO	3	32	85 1/4	20.0	163.00
3685TO	4	36	85 1/4	22.0	163.00
0988TO	6	9	88 1/4	15.0	119.00
1088TO	4	10	88 1/4	15.0	118.00
1288TO	4	12	88 1/4	15.0	118.00
1388TO	4	13	88 1/4	16.0	128.00
1588TO	4	15	88 1/4	16.0	128.00
1688TO	3	16	88 1/4	18.0	131.00
1888TO	3	18	88 1/4	18.0	131.00
2088TO	3	20	88 1/4	18.0	143.00
2488TO	3	24	88 1/4	18.0	143.00
2688TO	3	26	88 1/4	19.0	149.00
3088TO	3	30	88 1/4	21.0	149.00
3288TO	3	32	88 1/4	23.0	162.00
3688TO	4	36	88 1/4	23.0	162.00
0997TO	6	9	97 1/4	17.0	142.00
1297TO	3	12	97 1/4	18.0	136.00
1597TO	3	15	97 1/4	19.0	149.00
1897TO	3	18	97 1/4	19.0	156.00
2497TO	3	24	97 1/4	21.0	163.00
3097TO	3	30	97 1/4	22.0	178.00
3697TO	3	36	97 1/4	23.0	195.00

Top

Top

Bottom

Bottom

Custom heights and/or custom punch spacing on uprights are available on orders of a single size in quantities of 50 pieces or more and/or orders of multiple sizes in quantities of 200 pieces or more. Call factory for pricing.

Standard Colors



Sand (SND) Champagne/ Putty (CPY) Light Grey (LGY) Medium Grey (MGY) Black (BLK) Oyster (OYS)

Closed Uprights

USE FOR ROW ENDS

CAT. NO.	PCS/CTN	D	H	WT.	PRICE
1240LC	4	12	40 1/4	7.8	\$82.00
1540LC	4	15	40 1/4	9.0	84.00
1840LC	4	18	40 1/4	10.1	92.00
2440LC	4	24	40 1/4	12.0	104.00
3040LC	4	30	40 1/4	14.0	111.00
3640LC	4	36	40 1/4	16.0	122.00
0964LC	6	9	64 1/4	11.0	97.00
1264LC	4	12	64 1/4	12.0	99.00
1564LC	4	15	64 1/4	14.0	109.00
1864LC	4	18	64 1/4	15.0	116.00
2464LC	4	24	64 1/4	19.0	119.00
3064LC	4	30	64 1/4	21.0	153.00
3664LC	4	36	64 1/4	24.0	156.00
0976LC	4	9	76 1/4	13.0	105.00
1076LC	4	10	76 1/4	13.7	102.00
1276LC	6	12	76 1/4	13.7	102.00
1376LC	4	13	76 1/4	14.1	111.00
1576LC	6	15	76 1/4	15.0	111.00
1676LC	4	16	76 1/4	15.1	128.00
1876LC	4	18	76 1/4	17.0	128.00
2076LC	4	20	76 1/4	21.0	149.00
2476LC	4	24	76 1/4	21.0	149.00
2676LC	4	26	76 1/4	22.0	163.00
3076LC	4	30	76 1/4	24.3	168.00
3276LC	4	32	76 1/4	25.0	190.00
3676LC	4	36	76 1/4	28.0	190.00
0985LC	4	9	85 1/4	14.0	122.00
1085LC	4	10	85 1/4	15.0	118.00
1285LC	6	12	85 1/4	15.0	118.00
1385LC	4	13	85 1/4	17.0	131.00
1585LC	6	15	85 1/4	17.0	131.00
1685LC	4	16	85 1/4	17.7	145.00
1885LC	4	18	85 1/4	19.0	145.00
2085LC	4	20	85 1/4	20.0	169.00
2485LC	4	24	85 1/4	23.0	169.00
2685LC	4	26	85 1/4	24.0	189.00
3085LC	4	30	85 1/4	27.0	189.00
3285LC	4	32	85 1/4	31.0	219.00
3685LC	4	36	85 1/4	30.0	219.00
0988LC	4	9	88 1/4	14.0	122.00
1088LC	4	10	88 1/4	16.0	118.00
1288LC	6	12	88 1/4	16.0	118.00
1388LC	6	13	88 1/4	17.0	132.00
1588LC	6	15	88 1/4	17.0	132.00
1688LC	4	16	88 1/4	20.0	148.00
1888LC	4	18	88 1/4	20.0	148.00
2088LC	4	20	88 1/4	24.0	169.00
2488LC	4	24	88 1/4	24.0	169.00
2688LC	4	26	88 1/4	25.0	193.00
3088LC	4	30	88 1/4	27.0	193.00
3288LC	4	32	88 1/4	31.0	214.00
3688LC	4	36	88 1/4	31.0	214.00
0997LC	4	9	97 1/4	16.0	136.00
1297LC	4	12	97 1/4	18.0	141.00
1597LC	4	15	97 1/4	21.0	165.00
1897LC	4	18	97 1/4	23.0	169.00
2497LC	4	24	97 1/4	27.0	199.00
3097LC	4	30	97 1/4	31.0	231.00
3697LC	4	36	97 1/4	35.0	266.00
12121LC	4	12	121 1/4	23.0	175.00
15121LC	4	15	121 1/4	26.0	190.00
18121LC	4	18	121 1/4	28.0	207.00
24121LC	4	24	121 1/4	34.0	234.00
30121LC	4	30	121 1/4	39.0	273.00
36121LC	4	36	121 1/4	44.0	311.00

All closed "L" uprights are 1 1/8" wide.



USE FOR INTERMEDIATE POSTS

CAT. NO.	PCS/CTN	D	H	WT.	PRICE
1240TC	3	12	40 1/4	10.0	\$95.00
1540TC	3	15	40 1/4	11.0	99.00
1840TC	3	18	40 1/4	12.0	105.00
2440TC	3	24	40 1/4	14.0	116.00
3040TC	3	30	40 1/4	16.0	122.00
3640TC	3	36	40 1/4	18.0	131.00
0964TC	6	9	64 1/4	14.0	111.00
1264TC	3	12	64 1/4	16.0	116.00
1564TC	3	15	64 1/4	17.0	128.00
1864TC	3	18	64 1/4	18.5	136.00
2464TC	3	24	64 1/4	22.0	158.00
3064TC	3	30	64 1/4	25.0	176.00
3664TC	3	36	64 1/4	28.0	175.00
0976TC	6	9	76 1/4	16.6	118.00
1076TC	4	10	76 1/4	17.1	131.00
1276TC	4	12	76 1/4	18.0	131.00
1376TC	4	13	76 1/4	18.3	132.00
1576TC	4	15	76 1/4	19.0	132.00
1676TC	3	16	76 1/4	20.0	145.00
1876TC	3	18	76 1/4	22.0	145.00
2076TC	3	20	76 1/4	23.0	173.00
2476TC	3	24	76 1/4	25.0	173.00
2676TC	3	26	76 1/4	26.0	193.00
3076TC	3	30	76 1/4	29.0	193.00
3276TC	3	32	76 1/4	30.0	195.00
3676TC	3	36	76 1/4	32.0	203.00
0985TC	6	9	85 1/4	18.0	136.00
1085TC	4	10	85 1/4	20.0	145.00
1285TC	4	12	85 1/4	20.0	145.00
1385TC	4	13	85 1/4	20.0	156.00
1585TC	4	15	85 1/4	21.0	156.00
1685TC	3	16	85 1/4	22.0	169.00
1885TC	3	18	85 1/4	24.0	169.00
2085TC	3	20	85 1/4	26.0	196.00
2485TC	3	24	85 1/4	29.0	196.00
2685TC	3	26	85 1/4	30.0	226.00
3085TC	3	30	85 1/4	32.0	226.00
3285TC	3	32	85 1/4	37.0	246.00
3685TC	3	36	85 1/4	37.0	246.00
0988TC	6	9	88 1/4	19.0	141.00
1088TC	4	10	88 1/4	20.0	145.00
1288TC	4	12	88 1/4	20.0	145.00
1388TC	4	13	88 1/4	22.0	156.00
1588TC	4	15	88 1/4	22.0	156.00
1688TC	3	16	88 1/4	25.0	173.00
1888TC	3	18	88 1/4	25.0	173.00
2088TC	3	20	88 1/4	26.0	199.00
2488TC	3	24	88 1/4	29.0	199.00
2688TC	3	26	88 1/4	30.0	226.00
3088TC	3	30	88 1/4	33.0	226.00
3288TC	3	32	88 1/4	38.0	246.00
3688TC	3	36	88 1/4	38.0	246.00
0997TC	6	9	97 1/4	21.0	165.00
1297TC	3	12	97 1/4	23.0	169.00
1597TC	3	15	97 1/4	25.0	196.00
1897TC	3	18	97 1/4	28.0	199.00
2497TC	3	24	97 1/4	32.0	227.00
3097TC	3	30	97 1/4	37.0	267.00
3697TC	3	36	97 1/4	41.0	298.00
12121TC	3	12	121 1/4	21.0	210.00
15121TC	3	15	121 1/4	32.0	229.00
18121TC	3	18	121 1/4	35.0	246.00
24121TC	3	24	121 1/4	40.0	271.00
30121TC	3	30	121 1/4	46.0	320.00
36121TC	3	36	121 1/4	51.0	358.00

All closed "T" uprights are 2" wide.



SHELVING

Custom heights and/or custom punch spacing on uprights are available on orders of a single size in quantities of 50 pieces or more and/or orders of multiple sizes in quantities of 200 pieces or more. Call factory for pricing.

Standard Colors



Sand (SND) Champagne/ Putty (CPY) Light Grey (LGY) Medium Grey (MGY) Black (BLK) Oyster (OYS)

Thin Profile Shelves (No Slots)

THIN PROFILE SHELVES - 22 GAUGE



CAT. NO.	LOAD CAP.*	Recommended Reinforcements	PCS/ CTN	W	D	H	WT.	PRICE
T2-2412	600	—	16	24	12	25/32	3.1	\$28.00
T2-2415	500	—	16	24	15	25/32	3.8	38.00
T2-2424	400	1	8	24	24	25/32	5.8	53.00
T2-2430	400	2	8	24	30	25/32	7.2	70.00
T2-3010	600	—	8	30	10	25/32	3.2	28.00
T2-3012	600	—	8	30	12	25/32	3.8	28.00
T2-3013	500	—	8	30	13	25/32	4.1	38.00
T2-3015	500	—	8	30	15	25/32	4.7	38.00
T2-3016	500	1	8	30	16	25/32	4.9	44.00
T2-3018	500	1	8	30	18	25/32	5.5	44.00
T2-3020	400	1	8	30	20	25/32	6.1	53.00
T2-3024	400	1	8	30	24	25/32	7.2	53.00
T2-3026	400	2	8	30	26	25/32	7.7	70.00
T2-3030	400	2	8	30	30	25/32	8.8	70.00
T2-3032	400	2	8	30	32	25/32	9.4	80.00
T2-3609	600	—	16	36	9	25/32	3.6	31.00
T2-3610	600	—	16	36	10	25/32	3.9	28.00
T2-3612	600	—	16	36	12	25/32	4.6	28.00
T2-3613	500	—	8	36	13	25/32	4.6	38.00
T2-3615	500	—	8	36	15	25/32	5.5	38.00
T2-3616	500	1	8	36	16	25/32	5.9	44.00
T2-3618	500	1	8	36	18	25/32	6.5	44.00
T2-3620	400	1	8	36	20	25/32	7.2	53.00
T2-3624	400	1	8	36	24	25/32	8.5	53.00
T2-3626	400	2	8	36	26	25/32	9.2	70.00
T2-3630	400	2	8	36	30	25/32	10.5	70.00
T2-3632	400	2	8	36	32	25/32	11.1	80.00

CAT. NO.	LOAD CAP.*	Recommended Reinforcements	PCS/ CTN	W	D	H	WT.	PRICE
T2-4209	600	—	16	42	9	25/32	4.1	\$31.00
T2-4210	600	—	12	42	10	25/32	4.5	36.00
T2-4212	600	—	12	42	12	25/32	5.3	36.00
T2-4213	500	—	8	42	13	25/32	5.7	44.00
T2-4215	500	—	8	42	15	25/32	6.4	44.00
T2-4216	500	1	8	42	16	25/32	6.8	53.00
T2-4218	500	1	8	42	18	25/32	7.6	53.00
T2-4220	500	1	8	42	20	25/32	8.3	64.00
T2-4224	500	1	8	42	24	25/32	9.8	64.00
T2-4226	450	2	8	42	26	25/32	10.6	77.00
T2-4230	450	2	8	42	30	25/32	12.0	77.00
T2-4232	450	2	8	42	32	25/32	12.8	82.00
T2-4809	550	—	16	48	9	25/32	4.7	41.00
T2-4810	550	—	12	48	10	25/32	5.1	40.00
T2-4812	550	—	12	48	12	25/32	6.0	40.00
T2-4813	400	—	8	48	13	25/32	6.4	50.00
T2-4815	400	—	8	48	15	25/32	7.3	50.00
T2-4816	350	1	8	48	16	25/32	7.7	57.00
T2-4818	350	1	8	48	18	25/32	8.6	57.00
T2-4820	450	2	8	48	20	25/32	9.5	67.00
T2-4824	450	2	8	48	24	25/32	11.2	67.00
T2-4826	400	2	8	48	26	25/32	12.1	87.00
T2-4830	400	2	6	48	30	25/32	13.8	87.00
T2-4832	400	2	6	48	32	25/32	14.7	98.00

For use with all uprights except double wall (library) uprights. Each shelf requires two shelf supports. Load capacities are based on using the recommended number of TR-dd reinforcements and on using TS-wwgg shelf supports, with weight evenly distributed. Shelves punched for optional center dividers (CD-ww). If using SHS supports, HR-dd reinforcements are required. *NOTE: Load capacities do not apply to mobile units.

THIN PROFILE SHELVES - 18 GAUGE

CAT. NO.	LOAD CAP.*	Recommended Reinforcements	PCS/ CTN	W	D	H	WT.	PRICE
T-3012	600	—	16	30	12	25/32	5.4	53.00
T-3015	500	—	8	30	15	25/32	8.2	70.00
T-3024	400	1	8	30	24	25/32	13.0	95.00
T-3030	500	2	8	30	30	25/32	16.8	99.00
T-3609	600	—	16	36	9	25/32	5.7	51.00
T-3612	600	—	16	36	12	25/32	7.3	53.00
T-3615	500	—	8	36	15	25/32	8.9	70.00
T-3618	500	1	8	36	18	25/32	10.5	67.00
T-3624	400	1	8	36	24	25/32	13.6	95.00
T-3630	500	2	8	36	30	25/32	18.0	111.00
T-4209	600	—	16	42	9	25/32	6.6	50.00
T-4212	600	—	12	42	12	25/32	8.4	64.00
T-4215	500	—	8	42	15	25/32	10.3	71.00
T-4218	550	1	8	42	18	25/32	12.1	78.00
T-4224	550	2	8	42	24	25/32	15.8	97.00
T-4230	550	2	8	42	30	25/32	19.4	115.00
T-4809	550	—	16	48	9	25/32	7.5	67.00
T-4812	550	—	12	48	12	25/32	9.6	78.00
T-4815	450	—	8	48	15	25/32	11.7	88.00
T-4818	450	1	8	48	18	25/32	13.8	85.00
T-4824	500	2	8	48	24	25/32	17.9	105.00
T-4830	500	2	6	48	30	25/32	22.1	138.00



For use with all uprights except double wall (library) uprights. Each shelf requires two shelf supports. Load capacities are based on using the recommended number of TR-dd reinforcements and on using TS-wwgg shelf supports, with weight evenly distributed. Shelves punched for optional center dividers (CD-ww). If using SHS supports, HR-dd reinforcements are required.

*NOTE: Load capacities do not apply to mobile units.

Standard Colors

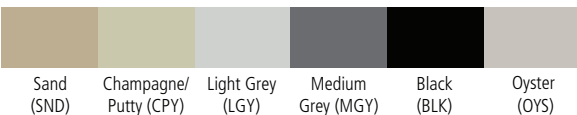

SHELVING

Thin Profile Slotted Shelves

THIN PROFILE SLOTTED SHELVES - 22 GAUGE



SINGLE ENTRY

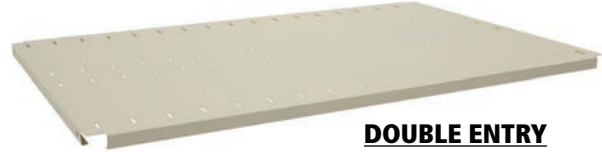

DOUBLE ENTRY

CAT. NO.	LOAD CAP.*	Recommended Reinforcements	PCS/ CTN	W	D	H	WT.	PRICE
SINGLE ENTRY								
TQ2-2412	600	—	16	24	12	25/32	3.8	\$30.00
TQ2-2415	500	—	8	24	15	25/32	3.8	36.00
TQ2-3010	600	—	16	30	10	25/32	3.2	30.00
TQ2-3012	600	—	16	30	12	25/32	3.8	30.00
TQ2-3013	500	—	8	30	13	25/32	4.1	36.00
TQ2-3015	500	—	8	30	15	25/32	4.7	36.00
TQ2-3016	500	1	8	30	16	25/32	4.9	44.00
TQ2-3609	600	—	16	36	9	25/32	3.6	30.00
TQ2-3610	600	—	16	36	10	25/32	3.9	30.00
TQ2-3612	600	—	16	36	12	25/32	4.6	30.00
TQ2-3613	500	—	8	36	13	25/32	4.9	36.00
TQ2-3615	500	—	8	36	15	25/32	5.5	36.00
TQ2-3616	500	1	8	36	16	25/32	5.9	44.00
TQ2-4209	600	—	16	42	9	25/32	4.1	31.00
TQ2-4210	600	—	16	42	10	25/32	4.5	36.00
TQ2-4212	600	—	12	42	12	25/32	5.3	36.00
TQ2-4213	500	—	8	42	13	25/32	5.7	44.00
TQ2-4215	500	—	8	42	15	25/32	6.4	44.00
TQ2-4216	500	1	12	42	16	25/32	6.8	57.00
TQ2-4809	550	—	16	48	9	25/32	4.7	36.00
TQ2-4810	550	—	16	48	10	25/32	5.1	38.00
TQ2-4812	550	—	12	48	12	25/32	6.0	38.00
TQ2-4813	400	—	8	48	13	25/32	6.4	47.00
TQ2-4815	400	—	8	48	15	25/32	7.3	47.00
TQ2-4816	350	1	8	48	16	25/32	7.7	57.00

CAT. NO.	LOAD CAP.*	Recommended Reinforcements	PCS/ CTN	W	D	H	WT.	PRICE
DOUBLE ENTRY								
TQD2-2424	400	1	8	24	24	25/32	5.8	\$53.00
TQD2-2430	400	2	8	24	30	25/32	7.2	70.00
TQD2-3020	400	1	8	30	20	25/32	7.2	53.00
TQD2-3024	400	1	8	30	24	25/32	7.2	53.00
TQD2-3026	400	2	8	30	26	25/32	7.7	70.00
TQD2-3030	400	2	8	30	30	25/32	8.7	70.00
TQD2-3032	400	2	8	30	32	25/32	9.4	80.00
TQD2-3618	500	1	8	36	18	25/32	6.5	50.00
TQD2-3620	400	1	8	36	20	25/32	7.2	53.00
TQD2-3624	400	1	8	36	24	25/32	8.5	53.00
TQD2-3626	400	2	8	36	26	25/32	9.2	70.00
TQD2-3630	400	2	8	36	30	25/32	10.5	70.00
TQD2-3632	400	2	8	36	32	25/32	11.1	80.00
TQD2-4218	500	1	8	42	18	25/32	7.6	57.00
TQD2-4220	500	2	8	42	20	25/32	8.4	62.00
TQD2-4224	500	2	8	42	24	25/32	9.9	62.00
TQD2-4226	450	2	8	42	26	25/32	10.6	77.00
TQD2-4230	450	2	8	42	30	25/32	12.1	77.00
TQD2-4232	450	2	8	42	32	25/32	12.9	80.00
TQD2-4818	350	1	8	48	18	25/32	8.6	58.00
TQD2-4820	450	2	8	48	20	25/32	9.5	67.00
TQD2-4824	450	2	8	48	24	25/32	11.2	67.00
TQD2-4826	400	2	8	48	26	25/32	12.1	87.00
TQD2-4830	400	2	8	48	30	25/32	13.8	87.00
TQD2-4832	400	2	8	48	32	25/32	14.7	105.00

For use with all uprights except double wall (library) uprights. Each shelf requires two shelf supports. Load capacities are based on using the recommended number of TR-dd reinforcements and using TS-wvvgg shelf supports, with weight evenly distributed. If using SHS supports, HR-dd reinforcements are required. Slotted on 2" centers for optional adjustable dividers. *NOTE: Load capacities do not apply to mobile units.

THIN PROFILE SLOTTED SHELVES - 18 GAUGE



SINGLE ENTRY



DOUBLE ENTRY

CAT. NO.	LOAD CAP.*	Recommended Reinforcements	PCS/ CTN	W	D	H	WT.	PRICE
SINGLE ENTRY								
TQ-3012	600	—	16	30	12	25/32	6.1	57.00
TQ-3015	500	—	8	30	15	25/32	7.5	62.00
TQ-3609	600	—	16	36	9	25/32	5.7	51.00
TQ-3612	600	—	16	36	12	25/32	7.3	57.00
TQ-3615	500	—	8	36	15	25/32	8.9	62.00
TQ-4209	600	—	16	42	9	25/32	6.6	61.00
TQ-4212	600	—	12	42	12	25/32	8.4	60.00
TQ-4215	500	—	8	42	15	25/32	10.3	71.00
TQ-4809	550	—	16	48	9	25/32	7.5	67.00
TQ-4812	550	—	12	48	12	25/32	9.6	75.00
TQ-4815	450	—	8	48	15	25/32	11.7	85.00

CAT. NO.	LOAD CAP.*	Recommended Reinforcements	PCS/ CTN	W	D	H	WT.	PRICE
DOUBLE ENTRY								
TQD-3024	400	1	8	30	24	25/32	13.6	88.00
TQD-3030	500	2	8	30	30	25/32	16.8	109.00
TQD-3618	500	1	8	36	18	25/32	10.5	85.00
TQD-3624	400	1	8	36	24	25/32	13.6	88.00
TQD-3630	500	2	8	36	30	25/32	16.8	109.00
TQD-4218	550	1	8	42	18	25/32	12.1	92.00
TQD-4224	550	2	8	42	24	25/32	15.8	95.00
TQD-4230	550	2	8	42	30	25/32	19.4	128.00
TQD-4818	450	1	8	48	18	25/32	13.8	101.00
TQD-4824	500	2	8	48	24	25/32	17.9	109.00
TQD-4830	500	2	8	48	30	25/32	22.1	132.00

For use with all uprights except double wall (library) uprights. Each shelf requires two shelf supports. Load capacities are based on using the recommended number of TR-dd reinforcements and using TS-wvvgg shelf supports, with weight evenly distributed. If using SHS supports, HR-dd reinforcements are required. Slotted on 2" centers for optional adjustable dividers. *NOTE: Load capacities do not apply to mobile units.

Standard Colors

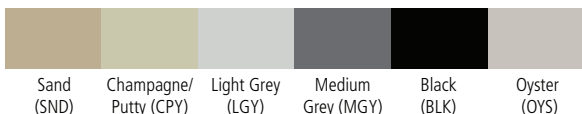

THIN SHELF SUPPORTS



CAT. NO.	PCS/CTN	W	D	H	WT.	PRICE
14 GAUGE						
TS-2414	30	24	—	3/4	1.0	\$9.10
TS-3014	30	30	—	3/4	1.3	9.10
TS-3614	30	36	—	3/4	1.6	9.20

CAT. NO.	PCS/CTN	W	D	H	WT.	PRICE
11 GAUGE						
TS-3611	30	36	—	3/4	2.5	\$14.50
TS-4211	30	42	—	3/4	2.9	16.50
TS-4811	30	48	—	3/4	3.3	18.20

THIN SHELF REINFORCEMENTS



CAT. NO.	PCS/CTN	W	D	H	WT.	PRICE
TR-09	144	15/16	9	5/8	.3	\$4.10
TR-10	144	15/16	10	5/8	.4	
TR-12	144	15/16	12	5/8	.5	4.10
TR-13	144	15/16	13	5/8	.5	4.70
TR-15	144	15/16	15	5/8	.6	4.70
TR-16	144	15/16	16	5/8	.7	5.30

CAT. NO.	PCS/CTN	W	D	H	WT.	PRICE
TR-18	72	15/16	18	5/8	.7	\$5.30
TR-20	72	15/16	20	5/8	1.0	7.20
TR-24	72	15/16	24	5/8	1.0	7.20
TR-26	72	15/16	26	5/8	1.1	8.70
TR-30	72	15/16	30	5/8	1.3	8.70
TR-32	72	15/16	32	5/8	1.3	8.70

THIN SHELF SUPPORTS (For Single Entry Only)

An economical option for use with single-entry units only. TSC-ww14 shelf supports will not accept shelf reinforcements, and thus should not be used when TR-dd shelf reinforcements are required. Two supports required per shelf.



CAT. NO.	PCS/CTN	W	D	H	WT.	PRICE
14 GAUGE						
TSC-3614	30	36	—	3/4	1.5	\$10.40
TSC-4214	30	42	—	3/4	1.9	11.80
TSC-4814	30	48	—	3/4	2.2	13.80

HEAVY SHELF SUPPORTS



CAT. NO.	PCS/CTN	W	D	H	WT.	PRICE
14 GAUGE						
HS-3014	30	30	—	1 1/8	1.3	\$9.80
HS-3614	30	36	—	1 1/8	1.8	9.80
HS-4214	30	42	—	1 1/8	2.0	11.50
HS-4814	30	48	—	1 1/8	2.2	12.80

CAT. NO.	PCS/CTN	W	D	H	WT.	PRICE
11 GAUGE						
HS-3611	30	36	—	1 1/8	2.6	\$16.20
HS-4211	30	42	—	1 1/8	3.1	17.00
HS-4811	30	48	—	1 1/8	3.6	18.90

HEAVY SHELF REINFORCEMENTS



CAT. NO.	PCS/CTN	W	D	H	WT.	PRICE
HR-12	96	15/16	12	5/8	.7	\$5.70
HR-13	96	15/16	13	5/8	.8	6.40
HR-15	96	15/16	15	5/8	.9	6.40
HR-16	96	15/16	16	5/8	1.1	7.20
HR-18	48	15/16	18	5/8	1.1	7.20

CAT. NO.	PCS/CTN	W	D	H	WT.	PRICE
HR-20	48	15/16	20	5/8	1.5	\$9.50
HR-24	48	15/16	24	5/8	1.5	9.50
HR-26	48	15/16	26	5/8	1.6	11.20
HR-30	48	15/16	30	5/8	1.9	11.20
HR-32	48	15/16	32	5/8	2.3	13.60
HR-36	36	15/16	36	5/8	2.3	13.60

SINGLE RIVET BOTTOM SHELF SUPPORTS



Two supports required per shelf. Use HR-dd reinforcements for 18" & deeper shelves. Use only with bottom shelf, to permit shelf to fit flush with floor or for attachment to mobile bases.

CAT. NO.	PCS/CTN	W	D	H	WT.	PRICE
SHS-2414	30	24	—	1 3/8	2.0	\$13.80
SHS-3014	30	30	—	1 3/8	2.0	13.80
SHS-3614	30	36	—	1 3/8	2.0	13.80
SHS-4214	30	42	—	1 3/8	2.4	14.30
SHS-4814	30	48	—	1 3/8	2.7	15.80

HANG-ROD COMPONENTS

Hang rod assemblies require two hanging brackets, one hang bar and four galvanized clips (each sold separately, below) to attach. Provides one hanging position.



CAT. NO.	PCS/CTN	W	D	H	WT.	PRICE
HANG BAR						
LTTB-30	1	30	1/2	1 1/2	2.1	\$26.00
LTTB-36	1	36	1/2	1 1/2	2.1	27.00
LTTB-42	1	42	1/2	1 1/2	2.4	30.00
LTTB-48	1	48	1/2	1 1/2	2.7	33.00
HANG BAR CLIPS						
MC-1P	1	Painted			.1	\$0.94

CAT. NO.	PCS/CTN	W	D	H	WT.	PRICE
HANGING BRACKETS						
HRSB-12	1	1	12	2 1/8	1.2	\$27.00
HRSB-15	1	1	15	2 1/8	1.5	28.00
HRSB-18	1	1	18	2 1/8	1.9	22.00
HRSB-24	1	1	24	2 1/8	2.5	24.00
HRSB-30	1	1	30	2 1/8	3.2	34.00

Standard Colors

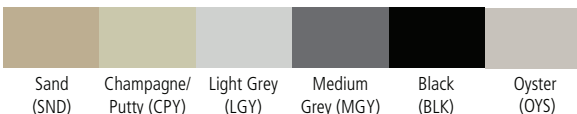

Alternative Shelves & Dividers



HEAVY SHELF

Each shelf requires two shelf supports. Load capacities are based on using the recommended number of HR-dd reinforcements and using HS-ww11 shelf supports, with weight evenly distributed.

*NOTE: Load capacities do not apply to mobile units.

CAT. NO.	LOAD CAP.*	Recommended Reinforcements	PCS/CTN	W	D	H	WT.	PRICE
HEAVY SHELF								
H-3612	1,100	—	12	36	12	1 7/32	7.9	\$54.00
H-3615	1,000	—	6	36	15	1 7/32	9.5	58.00
H-3618	950	1	6	36	18	1 7/32	11.1	72.00
H-3624	900	1	6	36	24	1 7/32	14.4	89.00
H-3630	1,000	2	4	36	30	1 7/32	17.6	108.00
H-3636	900	2	4	36	36	1 7/32	20.8	126.00
H-4212	1,000	—	8	42	12	1 7/32	9.1	78.00
H-4215	900	—	6	42	15	1 7/32	11.0	80.00
H-4218	800	1	6	42	18	1 7/32	12.8	85.00

CAT. NO.	LOAD CAP.*	Recommended Reinforcements	PCS/CTN	W	D	H	WT.	PRICE
HEAVY SHELF								
H-4224	900	2	6	42	24	1 7/32	16.6	\$98.00
H-4230	900	2	4	42	30	1 7/32	20.3	131.00
H-4236	800	2	4	42	36	1 7/32	24.0	136.00
H-4812	900	—	8	48	12	1 7/32	10.3	75.00
H-4815	750	—	6	48	15	1 7/32	12.5	82.00
H-4818	700	1	6	48	18	1 7/32	14.6	91.00
H-4824	800	2	6	48	24	1 7/32	18.8	112.00
H-4830	800	2	4	48	30	1 7/32	23.0	135.00
H-4836	700	2	4	48	36	1 7/32	27.3	156.00



PARTICLEBOARD SHELVES

Each shelf requires two HS shelf supports. Load capacities are based on using HS-ww14 shelf supports and on weight being evenly distributed.

*NOTE: Load capacities do not apply to mobile units.

Color option not available

CAT. NO.	W	D	H	WT.	PRICE
PBL-3612	35 9/16	10 7/8	5/8	7.7	\$15.50
PBL-3615	35 9/16	13 7/8	5/8	9.6	17.60
PBL-3618	35 9/16	16 7/8	5/8	11.4	23.00
PBL-3624	35 9/16	22 7/8	5/8	15.1	31.00
PBL-3630	35 9/16	28 7/8	5/8	19.2	38.00
PBL-3636	35 9/16	34 7/8	5/8	23.0	45.00
PBL-4212	41 9/16	10 7/8	5/8	8.9	19.60
PBL-4215	41 9/16	13 7/8	5/8	11.2	22.00
PBL-4218	41 9/16	16 7/8	5/8	13.4	28.00

CAT. NO.	W	D	H	WT.	PRICE
PBL-4224	41 9/16	22 7/8	5/8	17.8	\$38.00
PBL-4230	41 9/16	28 7/8	5/8	23.0	41.00
PBL-4236	41 9/16	34 7/8	5/8	27.0	52.00
PBL-4812	47 9/16	10 7/8	5/8	10.2	21.00
PBL-4815	47 9/16	13 7/8	5/8	12.7	26.00
PBL-4818	47 9/16	16 7/8	5/8	15.2	30.00
PBL-4824	47 9/16	22 7/8	5/8	20.0	40.00
PBL-4830	47 9/16	28 7/8	5/8	25.0	50.00
PBL-4836	47 9/16	34 7/8	5/8	31.0	59.00

CAT. NO.	PCS/CTN	W	D	H	WT.	PRICE
Used on 36", 42" or 48" wide units						
RSMB-12	2	30	12	5/8	9.3	\$98.00
RSMB-15	2	30	15	5/8	9.7	100.00
RSMB-18	2	30	18	5/8	10.0	105.00
RSMB-24	2	30	24	5/8	10.8	108.00
RSMB-30	2	30	30	5/8	11.6	112.00
RSMB-36	2	30	36	5/8	12.4	114.00
30" WIDE EXTRA SHELF (FOR DOUBLE ENTRY UNITS)						
RS-3012	2	30	11 7/8	5/8	7.2	\$81.00

CAT. NO.	PCS/CTN	W	D	H	WT.	PRICE
Used on 30" wide units						
RSMB-12-24	2	24	12	5/8	7.9	\$139.00
RSMB-15-24	2	24	15	5/8	8.3	141.00
RSMB-18-24	2	24	18	5/8	8.6	146.00
RSMB-24-24	2	24	24	5/8	9.4	149.00
RSMB-30-24	2	24	30	5/8	10.2	153.00
RSMB-36-24	2	24	36	5/8	11.0	
24" WIDE EXTRA SHELF (FOR DOUBLE ENTRY UNITS)						
RS-2412	2	24	11 7/8	5/8	5.8	\$122.00

REFERENCE SHELF KITS



Shelf is 11 7/8" deep. Reduces filing space by 1". Kit comes with mounting brackets and one shelf. Brackets and shelves packed separately. For double entry units, order extra shelf.

SHELVING

CAT. NO.	PCS/CTN	W	D	H	WT.	PRICE
LTPD-30	8	30	14	1 5/16	8.7	
LTPD-36	8	36	14	1 5/16	10.1	193.00
LTPD-42	8	42	14	1 5/16	11.7	
LTPD-48	8	48	14	1 5/16	13.2	220.00

For quantities less than 25 pieces, add \$300/Net setup charge.

Used for displaying media such as magazines, journals, etc.

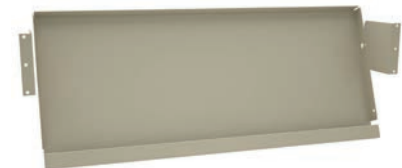

PERIODICAL SHELVES

CAT. NO.	PCS/CTN	W	D	H	WT.	PRICE
ADJUSTABLE FILE DIVIDER (STEEL)						
FD-0808*	40	—	8	8	.5	\$5.50
FD-1108**	50	—	11	8	.8	5.00
FDP-1108	50	—	11	8	.8	5.00
ADJUSTABLE FILE DIVIDER (PLASTIC)						
PD-1108	25	—	11	8	.4	\$5.00

*Use FD-0808 with TQ2-ww09, TQD2-ww18, LQ2-ww09 & LQD2-ww18.
**Includes Tennsco imprint.



FD-1108

PD-1108

Standard Colors (Unless Otherwise Specified)

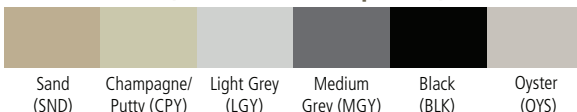

LOCKING DOOR KITS (For HIPAA Compliance)



LTHD-4276RH
Hinged Door for Single Units —
Extends 1 3/4" from front of unit; door
frame uses 1/2" vertical filing space.

All doors come standard with lock, in compliance with Health Insurance Portability and Accountability Act of 1996 (HIPAA) regulations.

CAT. NO.	PCS/CTN	W	D	H	WT.	PRICE
HINGED DOOR KIT — Fits Single Units						
LTHD-3676RH	—	36	1 3/4	76	56	\$814.00
LTHD-4276RH	—	42	1 3/4	76	64	861.00
LTHD-4876RH	—	48	1 3/4	76	81	1,041.00
LTHD-3688RH	—	36	1 3/4	88	63	771.00
LTHD-4288RH	—	42	1 3/4	88	74	1,103.00
LTHD-4888RH	—	48	1 3/4	88	84	1,113.00
EXTENDED HINGED DOOR KIT* — Fits Single Units**						
LTHD-3676RHD	—	36	2 3/4	76	60	\$865.00
LTHD-4276RHD	—	42	2 3/4	76	68	985.00
LTHD-4876RHD	—	48	2 3/4	76	86	1,113.00
LTHD-3688RHD	—	36	2 3/4	88	68	838.00
LTHD-4288RHD	—	42	2 3/4	88	79	1,061.00
LTHD-4888RHD	—	48	2 3/4	88	89	1,189.00

*Provides additional clearance for filing with end tab file folders.
**Extends 2 3/4" from front of unit;
Door frame uses 1/2" vertical filing space.
For optional keyed alike lock (\$18 Net), add "KA" to catalog number.
For optional keyed specific lock (\$18 Net), add "KS" to catalog number.

BACKS - TWO PIECES



Packed 4 pieces per carton. Top and bottom stiffeners included.

CAT. NO.	W	D	H	WT.	PRICE
30" WIDE					
LTBP-3064-2	30	—	64 ^{3/16}	13.0	\$236.00
LTBP-3076-2	30	—	76 ^{3/16}	15.4	227.00
LTBP-3085-2	30	—	85 ^{3/16}	17.2	267.00
LTBP-3088-2	30	—	88 ^{3/16}	17.8	251.00
LTBP-3097-2	30	—	97 ^{3/16}	19.9	304.00
LTBP-30121-2	30	—	121 ^{3/16}	25.0	351.00
36" WIDE					
LTBP-3664-2	36	—	64 ^{3/16}	15.6	\$236.00
LTBP-3676-2	36	—	76 ^{3/16}	18.6	227.00
LTBP-3685-2	36	—	85 ^{3/16}	21.0	267.00
LTBP-3688-2	36	—	88 ^{3/16}	21.0	251.00
LTBP-3697-2	36	—	97 ^{3/16}	24.0	304.00
LTBP-36121-2	36	—	121 ^{3/16}	30.0	351.00

CAT. NO.	W	D	H	WT.	PRICE
42" WIDE					
LTBP-4264-2	42	—	64 ^{3/16}	18.3	\$260.00
LTBP-4276-2	42	—	76 ^{3/16}	22.0	271.00
LTBP-4285-2	42	—	85 ^{3/16}	24.0	307.00
LTBP-4288-2	42	—	88 ^{3/16}	25.0	293.00
LTBP-4297-2	42	—	97 ^{3/16}	28.0	332.00
LTBP-42121-2	42	—	121 ^{3/16}	35.0	358.00
48" WIDE					
LTBP-4864-2	48	—	64 ^{3/16}	21.0	\$261.00
LTBP-4876-2	48	—	76 ^{3/16}	25.0	291.00
LTBP-4885-2	48	—	85 ^{3/16}	28.0	311.00
LTBP-4888-2	48	—	88 ^{3/16}	29.0	322.00
LTBP-4897-2	48	—	97 ^{3/16}	32.0	349.00
LTBP-48121-2	48	—	121 ^{3/16}	40.0	400.00

SLOTTED AND ADJUSTABLE BACK STOPS



SLOTTED BACK STOPS
Use with FD-0808, FD-1108,
FDP-1108, FD-1612, PD-1108

CAT. NO.	PCS/CTN	W	D	H	WT.	PRICE
SLOTTED BACK STOPS						
BS-30	40	30	—	2	1.2	\$10.20
BS-36	40	36	—	2	1.3	10.20
BS-42	40	42	—	2	1.6	11.60
BS-48	40	48	—	2	1.8	12.80

SLOTTED CENTER STOPS



Use with double entry thin
slotted shelves only.

CAT. NO.	PCS/CTN	W	D	H	WT.	PRICE
SLOTTED CENTER STOP*						
CS-30	20	30	—	4	1.9	\$13.80
CS-36	20	36	—	4	2.2	13.80
CS-42	20	42	—	4	2.6	16.00
CS-48	20	48	—	4	3.0	17.90

UNSLOTTED CENTER DIVIDERS



Use with unslotted shelves to divide shelves
into equal halves. Not available for
use on 9" deep shelves.

CAT. NO.	PCS/CTN	W	D	H	WT.	PRICE
CD-30	50	30	3/8	2	1.4	\$20.00
CD-36	50	36	3/8	2	1.4	20.00
CD-42	50	42	3/8	2	1.6	22.00
CD-48	50	48	3/8	2	1.8	23.00

NYLON FEET



Black nylon foot shaped to fit each type of
L&T upright. May also be used as an upright
top cap. Two required per upright.

CAT. NO.	DESCRIPTION	PRICE
LTNF-L	Fits "L" Uprights	\$2.60
LTNF-T	Fits "T" Uprights	2.60

Foot For "T" Uprights

Foot For "L" Uprights

Available in Black only.

Standard Colors (Unless Otherwise Specified)



Sand (SND) Champagne/ Putty (CPY) Light Grey (LGY) Medium Grey (MGY) Black (BLK) Oyster (OYS)

SEISMIC FULL HEIGHT CENTER STOPS

CAT. NO.	PCS/CTN	W	D	H	WT.	PRICE
FOR LETTER AND LEGAL FILING						
FHCS-3010.5	8	30	—	10½	6.2	\$72.00
FHCS-3012	8	30	—	12	6.9	77.00
FHCS-3013.5	8	30	—	13½	7.3	84.00
FHCS-3015	8	30	—	15	8.2	85.00
FHCS-3610.5	8	36	—	10½	7.4	72.00
FHCS-3612	8	36	—	12	8.2	77.00
FHCS-3613.5	8	36	—	13½	9.0	84.00
FHCS-3615	8	36	—	15	9.7	85.00
FHCS-4210.5	8	42	—	10½	8.6	84.00
FHCS-4212	8	42	—	12	9.5	85.00
FHCS-4213.5	8	42	—	13½	10.4	89.00
FHCS-4215	8	42	—	15	11.3	97.00
FHCS-4810.5	8	48	—	10½	9.7	87.00
FHCS-4812	8	48	—	12	10.8	95.00
FHCS-4813.5	8	48	—	13½	11.8	99.00
FHCS-4815	8	48	—	15	12.8	104.00



Used to help reinforce shelving units in seismic zones.

For quantities less than 100 pieces, add \$500 Net set-up charge.

FRONT BASES

CAT. NO.	PCS/CTN	W	D	H	WT.	PRICE
FB-3002	50	30	—	2 5/16	.7	\$8.40
FB-3602	50	36	—	2 5/16	1.0	8.40
FB-4202	50	42	—	2 5/16	1.1	13.70
FB-4802	50	48	—	2 5/16	1.3	10.90

CAT. NO.	PCS/CTN	W	D	H	WT.	PRICE
FB-3004	50	30	—	3 5/16	1.1	\$11.90
FB-3604	50	36	—	3 5/16	1.6	11.90
FB-4204	50	42	—	3 5/16	1.8	16.50
FB-4804	50	48	—	3 5/16	2.0	18.30



Acts as a kickplate and provides a flush, finished appearance.

CAT. NO.	PCS/CTN	W	D	H	WT.	PRICE
LTAT-36	10	36	—	2 3/4	3.0	\$41.00
LTAT-42	10	42	—	2 3/4	3.4	44.00
LTAT-48	10	48	—	2 3/4	3.9	47.00

Use to tie units together across aisle for extra stabilization in tall units. Other lengths available upon request; consult factory for pricing.



AISLE TIES

CAT. NO.	W	D	H	WT.	PRICE
BSN6	4 5/8	1 3/4	6	.6	\$11.50
BSN9	4 5/8	1 3/4	9	1.1	14.00

Non-skid base included; packed as ordered.



BOOK SUPPORTS

CAT. NO.	DESCRIPTION	PRICE
LTCP-1	Ties posts back-to-back	\$3.30
LTPF-1	For protection of carpeting	1.20
LTSP-1	Shim to help adjust for uneven floor	4.00
LTWT-1	Attaches post to wall for added security	3.40
LTUC-1	Ties posts back-to-back	2.10
LTSP-1	Prevents shelf support from slipping	0.77
LTSI-36	Provides extra stability for seismic standards	15.30
LTUP-1	To touch up scrapes and scratches	19.80
LTSP-1	Splice for extending existing posts	4.80
SCH-P	Holds 3x5" cards for shelf labeling	6.00

Color options only available on select products.



LTCP-1



LTPF-1



LTSP-1



LTWT-1



LTUC-1



LTSP-1



LTSI-36



LTUP-1



LTSP-1



SCH-P

MISCELLANEOUS L&T PARTS

CAT. NO.	DESCRIPTION	SIZE	PRICE
SMALL LEVELER (FOR USE ON CONCRETE/TILE FLOOR)			
LPLI-S	Fits "L" Uprights	1/4"-20 x 9/16"	\$2.80
TPLI-S	Fits "T" Uprights	1/4"-20 x 9/16"	2.10
LARGE LEVELER (FOR USE ON CARPET)			
LPLI-L	Fits "L" Uprights	1/4"-20 x 1 3/8"	\$4.80
TPLI-L	Fits "T" Uprights	1/4"-20 x 1 3/8"	2.60



For carpeting



For hard floors

LEVELING FEET

Color options not available

Standard Colors (Unless Otherwise Specified)

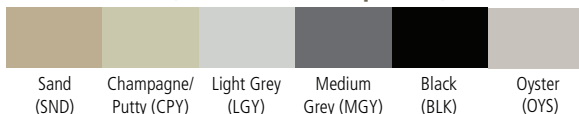

Flared & Adjustable Leg Workbenches

FLARED LEG WORKBENCHES



Steel Top with Flared Legs



Plastic Top with Flared Legs



Hardwood Top with Flared Legs



Compressed Top with Flared Legs

National Motor Freight Class: 70

CAT. NO.	LOAD CAP.	W	D	H	WT.	PRICE
Steel Top						
WB-1-3048S♣	4,000	48	30	33 1/2	91	\$550.00
WB-1-3060S♣	2,500	60	30	33 1/2	103	589.00
WB-1-3072S♣	1,800	72	30	33 1/2	120	645.00
WB-1-3096S*♣	4,000	96	30	33 1/2	173	896.00
WB-1-3660S♣	2,500	60	36	33 1/2	122	666.00
WB-1-3672S♣	1,800	72	36	33 1/2	134	725.00
WB-1-3696S*♣	4,000	96	36	33 1/2	192	984.00
Plastic Top						
WB-1-3048P♣	1,200	48	30	33 1/2	126	\$754.00
WB-1-3060P♣	800	60	30	33 1/2	123	785.00
WB-1-3072P♣	750	72	30	33 1/2	139	893.00
WB-1-3096P*♣	1,200	96	30	33 1/2	190	1,258.00
WB-1-3660P♣	800	60	36	33 1/2	150	996.00
WB-1-3672P♣	750	72	36	33 1/2	182	1,037.00
WB-1-3696P*♣	1,200	96	36	33 1/2	225	1,426.00
Hardwood Top						
WB-1-3048W♣	4,000	48	30	33 3/4	96	\$957.00
WB-1-3060W♣	3,800	60	30	33 3/4	124	1,070.00
WB-1-3072W♣	3,600	72	30	33 3/4	142	1,237.00
WB-1-3096W*♣	4,000	96	30	33 3/4	184	1,708.00
WB-1-3660W♣	3,800	60	36	33 3/4	137	1,240.00
WB-1-3672W♣	3,600	72	36	33 3/4	162	1,423.00
WB-1-3696W*♣	4,000	96	36	33 3/4	217	2,438.00
Compressed Wood Top						
WB-1-3048C♣	2,400	48	30	33 3/4	124	\$746.00
WB-1-3060C♣	1,900	60	30	33 3/4	152	816.00
WB-1-3072C♣	1,500	72	30	33 3/4	175	919.00
WB-1-3096C*♣	2,400	96	30	33 3/4	233	1,454.00
WB-1-3660C♣	1,900	60	36	33 3/4	169	945.00
WB-1-3672C♣	1,500	72	36	33 3/4	206	1,071.00
WB-1-3696C*♣	2,400	96	36	33 3/4	270	1,500.00

*96" w workbenches have 3 sets of legs.

- Assembly required.

ADJUSTABLE LEG WORKBENCHES



Steel Top with Adjustable Legs



Plastic Top with Adjustable Legs



Hardwood Top with Adjustable Legs



Compressed Top with Adjustable Legs

National Motor Freight Class: 70

CAT. NO.	LOAD CAP.	W	D	H	WT.	PRICE
Steel Top						
WBA-1-3048S♣	4,000	48	30	29 3/8-36 7/8	98	\$564.00
WBA-1-3060S♣	2,500	60	30	29 3/8-36 7/8	110	603.00
WBA-1-3072S♣	1,800	72	30	29 3/8-36 7/8	127	659.00
WBA-1-3096S*♣	4,000	96	30	29 3/8-36 7/8	182	917.00
WBA-1-3660S♣	2,500	60	36	29 3/8-36 7/8	129	684.00
WBA-1-3672S♣	1,800	72	36	29 3/8-36 7/8	141	743.00
WBA-1-3696S*♣	4,000	96	36	29 3/8-36 7/8	202	1,011.00
Plastic Top						
WBA-1-3048P♣	1,200	48	30	29 3/8-36 7/8	115	\$768.00
WBA-1-3060P♣	800	60	30	29 3/8-36 7/8	130	799.00
WBA-1-3072P♣	750	72	30	29 3/8-36 7/8	145	907.00
WBA-1-3096P*♣	1,200	96	30	29 3/8-36 7/8	200	1,279.00
WBA-1-3660P♣	800	60	36	29 3/8-36 7/8	157	1,014.00
WBA-1-3672P♣	750	72	36	29 3/8-36 7/8	188	1,055.00
WBA-1-3696P*♣	1,200	96	36	29 3/8-36 7/8	235	1,453.00
Hardwood Top						
WBA-1-3048W♣	4,000	48	30	29 5/8-37 1/8	103	\$971.00
WBA-1-3060W♣	3,800	60	30	29 5/8-37 1/8	131	1,084.00
WBA-1-3072W♣	3,600	72	30	29 5/8-37 1/8	148	1,251.00
WBA-1-3096W*♣	4,000	96	30	29 5/8-37 1/8	194	1,729.00
WBA-1-3660W♣	3,800	60	36	29 5/8-37 1/8	144	1,258.00
WBA-1-3672W♣	3,600	72	36	29 5/8-37 1/8	168	1,441.00
WBA-1-3696W*♣	4,000	96	36	29 5/8-37 1/8	227	2,465.00
Compressed Wood Top						
WBA-1-3048C♣	2,400	48	30	29 5/8-37 1/8	131	\$760.00
WBA-1-3060C♣	1,900	60	30	29 5/8-37 1/8	159	830.00
WBA-1-3072C♣	1,500	72	30	29 5/8-37 1/8	181	933.00
WBA-1-3096C*♣	2,400	96	30	29 5/8-37 1/8	238	1,475.00
WBA-1-3660C♣	1,900	60	36	29 5/8-37 1/8	176	963.00
WBA-1-3672C♣	1,500	72	36	29 5/8-37 1/8	212	1,089.00
WBA-1-3696C*♣	2,400	96	36	29 5/8-37 1/8	280	1,527.00

*96" w workbenches have 3 sets of legs.

- Assembly required.

Standard Colors



Items with this symbol are available to ship in 2-3 days. Limited quantities and select colors.



(MGY)

Electronic Workbenches

ELECTRONIC WORKBENCHES



EB-1-3072S
Solid Steel Top
Electronic Workbench



EB-2-3072M
Hard Wood Top
Electronic Workbench
With Electronic Riser

- Assembly required.

CAT. NO.	TOP MATERIAL	W	D	H	LOAD CAP.*	WT.	PRICE
Electronic Workbench with Stringer and Outlet Panel							
EB-1-3072S♣	Solid Steel	72	30	33 1/2	1,800	156	\$926.00
EB-1-3072M♣	Hard Wood	72	30	33 3/4	2,000	178	1,518.00
EB-1-3672M♣	Hard Wood	72	36	33 3/4	2,000	195	1,694.00
EB-1-3072P♣	Plastic Laminate	72	30	33 1/2	750	175	1,174.00
EB-1-3672P♣	Plastic Laminate	72	36	33 1/2	750	215	1,308.00
EB-1-3072C♣	Compressed Wood	72	30	33 3/4	1,500	211	1,200.00
EB-1-3672C♣	Compressed Wood	72	36	33 3/4	1,500	239	1,342.00
Electronic Workbench with Stringer, Outlet Panel and Electronic Riser							
EB-2-3072S♣	Solid Steel	72	30	33 1/2	1,800	187	\$1,121.00
EB-2-3072M♣	Hard Wood	72	30	33 3/4	2,000	209	1,713.00
EB-2-3672M♣	Hard Wood	72	36	33 3/4	2,000	226	1,889.00
EB-2-3072P♣	Plastic Laminate	72	30	33 1/2	750	206	1,369.00
EB-2-3672P♣	Plastic Laminate	72	36	33 1/2	750	246	1,503.00
EB-2-3072C♣	Compressed Wood	72	30	33 3/4	1,500	242	1,395.00
EB-2-3672C♣	Compressed Wood	72	36	33 3/4	1,500	270	1,537.00

*Load capacity is for top only. This is not the represented load capacity for riser.
Includes top, panel legs and electronic outlet panel. Electronic wiring kit is not included with outlet panel.
Wiring kit (WK-1) must be ordered separately, found on page 73.

National Motor Freight Class: 70

ELECTRONIC MODULAR WORKBENCHES



EMB-1-3072S
Solid Steel Top
Electronic Modular
Workbench



EMB-2-3072M
Hard Wood Top
Electronic Modular
Workbench

- Assembly required.

CAT. NO.	TOP MATERIAL	W	D	H	LOAD CAP.	WT.	PRICE
EMB-1-3072S*♣	Solid Steel w/ 2 Drawer Units	72	30	33 1/2	1,800	248	\$2,264.00
EMB-1-3072M*♣	Hard Wood w/ 2 Drawer Units	72	30	33 3/4	2,000	267	2,836.00
EMB-1-3072P*♣	Plastic Laminate w/ 2 Drawer Units	72	30	33 1/2	750	264	2,492.00
EMB-1-3072C*♣	Compressed Wood w/ 2 Drawer Units	72	30	33 3/4	1,500	300	2,519.00
EMB-2-3072S**♣	Solid Steel w/ 1 Drawer & Cabinet	72	30	33 1/2	1,800	219	1,859.00
EMB-2-3072M**♣	Hard Wood w/ 1 Drawer & Cabinet	72	30	33 3/4	2,000	238	2,432.00
EMB-2-3072P**♣	Plastic Laminate w/ 1 Drawer & Cabinet	72	30	33 1/2	750	235	2,087.00
EMB-2-3072C**♣	Compressed Wood w/ 1 Drawer & Cabinet	72	30	33 3/4	1,500	271	2,114.00

Load capacity is for top only.

* Includes top, two modular drawer units and electric outlet panel. Electric wiring kit is not included with outlet panel.

** Includes top, one modular drawer unit, one modular cabinet unit and electric outlet panel. Electric wiring kit is not included with outlet panel.
Wiring kit (WK-1) must be ordered separately, found on page 73.

National Motor Freight Class: 70

Standard Colors

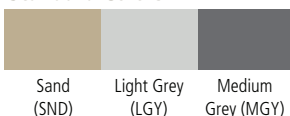

♣ Items with these symbols are available to ship in 2-3 days. Limited quantities and select colors.



Workbench Tops

STEEL TOPS



*96" w tops require three legs.
Durable 12 gauge steel work surface reinforced with 14 gauge mounting brackets. Includes two mounting brackets (enough to mount one workbench drawer or two modular cabinets).

Stringer required for workbenches with legs & no pedestals.

National Motor Freight Class: 70

CAT. NO.	LOAD CAP.	W	D	H	WT.	PRICE
With Stringer						
T-3048 ♣	4,000	48	30	1 1/2	62	\$370.00
T-3060 ♣	2,500	60	30	1 1/2	74	409.00
T-3072 ♣	1,800	72	30	1 1/2	91	465.00
T-3096* ♣	4,000	96	30	1 1/2	129	626.00
T-3648 ♣	4,000	48	36	1 1/2	71	402.00
T-3660 ♣	2,500	60	36	1 1/2	90	476.00
T-3672 ♣	1,800	72	36	1 1/2	107	535.00
T-3696* ♣	4,000	96	36	1 1/2	144	699.00
Without Stringer						
G-T-3048	4,000	48	30	1 1/2	57	\$350.00
G-T-3060 ♣	2,500	60	30	1 1/2	69	379.00
G-T-3072 ♣	1,800	72	30	1 1/2	84	435.00
G-T-3096*	4,000	96	30	1 1/2	116	585.00
G-T-3648	4,000	48	36	1 1/2	66	379.00
G-T-3660	2,500	60	36	1 1/2	83	448.00
G-T-3672	1,800	72	36	1 1/2	97	500.00
G-T-3696* ♣	4,000	96	36	1 1/2	131	669.00

STEEL TOPS WITH HARD BOARD



1/8" hardboard helps to deaden sound of items placed or used on work surface and protects durable 12 gauge steel work surface from scratches. Reinforced with 14 gauge mounting brackets. Includes two mounting brackets (enough to mount one workbench drawer or two modular cabinets).

Stringer required for workbenches with legs & no pedestals.

National Motor Freight Class: 70

CAT. NO.	LOAD CAP.	W	D	H	WT.	PRICE
With Stringer						
THB-3060	2,500	60	30	1 1/2	78	\$549.00
THB-3072	1,800	72	30	1 1/2	99	622.00
THB-3672	1,800	72	36	1 1/2	119	659.00
Without Stringer						
G-THB-3060	2,500	60	30	1 1/2	72	\$505.00
G-THB-3072	1,800	72	30	1 1/2	92	616.00
G-THB-3672	1,800	72	36	1 1/2	109	694.00

HARDWOOD TOPS



*96" w tops require three legs.
Features assorted hardwoods in a butcher-block construction to resist warp.

Stringer required for workbenches with legs & no pedestals.

Available in Natural only.

National Motor Freight Class: 70

CAT. NO.	LOAD CAP.	W	D	H	WT.	PRICE
With Stringer						
MT-3060 □	3,800	60	30	1 3/4	95	\$890.00
MT-3072 □	3,600	72	30	1 3/4	113	1,057.00
MT-3096*	4,000	96	30	1 3/4	141	1,438.00
MT-3660 □	3,800	60	36	1 3/4	105	1,050.00
MT-3672 □	3,600	72	36	1 3/4	130	1,233.00
MT-3696*	4,000	96	36	1 3/4	169	2,153.00
Without Stringer						
G-MT-3060 □	3,800	60	30	1 3/4	87	\$848.00
G-MT-3072 □	3,600	72	30	1 3/4	103	1,008.00
G-MT-3096*	4,000	96	30	1 3/4	128	1,361.00
G-MT-3660 □	3,800	60	36	1 3/4	97	1,008.00
G-MT-3672 □	3,600	72	36	1 3/4	120	1,184.00
G-MT-3696*	4,000	96	36	1 3/4	156	2,076.00

Standard Colors (Unless Otherwise Specified)



♣ □
Items with these symbols are available to ship in 2-3 days. Limited quantities and select colors.

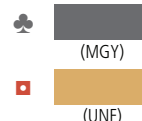

SHOP EQUIPMENT

Workbench Tops

PLASTIC LAMINATE TOPS

CAT. NO.	LOAD CAP.	W	D	H	WT.	PRICE
With Stringer						
PT-3060 ◀	800	60	30	1 1/2	94	\$605.00
PT-3072 ◀	750	72	30	1 1/2	110	713.00
PT-3096*	1,200	96	30	1 1/2	147	988.00
PT-3660 ◀	800	60	36	1 1/2	118	806.00
PT-3672 ◀	750	72	36	1 1/2	150	847.00
PT-3696*	1,200	96	36	1 1/2	177	1,141.00
Without Stringer						
G-PT-3060 ◀	800	60	30	1 1/2	83	\$563.00
G-PT-3072 ◀	750	72	30	1 1/2	100	664.00
G-PT-3096*	1,200	96	30	1 1/2	134	911.00
G-PT-3660 ◀	800	60	36	1 1/2	110	764.00
G-PT-3672 ◀	750	72	36	1 1/2	140	798.00
G-PT-3696*	1,200	96	36	1 1/2	164	1,064.00

Available in White only.



*96" w tops require three legs.
High pressure laminate top & edges; particleboard core.
Non-conductive surface is ideal for electronics.

Stringer required for workbenches with legs & no pedestals.

National Motor Freight Class: 70

COMPRESSED WOOD TOPS

CAT. NO.	LOAD CAP.	W	D	H	WT.	PRICE
With Stringer						
CT-3060 ◻	1,900	60	30	1 3/4	123	\$636.00
CT-3072 ◻	1,500	72	30	1 3/4	146	739.00
CT-3096*	2,400	96	30	1 3/4	185	1,184.00
CT-3660 ◻	1,900	60	36	1 3/4	137	755.00
CT-3672 ◻	1,500	72	36	1 3/4	174	881.00
CT-3696*	2,400	96	36	1 3/4	222	1,215.00
Without Stringer						
G-CT-3060 ◻	1,900	60	30	1 3/4	115	\$594.00
G-CT-3072 ◻	1,500	72	30	1 3/4	136	690.00
G-CT-3096*	2,400	96	30	1 3/4	172	1,107.00
G-CT-3660 ◻	1,900	60	36	1 3/4	129	713.00
G-CT-3672 ◻	1,500	72	36	1 3/4	164	832.00
G-CT-3696*	2,400	96	36	1 3/4	209	1,138.00

Available in Natural only.

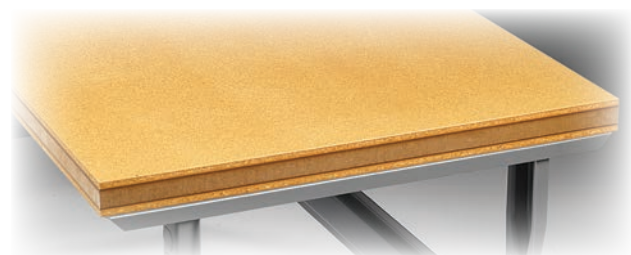

*96" w tops require three legs.
Tempered hardboard top and bottom surface laminated to compressed wood core. Banded on all sides with hard maple.

Stringer required for workbenches with legs & no pedestals.

National Motor Freight Class: 70

STRINGERS

CAT. NO.	W	D	H	WT.	PRICE
WBS-48 ♣	48	—	5	6.4	\$38.00
WBS-60 ♣	60	—	5	8.1	42.00
WBS-72 ♣	72	—	5	9.7	49.00
WBS-96 ♣	96	—	5	13.2	77.00

Ties workbench legs together for added stability.

Stiffening beads provide added strength.



National Motor Freight Class: 70

MOUNTING CHANNELS

CAT. NO.	W	D	H	WT.	PRICE
WBMC-30 ♣	1 3/16	30	1 5/16	4.2	\$43.00
WBMC-36 ♣	1 3/16	36	1 5/16	5.0	52.00

Mounts stackable drawer or modular cabinets on steel tops. Two mounting channels are included with steel top; order additional channels for unique configurations only.

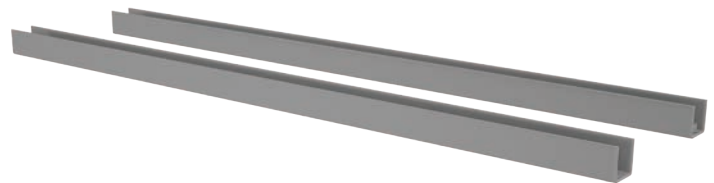

National Motor Freight Class: 70

MOUNTING ANGLES

CAT. NO.	W	D	H	WT.	PRICE
WBLB-30	1 7/8	22	1 1/16	3.4	\$24.00

Mounts stackable drawer on electronic workbench. One set required per hanging item.

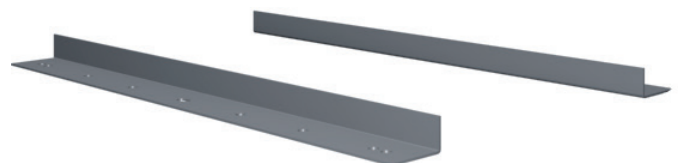

National Motor Freight Class: 70

Standard Colors (Unless Otherwise Specified)



Items with these symbols are available to ship in 2-3 days. Limited quantities and select colors.



FLARED LEGS



Priced per leg.
Complete with two easily removable plastic outlet inserts. Feet prepunched for floor anchoring.

24" deep legs available in quantity; consult factory for pricing.

National Motor Freight Class: 70

CAT. NO.	LOAD CAP.*	W	D	H	WT.	PRICE
L-2830	5,000	3 1/2	30	28	14.5	\$105.00
L-2836	5,000	3 1/2	36	28	15.5	108.00
L-3230♣	5,000	3 1/2	30	32	14.5	90.00
L-3236♣	5,000	3 1/2	36	32	16.0	95.00

*Load Capacity represents total per pair.

ADJUSTABLE LEGS



Priced per leg.

Complete with two easily removable plastic outlet inserts. Feet prepunched for floor anchoring.

National Motor Freight Class: 70

CAT. NO.	LOAD CAP.*	W	D	H**	WT.	PRICE
AL-3230♣	4,000	3	30	27 7/8-35 3/8	17.8	\$97.00
AL-3236♣	4,000	3	36	27 7/8-35 3/8	19.3	104.00
AL-4230♣	3,000	3	30	35 3/8-41 3/8	18.8	118.00
AL-4236♣	3,000	3	36	35 3/8-41 3/8	20.3	125.00

*Load Capacity represents total per pair.

**Adjustable on 1 1/2" centers.

PANEL LEGS



Priced per pair.
Prepunched holes for easy attachment.

National Motor Freight Class: 70

CAT. NO.	LOAD CAP.*	W	D	H	WT.	PRICE
LP-3230♣	2,000	3	28	32	48.0	\$287.00

*Load Capacity represents total per pair.

CASTER KITS



Swivel

Fixed

Casters attach to 30" or 36" deep flared or adjustable legs to provide mobility for your workbench. Kit includes mounting brackets and four casters, swivel and fixed. The swivel casters are lockable.

National Motor Freight Class: 70

CAT. NO.	LOAD CAP.	DESCRIPTION	WT.	PRICE
For 48"W - 72"W Workbenches				
WBCK-3036♣	1,000	Two fixed, Two swivel	16	\$141.00
WBCK-3036S	1,000	Four swivel	16	147.00
For 96"W Workbenches				
WBCK-3036-3	1,000	Two fixed, Four swivel	24	\$211.00

NOTE: Lower shelf or two stringers required for stability when using caster kits.

LOWER SHELVES

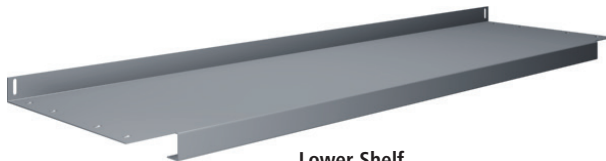

Lower Shelf

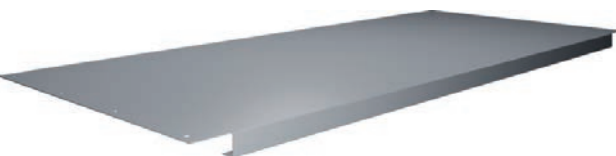

Full Depth Lower Shelf

National Motor Freight Class: 70

CAT. NO.	LOAD CAP.*	W	D	WT.	PRICE
Shelf For Flared Leg or Adjustable Leg Workbenches					
S-48♣	450	48	14	15.5	\$87.00
S-60♣	450	60	14	19.5	102.00
S-72♣	350	72	14	23.0	125.00
S-96♣	850	96	14	31.0	164.00
Full Depth Shelf For Flared Leg Workbenches					
FS-48	450	48	20	21.0	\$157.00
FS-60	450	60	20	25.0	174.00
FS-72	350	72	20	30.0	196.00
FS-96**	850	96	20	42.0	305.00
Full Depth Shelf For 30"D Adjustable Leg Workbenches					
FS-3060	450	60	20 1/2	36.0	\$143.00
FS-3072	450	72	20 1/2	41.0	165.00
Full Depth Shelf For 36"D Adjustable Leg Workbenches					
FS-3648	450	48	26 1/2	37.0	\$169.00
FS-3660	450	60	26 1/2	39.0	165.00
FS-3672	350	72	26 1/2	46.0	195.00
FS-3696**	850	96	26 1/2	60.0	252.00

*All loads must be evenly distributed.

**96" w are two pieces.

Standard Colors



Sand (SND) Light Grey (LGY) Medium Grey (MGY)



Items with this symbol are available to ship in 2-3 days. Limited quantities and select colors.



(MGY)

Workbench Accessories

NOTE: Load capacities for Modular Storage Cabinets and Modular Drawer Cabinets represent units when being used to support a workbench with weight evenly distributed on top. Drawer load capacity is 70 lbs. **Modular Pedestal Cabinets are designed to work with 30" deep workbench tops only.**

MODULAR CABINETS

CAT. NO.	LOAD CAP.	W	D	H	WT.	PRICE
Modular Cabinets						
MS-1524♣	1,000	15	24	32	48	\$462.00
MD-1524♣	1,000	15	24	32	77	\$867.00
MD2-1524	1,000	15	24	32	68	\$911.00
MD3-1524♣	1,000	15	24	32	69	\$895.00
Caster Kit For Modular Cabinets						
CB-1524	1,000	15	24	3 1/4	18	\$192.00
Extra Drawer Divider (Galvanized Only)						
WBDD-12♣		12 3/8	—	4 1/4	0.6	\$3.80
Optional Extra Shelf for MS-1524						
MBS-1524	100	15	23	3/4	5	\$63.00

Storage Cabinet comes standard with locking recessed handle. One adjustable shelf included. Drawer unit comes standard with keylock which locks all drawers simultaneously. Includes one divider per drawer. The MD-1524 & MD3-1524 come with one plastic pencil tray placed in the top drawer. Order tops without stringers with the modular units.



National Motor Freight Class: Cabinets, 100; Caster Kits, 70

CAT. NO.	LOAD CAP.	W	D	H	WT.	PRICE
WBHC-1516	70	15	18	16	20	\$280.00

National Motor Freight Class: 100

Cabinet comes standard with locking recessed handle. Can also be mounted under or above stackable drawer.

HANGING CABINET

Bolt-in center shelf can be flipped so cabinet door can open in either direction.

When mounting to steel top, use one set of Mounting Channels (included with top); when mounting to electronic workbench, use one set of Mounting Angles. Mounts to wood tops directly.



CAT. NO.	LOAD CAP.	W	D	H	WT.	PRICE
Stackable Drawer						
WBD-1	70	15	18	8 1/4	18	\$186.00
WBD-1-MGY*♣	70	15	18	8 1/4	21	\$147.00
Cam Lock (Field Installable)						
CL-1☐		—	—	—	0.1	\$9.40
Extra Divider (Galvanized Only)						
WBDD-12☐		12 3/8	—	4 1/4	0.6	\$3.80

*Medium Grey Only.
WBD-1 available only in select colors.

Includes one drawer divider, one removable pencil tray, and installed cam lock with key.

When mounting to steel top, use one set of Mounting Channels (included with top); when mounting to electronic workbench, use one set of Mounting Angles. Mounts to wood tops directly.

STACKABLE DRAWERS



National Motor Freight Class: 70

CAT. NO.	LOAD CAP.	W	D	H	WT.	PRICE
WBD-25*♣	70	25	22	6	17	\$241.00

Includes left and right mounting channels, rear brace and drawer. Drawer includes cam lock.

*Medium Grey Only.

25" WIDE HANGING DRAWER

When mounting to steel top, use one set of Mounting Channels (included with top); when mounting to electronic workbench, use one set of Mounting Angles (WBLB-30). Mounts to wood tops directly.



National Motor Freight Class: 70

CAT. NO.	LOAD CAP.	W	D	H	WT.	PRICE
SM-42	250	42	14	1 1/2	14.4	\$90.00

16 gauge steel shelf.

National Motor Freight Class: 70

MODULAR BENCH LOWER SHELF

For use with workbenches with modular units with 72"W tops.

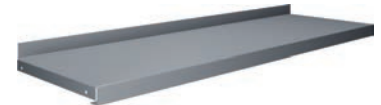

CAT. NO.	W	D	H	WT.	PRICE
SB-3048♣	48	30	3	12.2	\$78.00
SB-3060♣	60	30	3	14.0	\$81.00
SB-3072♣	72	30	3	15.7	\$90.00
SB-3096♣	96	30	3	18.9	\$118.00
SB-3648	48	36	3	13.9	\$85.00
SB-3660	60	36	3	15.2	\$88.00
SB-3672♣	72	36	3	17.0	\$95.00
SB-3696♣	96	36	3	19.9	\$122.00

SIDE & BACK RAIL KITS



Adds 3" to overall workbench height.

National Motor Freight Class: 70

Standard Colors (Unless Otherwise Specified)



♣ ☐
Items with these symbols are available to ship in 2-3 days. Limited quantities and select colors.



(MGY)



(Galvanized)

WORKBENCH RISER WITH END SUPPORTS



Risers have a 1 1/2" tall backstop. Riser will add 12" overall height to the workbench. May be double stacked.

National Motor Freight Class: 70

CAT. NO.	LOAD CAP.	W	D	H	WT.	PRICE
R-1048♣	600	48	10 1/2	12	18.5	\$139.00
R-1060♣	450	60	10 1/2	12	21	133.00
R-1072♣	350	72	10 1/2	12	24	147.00
R-1096*♣	1,000	96	10 1/2	12	32	230.00
R-106018♣	450	60	10 1/2	18	24	168.00
R-107218♣	350	72	10 1/2	18	27	183.00

*96" w risers use a center upright.

ELECTRIC RISER WITH END SUPPORTS



Risers have a 1 1/2" tall backstop. Riser will add 12" or 18" overall height to the workbench.

Includes knockouts for four duplex receptacle outlets. Optional wiring kit may be ordered on page 73 or prewired below. May be double stacked.

National Motor Freight Class: 70

CAT. NO.	LOAD CAP.	W	D	H	WT.	PRICE
RE-1060♣	450	60	10 1/2	12	27	\$183.00
RE-1072♣	350	72	10 1/2	12	31	195.00
RE-1560	450	60	15	12	35	234.00
RE-1572	350	72	15	12	39	252.00
RE-18-1560♣	450	60	15	18	38	244.00
RE-18-1572♣	350	72	15	18	43	258.00
RE-18-1596♣	300	96	15	18	53	323.00

PREWIRED ELECTRIC RISER WITH END SUPPORTS



Risers have a 1 1/2" tall backstop. Riser will add 12" or 18" overall height to the workbench. May be double stacked.

National Motor Freight Class: 70

CAT. NO.	LOAD CAP.	W	D	H	WT.	PRICE
REI-1060-WK-1	450	60	10 1/2	12	30	\$482.00
REI-1072-WK-1	350	72	10 1/2	12	34	498.00
REI-1560-WK-1	450	60	15	12	35	521.00
REI-1572-WK-1	350	72	15	12	53	584.00
REI-18-1560-WK-1♣	450	60	15	18	54	540.00
REI-18-1572-WK-1♣	350	72	15	18	60	564.00
REI-18-1596-WK-1	300	96	15	18	72	640.00

DOUBLE DECKER CENTER RISER WITH END SUPPORTS

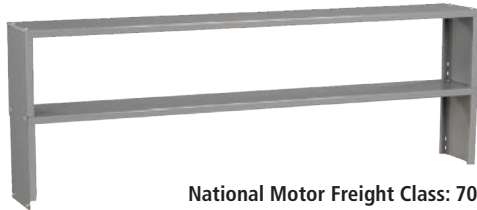

National Motor Freight Class: 70

CAT. NO.	LOAD CAP.	W	D	H	WT.	PRICE
R2-1060	450	60	10 1/2	24	42	\$277.00
R2-1072	350	72	10 1/2	24	48	301.00

Risers have no back flanges. Unit may be mounted in center of top for double entry.

ELECTRIC OUTLET PANEL FOR BENCHES WITH PANEL LEGS



National Motor Freight Class: 70

CAT. NO.	W	D	H	WT.	PRICE
WOP-72♣	71 5/8	3	4 3/8	17.4	\$174.00

Provides mounting plate for four duplex outlets on 72" panel leg workbenches. Optional wiring kit is available on page 73.

ELECTRIC OUTLET PANEL FOR BENCHES WITH TWO MODULAR UNITS



National Motor Freight Class: 70

CAT. NO.	W	D	H	WT.	PRICE
Without Wiring Kit					
WOP-42♣	42	3 3/8	4 3/8	10.3	\$95.00
Wiring Kit Installed					
WOPI-42-WK-1	42	3 3/8	4 3/8	12.8	\$361.00

Provides mounting plate for four duplex outlets on 72" panel leg workbenches. Optional wiring kit is available on page 73.

Standard Colors (Unless Otherwise Specified)



Items with this symbol are available to ship in 2-3 days. Limited quantities and select colors.



(MGY)

CAT. NO.	WT.	PRICE
WK-1	2.5	\$199.00

Prewired for quick installation. Comes complete with four duplex receptacles, on/off switch with pilot light, 8 foot grounded cord and plug, 15 amp, 115 volt service and circuit breaker. Use with electronic riser, outlet panels, or electronic workbench.

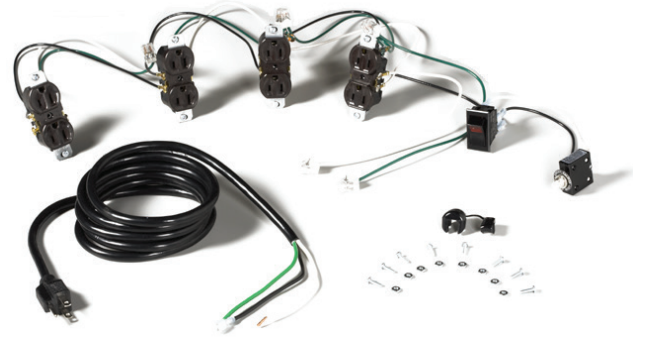

National Motor Freight Class: 70



**SR-57
OPEN STYLE**



**SR-58
CLOSED STYLE**



**SR-59
WALL MOUNTED**

FOREMAN'S DESKS

CAT. NO.	W	D	H	LOAD CAPACITY			WT.	PRICE
				TOP	DRAWER	SHELF		
SR-57	34 1/2	29	53	Open Style 250	70	200	97	\$885.00
SR-58	34 1/2	29	53	Closed Style 250	70	200	155	\$1,376.00
SR-59	34 1/2	29	17 1/2*	Wall Mounted 250	70	—	83	\$878.00

*Note: If including mounting bracket in height calculations, add 16 1/4" to height listed above. Combines a convenient, sturdy writing surface with compartmentalized riser for storing writing utensils, forms and papers. Drawer comes standard with lock and two keys. Shipped partially assembled.

Medium Grey only. National Motor Freight Class: 70

Standard Colors



Medium Grey (MGY)

Items with these symbols are available to ship in 2-3 days. Limited quantities and select colors.

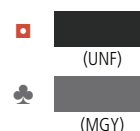

SHOP EQUIPMENT

CANTILEVERED ACCESSORY SYSTEM

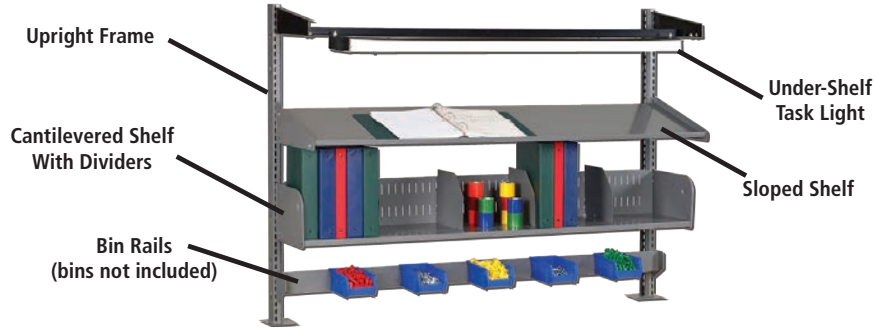

The Cantilevered Accessory System provides a variety of convenient storage options for your workstation. Start with upright frames, then add accessories such as shelves with dividers, sloped shelves, an overhead light, or a bin rail for adding third-party bins for small parts storage.

UPRIGHT FRAMES



Accessories attach to uprights without tools.

NOTE: Cantilever system requires 72" or wider top.

National Motor Freight Class: 70

CAT. NO.	DESCRIPTION	W	D	H	WT.	PRICE
WBRU-24A	Sold as a Pair	4	5 1/4	24	10.7	\$144.00
WBRU-42A	Sold as a Pair	4	5 1/4	42	15.7	\$150.00

Upright frames attach to the rear edge of the work surface to provide a substantial structure from which to support storage shelves, bin rails, sloped shelves and lighting. Attaches with four bolts per side (drilling required to attach). Both sizes of uprights may be attached directly to the Tensco steel or wood tops.

CANTILEVERED SHELF

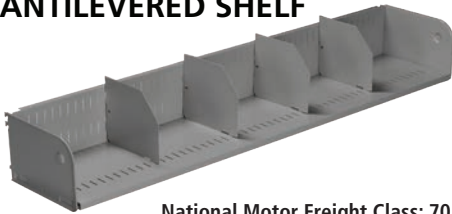

National Motor Freight Class: 70

CAT. NO.	W	D	H	WT.	PRICE
TWBS-6012A	60	12	7 1/2	21	\$151.00

May be quickly and easily repositioned. Four adjustable dividers are furnished with each shelf.

SLOPED SHELF

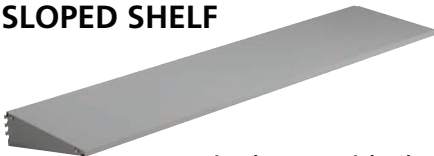

National Motor Freight Class: 70

CAT. NO.	W	D	H	WT.	PRICE
TWSS-6012A	60	12	3/4	19	\$90.00

May be quickly and easily repositioned. Includes a front lip to keep items from rolling off the shelf.

BIN RAIL

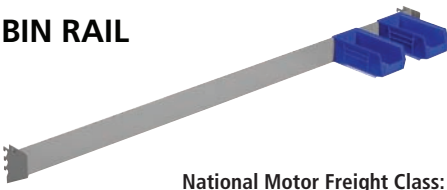

National Motor Freight Class: 70

CAT. NO.	W	D	H	WT.	PRICE
TWBR-60	60	3 7/8	4 3/16	7	\$164.00

Bin Rails accommodate a variety of commercially available plastic and steel parts bins. Easily adjustable up or down on the upright frame. Bins not included.

CANTILEVER TASK LIGHTING



National Motor Freight Class: 70

CAT. NO.	W	D	H	WT.	PRICE
TWCTL-48	Task Light			14	\$322.00
	50 5/32	8	1 25/32		
TWLB-60	60	13 1/2	3 1/2	8.2	\$78.00

The cantilever task light provides overhead lighting for your work area. Unit contains two 32-watt lamps and is prewired with an 8' power cord and power switch. Use bracket kit for mounting onto cantilever uprights. Mounting bracket allows light to adjust back and forth in 1 1/2" increments, or an angle if mounted on top. Available in black only.

Standard Colors (Unless Otherwise Specified)



SHOP EQUIPMENT

Mobile Workbenches & Service Carts

MOBILE WORKBENCHES



MB-1-2542



MB-2530-BB



MB-3-2545



MB-4-2545



MB-2-2542



MB-2530-C



MB-5-2545



MB-6-2545



MB-7-2545



REI-1045-WK-1



MHE-25

CAT. NO.	LOAD CAP.	W	D	H	WT.	PRICE
Mobile Workbenches						
*MB-1-2542♣	1,000	42	25	36 1/4	182	\$1,946.00
*MB-2-2542♣	1,000	42	25	36 1/4	157	1,588.00
**MB-2530-BB♣	1,000	33	25	40	234	2,036.00
**MB-2530-C♣	1,000	33	25	40	153	1,338.00
**MB-3-2545♣	1,000	48	25	40	294	2,843.00
**MB-4-2545♣	1,000	48	25	40	270	2,439.00
**MB-5-2545	1,000	48	25	40	220	2,286.00
**MB-6-2545	1,000	48	25	40	251	2,215.00
**MB-7-2545	1,000	48	25	40	278	2,523.00
Extra Shelf For Cabinet of MB-1-2542 or MB-2-2542						
MBS-2124	100	21	23	3/4	6.4	\$73.00
Extra Shelf For Left Side of MB-2-2542 or 15" Wide Single Door Cabinets						
MBS-1524	100	15	23	3/4	5.0	\$63.00
Prewired Electric Riser (Fits only 48" wide units)						
REI-1045-WK-1	—	45	8	10 1/4	23.0	\$386.00
Electric Riser (Fits only 48" wide units)						
RE-1045*	—	45	8	10 1/4	23.0	\$186.00
Push Handle Power Strip						
MHE-25	—	25	8	10 1/4	5.0	\$290.00

*Side and Back Rail adds 1 3/4" to overall workbench height.

**Side and Back Rail on the 3" to overall workbench height.

*Optional wiring kit (WK-1) may be ordered on page 73.

National Motor Freight Class: 100

CAT. NO.	LOAD CAP.	W	D	H	WT.	PRICE
16" Wide Service Cart						
SC-1630♣	150*	30	16	32	36	\$319.00
Optional Center Tray For 16" Wide Service Cart						
ST-16♣	150	30	16	3 1/4	11	\$91.00
24" Wide Service Cart						
SC-2436♣	150*	36	24	32	40	\$385.00
Optional Center Tray For 24" Wide Service Cart						
ST-24♣	150	36	24	3 1/4	15.8	\$120.00

*Load capacity is 150 lbs. per tray.

Two-shelf service cart with optional center tray. Trays have 3/8" lip and can be reversed to use as either a flat work surface or a storage compartment. Hard rubber casters (two swivel and two stationary). Shipped unassembled.

National Motor Freight Class: 70

Standard Colors (Unless Otherwise Specified)



♣ Items with these symbols are available to ship in 2-3 days. Limited quantities and select colors.



SERVICE CARTS

Available in Medium Grey only.



SHOP EQUIPMENT

PACKING TABLES

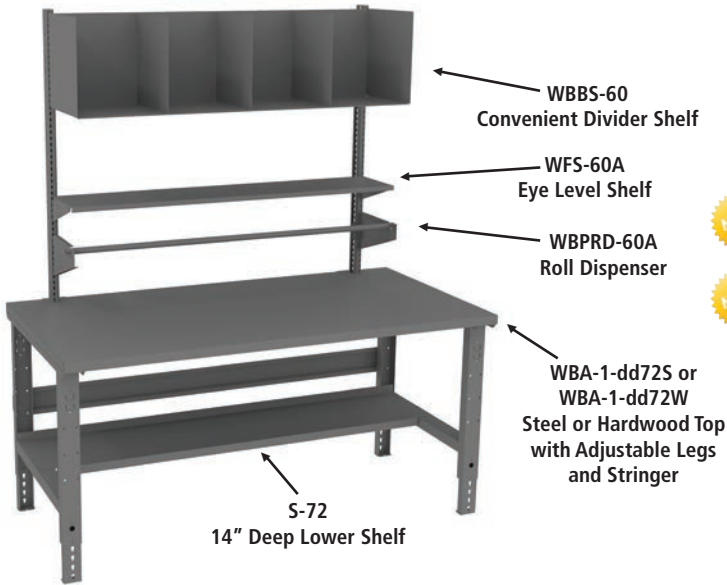

CAT. NO.	W	D	H	WT.	PRICE
Packing Table with Steel Top					
NEW APT-3072S	72	30	83 7/16	252	\$1,858.00
APT-3672S	72	36	83 7/16	271	1,936.00
Packing Table with Hardwood Top					
NEW APT-3072W	72	30	83 7/16	275	\$2,456.00
APT-3672W	72	36	83 7/16	295	2,634.00

Available in Medium Grey only.

- Assembly required.

National Motor Freight Class: 70

PACKING TABLE ACCESSORIES

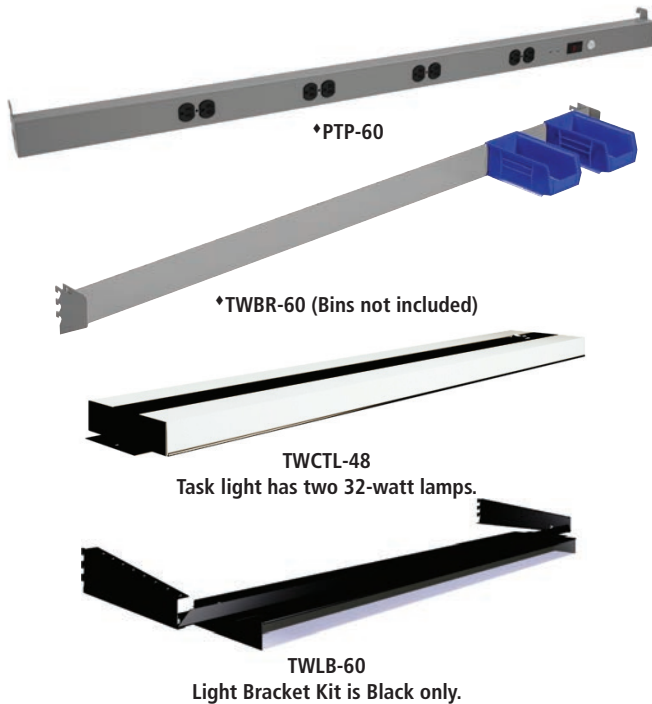

CAT. NO.	W	D	H	WT.	PRICE
Power Rail					
PTP-60*	57 3/32	2 1/2	1 3/4	12	\$454.00
Bin Rail					
TWBR-60*	57 7/32	3 7/8	4 3/16	7	\$164.00
Task Light					
TWCTL-48	50 5/32	8	1 25/32	14	\$322.00
Task Light Bracket Kit*					
TWLB-60	60	13 1/2	3 1/2	8.2	\$78.00

*Task Light Bracket Kit required for Task Light.

*Optional wiring kit (WK-1) may be ordered on page 73.

*Available in Medium Grey only.

National Motor Freight Class: 70

Standard Colors (Unless Otherwise Specified)







































SHOP EQUIPMENT





PRODUCT LINE OVERVIEW

STORAGE CABINETS										
	Deluxe	Standard	Jumbo	C-Thru	Specialty					
BOOKCASES										
	13 1/2" Deep	18" Deep	Cabinet/Bookcase Combo							
FILING										
	Card & Multimedia	Fixed Shelf Lateral File	Lateral File	Imperial Shelving	Fixed Shelf Filing	Lit. Sorter & 30 Drawers				
LOCKERS										
	Standard	Ventilated	C-Thru	Heavy-Duty	Cubby					
SHELVING										
	Bulk Rack	ESP	Q-Line	Stur-D-Stor	Regal	Z-Line	Record Archive	Capstone	L&T	Estey Library
SHOP EQUIPMENT										
	All Purpose Workbench	Electronic Workbench	Modular Workbench	Modular/Mobile Tool Cart	Foreman's Desk	Service Cart	Packing Table			



Customer Service: (866) 446-8686 • www.tennsco.com • customerservice@tennsco.com



PROUDLY MADE IN THE U.S.A.