



FIRE LADDERS

Aluminum & Fiberglass

"Use a Good Ladder or Stay on the Ground"

Toll Free: 877-386-5377 (DUOLDERS)

www.duosafety.com

Celebrating Over 80 Years

Duo-Safety Ladder Corporation is a privately owned company started in 1931, and incorporated in Wisconsin in 1933. The Corporation has been in the same family since its start and is now welcoming in the 3rd generation. We are the oldest and largest manufacturer of fire fighting ladders in North America. We sell and ship to all fifty states and Canada daily and deal with every fire truck manufacturer in North America. We are justly proud of our reputation and success of our company and we feel very strongly that these goals were achieved because of our employees and dealership network.

Over 80 years of experience in the manufacture of the highest quality Fire Service Ladders stands behind each DUO-SAFETY Ladder. DUO-SAFETY's leadership in the field has been won through quality and the long service life of its products.

All DUO-SAFETY Aluminum ladders feature **welded** and **expanded** rungs. This two step process makes certain the rung joints are as strong as the ladder beams, and no looseness should develop.

DUO-SAFETY Aluminum Fire ladders feature 6061-T6 aluminum alloy, 1-1/4" corrugated rungs and welded rung joints.

DUO-SAFETY extension and roof ladder models are all rated for 750 lb. load with a 4:1 safety factor.

All DUO-SAFETY Ladders meet/or exceed all applicable standards as established by the National Fire Protection Association for Fire Service Ground Ladders at time of manufacture.

We suggest all Fire Departments refer to and obtain a copy of both the National Fire Protection Association (N.F.P.A.) and the International Fire Service Training Association (I.F.S.T.A.) for complete and proper practices and usage of Fire Service ladders.

National Fire Protection Association (N.F.P.A.)

1 Batterymarch Park
Quincy, MA 02169
Phone: 1-800-344-3555
Fax: 1-617-770-0700
www.nfpa.org

International Fire Service Training Association (I.F.S.T.A.)

930 North Willis
Stillwater, OK 74078
Phone: 1-800-654-4055
Fax: 1-405-744-8204
www.ifsta.org

DUO-SAFETY LADDER CORPORATION 513 W 9th Avenue PO Box 497 Oshkosh WI 54903-0497

Toll Free: 877-386-5377 Fax: 920-231-2460 mail@duosafety.com www.duosafety.com



DUO-SAFETY LADDER CORPORATION

Why Buy Duo-Safety Ladders? Welded & Expanded Rungs!

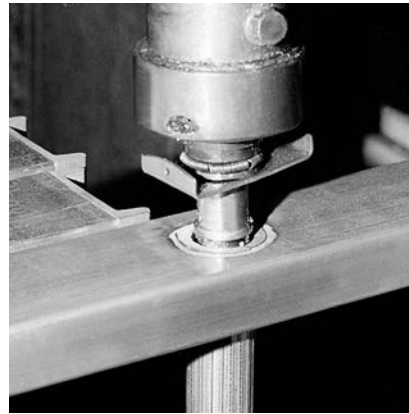

Welded 6061-T6 Aluminum has minimum yield of 8,000 PSI

Welding & Expanding makes the strongest rung to rail connection possible.

We feel rungs should never come loose. If your rungs get loose on any extension ladder, the fly section could fall out.

Do you have time to check all of your ladders before you use them??

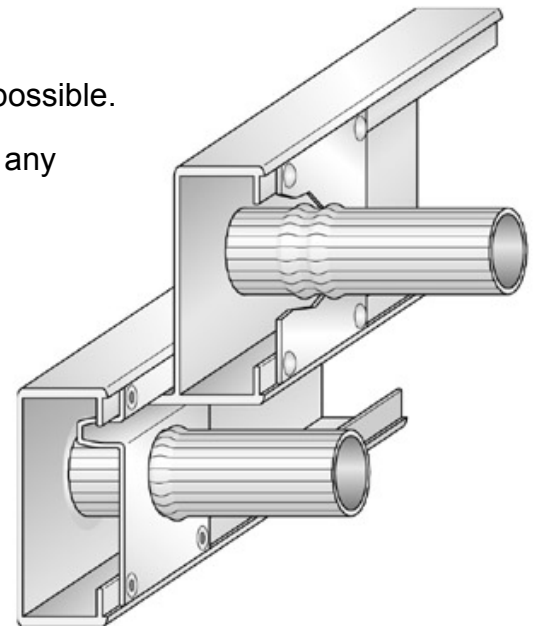

We feel it makes a lot of sense to use the strongest possible rung connection method to make the safest possible ladder. Thus, buy Duo-Safety Ladders with welded and expanded rungs.

DUO-SAFETY LADDER CORPORATION 513 W 9th Avenue PO Box 497 Oshkosh WI 54903-0497

Toll Free: 877-386-5377

Fax: 920-231-2460

mail@duosafety.com

www.duosafety.com



DUO-SAFETY LADDER CORPORATION



Solid Beam Aluminum Ladders

These incorporate Duo-Safety's exclusive tongue and groove arrangement. This outstanding construction design holds the sections firmly and rigidly, without brackets, hooks or obstructions of any kind. These compact ladders require a minimum of banking space - and have the extra advantage of being especially stable and rigid.

Series 1000-A

2 3/4" Channel Rail
750 lb Duty Rated

SPECIFICATIONS

SERIES 1000-A 2-SECTION

| Size | Closed Length | Width | Banking Thickness | Weight |
|------|---------------|-------|-------------------|--------|
| 10' | 7' 2.25" | 18.5" | 4.56" | 29 lbs |
| 12' | 8' 2.25" | 18.5" | 4.56" | 32 lbs |
| 14' | 9' 2.25" | 18.5" | 4.56" | 34 lbs |
| 16'* | 9' 11.5" | 18.5" | 4.56" | 40 lbs |

All dimensions listed are N.F.P.A. Design Verification Standards. Variations occur in each product of approximately +/- .125" due to the type of rivets, nuts, bolts etc. used. If you require precise dimensions, please call our office and request a copy of our current field dimension sheets.

Weight listed is actual weight of product only. For shipping purposes, please call our office for packaged weight before obtaining freight estimates.

Prong Feet as Standard
Rubber safety shoes optional for hard surface use

*Only the 16' length has a pulley and 3/8" manila rope installed
All other lengths are raised manually

DUO-SAFETY LADDER CORPORATION 513 W 9th Avenue PO Box 497 Oshkosh WI 54903-0497

Toll Free: 877-386-5377

Fax: 920-231-2460

mail@duosafety.com

www.duosafety.com



DUO-SAFETY LADDER CORPORATION

Solid Beam Aluminum Ladders

These incorporate Duo-Safety's exclusive tongue and groove arrangement. This outstanding construction design holds the sections firmly and rigidly, without brackets, hooks or obstructions of any kind. These compact ladders require a minimum of banking space - and have the extra advantage of being especially stable and rigid.

Series 900-A

Series 925-A

3 1/4" Channel Rail
750 lb Duty Rated

SPECIFICATIONS

SERIES 900-A 2-SECTION

| Size | Closed Length | Width | Banking Thickness | Weight |
|------|---------------|--------|-------------------|--------|
| 20' | 12' 2.75" | 21.75" | 5.375" | 60 lbs |
| 24' | 14' 2.75" | 21.75" | 5.375" | 72 lbs |

SERIES 925-A 3-SECTION

| Size | Closed Length | Width | Banking Thickness | Weight |
|------|---------------|-------|-------------------|--------|
| 22' | 10' 8.75" | 24" | 7.625" | 82 lbs |
| 26' | 11' 8.75" | 24" | 7.625" | 92 lbs |

All dimensions listed are N.F.P.A. Design Verification Standards. Variations occur in each product of approximately +/- .125" due to the type of rivets, nuts, bolts etc. used. If you require precise dimensions, please call our office and request a copy of our current field dimension sheets.

Weight listed is actual weight of product only. For shipping purposes, please call our office for packaged weight before obtaining freight estimates.



Model 900A



Model 925A

Prong Feet as Standard
Rubber safety shoes optional for hard surface use

DUO-SAFETY LADDER CORPORATION 513 W 9th Avenue PO Box 497 Oshkosh WI 54903-0497

Toll Free: 877-386-5377

Fax: 920-231-2460

mail@duosafety.com

www.duosafety.com



DUO-SAFETY LADDER CORPORATION

Solid Beam Aluminum Ladders

These incorporate Duo-Safety's exclusive tongue and groove arrangement. This outstanding construction design holds the sections firmly and rigidly, without brackets, hooks or obstructions of any kind. These compact ladders require a minimum of banking space - and have the extra advantage of being especially stable and rigid.

Series 1200-A

Series 1225-A

3 3/4" Channel Rail
750 lb Duty Rated

SPECIFICATIONS

SERIES 1200-A 2-SECTION

| Size | Closed Length | Width | Banking Thickness | Weight |
|------|---------------|-------|-------------------|---------|
| 28' | 16' 3.25" | 24" | 6.5" | 87 lbs |
| 30' | 18' 3.25" | 24" | 6.5" | 107 lbs |
| 35' | 20' 3.25" | 24" | 6.5" | 122 lbs |

SERIES 1225-A 3-SECTION

| Size | Closed Length | Width | Banking Thickness | Weight |
|------|---------------|-------|-------------------|---------|
| 28' | 12' 11" | 24" | 9.125" | 107 lbs |
| 30' | 13' 3" | 24" | 9.125" | 108 lbs |
| 35' | 15' 3" | 24" | 9.125" | 129 lbs |

All dimensions listed are N.F.P.A. Design Verification Standards. Variations occur in each product of approximately +/- .125" due to the type of rivets, nuts, bolts etc. used. If you require precise dimensions, please call our office and request a copy of our current field dimension sheets.

Weight listed is actual weight of product only. For shipping purposes, please call our office for packaged weight before obtaining freight estimates.

Prong Feet as Standard

Rubber safety shoes optional for hard surface use



Model 1225A



Model 1200A

DUO-SAFETY LADDER CORPORATION 513 W 9th Avenue PO Box 497 Oshkosh WI 54903-0497

Toll Free: 877-386-5377

Fax: 920-231-2460

mail@duosafety.com

www.duosafety.com



DUO-SAFETY LADDER CORPORATION

Solid Beam Aluminum Ladders



Originally produced for the Forestry Departments for use on their brush pumbers. This ladder was designed for a maximum closed length to fit in a restricted space. Due to the compact design, this ladder does not have a cable pulley to help extend the fly section. In order to extend the ladder, you must first extend the fly section by hand and use the rope and pulley to fully extend the ladder.

Series 912

3 1/4" Channel Rail
750 lb Duty Rated

SPECIFICATIONS

SERIES 912-86 3-SECTION

| Size | Closed Length | Width | Banking Thickness | Weight |
|------|---------------|-------|-------------------|--------|
| 16' | 86" | 24" | 8.125" | 65 lbs |

SERIES 912-100 3-SECTION

| Size | Closed Length | Width | Banking Thickness | Weight |
|------|---------------|-------|-------------------|--------|
| 20' | 100" | 24" | 8.125" | 80 lbs |

All dimensions listed are N.F.P.A. Design Verification Standards. Variations occur in each product of approximately +/- .125" due to the type of rivets, nuts, bolts etc. used. If you require precise dimensions, please call our office and request a copy of our current field dimension sheets.

Note: Due to compact size - you must manually extend fly/top section by hand and use the rope & pulley to fully extend the ladder.

Weight listed is actual weight of product only. For shipping purposes, please call our office for packaged weight before obtaining freight estimates.

Prong Feet as Standard
Rubber safety shoes optional for hard surface use

DUO-SAFETY LADDER CORPORATION 513 W 9th Avenue PO Box 497 Oshkosh WI 54903-0497

Toll Free: 877-386-5377

Fax: 920-231-2460

mail@duosafety.com

www.duosafety.com



DUO-SAFETY LADDER CORPORATION

Solid Beam Aluminum Ladders

These incorporate Duo-Safety's exclusive tongue and groove arrangement. This outstanding construction design holds the sections firmly and rigidly, without brackets, hooks or obstructions of any kind. These compact ladders require a minimum of banking space - and have the extra advantage of being especially stable and rigid.

Series 1500-A

Series 1525-A

5" Channel Rail
750 lb Duty Rated

SPECIFICATIONS

SERIES 1500-A 2-SECTION WITH POLES

| Size | Closed Length | Width over Poles | Banking Thickness | Weight |
|------|---------------|------------------|-------------------|---------|
| 40' | 23' 4" | *26.5" | 7.4" | 213 lbs |
| 45' | 26' 4" | 26.5" | 7.4" | 242 lbs |

SERIES 1525-A 3-SECTION WITH POLES

| Size | Closed Length | Width over Poles | Banking Thickness | Weight |
|------|---------------|------------------|-------------------|---------|
| 40' | 16' 10" | *26.5" | 9.8" | 215 lbs |
| 45' | 19' | 26.5" | 9.8" | 240 lbs |

All dimensions listed are N.F.P.A. Design Verification Standards. Variations occur in each product of approximately +/- .125" due to the type of rivets, nuts, bolts etc. used. If you require precise dimensions, please call our office and request a copy of our current field dimension sheets.

Weight listed is actual weight of product only. For shipping purposes, please call our office for packaged weight before obtaining freight estimates.

*Staypoles are optional on 40 ft length.

Base width is 24" standard plus 2.5" to go over poles.

Weight without poles deduct approx. 35 lbs each.

MFG Note: We do recommend Staypoles for 40' ladders even though NFPA has listed as optional

Prong Feet as Standard

Rubber safety shoes optional for hard surface use

All Extension ladders 40' and over are equipped with 1/2" manila rope as standard

DUO-SAFETY LADDER CORPORATION 513 W 9th Avenue PO Box 497 Oshkosh WI 54903-0497

Toll Free: 877-386-5377

Fax: 920-231-2460

mail@duosafety.com

www.duosafety.com



DUO-SAFETY LADDER CORPORATION

Aluminum Roof Ladders

Famous Duo-Safety Rail Construction provides the advantage of extra strength without cumbersome weight. Ideal for pumper use - these outstanding ladders have been proven and approved for many years by fire companies everywhere. Installed with standard 3/4" hooks or heavy duty 7/8" hooks for an additional fee.

Series 775-A

Series 875-A

Series 1275-A

Channel Rail Construction
750 lb Duty Rated

SPECIFICATIONS

SERIES 775-A ROOF

| Size | Length | Width | Rail Size | Weight |
|------|-----------|-------|-----------|--------|
| 10' | 10' 2.25" | 19" | 2.75" | 22 lbs |
| 12' | 12' 2.25" | 19" | 2.75" | 24 lbs |
| 14' | 14' 2.25" | 19" | 2.75" | 28 lbs |

SERIES 875-A ROOF

| Size | Length | Width | Rail Size | Weight |
|------|----------|-------|-----------|--------|
| 16' | 16' 2.5" | 19" | 3.25" | 39 lbs |
| 18' | 18' 2.5" | 19" | 3.25" | 44 lbs |
| 20' | 20' 2.5" | 19" | 3.25" | 48 lbs |

SERIES 1275-A ROOF

| Size | Length | Width | Rail Size | Weight |
|------|--------|-------|-----------|--------|
| 25' | 25' 3" | 19" | 3.75" | 64 lbs |
| 30' | 30' 3" | 19" | 3.75" | 72 lbs |

All dimensions listed are N.F.P.A. Design Verification Standards. Variations occur in each product of approximately +/- .125" due to the type of rivets, nuts, bolts etc. used. If you require precise dimensions, please call our office and request a copy of our current field dimension sheets.

Weight listed is actual weight of product only. For shipping purposes, please call our office for packaged weight before obtaining freight estimates.

Prong Feet as Standard

Rubber safety shoes optional for hard surface use

DUO-SAFETY LADDER CORPORATION 513 W 9th Avenue PO Box 497 Oshkosh WI 54903-0497

Toll Free: 877-386-5377

Fax: 920-231-2460

mail@duosafety.com

www.duosafety.com



DUO-SAFETY LADDER CORPORATION

Aluminum Double End Roof Ladders

Famous Duo-Safety Rail Construction provides the advantage of extra strength without cumbersome weight. This ladder was designed for firefighters so that no matter what end of the ladder is on top at the roof peak, there are hooks available. Installed with standard 3/4" hooks or heavy duty 7/8" hooks for an additional fee.

Series 775-DR

Series 875-DR

Channel Rail Construction
750 lb Duty Rated

SPECIFICATIONS

SERIES 775-DR DOUBLE END ROOF

| Size | Length | Width | Rail Size | Weight |
|------|------------|-------|-----------|--------|
| 10' | 10' 1.625" | 19" | 2.75" | 29 lbs |
| 12' | 12' 1.625" | 19" | 2.75" | 33 lbs |
| 14' | 14' 1.625" | 19" | 2.75" | 35 lbs |

SERIES 875-DR DOUBLE END ROOF

| Size | Length | Width | Rail Size | Weight |
|------|------------|-------|-----------|--------|
| 16' | 16' 2.125" | 19" | 3.25" | 49 lbs |
| 18' | 18' 2.125" | 19" | 3.25" | 53 lbs |
| 20' | 20' 2.125" | 19" | 3.25" | 56 lbs |

All dimensions listed are N.F.P.A. Design Verification Standards. Variations occur in each product of approximately +/- .125" due to the type of rivets, nuts, bolts etc. used. If you require precise dimensions, please call our office and request a copy of our current field dimension sheets.

MFG Note: We do not recommend retro fitting older ladders for double hooks.

Weight listed is actual weight of product only. For shipping purposes, please call our office for packaged weight before obtaining freight estimates.

Prong Feet as Standard
Rubber safety shoes optional for hard surface use

DUO-SAFETY LADDER CORPORATION 513 W 9th Avenue PO Box 497 Oshkosh WI 54903-0497

Toll Free: 877-386-5377

Fax: 920-231-2460

mail@duosafety.com

www.duosafety.com



DUO-SAFETY LADDER CORPORATION

Folding Roof Ladders

Equipped with directional folding roof hooks, the Folding Roof Ladder was designed to save space when stored on your fire truck unit. This ladder easily folds for side mounting on a standard engine, yet opens and locks into a long roof ladder for use.

****Please note: this ladder is NOT designed for use as an A-frame style ladder, refer to our 35B or 300A models.**

Series 1275-FR

3 3/4" Channel Rail
750 lb Duty Rated



Shown in a slightly open/closing position to demonstrate how it folds up for storage. **NOT intended to be used in this manner.**

SPECIFICATIONS

SERIES 1275-FR

| Lengths | Extended Length | Width | Banking Thickness | Weight |
|-----------|-----------------|-------|-------------------|--------|
| 8' - 16' | 16' 4.75" | *19" | 7.625" | 65 lbs |
| 10' - 20' | 20' 4.75" | *19" | 7.625" | 72 lbs |
| 12' - 24' | 24' 4.75" | *19" | 7.625" | 80 lbs |
| 14' - 28' | 28' 4.75" | *19" | 7.625" | 86 lbs |
| 15' - 30' | 30' 4.75" | *19" | 7.625" | 97 lbs |

* Overall width including bolt heads on hinge brackets = 20.25"

All dimensions listed are N.F.P.A. Design Verification Standards. Variations occur in each product of approximately +/- .125" due to the type of rivets, nuts, bolts etc. used. If you require precise dimensions, please call our office and request a copy of our current field dimension sheets.

Weight listed is actual weight of product only. For shipping purposes, please call our office for packaged weight before obtaining freight estimates.

Prong Feet as Standard
Rubber safety shoes optional for hard surface use

DUO-SAFETY LADDER CORPORATION 513 W 9th Avenue PO Box 497 Oshkosh WI 54903-0497

Toll Free: 877-386-5377

Fax: 920-231-2460

mail@duosafety.com

www.duosafety.com



DUO-SAFETY LADDER CORPORATION

Aluminum Wall Ladders

Famous Duo-Safety Rail Construction provides the advantage of extra strength without cumbersome weight. Ideal for pumper use - these outstanding ladders have been proven and approved for many years by fire companies everywhere.

Series 750-A

Series 850-A

Series 1250-A

Channel Rail Construction
750 lb Duty Rated

SPECIFICATIONS

SERIES 750-A WALL

| Size | Length | Width | Rail Size | Weight |
|------|-----------|-------|-----------|--------|
| 8' | 8' 2.25" | 19" | 2.75" | 14 lbs |
| 10' | 10' 2.25" | 19" | 2.75" | 17 lbs |
| 12' | 12' 2.25" | 19" | 2.75" | 20 lbs |
| 14' | 14' 2.25" | 19" | 2.75" | 25 lbs |

SERIES 850-A WALL

| Size | Length | Width | Rail Size | Weight |
|------|----------|-------|-----------|--------|
| 16' | 16' 2.5" | 19" | 3.25" | 35 lbs |
| 18' | 18' 2.5" | 19" | 3.25" | 43 lbs |
| 20' | 20' 2.5" | 19" | 3.25" | 45 lbs |

SERIES 1250-A WALL

| Size | Length | Width | Rail Size | Weight |
|------|--------|-------|-----------|--------|
| 25' | 25' 3" | 19" | 3.75" | 62 lbs |
| 30' | 30' 3" | 19" | 3.75" | 70 lbs |

All dimensions listed are N.F.P.A. Design Verification Standards. Variations occur in each product of approximately +/- .125" due to the type of rivets, nuts, bolts etc. used. If you require precise dimensions, please call our office and request a copy of our current field dimension sheets.

Weight listed is actual weight of product only. For shipping purposes, please call our office for packaged weight before obtaining freight estimates.

Prong Feet as Standard

Rubber safety shoes optional for hard surface use

DUO-SAFETY LADDER CORPORATION 513 W 9th Avenue PO Box 497 Oshkosh WI 54903-0497

Toll Free: 877-386-5377

Fax: 920-231-2460

mail@duosafety.com

www.duosafety.com



DUO-SAFETY LADDER CORPORATION

Aluminum Truss Fire Ladders

The 500-C Series ladders represent great strength and extraordinary safety. All this is incorporated into the tubular rail construction of this ladder. Available in all standard sizes - see specifications below.

Series 500-C

Series 525-C

750 lb Duty Rated

SPECIFICATIONS

SERIES 500-C 2-SECTION

| Size | Closed Length | Width | Width Over Poles | Banking Thickness | Weight |
|------|---------------|-------|------------------|-------------------|---------|
| 14' | 9' .75" | 24" | | 7" | 74 lbs |
| 16' | 10' .75" | 24" | | 7" | 75 lbs |
| 18' | 11' .75" | 24" | | 7" | 76 lbs |
| 20' | 12' .75" | 24" | | 7" | 78 lbs |
| 24' | 14' .625" | 24" | | 7" | 90 lbs |
| 28' | 16' .625" | 24" | | 8" | 112 lbs |
| 30' | 18' .75" | 24" | | 8" | 131 lbs |
| 35' | 20' | 24" | | 8" | 153 lbs |
| 40' | 23' .75" | 24" | *26" | 8" | 210 lbs |
| 45' | 26' .75" | 24" | 26" | 9" | 255 lbs |
| 50' | 28' .75" | 24" | 26" | 9" | 279 lbs |

SERIES 525-C 3-SECTION

| Size | Closed Length | Width | Width Over Poles | Banking Thickness | Weight |
|------|---------------|-------|------------------|-------------------|---------|
| 28' | 13' .75" | 26" | | 10.25" | 140 lbs |
| 30' | 14' .75" | 26" | | 10.25" | 164 lbs |
| 35' | 15' 4" | 26" | | 10.25" | 179 lbs |
| 40' | 17' 7.75" | 26" | *28.5" | 10.25" | 245 lbs |
| 45' | 19' .75" | 26" | 28.5" | 11.25" | 265 lbs |
| 50' | 21' 2.75" | 26" | 28.5" | 11.25" | 297 lbs |

All dimensions listed are N.F.P.A. Design Verification Standards. Variations occur in each product of approximately +/- .125" due to the type of rivets, nuts, bolts etc. used. If you require precise dimensions, please call our office and request a copy of our current field dimension sheets.

Weight listed is actual weight of product only.
For shipping purposes, please call our office for packaged weight before obtaining freight estimates.

*Staypoles are optional on 40 ft length
 Weight without poles deduct approx. 35 lbs each

All Extension ladders 40' and over are equipped with 1/2" manila rope as standard

Prong Feet as Standard
 Rubber safety shoes optional for hard surface use

DUO-SAFETY LADDER CORPORATION 513 W 9th Avenue PO Box 497 Oshkosh WI 54903-0497

Toll Free: 877-386-5377

Fax: 920-231-2460

mail@duosafety.com

www.duosafety.com



DUO-SAFETY LADDER CORPORATION

Aluminum Truss Fire Ladders

The tubular construction of Duo-Safety's 500-C Series incorporates the inherent strength of a rectangle, a channel and an "I" beam combined to provide the ultimate in strength and safety. Construction features include: double parallel fins; double set of truss plates; ribbed, extruded rungs, electrically welded to outside of truss plates; and aluminum rivets.

Series 575-C Roof

Series 550-C Wall

750 lb Duty Rated

SPECIFICATIONS

SERIES 575-C ROOF

| Size | Length | Width | Rail Size | Weight |
|------|---------|--------|-----------|---------|
| 10' | 10' .5" | 19.75" | 4.5" | 39 lbs |
| 12' | 12' .5" | 19.75" | 4.5" | 43 lbs |
| 14' | 14' .5" | 19.75" | 4.5" | 50 lbs |
| 16' | 16' .5" | 19.75" | 4.5" | 55 lbs |
| 18' | 18' .5" | 19.75" | 4.5" | 57 lbs |
| 20' | 20' .5" | 19.75" | 4.5" | 63 lbs |
| 25' | 25' .5" | 19.75" | 4.5" | 80 lbs |
| 30' | 30' .5" | 19.75" | 5.5" | 100 lbs |

SERIES 550-C WALL

| Size | Length | Width | Rail Size | Weight |
|------|---------|-------|-----------|--------|
| 10' | 10' .5" | 22.5" | 4.5" | 31 lbs |
| 12' | 12' .5" | 22.5" | 4.5" | 37 lbs |
| 14' | 14' .5" | 22.5" | 4.5" | 44 lbs |
| 16' | 16' .5" | 22.5" | 4.5" | 48 lbs |
| 18' | 18' .5" | 22.5" | 4.5" | 55 lbs |
| 20' | 20' .5" | 22.5" | 4.5" | 59 lbs |
| 22' | 22' .5" | 22.5" | 4.5" | 67 lbs |
| 24' | 24' .5" | 22.5" | 4.5" | 74 lbs |
| 25' | 25' .5" | 22.5" | 4.5" | 77 lbs |
| 26' | 26' .5" | 22.5" | 5.5" | 81 lbs |
| 28' | 28' .5" | 22.5" | 5.5" | 88 lbs |
| 30' | 30' .5" | 22.5" | 5.5" | 96 lbs |

All dimensions listed are N.F.P.A. Design Verification Standards. Variations occur in each product of approximately +/- .125" due to the type of rivets, nuts, bolts etc. used. If you require precise dimensions, please call our office and request a copy of our current field dimension sheets.

Weight listed is actual weight of product only. For shipping purposes, please call our office for packaged weight before obtaining freight estimates.



Model 575C



Model 550C

Prong Feet as Standard - Rubber safety shoes optional for hard surface use

DUO-SAFETY LADDER CORPORATION 513 W 9th Avenue PO Box 497 Oshkosh WI 54903-0497

Toll Free: 877-386-5377

Fax: 920-231-2460

mail@duosafety.com

www.duosafety.com



DUO-SAFETY LADDER CORPORATION

Aluminum Folding Ladders

The ultimate in handy, convenient and light weight, these ladders fold into a compact bundle for storing or carrying. In the open position, special locking devices keep the ladders absolutely rigid. Equipped with Duo-Safety Ladder shoes as an extra precaution.

Series 585-A

300 lb Duty Rated

SPECIFICATIONS

SERIES 585-A ALUMINUM

| Size | Open Length | Closed Length | Open Width | Banking Thickness | Weight |
|------|-------------|---------------|------------|-------------------|--------|
| 8' | 8' .375" | 8' 9.75" | 12.12" | *2.75"x4.25" | 13 lbs |
| 9' | 9' 1.87" | 10' .25" | 12.12" | *2.75"x4.25" | 15 lbs |
| 10' | 10' 1.87" | 11' .25" | 12.12" | *2.75"x4.25" | 16 lbs |
| 12' | 12' .375" | 12' 10.75" | 12.12" | *2.75"x4.25" | 20 lbs |
| 14' | 14' .375" | 14' 10.75" | 12.12" | *2.75"x4.25" | 22 lbs |

*Overall width includes shoes

All dimensions listed are N.F.P.A. Design Verification Standards. Variations occur in each product of approximately +/- .125" due to the type of rivets, nuts, bolts etc. used. If you require precise dimensions, please call our office and request a copy of our current field dimension sheets.

Weight listed is actual weight of product only. For shipping purposes, please call our office for packaged weight before obtaining freight estimates.

Safety Warnings

This ladder folds side to side (together) - caution should be used when placing your hands/fingers for closing and opening ladder.

If the lock assembly is bent or does not properly lock
DO NOT USE ladder as it is not safe to climb





DUO-SAFETY LADDER CORPORATION

Combination Jackknife "A" & Single Ladders

An unusually versatile ladder with countless uses for both indoor and outdoor work. This combination ladder serves as a rugged single ladder - or can be easily converted into a sturdy "A" type ladder with a double climbing side. Strong, heavy gauge steel locking device makes changeover easy and fast. Equipped with famous Duo-Safety Ladder shoes for extra safety.

Series 35-B

3 1/4" Channel Rail
300 lb Duty Rated



SPECIFICATIONS

SERIES 35-B ALUMIUM

| Size | Closed Length | Height as (A) Type | Length as single | Width | Banking Thickness | Weight |
|----------|---------------|--------------------|------------------|---------|-------------------|--------|
| 4' - 8' | 4' 1.875" | 3' 10.62" | 8' 1.75" | *19.75" | **8.37" | 35 lbs |
| 6' - 12' | 6' 1.875" | 5' 10.62" | 12' 1.75" | *19.75" | **8.37" | 40 lbs |
| 7' - 14' | 7' 1.875" | 6' 10.62" | 14' 1.75" | *19.75" | **8.37" | 45 lbs |
| 8' - 16' | 8' 1.875" | 7' 10.62" | 16' 1.75" | *19.75" | **8.37" | 50 lbs |

*Overall width including safety shoes = 20.5"

** Banking height includes safety shoes tilted in open position

All dimensions listed are N.F.P.A. Design Verification Standards. Variations occur in each product of approximately +/- .125" due to the type of rivets, nuts, bolts etc. used. If you require precise dimensions, please call our office and request a copy of our current field dimension sheets.

Weight listed is actual weight of product only. For shipping purposes, please call our office for packaged weight before obtaining freight estimates.

DUO-SAFETY LADDER CORPORATION 513 W 9th Avenue PO Box 497 Oshkosh WI 54903-0497

Toll Free: 877-386-5377

Fax: 920-231-2460

mail@duosafety.com

www.duosafety.com



DUO-SAFETY LADDER CORPORATION

Combination Step and Extension Ladders

The 300 Series Combination Ladder is ideal for indoor fire fighting. In attics and other confined places, this sturdy, ruggedly constructed ladder can be quickly and easily changed from an 8' step to a 13' extension. Extra strong rails and rungs are typical of the heavy duty construction that means extra safety and service provided by this practical, versatile ladder.

Series 300-A

2 3/4" Channel Rail
750 lb Duty Rated



SPECIFICATIONS

SERIES 300-A ALUMINUM

| Size | Closed Length | Height as Step Ladder | Length Extended | Width | Banking Thickness | Weight |
|-----------|---------------|-----------------------|-----------------|---------|-------------------|--------|
| 6' - 9' | 6' 2" | 5' 6" | 9' | *23.25" | **5.68" | 34 lbs |
| 8' - 13' | 8' 2.25" | 7' 6" | 13' | *23.25" | **5.68" | 42 lbs |
| 10' - 15' | 9' 10.875" | 9' 6" | 15' | *23.25" | **5.68" | 47 lbs |

*Overall width including bolt heads on hinge brackets = 23.75"

** Overall banking height including rivet heads and spreader bar = 6.43"

All dimensions listed are N.F.P.A. Design Verification Standards. Variations occur in each product of approximately +/- .125" due to the type of rivets, nuts, bolts etc. used. If you require precise dimensions, please call our office and request a copy of our current field dimension sheets.

Weight listed is actual weight of product only. For shipping purposes, please call our office for packaged weight before obtaining freight estimates.

Prong Feet as Standard
Rubber safety shoes optional for hard surface use

DUO-SAFETY LADDER CORPORATION 513 W 9th Avenue PO Box 497 Oshkosh WI 54903-0497

Toll Free: 877-386-5377

Fax: 920-231-2460

mail@duosafety.com

www.duosafety.com



DUO-SAFETY LADDER CORPORATION

“FRESNO” Aluminum Attic Extension Ladder

“Fresno” Series 701 Aluminum Attic Extension Ladders have become very popular in many sections of the country. Specifically designed for indoor use where space is limited, they are particularly ideal for entering attics through ceiling trap doors and similar close-quarter situations.

The “Fresno” Attic Extension Ladder features strong, light weight channel construction and is only 13” wide, making carrying easier on narrow stairways where longer, bulkier ladders cannot be used.

Series 701 Attic Extension Ladders are available in the stock sizes shown below and in special sizes on request.

Series 701

2 3/4” Channel Rail
750 lb Duty Rated



SPECIFICATIONS

SERIES 701 ALUMINUM

| Size | Closed Length | Over Rail Width | Inside Top Section | Banking Thickness | Weight |
|------|---------------|-----------------|--------------------|-------------------|--------|
| 10' | 7' 2" | 13" | 7.75" | 4.563" | 27 lbs |
| 12' | 8' 2" | 13" | 7.75" | 4.563" | 30 lbs |
| 14' | 9' 2" | 13" | 7.75" | 4.563" | 32 lbs |

All dimensions listed are N.F.P.A. Design Verification Standards. Variations occur in each product of approximately +/- .125" due to the type of rivets, nuts, bolts etc. used. If you require precise dimensions, please call our office and request a copy of our current field dimension sheets.

Weight listed is actual weight of product only. For shipping purposes, please call our office for packaged weight before obtaining freight estimates.

Prong Feet as Standard
Rubber safety shoes optional for hard surface use

DUO-SAFETY LADDER CORPORATION 513 W 9th Avenue PO Box 497 Oshkosh WI 54903-0497

Toll Free: 877-386-5377

Fax: 920-231-2460

mail@duosafety.com

www.duosafety.com



DUO-SAFETY LADDER CORPORATION

Fiberglass Fire Ladders

These fire ladders use extruded fiberglass channel rail construction and aluminum rungs welded to aluminum blocks and riveted to the fiberglass side rails.

All fiberglass ladders are non-conductive for single phase 110 volt service with a maximum of 30,000 volts only, dependant upon conditions.

Series YGE-2

Series YGE-3

4 1/2" Channel Rail

750 lb Duty Rated

Special self-extinguishing resin - will not support flame

Special high temperature resins for heat resistance

Special ultra-violet screen for fade resistance

Safety yellow color for better visibility in smoke

SPECIFICATIONS

SERIES YGE-2 2-SECTION

| Size | Closed Length | Width | Banking Thickness | Weight |
|------|---------------|-------|-------------------|---------|
| 16' | 10' .5" | 23" | 7" | 80 lbs |
| 20' | 12' 3.5" | 23" | 7" | 95 lbs |
| 24' | 14' 3.5" | 23" | 7" | 110 lbs |
| 28' | 16' 3.5" | 23" | 7" | 126 lbs |
| 30' | 17' 10.5" | 23" | 7" | 140 lbs |
| 35' | 20' 3.5" | 23" | 7" | 160 lbs |

SERIES YGE-3 3-SECTION

| Size | Closed Length | Width | Banking Thickness | Weight |
|------|---------------|-------|-------------------|---------|
| 28' | 12' 11.5" | 26.5" | 9.5" | 162 lbs |
| 30' | 13' 3.5" | 26.5" | 9.5" | 170 lbs |
| 35' | 15' 3.5" | 26.5" | 9.5" | 195 lbs |

All dimensions listed are N.F.P.A. Design Verification Standards. Variations occur in each product of approximately +/- .125" due to the type of rivets, nuts, bolts etc. used. If you require precise dimensions, please call our office and request a copy of our current field dimension sheets.

Weight listed is actual weight of product only. For shipping purposes, please call our office for packaged weight before obtaining freight estimates.

Prong Feet as Standard

Rubber safety shoes optional for hard surface use

Model YGE-2

Model YGE-3

DUO-SAFETY LADDER CORPORATION 513 W 9th Avenue PO Box 497 Oshkosh WI 54903-0497

Toll Free: 877-386-5377

Fax: 920-231-2460

mail@duosafety.com

www.duosafety.com



DUO-SAFETY LADDER CORPORATION

Fiberglass Fire Ladders

These fire ladders use extruded fiberglass channel rail construction and aluminum rungs welded to aluminum blocks and riveted to the fiberglass side rails.

All fiberglass ladders are non-conductive for single phase 110 volt service with a maximum of 30,000 volts only, dependant upon conditions.

Series YGR-Roof

3 3/8" Channel Rail

750 lb Duty Rated

Special self-extinguishing resin - will not support flame

Special high temperature resins for heat resistance

Special ultra-violet screen for fade resistance

Safety yellow color for better visibility in smoke

Equipped with 3/4" roof hooks

SPECIFICATIONS

SERIES YGR - ROOF

| Size | Length | Width | Rail Size | Weight |
|------|------------|--------|-----------|--------|
| 10' | 10' 2.812" | 19.25" | 3.375" | 33 lbs |
| 12' | 12' 2.812" | 19.25" | 3.375" | 35 lbs |
| 14' | 14' 2.812" | 19.25" | 3.375" | 41 lbs |
| 16' | 16' 2.812" | 19.25" | 3.375" | 47 lbs |
| 18' | 18' 2.812" | 19.25" | 3.375" | 50 lbs |
| 20' | 20' 2.812" | 19.25" | 3.375" | 56 lbs |

All dimensions listed are N.F.P.A. Design Verification Standards. Variations occur in each product of approximately +/- .125" due to the type of rivets, nuts, bolts etc. used. If you require precise dimensions, please call our office and request a copy of our current field dimension sheets.

Weight listed is actual weight of product only. For shipping purposes, please call our office for packaged weight before obtaining freight estimates.

Prong Feet as Standard

Rubber safety shoes optional for hard surface use

DUO-SAFETY LADDER CORPORATION 513 W 9th Avenue PO Box 497 Oshkosh WI 54903-0497

Toll Free: 877-386-5377

Fax: 920-231-2460

mail@duosafety.com

www.duosafety.com



DUO-SAFETY LADDER CORPORATION

Fiberglass Fire Ladders

These fire ladders use extruded fiberglass channel rail construction and aluminum rungs welded to aluminum blocks and riveted to the fiberglass side rails.

All fiberglass ladders are non-conductive for single phase 110 volt service with a maximum of 30,000 volts only, dependant upon conditions.

Series YGR-Wall

3 3/8" Channel Rail

750 lb Duty Rated

Special self-extinguishing resin - will not support flame

Special high temperature resins for heat resistance

Special ultra-violet screen for fade resistance

Safety yellow color for better visibility in smoke



SPECIFICATIONS

SERIES YGR - WALL

| Size | Length | Width | Rail Size | Weight |
|------|----------|--------|-----------|--------|
| 10' | 10' 2.5" | 19.25" | 3.375" | 26 lbs |
| 12' | 12' 2.5" | 19.25" | 3.375" | 30 lbs |
| 14' | 14' 2.5" | 19.25" | 3.375" | 36 lbs |
| 16' | 16' 2.5" | 19.25" | 3.375" | 40 lbs |
| 18' | 18' 2.5" | 19.25" | 3.375" | 46 lbs |
| 20' | 20' 2.5" | 19.25" | 3.375" | 50 lbs |

All dimensions listed are N.F.P.A. Design Verification Standards. Variations occur in each product of approximately +/- .125" due to the type of rivets, nuts, bolts etc. used. If you require precise dimensions, please call our office and request a copy of our current field dimension sheets.

Weight listed is actual weight of product only. For shipping purposes, please call our office for packaged weight before obtaining freight estimates.

Prong Feet as Standard
Rubber safety shoes optional for hard surface use

DUO-SAFETY LADDER CORPORATION 513 W 9th Avenue PO Box 497 Oshkosh WI 54903-0497

Toll Free: 877-386-5377

Fax: 920-231-2460

mail@duosafety.com

www.duosafety.com



DUO-SAFETY LADDER CORPORATION

Combination Jackknife "A" & Single Ladders

An unusually versatile ladder with countless uses for both indoor and outdoor work. This combination ladder serves as a rugged single ladder - or can be easily converted into a sturdy "A" ladder with a double climbing side. Strong, heavy gauge steel locking device makes changeover easy and fast. Equipped with famous Duo-Safety Ladder shoes for extra safety.

Series 35-FGB

3 1/4" Channel Rail
750 lb Duty Rated



SPECIFICATIONS

SERIES 35-FGB FIBERGLASS

| Size | Closed Length | Height as (A) Type | Length as single | Width | Banking Thickness | Weight |
|----------|---------------|--------------------|------------------|---------|-------------------|--------|
| 4' - 8' | 4' 2.75" | 3' 11.5" | 8' 3.25" | *19.25" | **8" | 42 lbs |
| 6' - 12' | 6' 2.75" | 5' 11.5" | 12' 3.25" | *19.25" | **8" | 46 lbs |
| 7' - 14' | 7' 2.75" | 6' 11.5" | 14' 3.25" | *19.25" | **8" | 49 lbs |
| 8' - 16' | 8' 2.75" | 6' 11.5" | 16' 3.25" | *19.25" | **8" | 53 lbs |

*Overall width including safety shoes = 19.75"

** Banking height includes safety shoes tilted in open position

All dimensions listed are N.F.P.A. Design Verification Standards. Variations occur in each product of approximately +/- .125" due to the type of rivets, nuts, bolts etc. used. If you require precise dimensions, please call our office and request a copy of our current field dimension sheets.

Weight listed is actual weight of product only. For shipping purposes, please call our office for packaged weight before obtaining freight estimates.

Prong Feet as Standard
Rubber safety shoes optional for hard surface use

DUO-SAFETY LADDER CORPORATION 513 W 9th Avenue PO Box 497 Oshkosh WI 54903-0497

Toll Free: 877-386-5377

Fax: 920-231-2460

mail@duosafety.com

www.duosafety.com



DUO-SAFETY LADDER CORPORATION

Pike Poles - Fiberglass

Duo-Safety Fiberglass Pike Poles have an extruded aluminum head for durability and permanent molded-in yellow color. Available in 2' - 20' lengths. To reduce shipping cost on single orders for 10' - 16' lengths, request United Parcel Shipment of 2-part sleeved pole to be permanently assembled at destination. (Fee is charged for sleeving)

PLEASE NOTE: Pike Poles are designed for push and pull applications. This pole is hollow, it is NOT intended to be used as a pry bar.



SPECIFICATIONS

Pole Diameter 1.75"

| Length | Weight |
|--------|--------|
| 2' | 1 lbs |
| 3' | 2 lbs |
| 4' | 3 lbs |
| 5' | 4 lbs |
| 6' | 4 lbs |
| 8' | 5 lbs |
| 10' | 6 lbs |
| 12' | 7 lbs |
| 14' | 9 lbs |
| 16' | 10 lbs |
| 18' | 12 lbs |
| 20' | 14 lbs |

D-Handles for Pike Poles

Handles are welded aluminum construction available to fit fiberglass pike poles. These large aluminum D-Handles can be retro-fitted to your in-service pike poles or ordered installed on new poles at the factory.



Pike Pole Head

Series FPH - For Fiberglass Poles





DUO-SAFETY LADDER CORPORATION

Fire Ladder Replacement Parts

Roof Hook Assembly

These extremely sturdy hooks have a cold rolled steel hook and a steel spring semi-enclosed in an aluminum housing for protection of working parts.

Part Numbers:

RH-1 3/4" NFPA standard size

RH-2 7/8" Heavy Duty size

RH-YG Fiberglass 3/4" size



Included: (All models except fiberglass)

- 1 Aluminum rung
- 1 Pair New 3/4" Roof Hooks
- 4 Each 1/4" x 3/4" Bolts
- 4 Each 1/4" Nuts
- 4 Each 1/4" Flat Washers
- 4 Each 1/4" Lock Washers
- 4 Each Rivets
- Instruction Sheet

Ladder Lock Assembly

These automatic ladder locks are ideal for all types of extension ladders. The housing protects the mechanism from rain, snow and ice.

Part Number:

LLA - Specify lettered pair when ordering.

(ex. A/B, C/D)

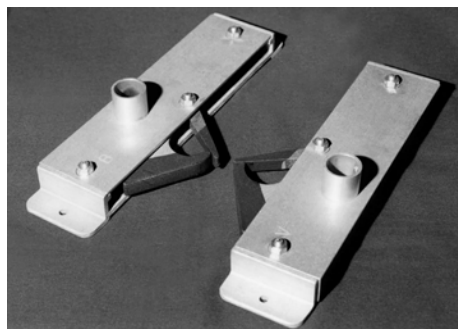

Lock Housing Repair Kit

For in field repairs of automatic lock housings for fire department ladders.

A complete kit consisting of instructions and replacement parts to recondition spring loaded extension ladder lock.



Parts in Kit:

- * Instruction sheet showing lock housing parts for assembly and disassembly
- * New bolts, nuts, washers & rivets
- * New springs to replace weak or broken springs

DUO-SAFETY LADDER CORPORATION 513 W 9th Avenue PO Box 497 Oshkosh WI 54903-0497

Toll Free: 877-386-5377

Fax: 920-231-2460

mail@duosafety.com

www.duosafety.com



DUO-SAFETY LADDER CORPORATION

Ladder Safety Shoes

Strong, dependable Duo-Safety Ladder Shoes are equipped with rugged, spiked toes for ground use and are easily converted to rubber soled shoes for hard surface use. Suction soles have 8" of gripping area.



Part Numbers:

| | |
|---------|--------------------------------------|
| SSA | For Aluminum & Wood Ladders |
| SSA-585 | For 585-A Ladders |
| SSA-U | For Aluminum Ladders (universal kit) |
| SSW-FG | For Fiberglass Ladders |



Halyard/Rope

All rope furnished with Duo-Safety Ladders as standard still continues to be pure manila rope. The factory uses manila rope because it still offers the least expensive and best combination of desirable features available in rope today:

- Soft - not stiff
- Abrasive - does not slip in gloves
- Will not stretch with heat exposure
- Has a maximum tensile strength of at least 825 lbs (No ladder requires more than 75 lbs to raise)
- Readily available for replacement in any local hardware store - when it wears out
- However, halyard replacement can be any rope material you choose - as long as NFPA-1931 is followed.



Available in standard 3/8" or 1/2" diameter priced by the foot or available in 600' or 1200' coils.

Cable Repair Kit

A complete kit containing all the required parts needed to convert the cable on your three section ladder to an adjustable length cable. This kit is normally never required, but if usage has been such that the fly section does not lock in when the lower section locks, a repair kit cable may be required.

Parts in kit:

- 1 Cable (length to fit model ordered)
- 2 Each "U" bolts to clamp cable
- 2 Each Thimbles for ends of cable
- 4 Each Halves of rung clip attached to end of cable
- 2 Each Bolt and nut for rung clip

When ordering Cable Repair Kit, be sure to specify the exact ladder length & type of ladder.

DUO-SAFETY LADDER CORPORATION 513 W 9th Avenue PO Box 497 Oshkosh WI 54903-0497

Toll Free: 877-386-5377

Fax: 920-231-2460

mail@duosafety.com

www.duosafety.com



DUO-SAFETY LADDER CORPORATION

End Caps for Ladders

All end caps are sold in pairs only and are supplied with the proper rivets.

All rivet removals use a 3/16" drill bit, and a hand/air rivet gun to install.

If the end caps are roof ladders/fly section caps - they are plain type (no guide notch cut out)

If the end caps are for base sections/middle sections - they are cap types with a notch cut out for guides.

YOU STILL MUST ADVISE RAIL SIZE FOR PROPER FITS.

EXAMPLE:

14' 775A end caps - order: 1 pair - plain type - 2 3/4" rail size

24' 900A end caps - order: 1 pair - plain type - 3 1/4" rail size

plus order: 1 pair - notch cut type - 3 1/4" rail size

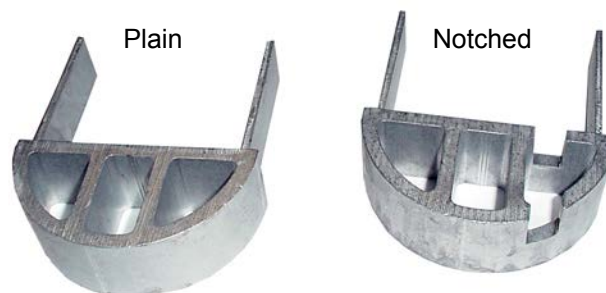

End Caps for Folding Ladders

Duo-Safety folding ladders in the past had rubber end caps. Since 2001, Duo-Safety has replaced the rubber end cap with new aluminum end caps. Aluminum end caps are riveted on the end of the ladder and never fall off like the previous rubber caps. The aluminum end caps will fit into the rails of older model folding ladders. All new pairs of aluminum end caps come with rivets and instructions for installation.

The new aluminum end caps add about 1 inch to the length of the folding ladder.

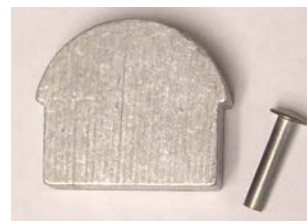

Prong Feet/Spurs for Ladders

All prong feet are made of aluminum and are sold in pairs only and are supplied with the proper rivets.

All rivet removals use a 3/16" drill bit, and a hand/air rivet gun to install.

If the prong feet are roof ladders - they are plain type (no guide notch cut out)

If the prong feet are for base sections - they are with a notch cut out for guides.

YOU STILL MUST ADVISE RAIL SIZE FOR PROPER FITS.

EXAMPLE:

14' 775A prong feet - order: 1 pair - plain type - 2 3/4" rail size

24' 900A prong feet - order: 1 pair - notch cut type - 3 1/4" rail size



DUO-SAFETY LADDER CORPORATION 513 W 9th Avenue PO Box 497 Oshkosh WI 54903-0497

Toll Free: 877-386-5377

Fax: 920-231-2460

mail@duosafety.com

www.duosafety.com



DUO-SAFETY LADDER CORPORATION

Duo-Safety Rung Expander Kit

For convenient in-the-field hand repair service

Notice: All Duo-Safety Ladders have welded rungs. To replace rungs in any Duo-Safety aluminum ladders, please order and use our rung expander kit if you are replacing more than three rungs in any one section.

The rung expander kit consists of:

1. Hand expander tool
2. Rung reamer tool
3. Instruction sheet



Cutter 1.25" Diameter



You remove the damaged rungs using the rung reamer tool and your 1/2" drill motor. This tool cuts the old rung away from the ladder rail and inner plate assembly and leaves the proper size finished hole to be able to re-weld a new rung into the rail (we suggest heli-arch welding). You then finish the job with the hand rung expander to expand the rung tight on the inner plate assembly (see instructions with kit).

There are two plans available for use of the kit. 1) Loan Plan - the kit is shipped on memorandum billing - a credit is issued upon its return. The only charge is for shipping. 2) Purchase Plan - the kit may be purchased outright. Extra rungs and plates are billed F.O.B. Oshkosh, Wisconsin.

Aluminum Rungs

All rungs are 1 1/4" diameter by .065" wall thickness. This is considered a Standard Rung. If the ladder width is wider than 24" you probably have Heavy Rungs - 1 1/4" diameter by .105 wall thickness.

Note: All replacement rungs are supplied 24" standard .065" wall

To remove any welded rung from the rail or plate, you must use a rung reamer tool. There is no need to replace the rung plates unless they are damaged.

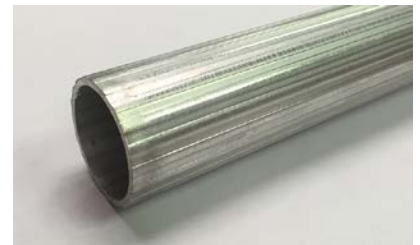

Stainless Steel Wear Sleeves

Stainless Steel Wear Sleeves were developed to prevent damage and wear to ladder rungs, possibly caused by nesting ladders. Sleeves are sold individually and come with two pop rivets. Sleeves should be placed on the rungs as pictured below at wear points. You should not require more than 4 wear sleeves between any two ladders.

Dimensions for the wear sleeve is 1.5" wide and 0.88" high.

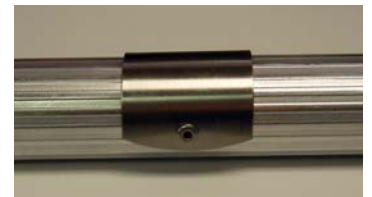

DUO-SAFETY LADDER CORPORATION 513 W 9th Avenue PO Box 497 Oshkosh WI 54903-0497

Toll Free: 877-386-5377

Fax: 920-231-2460

mail@duosafety.com

www.duosafety.com



DUO-SAFETY LADDER CORPORATION

Heat Sensor Labels

These are visual warning labels furnished on all aluminum and fiberglass ladders since January, 1984.

REMOVE LADDER FROM SERVICE
AND TEST IF ANY HEAT SENSOR
TURNS DARK



These labels are heat sensitive material that turn black if any heat is ever present that is greater than approximately 300 degrees F. The 300 degree F temperature is used because once aluminum fire ladder materials (6061-T6 alloy) reach this 300 degree F (even if only for a moment), the ladder material may have lost at least 25% of its load capacity. This heat exposure effect is not reversible in the ladder and can continue to accumulate over its entire lifetime.

NOTE: If any heat sensor label becomes black - remove the ladder from service at once and have the ladder load tested before the ladder is ever used again. If the ladder passes the load test - you have had a false alarm - replace the heat sensors and return the ladder to service. Replacement heat sensor labels are only available for ladders that have passed the load test. If the ladder does not pass the test, we will not supply you with new labels. Call the factory for details.

REMEMBER: Heat sensor labels that look OK do not make the ladder safe to use.

N.F.P.A. now requires 4 heat sensors and one instruction label per ladder section. Each heat sensor has an expiration date printed on them. If you have noticed any expired labels, conduct/schedule testing first per NFPA-1932 (Current Edition) and the expired labels must be replaced. Place 2 heat sensor labels below the 2nd rung from the top of each inside rail section (1 on the right inside rail - 1 on the left inside rail). Place the other 2 heat sensor labels, including one instruction label at the approximate middle point of each inside rail section (1 on the right inside rail - 1 on the left inside rail with instruction label)

Fire Ladder Labels

These warning labels are required on all aluminum and fiberglass ladders. These labels show important warnings and proper ladder angle placement.

One set/pair of Danger/Electrical/Angle labels are required for each ladder. The labels should be placed at the bottom of the ladder, outside the rail of the base section, both sides, between the 4th and 5th rung up from the bottom. Be sure the left label is placed on the right side, and the right label is placed on the left side. If placed on the wrong sides of the ladder, they will not make sense for ladder placement.



DUO-SAFETY LADDER CORPORATION 513 W 9th Avenue PO Box 497 Oshkosh WI 54903-0497

Toll Free: 877-386-5377

Fax: 920-231-2460

mail@duosafety.com

www.duosafety.com



DUO-SAFETY LADDER CORPORATION

Banking Arrangements

Select your banking arrangement, indicate the ladder series and dimensions on this sheet, and send with your order. This will facilitate handling and ensure shipment of the right ladder for your requirements. There is an additional cost for special banking widths.

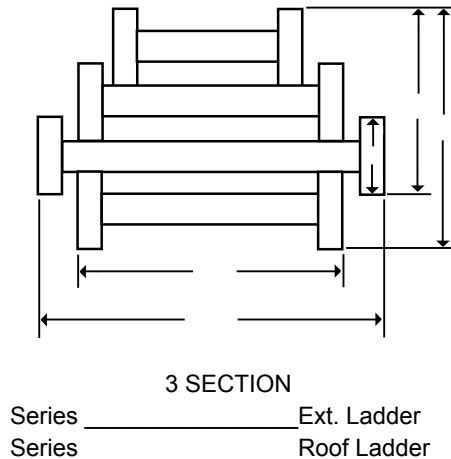
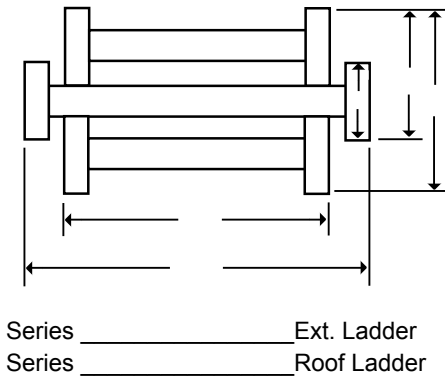
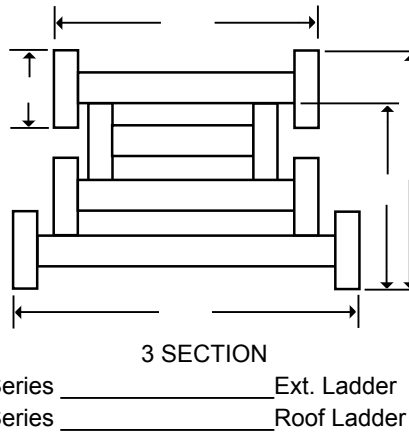
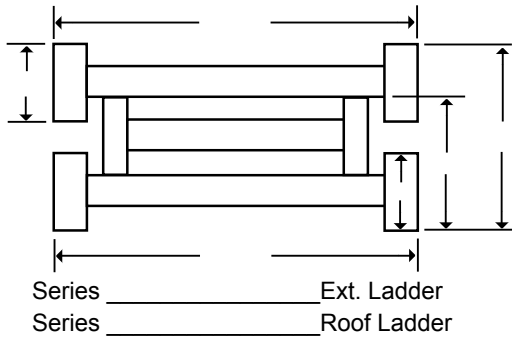

Ladder Placement

One of the most vital areas of ladder safety is the correct placement angle of your ladder. The illustration to the right shows the exact method for proper placement of ladders of varying lengths. With this method, the ladder is placed against the vertical plane (wall, etc.) at a 75-1/2 degree angle.

$$\text{correct placement (distance from wall)} = \frac{\text{total working length of ladder}}{4}$$

A simple formula for correct placement is to position the bottom of the ladder at a distance from a vertical plane equal to 1/4 the total working length of the ladder. At this angle, your ladder will give the best service and maximum strength.

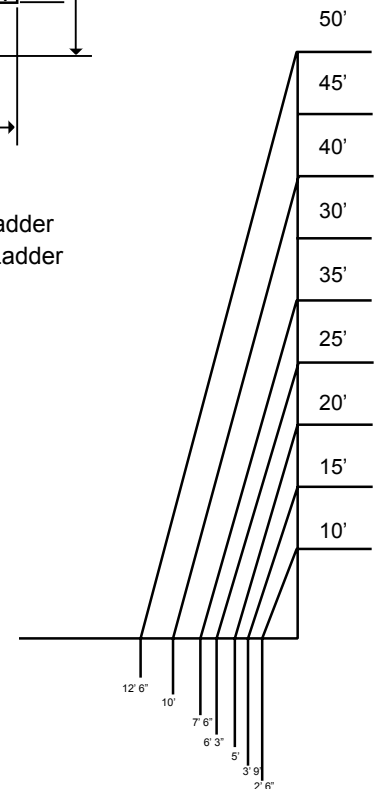



DUO-SAFETY LADDER CORPORATION

Ladder Usage

Even the best engineered piece of equipment must be properly used and maintained for best results. The following recommendations will help you obtain maximum service and safety from your Fire Ladders.

1. The strength of any ladder, regardless of the manufacturer, will be considerably reduced in the horizontal position. With this in mind, we recommend that no ladder be used in this position unless specifically designed for this purpose.
2. Extreme caution must be taken when any ladder is used near high voltage lines, transformers or any electrical source. When these conditions are present, follow established safety procedures as issued by your own department.
3. If a ladder has been subjected to extreme heat or unusual abuse, it should be tested prior to further use to assure no damage has affected the structural members.
4. When carried on a truck, ladders should be fastened down. Contact points on mounting brackets should be padded to minimize abrasion.
5. Never bed or place a ladder near engine exhaust heat.
6. Inspect hardware fittings, accessories, ropes, cables and pulleys after each use to be sure the ladder meets NFPA standards.
7. All ladders should be tested in accordance with the latest NFPA regulations.
8. Ladders shall not be used for any operation nor in any way which is not specifically recommended by both NFPA and IFSTA standards and/or training manuals.

Ladder Facts

Fire Department ladders are constructed of 3 possible material types: ie; Wood, Fiberglass or Aluminum. All fire department ladders were made of wood 100 years ago. However, today, man made materials have taken over the market because of lighter weight and greater reliability. Also, today lumber has become scarce and very expensive.

Fire Ladders - General

Aluminum ladders, like any other designed and engineered metal products, are built to exact tolerances with precise usage and safety factors built in. Duo-Safety fire ladders in general are designed and built to carry a 750 lb. load with a 4:1 safety factor. Aluminum and Fiberglass materials lend themselves to ladder construction very nicely for several reasons:

- * Both are man made and there is no guess work about the design limits of the materials. You just decide where you need your limits and design the material size to fit.
- * All the material is the same - every time - quality control is easy.
- * Aluminum is used to save weight on the ladders.
- * Fiberglass is used to reduce electrical hazard.
- * Lumber, however is a natural product - not man made - thus every tree and board is different and has a different load limit.
- * Lumber (wood) ages rapidly and tends to swell and shrink with changes of temperature and humidity. These changes affect the load limit almost daily.
- * Aluminum and Fiberglass are basically not affected by these daily changes and their load limits do not change daily.

Thus, it becomes apparent for the most reliable ladder products, Aluminum and Fiberglass have become the only remaining choices.

DUO-SAFETY LADDER CORPORATION 513 W 9th Avenue PO Box 497 Oshkosh WI 54903-0497

Toll Free: 877-386-5377

Fax: 920-231-2460

mail@duosafety.com

www.duosafety.com



DUO-SAFETY LADDER CORPORATION

Frequently Asked Questions

Ladders are tools and must be maintained to ensure safe operation. For complete ladder testing information, please refer to N.F.P.A. 1932 which includes a chapter entitled "Service Testing Ground Ladders". Below are some commonly asked questions concerning fire department ground ladder testing and maintenance procedures.

- Q. How often must I test my ladders? We are a small fire department.**
All fire department ground ladders must be service tested at least annually, in accordance with N.F.P.A. 1932.
- Q. What tests are required?**
Refer to N.F.P.A. 1932 - the three basic tests required involve a center load test for ladder strength, a hardware test to verify hardware functionality and strength, and a roof hook test applicable only to roof ladders. These are all defined in the N.F.P.A. 1932 standard.
- Q. Who can perform my test?**
There are numerous testing companies capable of performing fire department ground ladder in-service tests at your facility. However, the tests are designed to make it relatively easy and affordable for a department or group of departments to perform their own tests.
- Q. If I test my ladders, do I weaken them?**
Required periodic testing does not adversely affect a good ladder. We at Duo-Safety have put the same ladder through over 1,000 test load cycles and the ladder still continued to meet the N.F.P.A. standards.
- Q. Should we use our Duo-Safety ladder "fly in" or "fly out"?**
Duo-Safety ladders are all designed for the "fly out" application. Ladders constructed to be used "fly out" should not be used "fly in" as the hardware can project through and be a tripping hazard. Contact our office for further information.
- Q. What is the load capacity of your ladders?**
The load capacity of fire department ground ladders is spelled out in N.F.P.A. 1932. It is generally 750 pounds on any ladder except folding ladders and pompier ladders. This is based ONLY on the fact that the ladder is set at the proper angle of one-fourth the distance to support point out from the base AND is tied off at the top and bottom to prevent slippage AND has been tested for N.F.P.A. 1932 testing requirements to ensure continued structural reliability.
- Q. Are ladders field repairable?**
All Duo-Safety ladder parts are available for field installation. These require a minimum number of readily available tools to accomplish the repairs. Many times, it is not cost effective to repair a ladder and may be more cost effective to replace a section or even to replace the entire ladder.
- Q. Are your ladders N.F.P.A. compliant?**
All Duo-Safety fire department ground ladders meet and/or exceed the requirements of N.F.P.A. at time of manufacture.



DUO-SAFETY LADDER CORPORATION

Frequently Asked Questions

- Q. Are your ladders equipped with three-quarter inch diameter roof hooks?**
Yes, since 1984.
- Q. Why do we have to change the roof hooks?**
Older hooks, which were five-eighths inch diameter, will not pass the current N.F.P.A. 1932 strength test.
- Q. What labels are required on our ladders?**
N.F.P.A. now requires 4 (four) heat sensors per each section on a ladder and 1 (one) pair of fire ladder labels (danger/electrical/angle indicator) on each base section of a ladder. Please contact our office for instructions and proper placement of these labels.
- Q. What maintenance is required for my ladders?**
Refer to N.F.P.A. 1932 standards for testing information; otherwise, basic care includes regular cleaning/waxing/lubrication at least annually but ideally after each use at a fire is best. Please refer to our "Care & Maintenance Booklet" provided free. Contact our office for a copy.
- Q. What are your lead times on delivery?**
Generally, most of our products are available from stock pending prior sales. We strive to maintain a large service inventory in order to fill your immediate needs.
- Q. Can we order special widths/lengths of ladders?**
Special widths/lengths are available, however we do charge an extra fee to manufacture special ladders. Please refer to our current production models listed in our catalog - if at all possible please try to re-arrange truck mounts etc. to fit current N.F.P.A. models. Please contact our office for fees and instruction on proper measurements needed for replacement ladders.
- Q. How come it costs so much to ship my ladders?**
Shipping costs are figured by weight and distance the items have to travel. Freight costs are the result of the class we ship ladders at (as established by the freight carriers) and damage claims. Duo-Safety is unable to quote freight rates. Please contact our office if you require help in obtaining the proper information needed. We will provide you with an estimated shipping weight and shipping class and our recommendation on a carrier to your area. Please note we make every effort to use carriers that are responsible with our freight, however, damages can occur from time to time.
PLEASE ALWAYS INSPECT FULLY YOUR SHIPMENT BEFORE YOU SIGN THE DRIVER'S BILL OF LADING. ONCE THE BILL IS SIGNED - YOU MAY HAVE LOST ANY RIGHT TO A CLAIM.



DUO-SAFETY LADDER CORPORATION

Ladder Testing

Ladders are tools and require some maintenance to ensure their continuing safety.

For complete testing details, we suggest all Fire Departments obtain a current copy of the National Fire Protection Association (N.F.P.A.) 1932 (latest edition) entitled Use, Maintenance and Service Testing of Fire Department Ground Ladders. This N.F.P.A. document outlines and details all the tests required for your annual ladder tests.

We feel the annual requirement for inspection and testing is the very least a concerned Fire Department should do for their firefighters.

- Do you always know what has happened to your ladders?
- How long have your ladders been in service?
- How many times have they been dropped?
- Overheated? Over loaded? Hit by something?
- Do you have wood ladders? Are they dried and splitting?

The primary, most basic of all the N.F.P.A. tests is the Horizontal Bend Test. An abbreviated outline of that test follows:

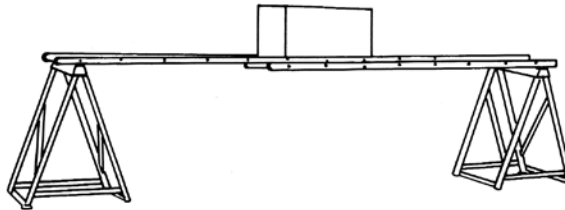

Horizontal Bend Test / Visual Inspection

Place the ladder to be tested upon a pair of sawhorses. The horses are placed 6" in from each end of the ladder - top and bottom. Be sure the ladder is fully extended and as level as possible. We suggest you now do your visual inspection of the ladder before the load is placed. Check for any noticeable problems - loose nuts/bolts, bent rungs/loose rungs, any problems/areas that no longer look factory fresh. If everything looks OK - proceed to the load test.

1. The test load required is 350 lbs for pre-load and 500 lbs for final load.
2. The pre-load of 350 lbs is applied to the center area of the ladder covering 32" in length and at least the width of ladder section. (Center of the ladder and no more than 16" on each side of the center.)
3. Wait one minute and remove the 350 lb pre-load and measure from the center of the ladder to the ground - record the measurement.
4. Apply the full 500 lb test load to the load area, wait 5 minutes and again remove the 500 lbs.
5. After another 5 minutes, measure from the center of the ladder to the ground - record the measurement.

If the difference between measurements is greater than 1/2" for ladders up to 25 ft or 1" for ladders 26 ft to 34 ft or 1-1/2" for ladders over 35 ft - the ladder has failed. Remove from service and destroy. If the amount of set is less than allowed, you have passed the test.

Remember - the ladders lifetime job is to be able to carry a load. How else but by a load test can anyone find out if the ladder is still able to carry that load? There are various other tests outlined in the N.F.P.A. standard, however if your ladder passes the center load test, it now has a greater probability of passing the rest of the tests. For further discussion of ladder testing, we suggest you contact us at 1-877-386-5377.

DUO-SAFETY LADDER CORPORATION 513 W 9th Avenue PO Box 497 Oshkosh WI 54903-0497

Toll Free: 877-386-5377

Fax: 920-231-2460

mail@duosafety.com

www.duosafety.com



DUO-SAFETY LADDER CORPORATION

Ladder Care & Maintenance Booklet

This booklet covers the care and maintenance of Duo-Safety ground ladders. It is a general guide to follow for care and use. Please contact our office for your copy.



Warranty

Duo-Safety Ladder products shall be free from defects in material and workmanship under normal use and service. This warranty is in effect within the first two years of use. The Company's warranty is limited to repair or replacement of any product Duo-Safety determines has failed during the warranty period due to defective material or workmanship. After written approval by the Seller, the product or defective part must be returned prepaid to the Seller's plant, Oshkosh, Wisconsin. The provisions of the warranty shall not apply to any Duo-Safety product which has been subject to misuse, negligence, alteration or accident, or which has been repaired by someone other than the Seller.

There are no warranties which extend beyond the description on the face hereof

DUO-SAFETY LADDER CORPORATION 513 W 9th Avenue PO Box 497 Oshkosh WI 54903-0497

Toll Free: 877-386-5377

Fax: 920-231-2460

mail@duosafety.com

www.duosafety.com



DUO
Safety

Duo-Safety Ladder Corporation

513 W 9th Avenue PO Box 497
Oshkosh, WI 54903-0497
Phone: 920-231-2740 Fax: 920-231-2460
Toll Free: 877-386-5377 (DUOLDRS)
email: mail@duosafety.com
www.duosafety.com