

“HG” Hot Gas Generator

Gas Fired Furnace System

Operations & Maintenance Manual

Gen. 5 – Ver. 2.0

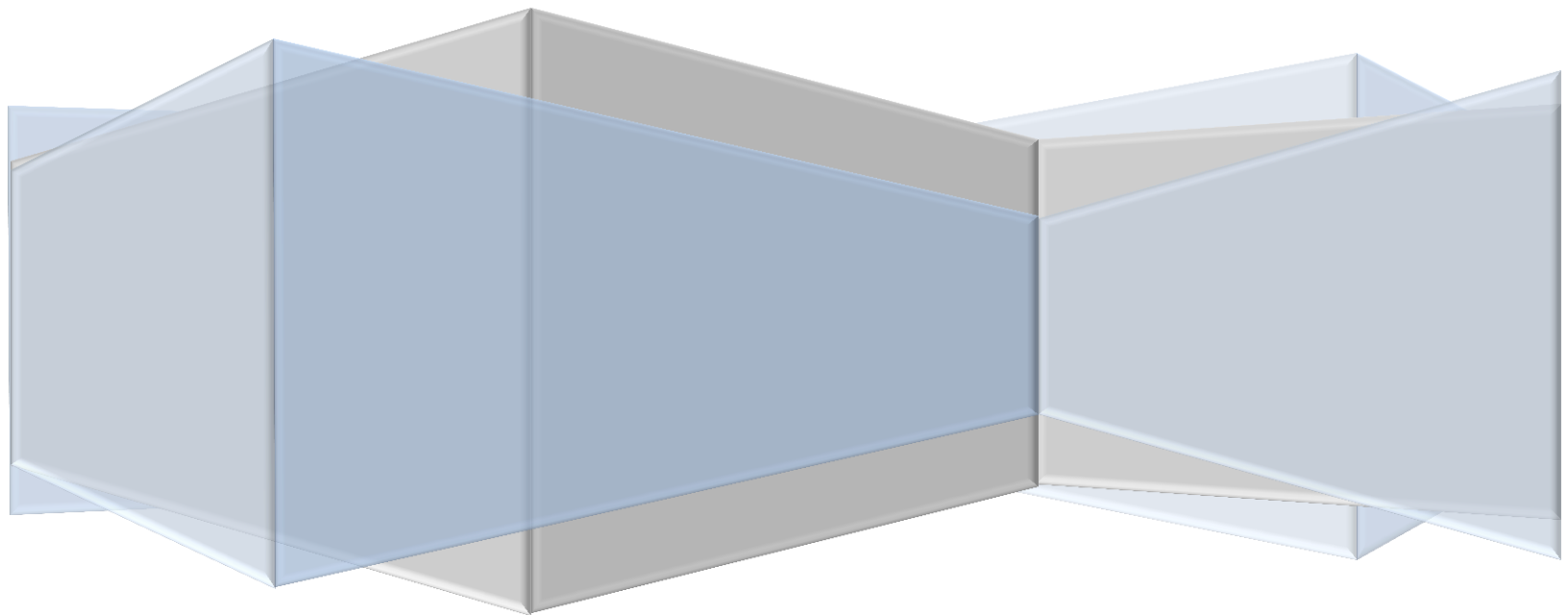

Table of Contents

OPERATING PRECAUTIONS	3
CHAPTER 1.....	4
Introduction to Your “HG” Hot Gas Generator	4
460VAC CONTROLS	6
VARIABLE FREQUENCY DRIVE / BLOWER SPEED CONTROL	6
LINE REACTOR	6
115VAC CONTROL TRANSFORMER	6
TEMPERATURE & AIR FLOW CONTROLLER	6
CONTROL SWITCHES & PILOT LIGHTS	6
CONVENIENCE OUTLET	6
FLAME MANAGEMENT CONTROL.....	6
IGNITOR / FLAME SENSOR	7
AIR PRESSURE SWITCH.....	7
AIR FLOW MONITOR	7
GAS SOLENOIDS	7
PROPORTIONAL GAS CONTROL SOLENOID.....	7
COMBUSTION CHAMBER	7
PILOT BURNER.....	7
BLOWER, HIGH FLOW – LOW PRESSURE (460VAC)	8
BLOWER, LOW FLOW – HIGH PRESSURE (460VAC)	8
PILOT PRESSURE REGULATOR – LEFT	8
MAIN BURNER REGULATOR – RIGHT	8
CHAPTER 2.....	9
Installation	9
CHAPTER 3.....	11
Starting & Operation.....	11
A. PREPARATION FOR START UP	11
B. HEATER START UP	11

WARNING..... 11

 TEMPERATURE PROFILE CONTROL 12

 C. HEATER SHUT DOWN 12

CHAPTER 4..... 13

Adjustments 13

 B. PHYSICAL ADJUSTMENT 13

 C. ELECTRICAL ADJUSTMENT 13

 D. AIR FLOW ADJUSTMENT 13

 E. FUEL FLOW ADJUSTMENT 13

CHAPTER 5..... 14

Maintenance 14

 B. AIR SUPPLY MAINTENANCE 14

 C. ELECTRICAL MAINTENANCE 14

 D. GAS MAINTENANCE 14

burners inc.

CUSTOM FABRICATION GROUP

PO Box 735 • Milford • MI • 48381-0735

Ph: 800-878-2876 • Fax: 800-878-9329

www.burnersinc.com • info@burnersinc.com



OPERATING PRECAUTIONS



This operating manual presents information that will help to properly operate and care for your “HG” Hot Gas Generator from [Burners, Inc.](#). Study its contents carefully. The unit will provide good service and continued operation if proper operating and maintenance instructions are followed. No attempt should be made to operate the unit until the principles of operation and all of the components are thoroughly understood. Only trained and authorized personnel should be allowed to operate, adjust or repair this equipment.

If you are operating this heating system, it is your responsibility to ensure that such operation is in full accordance with all applicable safety requirements and safety codes.

Throughout this manual, we have used symbols to stress important information. These symbols and their meaning are as follows:



WARNING – This symbol precedes information which, if disregarded, may result in injury to the user of the heating system or to others.



CAUTION – This symbol precedes information which, if disregarded, may result in damage to the heating system.



NOTE – This symbol precedes information which is vital to the proper operation of or maintenance of the heating system.

CHAPTER 1

Introduction to Your “HG” Hot Gas Generator

The heating system is comprised of four (4) different sub-systems and is described in the following sections of chapter 2:

A – CONTROL • B – COMBUSTION • C – AIR • D - GAS

A. GENERAL DESCRIPTION

The “HG” series Hot Gas Generator, Gas Fired Furnace heating system is based on a given heating output to be used as a direct fired heat source. See figure 1.1 for model designation.

MODEL	HEATING OUTPUT
HG – 300	300,000 BTU/hr
HG – 500	500,000 BTU/hr
HG – 1000	1,000,000 BTU/hr
HG – 2000	2,000,000 BTU/hr

Figure 1.1

B. CONTROL SYSTEM

The term “control” covers electrical controls or those monitored by the programming control or flame management system.

The sequence of operation from start-up through shut-down is governed by the flame management controller in conjunction with the operating and monitoring devices.

The burner control circuit operates on 115VAC, single phase, 60 hertz alternating current.

In addition to the standard flame management controls, other devise may be required to meet specific requirements of your insurance carrier, or local municipal building, or mechanical code. Refer to the electrical schematic furnished in the manual to determine the specific components in the burner and control circuits.



NOT SHOWN (optional items or items that might be relocated)

CASTERS	Located at the bottom base platform
CONVENIENCE OUTLET 115VAC – 5 amp (optional)	Located to the left of the 115VAC electrical controls. Can be used for sequenced events during system operation
COMBUSTION CHAMBER PRESSURE GAUGE / SWITCH	Located to the right of the 115VAC electrical controls. Can be used to monitor and control operation based on combustion chamber back pressure.

460VAC CONTROLS

The 460 VAC control enclosure section contains the main power disconnect switch, the supply air blower motor control and the 115 VAC control transformer.

VARIABLE FREQUENCY DRIVE / BLOWER SPEED CONTROL

Otherwise known as a VFD, is located inside the 460 VAC control enclosure section. This drive will change the electrical frequency sent to the supply air blower motor to control the air flow volume in the combustion chamber.

LINE REACTOR

The line reactor is a device located inside the 460VAC control enclosure section and is electrically connected to the output of the VFD. It is used to condition the electrical signal between the VFD and supply air blower motor.

115VAC CONTROL TRANSFORMER

The control transformer is located inside the 460VAC control enclosure section and is used to supply 115VAC to the heater electrical controls. The control transformer has both a double pole 460VAC primary fuse block and a single pole secondary fuse block for protection.

TEMPERATURE & AIR FLOW CONTROLLER *(air flow control is optional)*

Located on the 115VAC enclosure, both the temperature and air flow controllers (may be combined in one unit) are used to define the operating characteristics for the heater. The controllers may be used for step profile control, if equipped (*see the operations manual of the specific control for your system*)

CONTROL SWITCHES & PILOT LIGHTS

The operator interface is located on the 115VAC control enclosure. These switches and pilot lights are used for the following conditions:

1. Main Control Power
2. Blower Operation
3. Pilot Operation (low output)
4. Burners Operation (proportional control)
5. Profile Control Bypass

CONVENIENCE OUTLET (Optional)

This duplex outlet enables the operator to activate additional 115VAC devices during the normal operation of the heating system. Such uses may to activate solenoids, fans or other low current devices. This outlet is capable of supplying 115VAC single phase, 60 Hz at 5 amps.

FLAME MANAGEMENT CONTROL

The flame management control module is located in a special enclosure, directly behind the regulator enclosure. This module begins the trial for burner ignition and monitors the burner flame for acceptable operation. If abnormal or no flame is detected, the flame control module will immediately shut off the gas supply to the burner.

IGNITOR / FLAME SENSOR

The ignitor / flame sensor is located on the outlet of the combustion chamber. It is connected electrically to the flame management controller. It is used to both ignite the fuel gas and to monitor the combustion inside the combustion chamber.

AIR PRESSURE SWITCH

This switch is located inside the 115VAC enclosure and is connected to the combustion chamber with ¼" plastic tubing. It monitors the presence of air pressure within the combustion chamber.

AIR FLOW MONITOR

The supply air flow monitor is a device located in the air measurement tube, just inside the chassis. It measures the speed of air at the blower inlet through differential pressure calculations.

GAS SOLENOIDS

The gas train containing the gas solenoids is located in a separate enclosure, directly to the right of the operator controls. These solenoids control the flow of fuel to the burner.

PROPORTIONAL GAS CONTROL SOLENOID

The proportional gas control solenoid is located on the bottom portion of the gas train. This solenoid controls the flow of fuel to the main burner based on the signal received from the temperature controller. The proportional gas control solenoid has an onboard signal conditioner. This signal conditioner is used to translate the signal from the temperature controller to a voltage signal used by the solenoid.

C. COMBUSTION SYSTEM

The combustion system consists of the main combustion chamber and the gas fired burners (pilot & main), located inside the combustion chamber.

COMBUSTION CHAMBER

The combustion chamber is the stainless steel tube mounted inside the chassis and extending outside of the chassis. It is constructed of a high-temperature, stainless steel alloy (T-304).

PILOT BURNER

The pilot burner is a high pressure, fixed orifice, venturi style and is designed to operate with very little air flow (3 psi delivery pressure) to a system maximum pressure (30 psi delivery pressure) depending upon the amount of supply air.

D. AIR SYSTEM

The air system consists of the supply air delivery blower and associated air supply ducting. The air supply system may be either provided by Burners, Inc. and sized to the required specifications, or may be provided by the customer. This manual will outline typical systems provided by Burners, Inc.

BLOWER, HIGH FLOW – LOW PRESSURE (460VAC)

This type of blower is referred to as a regenerative style blower and is typically located directly under the main heater chassis, but may be relocated next to the main chassis, if required. The blower discharge is coupled to the supply air inlet on the combustion chamber with a flexible air supply hose. This style of blower requires the 460VAC electrical enclosure for proper operation.

BLOWER, LOW FLOW – HIGH PRESSURE (460VAC)

This type of blower is referred to as rotary-vane style blower and is typically located directly under the main chassis, but may be relocated next to the main chassis, if required. The blower discharge is coupled to the supply air inlet on the combustion chamber with a flexible air supply hose. This style of blower requires the 460VAC electrical enclosure for proper operation.



WARNING - The rotary-vane style blower can produce extremely loud noise levels. Proper hearing protection must be used when operating this type of blower.

E. GAS SYSTEM

The gas system consists of the fuel supply components installed on the gas train, located on the gas flow adjustment area. These components can be adjusted by opening the door on the upper right side of the operator controls.

PILOT PRESSURE REGULATOR – LEFT

The pilot burner gas delivery pressure can be adjusted from the control knob located inside the gas flow control area. This setting is used to control the minimum temperature (gas flow) desired.

MAIN BURNER REGULATOR – RIGHT

The main burner (proportional control flow) gas delivery pressure can be adjusted from the gas flow control area. This setting is used to control the maximum temperature (gas flow) desired.

CHAPTER 2

Installation

A. LOCATION

 **WARNING** - The heater must be located in an area away from all combustible vapors, fumes and dusts. This unit produces live flame and operates well above the ignition temperature of most combustible material. Extreme care must be taken in selecting a safe area for this heater to operate in.

 **CAUTION** – *While optional shop casters may be supplied with your heater, provisions for securing the heater to a stationary fixture must be incorporated into the installation of the equipment.*

The vertical height of the heater discharge may be adjusted by loosening the clamps and manually raising / lowering the combustion chamber. This operation is done more easily and safely with two or more people.

 **NOTE** – It is recommended that a consumable hot gas delivery pipe be attached to the hot gas discharge of the heater. Typically the pipe is constructed of stainless steel and is approximately 48” in length. Over time, this pipe will degrade, due to excessive and rapid heating and cooling therefore must periodically be replaced.

 **CAUTION** – *It is important to remember that when attaching the heater to a system or part that is subject to any movement, you must install a flexible connector between the heater and the system or part. The flexible connector should be made of a suitable material and design that is intended for extremely rapid and high heating conditions. Also, it is very important to isolate or dampen any vibration that might travel back from the system or part before it can affect the heater.*

 **NOTE** – It is strongly recommended that a high temperature, anti-seizing compound be applied to all threaded piping and connectors used on the hot gas routing. The anti-seizing compound should be rated for at 2000° F (1100° C)

B. SUPPLY AIR CONNECTION

If your heater was purchased without a supply air blower option, it will be necessary for you to secure a suitable air source.

Refer to the electrical schematic furnished in this manual for the electrical interlock circuits associated with the blower circuit.

C. ELECTRICAL CONNECTION

FOR 460VAC UNITS – If your furnace is a 460VAC type, it will be necessary to connect it to an appropriate electrical source. This should only be done by a qualified industrial electrical contractor.



WARNING – Failure to correctly connect this heater to an appropriate electrical source may cause equipment damage and serious personnel injury.

IMPORTANT – For proper electrical supply requirements, please refer to the data label affixed to the heater.

A wire feed hole is provided in the 460VAC electrical control enclosure section for the electrical supply wiring. If no feed hole is provided, or a larger hole is required, you may drill a new hole into the 460VAC electrical enclosure.

IMPORTANT – Be certain that there are no electrical components interfering with the proposed new wire feed hole location. Also, be certain that no metal filings are allowed to come into contact with any of the components inside the 460VAC electrical control enclosure.

D. GAS CONNECTION

The “HG” series heaters are designed to operate on either vapor LPG (propane) or vapor natural gas with a fuel supply delivery pressure of at least 20 psig but no greater than 200 psig.

IMPORTANT – Refer to the data label affixed to the heater for the correct fuel type.

The vapor fuel supply must wither by hard piped with approved gas pipe & connections, or routed through an approved hose. All connections must be leak checked prior to every use.



WARNING – Failure to use an approved fuel delivery line or hose can result in a fuel leak, which could lead to a fire or an explosion. ***ALWAYS USE AN APPROVED FUELED DELIVERY LINE OR HOSE.***

All gas connections should only be performed by a qualified industrial mechanical contractor and leak checked before EVERY use.

CHAPTER 3

Starting & Operation

A. PREPARATION FOR START UP

When installation is complete and all air, electrical, and fuel connections are made, make certain that all connections are tight and secure. The operator should become familiar with both the operation of the heater and of the system or part being connected to it. Also, make certain that the system or part being connected to the heater is properly secured, attached and isolated from the heater.

B. HEATER START UP

To begin operating the heater, follow the steps outlined below, in sequential order. If you cannot successfully complete a step, DO NOT CONTINUE the startup process, terminate the operation and shut off all electrical and fuel supply to the heater, refer to the ADJUSTMENTS section of this manual.

 **WARNING** – The following steps will produce extremely hot discharge gases. Verify that the flow of this extremely hot gas will not harm anyone or anything.

1. Turn the 460VAC main disconnect to the ON position.
2. Turn the fuel supply valve to the ON (or inline) position.
3. Turn the CONTROL POWER selector switch to the ON position.
4. Allow the Temperature & Air Flow controllers to complete a self-check.
5. If applicable, set your desired supply airflow set point into the airflow controller.
6. Set the desired supply temperature set point into the temperature controller.
7. To begin supply air flow, turn the BLOWER switch to the ON position.
8. Allow the airflow to stabilize.
9. Make sure Temperature Control Selector is set to “Single SP”
10. To begin burner operation, turn the PILOT SELECTOR switch to the ON Position.
11. Allow the temperature to stabilize. If the temperature stabilizes above your desired set point, you should lower setting on the pilot regulator adjustment knob.
12. To begin temperature control, turn the MAIN BURNER selector switch to the ON position.
13. Allow the temperature to stabilize at the desired set point. It may be necessary to adjust the main burner regulator-adjusting knob in order to achieve and maintain your desired set point.

TEMPERATURE PROFILE CONTROL

If you desire to use the temperature profile capability (if applicable) of your heater system, please refer to the operations manual for the controller installed in your heater.

Make sure Temperature Control Selector Switch is set to "Profile".

Profile Events

E3 – Turn on burner system

E4 – Activate Air Flow auxiliary set-point (Au SP)

E5 – Energize 115VAC outlet (if equipped)

C. HEATER SHUT DOWN

After you have finished using the heater, you must shut down the heater in the proper order.

IMPORTANT – Failure to follow the proper shut down procedure may result in equipment failure.

1. Shut OFF the main fuel supply source.
2. Allow the heater to burn off all remaining fuel in the fuel delivery line or hose.
3. Wait for the heater's PILOT and BURNER pilot lights to turn OFF.
4. Turn OFF both the PILOT and BURNER selector switches.
5. Allow the blower to continue to operate for at least 15 minutes.
6. Turn OFF the fuel valve on the heater.
7. Turn OFF the BLOWER selector switch.
8. Turn OFF the MAIN POWER selector switch.
9. Turn OFF the MAIN 460VAC disconnect switch.
10. Turn OFF the electrical supply source.

 **WARNING** – The hot gas piping and attached system or part may still be very hot. Be certain to secure the area around the furnace to avoid any accidental personnel contact with these hot components.

CHAPTER 4

Adjustments

A. GENERAL

While each heater is tested at the factory for correct operation before shipment, variable conditions may require further adjustment after installation to assure maximum operating efficiency.

Prior to placing the heater into initial service, a complete inspection should be made of all controls, connections, piping and wiring to ensure that no damage or mis-adjustments occurred during shipping or installation.

B. PHYSICAL ADJUSTMENT

Verify secure and there is no visible damage to any component on the test furnace.

C. ELECTRICAL ADJUSTMENT

The only electrical adjustments that can be made on this heater are controller based (i.e. – the PID & calibration of the temperature and air flow controllers, and the VFD control). In order to adjust these items, please refer to the operators' manual associated with the device.

D. AIR FLOW ADJUSTMENT

Depending on the type of supply air blower, typically there are no adjustable components. If re-calibration of the air velocity sensor is required, it may be due to a scaling problem within the airflow controller. If the scaling values are correct, the air velocity sensor must be factory serviced. Consult Burners, Inc.

E. FUEL FLOW ADJUSTMENT

Minor temperature window adjustments can be accomplished by simply raising or lowering both the pilot or main burner regulator adjusting knobs inside the fuel flow control enclosure area can accomplish minor temperature window adjustments. If the proportional gas control solenoid requires re-calibration, refer to the operations manual associated with this solenoid (typically - Burkert type 1094).

CHAPTER 5

Maintenance

A. GENERAL

A maintenance program avoids unnecessary down time, costly repairs, and promotes safety. It is recommended that a record be maintained of daily, weekly, monthly and annual maintenance activities.

 **WARNING** – Only qualified personnel should ever be allowed to maintain, service, or repair this heater system.

 **WARNING** - *Unusual noises, improper gauge readings, leaks, loose connections, signs of overheating, etc. can indicate a developing malfunction or problem. If any of these types of conditions occur, discontinue use and notify a supervisor immediately to schedule a corrective action*

B. AIR SUPPLY MAINTENANCE

DAILY – Inspect the supply air duct for leaks or cracks (REPLACE)

DAILY – Inspect wiring to the blower motor (REPAIR)

WEEKLY – Clean off air filter media (SERVICE)

MONTHLY – Grease all grease fittings on the blower motor (SERVICE)

ANNUAL – Have motor windings checked (SERVICE)

C. ELECTRICAL MAINTENANCE

DAILY – Inspect all wiring for loose connections (REPAIR)

WEEKLY – Inspect ignitor/flame sensor (REPLACE)

BI-MONTHLY – Replace ignitor/flame sensor

ANNUAL – Inspect all electrical components and connections (SERVICE)

D. GAS MAINTENANCE

DAILY – Inspect fuel delivery line and hose for loose connections (REPAIR)

DAILY – Inspect fuel delivery line and hose for cracks and leaks (REPAIR/REPLACE)

ANNUAL – Clean out all solenoids (SERVICE)

WARNING: THESE DRAWINGS ARE TO BE USED ONLY IN CONNECTION WITH EQUIPMENT COMPLYING IN ALL RESPECTS WITH THE ORIGINAL EQUIPMENT MANUFACTURER'S SPECIFICATIONS. THE INSTALLER MUST INSPECT THE EQUIPMENT AND ASCERTAIN COMPLIANCE WITH THE ORIGINAL EQUIPMENT MANUFACTURER'S SPECIFICATIONS BEFORE USING THESE DRAWINGS. DO NOT USE THESE DRAWINGS IF THE EQUIPMENT HAS BEEN MODIFIED SUCH USE MAY CAUSE EQUIPMENT FAILURE OR MALFUNCTION, WHICH MAY RESULT IN ELECTRICAL SHOCK OR BURNS OR OTHER SEVERE PERSONNEL INJURY OR PROPERTY DAMAGE. BURNERS, INCORPORATED DISCLAIMS ANY AND ALL LIABILITY FOR ANY SUCH INJURY OR DAMAGE, WHETHER DIRECT, INDIRECT, INCIDENTAL OR CONSEQUENTIAL, RESULTING FROM THE USE OF THESE DRAWINGS IN CONNECTION WITH EQUIPMENT WHICH DOES NOT COMPLY IN ALL RESPECTS WITH THE MANUFACTURER'S ORIGINAL SPECIFICATIONS OR LOCAL CODES, OR COMPLIANCE OR ANY APPLICABLE INSTALLATION GUIDELINES.

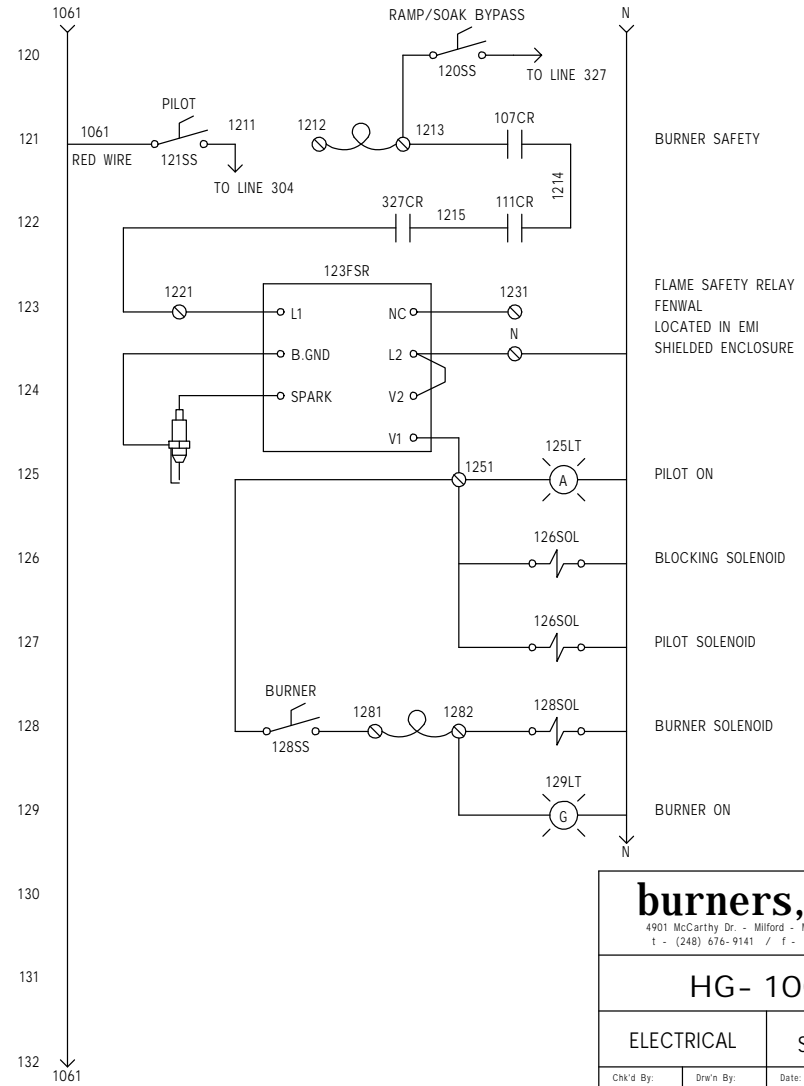
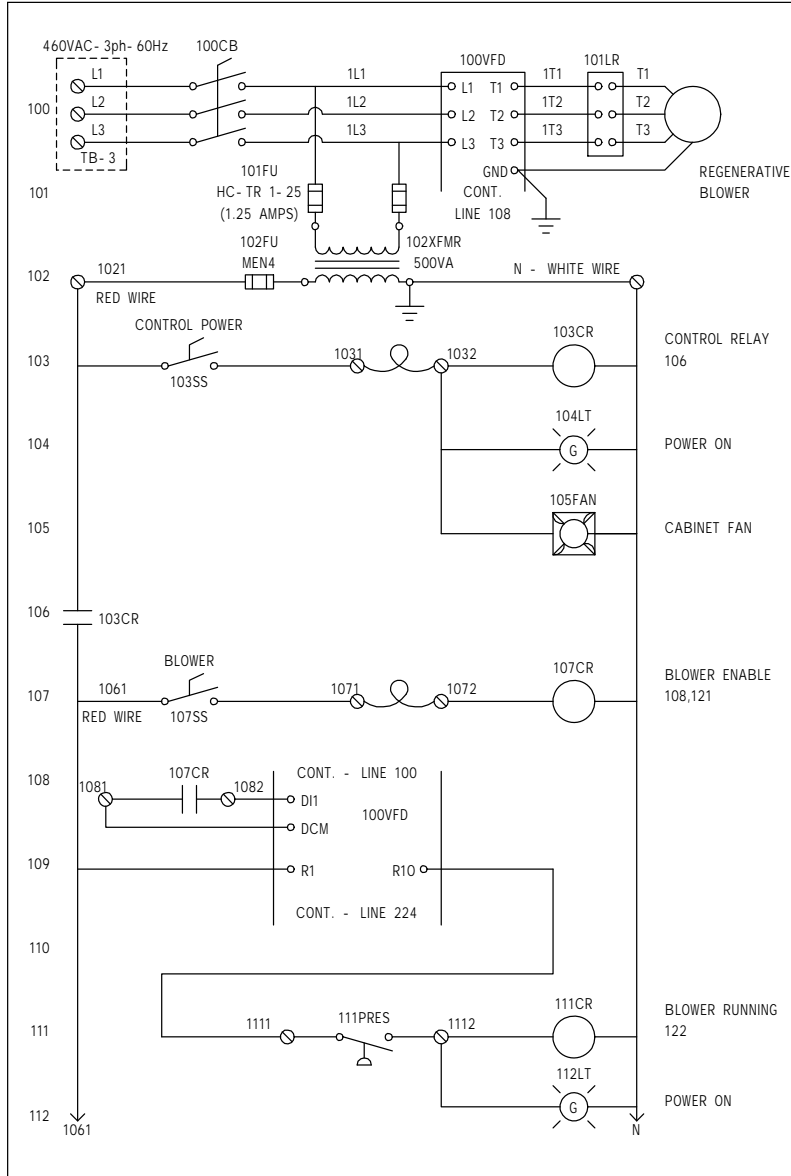

burners, inc.
 4901 McCarthy Dr. - Milford - Michigan - 48381
 t - (248) 676-9141 / f - (248) 684-4475

HG - 1000

ELECTRICAL		SCHEMATIC	
Chk'd By: SMB	Drw'n By: rjb	Date: 10/11	Page: EL-01

WARNING: THESE DRAWINGS ARE TO BE USED ONLY IN CONNECTION WITH EQUIPMENT COMPLYING IN ALL RESPECTS WITH THE ORIGINAL EQUIPMENT MANUFACTURER'S SPECIFICATIONS. THE INSTALLER MUST INSPECT THE EQUIPMENT AND ASCERTAIN COMPLIANCE WITH THE ORIGINAL EQUIPMENT MANUFACTURER'S SPECIFICATIONS BEFORE USING THESE DRAWINGS. DO NOT USE THESE DRAWINGS IF THE EQUIPMENT HAS BEEN MODIFIED SUCH USE MAY CAUSE EQUIPMENT FAILURE OR MALFUNCTION, WHICH MAY RESULT IN ELECTRICAL SHOCK OR BURNS OR OTHER SEVERE PERSONNEL INJURY OR PROPERTY DAMAGE. BURNERS, INCORPORATED DISCLAIMS ANY AND ALL LIABILITY FOR ANY SUCH INJURY OR DAMAGE, WHETHER DIRECT, INDIRECT, INCIDENTAL OR CONSEQUENTIAL, RESULTING FROM THE USE OF THESE DRAWINGS IN CONNECTION WITH EQUIPMENT WHICH DOES NOT COMPLY IN ALL RESPECTS WITH THE MANUFACTURER'S ORIGINAL SPECIFICATIONS OR LOCAL CODES, OR COMPLIANCE OR ANY APPLICABLE INSTALLATION GUIDELINES.

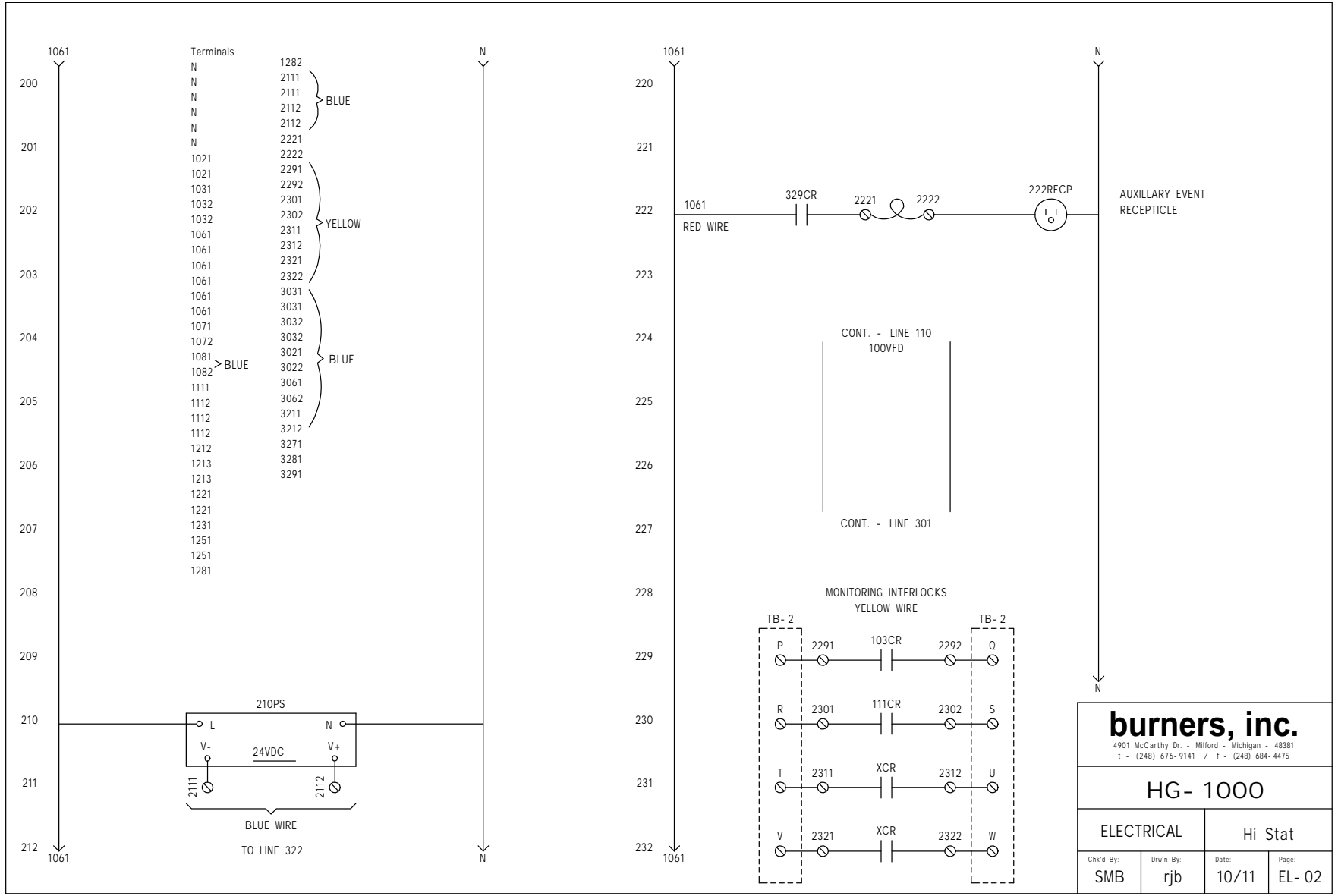

WARNING : THESE DRAWINGS ARE TO BE USED ONLY IN CONNECTION WITH EQUIPMENT COMPLYING IN ALL RESPECTS WITH THE ORIGINAL EQUIPMENT MANUFACTURER'S SPECIFICATIONS. THE INSTALLER MUST INSPECT THE EQUIPMENT AND ASCERTAIN COMPLIANCE WITH THE ORIGINAL EQUIPMENT MANUFACTURER'S SPECIFICATIONS BEFORE USING THESE DRAWINGS. DO NOT USE THESE DRAWINGS IF THE EQUIPMENT HAS BEEN MODIFIED. SUCH USE MAY CAUSE EQUIPMENT FAILURE OR MALFUNCTION, WHICH MAY RESULT IN ELECTRICAL SHOCK OR BURNS OR OTHER SEVERE PERSONNEL INJURY OR PROPERTY DAMAGE. BURNERS, INCORPORATED DISCLAIMS ANY AND ALL LIABILITY FOR ANY SUCH INJURY OR DAMAGE, WHETHER DIRECT, INDIRECT, INCIDENTAL OR CONSEQUENTIAL, RESULTING FROM THE USE OF THESE DRAWINGS IN CONNECTION WITH EQUIPMENT WHICH DOES NOT COMPLY IN ALL RESPECTS WITH THE MANUFACTURER'S ORIGINAL SPECIFICATIONS OR LOCAL CODES, OR COMPLIANCE WITH ANY APPLICABLE INSTALLATION GUIDELINES.

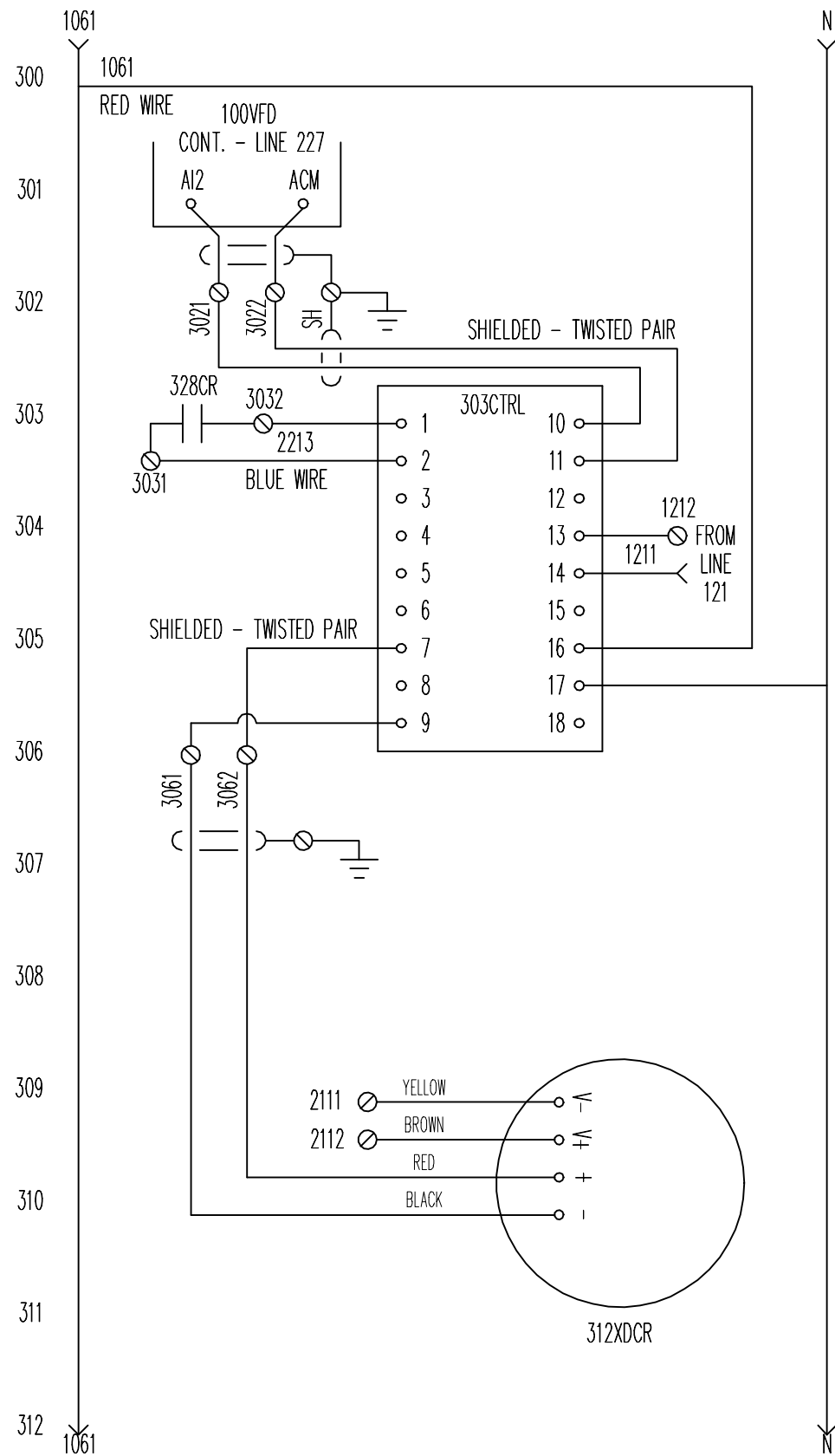

AIR FLOW CONTROLLER

DIFFERENTIAL PRESSURE TRANSDUCER DWYER
 DH3-004 (0-1"WC)
 used w/ 6" x 4" venturi for 350 scfm
 DH3-006 (0-5"WC)
 used w/ 6" x 4" venturi for 850 scfm

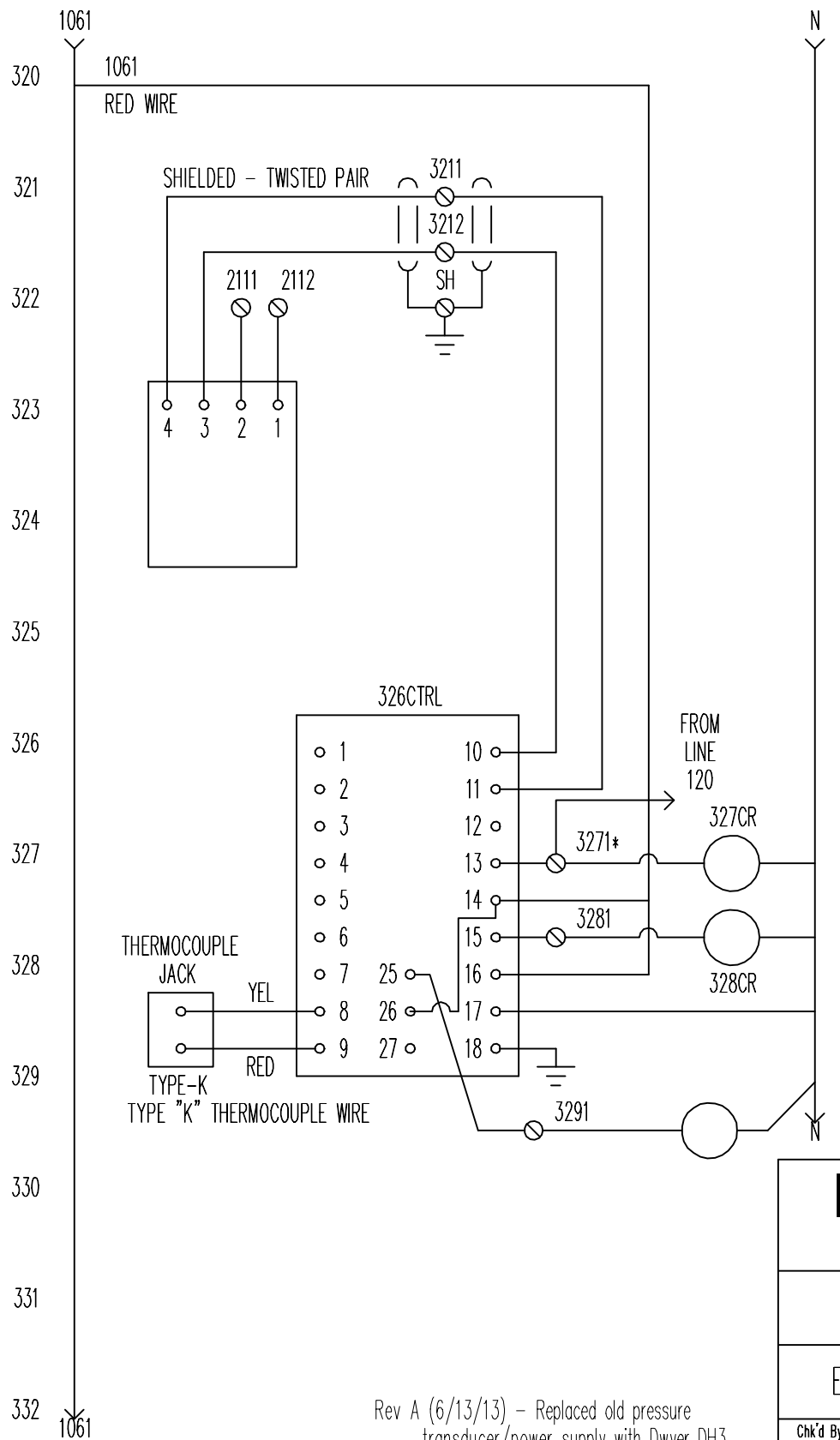

PROPORTIONAL CONTROL GAS SOLENOID

TEMPERATURE CONTROLLER

BURNER ENABLE 122

EVENT 4 ENABLE (AUX AIR FLOW SP) 303

Rev A (6/13/13) - Replaced old pressure transducer/power supply with Dwyer DH3

burners, inc.
 4901 McCarthy Dr. - Milford - Michigan - 48381
 t - (248) 676-9141 / f - (248) 684-4475

HG-1000

ELECTRICAL		SCHEMATIC	
Chk'd By: SMB	Drw'n By: rjb	Date: 10/11	Page: EL-03