

---

# LEATHERCRAFT

---

A Pacific Northwest Extension Publication  
Oregon • Washington • Idaho  
PNW 132 • Reprinted October 1998

# Contents

<b>BEGINNING LEATHERCRAFT</b>	
Tools	3
<b>Basic Skills</b>	
Designs	5
Carving and Stamping	6-15
Finishing Leather	16
Lacing	16-23
Attaching Snap Buttons	24
<b>ADVANCED LEATHERCRAFT</b>	
Tools	25
Ways to Decorate Leather	28
How to Filigree	30
<b>Basic Skills</b>	
Hand and Machine Stitching	32
Skiving	33
Border Lines	34
Edging Belts, Etc.	34
Burnishing the Edges	34
Folds	34
Cementing Stiffeners in Place	36
Installing Hardware	36
Cementing the Lining	38
Instructions for a Lady's Purse	40
Making a Basic Design	42
Figure Carving	45
Dyeing Leather	47
<b>IDEAS</b>	
Hints and Tips on Buying and Cutting Hides	52-53
Demonstrations	53
Coin Purse	54
Billfold	55
Letters	56

---

The original bulletin was developed under the guidance of John A. Kiesow, formerly Extension Specialist, 4-H—Youth and revisions by Duane P. Johnson, State 4-H leader, Oregon State University. This circular was adapted from material prepared by Mrs. Ruth Moe of the State 4-H Department, University of Wyoming. Special acknowledgment is given to the Tandy Leather Company for information and illustrations, and to Harold Starr and Mrs. Patricia Hitchcock, a 4-H volunteer leader. Other information was obtained from "General Leathercraft," by Raymond Cherry; "Leathercraft," by James A. Schwalbach, University of Wisconsin; "Leather Art," by F. O. Baird; and "Lucky Seven," by the Craftool Company. This circular may not be sold without permission from the Tandy Leather Company and others who have provided material for free use by the 4-H program.

# Beginning Leathercraft

There are a good many tools that are needed to do good leather work. However there are many that are only needed once in awhile, so if you go together in your club and buy tools that everyone can use, it will be less expensive. Those tools marked with an asterisk are those which each member should have.

- \*1. Pencil
- \*2. Masking tape or paper clips
- \*3. Tracing paper (or light-weight sheet plastic)
- \*4. Block of marble about 10" to 12" square and an inch or so thick
- 5. Pine cutting board
- 6. Small can Neat-lac or other finish (or saddle soap or wax)

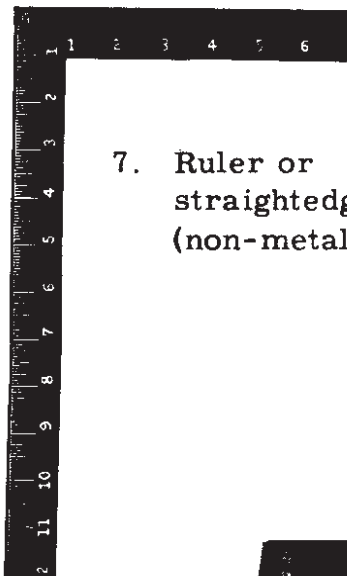

7. Ruler or straightedge (non-metallic)



8. Scissors



9. Cutting knife

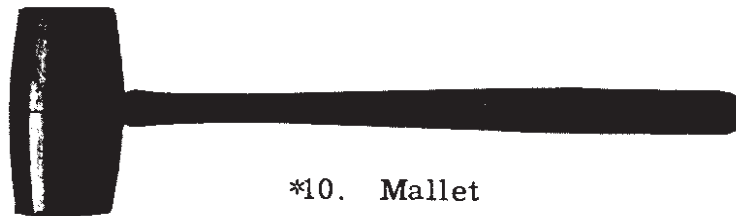

\*10. Mallet



11. Thonging Chisel  
(Use single prong for corners)

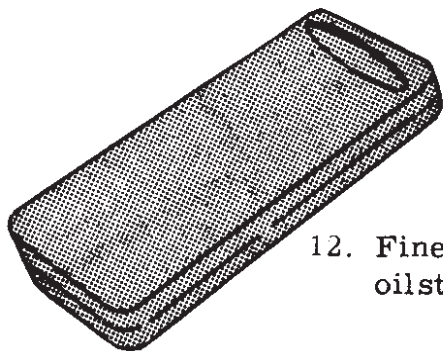

12. Fine-grit oilstone

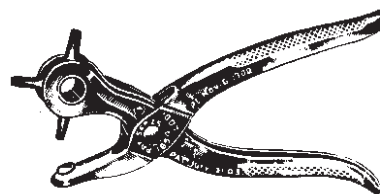

13. Revolving punch

14. Sponge



15. Swivel knife

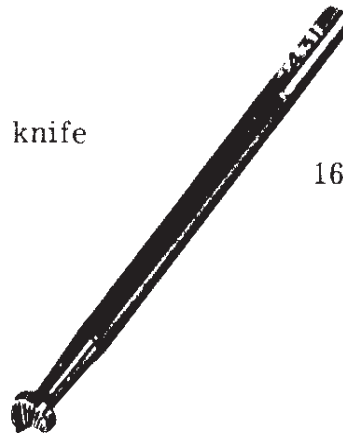

16. Stamping tools

(Your swivel knife and stamps should be kept in a container which will prevent them from knocking together and getting dull. Either a wooden frame with the right-sized holes or a cloth sewed into compartments may be used.)



17. Rubber cement

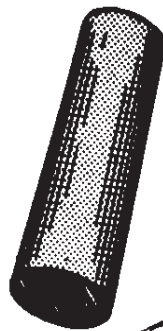

Jeweler's rouge

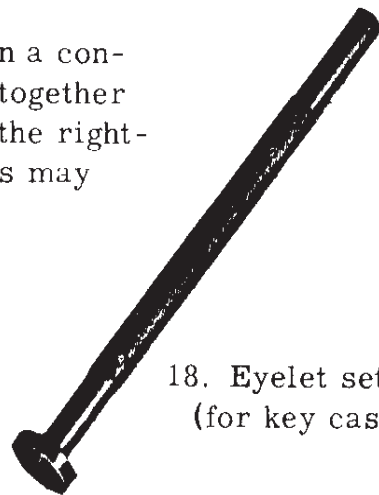

18. Eyelet setter  
(for key case)



19. Jeweler's rouge strap

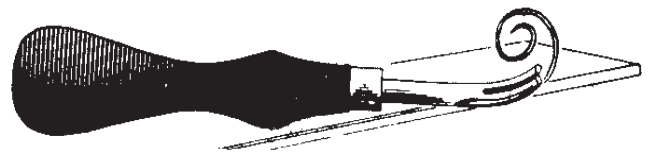

20. Edge beveler (use for beveling edges of belt or dog collar)

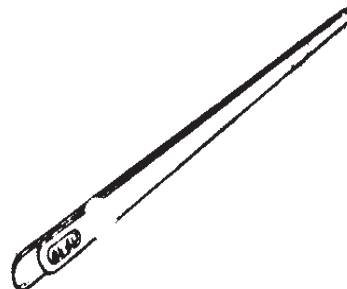
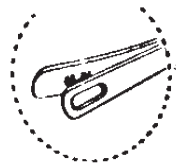

21. Lacing needle



If you are clever with a pencil it will be nice to make your own designs. However, to begin your leather work there are a few designs included in this book; and you may get others from leather stores.

### Tracing Your Design

After you have decided what you want to make, find a design that you like (or make one). Be sure that it fits the space that you want to put it on. If there is lacing to be done, be sure to leave a three-eighths-inch border between your design and the edge.

Trace your design on thin paper--or a thin plastic sheet works real well. Do not trace anything except the main outlines. Do not include the "decorative cuts". (See page 15) Lay your design directly on the leather.



## THE SWIVEL KNIFE



The swivel knife is the most important tool used in leather carving, and it is very important that it be kept sharp. Keep a sharpening stone handy and a strap of cowhide impregnated with jeweler's rouge. Get in the habit of "stropping" your swivel knife every time you pick it up. The rouge strap is prepared by applying neatsfoot oil on a small strap which is then rubbed with a stick of jeweler's rouge.

### Description

The swivel knife consists of three main parts:

1. The saddle: the curved piece of metal fastened at the top in such a manner that it will turn on the rest of the knife, creating a swivel action.
2. The barrel: the cylindrically shaped piece of metal with the saddle attached at one end and the blade at the other.
3. The blade: the piece of metal at the bottom of the knife with the cutting edge at one end and attached to the barrel at the other.

### How to Hold

The knife is held with the end of the forefinger lying in the saddle and the barrel held near the bottom between the thumb and 2nd and 3rd fingers. The side of the little finger rests on the leather to aid in guiding the knife. The knife is tipped away from the body, leaving the back corner of the blade resting on the leather to do the cutting. The broad side of the blade is held so that it is straight up and down.

## How to Cut

Place the leather on your work table so that the design is up. Hold the swivel knife as it tells you above; place the cutting point at the beginning of one of the traced lines. Draw the knife toward your body, following the curves in the line by turning the barrel with the fingers. The pressure on the knife is gradually released at the end of the cut, resulting in a taper. The cuts are made in sections when going around sharp curves in the design.

The leather is turned after each cut so that the next cut will be made toward the body.

Each time you stop (in the middle of a curve), be sure to place the blade back a ways when starting again so that the cut will continue in the same smooth flow.

If the knife has been held straight, the cuts will be wedge shaped. If it has been leaned to either side the result will be an undercut.

Cut this way



WEDGE CUT

Don't cut this way



UNDERCUT

## Practice Design

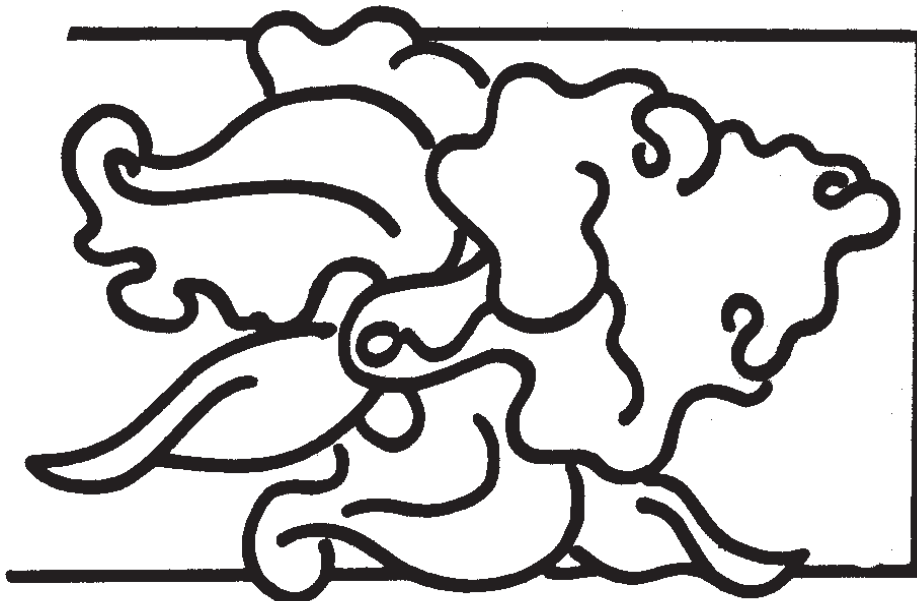

by Ken Gregson

## THE SHADE TOOL

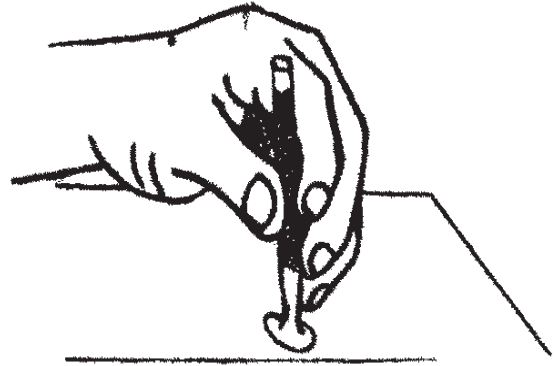

### Description

The shader is a stamp tool with the working end shaped like a raindrop. There are several different kinds, but a medium size with a smooth surface is good to start with.

### Purpose

The shader is used to make the dish-shaped impressions in flower petals, leaves, and down the length of fern swirls. These impressions give the appearance of folds and add to the three-dimension effect which is so necessary to make your design look good.

### How to Use

Start the impressions out near the edge of the petals and leaves. Then follow the general contour of the form, staying the same distance from the swivel cuts. The tool is moved slightly as it rebounds after each sharp blow with the mallet. The tapping is gradually lightened as it approaches the camouflage area, giving a dish shape to the impression. The distance between the shaded area and the swivel knife cuts should be from a sixteenth to an eighth of an inch, depending upon the size of the design, but the impression should never extend all the way to the cut.

The rich brown color of the shaded area is obtained by hitting the tool hard and having the leather at the proper moisture content. If the leather seems dry, add more water with a sponge, then let the surface moisture evaporate until the leather turns to near its natural color. A marble block or some other hard, smooth surface is a necessity for good shading.





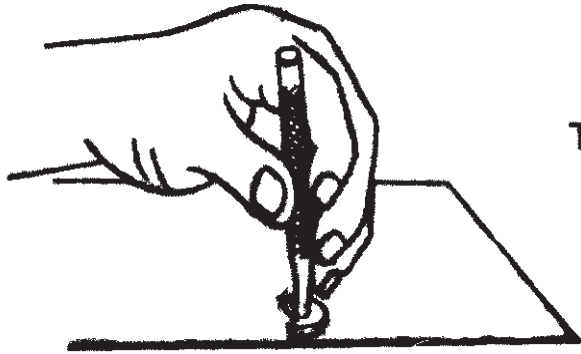

## THE CAMOUFLAGE TOOL

### Description

The camouflage is a crescent-shaped tool with evenly spaced lines running out from the inside of the crescent much like sunrays.

### Purpose

The camouflage is used to give stems, flower petals, leaves, and fern swirls a ruffled appearance representing folds and small veins. It may also be used to form flower centers and to end fern swirls.

### How to Hold

The shank is held between the thumb and three fingers. The fingers are spread up the length of the shank to furnish support. The side of the little finger rests on the leather as the tool is moved after each tap with the mallet.

### How to Use

Leaves and Stems. The impressions are started at the bottom of the leaf or stem. The tool is lifted after each tap with the mallet and placed just above the previously made impression. The space between impressions should be uniform. The tap of the mallet is gradually lightened as the tool approaches the top of the leaf. Any marks made on the outside of the stem will be removed later with the beveler.

Flower Petals. The impressions are started at the center of the flower. The tool is worked toward the outside of the petal.

Fern Swirls. The tool is leaned to one side as it is tapped, up and around the swirl. It is spaced evenly and tapped uniformly.



## THE VEINER

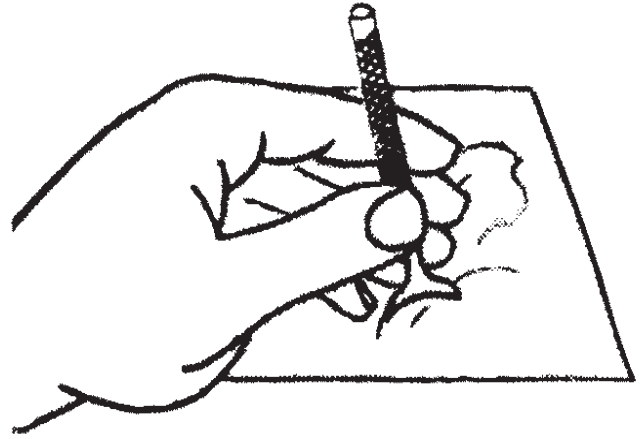

### Description

The working end of the veiner is crescent shaped (like a moon).

### Purpose

The veiner is used to form the veins branching from the center ribs of large leaves. It is also used around the edge of fern swirls and to make folds in the petals of flowers.

### How to Use

The veins are formed in the leaves by starting at the stem end and working toward the tip. The length of the vein is controlled by tilting the tool, using only a part of the crescent to form the desired impression. Place the end of the tool in the center cut of the leaf with the open side of the crescent toward the stem and extending away at about a 45 degree angle. The tool is spaced evenly as it is moved along the leaf after each tap with the mallet. It is tilted less to form longer veins in the wider parts of the leaf.



Your veiner impressions should look like this.

The impressions up and around the fern swirl are made by using only the tip end of the crescent. They should point toward a common center as the tool is tapped around the swirl. The tip end is also used to stop dead-end cuts.

Hold the veiner flat to form the folds in flower petals. The impressions are spaced evenly and gradually decreased in depth as they radiate from the seed pod.

## THE BEVELER

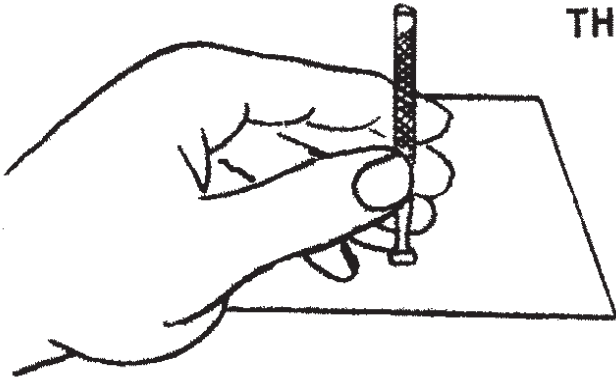

### Description

The working end of the beveler is almost flat, with the surface slightly rounded and slanted. A medium size with a smooth surface is usually the best with which to start.

### Purpose

The beveler is used to knock down one side of each swivel knife cut, giving a three-dimensional effect to the design. The less prominent parts of the design are knocked down to make them appear to be further in the background.

### How to Use

The side of the little finger rests on the leather to steady the tool and keep the leather from sliding. The high edge of the beveler is held in the swivel knife cut and moved about one-fourth the distance of its width as it rebounds slightly after each tap with the mallet. Hold the face of the beveler straight with the cut and against the side left standing. The leather is turned in such a manner as to leave the high side of the beveler facing the body.

Lay the side of the little finger in place on the table. Then place the high edge of the beveler in the cut about one inch in front of the little finger. Move the beveler slowly toward the little finger after each tap with the mallet. Repeat this until the cut has been beveled along its entire length.

A bumpy appearance to the beveled area is an indication that the beveler has been moved too far after each tap with the mallet, or it has not been held straight. Rough places in the beveling may be smoothed down somewhat by going over it.

Determine which part of the design should lie on top, then bevel down around it. Generally the flowers, the main stems, and the more prominent leaves are left standing.



## THE MULE'S FOOT

### Description

The mule's foot is V shaped.

### Purpose

It is used under dead-end cuts and to decorate stems.

### How to Use

Like the seeder, the moisture content of the leather should be low.

For decorating stems, start at the top, tilting the tool toward the flower with the point of the V downward. Strike the tool firmly and decrease the depth of the impressions as it is worked down the stem.

For ending dead-end cuts, one or more impressions are tapped in just below the end of the cut with the point of the V downward.

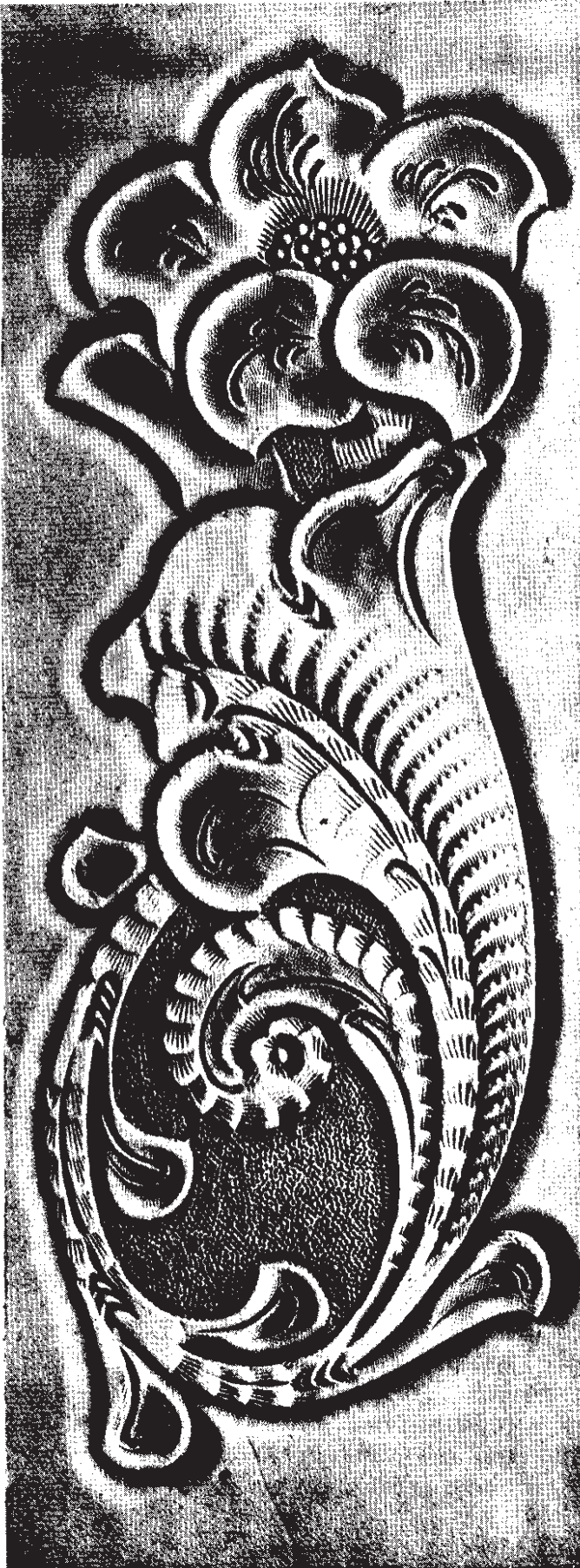

Billfold design—illustrating use of mule's foot, seeder and other stamping tools.

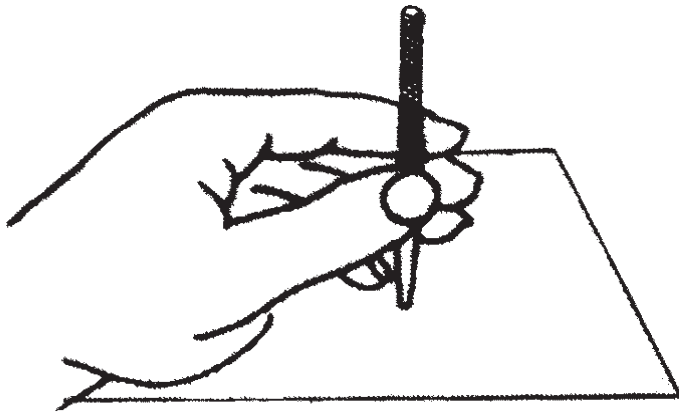

## THE SEEDER

### Description

The end of the seed tool has a concave surface which leaves a dome-shaped impression in the leather.

### Purpose

The seeder is used to fill in the seed pods of flowers, at the junction of flower and stem, and in the center of fern swirls.

### How to Use

The leather being worked should not be very damp. Use a beveler or large camouflage to stamp the leather down around the top of the seed pod. Tilt the seeder slightly toward the top of the flower to give the seed pod a rounding appearance. Then tap in the first row of seeds. Hit the tool just hard enough to force the leather up in the concave surface, leaving a rounded top to each seed. If the seeds are flat on top, the tool is not being hit hard enough. The seeds should barely touch at the edges but not overlap. Hold the seeder straight to fill in the remainder of the seed pod.

The seed tools used in the center of fern swirls and at the junction of flowers and stems are usually much larger than those used to fill in the seed pod and will require a harder lick with the mallet. The larger tools will also have a tendency to bounce and leave a double impression. The bouncing may be prevented by holding the tool low and pressing it down. Tap the tool lightly with the first lick, then follow up with one or two heavier blows with the mallet.

Small seed tools are sometimes used as background tools. They are used on large belts and other designs adaptable to a coarse background.



Belt design, showing use of seeder.

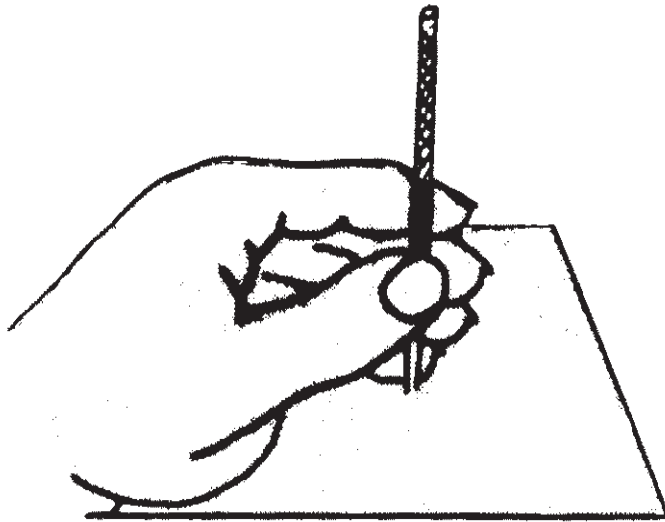

## THE BACKGROUND

### Description

The background tool comes in various sizes, and the one to use depends on how big a space there is to cover and on how small a corner you need to get into.

### Purpose

It is used to tap down the area around your leaves, flowers, and swirls so they will stand out.

### How to Use

The tool is held straight up and down with the side of the little finger resting on the leather and the other three fingers stacked on top to make a spring action, causing the tool to rebound after each tap with the mallet. Move the background tool evenly and tap with a uniform lick of the mallet to obtain a smooth background of uniform depth.

Work the background areas systematically, completing each area before moving to the next.

The working end of most background tools is small; the moisture content of the leather should therefore be very low.

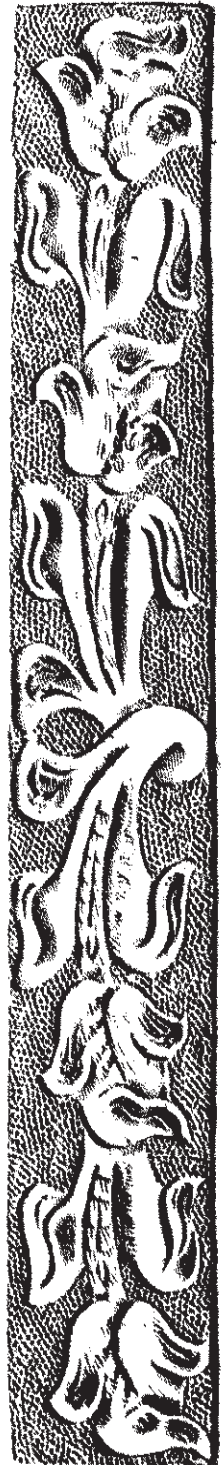

## ORNAMENTAL CUTS

The ornamental cuts are made free hand with the swivel knife and follow the general contour of the leaves, petals, and stems.

It is hard to make your ornamental cuts smooth, so practice quite awhile on some scrap leather.

If the leather seems too dry, add more moisture with a sponge and allow the surface moisture to evaporate. (Be sure to go over the entire surface with your sponge so it will not leave water marks.)

Turn the knife in the fingers so the blade is almost parallel to the body, then force the blade deep into the leather, turning the knife sharply as it is pulled toward the body. The pressure on the knife is gradually decreased as the blade approaches the end of the cut.

Practice until you can coordinate the cutting, turning, and releasing of pressure into one movement.



Billfold design showing ornamental cuts and stamping tool impressions.

## LEATHER FINISH

Leather will look better and wear better if it has a coating of some kind put on it. Any finish is best when put on after your carving and stamping are done and before lacing or setting snaps, to keep from getting the leather dirty or smudgy from too much handling.

A weak solution of oxalic acid (one teaspoon to one pint of water) will remove any smudges or fingermarks from the leather. Rinse with a damp sponge and let dry.

Caution: Do not wet too much or you will lose the coloring created by the stamping tools.

When using treating compound or colorless dressings, apply evenly with a circular motion. Cover the surface quickly and evenly. Let it dry and, if too light, apply the second coat.

If liquid wax or saddle soap is used to finish the leather, apply a thin coat. Thick coats turn white and fill up the cuts and tool impressions. When dry, polish to a high lustre with a soft cloth.

## LACING

Calf lacing is the best to use and will come in a variety of shades from tan to dark brown and black. Goat lacing is cheaper and there are more colors. Lacing can be purchased by the yard or by the spool and is of course cheaper to buy by the spool.

The amount of lacing required is:

Whipstitch	1 1/2 times the distance to be laced
Single Cordovan	6 to 6 1/2 times the distance to be laced
Double Cordovan	8 to 8 1/2 times the distance to be laced

The most common lacing used is 3/32 of an inch in width, although other popular widths are 1/16, 1/8, and 3/16.

### Punching the Holes

In preparation for punching the lacing holes, you will need a piece of soft wood to place under your article (which should be placed carved side down). With a pencil, mark a guide line for your punching tool 1/8 of an inch from the



edge all around where your article is to be laced. Then with a razor blade or sharp knife, cut off the corners so they are very slightly rounded.

Using a carpenter's hammer and lacing punch, make holes through the leather along the guide line. Your punch probably has four prongs. After the first series of cuts, place the first prong in the last cut and strike again. Continue this process around your article.

### Lacing Your Article

The easiest way to lace is to use a lacing needle. Work with a piece of lacing 3 to 4 feet long, with one end of your lace inserted into the needle. Lace with the carved side of the article facing you. Drawing the lacing through Bees Wax will make it pull through the leather easier, and save wear on the lacing.

The lacing needle is pointed away from the body when inserting under loops or through holes. It is best to start somewhere along the edge of the project rather than on a corner.

In lacing around the corners or at bends (such as in a billfold) it is advisable to do double lacing through two or three holes.

### Methods of Lacing

There are many ways to lace articles, and 3 ways are shown here: whip stitch, single Cordovan, and double Cordovan.

#### WHIP STITCH

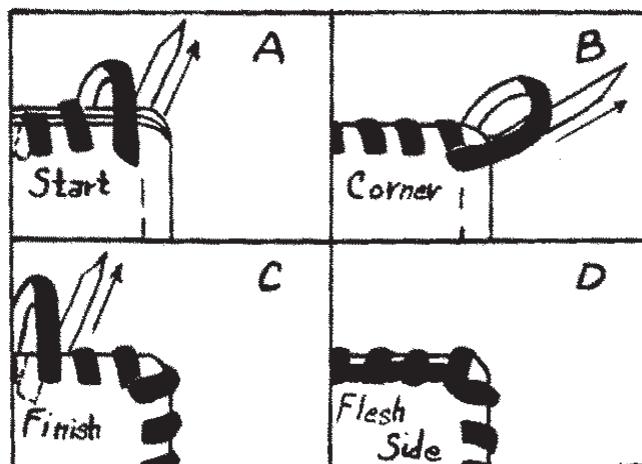

# SINGLE CORDOVAN EDGE LACING

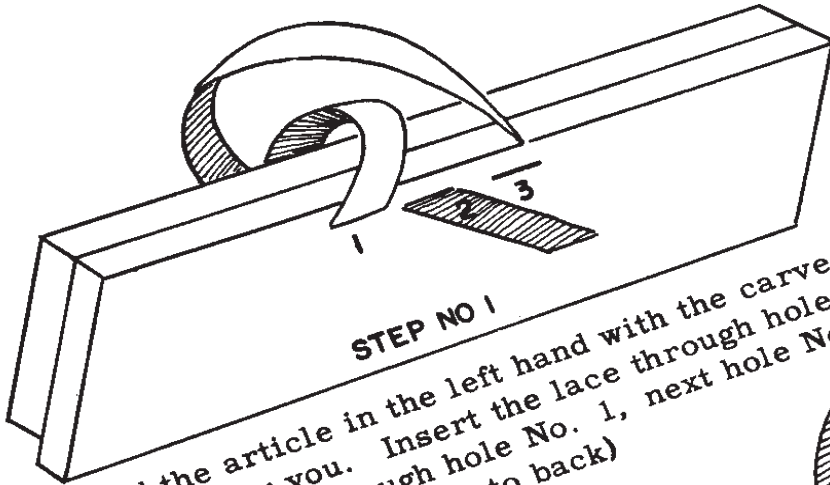

**STEP NO 1**

Hold the article in the left hand with the carved side facing you. Insert the lace through hole No. 2, then through hole No. 1, next hole No. 3 in that order. (Front to back)

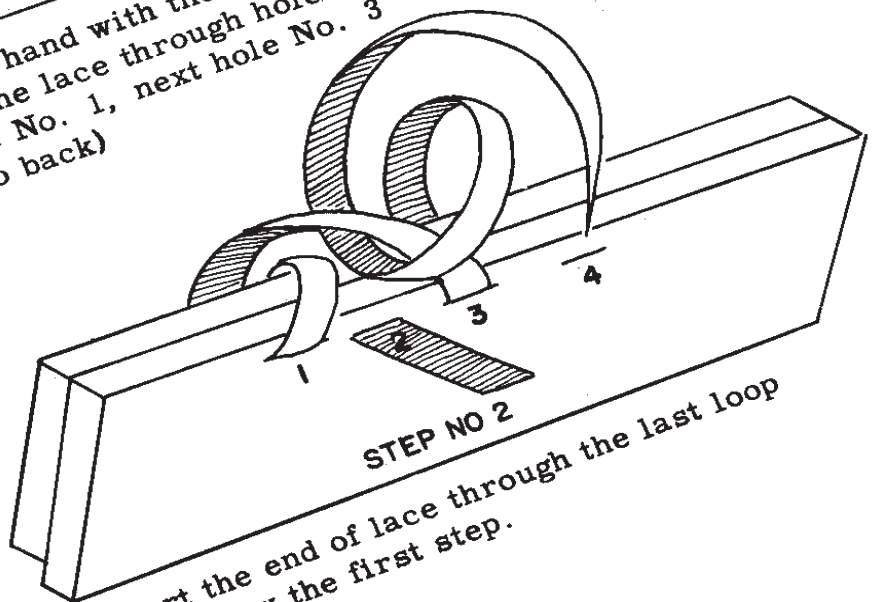

**STEP NO 2**

Insert the end of lace through the last loop formed by the first step.

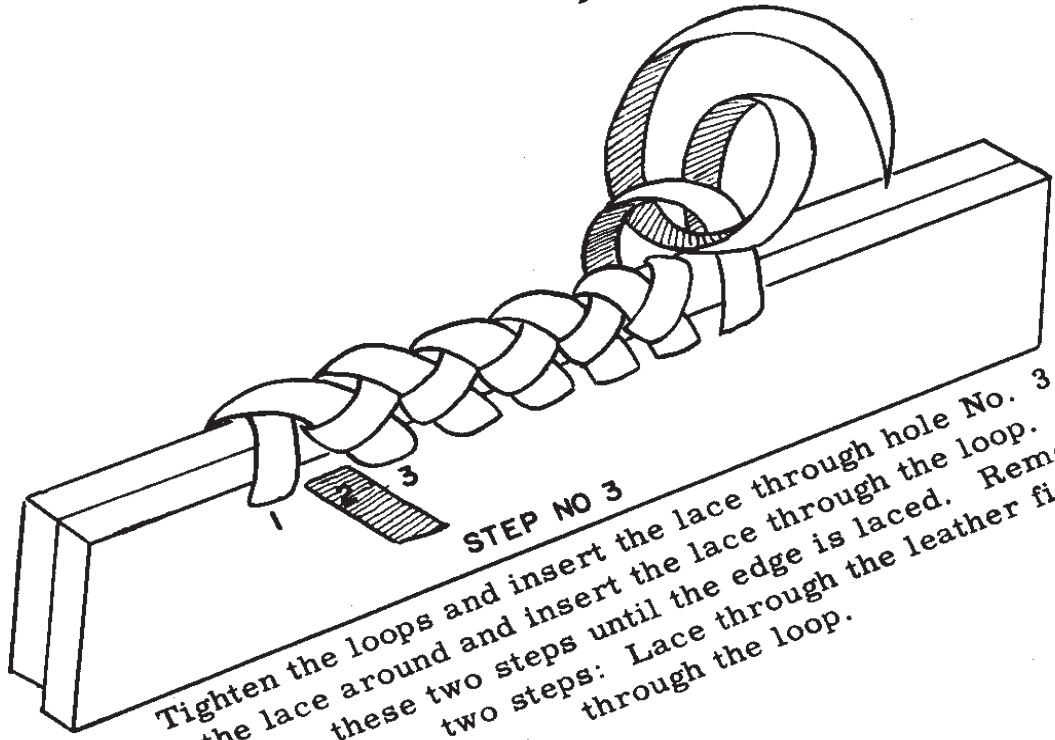

**STEP NO 3**

Tighten the loops and insert the lace through hole No. 3. Bring the lace around and insert the lace through the loop. Continue these two steps until the edge is laced. Remember the two steps: Lace through the leather first, then through the loop.

STEPS IN JOINING SINGLE CORDOVAN LACING

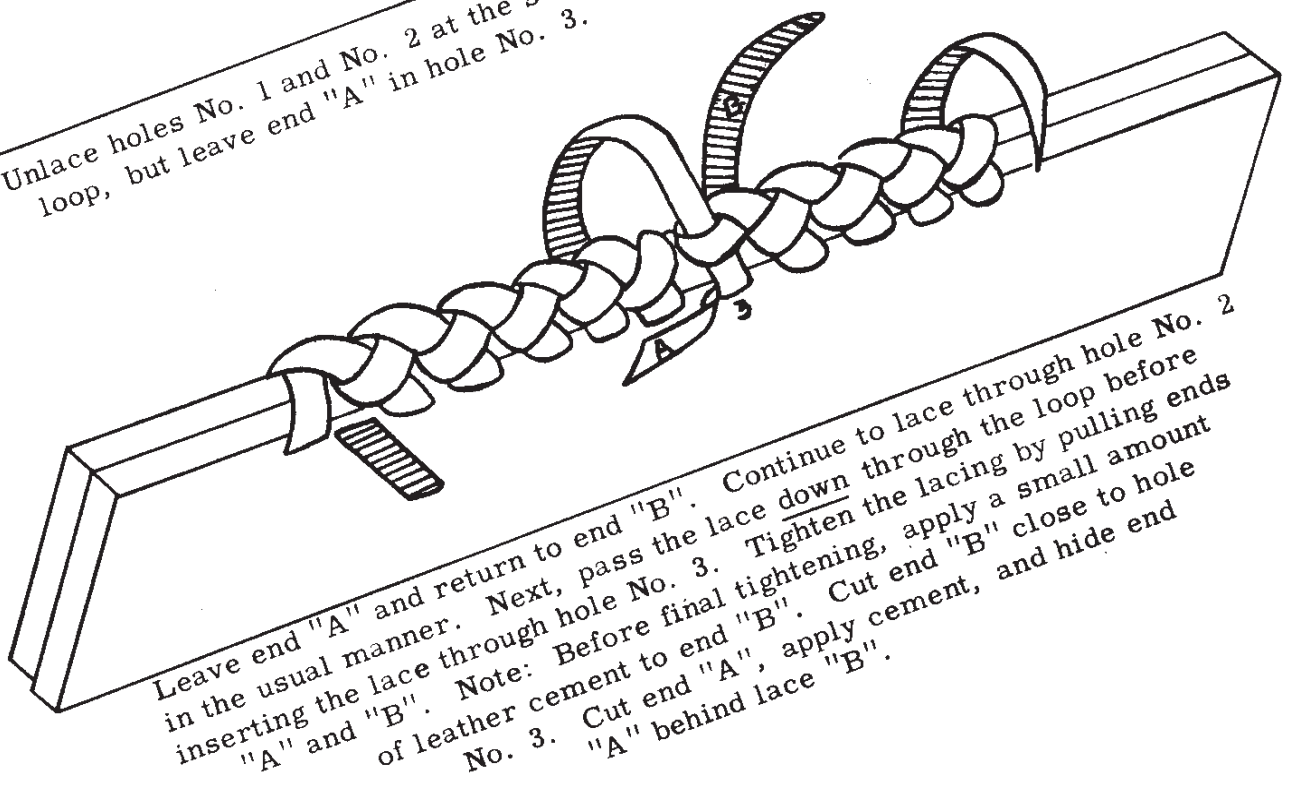
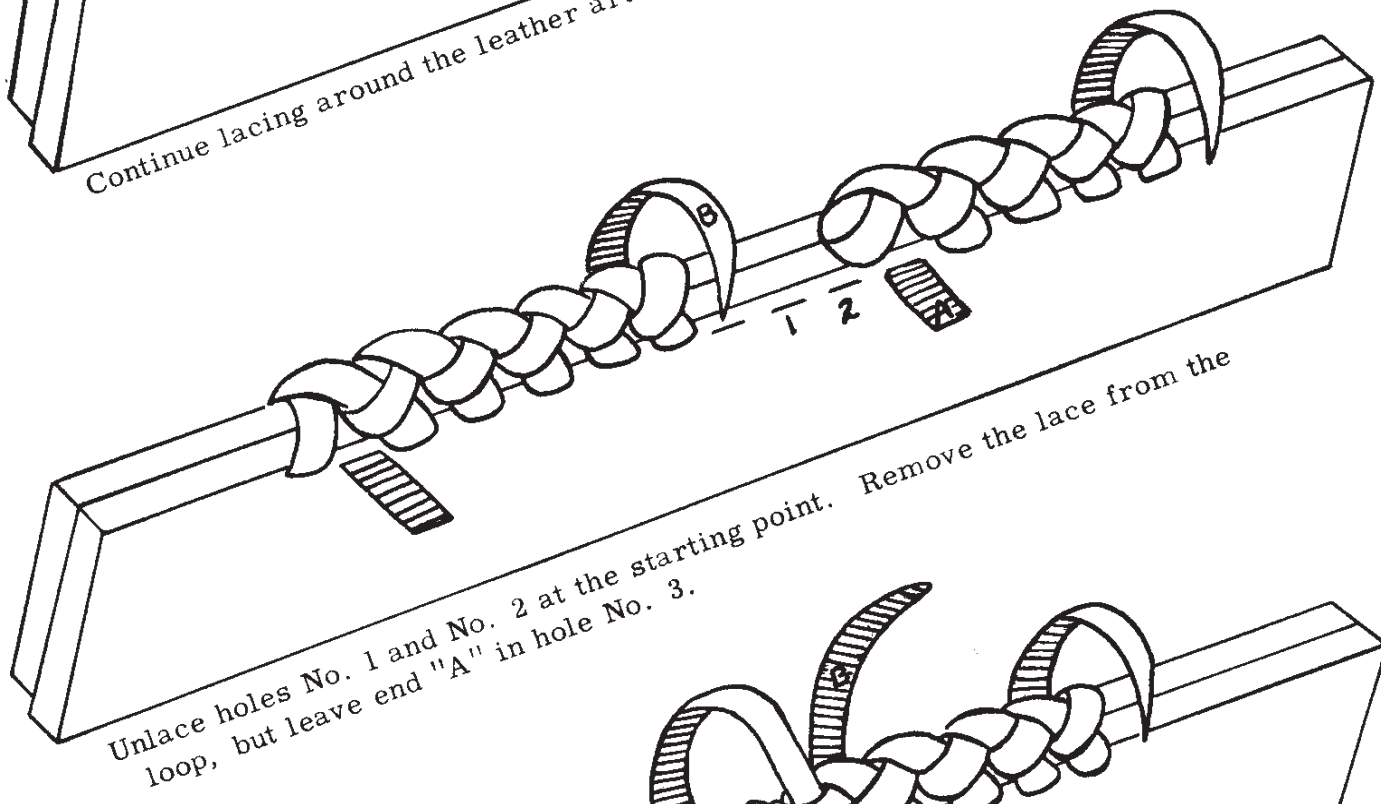
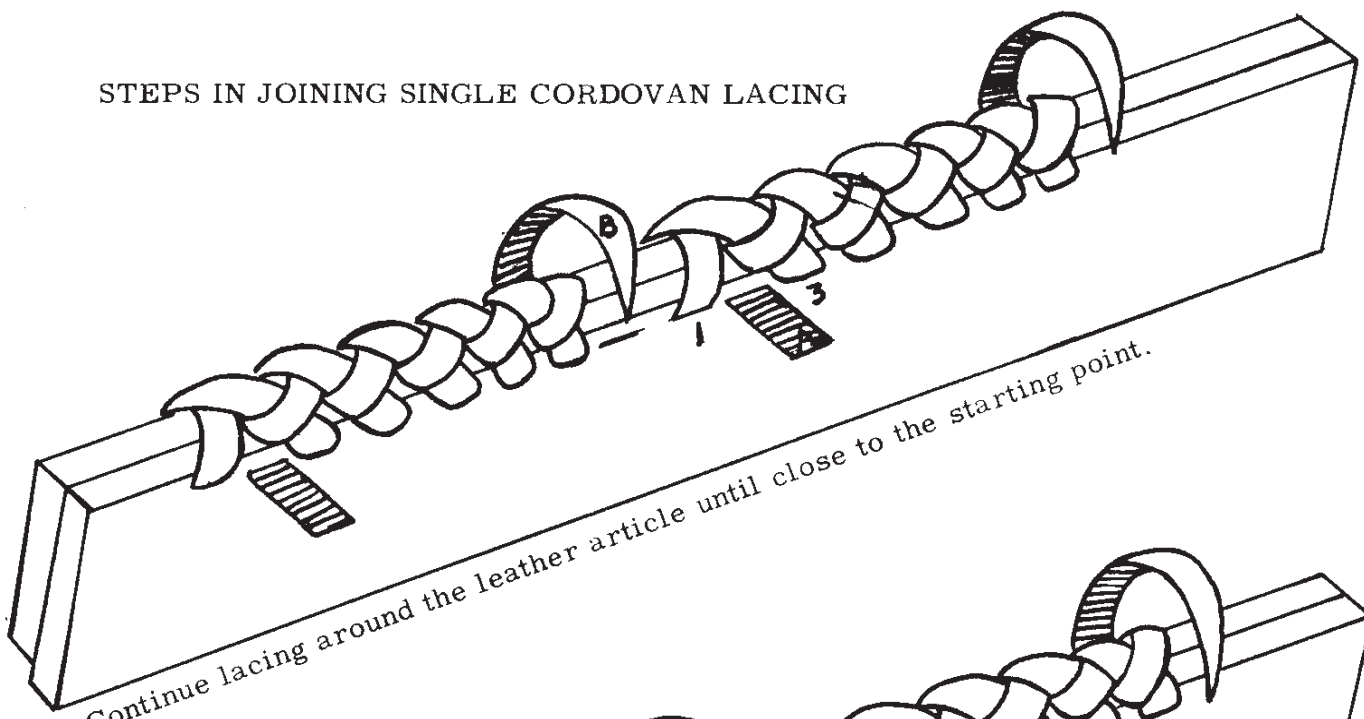

# DOUBLE CORDOVAN EDGE LACING

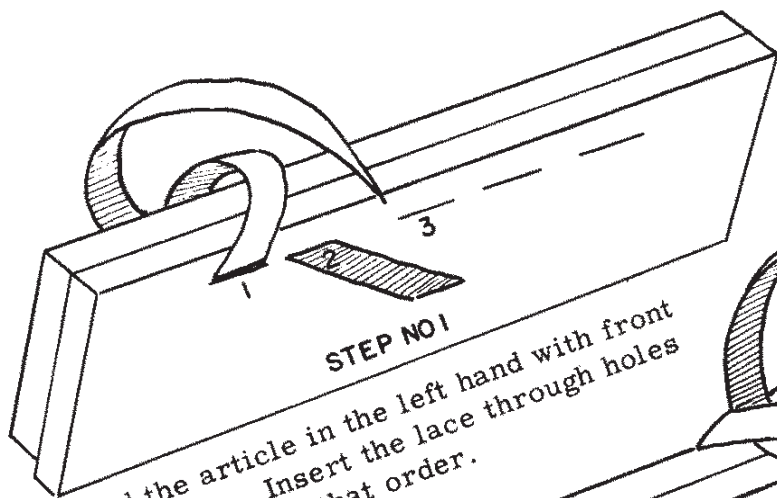

**STEP NO 1**  
Hold the article in the left hand with front facing you. Insert the lace through holes 1, 2, and 3, in that order.

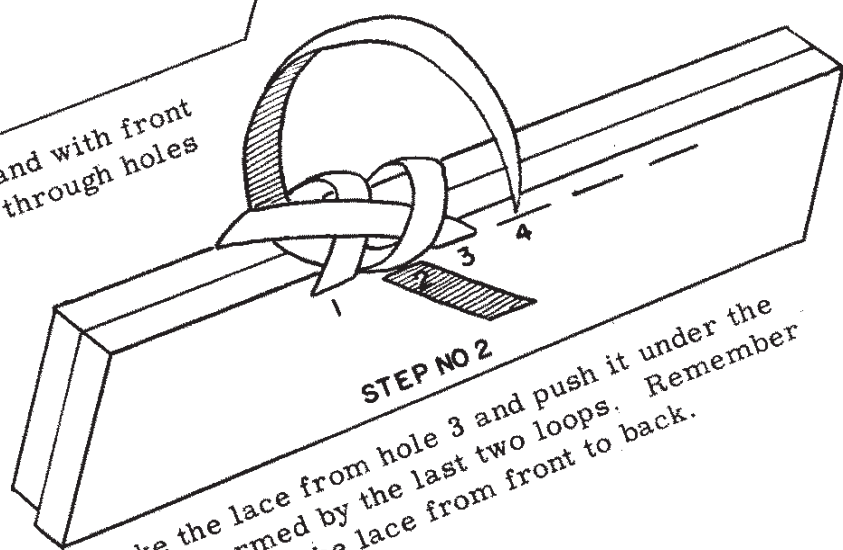

**STEP NO 2**  
Take the lace from hole 3 and push it under the "X" formed by the last two loops. Remember to insert the lace from front to back.

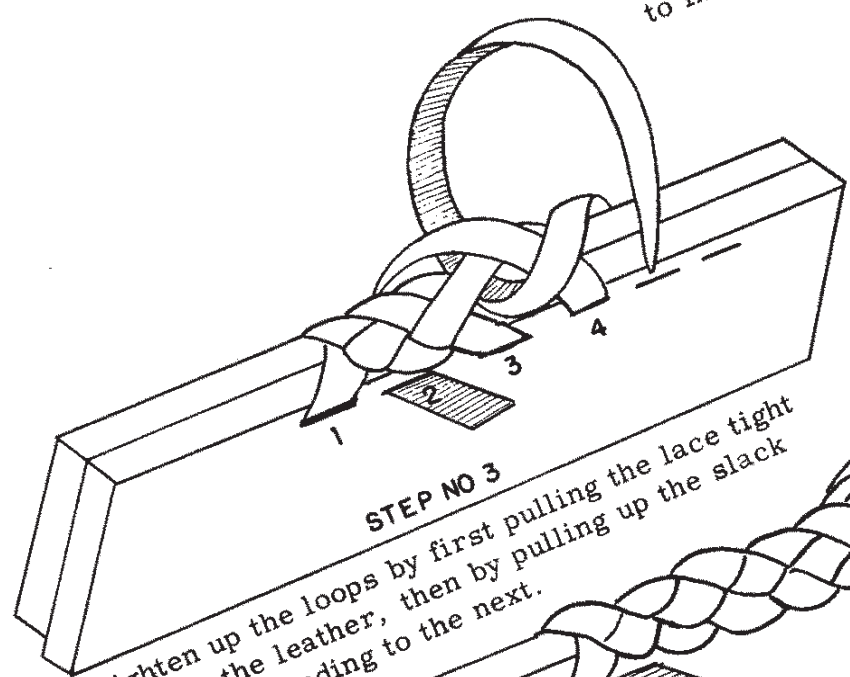

**STEP NO 3**  
Tighten up the loops by first pulling the lace tight through the leather, then by pulling up the slack before proceeding to the next.

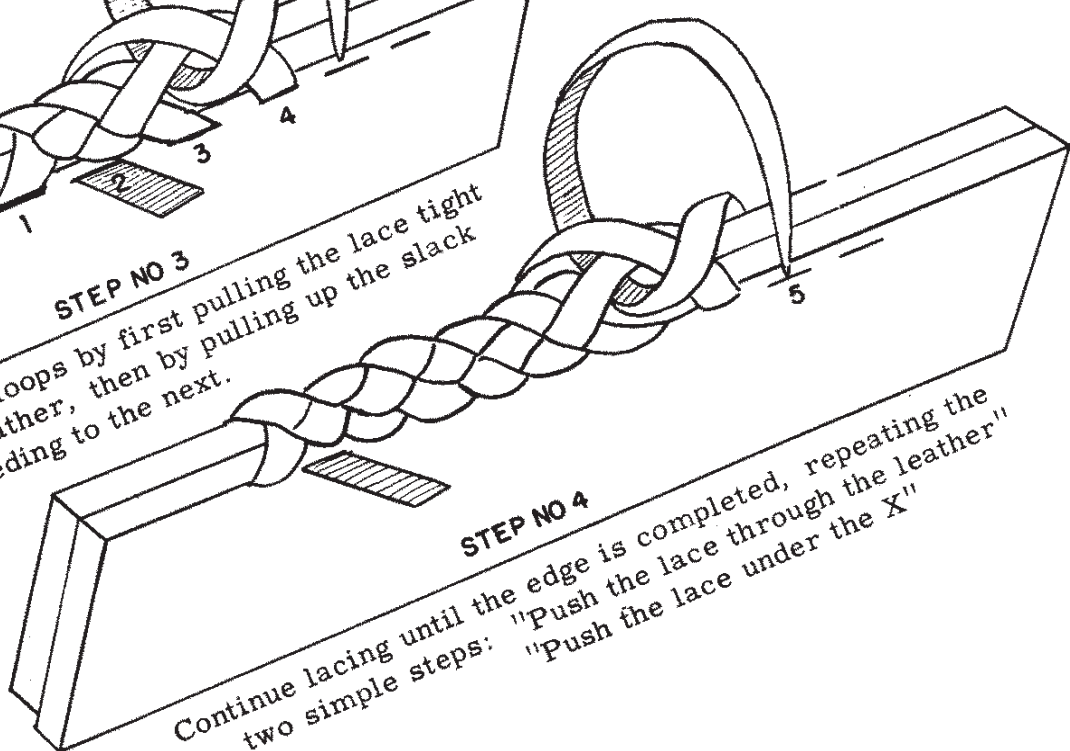

**STEP NO 4**  
Continue lacing until the edge is completed, repeating the two simple steps: "push the lace through the leather" "push the lace under the X"

# STEPS IN JOINING DOUBLE CORDOVAN EDGE LACING

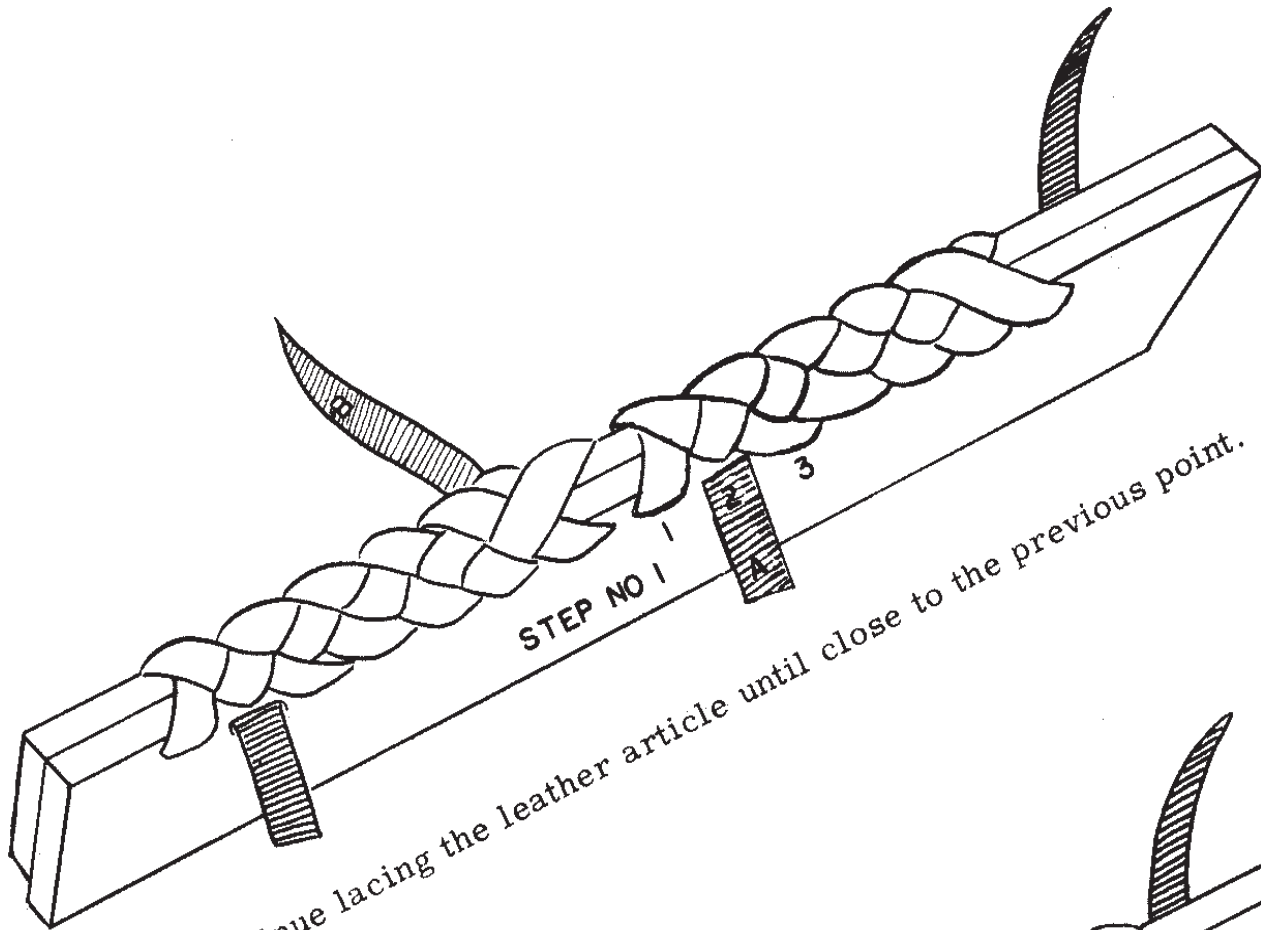

STEP NO 1  
Continue lacing the leather article until close to the previous point.

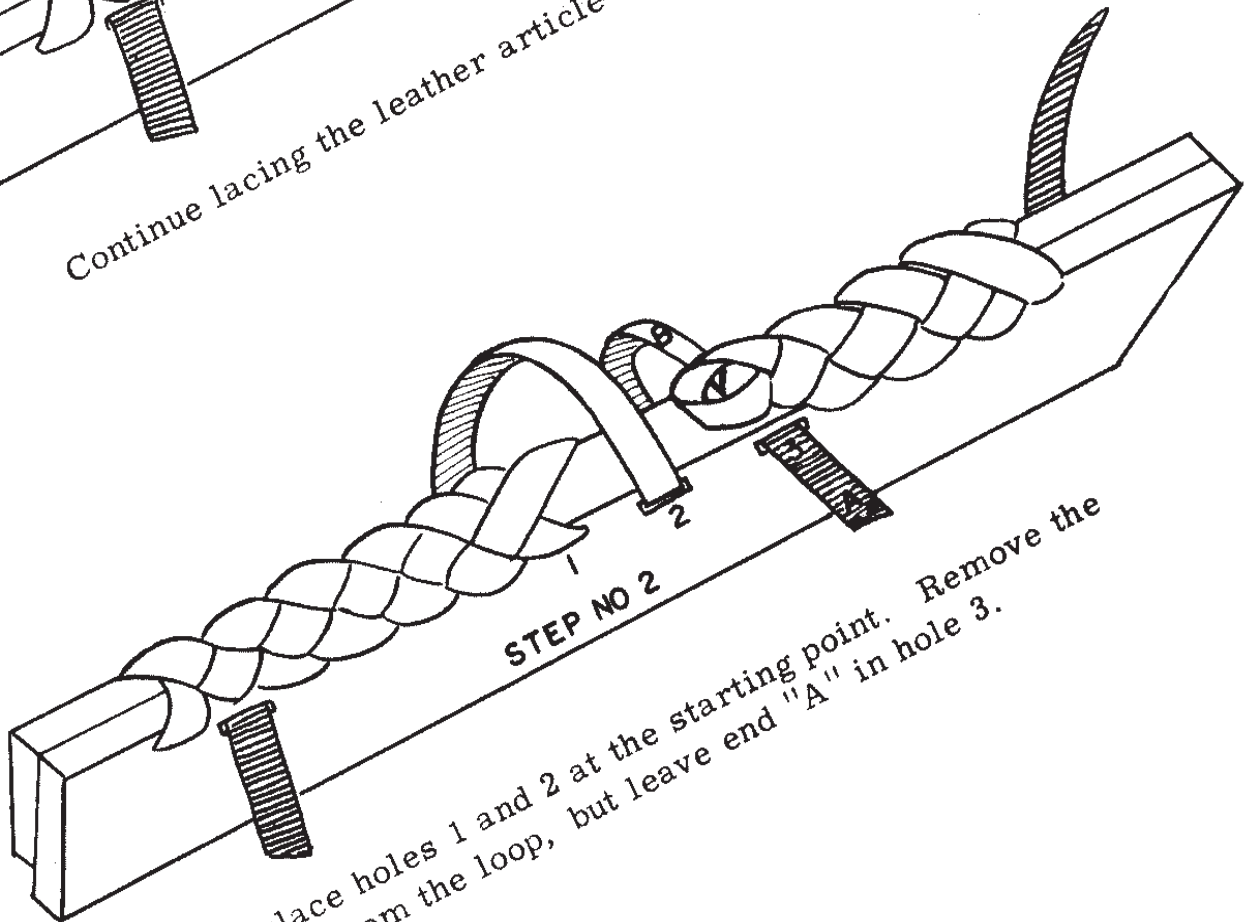

STEP NO 2  
Unlace holes 1 and 2 at the starting point. Remove the lace from the loop, but leave end "A" in hole 3.

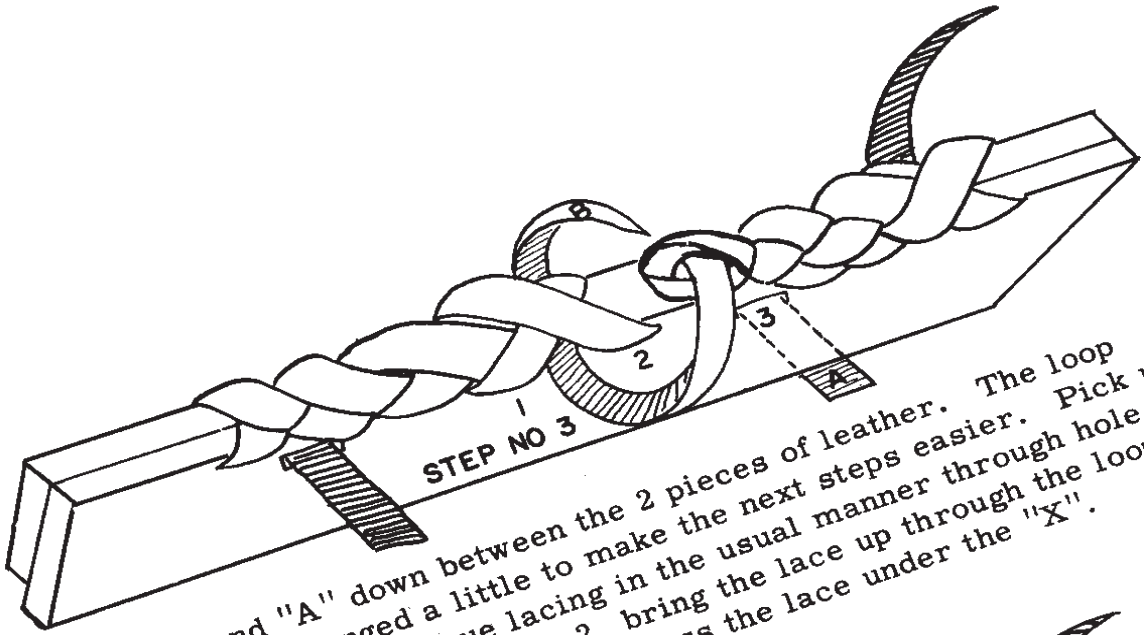

STEP NO 3

Pull end "A" down between the 2 pieces of leather. The loop may be enlarged a little to make the next steps easier. Pick up end "B" and continue lacing in the usual manner through hole 2. After going through hole 2, bring the lace up through the loops from bottom to top and then pass the lace under the "X".

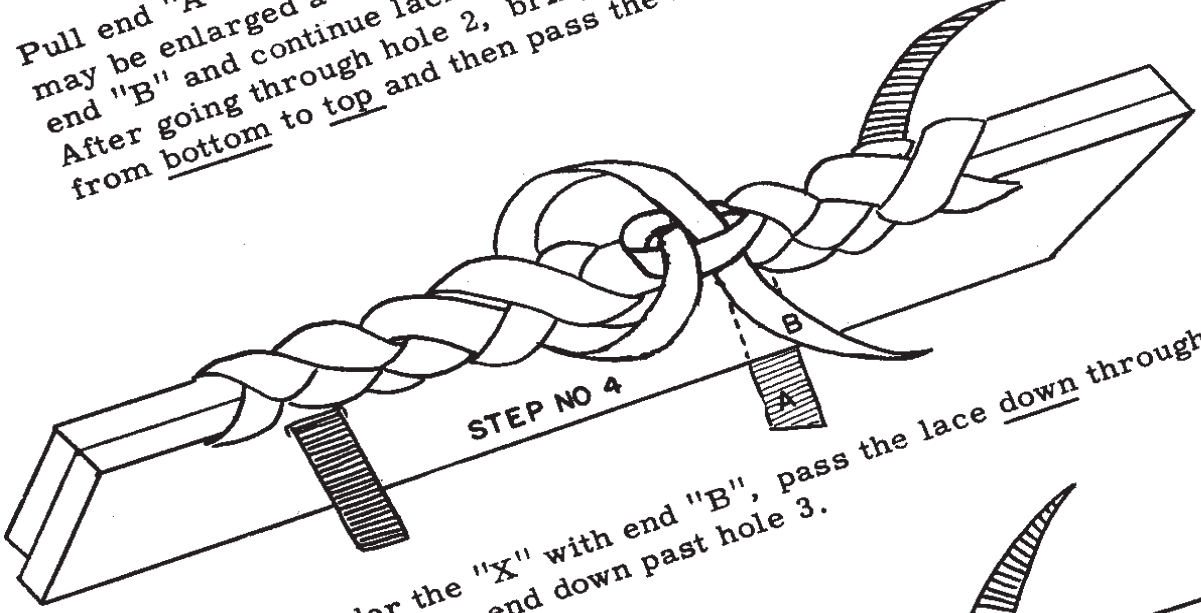

STEP NO 4

After going under the "X" with end "B", pass the lace down through the loop and bring the end down past hole 3.

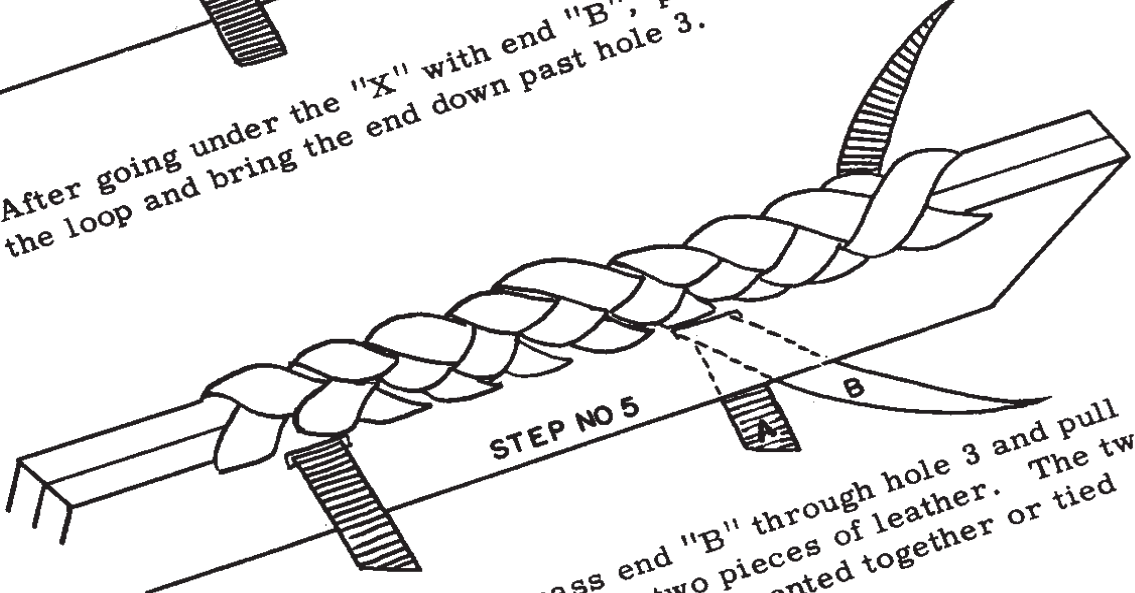

STEP NO 5

Tighten the loops and pass end "B" through hole 3 and pull the slack down between the two pieces of leather. The two ends "A" and "B" may be cemented together or tied into a knot to prevent unlacing.

## SPLICING LACE

### Cementing

Joining a new piece of lacing to the old is called splicing. Remove the needle from the end of the lacing now being used. Then, with a razor blade or sharp knife, thin the end on a slant about  $\frac{3}{4}$  of an inch back. Cut off a new piece of lacing, 4 or 5 feet in length, and thin one end as you did the other piece. Be careful to thin the smooth side of one lacing and the rough side of the other. Thus, when the two ends are glued together, the splice is the same thickness as the lace.

With rubber cement, put a few drops on the thinned end of one piece of lacing and lap the other piece over it. Press together and allow to dry completely. Then continue lacing as before. Be sure that enough cement is used to cover both ends well so that they won't fray.



### Substituting

Step 1. When you see you are about out of lacing lay in an extra lace between the two thicknesses of leather above the lacing holes.

Step 2. Lace over this extra lace four or five more holes until out of lace.



Step 3. Insert the short end of the old lace through the first thickness of leather or about half way and bring up from between the two thicknesses. Bring new lace through hole of the second thickness or the other half.



Step 4. Lay short end of old lace back between the two thicknesses and above lacing holes, and continue lacing with new lace.

When properly done, it is almost impossible to tell where a new lace was added and is much more permanent a method.

## ATTACHING SNAP BUTTONS

### Materials Needed

Snap-button outfit  
Revolving punch



cap



eyelet

### How to Do

1. There are 4 different parts to a snap button-- the cap and eyelet form one unit, and the spring and post form the other.
2. Locate and punch the proper-sized hole for the eyelet. Use a piece of scrap leather to make a test hole to check the size.
3. Insert the eyelet through from the under side of the leather. Lay the eyelet on the anvil of the snap-attaching set with the flesh side of the leather down. Place the cap over the eyelet and the concave part of the hammer of the snap-attaching set on top of the cap. Strike the hammer sharply with a mallet. This will fasten the parts firmly together. Too much force will cut the leather around the eyelet.
4. Locate the hole for the post by aligning all parts and then pressing the cap firmly in position where it is to snap on to the spring. The eyelet will leave an impression, thus locating the position for the spring and post. Punch a No. 1 hole.
5. Insert the post through from the under side of the leather. Lay the post on the anvil and place the spring over the post. The hollow part of the hammer is placed over the spring. Strike the hammer sharply with the mallet. Test the snap button. If it is too loose, lightly tap the spring. If the cap will not close over the spring, loosen the spring by lightly compressing it with a pair of pliers.



spring



post

### How to Set Buttons and Attach Buckle on Belt

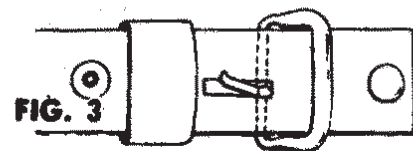
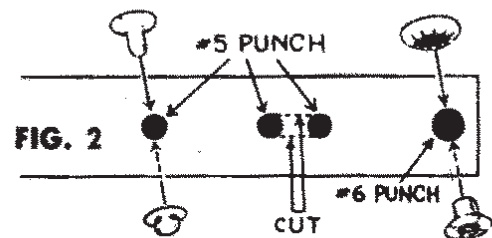



# Advanced Leathercraft

Many leather tools were designed for a special purpose or to make a special job easier. If you plan to do a lot of leather work it will pay to get some of these special tools in addition to those you needed for Unit I. Some which are handy to have are:

**Skiving Knife** (For skiving leather)



**Beveled Edge Skiving Knife** (Used mostly to skive or thin edges of heavier weights of leather.)

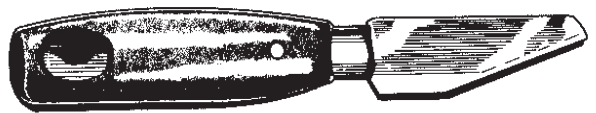

**Dye Brush**

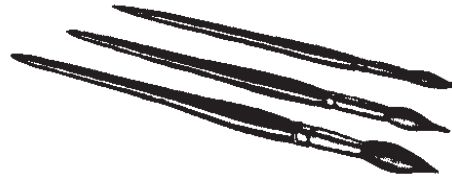

**Bag or Oblong Punch** (Easily punches buckle slots, bag slots, etc. in heaviest leather.)

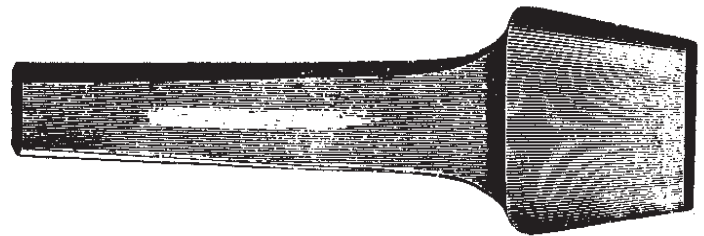

**Round Drive Punch** (Sizes 0 to 12)

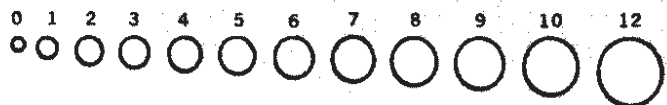

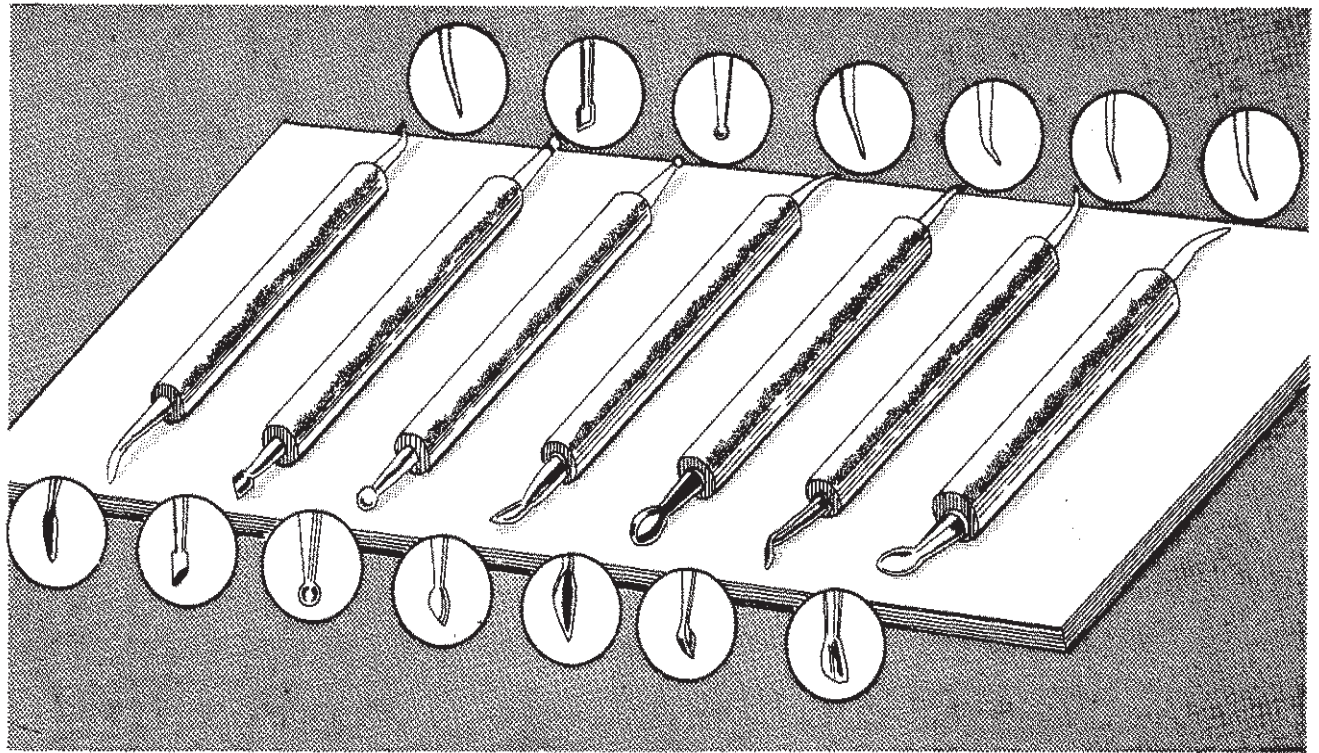

**Modeler**



**Spacer (Sizes 5-6-7)**

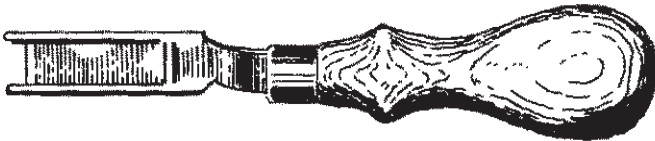

**French Edge Skiving Tool.**  
For both left and right handed persons. Tool gouges, channels, skives and countersinks rivets.

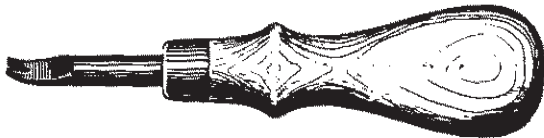

**Edger (Sizes 1-2-3-4-5)**



**Bone Folder (Smooth finished white bone folder for pasting and folding. Six inches long.)**

**Creaser** (Sizes 1-2-3-4-5)



**Circle Edge Slicker** (Used for polishing unlaced edges.)

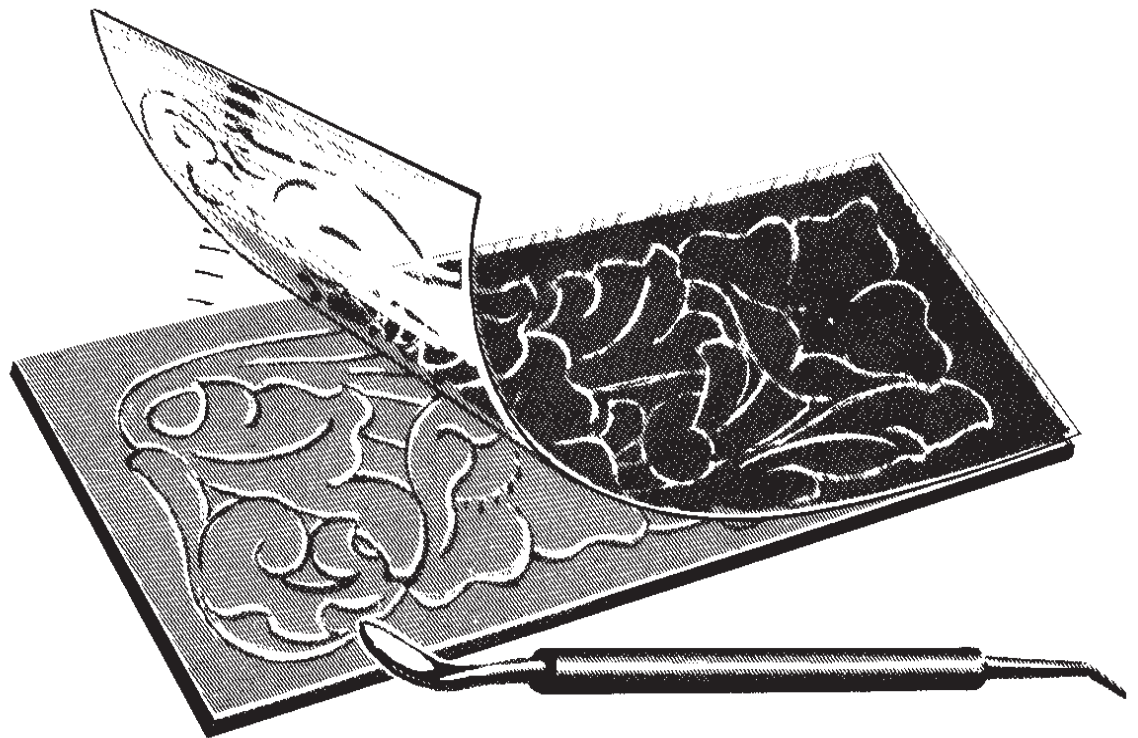
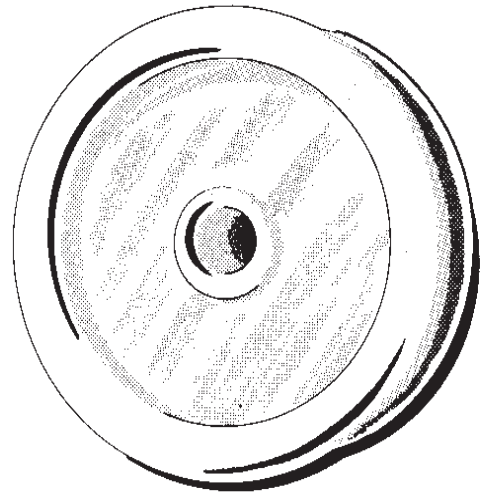

"**Craftaids**" are plastic patterns and may be obtained for many items. They furnish a quick way of transferring designs to the leather.

# Ways to Decorate Leather

(Other Than Carving or Stamping)

## Outline Tooling

Remove the paper design after all lines have been traced, and moisten the leather again if necessary. If the leather is too moist, water will ooze up the back of the modeler as you tool. If the leather is too dry, the modeler will tend to scratch or break through the outer surface of the leather.

Place the leather on a smooth, flat surface, such as marble, and go over the outline lightly until you have retraced the design. Hold the modeler as you would a pencil. Go over the design several times, increasing the pressure each time, until the outline of the design is very clear and the lines are depressed uniformly.

Use a straight edge to tool straight lines.

## Flat Modeling

This method of decorating leather is more advanced than outline tooling and will take more time and patience. The design will be just the opposite of outline tooling for the background is depressed, making the design stand out in bold relief. Take care not to mar or scratch the softened leather with fingernails, tools, or other objects.

Remove the paper design and moisten the leather a second time if necessary. Go over the design on the leather with the modeler as in outline tooling.

Depress the background around the design by using the broad end of the modeler, holding it parallel to the surface of the leather. Use considerable pressure to smooth out the background, but be careful so you don't rough up the leather. This may be smoothed by rubbing the leather with the grain.



The deerfoot modeler may be used for putting down the background by holding it in an almost vertical position. Use a firm, even pressure on the deerfoot, pressing down the background around the design. The edges of the design may be softened by taking the broad end of the modeler and smoothing them.

## Stippling

Stippling the backgrounds of designs, accentuates the design and makes them more beautiful.

Moisten the leather as in any other form of tooling and place it finished side up, on a piece of marble.

Use the small end of the modeler to do fine stippling. Take care not to break through the outer surface of the leather.

A ball-point modeler may be used to stipple. Hold the ball point in a vertical position and enrich the background with a tapping motion. Better results may be obtained on some leathers by applying pressure to the tool and turning it at the same time. This will make a clear, round impression on the leather.

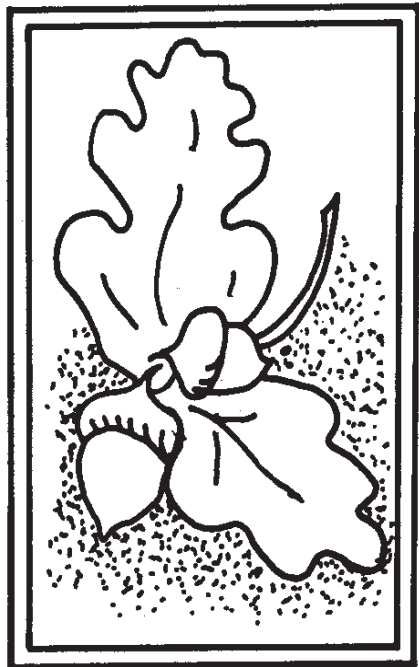

EMBOSSING

Embossing is raising the design, or part of it, above the surface of the leather by working it out from the flesh side. A 3/4 oz. cowhide lends itself well to embossing. Heavier weights, though, can be used for large projects.

Two general methods of embossing are used. The "plug" method, in which a plug of leather, carved and sculptured to the contours of the design, is glued into the cavity; and the "packing" method, when materials such as cotton or leather shavings mixed with rubber are glued into the embossed area. Both methods employ the same basic steps.

Step 1. Transfer design to grain side of leather, and cut all solid lines with the swivel knife. Bevel all around the outline of the area to be embossed. The tooling will then show through on the reverse side of the leather

Step 2. Turn the dampened leather with the grain side down; hold in palm of hand and with a modeler, work the leather into a cavity which will accommodate the plug or packing materials.

Figure 1. As the leather is worked down with the modeler, keep in mind the contours of the figure, and work the portions of the cavity to the desired depth of these contours.



Step 3. If the plug method is used, the plug must be sculptured to add greater depth to the carving. The plug is cut smaller than the outline of the design, see Figure 2. The plug is cut out and then shaped to the design's contour; Figure 3. When the plug has been shaped sufficiently, it is glued into the cavity.

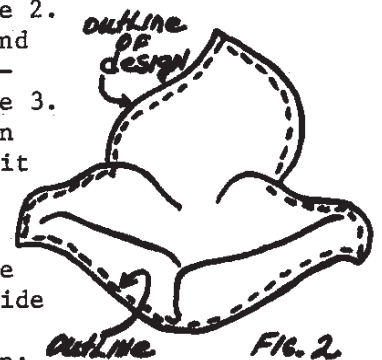

Step 4. Turn the leather over, right side up, and re-bevel the outlines of the design; Figure 4. This procedure forces the plug into position.

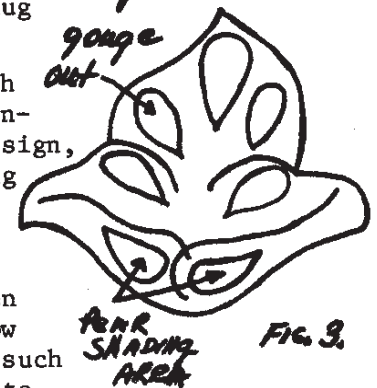

Now proceed with the carving of all inside lines of the design, and complete beveling and stamping in the regular way. Work over the plug; the fact that it has been sculptured will allow the stamping tools, such as the pear shader, to sink into the plug and give greater depth to the design.

All steps for embossing, using a packing material instead of a plug, are the same for shaping the cavity.

The "packing" method lends itself well to small areas. Once the cavity is formed, the packing material is mixed with rubber cement and

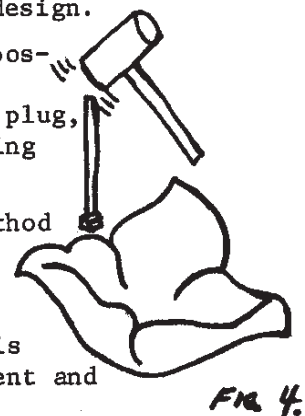

then packed firmly into the cavity. Fine leather skivings make excellent packing materials.

Before the packing material sets firmly, turn the leather right side up and follow Step 4. Since the packing is still soft, it will yield and be forced into the depressed areas, and out of the areas where it is not supposed to be.

If the cavity has been filled too much, the excess will be forced over the outline of the design area. The excess is then cleaned off, or skived off to make the plugged area level with the outline of the design.

A packed cavity is softer to work on than a plug, and care must be taken not to force too much of the packing out of the raised areas.

Once the plug, whether a sculptured plug, or of packing material, has been worked to the desired dimensions, glue

a thin piece of leather, such as skiver, to the flesh side of the project to help keep the plug in place.

Sometimes it is not possible to cut a plug as thick as you would like the embossed portion to be. When this situation arises, the embossed area is either plugged or filled, as described above, and then layers of leather are glued on top of the plugged area until the whole depressed area is filled level to the surface of the flesh side.

In order to maintain the proper perspective in a picture, the figures in the foreground should be higher embossed than those in the distance.

Some of the tools that are needed for cutting and shaping plugs are; a skiving knife, a cutting knife, such as a Xacto knife, a gouge, edge bevelers, and if available, wood carving chisels work very well for removing portions of the plug.



## How to Filigree

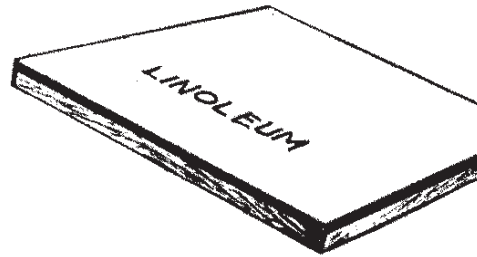

**TIP**  
GLUE A PIECE OF HEAVY LINOLEUM TO A SMOOTH BOARD. THIS MAKES A GOOD CUTTING BLOCK FOR FILIGREE WORK, CUTTING STENCILS, PUNCHING HOLES, ETC.

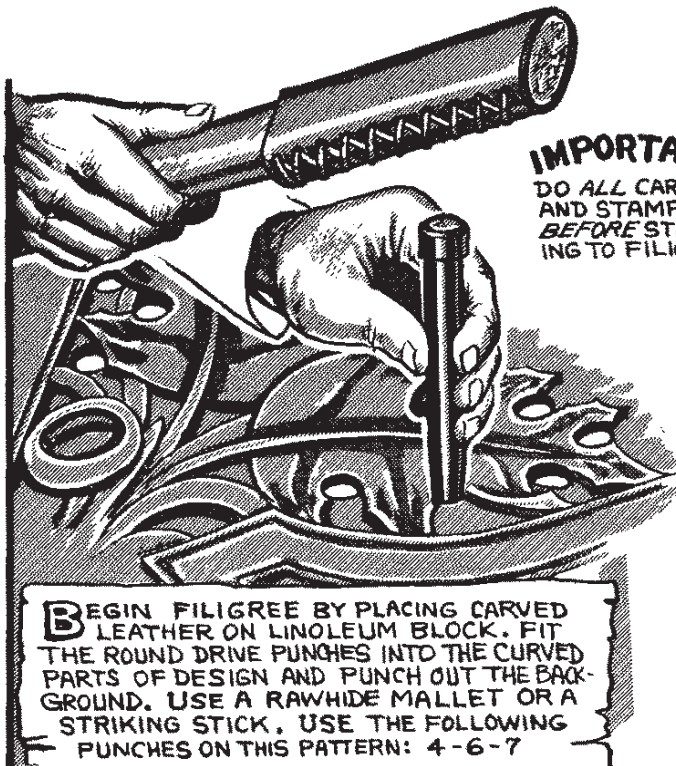

**IMPORTANT!**  
DO ALL CARVING AND STAMPING BEFORE STARTING TO FILIGREE.

**DON'T DO THIS →**  
NEVER CUT THRU A STEM. REMEMBER... ONLY THE BACKGROUND IS REMOVED.

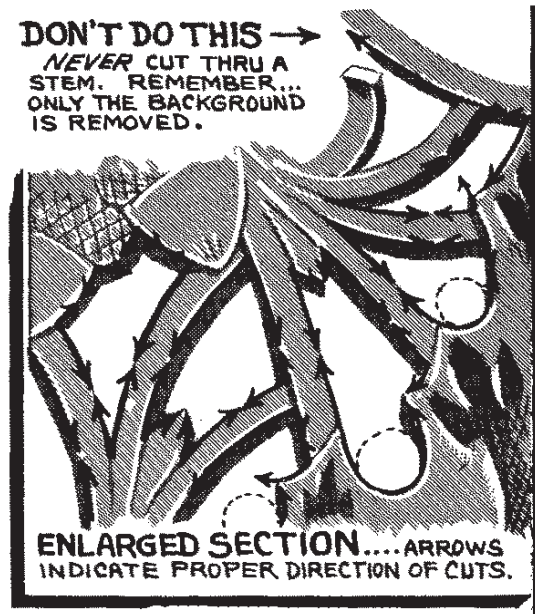

**ENLARGED SECTION....ARROWS INDICATE PROPER DIRECTION OF CUTS.**

**BEGIN FILIGREE BY PLACING CARVED LEATHER ON LINOLEUM BLOCK. FIT THE ROUND DRIVE PUNCHES INTO THE CURVED PARTS OF DESIGN AND PUNCH OUT THE BACKGROUND. USE A RAWHIDE Mallet OR A STRIKING STICK. USE THE FOLLOWING PUNCHES ON THIS PATTERN: 4-6-7**

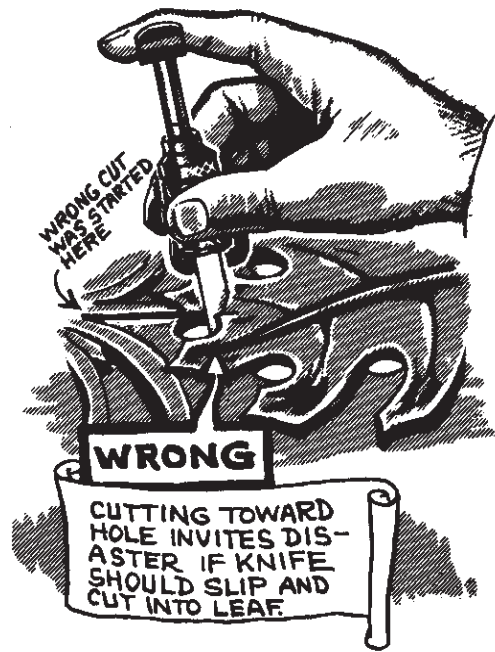
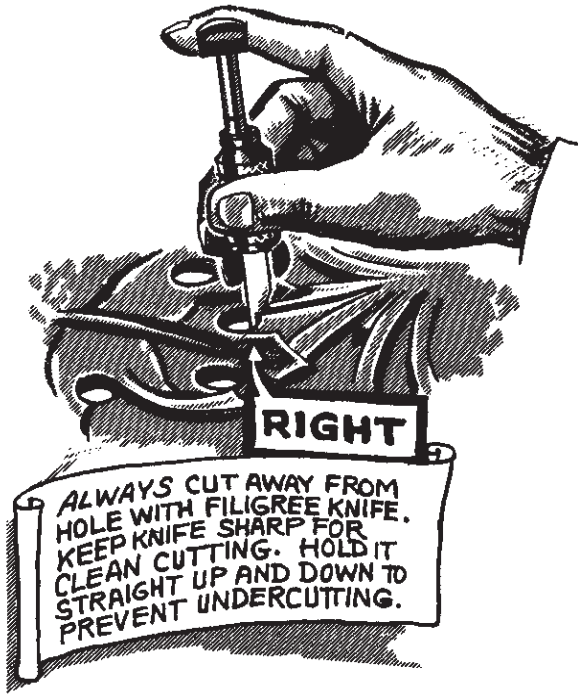

After filigreeing, apply leather dressing to carved panels. Use a small brush to thoroughly cover edges of filigreed areas. Colored leather--gold kid,

silver, red, green, white, or any one of a large variety now available-- is sometimes used between the lining and the filigreed panels.

Here is a photograph of an 8 inch mat of filigreed leather. It can be used to set potted plants on or for any number of other purposes. When well coated with a leather dressing it is quite waterproof.

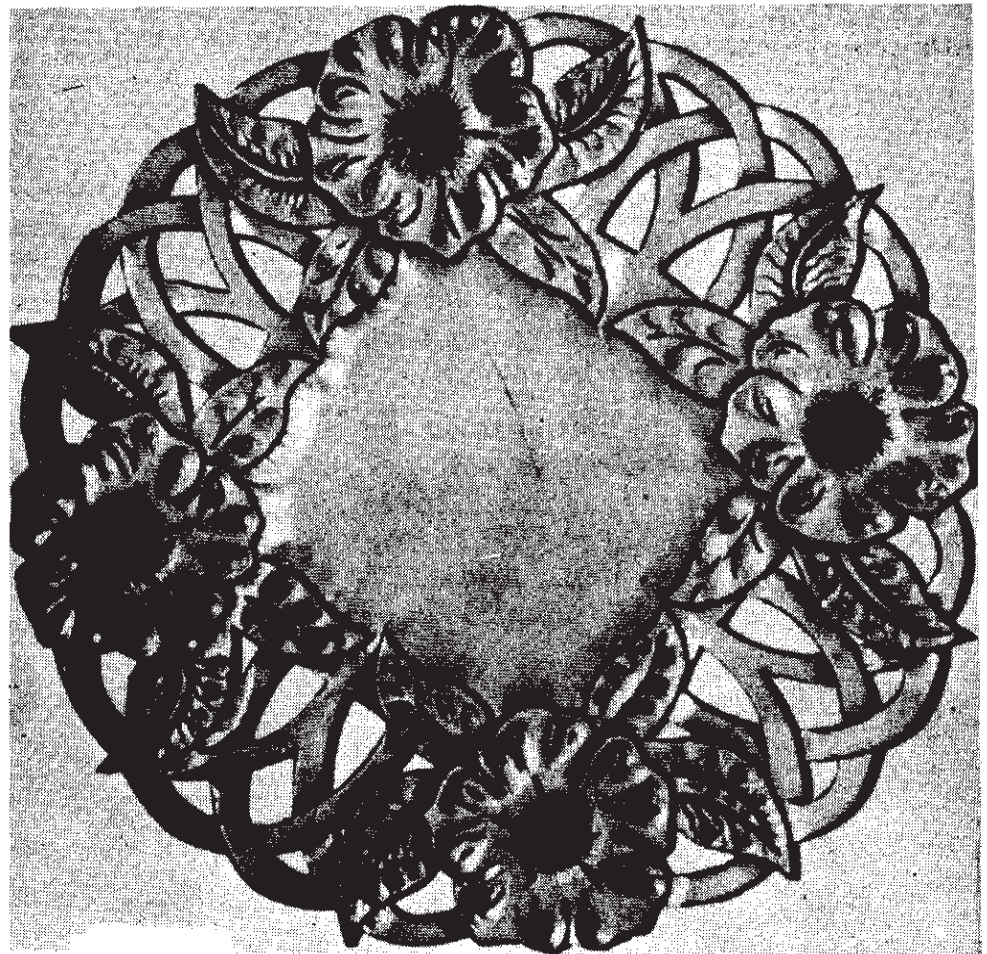

# Hand & Machine Stitching

## Machine Stitching

The ordinary sewing machine found in the home can sew leather. Machine sewing is used to fasten zippers to leather, to sew gussets, purses, bill-fold pockets, etc. The leather cannot be too thick or you will encounter trouble. A used sewing machine for heavy work can often be bought at a sewing machine shop.

1. Place a straight No. 19 needle in the needle clamp and tighten. Be sure the flat side of the needle faces the right way, and that the thread will lie in the long groove of the needle during the sewing. Use an E shoe-twist machine-silk or linen thread of about the same weight. Silk thread will work much better on the machine, since it is not as stiff as linen thread, but by dropping the needle about one-half the thickness of a dime, better results will be obtained with linen thread.
2. Fill the bobbin and replace it. Then thread the machine correctly and check for the proper tension.
3. Set the stitch regulating lever or screw so that the machine will sew nine stitches per inch for zippers in notebooks or for sewing where the leather is very thick. Too many stitches per inch will cut the leather.
4. Pieces of leather to be sewed should first be cemented together. This will keep the leather from slipping and will keep suedes from stretching.
5. Start sewing by laying both ends of the thread back under the pressure foot. Place the edge of the leather just far enough under the pressure foot so that the first stitch may be taken. Lower the pressure foot and begin sewing.
6. To finish the sewing, stop the machine before reaching the end of the seam. Raise the pressure foot and remove the leather by pulling it straight back away from you. Leave enough thread to tie the ends and to prevent the thread from pulling through the needle.

## Hand Stitching

Since a sewing machine isn't always available, it is well to know how to hand stitch. Hand stitching is often better for some leather projects than machine stitching--especially for those with hard-to-get-at corners. Practice on scrap leather.

1. Locate and draw a very light line with a pencil for the row of stitching holes. On small and light weight work, this line should be 1/16 inch in from the edge of the work. If the work is heavier and larger, this line may vary up to 1/8 inch from the edge.

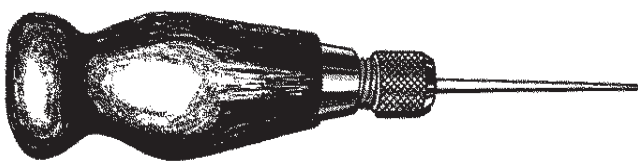

Awl Haft and Blade for  
prepunishing stitching holes.

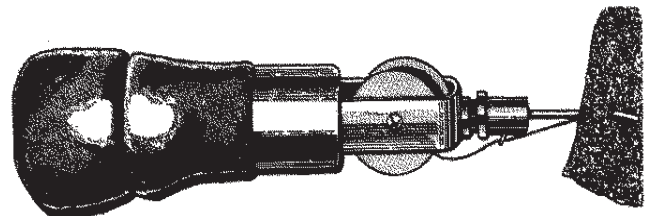

Lock Stitch Awl for hand sewing.



2. Determine how many stitches per inch are to be made. For light work there should be 8 to 10 stitches per inch, for heavy work 5 to 6 stitches per inch. Place on a clean, smooth, soft board. Use the correct space marker to cut the holes through light weight leather. A stitching punch may be used on heavier leather by holding it in a vertical position and tapping it lightly with a wooden mallet, just cutting through the leather.

3. For stitching small projects made from light weight leather, use a common sewing needle, size 5, and buttonhole twist silk. Use a larger needle and linen thread for larger projects made from heavier leather. Linen thread should be waxed before it is used by pulling it through a piece of bee's wax.

4. Two needles and two sets of string gives a tighter stitch.



## Skiving

Skiving will reduce the thickness of the leather in areas where several pieces will join or where the leather will be doubled over and cemented to make a facing. This paring down of the thickness is done on the flesh side of the leather only. A special safety skiver, head knife, or beveled edge knife is

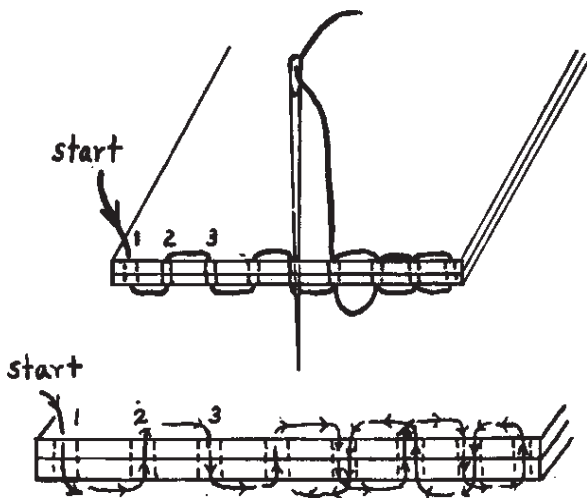

Running Stitch

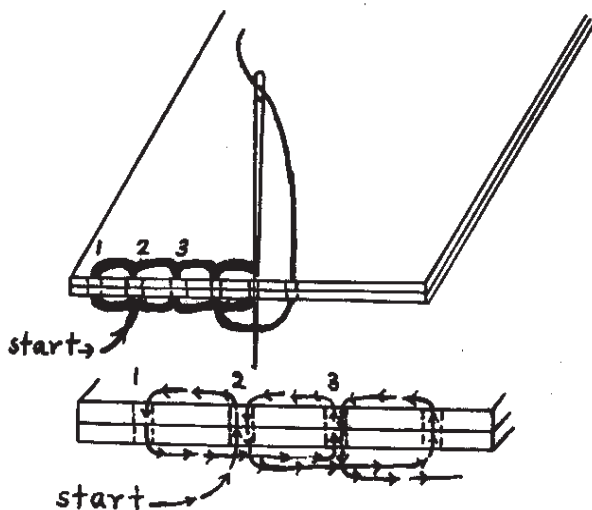

Back Stitch

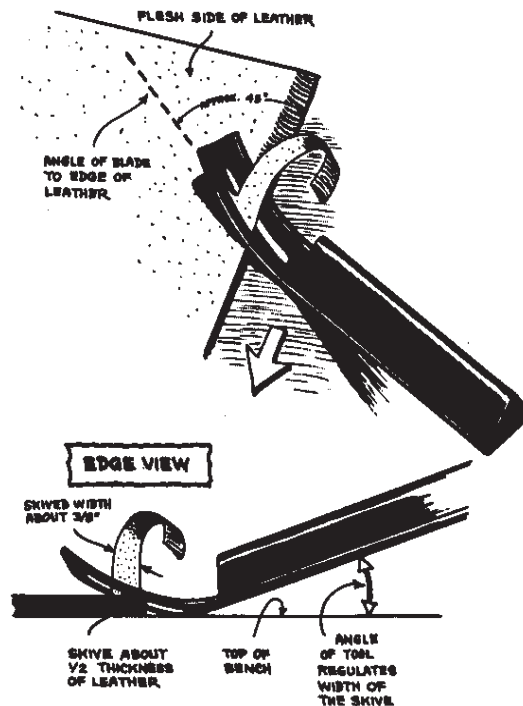

used. Places where skiving would be helpful include belt ends which must pass through a buckle or the main part of a handbag where the gusset is to be joined.

# Border Lines

To cut border lines in belts, straps, or handles, use a swivel knife and straight edge. Cut a line about 1/8 inch from each side. You can use a creaser or cutter designed just for this purpose.



## Edging Belts, Etc.

For a professional appearance use an edger to round off edges that are not to be laced. This tool cuts only at the proper angle and is safe to use.

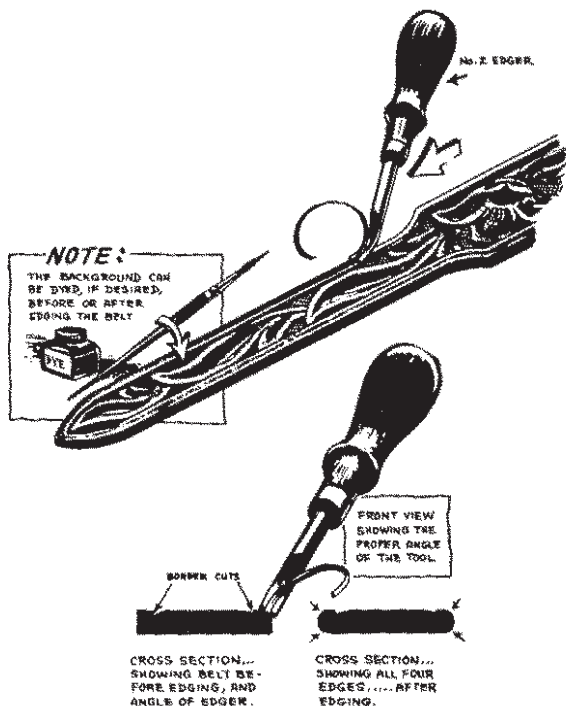

## Burnishing the Edges

Burnishing means to smooth the fibers along the edges of a project, giving them a rich brown color. Use this technique on belts, straps, and other edges not covered with lacing. Moisten

a sponge with water and wet the edges to be burnished. Hold the project securely (on strap-like projects, lay them on a table or bench with the edge sticking out), and rub a circle edge slicker rapidly and firmly over the edge. If the project has edges which are to be dyed, apply the dye before you burnish to allow greater penetration of the dye into the leather.

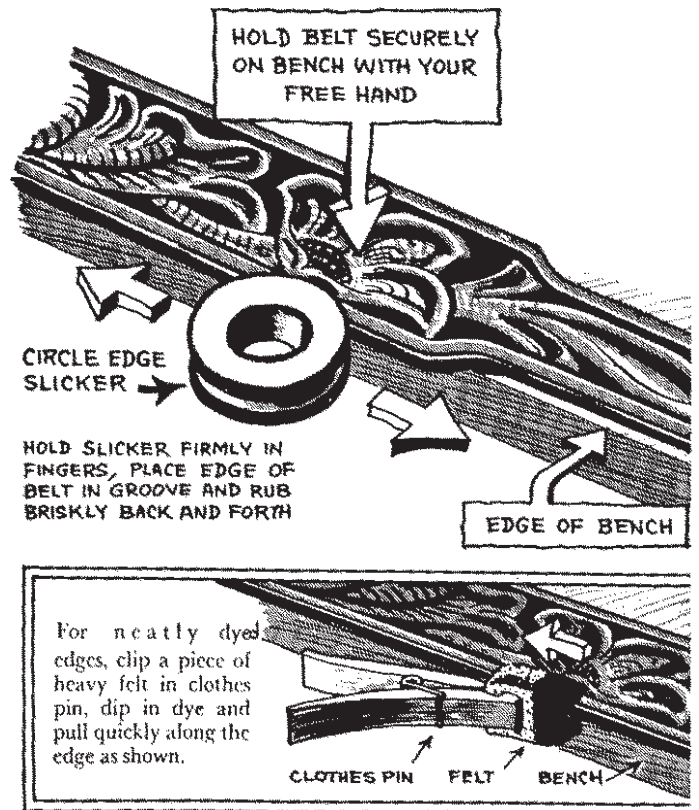

## Folds

### Marking the Fold Line

Be sure the leather has not stretched out of shape. Using a straight edge, make a line for the fold with a pencil. Make sure that the fold line is in the right place.

### Gouging the Fold

Gouging removes some of the leather for easier folding. Normal gouging depth is about 1/2 the thickness of the leather. Lay the leather grain side down and gouge only the flesh side. Using the

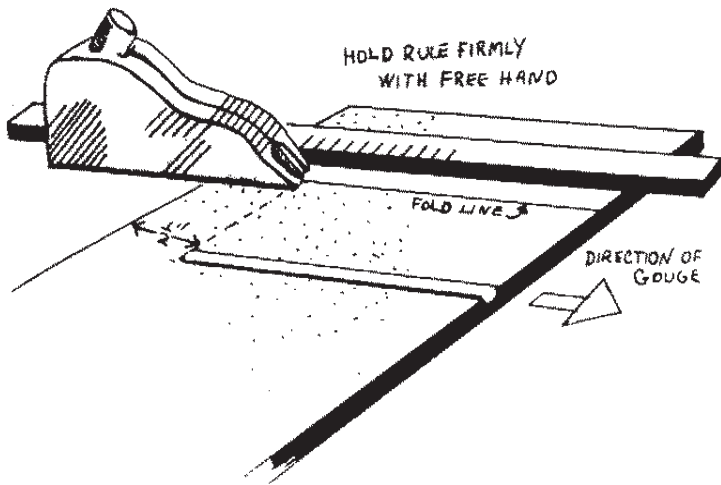

adjustable gouge, begin gouging about 1/2 inch from the end of the leather. Use a straight edge as a guide to hold the gouge steady along the marked line. Gouge to the end of the leather, turn the leather around and gouge the 1/2 inch of leather still at the other end. If you moisten the leather along the marked line, it may be easier to gouge.

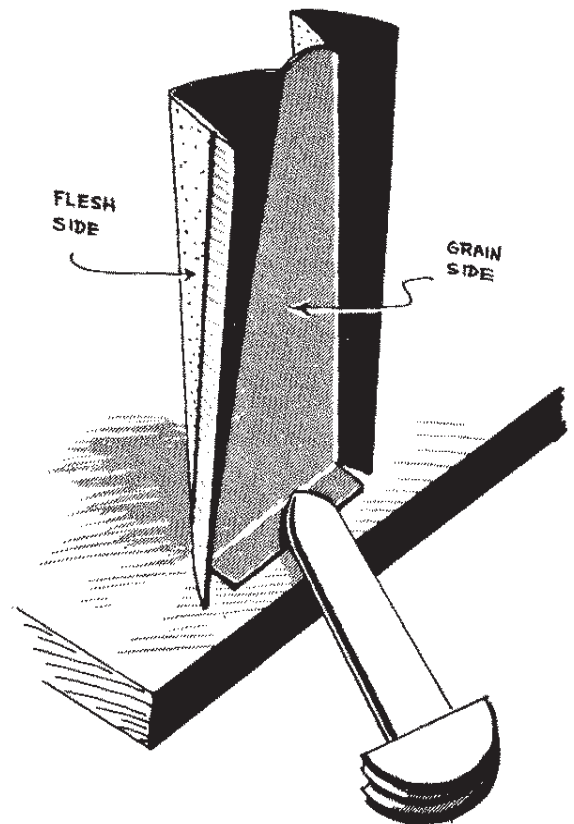

### Folding Gussets, etc.

Dampen all the gouged areas with a sponge. Lay the project on a hard surface and use the bone folder to crease

the leather along the gouged marks. Where one end of the project turns out (as in a purse gusset), turn it up on the bench and use the point of the bone folder to make a sharp crease. Avoid rubbing too hard with the folder, as this will be on the grain side and will burnish the leather.

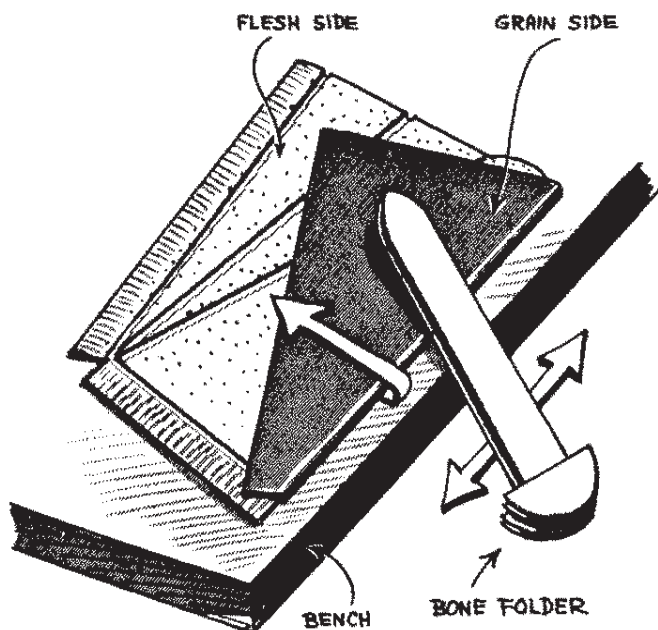

# Cementing Stiffeners in Place

After all gouging and skiving have been done, allow the leather to dry. Carefully apply a thin layer of rubber cement over the flesh side of the leather where the stiffener is to be laid, and on one side of the stiffener. Begin at the bottom of the stiffener and carefully place the pieces together. Take care to avoid getting any cement into gouges or holes.

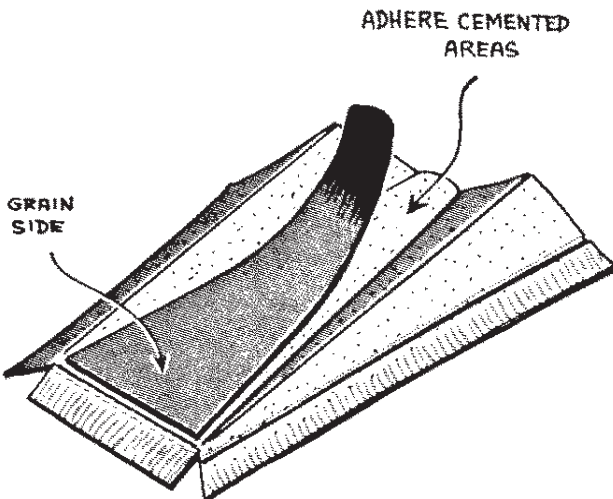
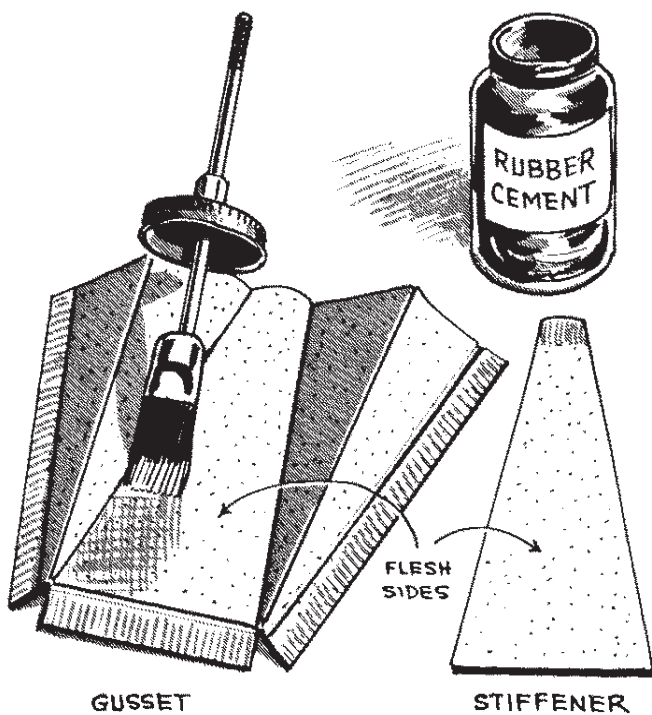

# Installing Hardware

## Installing Bag Clasps

Be sure to mark the position for the clasp on the leather, as indicated on the pattern. With the prongs of the clasp straight, position it over the mark and press firmly enough to make indentations from the prongs. Remove the clasp and use a thonging chisel to punch the holes for the prongs. Place the prongs through the holes and fit the back plate over the prongs. Bend the prongs over the back plate. Install strap hangers the same way, except that no back plates are used.

## Installing a Bag Clasp Eyelet

Fold the flap over and use a pencil to mark the center of the clasp. Open flap and lay it flat. Position the eyelet on the leather and draw around the inside with a pencil or stylus. Cut out this area

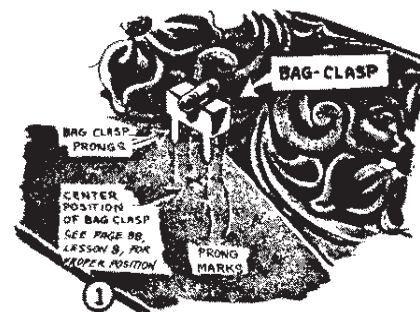

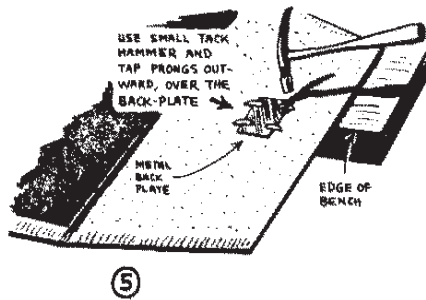
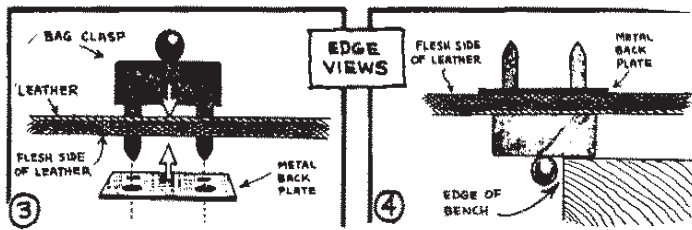

with a sharp knife. Place the eye into slot from carved side; turn the lining side up and slip back plate into position. Fold prongs over into depressions and tap with mallet.

### Joining Pieces

When two leather pieces are to be joined, use a knife to scuff (rough-up)

the edges of the leather. This is a necessity on finished or dyed leathers where cement will not adhere well. Scuff an area about 1/4 inch from the edges. Apply two coats of cement to each edge to be joined. Let them dry before joining them. Carefully align the pieces and press together. Sometimes a mallet is helpful to tap down the edges.

### Attaching Flaps and Extra Pieces with Rapid Rivets

Punch the rivet holes in any flat piece before that piece is laced to the main body of the project. Position a rivet cap on the outside of the project with the raised portion in the hole. Lay the project down on a hard surface, such as metal, and place the stud of the rivet down through hole into cap. Strike the stud of the rivet hard with mallet to firmly set it.

Knobby rivets can be used on the corners of handbags and bowling bags, etc., to prevent scuffing and marring the bottom of the bag and to help prevent lacing from wearing through at the bottom. Check the length of the rivet post and if it is too long, cut it off before installing.

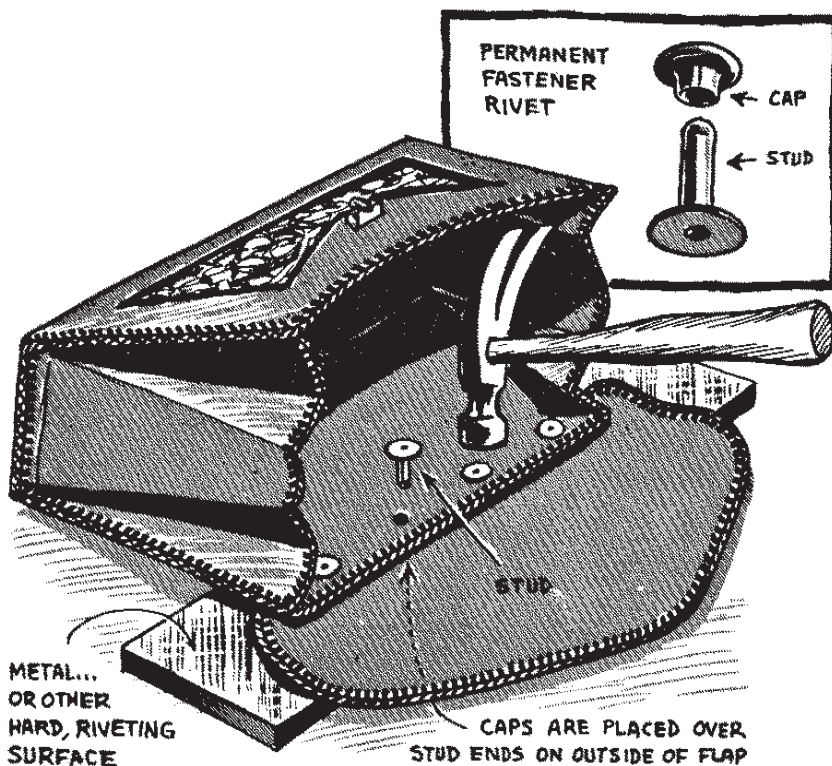

# Cementing the Lining

Apply cement to the skived edge of an article.

Smooth out any wrinkles in the lining by rubbing toward the edge with a bone folder.

The lining is shown as attached to a folded article such as the flap of a bag. Cement the flat surfaces together at the edges, then place over a block or table edge with the lining against the edge at the point at which the fold is to be made. Apply cement along the fold and out to edges of flap. Then press carefully together, working toward the outer margin of the flap, smoothing out any wrinkles in the lining. Additional cement may be necessary if it becomes too dry to adhere.

A form is used here in the same manner. This may be shaped from a block of wood for small articles, or made of sheet metal tacked to end blocks of the proper size for larger purse flaps.

The same thing may be accomplished without a form as indicated in this picture. Here the lining is kept smooth and all bulging and wrinkles worked out between the thumb and fingers as the fold is gradually made. This method is satisfactory for small articles.

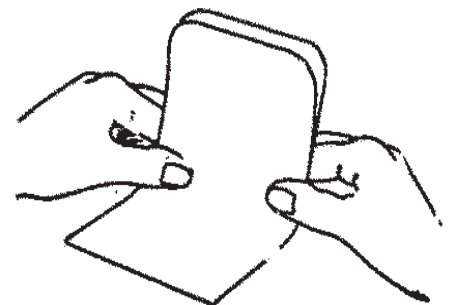
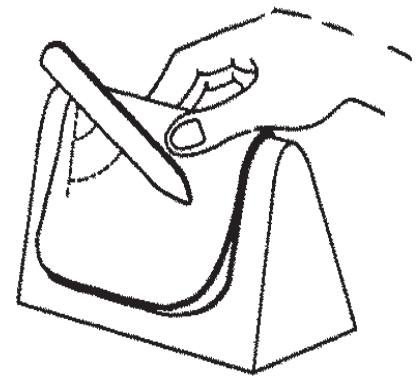
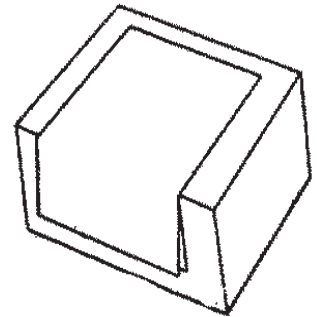
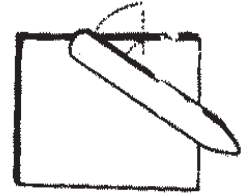
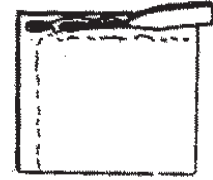

These pictures show the procedure in lining a gusset. Note that the top of the outside piece is skived back farther from the edge than the other margins. Picture "b" shows the shape of the lining. It is shorter than the outside piece and the depth of the skived edge is the same on all margins. Apply the cement to the edges and along the line of the fold; then place the lining in position as shown in sketch "c". Fold the whole gusset as in

sketch "d". Press the edges firmly and smoothly together while holding in the folded position. Fold the top edge of the outer leather, which extends beyond the lining, over the lining and cement it down. The gusset is now ready to be inserted in the proper position in the bag, as shown in sketch "f". Cement the edges of the gusset to the edges of the outside of the purse to hold them in position while the bag is punched and laced.

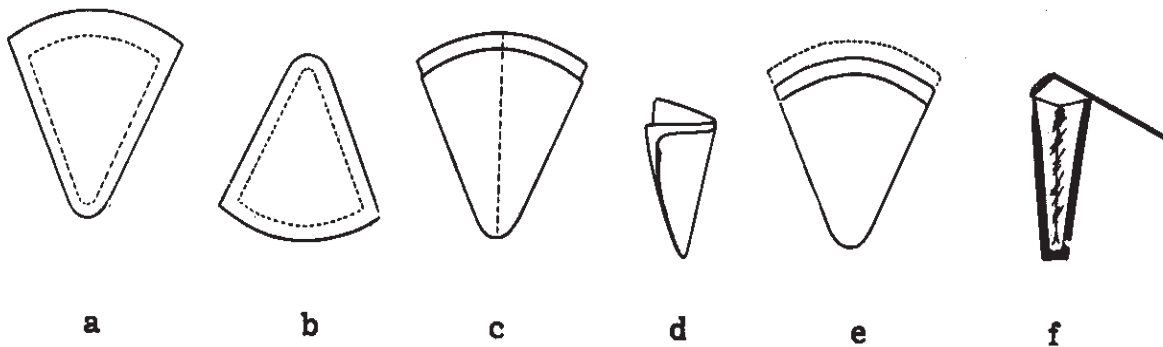

# Instructions for a Lady's Purse

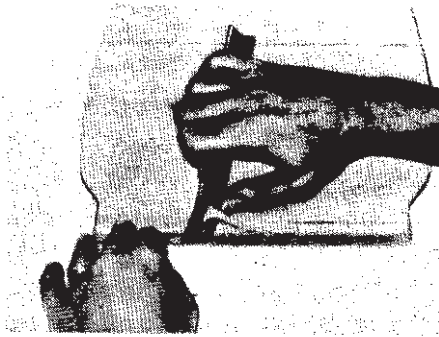

**1** SKIVE TURN-BACK ON EACH END OF THE PURSE PANEL.

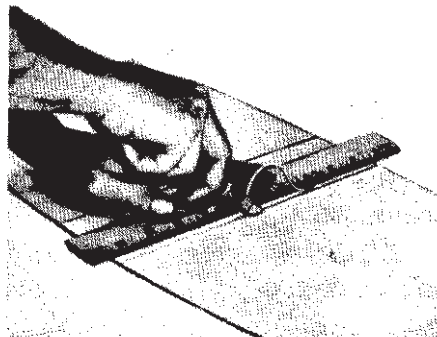

**2** GOUGE THE BOTTOM OF THE BAG FOR THE SQUARE BOTTOM GUSSET.



**3** SKIVE THE EDGES OF THE PURSE WHERE THE GUSSETS WILL BE.

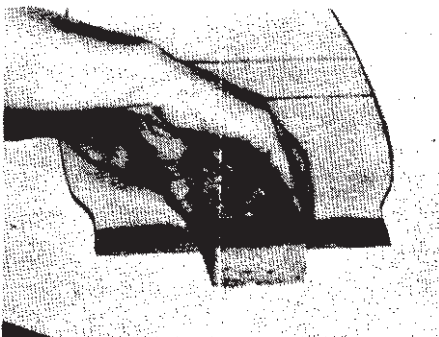

**4** MOISTEN THE EDGES OF THE TURN-BACK.

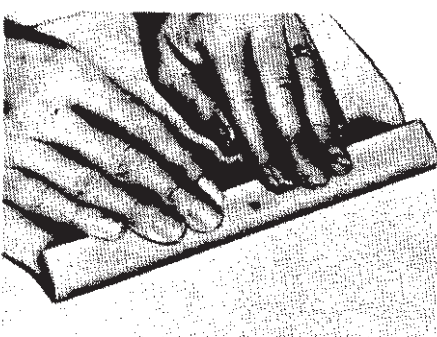

**5** FOLD BACK THE TURN-BACK ON EACH END OF THE PURSE PANEL.



**6** PLACE PURSE LOCK OVER CENTER OF PURSE PANEL AND MARK FOR HOLES.

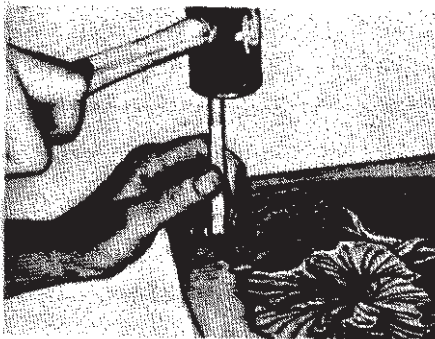

**7** PUNCH TWO HOLES FOR THE PURSE LOCK.

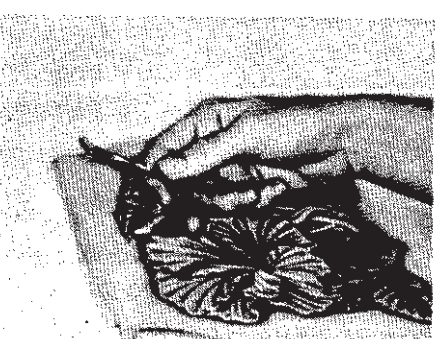

**8** INSTALL PURSE LOCK.



**9** POSITION THE PURSE LOCK, MARK AND INSTALL THE TWIST LOCK.

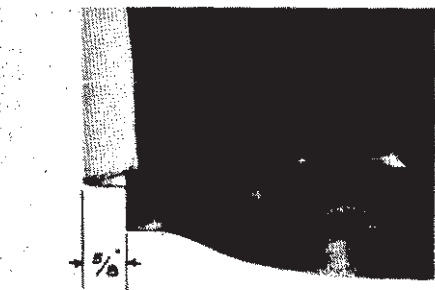

**10** LAY PURSE PANEL OUT FLAT AND TRIM LACING TO FIT UNDER THE TURN-BACK.

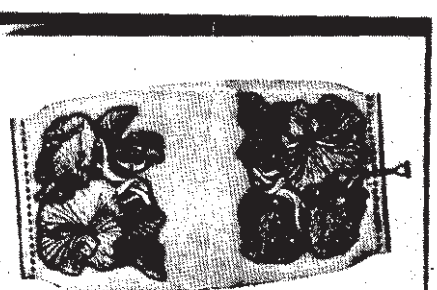

**11** CEMENT PURSE LINING, PUNCH HOLES THROUGH TURN-BACK AND LACE.



**12** MOISTEN AND FOLD GUSSETS FOR ASSEMBLY.





13 APPLY CEMENT AND CEMENT LININGS TO GUSSETS.



14 FOLD LININGS UP AND CEMENT TO THE FORMED EDGES OF THE GUSSETS.

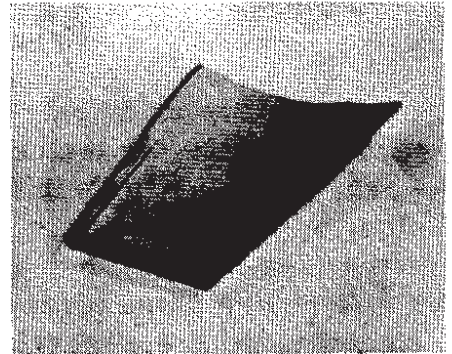

15 THE FINISHED GUSSETS AND LININGS SHOULD LOOK LIKE THIS.

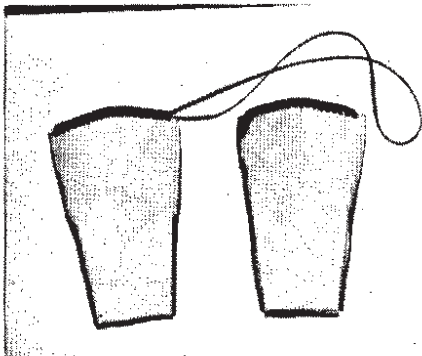

16 PUNCH AND LACE THE TOPS OF THE GUSSETS.

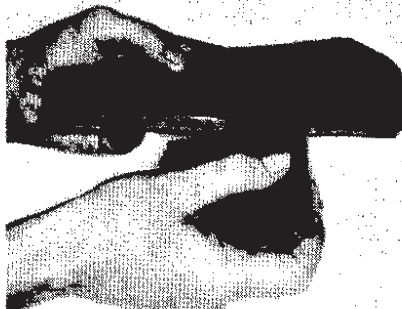

17 SCRAPE OR SANDPAPER THE EDGES OF THE GUSSETS AND THE LINING OF THE PURSE.

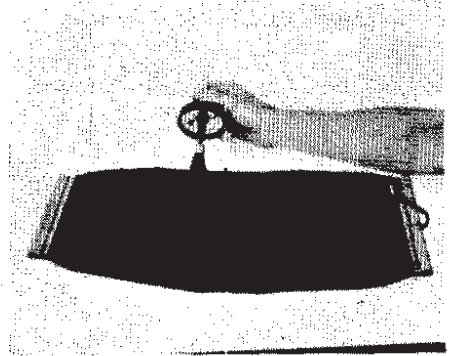

18 CEMENT THE EDGES OF THE PURSE AND THE GUSSETS.

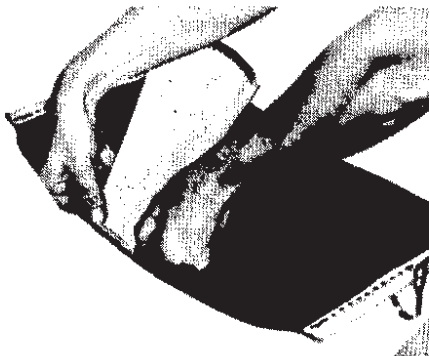

19 INSTALL THE BOTTOM OF THE GUSSETS FIRST.



20 PUSH GUSSET DOWN INTO THE CORNER OF THE BEND AND STICK TO PURSE.



21 PRESS THE REST OF THE GUSSET TO THE EDGES OF THE CEMENTED PURSE.



22 PUNCH HOLES & START LACING AS SHOWN.



23 FINISH LACE AT END SHOWN AND TIE OFF

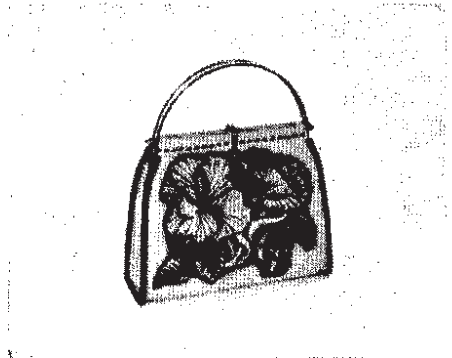

24 INSTALL RODS AND HANDLE ON THE PURSE. THIS COMPLETES THE PURSE.

# Making a Basic Design

There are many patterns available for leather work, but sometimes it is nice to make your own.

Here are some ideas on how to go about making the various parts of a design, and how to put them together. (1)

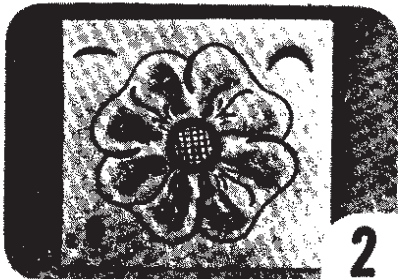

**2**  
This is a very simple flower and was carved with three tools and the swivel knife.



**3**  
Wood paneling is very easy to do.

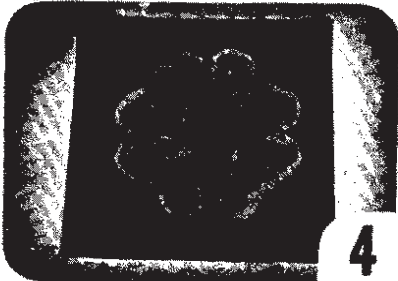

**4**  
This is the same flower with different tools used and initials overlaid.

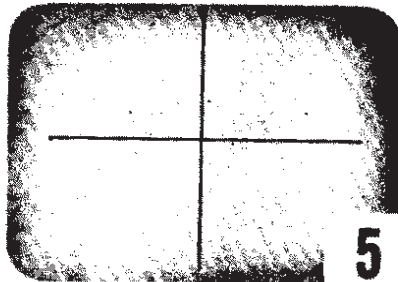

**5**  
To start the flower design draw two crossed lines.

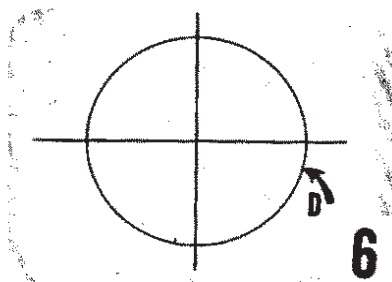

**6**  
With a compass draw a circle the diameter you wish the flower to be. In this case for a billfold the diameter is 2 1/4" Line "D."

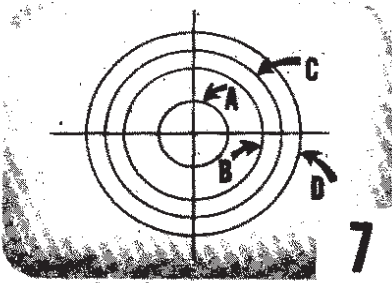

**7**  
Draw the following circles: A. The flower center, B. The start of the petals, C. The intersecting point for the outside of the petals.

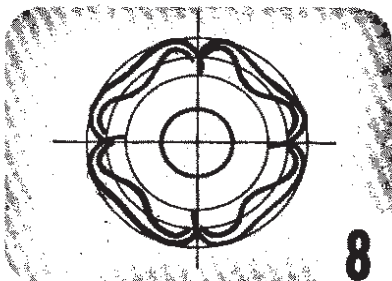

**8**  
Draw in the flower petals and the petal turnbacks.

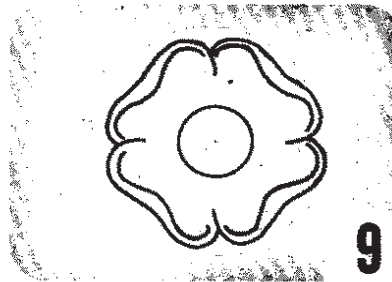

**9**  
Erase all lines except the outlines you wish to use. This is your tracing pattern for the four petal flower.

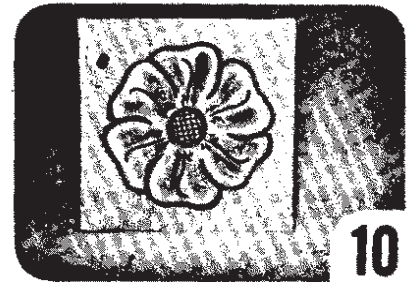

**10**  
You may use as many petals as you wish. This is a six petaled flower and the next three figures show how to develop.

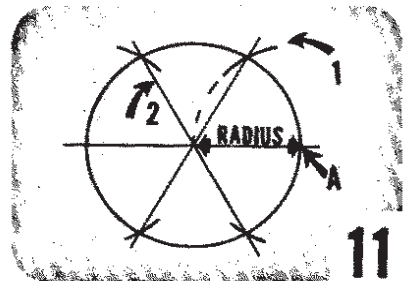

**11**  
Draw the horizontal line. Next draw large circle. Keep the same compass setting and swing #1 arcs from point A. Draw #2 lines.

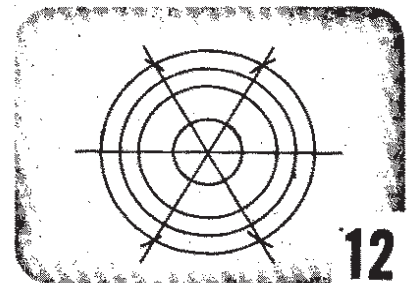

**12**  
Draw in the smaller circles and petals.

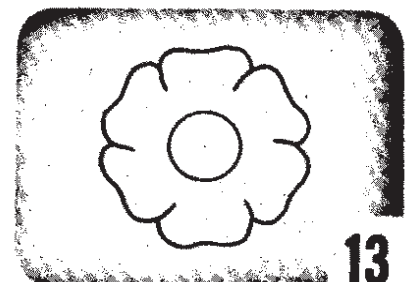

**13**  
This is your tracing pattern.



14

Leaves are needed to go with your flowers. This is the leaf we will use.

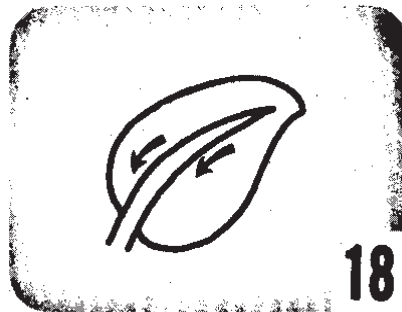

18

Third, draw in the stem.

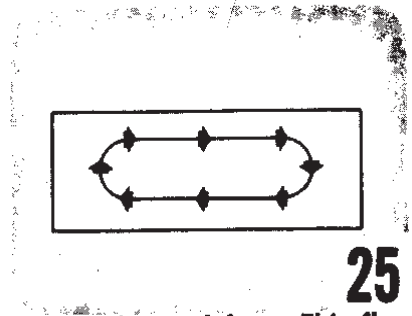

25

This is the oval form. This flow is used a great deal in developing designs for divided pattern billfolds or any small area.

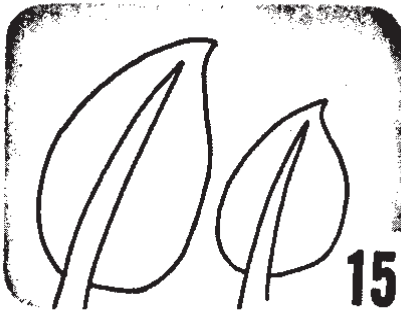

15

Make several leaves like this in different sizes. See Figs. #16, #17 and #18.

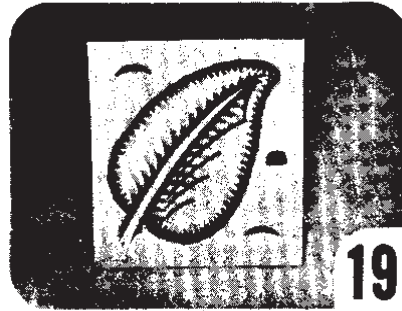

19

This is the same leaf as in Fig. 14 carved with different tools.

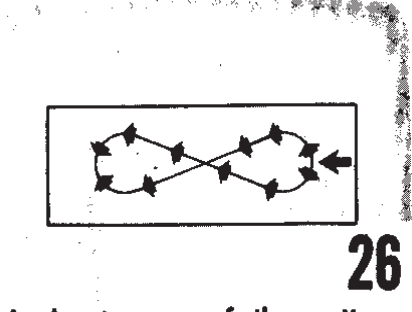

26

Look at some of the patterns now on the market and determine the flow of lines used to develop them. This is the figure eight.



16

First, draw the outside curve.

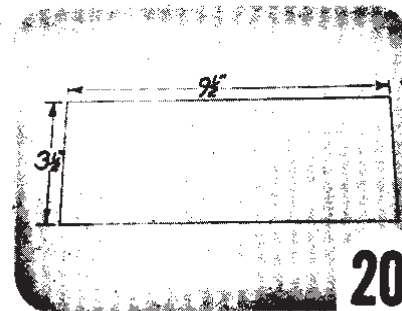

20

The design we will make will be made to fit a billfold back of the size shown in this photo.

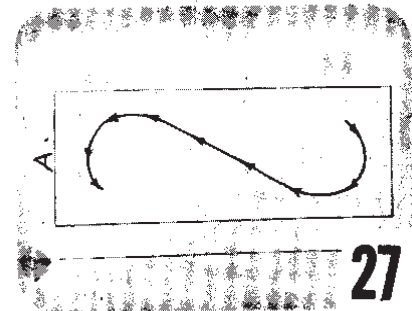

27

The figure "S" flow line has been selected for the development of the billfold design illustrated on this sheet. Sketch in the "S."

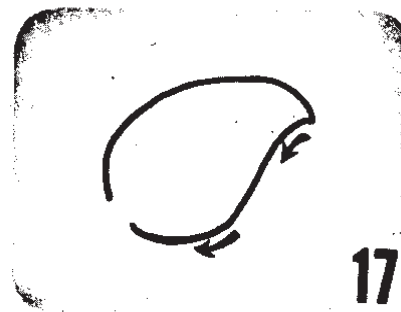

17

Second, draw the inside curve.



21

Use a small piece of tracing paper and make a tracing of the flower of your choice that will fit the design area.

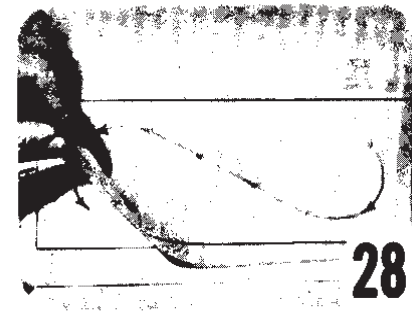

28

Place a piece of tracing paper over the outline of the billfold.

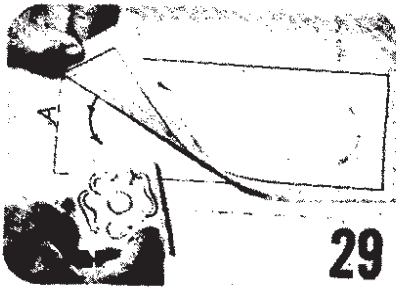

29

Take the traced flower and place it under the tracing paper and on the curve of the "S."



30

Trace in the flower.

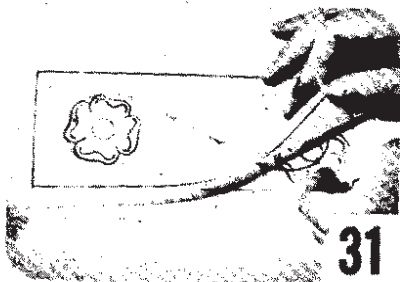

31

Move the traced flower to the other end of the "S" and trace again.

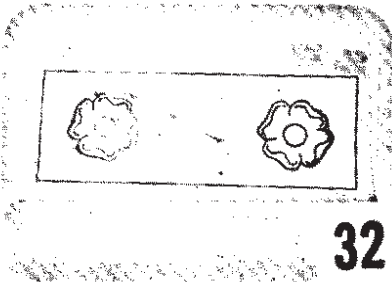

32

The design is now ready for the leaves to be added.



33

Use the leaf you traced on the small piece of tracing paper and place it under the tracing you are making.



34

Trace in the first leaf and remove the traced leaf from under the design.



35

Turn the leaf over and place it a little further along the flow of the "S" and trace in the leaf.



36

Turn the leaf over again and place under the paper ahead of the last leaf drawn and trace in the leaf.

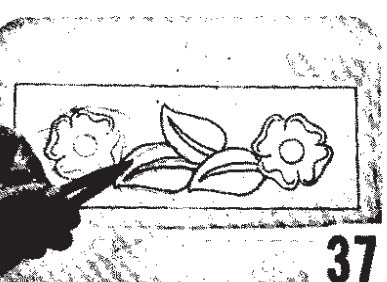

37

Occasionally you may have to change a line to make it fit into the design.

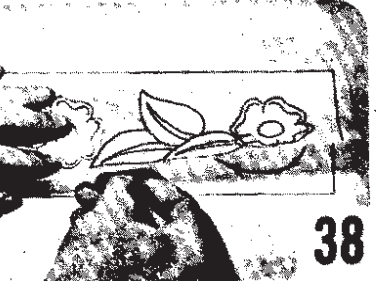

38

Notice this leaf was not turned over after tracing in the last leaf. It fits into the line of the "S."



39

The arrow points to a blank area.

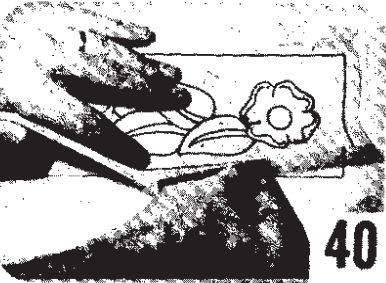

40

Fill in the blank area.

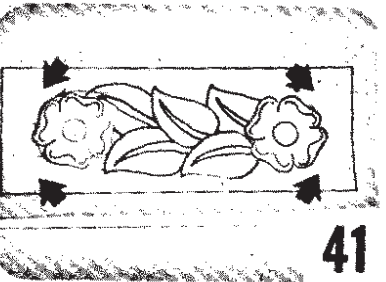

41

The four corners look empty.

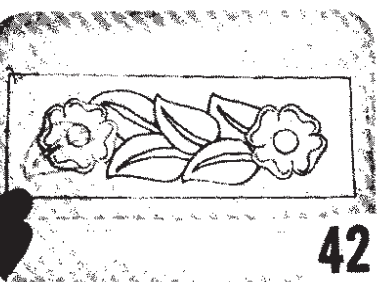

42

Fill in the corners with just a portion of the leaf.

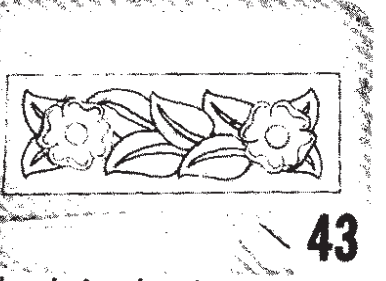

43

The design has been filled in, but it will need to be refined.

# Figure Carving

Figure carving does not differ much from floral carving. The main differences are:

1. Smaller details.
2. Sharper relief & illusions of greater depth.
3. Third dimension.
4. More difficult.

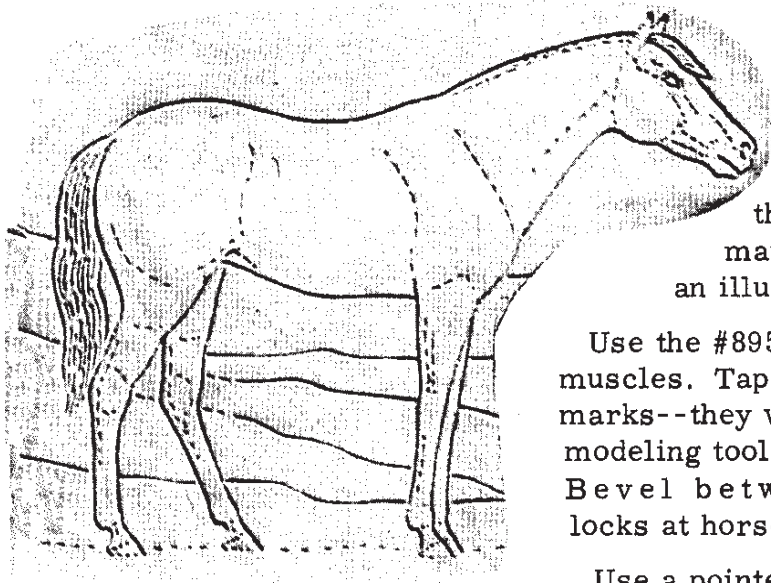

Here is a horse on which to practice.

Trace the figure as carefully as possible. Do not omit any lines. Be sure to trace all dotted lines, too. Dampen both sides of the leather. Transfer the design to the damp leather. Strop your knife and cut all solid lines of the horse. Do not cut any dotted lines. They are guide lines for beveling contours and muscles.

Bevel the dotted lines lightly, except at point of shoulder and flank. At these points apply more striking pressure. Bevel around legs and under belly. Strike the tool hard when beveling outlines. Use the heel of the tool to slope beveling and matt down away from the figure. This creates an illusion of depth.

Use the #895 beveling tool to bevel the jowl and neck muscles. Tap the tool lightly. Don't worry about tool marks--they will be smoothed out later with your modeling tool. Tap lightly on horse's face with #891. Bevel between tail and hind leg. Bevel under fetlocks at horse's ankles.

Use a pointed beveler between the ears and under the tail to sharpen relief. Use the spoon of the modeler to smooth out rough beveling marks.

Round the outline edges of the horse to make him look real. The modeling tool is very important in the figure carving. Use the spoon to round edges of figures; the point for fine details and as a tracing stylus.

Scratch in hairlines on forelock, mane, and tail with point of spoon. Add facial expression and press in nostril and corners of eye with point of spoon. Shape the eye round. Do not smash down the eyeball.

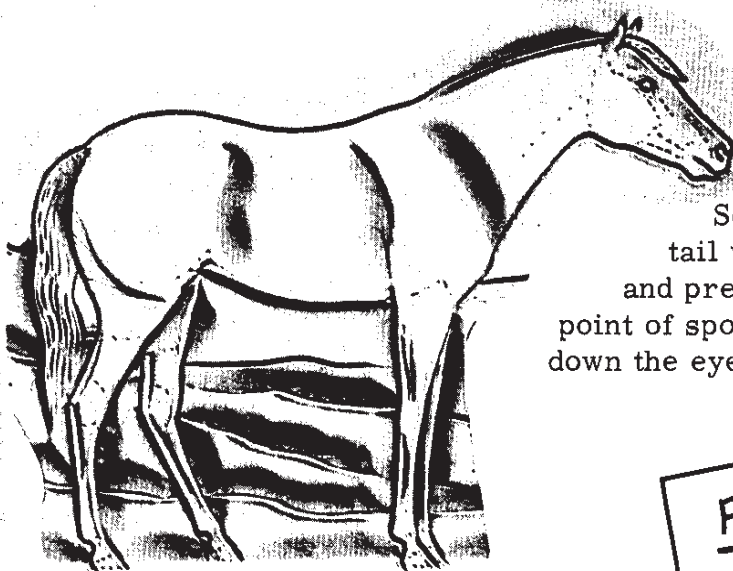

Figure Carving Rule:  
Always cut the foremost objects first.

# RIGHT

Only a casual glance is needed to notice the difference between right and wrong carving. However, let's make some specific comparisons to demonstrate what is wrong with wrong and right with the right.

In the "wrong" carving of the horse, notice that the legs are much too thin for correct proportion. This can be caused by careless tracing, or more commonly, it results from the swivel knife cut being slightly on the inside of the tracing line. Compare with the "right" figure where the cut was made along the outside of the cut.

# WRONG

In the "wrong" figure, the beveling is choppy rather than having been "walked" along smoothly with an even striking force. Even the most careful beveling will require the use of a modeler to finish it correctly. The smooth effect of the modeler can be seen in the "right" figure at the top. The mane and tail demand flowing lines rather than straight lines, and these also are made with the modeler.

The matting tool, like the beveler, must be walked smoothly along with an even striking force.

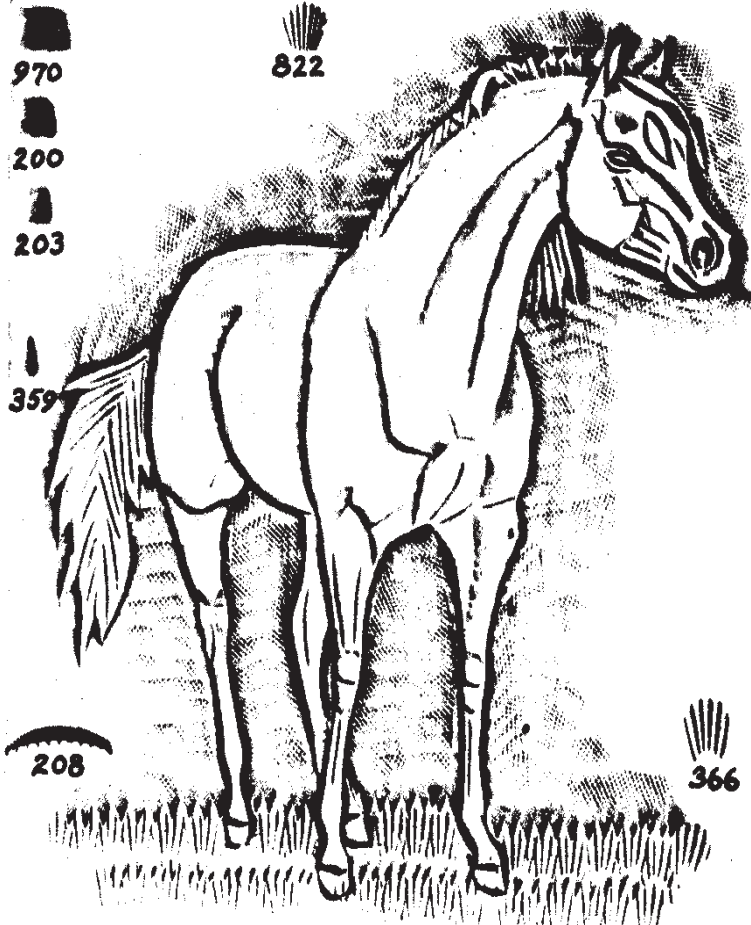
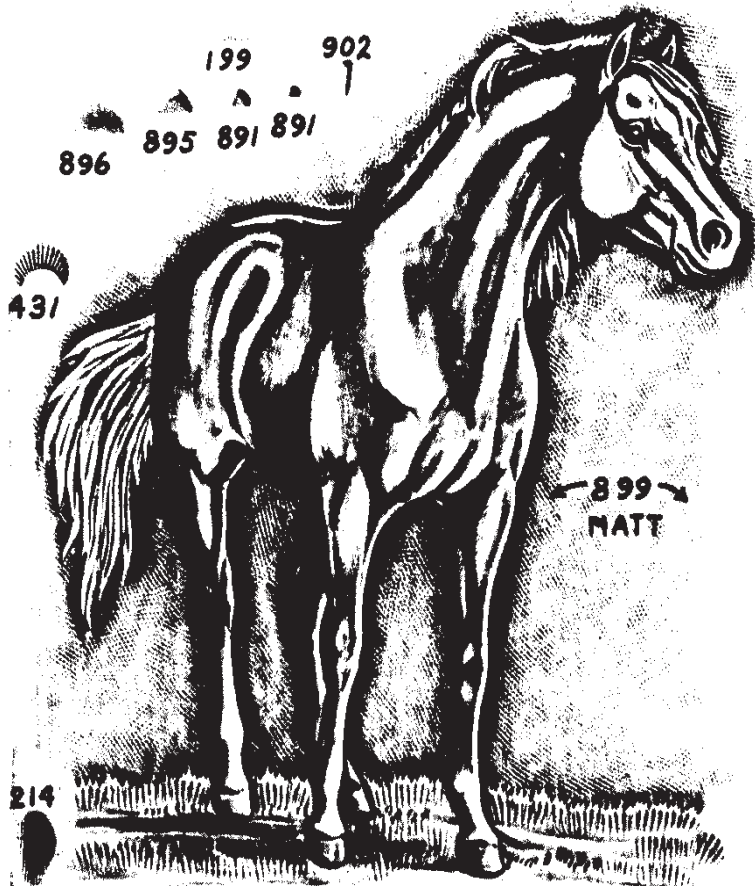

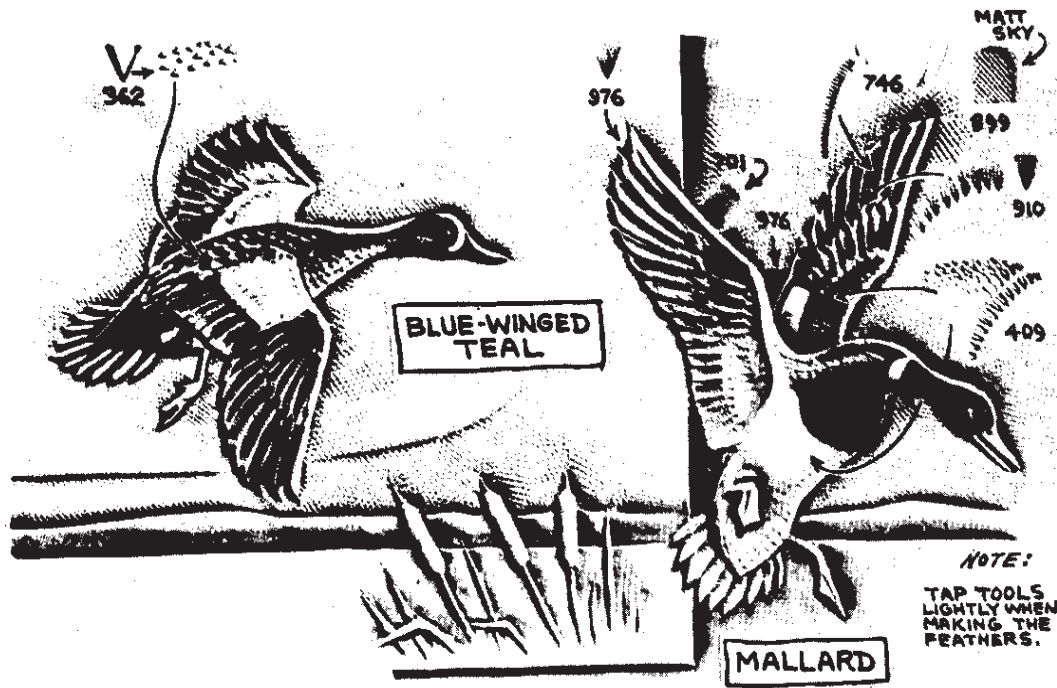

## Dyeing Leather

Often dye can be used to good advantage to improve the appearance of your leather article. In most cases, however, it will decrease the durability of the article as dyes tend to fade with wear.

### Kinds of Dyes and Stains

You may want to color your own article or at least part of the design you have carved. There are many different dyes and stains available with which to work.

**Water Dyes.** Most commonly used dyes for leather are aniline dyes. They come as a powder and are mixed with hot water to make a solution. Directions are on the packages of dye purchased from supply houses. The article may be completely immersed to color it or the dye may be applied with a brush.

**Oil Stains.** These are used to produce soft effects and make the article more durable. Thin them with turpentine. Apply oil stains and wipe off immediately.

**Spirit Dyes.** These are powder dyes that are soluble in alcohol, or they may be purchased already mixed. They are inexpensive and easy to use.

**Higgins' Waterproof Drawing Inks.** These inks are excellent for dyeing edges of leather and small designs. They are not suited for coloring large projects because they are expensive.

**Acids, Salts, and Oxides.** The following acids, salts, and oxides are soluble in water. A few grains or crystals dissolved in a half cup of distilled water will make a solution sufficiently strong. Always try the solution first on a piece of scrap leather. If the solution is too strong, the leather will darken, crack, and deteriorate rapidly. Add more distilled water to solutions which produce such effects. The best way to get dark shades is to apply a weak solution several times. Remember, it is always best to experiment on scrap leather before applying the following solutions to your work:

1. Ferrous hydroxide--various shades of brown.

2. Chromium trioxide -- various shades of brown.
3. Ferrous sulphate--shades from pale gray to deep blue gray.
4. Ferrous ammonium sulphate-- deep grays.
5. Picric acid--various shades of yellow. Applied over ferrous sulphate, it will produce shades of green.

### How to Dye Leather

Complete all carving and thoroughly clean the leather before dyeing it. A weak solution of oxalic acid is good for cleaning leather. Be sure to sponge the leather with clean water after cleaning it.

The leather should be almost dry before applying dye. Always test the color on a piece of scrap leather before you apply dye to your project.

Use a small brush and flow the dye on to the leather. If the color is too light after the dye dries, flow on another coat. Use a different brush to apply different colors, or wash the brush thoroughly between coats. Different tones of color may be obtained by flowing one color upon another.

Apply dye to the edges of leather, using a brush, or the method shown on page 15. Be careful not to get the dye on the finished side of the leather.

When dyed surface is dry (about two hours), polish it with a soft cloth.

Articles not subject to great wear may be colored with regular water color colors. Always practice on scrap leather.

Put antique finish into and around carved designs. Wipe off surplus finish immediately with a soft cloth. Allow the finish which remains around the



1. Touch center of background area with properly loaded brush first.
2. Work around upper edge of all background, and filling in upper portions, always keeping area to be dyed in full view.

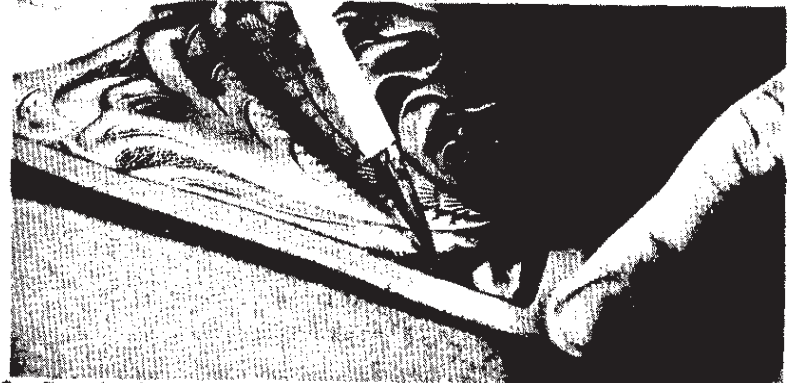

3. Turn leather around approximately 180°, and fill in upper portions of this side.

carved design and in the depressions to dry. Then polish with a soft cloth.

If you want to dye the entire article, use the following methods:

If using a swab applicator, apply dye to leather in circular motions. If using a



large squirrel-hair brush tilt leather so that left side is on a slight angle and apply dye from left to right in straight, even strokes. Begin each subsequent stroke from the left and partially overlap the preceding stroke. Apply dye freely until the article is completely covered. If you want a deeper tone, allow the first coat to set for about ten minutes before applying the second coat.

### Application

Apply the lightest tones of the lightest colors first and progress to the darkest tone of the same color. For example: a brown horse on a hot, sandy desert. Begin with the yellow or light tan tones for the desert, graduating to the darker tones of tan, reflecting highlights and shading. Then begin with the lightest tones of brown on the horse, graduating to the darker tones. Work your brush from left to right, beginning your stroke wherever you wish the darkest shade of that particular tone. This is especially true with the oil and solvent dyes because where the brush initially contacts the leather, the heaviest deposit of dye will be left. With the water soluble dye, the colors also should be applied from light to dark; however, these dyes may be blended together by modeling them with your index finger as long as the dye is wet enough. Many beautiful color arrangements can be had with this latter method. A little experimentation here can be a lot of fun.

### Suggestions as to Selection of Colors

Browns, tans, and russet are leather colors. They can be used very effectively in their various tones for this type of dyeing. Since leather assumes no other color from its mellowing, these colors will be greatly enhanced as the leather ages. If you wish to use other colors, select colors with a common base (water or oil).

Dyes also are available in colors such as blue, yellow, green, white, red, etc. Sometimes it is interesting to use a color to make matching accessories. Use color sparingly though as the natural beauty of the leather is best for most articles.

### Added Tips on Leather Dyeing

1. When dyeing, turn leather whenever necessary.
2. Feel relaxed.
3. Being relaxed gives you an attitude of confidence.
4. Tensions and anxieties inevitably result in mishaps.
5. Don't hurry. Be deliberate. Remember, you already have a great deal of time and money in your carving.

A little more patience will pay great dividends.

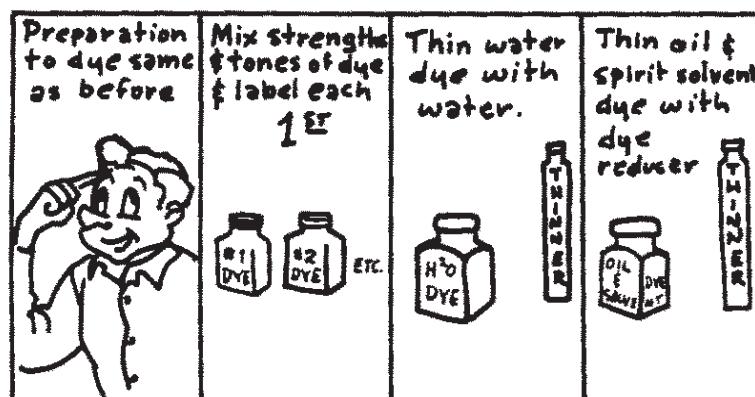

NOTE HOW LIGHTS AND SHADOWS CREATE ROUNDNESS AND DEPTH ON THE HORSE BELOW.

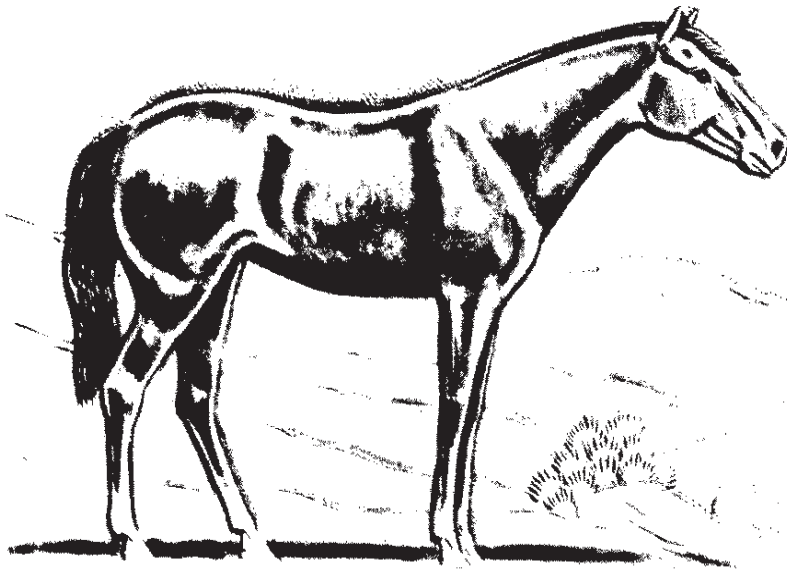

REMEMBER.....  
DO NOT TOUCH HIGHLIGHTS WITH DYE.

DYE #1

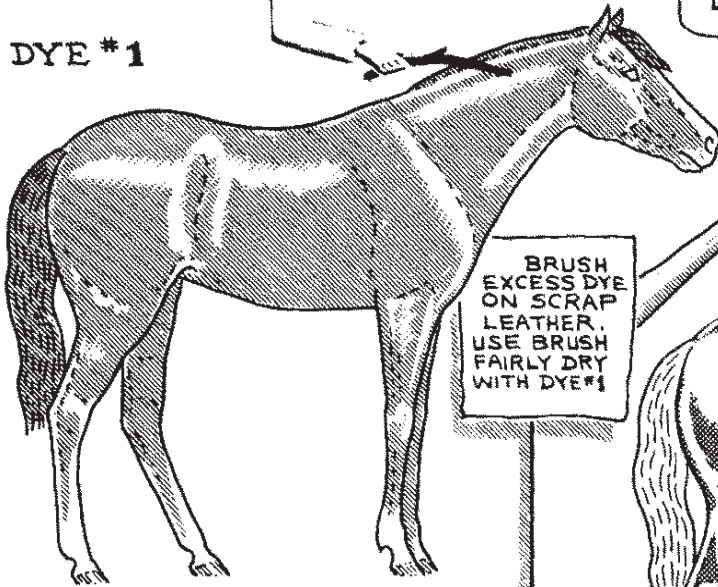

BRUSH EXCESS DYE ON SCRAP LEATHER. USE BRUSH FAIRLY DRY WITH DYE #1

DYE #2

GROUND SHADOW

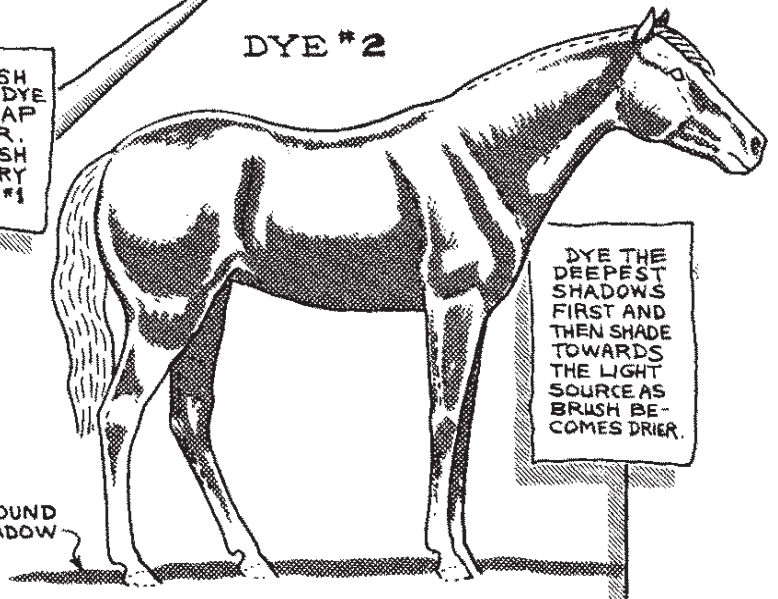

DYE THE DEEPEST SHADOWS FIRST AND THEN SHADE TOWARDS THE LIGHT SOURCE AS BRUSH BECOMES DRIER.

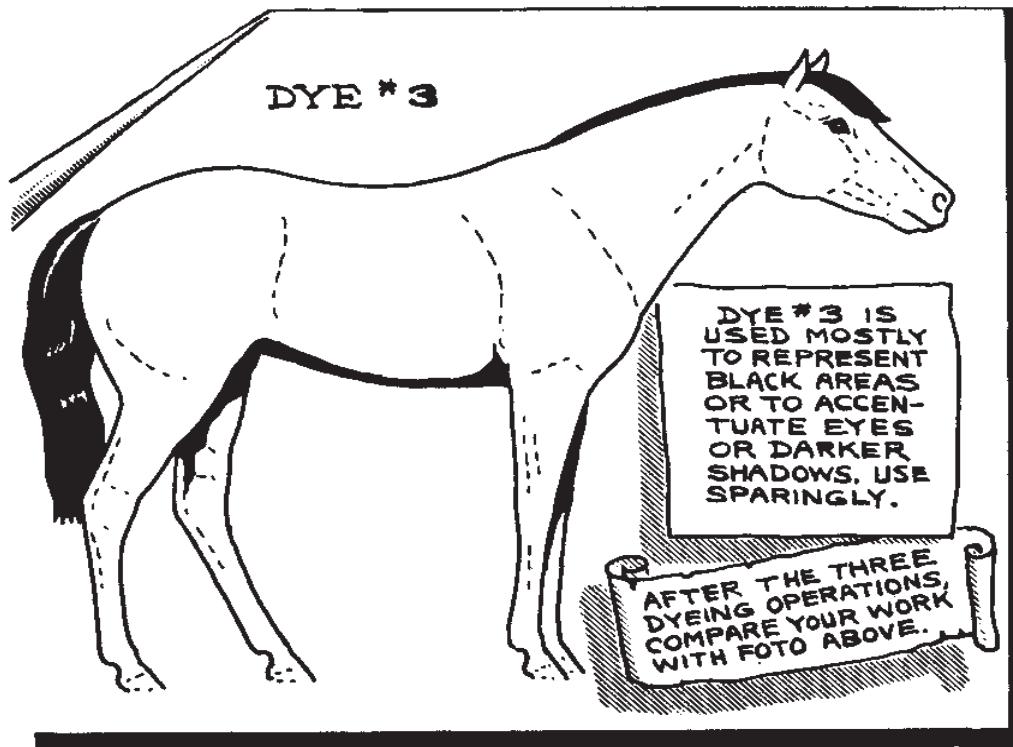

**FORMULA**  
FOR MIXING THE DYE

**DYE #1**  
1 PART BROWN  
3 PARTS ALCOHOL

**DYE #2**  
1 PART BROWN  
1 PART ALCOHOL

**DYE #3**  
FULL STRENGTH

*NOTE: DUE TO THE MANY TYPES OF DYE AVAILABLE, IT MAY BE NECESSARY FOR THE CRAFTSMAN TO ALTER THE FORMULA ABOVE BY USING MORE OR LESS THINNER TO PRODUCE THE DESIRED SHADE. ALCOHOL OR METHANOL MAY BE USED.*

# IDEAS

## HINTS AND TIPS ON BUYING AND CUTTING HIDES

Eventually an individual may want to cut projects from hides. This is particularly true of the older member who wants to make some project not available in a kit. A few simple facts about leather are in order.

Since leather comes from animals, and many of these animals are from the open range, a certain amount of natural imperfections are to be expected. One pays a premium price for A grade hides, and generally they tool no better than a B or C grade. Very little A grade leather is available. A good craftsman can work a pattern so that these imperfections do not show.

Leather is priced by the square foot, but is generally sold by the side, back, or, in the case of lining leathers, by the full skin. A cataloged price of so much per square foot refers to the price per square foot when the whole piece is purchased, and is not the price if you were to buy only one square foot of the leather. Most companies do not sell leather other than as listed in their catalogs.

The hides are graded by eye and not a machine, and there may be some difference from one grade hide to another of the same grade. Again, an A grade hide will not tool all that much better than one of a lower grade. No competent judge should give a lower ribbon because of some minor scar or imperfection on the project. You can be genuinely sure that you are using full-grain leather if some flaws are visible, as this is the part of the hide that has been exposed to the elements of nature.

All hides are measured by a machine which is constantly checked for accuracy by the government. The size of the hide is marked on the back in feet and

quarters of feet. For instance, a hide marked 9' is 9 and one-quarter square feet; a 2 would be a half-foot, and 3 would be three-fourths of a foot.

Companies use ounces to designate the thickness of the hides. An ounce represents  $1/64$ " in thickness, and the weight and thickness of a hide will vary some. So, 8/9 oz. leather means the hide is 8 to 9 oz. in weight,  $8/64$ " to  $9/64$ "... or about  $1/8$ " thick.

A few leathers, such as saddle skirting, are sold by the pound. Exotic leathers, such as alligator or snake, are sold by the square inch or by the skin.

If cutting templates (outlines of the projects) are made from something like a heavy cardboard, they can be laid out on the hide prior to cutting and arranged to make the best use of the hide. Much leather can be wasted by not double-checking a layout before cutting into the hide. A good leathercraftsman, like a good carpenter, measures twice, but cut only once.

Generally it does not matter in which direction on a cowhide a project is laid out, but it is better to cut belts the long way of the hide. Garment leathers are cut the long way of the hide also; the top of the pattern being started at the neck end of the skin. This makes the garment hang better.

Care must be used in cutting a napped leather such as suede. With its definite nap, all pattern pieces must run in the same direction, or the project will have a two-toned effect to it.

# Demonstrations

## Preparation of Demonstration

1. Decide what you would like to demonstrate, then be sure you know how to do it well yourself.
2. Gather together all materials needed-- tools, leather, patterns, etc.
3. Charts can be good visual aids if they are used to place emphasis on a step-by-step method.
4. Be sure your audience can see what you are doing. Sometimes a mirror can be used to good advantage to reflect your work in front of a large group.

## Suggestions for Demonstrations

- ... How to carve.
- ... Use of tools in stamping.
- ... How to lace a leather article.
- ... Cementing linings and edges.
- ... Setting a bag plate.
- ... Filigree work.
- ... Figure carving.
- ... Dyeing.
- ... Any other process used in leather work.
- ... Sewing suede leather.



## COIN PURSE

Here are two patterns for coin purses. They can be made any size you wish.

### How to Make

1. Make a pattern according to size desired. Mark the folds on your pattern and mark the places where your snaps will go.
2. Place pattern on leather and cut out leather. (Use straight edge.)
3. Select or make design and trace on leather.
4. Carve and stamp design.
5. Put finish on leather.
6. Insert snaps.
7. Punch holes for lacing, and lace. (The triangular purse is not to be laced.)

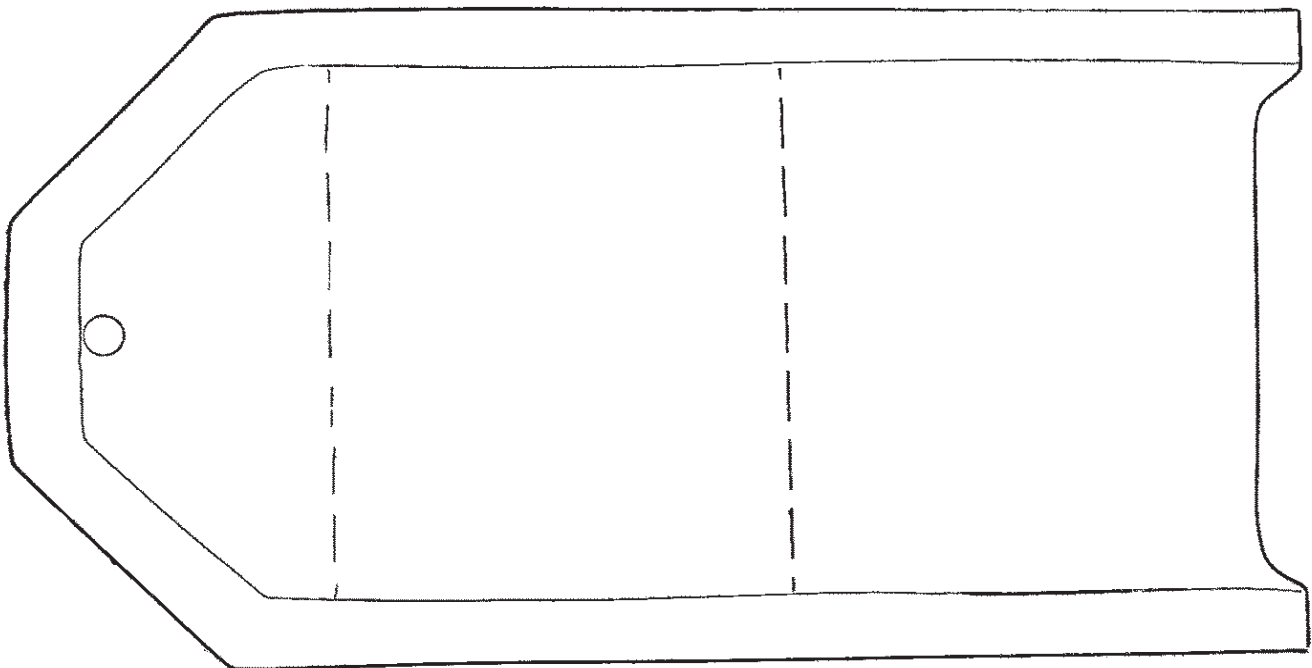
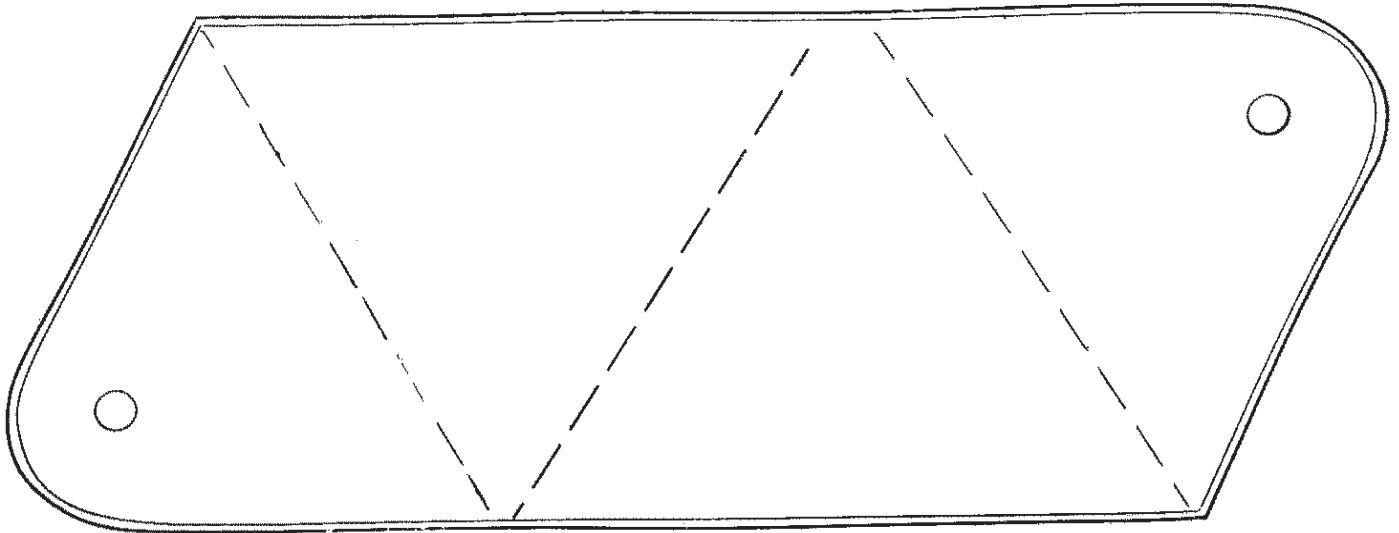
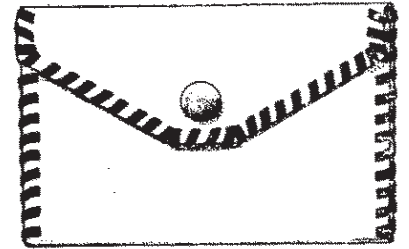
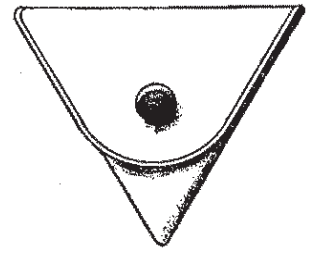

## BILLFOLD

### How to Make

1. Lay out pattern as shown in diagram.
2. Using pattern, cut out various pieces.  
Use skiver for lining.
3. Dampen leather.
4. Select or make design and trace on back piece.
5. Carve and stamp design.
6. Clean leather and apply finish.
7. Cement the pockets to the center piece. Cement a piece of skiver lining to the flesh side of the cover.
8. Punch the top edge of the inside part  $1/8''$  in from the edge.
9. Start lacing at the left end, cementing the end of the lace to the inside of the center piece. Lace across the pockets. Do not cut off the lace which is left over as you will continue lacing from here around the billfold as soon as you assemble it and make thong slits.
10. Cement the edges of the assembled inside part to the edges of the cover, being sure not to cement the top edge.
11. Round all four corners slightly and make thong slits  $1/8''$  in from the edge.
12. Continue lacing around the billfold, using the lace left over from the inside part of the billfold.
13. Cut celluloid to fit the pocket.

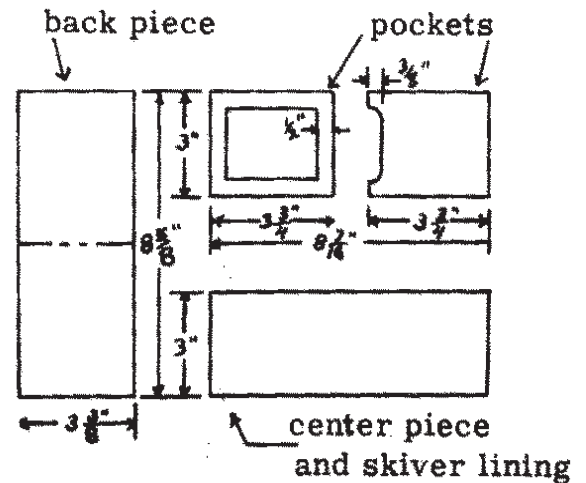

**3/4-INCH LETTERS FOR 1-INCH BELTS**

A B C D E F G

H I J K L M N

O P Q R S T U

V W X Y Z

**1/2-INCH LETTERS FOR BILLFOLDS, ETC.**

A B C D E F G H I J K

L M N O P Q R S T U V

W X Y Z

---

Published and distributed in furtherance of the Acts of Congress of May 8 and June 30, 1914, by the Oregon State University Extension Service, Washington State University Cooperative Extension, the University of Idaho Cooperative Extension System, and the U.S. Department of Agriculture cooperating.

The three participating Extension Services offer educational programs, activities, and materials—without regard to race, color, religion, sex, sexual orientation, national origin, age, marital status, disability, and disabled veteran or Vietnam-era veteran status—as required by Title VI of the Civil Rights Act of 1964, Title IX of the Education Amendments of 1972, and Section 504 of the Rehabilitation Act of 1973. The Oregon State University Extension Service, Washington State University Cooperative Extension, and the University of Idaho Cooperative Extension System are Equal Opportunity Employers. Published September 1975. Reprinted October 1998.

\$2.50