

SOKKIA

On-demand Remote Control System

RC-PR4

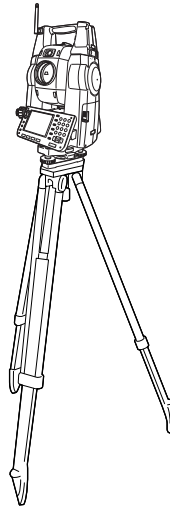
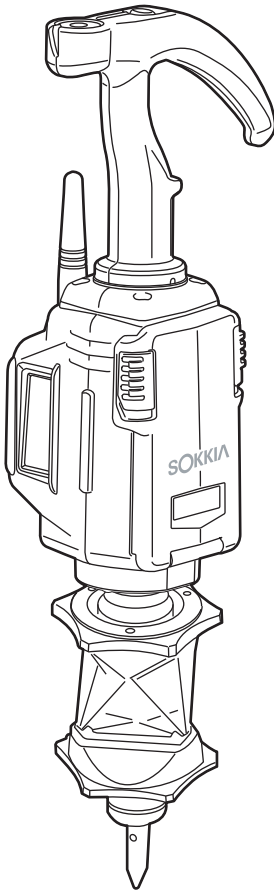

Class 1 Laser Product

SYSTEM MANUAL



Li-ion

CONTAINS Li-ion BATTERY.
MUST BE RECYCLED OR DISPOSED OF PROPERLY.

JSIMA

:This is the mark of the Japan Surveying
Instruments Manufacturers Association.

SOKKIA

On-demand Remote Control System

RC-PR4

Class 1 Laser Product

SYSTEM MANUAL

- Thank you for selecting the On-demand Remote Control System RC-PR4.
- Please read this operator's manual carefully before using this product.
- Verify that all equipment is included.
 "10.1 Standard Equipment"
- The specifications and general appearance of the instrument are subject to change without prior notice and without obligation by Sokkia Topcon Co., Ltd. and may differ from those appearing in this manual.
- The content of this manual is subject to change without notice.
- Some of the diagrams shown in this manual may be simplified for easier understanding.

HOW TO READ THIS MANUAL

Symbols

The following conventions are used in this manual.



: Indicates precautions and important items which should be read before operations.



: Indicates a cross-reference to refer to for additional information.



: Indicates supplementary explanation.



: Indicates an explanation for a particular term or operation.

[DIST] etc. : Indicates softkeys on the total station display.

{ESC} etc. : Indicates operation keys on the total station.

● **POWER** etc. : Indicates RC-Controller LEDs.

Notes regarding manual style

- Except where stated, "SRX" or "Series SRX" means SRX1X/SRX2X/SRX3X/SRX5X, "NET" means NET05AX and NET1AX, "total station" means SRX/NET in this manual.
- Screens and illustrations used in this manual are of SRX (with RC-TS3 handle).
- The On-demand Remote Control System adds remote control functions to the total station. Please read this manual in conjunction with the operator's manual for your instrument.
- The content of this system manual is mainly concerned with explaining the operation of the RC-Controller. For precautions and operating method, please read the operator's manual for your total station or data collector.
- *Bluetooth*[®] is a registered trademark of Bluetooth SIG, Inc.
- All other company and product names featured in this manual are trademarks or registered trademarks of each respective organization.

CONTENTS

| | |
|--|----|
| 1. PRECAUTIONS FOR SAFE OPERATION | 1 |
| 2. PRECAUTIONS | 3 |
| 3. LASER SAFETY INFORMATION | 6 |
| 4. ON-DEMAND REMOTE CONTROL FUNCTIONS | 7 |
| 4.1 Turning Operation Flow | 8 |
| 4.2 Measurement Flow | 9 |
| 5. SYSTEM CONFIGURATION | 12 |
| 5.1 Parts of the RC-Controller | 12 |
| 5.2 System Configuration of the SRX/NET | 14 |
| 5.3 System Configuration of the RC-Controller | 15 |
| 6. SETTINGS FOR THE SRX/NET | 20 |
| 6.1 Settings for <i>Bluetooth</i> Communication | 20 |
| 6.2 Settings for Auto Pointing and Auto Tracking | 22 |
| 6.3 Performing Turning from the SRX/NET | 24 |
| 6.4 Turning Error | 26 |
| 7. BASIC OPERATION | 27 |
| 7.1 Using the Battery | 27 |
| 7.2 Configuring Bluetooth Connections to the SRX/NET | 28 |
| 7.3 Button Operations | 29 |
| 7.4 Communication Status | 31 |
| 7.5 Calibrating the Electronic Compass | 32 |
| 8. ERROR INDICATIONS | 35 |
| 9. TROUBLESHOOTING | 36 |
| 10. STANDARD EQUIPMENT AND OPTIONAL ACCESSORIES | 38 |
| 10.1 Standard Equipment | 38 |
| 10.2 Optional Accessories | 38 |
| 10.3 Power Supply System | 40 |



CONTENTS

| | |
|--|----|
| 11. SPECIFICATIONS | 41 |
| 12. EXPLANATION | 44 |
| 12.1 High Accuracy with the 360° Prism | 44 |
| 13. REGULATIONS | 45 |

1. PRECAUTIONS FOR SAFE OPERATION

For the safe use of the product and prevention of injury to operators and other persons as well as prevention of property damage, items which should be observed are indicated by an exclamation point within a triangle used with WARNING and CAUTION statements in this system manual. The definitions of the indications are listed below. Be sure you understand them before reading the main text.

Definition of Indication

| | | |
|---|----------------|--|
|  | WARNING | Ignoring this indication and making an operation error could possibly result in death or serious injury to the operator. |
|  | CAUTION | Ignoring this indication and making an operation error could possibly result in personal injury or property damage. |



This symbol indicates items for which caution (hazard warnings inclusive) is urged. Specific details are printed in or near the symbol.



This symbol indicates items which are prohibited. Specific details are printed in or near the symbol.



This symbol indicates items which must always be performed. Specific details are printed in or near the symbol.

General



Warning



Do not use the unit in areas exposed to high amounts of dust or ash, in areas where there is inadequate ventilation, or near combustible materials. An explosion could occur.



Do not perform disassembly or rebuilding. Fire, electric shock, burns, or hazardous radiation exposure could result.



When securing the instrument in the carrying case make sure that all catches, including the side catches, are closed. Failure to do so could result in the instrument falling out while being carried, causing injury.



Caution



When mounting the instrument on the pole, tighten the pole-securing knob securely. Failure to tighten the knob properly could result in the instrument falling off the pole, causing injury.



Do not carry the pole with the tip pointed at other persons. A person could be injured if struck by the shoe.











Keep hands and feet away from the tip of the pole when fixing the pole in the ground. A hand or foot stab wound could result.

1. PRECAUTIONS FOR SAFE OPERATION

-  Do not use the carrying case as a footstool. The case is slippery and unstable so a person could slip and fall off it.

Power Supply

Warning





-  Do not short circuit. Heat or ignition could result.
-  Do not place articles such as clothing on the battery charger while charging batteries. Sparks could be induced, leading to fire.
-  Do not use batteries other than those designated. An explosion could occur, or abnormal heat generated, leading to fire.
-  Use only the specified battery charger to recharge batteries. Other chargers may be of different voltage rating or polarity, causing sparking which could lead to fire or burns.
-  Do not use the battery for any other purpose. Fire or burns caused by ignition could result.
-  Do not heat or throw batteries into fire. An explosion could occur, resulting in injury.
-  To prevent shorting of the battery in storage, apply insulating tape or equivalent to the terminals. Otherwise shorting could occur resulting in fire or burns.
-  Do not use batteries or the battery charger if wet. Resultant shorting could lead to fire or burns.

Caution

-  Do not touch liquid leaking from batteries. Harmful chemicals could cause burns or blisters.

Bluetooth wireless technology

Warning

-  Do not use within the vicinity of hospitals. Malfunction of medical equipment could result.
-  Use the instrument at a distance of at least 22 cm from anyone with a cardiac pacemaker. Otherwise, the pacemaker may be adversely affected by the electromagnetic waves produced and cease to operate as normal.
-  Do not use onboard aircraft. The aircraft instrumentation may malfunction as a result.
-  Do not use within the vicinity of automatic doors, fire alarms and other devices with automatic controls as the electromagnetic waves produced may adversely affect operation resulting in an accident.

2. PRECAUTIONS

Precautions

- Protect instruments from heavy shocks or vibration.
- Never touch the RC-Controller laser projection port or the total station beam detector. The ability of the system to perform Turning may be adversely affected.
- Turn the power OFF before removing the battery from the RC-Controller.
- Remove the battery when the RC-Controller is not used for long periods.
- Do not allow sand to come into contact with the battery cover catches or the 360° Sliding Prism ATP1S release button. Otherwise sand particles could jam the motion of the catches/button. In the event that sand has jammed the catches/button, hold the unit so that the catches/button are facing downward and operate the catches/button several times until the sand has fallen out.

Maintenance

- Wipe the RC-Controller laser projection port and total station beam detector with the wiping cloth (total station accessory).
- To clean the RC-Controller, lightly moisten a soft cloth in a mild detergent solution. Wring out excess water until the cloth is slightly damp, then carefully wipe the surface of the unit. Do not use any alkaline cleaning solutions, alcohol, or any other organic solvents on the instrument.
- Wipe the slide pole for the ATP1S with tissue paper or a cloth when prism movement along the pole ceases to be smooth. Do not use lubricants.
- Store the instrument in a dry room where the temperature remains fairly constant.
- Check the RC-Controller for proper adjustment periodically to maintain the instrument accuracy.

Precautions concerning water and dust resistance

The RC-Controller conforms to IP55 specifications for waterproofing and dust resistance when the battery cover is closed and connector caps are attached correctly.

- Make sure that moisture or dust particles do not come in contact with the terminals. Operating the instrument with moisture or dust on the terminals may cause damage to the instrument.
- Make sure that the inside of the carrying case and the instrument are dry before closing the case. If moisture is trapped inside the case, it may cause the instrument to rust.

Charging the battery

- The battery (BDC46C) was not charged at the factory. Charge the battery fully before using.

2. PRECAUTIONS

Precautions concerning *Bluetooth* wireless technology

- Use of this technology must be authorized according to telecommunications regulations of the country where the instrument is being used. Contact your local dealer in advance.
☞ "13. REGULATIONS"
- Sokkia Topcon Co., Ltd. is not liable for the content of any transmission nor any content related thereto. When communicating important data, run tests beforehand to ascertain that communication is operating normally.
- Do not divulge the content of any transmission to any third party.

Radio interference when using *Bluetooth* technology

Bluetooth communication with the RC-Controller uses the 2.4 GHz frequency band. This is the same band used by the devices described below.

- Industrial, scientific, and medical (ISM) equipment such as microwaves and pacemakers
- portable premises radio equipment (license required) used in factory production lines etc.
- portable specified low-power radio equipment (license-exempt)
- IEEE802.11b/IEEE802.11g standard wireless LAN devices

The above devices use the same frequency band as *Bluetooth* communications. As a result, using the RC-Controller within proximity to the above devices may result in interference causing communication failure or reduction of transmission speed.

Although a radio station license is not required for this instrument, bear in mind the following points when using *Bluetooth* technology for communication.

- Regarding portable premises radio equipment and portable specified low-power radio equipment:
 - Before starting transmission, check that operation will not take place within the vicinity of portable premises radio equipment or specified low-power radio equipment.
 - In the case that the instrument causes radio interference with portable premises radio equipment, terminate the connection immediately.
 - In the case that the instrument causes radio interference with portable specified low-power radio equipment, move away from said equipment and try again. If the problem persists contact your local dealer.
- When using the RC-Controller in proximity to IEEE802.11b or IEEE802.11g standard wireless LAN devices, turn off all devices not being used.
 - Interference may result, causing transmission speed to slow or even disrupting the connection completely. Turn off all devices not being used.
- Do not use the RC-Controller in proximity to microwaves.
 - Microwave ovens can cause significant interference resulting in communication failure. Perform communication at a distance of 3m or more from microwave ovens.
- Refrain from using the RC-Controller in proximity to televisions and radios.
 - Televisions and radios use a different frequency band to *Bluetooth* communications. However, even if the RC-Controller is used within proximity to the above equipment with no adverse effects with regard to *Bluetooth* communication, moving a *Bluetooth*-compatible device (including

the RC-Controller) closer to said equipment may result in electronic noise in sound or images, adversely affecting the performance of televisions and radios.

Precautions regarding transmission

- For best results
 - When using in conjunction with a total station, perform communication within a line-of-sight distance of approximately 300m. The usable range becomes shorter when obstacles block the line of sight, or devices other than total stations, such as PDAs or computers, are used. Wood, glass and plastic will not impede communication but the usable range becomes shorter. Moreover, wood, glass and plastic containing metal frames, plates, foil and other heat shielding elements as well as coatings containing metallic powders may adversely affect *Bluetooth* communication and concrete, reinforced concrete, and metal will render it impossible.
 - Use a vinyl or plastic cover to protect the instrument from rain and moisture. Metallic materials should not be used.
 - The direction of the *Bluetooth* antenna can have adverse effects upon usable range. For best results make sure that the antennas of both the RC-Controller and the companion device are pointing towards one another.

- Reduced range due to atmospheric conditions

The radio waves used by the RC-Controller may be absorbed or scattered by rain, fog, and moisture from the human body with the limit of usable range becoming lower as a result. Similarly, usable range may also shorten when performing communication in wooded areas. Moreover, as wireless devices lose signal strength when close to the ground, perform communication at as high a position as possible.



- Sokkia Topcon Co., Ltd. cannot guarantee that all *Bluetooth* devices are compatible with the On-demand Remote Control System.

Exceptions from responsibility

- The user of this product is expected to follow all operating instructions and make periodic checks (hardware only) of the product's performance.
- The manufacturer, or its representatives, assumes no responsibility for results of faulty or intentional usage or misuse including any direct, indirect, consequential damage, or loss of profits.
- The manufacturer, or its representatives, assumes no responsibility for consequential damage, or loss of profits due to any natural disaster, (earthquake, storms, floods etc.), fire, accident, or an act of a third party and/or usage under unusual conditions.
- The manufacturer, or its representatives, assumes no responsibility for any damage (change of data, loss of data, loss of profits, an interruption of business etc.) caused by use of the product or an unusable product.
- The manufacturer, or its representatives, assumes no responsibility for any damage, and loss of profits caused by usage different to that explained in the operator's manual.
- The manufacturer, or its representatives, assumes no responsibility for damage caused by incorrect operation, or action resulting from connecting to other products.

3. LASER SAFETY INFORMATION

RC-Controller is classified as a Class 1 Laser Product according to IEC Standard Publication 60825-1 Ed. 2.0: 2007 and United States Government Code of Federal Regulation FDA CDRH 21CFR Part1040.10 and 1040.11 (Complies with FDA performance standards for laser products except for deviations pursuant to Laser Notice No.50, dated June 24, 2007.)

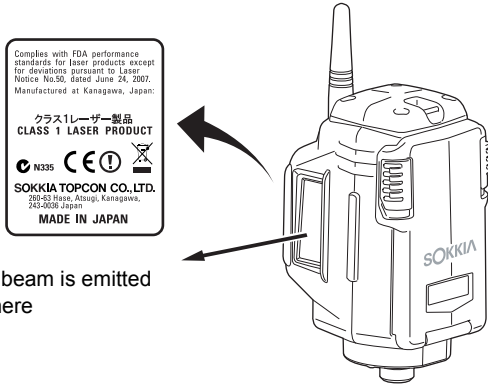

Laser beam is emitted from here

Warning

- Use of controls or adjustments or performance of procedures other than those specified herein may result in hazardous radiation exposure.
- Never point the laser beam at another person. If the laser beam strikes skin or an eye, it could cause serious injury.
- If an eye injury is caused by exposure to the laser beam, seek immediate medical attention from a licensed ophthalmologist.

Caution

- Perform checks at start of work and periodic checks and adjustments with the laser beam emitted under normal conditions.
- When the instrument is not being used, turn OFF the power.
- When disposing of the instrument, destroy the battery connector so that the laser beam cannot be emitted.
- Operate the instrument with due caution to avoid injuries that may be caused by the laser beam unintentionally striking a person in the eye. Avoid setting the instrument at heights at which the path of the laser beam may strike pedestrians or drivers at head height.
- Never point the laser beam at mirrors, windows or surfaces that are highly reflective. The reflected laser beam could cause serious injury.

4. ON-DEMAND REMOTE CONTROL FUNCTIONS

The On-demand Remote Control System works as follows. A laser is emitted from the laser projection port on the RC-Controller. The total station rotates until its beam detector receives this beam. In this way the total station is able to detect the position of the RC-Controller. This operation is called "Turning".

With the On-demand Remote Control System it is possible for a single operator to perform measurements, unaided, at multiple measurement points.

The RC-Controller incorporates a *Bluetooth* unit which allows simultaneous communication with both the total station and a data collector.

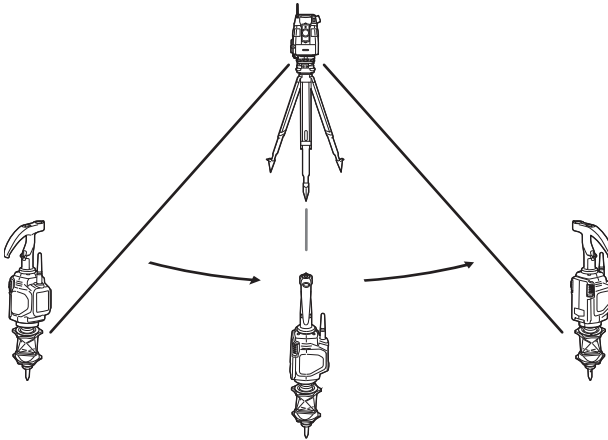

Electronic compass

The RC-Controller is equipped with an electronic compass. Using the Earth's magnetism, this compass can detect the RC-Controller's horizontal angle from magnetic north. The current angle is compared with that for the previous measurement to estimate the direction in which the RC-Controller moved following the previous measurement. By then taking into account the aspect of the telescope the RC-Controller can instruct the total station regarding the quickest rotation direction to the prism.

The onboard electronic compass was calibrated before being shipped from the factory. A function within the compass will automatically perform any necessary calibration in response to changes in the magnetic field.



Auto Pointing and Auto Tracking

When Auto Pointing is performed, the total station analyses the image of the prism in the field of view and moves the telescope to sight the center of this prism. When used in conjunction with the Auto Tracking function, the SRX/NET will then "track" the prism as it is moved to the next measurement point. When the prism has been "lost" due to an obstacle in the line-of-sight or operation has been interrupted, the On-demand Remote Control System allows you to quickly resume operation where you left off.

4.1 Turning Operation Flow

To perform Turning, follow the procedure below.

 For measurement procedure, see "4.2 Measurement Flow"

1. Point the RC-Controller laser projection port and prism in the direction of the total station and instruct the instrument to start Turning. A laser beam is emitted from the projection port. At the same time, the *Bluetooth* unit (COM 1) relays the instruction to begin Turning.
2. The total station begins to rotate horizontally, searching for the emitted laser beam. If it is not detected by the end of the second rotation, an error occurs.

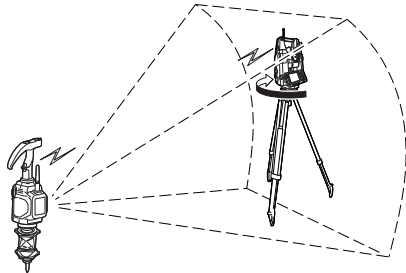

3. Once the position of the horizontal direction has been determined, the total station telescope then begins to rotate along the vertical axis searching for the position of the prism.

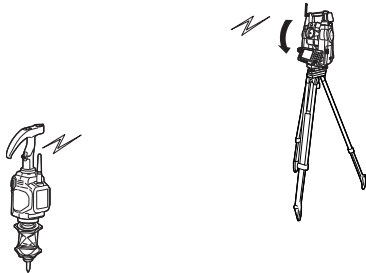

4. Once the position of the vertical direction has been determined an audio sounds and the total station automatically sights the prism in the field of view.

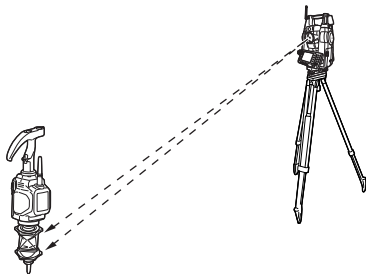

5. The SRX/NET tracks a sighted prism as it is moved to the next measurement point when Auto Tracking is set.



- The time limit for Turning is 60 seconds from the start of Turning operation. If the operation exceeds this time limit, an error occurs.



- When Auto Tracking has been selected, the SRX/NET will start tracking a moving prism once Turning to that prism has been completed.

4.2 Measurement Flow

This section explains the measurement procedure for a single operator working from the RC-Controller. An operator working alone will need a data collector (available as an optional accessory).





- When reflected laser signal is strong (object with high reflection factor):
If there is an object with a high reflection factor, such as a window or standing water, in the vicinity of the total station/prism, the laser beam may be reflected and Turning operation performed pointing at the object instead of the RC-Controller. In this case the accuracy of measurement results may be adversely affected.
- Fix the pole vertically over the measurement point.





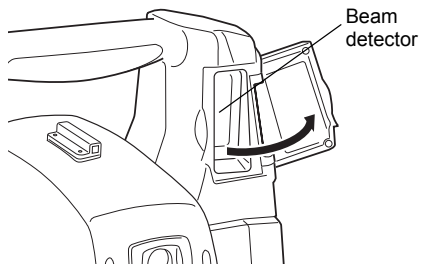

- For communication settings for data collectors etc., see the operator's manual for your respective device.

►PROCEDURE



1. Connect the instruments.
 "5. SYSTEM CONFIGURATION"
2. Switch ON the power to the total station. Open the beam detector cover.
3. Set measurement settings for the total station and select prism type.
 "6.2 Settings for Auto Pointing and Auto Tracking"
Prism selection: Operator's Manual "30.3 EDM Settings"



4. ON-DEMAND REMOTE CONTROL FUNCTIONS

4. Check that SRX/NET *Bluetooth* settings are made and the instrument is ready for communication.
 "6.1 Settings for Bluetooth Communication"
After completing the total station preparations above, the next step is to prepare the RC-Controller.
5. Press the POWER button  to switch ON the RC-Controller. ● **POWER** is Lit.
6. Fix the pole vertically over the measurement point and point the laser projection port of the RC-Controller roughly in the direction of the total station.
If the distance between the total station and the RC-Controller is over 100m (normal atmospheric conditions)/150m (good atmospheric conditions), set to Far Mode by pressing the FAR button  (● **FAR** is Lit).
 For atmospheric conditions, see "7.3.2 Setting Distance Mode"
7. When the total station is instructed (using a data collector) to perform distance measurement, Turning operation is carried out. Measurement starts when this Turning operation is complete.

Note

- When returned laser signal is weak (object with low reflection factor):
Even if the laser beam received by the total station has been reflected off an unrelated object, or sunlight has entered the beam detector, the total station still attempts to complete the stages of Turning operation as far as Auto Pointing. When the total station judges that the laser beam has not travelled directly from the RC-Controller to the beam detector, this position reading taken in error is nullified and the total station automatically continues Turning operation at the next position. However, the time limit for Turning is 60 seconds from the start of Turning operation and if the operation exceeds this time limit, an error occurs.
- Using the SRX guide light when performing Turning operation allows the operator to confirm whether or not the SRX has correctly located the RC-Controller laser beam. When a work site contains highly reflective surfaces it is recommended that measurement is performed using the guidelight. If the SRX has completed Turning operation pointing at the RC-Controller, both the red and green guide lights are visible from the position of the RC-Controller.
 For the total station guide light, see the Series SRX Operator's Manual
- With data collectors it is possible to specify the rotation direction for Turning operation before performing distance measurement.
 For operation procedure, see the operator's manual for your data collector.



Height difference and slope distance

The maximum measuring range depends on the height difference between the total station and the RC-Controller.

The shaded area in the graph below represents the measurement range when set to Far Mode.

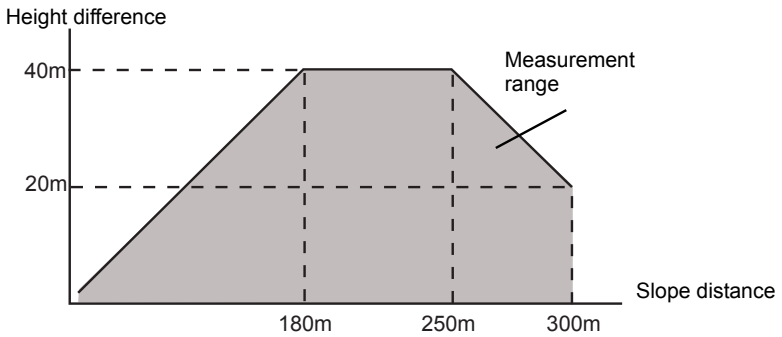

5. SYSTEM CONFIGURATION

5.1 Parts of the RC-Controller

● RC-Controller (RC-PR4)

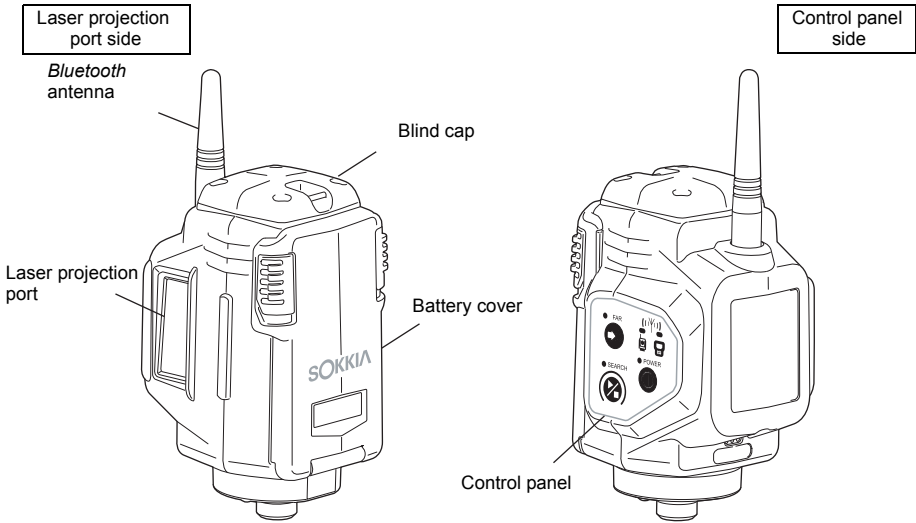

Control panel

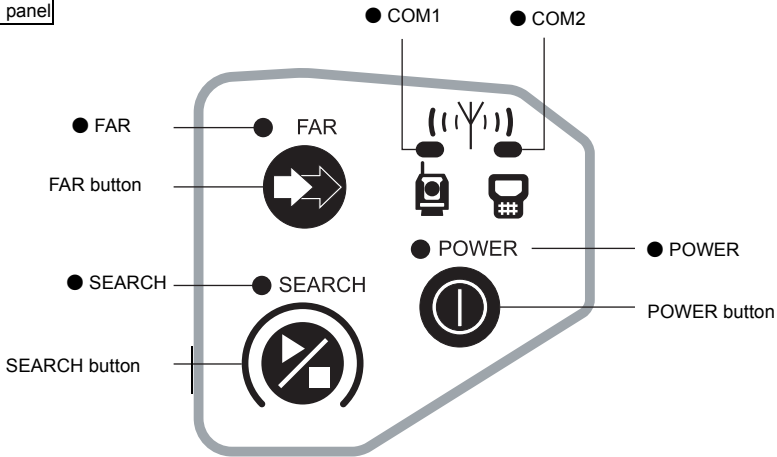

Note

- COM1 is for communication with the total station. COM2 is for communication with the data collector.

● RC-Handle (RC-PRH4)

The RC-Handle incorporates a circular level.

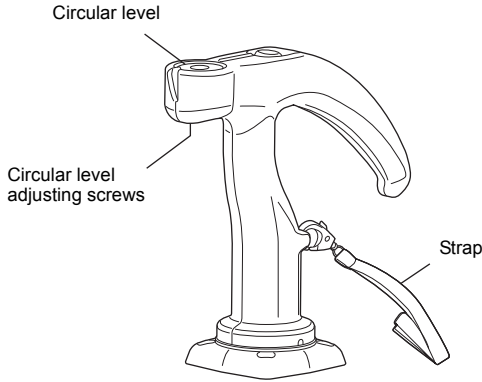

Adjusting the circular level

First attach the RC-Handle and 360° Prism ATP1 to the RC-PR4, and then attach the RC-PR4 to the instrument height adapter (AP41) etc. Holding the RC-Handle, keep the instrument level. Check the position of the bubble of the circular level. If the bubble is not off-center, no adjustment is necessary. If the bubble is off-center, perform the following adjustment. First confirm the off-center direction. Use the adjusting pin to loosen the circular level adjustment screw on the side opposite to the direction the bubble is displaced to move the bubble to the center. Adjust the adjusting screws until the tightening tension of the three screws is the same to align the bubble in the middle of the circle.

5.2 System Configuration of the SRX/NET

Only instruments incorporating a handle equipped with a beam detector (RC-TS3 or RC-TS3A) can be used with the On-demand Remote Control System.

Always open the beam detector cover when using the On-demand Remote Control System.



- The beam detector cover can be damaged if forced open beyond a certain angle. Always close the beam detector cover before moving the instrument.

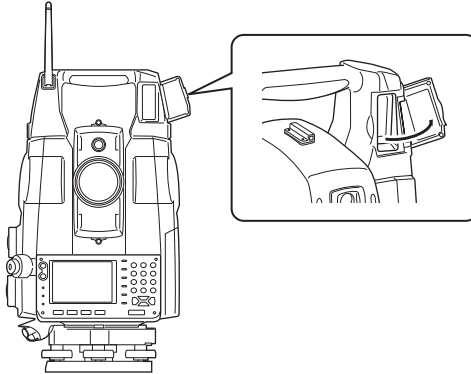

5.3 System Configuration of the RC-Controller

For use with other prism types, contact your local dealer.

● Pin Pole Type

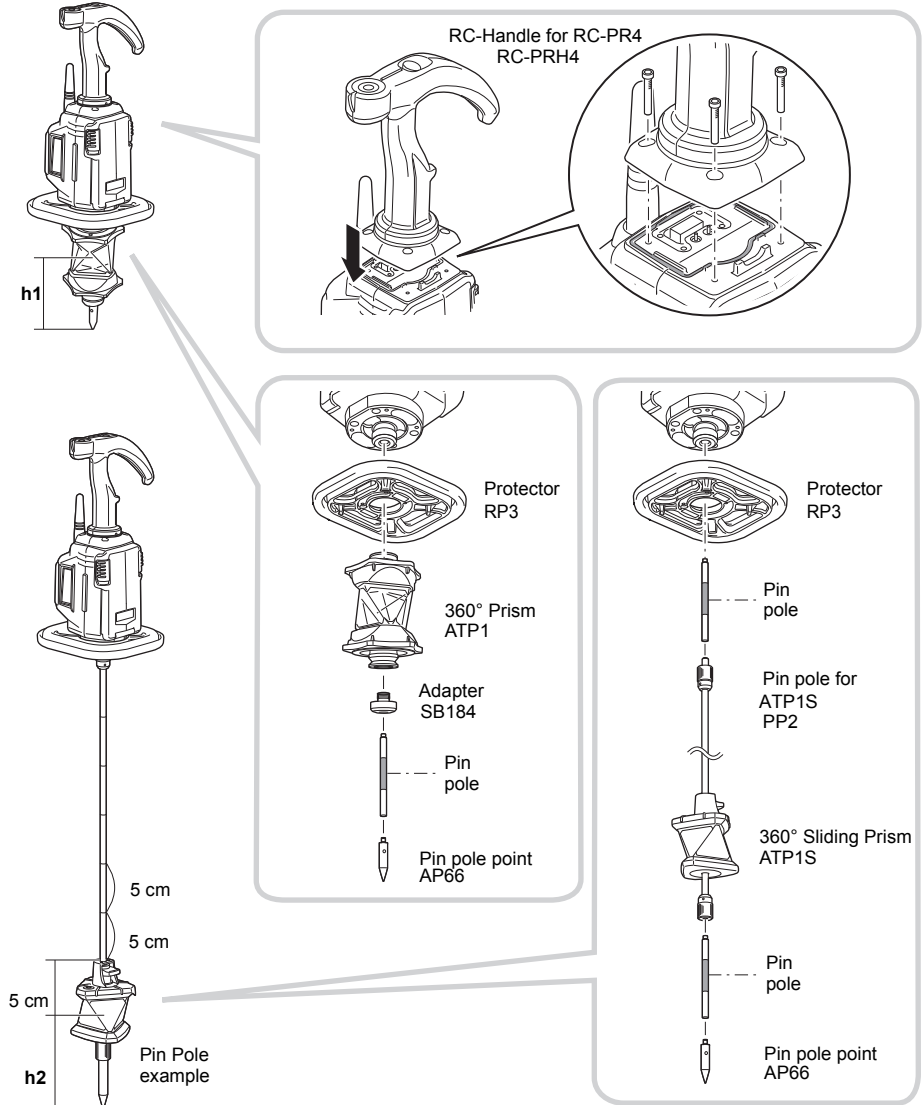

● Range Pole Type

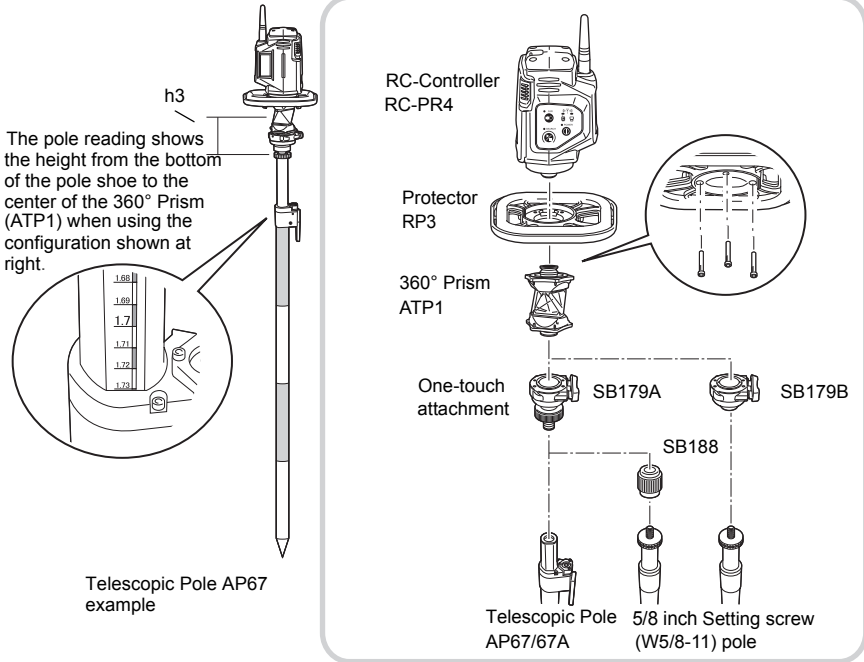

● Height to center of prism

The height to the center of the prism differs as shown below depending on the selection of prism/pole combination. Read the following in conjunction with the above diagrams.

Pin Pole Type

- h1: Height from the tip of the prism foot to the center of prism is 10 cm when mounting the 360° Prism ATP1 on the adapter SB184 and stainless steel prism foot AP66.
- h2: Height from the tip of the prism foot to the center of prism is 10 cm when mounting the 360° Sliding Prism ATP1S on the pin pole for ATP1S PP2 and the prism is at the lowest position on the pole. Graduations on the pin pole for ATP1S PP2 are at 5cm intervals. Aligning the top of the sliding prism with one of the graduations then sliding up or down to the next graduation will result in a vertical movement of 5 cm. Maximum range of the sliding pole is 40 cm.



•Do not subject the prism to strong shock when set at the highest position on the pin pole. Otherwise, the prism may slip downwards.

Range Pole Type

- h3: Height from the base of the one-touch attachment to the center of prism is as follows when mounting the 360° Prism ATP1 on the Range Pole.

| | |
|--|--------|
| AP67/67A with SB179A: | 87 mm |
| 5/8 inch Setting screw pole with SB179A and SB188: | 130 mm |
| 5/8 inch Setting screw pole with SB179B: | 74 mm |

● **Attaching/Releasing the One-touch attachment**

Slide the lock release button to the right then press to release the One-touch attachment.

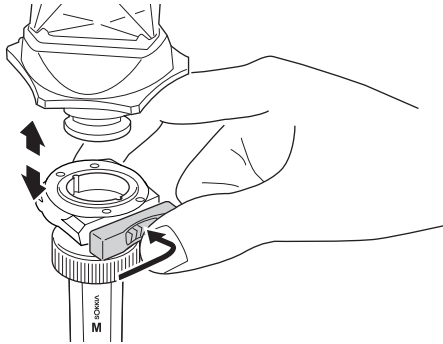

● **Attaching the One-touch attachment (SB179A) to the range pole (AP67/67A)**

Attach to the pole using the following procedure.

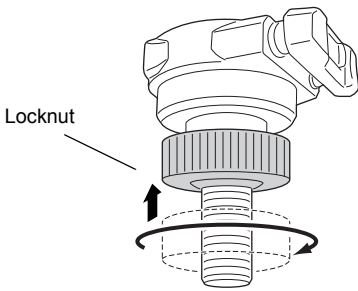

1. Rotate the locknut counterclockwise until it reaches the upper limit.

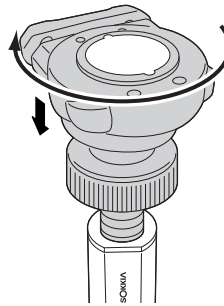

2. Rotate the One-touch attachment clockwise until the locknut meets the top of the pole.

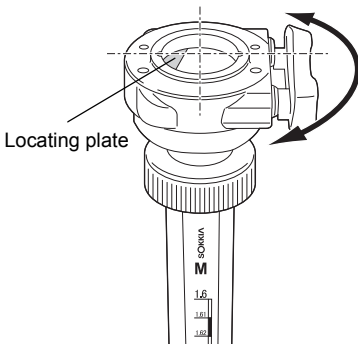

3. Adjust until the locating plate is on the left (with the graduations facing forward).

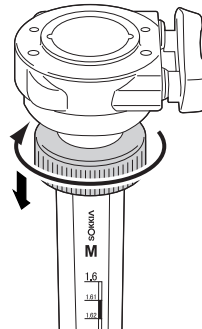

4. Rotate the locknut towards the pole until secured in place.

● Adjusting position of 360° Prism (ATP1S) on pin pole (PP2)

Pressing the release button allows the prism to slide up and down the pin pole. Release the release button to secure the prism at the desired position.



- A strong shock, such as dropping the prism, when the prism is mounted on the pin pole or when used as a stand-alone prism may cause the release button to lock. In this event, turn the prism upside down so the the release button is facing downwards and lightly tap the prism or pin pole on a hard surface such as concrete.

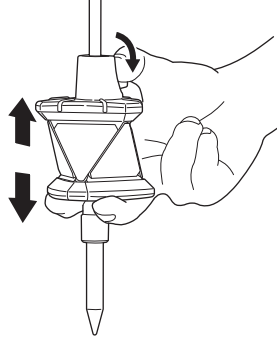

● Connecting the 360° Prism to the RC-Controller

Attach the 360° Prism to the RC-Controller so that the center of the RC-Controller and the sighting direction of the prism are aligned and the laser projection port is pointing in the same direction as the prism sighting direction.

Check the stickers to make sure the prism is the right way up.

 Prism sighting direction "12.1 High Accuracy with the 360° Prism"

Adjust as follows when the center of the RC-Controller and the sighting direction of the prism are not aligned. Detach the Protector RP3 and loosen adjusting screw (1) with the hexagonal wrench. Re-position the prism, then fix in place. If the RC-Controller and sighting direction are still not aligned, detach the 360° Prism and adjust adjusting screw (2). First move adjusting screw (2) fully to the left or right position and secure in place, then attempt re-alignment again using adjusting screw (1). If the desired result is still not obtained try moving adjusting screw (2) to the opposite position, then attempt re-alignment with adjusting screw (1) again.

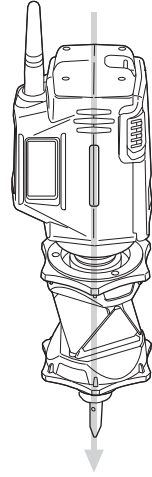

Direction in which 360° Prism is attached

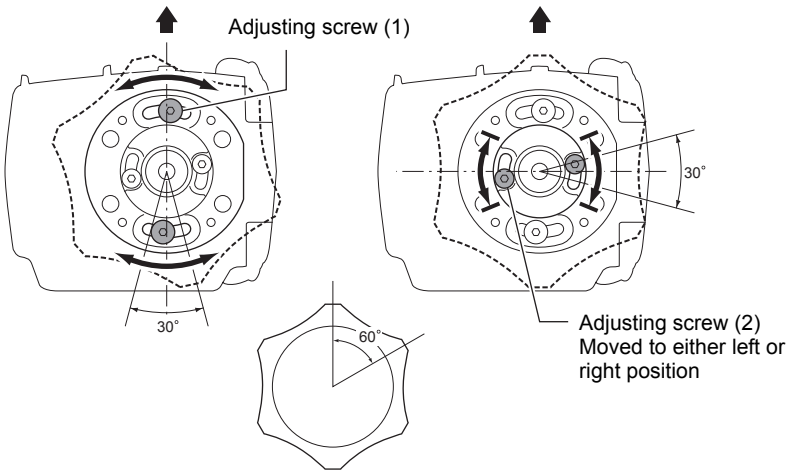

6. SETTINGS FOR THE SRX/NET

The following settings are necessary in order to use the SRX/NET as part of the On-demand Remote Control System.

- For other functions and operations, see the operator's manual for your total station.
For further details regarding *Bluetooth* communications, see "2. PRECAUTIONS Precautions concerning Bluetooth wireless technology"

6.1 Settings for *Bluetooth* Communication



- RC Handle with *Bluetooth* (RC-TS3) is necessary for *Bluetooth* communication.
- Bluetooth* communication causes SRX/NET battery power to be depleted at a rate higher than that for normal operation.

When communicating between the total station and RC-Controller using *Bluetooth* wireless technology, the modem for the total station will be set as the "Master" device and the SRX/NET will be set as the "Slave" device.

1. Select "Comms" in SETTINGS mode. Set "Comms mode" in the Comms setup tab to "*Bluetooth*".

Check that the status panel icon has changed to



- Changing communication settings during *Bluetooth* communication will cancel the connection.

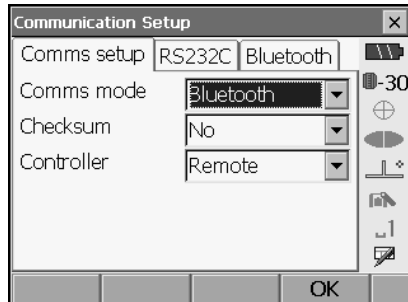
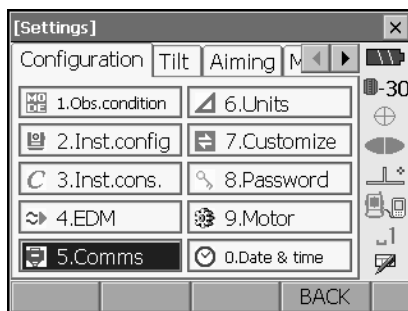

- The  status bar icon cannot be tapped in <Communication Setup>.





- Select "Slave" as the SRX/NET mode and press **[OK]**. Selection can also be made by tapping the  icon in the status panel until a menu appears.

Note

- When communicating between a data collector and the RC-Controller using *Bluetooth* wireless technology, set modem for the data collector as the "Slave" device. Set the data collector as the "Master" device.

 "7.4 Communication Status"  *Bluetooth* connections"

- The display returns to Meas mode and SRX/NET enters "Waiting" mode. The RC-Controller searches for the total station wireless device and initiates a connection.
-  "7.2 Configuring Bluetooth Connections to the SRX/NET"

- When a connection has been successfully established  is displayed in the status bar.

- COM1 on the RC-Controller control panel is lit.

Note

- Press **[Info]** in the *Bluetooth* tab to display the *Bluetooth* device address.

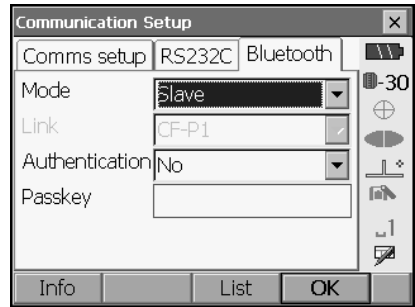

6.2 Settings for Auto Pointing and Auto Tracking



- Auto Pointing model does not support Auto Tracking.

► PROCEDURE

1. Select "Motor" in <Configuration>. Set Auto Pointing/Auto Tracking functions in the Configuration tab. For Auto Pointing only set "A.T. Setting" to "Search". For Auto Tracking, set "A.T. Setting" to "Track" and "Accu. search" to "Fine". Set "Srch method" to "R.C.".

Settings and Options

- (1) Accu. search
 - Fine/Rapid
- (2) A.T. Setting
 - Auto Pointing model: None/Search
 - Auto Tracking model: None/Search/Track
- (3) Srch method
 - G.S./R.C.

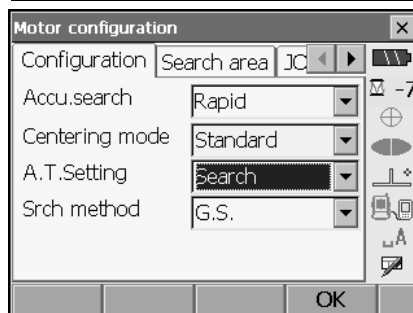
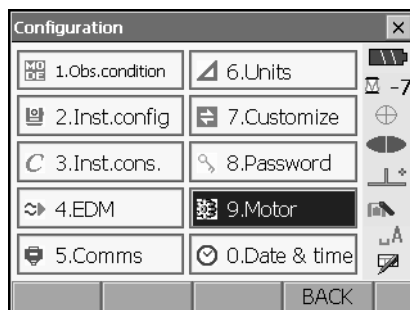

Accu. search

Set to "Fine" for greater accuracy during Auto Pointing. Make sure that the prism is securely mounted on a tripod etc.

Set to "Rapid" when supporting the pole by hand.

When "Fine" is set the SRX/NET checks that the prism position is stable, then searches for the prism direction. Once the SRX/NET confirms that the prism is sighted at the approximate center of the field-of-view, Auto Pointing is complete. Although this setting provides greater accuracy, when supporting the pole by hand, hand movements will result in Auto Pointing taking too long to complete and a "Time out" error will occur.

When "Rapid" is set however, Auto Pointing can be performed even with slight instability of prism position or minor shifts of target position in the field-of-view. The SRX/NET will use the data obtained to determine the direction of the target.

Auto Pointing performed using the "Rapid" setting can be completed in a much quicker time than the "Fine" setting.

"Fine" is recommended when a high level of measurement accuracy is needed. Sighting accuracy for Auto Pointing will be the "Fine" setting. The range for the offset between the target

and reticle after Auto Pointing completed changes as shown below depending on the Accu. search. setting.

"Fine": ± 5" (approx.)

"Rapid": ± 30" to ± 10' (depending on distance)

- Set "Srch. method" to "R.C." in order to start Turning operation in response to a Turning command issued from the RC-Controller. Set to "G.S." to search for the target in the area specified in the Search area tab.

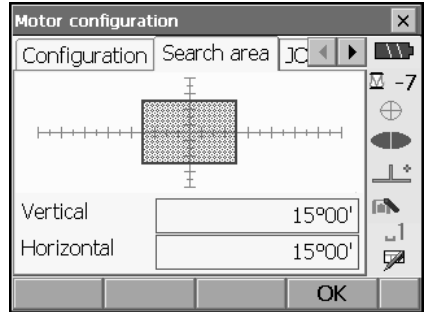

- When necessary, set the JOG dial turning speed for vertical and horizontal rotation of the telescope. The "Shift" point signifies the dial turning speed at which telescope rotation switches from the Lo speed setting to the Hi speed setting. The higher the "Shift" point setting, the faster the jog dial turning speed needed to activate the "Hi" speed setting.

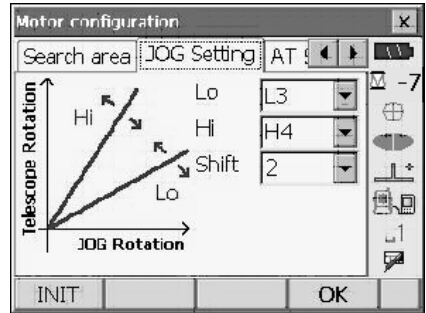

Settings and Options

- Lo
1 to 4 (steps. 4 is fastest)
- Hi
1 to 7 (steps. 7 is fastest)
- Shift point
1 to 6 (steps)

Press **[INIT]** to return JOG Setting tab settings only to their factory settings.

- Press **[OK]**.

6.3 Performing Turning from the SRX/NET

It is possible to allocate SRX/NET softkeys for both designating the Turning direction, and issuing the instruction to start Turning.

 For allocating softkey functions, see the Series SRX or NET05AX/NET1AX Operator's Manual

● SRX softkey operation

- **[RC]:** SRX/NET begins Turning directly in the direction of the RC-Controller.
- **[← RC]:** SRX/NET begins Turning in a counterclockwise (left) direction (from the point of view of the operation panel).
- **[RC →]:** SRX/NET begins Turning in a clockwise (right) direction (from the point of view of the operation panel).
- **[RC Cont]:** Nullifies the current measurement position and continues Turning operation.

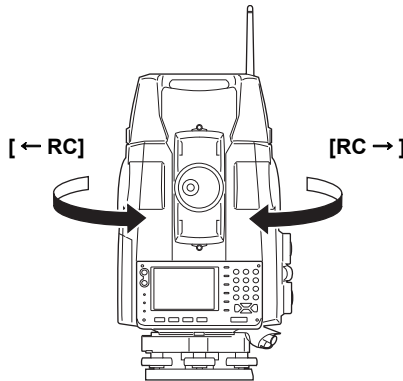

The functions of the following softkeys change according to the settings made in "A. T. Setting" and "Srch method" in <Motor configuration>.

When "Search" is set

| "Motor" setting Softkey | When "Search" set in "A.T. Setting" | | When "None" set in "A.T. Setting" |
|----------------------------|---|--|---|
| | "Srch method" is R.C. | "Srch method" is G.S. (Global Search) | |
| [SRCH] | Performs Auto Pointing | | |
| [DIST] | Performs Turning operation then angle/distance measurement | Performs Auto Pointing then angle/distance measurement | Performs angle and distance measurement |
| [RC] | Rotates directly in the direction of the RC-Controller then performs Auto Pointing | | |
| [←RC] | Rotates in a counterclockwise direction (from the point of view of the RC-Controller) then performs Auto Pointing | | |
| [RC→] | Rotates in a clockwise direction (from the point of view of the RC-Controller) then performs Auto Pointing | | |
| [RC Cont] | Nullifies the current measurement position then continues Turning operation | | |

| | | | |
|--|---|---|---------------------------|
| [AT On] (Auto Tracking model only) | Performs Turning operation then Auto Tracking | Performs Auto Pointing then Auto Tracking | Performs Auto Tracking *1 |
|--|---|---|---------------------------|

● When "Track" is set (Auto Tracking model only)

| "Motor" setting Softkey | When "Track" set in "A.T. Setting" | | When "None" set in "A.T. Setting" |
|----------------------------|---|--|---|
| | "Srch method" is R.C. | "Srch method" is G.S. (Global Search) | |
| [SRCH] | Performs Auto Pointing then Auto Tracking | | Performs Auto Pointing |
| [DIST] | Performs Turning operation then distance measurement/Auto Tracking | Performs Auto Pointing then distance measurement/Auto Tracking | Performs angle and distance measurement |
| [RC] | Rotates directly in the direction of the RC-Controller then performs Auto Pointing | | Rotates in the direction specified by the RC-Controller then performs Auto Pointing |
| [<-RC] | Rotates in a counterclockwise direction (from the point of view of the RC-Controller) then performs Auto Pointing/Auto Tracking | | Rotates in a counterclockwise direction (from the point of view of the RC-Controller) then performs Auto Pointing |
| [RC->] | Rotates in a clockwise direction (from the point of view of the RC-Controller) then performs Auto Pointing/Auto Tracking | | Rotates in a clockwise direction (from the point of view of the RC-Controller) then performs Auto Pointing |
| [RC Cont] | Nullifies the current measurement position then continues Turning operation/Auto Tracking | | Nullifies the current measurement position then continues Turning operation |
| [AT On] | Performs Turning operation then Auto Tracking | Performs Auto Pointing then Auto Tracking | Performs Auto Tracking *1 |

*1: Pressing **[AT On]** when A.T. Setting is set to "None" will result in one of the following operations being performed.

When "R.C." selected: Performs Turning operation then Auto Tracking

When "G.S." selected: Performs Auto Pointing then Auto Tracking

6.4 Turning Error

When Turning fails to detect the prism, an error occurs

When the laser beam from the RC-Controller is reflected off an unrelated object the SRX/NET completes Turning operation pointing at the object instead of the RC-Controller. When this happens, press **[RC Cont]** to nullify the current measurement position and continue Turning operation.



Lost Prism

In the event that an obstacle prevents the SRX/NET sighting the target during Auto Tracking, the instrument will predict the direction in which the target will travel and continue Auto Tracking based on this prediction for the time period set in "Forecast time". If the SRX/NET re-acquires the target in this predicted direction, Auto Tracking continues without change. If the target is not re-acquired however, the target is considered "lost" ("Target lost" status) and the SRX/NET enters either "Prism wait" or "Search" mode. When "Prism wait" has been selected in "Target lost" and the target enters the field of view or a Turning command is received from the RC-Controller within 60 seconds, the SRX/NET will search for the target, then resume Auto Tracking. If the target is not re-acquired within 60 seconds, sighting terminates.

Start Auto Tracking procedure again from step 1.

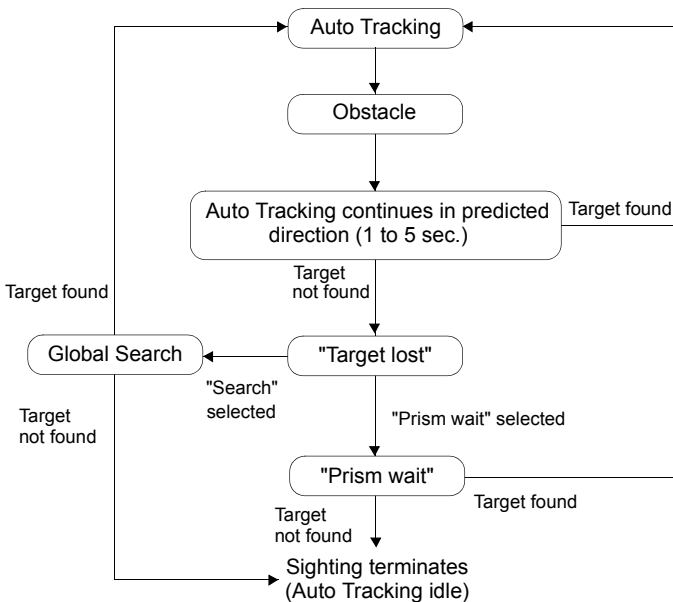

For error messages, see the Series SRX or NET05AX/NET1AX Operator's Manual

7. BASIC OPERATION

This section explains basic operation of the RC-Controller.

7.1 Using the Battery

Mount the charged battery (BDC46C). When the remaining battery power becomes low, the ● **POWER** Flashes.

 Types of power source: "10.3 Power Supply System"



- Remove the battery when the instrument is not being used.
- Before removing the battery, turn off the power to the instrument. If the battery is removed while the power is switched on, a warm boot occurs.
- When installing/removing the battery, make sure that moisture or dust particles do not come in contact with the inside of the instrument.

► PROCEDURE Mounting the battery

1. Slide down the catches on the battery cover to open.
2. Insert the battery in the direction of the arrow printed on the side and press down.
3. Close the battery cover. A click is heard when the cover is secure.

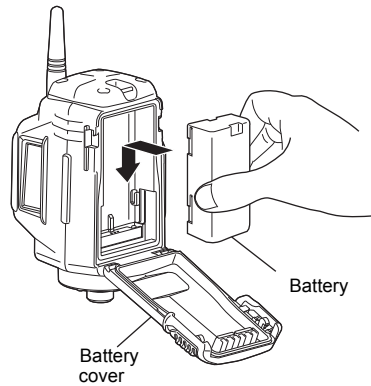



► PROCEDURE Removing the battery

1. Slide down the catches on the battery cover to open.
2. Push the battery up to release.
3. Close the battery cover. A click is heard when the cover is secure. Make sure that both catches on the battery cover have returned to their original positions.



7.2 Configuring *Bluetooth* Connections to the SRX/NET







The RC-Controller should be set to "Master" when pairing the total station with the RC-Controller for *Bluetooth* wireless communication for the first time. The RC-Controller searches for the total station wireless device and initiates a connection.

1. Turn on the total station and set communication settings.
 "6.1 Settings for Bluetooth Communication"
2. Turn on the RC-Controller while pressing the SEARCH button . ● **FAR** flashes and the RC-Controller searches for the total station wireless device. When the search is complete an audio tone sounds to indicate the number of devices found. Proceed to step 3.

If the total station wireless device is not found an audio tone sounds continuously and the RC-Controller powers off automatically. Check communication settings and conditions.

 "2. PRECAUTIONS Precautions concerning Bluetooth wireless technology"

3. ● **COM1** and ● **FAR** are lit when the audio tone stops. When  is displayed on the status bar of the total station companion device, press the FAR button  to confirm the pairing. The RC-Controller automatically powers off.

When  is displayed on the status bar of the total station companion device, the RC-Controller is currently paired to different device. Press the SEARCH button  to switch the pairing from the current device to the next locally available device. If  is displayed after a brief period, press the FAR button  to confirm the pairing. If however,  continues to be displayed, press the FAR button  until the status bar icon changes. If the SEARCH button  is pressed as many times as there are locally available devices and the status bar icon still does not change, an audio tone sounds continuously and the RC-Controller automatically powers off.

The wireless device for the total station was not found. Check communication settings and conditions.

 "2. PRECAUTIONS Precautions concerning Bluetooth wireless technology", "6.1 Settings for Bluetooth Communication"

7.3 Button Operations

The RC-Controller is operated using the buttons on the control panel.

7.3.1 Power ON/OFF

Press the POWER button  to switch ON the RC-Controller. ● **POWER** is Lit.

Press and hold the POWER button  to switch OFF the RC-Controller. An audio tone sounds twice and ● **POWER** Flashes before an audio tone sounds and the RC-Controller switches OFF.

7. BASIC OPERATION

7.3.2 Setting Distance Mode

The FAR button  is used to set the Distance Mode depending on the distance between the total station and the RC-Controller.

Pressing the FAR button  switches the ● **FAR** from Lit to Off and vice versa.

Lit: Far Mode

Off: Standard Mode

Set to Far Mode when the distance between the total station and the RC-Controller is over 100m (normal atmospheric conditions)/150m (good atmospheric conditions).

Atmospheric conditions

- Normal: slight haze, visibility about 20 km, sunny periods, weak scintillation.
- Good: no haze, visibility about 40 km, overcast, no scintillation.





- Set to Standard Mode (● **FAR** is Off) when the total station and RC-Controller are close.
- Using Far Mode (● **FAR** is Lit) when the total station and RC-Controller are close could result in the emitted laser beam being reflected off nearby objects. If this happens the total station will complete Turning pointing to the object instead of the RC-Controller.
- Set to Far Mode (● **FAR** is Lit) even when the distance between the total station and the RC-Controller is 100m or less if the height difference is large.
- Far Mode depletes battery power at a greater rate than Standard Mode.

The FAR button  cannot be pressed while the total station is Turning.

7.3.3 Starting Turning Operation

Press the SEARCH button  to start Turning operation.

- ● **SEARCH** Flashes when the total station is currently performing Turning operation.
- When Turning operation is complete, an audio tone sounds and ● **SEARCH** remains Lit for approx. 2 seconds.
- Press the SEARCH button  during operation to stop Turning.
- If the total station fails to detect the prism, a long audio tone sounds and ● **SEARCH** Flashes quickly for approx. 2 seconds to indicate that an error has occurred.
- When the laser beam from the RC-Controller is reflected off a unrelated object the total station completes Turning operation pointing at this object instead of the RC-Controller. When this happens, press and hold the SEARCH button  to nullify the current measurement position and continue Turning operation.

7.4 Communication Status

The *Bluetooth* wireless modem incorporated in the RC-Controller allows simultaneous communication between the RC-Controller and both the total station and data collector. COM1 is designed for long-range (line-of-sight distance up to 300m) communication with the total station. COM2 is for communication with data collectors. COM2 usable range varies depending on the usable range of the companion device.



Bluetooth connections



Communication between a pair of *Bluetooth* devices requires one device to be set as the "Master" and the other as the "Slave". To initiate connections from the SRX/NET side, set the SRX/NET as the "Master" device. To initiate connections from the paired device side, set the SRX/NET as the "Slave" device. The factory setting for the SRX/NET is "Slave".

Bluetooth connections are as follows:

COM1: Total station (Slave) - RC-Controller (Master)

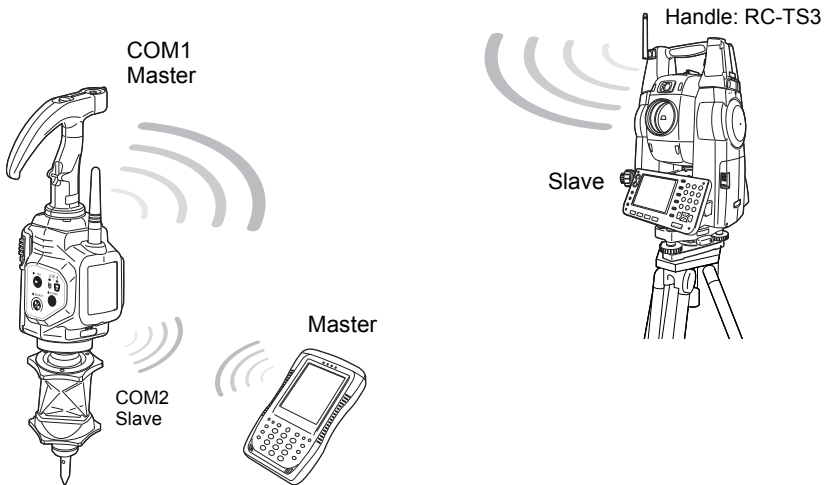
COM2: Data collector (Master) - RC-Controller (Slave)



| Port | Control panel status | |
|--|----------------------|---|
| | Lit | Flashing |
| COM1  (total station) | Comm OK | Searching for total station |
| COM2  (data collector) | Comm OK | Data collector is searching for RC-Controller |

7.5 Calibrating the Electronic Compass

The onboard electronic compass was calibrated before being shipped from the factory. A function within the compass will automatically perform any necessary calibration in response to changes in the magnetic field. Although this function by itself is sufficient in normal situations, when the RC-Controller becomes highly magnetized, manual calibration is necessary.





- When the power is ON, automatic calibration is performed to adjust for changes in temperature and magnetic field. When transporting the RC-Controller, with the power still ON, using modes of transport such as cars or trains which contain a large amount of magnetic substance (iron, magnets etc.), this function will calibrate for the magnetic field of said car or train. As a result, the direction in which the RC-Controller instructs a rotation in subsequent surveying tasks may not be correct. Always turn the power OFF when transporting.
- Manually calibrate the compass in the event that the RC-Controller has been transported with the power still ON and the resulting calibration inaccuracy persists.
- The ideal location for performing manual calibration would be an open area clear of any objects. Failing that, make sure that the surrounding area (i.e. several meters around the instrument including ground level) is clear of metallic objects (desks, steel frames, etc.) or devices containing magnets.
- Hold the RC-Controller on the pole at a height of at least 1m.
- Avoid physical contact with metallic objects (cellular phones, tape measures, etc.) or magnetic objects (such as magnetic necklaces) while performing manual calibration.

► PROCEDURE Checking whether manual calibration is necessary

1. Press the POWER button  to switch ON the RC-Controller. ● POWER is Lit.
If ● FAR and ● SEARCH flash and a rapid error tone sounds repeatedly, relocate to a position several meters away from metallic objects (desks, steel frames, etc.) or devices containing magnets before trying again.
If the audio tone continues to sound even after changing location, manual calibration is necessary.
2. When calibration is necessary, switch OFF and proceed to "PROCEDURE Manually calibrating the compass".



►PROCEDURE Manually calibrating the compass

1. Press the POWER button  while pressing the FAR button  with the power switched OFF. An audio tone sounds and the RC-Controller is switched ON in calibration mode.
● **FAR** and ● **SEARCH** are Lit.
2. Hold the RC-Controller vertical and press the SEARCH button .
● **FAR** flashes red and calibration starts.
3. Without moving the position of the RC-Controller, rotate it 1.5 to 2 times in a horizontal direction.

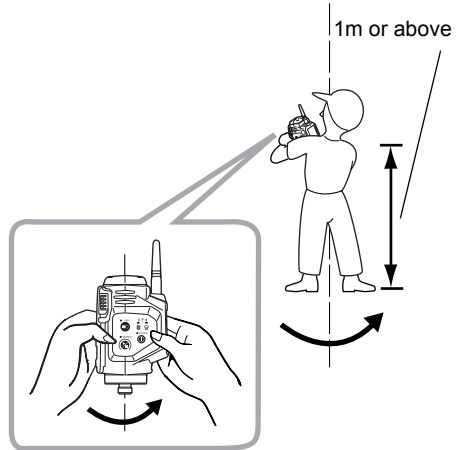

Rotate 1.5 to 2 times in approximately 10 seconds.





4. After rotating, continue to hold the RC-Controller vertical and press the SEARCH button .
● **SEARCH** turns Off.
5. Hold the RC-Controller horizontal and press the SEARCH button .
● **FAR** Flashes.

7. BASIC OPERATION

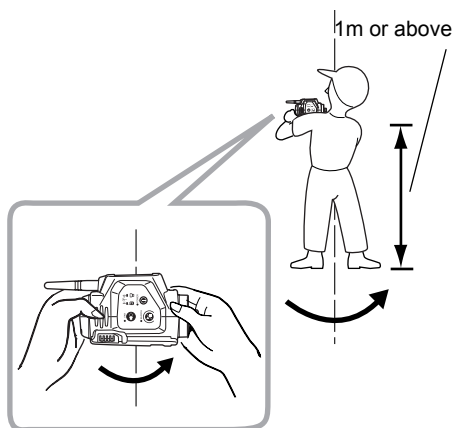



6. Without moving the position of the RC-Controller, rotate it 1.5 to 2 times in a horizontal direction.





7. After rotating, continue to hold the RC-Controller horizontal and press the SEARCH button .
8. ● **FAR** turns Off.
9. Push and hold the POWER button  on the RC-Controller to switch OFF. ● **POWER** turns Off and calibration is complete.



8. ERROR INDICATIONS

When an error occurs, the nature of the error is indicated by the condition of the LEDs on the RC-Controller.



| LED Condition | Error |
|--|---|
| ● POWER Flashing | Remaining battery power is low. Replace the batteries.  "7.1 Using the Battery" |
| 3 long audio tones and the ● POWER Flashes then power is cut off | No battery power remaining. Replace the batteries.  "7.1 Using the Battery" |
| Audio tone continues to sound and the ● POWER Flashes quickly/audio tone sounds continuously for approx. 10 seconds | The remaining battery power of the total station is low or the total station has switched OFF. Check the power to the total station.  Operator's manual for your total station |
| ● FAR /all LEDs Flashing quickly | Hardware error. Switch the power to the RC-Controller OFF and ON again. If the error reoccurs after restart, contact your local dealer. |
| A long audio tone sounds and ● SEARCH Flashes quickly for approx. 2 seconds | Turning failure  "9. TROUBLESHOOTING" |
| 3 audio tones and the ● FAR / ● SEARCH Flash | There are magnetic/metallic objects in the vicinity. Retry at a distance greater than several meters from such objects. If the audio tone continues to sound even after changing location, manual calibration is necessary.  "7.5 Calibrating the Electronic Compass" |

9. TROUBLESHOOTING

- Pressing the POWER button  does not switch ON the power.
 - Check that the battery has been inserted.
Replace the battery.
 "7.1 Using the Battery"

- The total station does not perform Turning operation even when distance measurement is executed.
 - The Turning operation setting of the total station is deactivated.
Set the "Srch method" setting for the SRX/NET to "R.C.".
 "6.2 Settings for Auto Pointing and Auto Tracking"
 - A connection has not been established with the total station.
Check the pairing settings and communication conditions for the total station and RC-Controllers being used.
 "6.1 Settings for Bluetooth Communication", "7.2 Configuring Bluetooth Connections to the SRX/NET"

- Turning operation failure
 - The beam detector cover is closed.
Close the beam detector cover.
 - Both the laser projection port and the prism are not pointing in the direction of the total station.
Point the laser projection port and the prism towards the total station.
 - The total station cannot receive the beam emitted from the RC-Controller as the amount of light is too low.
Check that the Distance Mode setting is correct.
 "7.3.2 Setting Distance Mode"
 - Turning operation has located the horizontal position but cannot find the vertical position.
Turning operation for the vertical position cannot be performed while the pole is tilted at an angle.
Check that the pole is fixed in the correct position, vertically over the measurement point.
 - Check that there are no obstacles between the beam detector of the total station and the laser projection port of the RC-Controller/prism.
 - Flat white surfaces in close proximity to the optical path between the total station beam detector and RC-Controller laser projection port may reflect the emitted laser beam and cause Turning operation failure. Have someone stand in front of such objects or otherwise cover, such as with a dark-colored cloth.
 - There is dust or dirt on the beam detector/laser projection port.
Dust off minute particles with the lens brush before carefully wiping with the cleaning cloth.

- Total station finishes Turning operation pointing in the wrong direction.
 - The total station receives the emitted laser beam after it has been reflected off a highly-reflective surface in the vicinity of the RC-Controller.
Continue Turning operation.
 "4.2 Measurement Flow"
 "6.3 Performing Turning from the SRX/NET"

- The signal for the data collector/RC-Controller equipped with *Bluetooth* wireless technology is weak.
- The wireless modem signal is poor because the data collector/RC-Controller is placed in a low position, close to ground level.
Place the modem in as high a position as possible.

10. STANDARD EQUIPMENT AND OPTIONAL ACCESSORIES



- Place the instrument in its case in accordance with the layout plan on the inside of the carrying case.
- Place the data collector in its dedicated protective case before inserting into the carrying case.

10.1 Standard Equipment

Please verify that all equipment is included.

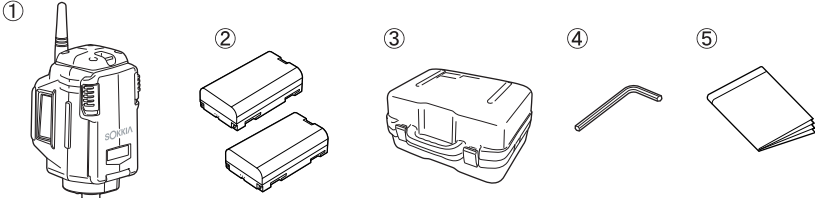

- | | | |
|---|---------------------------------|---|
| 1 | RC-PR4 main unit | 1 |
| 2 | Battery (BDC46C) | 2 |
| 3 | Carrying case (SC228) | 1 |
| 4 | On-demand Remote Control System | 1 |
| 5 | Manual | 1 |

10.2 Optional Accessories

For use with other prism types, contact your local dealer.

360° Prism (ATP1)

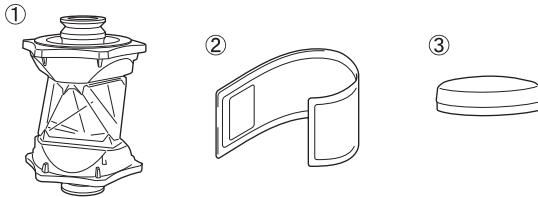

- | | | |
|---|-------------------|---|
| 1 | 360° Prism (ATP1) | 1 |
| 2 | Protective cover | 1 |
| 3 | Cap | 1 |

● Protective cover

Attach the protective cover when the prism is not being used to protect the prism surface from dirt and damage.

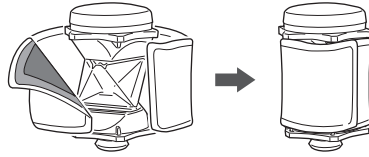

Note

- The inner (light grey) section can be used as a cleaning cloth to wipe the surface of the prism.

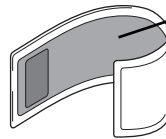

Inner: light grey (cleaning cloth section)

360° Sliding Prism (ATP1S)

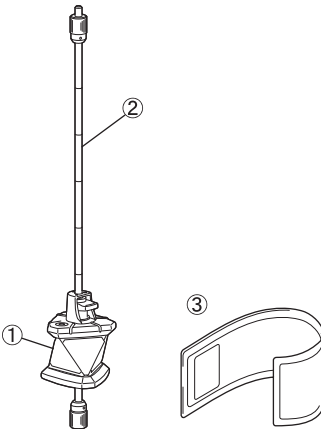

| | | |
|---|----------------------------|---|
| 1 | 360° Sliding Prism (ATP1S) | 1 |
| 2 | Pin Pole for ATP1S (PP2) | 1 |
| 3 | Protective cover | 1 |

The 360° Sliding Prism can be packed away in the carrying case (SC228). Packing is secured inside the carrying case to protect the contents. Remove this packing and place the prism at the bottom of the case.



- Be careful when removing the packing. Otherwise, the fastening may break.

RC-Handle (RC-PRH4)

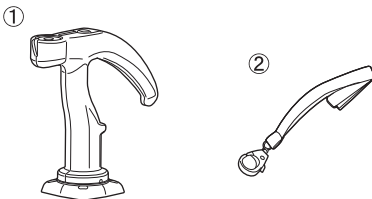

| | | |
|---|---------------------|---|
| 1 | RC-Handle (RC-PRH4) | 1 |
| 2 | Strap | 1 |

Protector (RP3)

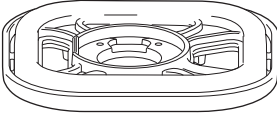

10.3 Power Supply System

Operate your RC-PR4 with the following combinations of power equipment.



- Never use any combination other than those indicated below. If you do, the instrument could be damaged.

Those indicated by * are standard accessories. Others are optional accessories (sold separately)

● Battery

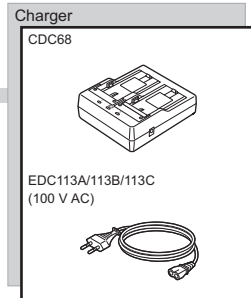
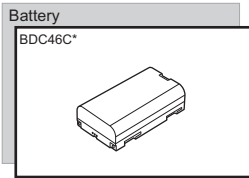

The power cable shown here is EDC113A

11. SPECIFICATIONS

Whole System Specifications

| | |
|---|---|
| Range: | (Slope distance between instrument and measuring point) (normal atmospheric conditions* ¹) |
| Standard Mode: | 2* ² to 100m* ³ |
| Far Mode: | 2* ² to 250m* ⁴ /300m* ³ |
| Operating time* ⁵ : | About 15 sec.* ¹ /18 sec.* ⁶ Up to finishing distance measurement (Rapid (single)) |
| Operating range of function for automatically determining rotation direction: | Magnetic inclination is 80° or less and horizontal component is more than 10μT* ⁷ |
| Data collector: | SOKKIA total station/3-D station-compatible product* ⁷ |
| Control panel (keyboard) | 3 Keys |
| Indicator | 5 LED |
| Audio tone | Yes |
| Operating temperature | -20 to 50°C |
| Storage temperature range | -30 to 70°C |
| Water resistance | IP55 (IEC 60529:2001) |
| Size | 69 (L) X 80.5 (W) X 131 (H) mm (excluding antenna) |
| Weight | About 420 g (with BDC46C) |

- *1: Normal: Slight haze, visibility about 20 km, sunny periods, weak scintillation.
- *2: Possible to use 1.8m (horizontal distance), height of instrument point and measurement point is almost the same, instrument height is 1.5m, and prism height is 0.10m.
- *3: About 20m height difference between instrument and RC-Controller laser projection port.
- *4: About 40m height difference between instrument and RC-Controller laser projection port.
- *5: Time taken between the start of the search and the obtaining of distance measurement results after the completion of Auto Pointing. Normal atmospheric conditions, instrument Turning horizontally 90°, 100m distance between instrument and measuring point.
Depends on the conditions and wireless modem used.
- *6: At a distance of less than 5m, pole leaning slightly.
- *7: For details, contact your local dealer.

RC-Controller (RC-PR4)

Laser Projection Port

| | |
|-----------------------|---|
| Signal source | Laser diode (IEC60825-1 Ed. 2.0: 2007/FDA CDRH 21 CFR Part 1040.10 and 1040.11 (Complies with FDA performance standards for laser products except for deviations pursuant to Laser Notice No.50, dated July 26, 2001.)) |
| Wavelength: | 785nm |
| Beam projection area | |
| Horizontal direction: | -10 to 10° |
| Angle of elevation: | More than 40° |
| Angle of depression: | More than 30° |

Rotation direction detector

| | |
|------------------------|--|
| Direction detector | magnetic compass sensor (geomagnetic measurement method) With automatic/manual calibration function |
| Measurement resolution | ±1° |

11. SPECIFICATIONS

Wireless communication

| | |
|----------------------|--|
| Transmission method: | FHSS |
| Modulation: | GFSK, $\pi/4$ DQPSK, 8DPSK |
| Frequency band: | 2.402 to 2.480GHz |
| Bluetooth profile | SPP, DUN |
| Power class | Class 1 |
| Usable range | 200m (No obstacles, few vehicles or sources of radio emissions/ interference in the near vicinity of the instrument, no rain) 300m (No obstacles, few vehicles or sources of radio emissions/ interference in the vicinity of the instrument, no rain) Usable range of the data collector varies depending on the usable range of the companion device. |
| Authentication | Yes/No (selectable) |
| Antenna | External antenna |

Power Supply (BDC46C)

Battery

| | |
|---------------------------------------|------------------------------------|
| Type: | Rechargeable Li-ion battery BDC46C |
| Working duration* ⁸ (25°C) | |
| Standard Mode: | 40 hours |
| Far Mode: | 35 hours |
| Charging time at 25 °C: | about 2.5 hours (using CDC68) |

*⁸: Repeat Turning with the instrument turned 90° and distance measurement performed in Rapid measurement (single) every 1 minute.

RC-Handle (RC-PRH4)

| | |
|---|-----------------------------------|
| Sensitivity of levels | 35'/2mm |
| Size (when attached to RC-PR4) | 80.5 (W) X 126.5 (D) X 242 (H) mm |
| Weight (when attached to RC-PR4, with BDC46C) | About 510g |

360° Prism (ATP1)

| | |
|--|---|
| Measuring range | (Using SRX/NET, angles of elevation and inclination both less than 15°) |
| EDM | 1.3 to 1000m* ⁹ |
| Auto Tracking | 2 to 500m* ⁹ |
| Auto Pointing | 2 to 600m* ⁹ |
| Prism constant | 7mm |
| 3D positioning accuracy (standard deviation) | 3mm (Angles of elevation and inclination both less than 20°) |
| Prism height | 37mm (from mounting face (flange face) when attached to RC-PR4) |
| Operating temperature | -20 to 50°C |
| Storage temperature range | -30 to 70°C |
| Size | 70 (W) X 104 (H) mm (with cap) |
| Weight | 265g (with cap) |

***9:** No haze, visibility over 20 km, slightly overcast (less than 30000 lx), no scintillation.

360° Sliding Prism (ATP1S)

| | |
|--|--|
| Measuring range | (Using SRX/NET, angles of elevation and inclination both less than 15°) |
| EDM | 1.3 to 1000m ^{*1} |
| Auto Tracking | 2 to 400m ^{*1} 2 to 500m ^{*10} |
| Auto Pointing | 2 to 500m ^{*1} 2 to 600m ^{*10} |
| Prism constant | 7mm |
| 3D positioning accuracy (standard deviation) | 3mm (Angles of elevation and inclination both less than 20°) |
| Prism height | 50mm (When attached to Pin Pole for ATP1S PP2, from bottom of pin pole) 100mm (When attached to Pin Pole for ATP1S PP2 and prism foot AP66, from tip of prism foot) |
| Prism slide range | 50mm to 350mm (When attached to Pin Pole for ATP1S PP2, graduations at 50mm intervals) |
| Operating temperature | -20 to 50°C |
| Storage temperature range | -25 to 70°C |
| Size | |
| 360° Sliding Prism ATP1S | 65 (W) X 77.5 (H) mm |
| Pin Pole for ATP1S PP2 | Ø6mm X 432mm (including connecting screw section and pole ends) |
| Weight | |
| 360° Sliding Prism ATP1S | 160g |
| Pin Pole for ATP1S PP2 | 110g |
| ATP1S, PP2 and AP66 | 290g |

***10:** Good: No haze, visibility about 40 km, overcast, no scintillation.

12. EXPLANATION

12.1 High Accuracy with the 360° Prism

Sighting can be more accurately performed by facing the 360° Prism toward the total station.

When using the ATP1, the 360° Prism should be set up so that a pair of diametrically-opposed hexagonal points on its rubber flanges are aligned with the sighting direction of the total station (see the diagram below).

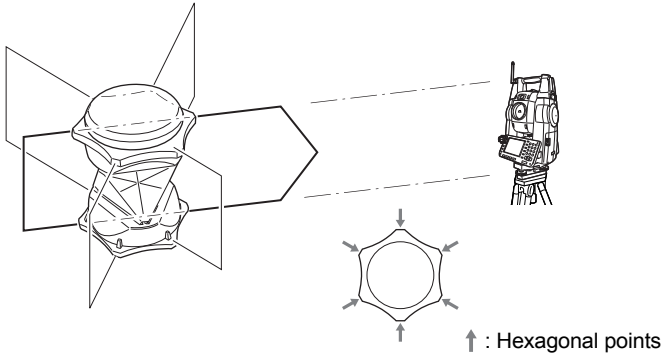

When using the ATP1S, the 360° Prism should be set up so that a pair of diametrically-opposed marks on top of the prism are aligned with the sighting direction of the total station.

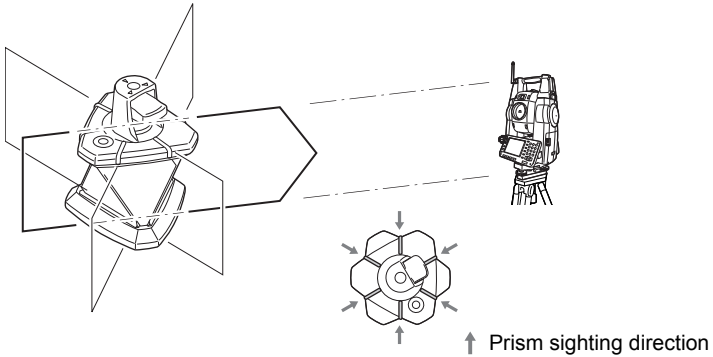

13. REGULATIONS

Users must ensure that their instrument is compliant with the relevant regulations and legal restrictions in place in the country of use.

For users in the US

WARNING: Changes or modifications to this unit not expressly approved by the party responsible for compliance could void the user's authority to operate the equipment.

NOTE: This equipment has been tested and found to comply with the limits for a Class A digital device pursuant to Part 15 of the FCC Rules. These limits are designed to provide reasonable protection against harmful interference when the equipment is operated in a commercial environment. This equipment generates, uses, and can radiate radio frequency energy and, if not installed and used in accordance with the instruction manual, may cause harmful interference to radio communications. Operation of this equipment in a residential area is likely to cause harmful interference in which case the user will be required to correct the interference at his own expense.

This transmitter must not be co-located or operated in conjunction with any other antenna or transmitter.

This equipment complies with FCC radiation exposure limits set forth for uncontrolled equipment and meets the FCC radio frequency (RF) Exposure Guidelines in Supplement C to OET65. This equipment should be installed and operated with at least 20cm and more between the radiator and person's body (excluding extremities: hands, wrists, feet and ankles).

For users in Canada

This Class A digital apparatus meets all requirements of Canadian Interference-Causing Equipment Regulations.

Cet appareil numérique de la Class A respecte toutes les exigences du Règlement sur le matériel brouilleur du Canada.

This class A digital apparatus complies with Canadian ICES-003.

Cet appareil numérique de la classe A est conforme à la norme NMB-003 du Canada.

Operation is subject to the following two conditions: (1) this device may not cause interference, and (2) this device must accept any interference, including interference that may cause undesired operation of this device.

This equipment complies with IC radiation exposure limits set forth for uncontrolled equipment and meets RSS-102 of the IC radio frequency (RF) Exposure rules. This equipment should be installed and operated with at least 20cm and more between the radiator and person's body (excluding extremities: hands, wrists, feet and ankles).

13. REGULATIONS

For users in the European Economic Area (EEA)

For a copy of the CE Conformity Declaration for this instrument, contact your local dealer.

RC-PR4 with WT11

Česky [Czech]

Sokkia BV potvrzuje, že výše uvedené zařízení je v souladu se základními požadavky a dalšími příslušnými ustanoveními směrnice 1999/5/ES.

Dansk [Danish]

Undertegnede, Sokkia B.V. erklærer herved, at følgende udstyr det ovennævnte udstyr overholder de væsentlige krav og øvrige relevante krav i direktiv 1999/5/EF.

Deutsch [German]

Sokkia B.V erklärt., dass die oben genannten Instrumente in Übereinstimmung mit den grundlegenden Anforderungen und den übrigen einschlägigen Bestimmungen der Richtlinie 1999/5/EG befindet.

Eesti [Estonian]

Käesolevaga kinnitab Sokkia B.V., seadme ülal mainitud varustus direktiivi 1999/5/EÜ põhinõuetele ja nimetatud direktiivist tulenevatele teistele asjakohastele sätetele.

English

Hereby, Sokkia B.V., declares that the above-mentioned equipment is in compliance with the essential requirements and other relevant provisions of Directive 1999/5/EC.

Español [Spanish]

Por medio de la presente Sokkia B.V., declara que el equipo arriba mencionado cumple con los requisitos esenciales y cualesquiera otras disposiciones aplicables o exigibles de la Directiva 1999/5/CE.

Ελληνική [Greek]

ΜΕ ΤΗΝ ΠΑΡΟΥΣΑ Sokkia B.V., ΔΗΛΩΝΕΙ ΟΤΙ ο προαναφερόμενος εξοπλισμός ΣΥΜΜΟΡΦΩΝΕΤΑΙ ΠΡΟΣ ΤΙΣ ΟΥΣΙΩΔΕΙΣ ΑΠΑΙΤΗΣΕΙΣ ΚΑΙ ΤΙΣ ΛΟΙΠΕΣ ΣΧΕΤΙΚΕΣ ΔΙΑΤΑΞΕΙΣ ΤΗΣ ΟΔΗΓΙΑΣ 1999/5/ΕΚ.

Français [French]

Par la présente Sokkia B.V., déclare que l'équipement mentionné ci-dessus est conforme aux exigences essentielles et aux autres dispositions pertinentes de la directive 1999/5/CE.

Italiano [Italian]

Con la presente Sokkia B.V., dichiara che questo II sopra menzionato equipaggiamento è conforme ai requisiti essenziali ed alle altre disposizioni pertinenti stabilite dalla direttiva 1999/5/CE.

Latviski [Latvian]

Ar šo Sokkia B.V., deklarē, ka augstāk minētā iekārta atbilst Direktīvas 1999/5/EK būtiskajām prasībām un citiem ar to saistītajiem noteikumiem.

Lietuvių [Lithuanian]

Šiuo Sokkia B.V., deklaruoja, kad šis aukščiau mineta įranga atitinka esminius reikalavimus ir kitas 1999/5/EB Direktyvos nuostatas.

Magyar [Hungarian]

Alulírott, Sokkia B.V. nyilatkozom, hogy a fent említett eszköz megfelel a vonatkozó alapvető követelményeknek és az 1999/5/EC irányelv egyéb előírásainak.

Malti [Maltese]

Hawn hekk, Sokkia B.V., tidjikkara li t-tagħmir imsemmi hawn fuq hu konformi mal-htigijiet essenzjali u provvedimenti rilevanti oħrajn ta' Direttiva 1999/5/KE.

Nederlands [Dutch]

Hierbij verklaart Sokkia B.V., dat bovengenoemd toestel in overeenstemming is met de essentiële eisen en de andere relevante bepalingen van richtlijn 1999/5/EG.

Polski [Polish]

Niniejszym Sokkia B.V. oświadcza, że sprzęt wymieniony powyżej jest zgodny z zasadniczymi wymogami oraz pozostałymi stosownymi postanowieniami Dyrektywy 1999/5/EC.

Português [Portuguese]

Sokkia B.V. declara que este o equipamento acima mencionado está conforme com os requisitos essenciais e outras disposições da Directiva 1999/5/CE.

Slovensko [Slovenian]

Sokkia B.V. izjavlja, da je ta zgoraj omenjena oprema v skladu z bistvenimi zahtevami in ostalimi relevantnimi določili direktive 1999/5/ES.

Slovensky [Slovak]

Sokkia BV potvrdzuje, že vyššie uvedené zariadenie je v súlade so základnými požiadavkami a všetky príslušné ustanovenia Smernice 1999/5/ES.

Suomi [Finnish]

Sokkia B.V. vakuuttaa täten että ylläoleva laite tyyppinen laite on direktiivin 1999/5/EY oleellisten vaatimusten ja sitä koskevien direktiivin muiden ehtojen mukainen.

Svenska [Swedish]

Härmed intygar Sokkia B.V. att den ovan nämnda utrustningen står i överensstämmelse med de väsentliga egenskapskrav och övriga relevanta bestämmelser som framgår av direktiv 1999/5/EG.

Íslenska [Icelandic]

Hér með staðfestir Sokkia B.V. að áður nefndur búnaður er í samræmi við grundvallarskilyrði og aðrar viðeigandi kröfur í fyrirmæli Evrópusambandsins 1999/5/EC.

Norsk [Norwegian]

Sokkia B.V. erklærer herved at utstyret nevnt ovenfor oppfyller de ubetingede krav og andre relevante bestemmelser i Direktiv 1999/5/EC.

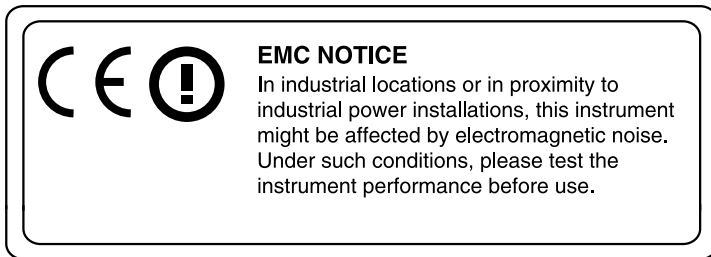
**For users in Mexico**

Este equipo opera a título secundario, consecuentemente, debe aceptar interferencias perjudiciales incluyendo equipos de la misma clase y puede no causar interferencias a sistemas operando a título primario.

COFETEL + RCPSOWT08-0101

13. REGULATIONS

For users in Indonesia

**06223/POSTEL/2008
2311**

For users in Taiwan

低功率電波輻射性電機管理辦法 (930322)

第十二條 經型式認證合格之低功率射頻電機，非經許可，公司、商號或使用者均不得擅自變更頻率、加大功率或變更原設計之特性及功能。

第十四條 低功率射頻電機之使用不得影響飛航安全及干擾合法通信；經發現有干擾現象時，應立即停用，並改善至無干擾時方得繼續使用。







前項合法通信，指依電信法規定作業之無線電通信。

低功率射頻電機須忍受合法通信或工業、科學及醫療用電波輻射性電機設備之干擾。

For users in the United Arab Emirates

Approved by TRA

Button Operations

| Operation | Button Operation | Indication |
|----------------------|---|---------------------------------------|
| POWER ON | Press  once | ● POWER is Lit |
| POWER OFF | Press and hold  | ● POWER Flashes then turns Off |
| Far Mode | When ● FAR is Off, press  once | ● FAR is Lit |
| Standard Mode | When ● FAR is Lit, press  | ● FAR is Off |
| Start Turning | Press  once | |
| Turning in operation | | ● SEARCH Flashes |
| Turning complete | | ● SEARCH is Lit for 2 seconds |
| Cancel Turning | Press  once while Turning in operation | ● SEARCH is Off |
| Continue Turning | Press and hold  | ● SEARCH Flashes |

SOKKIA TOPCON CO., LTD.

<http://www.sokkia.co.jp/english/>

1588 MATSUDASORYO, MATSUDA-MACHI, ASHIGARAKAMI GUN,
KANAGAWA, 258-8508 JAPAN