

SHC5000

Ruggedized Field Computer



SOKKIA

OWNER'S MANUAL

Copyright © July 2018 Sokkia, Inc All rights reserved.
Information is subject to change without notice.

Sokkia® is a registered trademarks of Sokkia, Inc. SHC5000™
Ruggedized Field Computer is a recognized trademark of
Sokkia, Inc.

Windows, Windows 10 and the Windows logo are
trademarks or registered trademarks of Microsoft
Corporation in the United States and/or other countries.

The *Bluetooth*® word mark is owned by the Bluetooth SIG,
Inc. Any use of such marks by Sokkia, Inc. is under license.

Adobe® Acrobat® and Adobe® Reader® are registered
trademarks of Adobe Systems Incorporated in the United
States and/or other countries.

The names of other companies and products mentioned
herein may be the trademarks of their respective owners.

This product is manufactured by Juniper Systems, 1132 West
1700 North, Logan, Utah, 84321. Phone (435) 753-1881.



WARNING! This symbol indicates that failure to follow
directions could result in serious injury.



CAUTION: This symbol indicates that failure to follow
directions could result in damage to equipment or loss of
information.

Part Number 26085-05 JS, 1013583-05 Sokkia

SOKKIA

tel: 1-800-4-Sokkia | web: <http://us.sokkia.com/>
16900 W. 118th Terrace, Olathe, KS 66061

Contents

1	Getting Started	1
	Perform Initial Tasks.....	3
	Operating System Languages and Document Updates.....	8
2	Standard Features	9
	Windows 10 Pro Operating System.....	10
	Display and Touchscreen.....	10
	Keypad Features.....	12
	Power Management.....	13
	LED Activity Indicators.....	16
	Light Sensor.....	16
	Connector Ports.....	18
	Audio Features.....	19
	Sleep, Reset, Hibernate, Power-Off, and Recovery..	19
	Sensors.....	22
	Bluetooth [®] Wireless Communication.....	22
	Wi-Fi Wireless Networking.....	23
	GPS/GNSS.....	23
	Camera.....	24
3	Optional Features and Accessories	25
	4G LTE Data Modem.....	26
	Office Docking Station.....	28
	Battery Charger.....	31
A	Storage, Maintenance, and Recycling	33
	Storing the SHC5000 and Battery Pack.....	34
	Protecting the Touchscreen	35
	Recycling the SHC5000 and Batteries.....	36
B	Warranty and Repair Information	37
	Limited Product Warranty	38
	Complete Care Service Plans.....	41

C	Warnings, Regulatory Information, Licensing	43
	Product Warnings.....	44
	Certifications and Standards.....	46
	Licensing Information.....	49
D	Specifications	51
	Index	59

1

Getting Started



Getting Started

The standard features for the SHC5000 Ruggedized Field Computer from Sokkia include a 7" display, capacitive touchscreen, keypad, front and rear cameras, GPS/GNSS, *Bluetooth*, and Wi-Fi. Standard accessories include a removable battery pack, an internal battery pack, AC wall charger, hand strap, connector port cover, a fine tip capacitive stylus and tether, and a foam tip stylus for wet conditions.

The Anatomy of the SHC5000 Front and Back Features

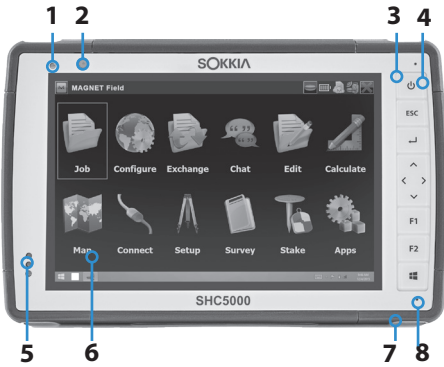

- 1 Ambient Light Sensor
- 2 Front Facing Camera Lens, 2 MP
- 3 Keypad
- 4 Power Key
- 5 Notification LEDs
- 6 Touchscreen and Display
- 7 Protective Over-molded Bumper (all four edges)
- 8 Microphone (one on each side)

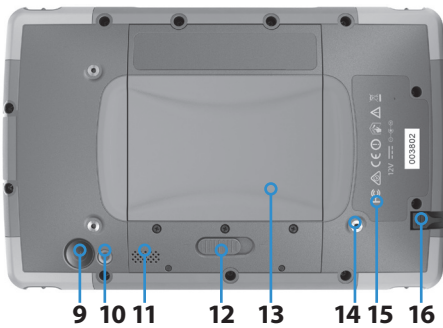

- 9 Rear Facing Camera Lens, 8 MP
- 10 Camera Flash
- 11 Speaker
- 12 Battery Door Lock
- 13 Door to Removable Battery Compartment and Card Slots
- 14 External Device Attachment Point (1 of 3 on the back)
- 15 Location of Internal Battery (not user accessible)
- 16 Storage Slot for Fine Tip Stylus

Battery Compartment and Card Slots

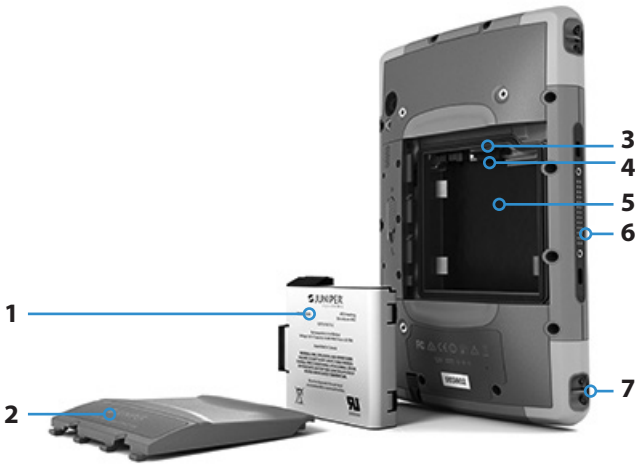

- 1 Battery Pack, Removable
- 2 Battery Door
- 3 Micro SIM Card Slot and Micro SD/SDHC Card Slot (underneath card retainer)
- 4 Flexible Card Retainer
- 5 Battery Compartment
- 6 Docking Connection
- 7 Hand Strap Attachment Point (2 on each side)

Connector Ports

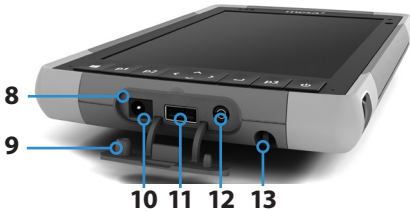

- 8 Connector Ports
- 9 Connector Port Protector
- 10 12 VDC Power Input Jack
- 11 USB 3.0 Host, Full Size
- 12 Microphone/Speaker Jack
- 13 Storage Slot for Fine Tip Stylus

Note: Your SHC5000 might look different than these images.

Perform Initial Tasks

When you receive your SHC5000, perform the tasks outlined in this section before first use.

Review Documentation

The owner's manual, quick start guide, and Microsoft® License Agreement are available in multiple languages. Other documents like release notes are available in English. These documents are located on our website at:

<http://us.sokkia.com/products/software-field-controllers/field-controller-hardware/shc5000>. Manuals might also be located on the SHC5000 (model dependent). View, download, and print documents as desired. (You need a PDF reader on the device you are viewing documents with. Options include the Windows 10 Edge browser and Adobe Reader, which is available from Adobe's website at: www.adobe.com.)

Documentation will be updated during the life of the SHC5000. Compare version numbers to see if a document has changed.

Install the Battery Pack, Micro SD Card, and Micro SIM Card

The SHC5000 comes with a rechargeable and removable Li-Ion battery pack. Install and charge the battery pack as follows:

1. The battery compartment is accessed from the back of the SHC5000. Push the battery lock switch in, slide it to the unlocked position, and remove the door.



CAUTION: The SHC5000 is not sealed against water and dust when the battery door is not installed.

2. If you are using a micro SD card for additional memory or a micro SIM card with the Cellular Data Modem (optional), you can install them now before you install the battery pack or at another time. If you do this, make sure you replace the flexible card retainer before installation of the battery. See *Chapter 2, Standard Features, SD Cards* for more details.
3. Follow the graphic on the battery label to insert the battery pack properly.

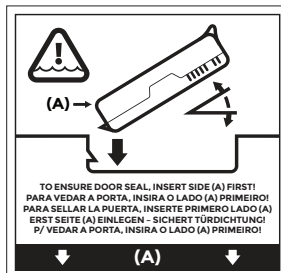

Hold the battery so that the black tab on the front edge of the battery is up and facing the door latch (this tab helps you pull the battery out). Place the back edge in first, gently pushing it underneath the two battery catches. Rotate the front edge down until it is in position.



CAUTION: Do not set the battery pack straight down. Damage to the unit could occur.

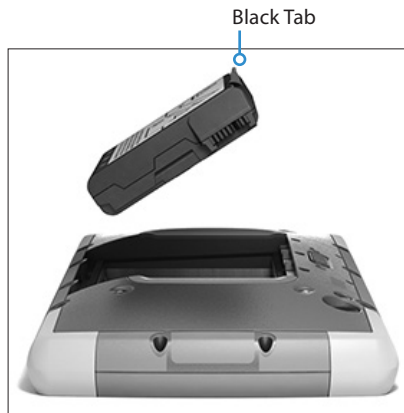

4. Replace the door and press down on it until the latch pops into the locked position.
5. Attach the appropriate plug for your country into the AC wall charger and plug it into a wall socket. Plug the other end into the DC power jack on the SHC5000.

Note: Use the AC wall charger that came with the SHC5000 or an approved charger. See Appendix C, Wall Charger Warnings, for details.

6. Charge the battery pack at room temperature (68° F or 20° C) for 6 hours (for the first charge). While the battery pack is charging, the red LED blinks. When it is fully charged and external power is applied, the red LED is solid.

Note: The SHC5000 will not recognize the internal battery until the SHC5000 is being charged for the first time.

Perform Set Up

1. Press the power key . The SHC5000 powers on and begins the startup process. The first time the SHC5000 is turned on, a *Getting ready* screen comes up with a progress indicator. This process can take a few minutes.
2. Windows setup menus are presented for first time set up.
 - Pick one of the languages listed and a time zone (if the language you want is not listed, you can change it later in Settings after you go through the set up screens and create a user).
 - Read and accept the license agreement.
 - To finish the setup process according to these instructions, you need internet access. (Alternatively, you may complete the setup without internet access by following the prompts and setting up a local user account instead of a Microsoft account.) Pick the network you want to use. For Cellular, you need to insert a SIM card (see Chapter 3, Optional Features, 4G LTE Data Modem for details). For Wi-Fi, you may need a security key.
 - Select *Express settings*.
 - Select the owner of the PC, *My organization* or *I own it*.
 - If you selected *My organization*, choose how you will connect to their infrastructure. In most situations, you want to select Domain. We suggest you check with your IT department. If you select yourself, go to the next step.
 - Connect to an existing Microsoft user account or establish one. You can also chose to do this later if you prefer.
3. You might be asked to restart the SHC5000 to complete installation.
4. The Microsoft Start screen appears in Tablet mode, which shows the Windows Start Menu with prominent app tiles. Select the symbol in the upper left screen to see the full Start Menu. If you prefer the traditional desktop view, open the Action Center and select Tablet mode which toggles it off.

Attach the Hand Strap and Stylus Tether

A hand strap, fine tip capacitive stylus, and tether are included with the SHC5000.

Hand Strap

To attach the hand strap to the SHC5000, follow the images below. You can attach it to the right or left side of the SHC5000:



1



2



3

Stylus Tether

Attach one end of the stylus tether to the stylus. To attach the tether to the SHC5000, follow these steps:

1. Push the free tether loop through one of the tether attachment points located on the side of each corner.



2. Insert the stylus with the attached tether through this loop and tighten the loop.
3. Place the stylus into the stylus storage slot located on the bottom of the SHC5000.

Operating System Languages and Document Updates

Install the Operating System in Other Languages

During the Windows set up process, you selected English or one of the languages that the operating system has been translated into, including the unique SHC5000 operating system features. Other languages are also available, however the unique SHC5000 operating system features are shown in English and not the language selected.

From the Start screen, go to *Settings > Time & Language > Region & Language*. Select your country or region from the pull down list. Select the + symbol to see a list of possible languages you can select from. You can also go to related settings and make additional location related adjustments.

Updates to Technical Documents

Periodically check for updates to documentation associated with the SHC5000 on our website at us.sokkia.com/products/software-field-controllers/field-controller-hardware/shc5000. Compare part numbers or dates to see if you have the most recent version of these documents.

2

Standard Features



Standard Features

This chapter discusses the standard features included with the SHC5000 Ruggedized Field Computer.

Windows 10 Pro Operating System

The SHC5000 has the Windows 10 Pro operating system. If you are not familiar with this operating system, we recommend that you go to the *Start menu > Get Started* (you need internet access to do this). Watch the videos and read the text to familiarize yourself with Windows 10. You can also go to Microsoft's website from another computer to learn about Windows 10.

Windows Start Menu

Press the Windows logo key or screen icon  to open the Start menu. All applications are listed here and you can select *Settings* and *File Explorer*. Tiles provide easy access to apps and can be customized.

Action Center

The Action Center provides quick controls, notifications, and messages. To view the Action Center, select the Action Center icon on the bottom tray (located on the far right end) or, from the right edge of the screen, swipe left towards the center of the screen. The Action Center is shown on the right hand side. Tiles are shown at the bottom. Some are toggles like *Tablet mode*, which toggles between *Tablet mode* and the traditional *desktop mode*. Some tiles take you to other screens where you can take action, like *Notes*, or view other menus like *All settings*.

View System Information for Your SHC5000

You can view information about your SHC5000 in the Device Info app. Go to the *Start menu* and select *Device Info*. For additional information, go to the Action Center. Select *All Settings > System > About*.

Display and Touchscreen

The SHC5000 has a bright color display and capacitive touchscreen with a diagonal viewing area of 7 inches (178 mm). It is easy to view outdoors and is sealed against

water and dust. The Windows® 10 operating system enhances the ability of the SHC5000 to recognize touch gestures, making it easy to use a finger to make selections and navigate. You can also use the fine tip capacitive stylus included with the SHC5000 or optimize it for wet conditions (see *Touchscreen Settings* in the next section).

Display and Touchscreen Profile Settings

Display Settings

To adjust the display settings including the text size, brightness, and orientation, go to the Action Center and select *All settings > System > Display*.

Backlight Brightness

There are a few shortcuts to adjust the display backlight brightness.

Open the Action Center. Tap the percent tile (sun icon) to toggle the display backlight brightness up or down in 25% increments from 0% to 100%. This same tile can be accessed by tapping the battery icon on the desktop. To simply dim the backlight, tap the *Battery saver* tile. Tap it again to return it to the previous brightness.

Display Magnifier

To turn the magnifier on, go to the Action Center and select *All settings > Ease of Use > Magnifier*. Turn the magnifier on and adjust other settings as desired. Once the magnifier is turned on, you can use the + and – symbols on the display to zoom in and out.

If you use this feature frequently, you can set up a programmable key to zoom in and out on the display. See *Keyboard Features, Programmable Keys* later in this chapter for more information.

Touchscreen Profile Settings

To adjust the touchscreen profile, go to the Start menu and select *Touchscreen Profiles* (located at the bottom of the Start menu screen in a tile). Select the profile you want the screen optimized for: finger and stylus (default), finger, stylus, glove, or wet conditions. As the new profile loads, a progress bar is shown. Do not interrupt the loading process.

You can try different profiles to see which one works best for you.

Note: When using the capacitive touchscreen on the SHC5000 in wet conditions, you must use your finger or the soft-tipped stylus that is included, even after selecting the wet conditions touchscreen profile. The hard-tipped stylus will not work. Other third party styli might work with the SHC5000 touch profiles, but we cannot guarantee it.







Calibration Tool - Do Not Use

The calibration tool in Windows 10 is for a resistive touchscreen. The SHC5000 has a capacitive touchscreen. If the Windows 10 screen calibration tool is used, it may degrade touchscreen performance.

Keypad Features

The SHC5000 has programmable keys, a power/suspend key, windows key, enter key, and a navigation pad.

The keys are sealed and have backlight illumination.

Key	Function
	Windows Start screen
F2	Volume down (programmable)
F1	Volume up (programmable)
	Move left
	Move right
	Move up
	Move down
	Enter (return)
ESC	Escape key (programmable)

Key	Function
	Power <ul style="list-style-type: none"> ■ Press and release: On or sleep ■ Hold for 5 seconds and pull down screen: Power off ■ Hold for 10 seconds: Reset device. CAUTION: before doing this, see the <i>Sleep, Reset, Hibernate, Power-Off, and Recovery</i> section in this chapter. ■ Hold for 20 seconds: Electrically disconnect the battery pack(s); to reconnect the batteries, you are required to plug in the charger or external 12 V power. CAUTION: before doing this, see the <i>Sleep, Reset, Hibernate, Power-Off, and Recovery</i> section later in this chapter.



Programmable Keys

The **F1, F2, and ESC** keys can be configured to launch applications or functions.

To adjust the programmable keys, open the Start menu and select *Keypad* (located at the bottom of the *Start menu* screen in a tile). The *Keypad Buttons and Backlight* panel appears. The programmable keys and their current assignments are shown. Select your preferred function for each key from the drop down menus.

Keypad Backlight Brightness

To adjust the keypad backlight brightness, go to the Start menu and select *Keypad*. At the bottom of the *Keypad Buttons and Backlight* panel is a slider that adjusts the keypad backlight brightness. You can make the backlight brighter by moving the slider to the right or turn it down by moving the slider to the left. Dimming the keypad backlight saves battery power when the SHC5000 is in use.

Power Management

The SHC5000 runs on battery power, using a rechargeable Li-Ion battery pack. The SHC5000 also has an internal battery. The SHC5000 operates on either or both battery packs.

Battery Status and Management

To find out how much battery life you have left, tap on the battery icon at the bottom of the desktop screen. The amount of charge left as a percent and the status of each battery is shown. The cumulative amount of battery life left for installed batteries and the approximate amount of time battery power will last is also shown. (This is an approximation. The amount of time left varies depending on what you are doing with the unit).

Preserving Battery Power

There are some settings you can adjust to preserve battery power.

- From the battery screen, the display backlight brightness can easily be toggled up or down in 25% increments from 0% to 100% by tapping the percent tile (see the sun icon).
- Tap the *Battery saver* tile to dim the backlight or return it to the previous brightness.
- To make additional adjustments, select *Power and sleep settings*. Settings like how much time passes before the SHC5000 turns off or goes to sleep and whether or not Wi-Fi stays connected while it is asleep can be adjusted.

Charging the Battery Pack(s)

For instructions on how to insert and charge the removable battery pack, refer to the instructions in *Chapter 1, Getting Started*. It typically takes 4 to 5 hours to fully charge a battery pack.

For units that have both a removable battery pack and an optional internal battery pack, the intelligent internal battery charging circuit first charges the battery pack with the least amount of energy. When this battery pack comes to the same level as the other battery pack, then both battery packs are charged at the same time until they are both fully charged.

Battery packs are charged most efficiently at room temperature (68° F or 20° C). They will not charge if it is too hot or too cold.

We recommend that you keep the SHC5000 battery pack(s) charging when it is not in use for up to two weeks. When you plug the SHC5000 into the wall charger that comes with it, the batteries are prevented from being overcharged.

! **CAUTION:** The SHC5000 is not sealed against water and dust when the battery or battery door is not installed properly.

Battery Life

Battery life on a full charge can be 20 hours or more. This varies depending on the applications used, backlight usage, and radio usage.

The shelf life of a battery is about one year. The battery packs should be recharged at least once per year. This prevents the battery packs from discharging to a level that might damage the batteries. Battery packs that are not recharged at least every year, could fail to work or may have reduced capacity.

! **CAUTION:** Only use batteries designed for the SHC5000 from an approved vendor. Use of non-approved batteries may void your product warranty. The SHC5000 must be returned to the factory for replacement of the internal battery, although the internal battery pack is designed to last the life of the SHC5000.

Power States

The SHC5000 runs on battery power, or external power.

Removing the Replaceable Battery

To remove the replaceable battery to replace it or to insert or remove SD cards, follow these steps.

1. Power off the SHC5000.
2. To remove the battery compartment door, push the battery lock switch in, slide it to the unlocked position, and remove the door.

! **CAUTION:** The SHC5000 is not sealed against water and dust when the battery door is not installed.

3. Remove the battery pack by pulling up on the black tab on the battery pack.



LED Activity Indicators

LED activity indicators are located on the front of the SHC5000.

- Red LED, solid: 1) When the SHC5000 is put to sleep or powered off by pressing the power key , the red LED is solid until the unit has successfully completed the process, and then the red LED turns off. 2) The AC adapter is plugged in and the battery is full (not charging).
- Red LED, blinking: The AC adapter is plugged in and the battery is in the process of charging.
- Green LED, solid or blinking: Programmable.
- Blue LED, solid or blinking: Programmable.
- Amber Light: Front or rear facing camera is in use.

The green and blue LEDs are in the same location. They can not be shown simultaneously. These LEDs can be programmed by a developer. Sample code is available upon request

Light Sensor

All units have an ambient light sensor located on the front of the SHC5000. The light sensor dynamically adjusts the backlight on the display.

You can disable this process and manually control the display brightness if you prefer. Go to the Start menu and select *Settings > System > Display*. Turn off *Change brightness automatically when lighting changes* and tap *Apply*. To manually adjust the display backlight, tap on the battery icon at the bottom of the desktop screen. The display backlight brightness can easily be toggled up or down in 25% increments from 0% to 100% by tapping the percent tile (see the sun icon).

SD Cards

The SHC5000 has a slot for a micro SD card located in the battery compartment. The card slot and flexible card holder are designed to hold the card securely in place so it will not come out or disconnect if the SHC5000 is dropped. To insert or remove a card, follow these steps:

1. Power off the SHC5000.
2. Remove the battery door as outlined in chapter 1.



CAUTION: The SHC5000 is not sealed against water and dust when the battery pack and battery door are not installed properly.



CAUTION: Always power off the SHC5000 before removing the battery. Failure to do so may cause loss of data or damage to the SHC5000. **EXCEPTION:** If your SHC5000 has an internal battery, this caution does not apply. You can safely remove the removable battery while the unit is running.

3. Remove the battery pack by pulling up on the black tab on the battery pack.

- An image on the battery compartment label shows the correct location and orientation for the SD card (slot on the right). Pull the flexible card holder back out of the way. Push the card into the slot to insert it.

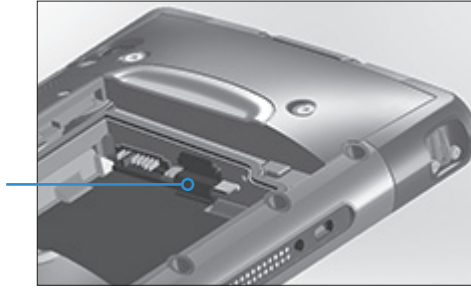

- Push the flexible card holder back into place, covering the card slots.
- Replace the battery pack, and attach the battery door. To remove the SD card, pull it out. Use tape or an eraser if you have trouble.

Connector Ports

The SHC5000 has the following jacks and connectors:



- Connector Ports
- Connector Protector
- 12 VDC Power Input Jack
- USB Host, Full Size
- Connector Protector Retainer
- Microphone/Speaker Jack
- Storage Slot for Fine Tip Stylus

The connector protector is removable and replaceable. See your sales representative if you need a new one. To remove it, pull it out of the ports, then gently pull the curved rubber retainers out of the holes they are in. Replace it by inserting the curved rubber retainers back into the holes.

Note: The connectors are sealed. A connector protector to not required to prevent water ingress. It protects the connectors from exposure to excessive dust and dirt.

Audio Features

The SHC5000 has the following audio features (see *The Anatomy of the SHC5000* images for the locations of these items):

- **Speaker** - The speaker provides audible indicators and program feedback. You can listen to mono audio files and watch video. For stereo audio, use *Bluetooth*, headphones or HDMI output from the optional dock.
- **Microphone** - Use the microphones to record audio notes or add sound to a video when using the camera. Built in microphones can also be used for Skype calls.
- **Audio Jack** - The audio jack supports a stereo headset or headset/microphone combination with 3.5 mm connections.

Sleep, Reset, Hibernate, Power-Off, and Recovery

Putting the SHC5000 to Sleep

The SHC5000 goes to sleep after a few minutes by default. When the SHC5000 is in a sleep state, it is still powered up, but in a low power state.

1. To put the SHC5000 to sleep, press and release the power key  or go to the Start menu, select the *Power* symbol, and select *Sleep*. Going into a sleep state can take several seconds, depending on which activities the SHC5000 is working on at the time. While it is going to sleep, the red LED remains lit.
2. To wake the unit from a sleep state, press and release the power key again. When it is awakened, the SHC5000 quickly resumes where it was before it was put to sleep.
3. You can change the sleep default setting by going to the Start menu and selecting *Settings > System > Power and Sleep > Sleep*.

Hibernating the SHC5000

The SHC5000 can be set up to hibernate, which powers down the SHC5000. The state of the SHC5000 is saved to a special file. When the SHC5000 is powered up, the unit boots, sees the special file, and restores everything to the state it was in before it hibernated. This is a safer choice

versus sleep if battery power is a concern. For example, your battery is fairly consumed, but you won't have access to the charger for a while. Hibernate will stretch your battery life out.

By default, when the SHC5000 power key is pressed, it goes to sleep. You can change this setting to hibernate (or other options).

Open the Start menu and select *Settings*, then go to *System > Power and sleep*. At the bottom of the screen under *Related settings*, select *Additional power settings > Choose what the power button does*. Under *Power button settings*, *When I press the power button*: select *Hibernate* from the pull down lists for the *On battery* and *Plugged in options*.

Powering Off and On the SHC5000

To preserve battery power, we recommend you power off the SHC5000 if it will not be used over a long weekend or several days.



CAUTION: Be aware that when the SHC5000 is powered off, it closes all programs and powers down all system components. If hibernate is not used, all programs are closed and unsaved data is lost.

1. Save open files, and close any running programs.
2. Go to the Start menu, select the *Power* symbol, and select *Shut Down*. If the Start menu is not available, press and hold the power key for 5 seconds and slide the screen that drops down towards the bottom of the SHC5000 screen.
3. On battery power, it typically takes about 30 seconds for the SHC5000 to completely shut down, although it can take several minutes.
4. To power on the SHC5000, press the power key.

Ctrl-Alt-Delete Function

Press and hold down the windows key, then press the power key. A list that includes the Task Manager is shown. Select Task Manager to see which apps are running. Press More details at the bottom to view Processes, Performance, and other items. This can be useful for troubleshooting.

Resetting the SHC5000

If the SHC5000 is unresponsive, slow, or programs won't launch, performing a reset might solve the issue. You might be asked to perform a reset when an application is installed.

! **CAUTION:** Be aware that during a reset, applications are closed and unsaved data is lost.

To reset your SHC5000, Go to the Start menu, select the Power symbol, and select *Restart*.

SHC5000 is Locked Up

If the SHC5000 is completely stuck and won't respond or you cannot get to the Start menu, hold the power key down for five seconds to see if that solves it. If that doesn't work, hold it down for 10 seconds. This causes a hardware shut off. Press the power key again to power on.

If 10 seconds doesn't work, hold the power button down for 20 seconds. Batteries are forced to electrically disconnect from the SHC5000, causing a complete shut down. The unit cannot be powered on again until it is plugged in with the AC adapter. Keep this in mind if you are in the field.

! **CAUTION:** Holding the power button down for 20 seconds for a forced disconnect is recommended only as a last resort. It can be very hard on the system hardware. NEVER do this to power off or reset a SHC5000.

Recovery Image

You can restore the SHC5000 back to the factory defaults using the Recovery Image.

Before initiating a recovery, make sure that the SHC5000 is plugged in. Go to the Start Menu and select *Settings > Update & Security > Recovery > Reset This PC > Get Started*. Choose *Keep my files* or *Remove everything* depending on your personal needs. A verification screen asks you to verify what you want to do with the existing files.

The recovery process can take up to 3 hours.

Sensors

Compass, Accelerometer, and Gyroscope

The SHC5000 has a built-in compass and accelerometer. The accelerometer assists the compass in determining direction, even when the device is not resting flat. The gyroscope senses change in angular motion. The compass, accelerometer, and gyroscope can also be used by other user applications.

The sensors in the SHC5000 have been factory calibrated. Periodic user calibrations helps the compass be calibrated to the environment it is being used in. A user calibration consists of moving the device through all orientations and angles.

Bluetooth® Wireless Communication

The SHC5000 has built-in *Bluetooth*® wireless technology, allowing you to connect it to other wireless devices with *Bluetooth* technology.

Creating a Partnership/Pairing a Bluetooth Device

To create a partnership between the SHC5000 and another device with *Bluetooth* technology:

1. Turn both devices on.
2. Place them within a few feet of each other. (The SHC5000 has long range *Bluetooth*, but the other device might not.)
3. Make *Bluetooth* discoverable on both devices. *Bluetooth* on the SHC5000 is off by default. To activate it, open the Action Center and press and hold the *Bluetooth* icon. Select *Go to settings*.
4. In the *Bluetooth* settings screen, you should see a list of all *Bluetooth* devices within range. Tap on the name of the device in the list you would like to pair with, then tap *Pair*. If prompted, enter the PIN or pass code of the paired device. You should now be paired with the device.

Note: If Bluetooth is on and the tablet enters sleep or hibernate mode, Bluetooth turns off to save battery power. The connection is resumed once it powers back on. (This is not the case with the extended range Bluetooth)

Wi-Fi Wireless Networking

The SHC5000 has built-in Wi-Fi wireless networking to connect to the Internet or an office network.

Connecting to a Wi-Fi Network

To use Wi-Fi, you need to be in range of a Wi-Fi access point to make a connection. When Wi-Fi is turned on (the default), the SHC5000 automatically starts scanning the area for available Wi-Fi networks.

From the Action Center, click and hold the *Wi-Fi network icon*, then select *go to settings*. A list of available networks is shown. Select the network you want to use and enter the network security key. The SHC5000 remembers the Wi-Fi network connections created.

Wi-Fi can be turned off and on and settings can be managed from this set up screen.

Note: Windows 10 does not support shared key WEP.

GPS/GNSS

SHC5000 Ruggedized Field Computers use an integrated GPS/GNSS receiver with an internal antenna to provide position information. Use Maps to see your location and ensure that GPS is working. Open the Start menu and select *Maps*.

GPS/GNSS Support

Integrated GPS/GNSS Support in Windows

The Windows operating system provides built-in support for GPS/GNSS devices. As part of that support, the Windows Sensor and Location platform provides a standard way for GPS/GNSS information to be made available to applications that have been designed using the Windows Sensor and Location application programming interfaces (APIs).

Legacy Support

In addition to the Sensor and Location APIs, legacy applications that require access to a serial port can access NMEA data through a serial COM port interface. The name of the COM port can be found by using Device Manager and looking under Ports (COM & LPT) for "u-blox Virtual COM port (COMx)" where "x" is the port number allocated on your device.

GPS/GNSS Accuracy

The GPS/GNSS antenna is under the notification LEDs and is intended to work in both portrait view and landscape view. Do not put your hand or another object over this area. Accuracy could be reduced. The more items between the antenna and the satellites, the lower the accuracy.

Camera

SHC5000 Ruggedized Field Computers have a front facing camera that is 2 MP and a rear facing camera that is 8 MP.

The camera app is accessed from the Start menu, *All apps > Camera*. There is also a camera tile in the Start menu. You can set up a programmable key to launch the camera app if you desire. See *Chapter 2, Standard Features, Keyboard Features, Programmable Keys* for more information.

Both the still image camera and video camera are available from this screen. Other options like audio and a flash are shown at the top of the camera screen.

Photo and Video Library

Photographs and videos are automatically stored in the Pictures folder.

3

Optional Features and Accessories



Optional Features and Accessories

This chapter discusses the optional features that can be included with the SHC5000 Ruggedized Field Computer.

4G LTE Data Modem

The 4G LTE data modem is an option for the SHC5000, adding Wide Area Network data modem capability.

This modem supports all major service providers in North America, Europe, and many other regions of the world. Refer to frequency bands and modes supported by the SHC5000 located in Appendix D, Specifications, and your service provider of choice for compatibility.

Set up a Data Account with a Wireless Provider

Contact a wireless provider to set up data service for the cellular data modem and obtain an account and micro SIM card. You need to provide the following information when setting up an account:

1. Billing Information and business ID, such as your Federal Tax I.D. or VAT number.
2. The wireless services required. Specify that you need data service only. You do not need voice or messaging services.
3. You may be asked for the modem's IMEI number. From the Start menu, select *Settings > Network & Internet > Cellular*. Tap on the Cellular icon, then select *Advanced Options*. The IMEI number is listed under *Properties*.

Install the SIM Card

The card slot and flexible card holder are designed to hold the card securely in place so it will not come out or disconnect if the field computer is dropped. To insert or remove a card, follow these step:

1. You must power off the SHC5000.
2. Remove the battery door as outlined in chapter 1.



CAUTION: *The SHC5000 is not sealed against water and dust when the battery pack and battery door are not installed properly.*

3. Remove the battery pack by pulling up on the black tab on the front of the battery pack.
4. An image on the battery compartment label shows the correct location and orientation for the SIM card (slot on the right). Pull the flexible card holder back out of the way. Push the card into the slot to insert it.

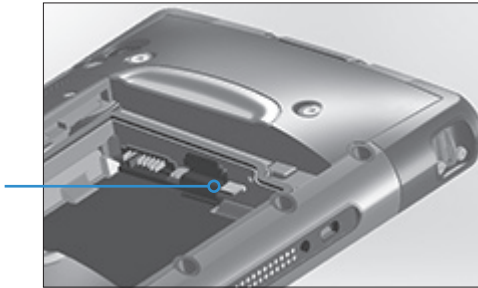

5. Push the flexible card holder back into place, covering the card slots.
6. Replace the battery pack, and attach the battery door. To remove the SIM card, gently pull it out with tweezers or a piece of tape.

Note: If the modem was on before shutting the SHC5000 down to insert the SIM card, you are prompted to configure the data connection when you reboot.

Office Docking Station

The Office Docking Station enables you to perform the following functions:

- Transfer data to another computer or network via an Ethernet connection
- Charge your SHC5000 Ruggedized Field Computer
- Use your SHC5000 as a desktop computer (a monitor, mouse, and keyboard can be connected)

Dock Features

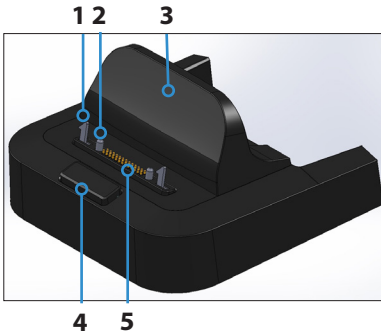

- 1 Lock Latch (2)
- 2 Alignment Pin (2)
- 3 Back Rest
- 4 Release Button
- 5 Pogo Pins
- 6 USB Ports (3)
- 7 HDMI Port
- 8 Ethernet Port
- 9 Power Input Jack



6 7 8 9

Ports

- The USB ports are for attaching devices to the SHC5000 such as a mouse, keyboard, or external storage device.
- The HDMI port is for connecting a video monitor to the SHC5000, giving you a second monitor.
- The Ethernet port is used for networking (an Ethernet cable is not included).

HDMI Port

Some early SHC5000 models require the use of a USB to HDMI dongle in order to use the HDMI feature.

The HDMI port on the dock can be used if the SHC5000 has three rows of docking pin contacts.



A dongle is required for HDMI if the SHC5000 has two rows of docking pin contacts.



Plug the USB connector on the dongle into a USB port on the dock, then plug the HDMI cable into the dongle. (Some dock models come with a dongle. They are also sold separately.)

How to Use the Dock

1. Provide power to the dock using the 20 W AC wall charger provided with your SHC5000 (the ports require external power). A 45 W charger is available as an option, and we recommend this charger if you are using the dock as an office computer with several peripheral functions. The 20 W AC wall charger might not provide enough power to charge the batteries and run the SHC5000.
2. Plug in the cables for your desired setup.
3. If a hand strap is covering the pin contacts on the SHC5000, unhook one end or remove it.
4. Hold the SHC5000 horizontally with the docking pin contacts facing down. Place it over the dock alignment pins and press down until you feel and hear the lock engage.

5. Some devices require drivers. If prompted, follow the instructions on the screen and wait for drivers to install. If you have a model of the dock that uses a USB to HDMI dongle, you may need to download and install a driver for the dongle. The newest version of the driver can be found here: <http://www.displaylink.com/downloads/file?id=675>. A disk with the driver on it is also provided with some dongles.

6. The SHC5000 charges more quickly if the power settings are set up to allow the SHC5000 to enter a low power mode when it is not in use, but is plugged in. To adjust this setting, go to the Start menu, then Settings > System > Power & sleep.

7. To remove the SHC5000 from the dock, press on the release button and pull the SHC5000 up.

Adding a Video Monitor or Projector

To connect a video monitor to the SHC5000, plug the device into the HDMI port (directly or through a USB to HDMI dongle). Go to the Action Center and select Project, then Extend or the option that you prefer. You can have the start bar appear on either one or both displays, or set the external monitor to be the main display. This can be helpful in an office environment. To set up additional features like orientation, go to the Start menu, then Settings > System > Display.

Mounting the Dock to a Surface

The Office Docking Station is freestanding. It can also be mounted to a surface like a desk or shelf. There are keyhole slots on the bottom for this purpose. The spacing between the holes is 4" (101.5 mm).

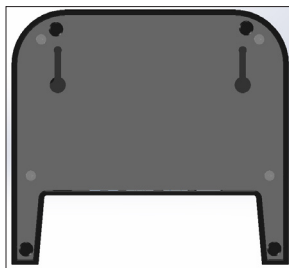

Ethernet Specifications

- 10/100/1000 Mbps twisted-pair Ethernet
- IEEE802.3/802.3u/802.3ab 10BASE-T, 100BASE-TX, and 1000BASE-T
- Manages twisted pair crossover detection and correction
- Full-duplex and half-duplex capability (only full-duplex operation at 1000 Mbps)

Maintenance and Environmental Issues

- The dock is intended for indoor use only.
- Temperatures should be between 0° C to 50° C.
- Avoid using the dock in situations where water can enter the connector ports. It is not sealed against water and must be kept dry.
- Do not touch the docking pins (spring loaded contacts) with conductive items when power is applied to the dock.
- Do not drop items on the dock that can damage the pins.
- Keep debris off of the docking pins

Battery Charger

The Battery Charger is an optional accessory, allowing you to charge spare battery packs for the SHC5000.

How to Use the Battery Charger

Batteries charge best at room temperature (about 68° F or 20° C). Batteries will not charge (or might charge slowly) at temperatures below 32° F (0° C) or above 122° F (50° C).

Power the Battery Charger by using the AC wall charger provided with your battery charger kit or your SHC5000. Slide the battery pack into the battery charger, orienting it so that the battery contacts meet the charging contacts in the battery charger. The red LED flashes slowly, indicating that the battery pack is charging.

LED Indicator

The LED indicates the charging status:

- Solid, on: The battery pack is fully charged.
- Blinking (slow): The battery pack is charging.
- Off: There is no power. The battery is not charging.

A

Storage, Maintenance, and Recycling



SOKKIA

Storage, Maintenance, and Recycling

Follow the instructions in this chapter to properly maintain and recycle the SHC5000.

Storing the SHC5000 and Battery Pack

When the SHC5000 is not being charged and is in a sleep state, it draws a small amount of power. This power draw is used to maintain the memory (RAM) of the SHC5000 in the same state it was in when it was awake. We recommend charging the unit each night or weekend when it is in a sleep state.

If the SHC5000 is not charged while in a sleep state and the battery reaches a low charge, it automatically powers off to prevent further drain on the battery.

Note: Data and programs are secure as long as they have been saved, even if the battery pack becomes discharged. The ruggedized field computer does not depend on the battery to store the data for extended periods.

Storing the SHC5000 for Less Than Two Weeks

To store the SHC5000 for less than two weeks, complete the following steps:

1. Close all applications.
2. Plug the SHC5000 into the AC wall adapter that was shipped with your unit.

Storing the SHC5000 for More than Two Weeks

To store the SHC5000 for two weeks or more, complete the following steps:

1. Charge the battery pack 30 to 50 percent.
2. Close all running programs, and turn off the unit.
3. Remove the battery pack.
4. If you have an internal battery pack, press and hold the power button for 20 seconds to disconnect it.
5. Place the battery pack in a cool, dry location.
6. The AC adapter must be plugged in and connected to the SHC5000 in order to turn it on after storage.

Protecting the Touchscreen

Protect the touchscreen from impact, pressure, or abrasive substances that could damage it. To further protect the touchscreen, apply a screen protector (optional accessory) using the directions that come with it in the package.

! **CAUTION:** Be sure to replace the screen protector as often as the screen protector instructions recommend.

Cleaning the SHC5000

Make sure the battery door is securely installed. Remove the screen protector if you want to clean underneath it. Use warm water, a mild cleaning solution, and a soft bristle brush to gently clean the SHC5000.

! **CAUTION:** Do not direct a high-pressure stream of water at the device to clean it. This action could break the seal, causing water to get inside the device and voiding the warranty.

! **CAUTION:** Exposure to some cleaning solutions may damage your device, including automotive brake cleaner, isopropyl alcohol, carburetor cleaner, and similar solutions. If you are uncertain about the strength or effect of a cleaner, apply a small amount to a less visible location as a test. If any visual change becomes apparent, promptly rinse and wash with a known mild cleaning solution or with water.

Recycling the SHC5000 and Batteries

When the SHC-5000 and Li-Ion battery packs for your SHC-5000 reach the end of their service life, they must not be disposed of with municipal waste. It is your responsibility to dispose of your waste equipment by handing it over to a designated collection point for the recycling of waste electrical and electronic equipment.

B

Warranty and Repair Information



SOKKIA

Warranty and Repair Information

Limited Product Warranty

Two Year Warranty

Sokkia Corporation USA (SC) warrants that the SHC5000 Ruggedized Field Computer and internal battery shall be free from defects in materials and workmanship, under normal intended use, for a period of 24 months from the date of shipment, excepting that this warranty shall not apply to user replaceable battery packs, media containing SHC5000 and desktop PC programs, user documentation, and any accessories.

Ninety Day Warranty

SC warrants that the following items shall be free from defects in materials and workmanship, under normal intended use, for a period of ninety (90) days from the date of shipment:

- User replaceable battery packs
- Media containing the SHC5000 and desktop computer programs
- User documentation
- Accessories

Warranty Exclusions

This warranty shall not apply if:

- (i) the product has been set up improperly or has been improperly installed or calibrated,
- (ii) the product is operated in a manner that is not in accordance with the user documentation,
- (iii) the product is used for a purpose other than for which it was designed,
- (iv) the product has been used in environmental conditions outside of those specified for the product,
- (v) the product has been subject to any modification, alteration, or change by or on behalf of customer (except and unless modified, changed or altered by SC or under direct supervision of SC),

- (vi) the defect or malfunction results from misuse or accident,
- (vii) the serial number on the product has been tampered with or removed, or
- (viii) the product has been opened or tampered with in any way (such as the tamper evident VOID label indicating certified IP [Ingress Protection] seal area has been tampered with or removed).

Parts that are excessively worn are not covered under warranty. These may include, but are not limited to, the keyboard elastomer and switch matrix, hand straps, and the touch screen (if applicable).

This warranty is exclusive and SC will not assume and hereby expressly disclaims any further warranties, whether express or implied, including, without limitation, any warranty as to merchantability, fitness for a particular purpose, non-infringement or any warranties arising from the course of performance, dealing, or usage of trade. SC specifically makes no warranties as to the suitability of its products for any particular application. SC makes no warranties that

- its products will meet your requirements or will work in combination with any hardware or applications software products provided by third parties,
- the operation of its products will be uninterrupted or error free, or
- all defects in the product will be corrected.

SC shall not be responsible for software, firmware, information, or memory data contained in, stored on, or integrated with any products returned to SC for repair, whether under warranty or not.

Remedy

In the event a defect in materials or workmanship is discovered and reported to SC within the specified warranty period, after evaluation by a technician at a certified repair center, SC will, at its option, repair the defect or replace the defective part or product. Replacement products may be new or reconditioned. SC warrants any replaced or repaired

product for a period of ninety (90) days from the date of return shipment, or through the end of the original warranty period, whichever is longer.

Limitation of Liability

To the fullest extent allowed by law, the obligation of SC shall be limited to the repair or replacement of the product. SC shall in no event be liable for special, incidental, or consequential, indirect, special or punitive damages of any kind, or for loss of revenue or profits, loss of business, loss of information or data, or other financial loss arising out of or in connection with the sale, installation, maintenance, use, performance, failure, or interruption of any product. Any responsibility and/or liability of SC shall, in connection with a warranted product, be limited in the maximum amount to the original purchase price.

Governing Law

This warranty is governed by the laws of California, U.S.A. and excludes the United Nations Convention on Contracts for the International Sale of Goods. The courts of Utah shall have exclusive personal jurisdiction in case of any disputes arising out of or in connection with this warranty.

Warranty Repairs

To obtain warranty repair or service on the SHC5000, submit a repair order on our website at <http://us.sokkia.com/sokkia-care> or contact an authorized repair center within the applicable warranty period. Products returned for repair or service without proper authorization may acquire an additional handling fee and/or delay in the repair. The customer is responsible to prepay all shipping costs when sending equipment to a repair center. The repair center will return the repaired equipment by the same method it was received with costs of shipping prepaid.

Services and Materials Provided Under Warranty

- Analysis of problem by service technician
- Labor and materials required to fix defective parts
- Functional analysis performed after repair
- Shipping costs to return device to customer

Complete Care Service Plans

We offer service plan options that provide additional benefits through participating repair centers. Services include:

- Service plan coverage up to five years from the original product ship date
- Up to a 50% discount on all charged repairs
- Expedited repairs and return shipping at no additional charge
- Replacement of worn and/or damaged parts at no additional charge
- Complete comprehensive coverage to protect your investment even when accidents occur
- Loaner product option when an expedited repair is not enough
- Priority support through a personal account specialist

For more information about our Complete Care service plans, go to our website at <http://us.sokkia.com/sokkia-care>.

Repairs, Upgrades, and Evaluations



CAUTION: Do not attempt to repair the SHC5000 yourself. This action voids the warranty.

Information about repairs, upgrades, and evaluations is located on our website at <http://us.sokkia.com/sokkia-care>. You can locate a repair center, submit a repair order, check repair status, view terms and conditions, get shipping instructions, and view lead times.

Before returning a unit, please get permission by submitting a repair order from our website and waiting for confirmation or by contacting a repair center directly. Be prepared to provide the following information:

- The product serial number. Information about your SHC5000 is shown when you go to the Start menu and select *Device Info*. The serial number is located inside the battery compartment as well.

Note: Before opening the battery door and removing the battery, see the proper procedure in Chapter 1, Getting Started and Chapter 2, Power Management.

- Name and shipping address of company/university/agency.
- Best contact method (phone, fax, email, cell/mobile).
- Clear, highly-detailed description of the repair or upgrade.
- Credit card/ purchase order number and billing address (for a repair or upgrade that is not covered by the standard warranty or an extended warranty policy).

System Information for your SHC5000

You might be asked to provide additional information about your SHC5000 when you contact a repair center. To view information like the operating system edition, OS build and serial number, go to the Start menu and select *Device Info*. You can find additional information under Action Center and select *All Settings > System > About*.

C

Warnings, Regulatory Information, Licensing



SOKKIA

Warnings, Regulatory Information, Licensing

Product Warnings

Follow the warnings listed below to use the SHC5000 and accessories safely.



Battery Warnings

WARNING! This device comes with a lithium-ion rechargeable battery pack. To reduce the risk of fire or burns, do not disassemble, crush, puncture, short external contacts, or expose the battery pack to fire.

Do not disassemble or open, crush, bend or deform, puncture or shred.

Do not modify or remanufacture, attempt to insert foreign objects into the battery, immerse or expose to water or other liquids, expose to fire, explosion or other hazard.

Only use the battery for the system for which it is specified.

Only use the battery with a charging system that has been qualified with the system per this standard. Use of an unqualified battery or charger may present a risk of fire, explosion, leakage, or other hazard.

Do not short circuit a battery or allow metallic conductive objects to contact battery terminals.

Replace the battery only with another battery that has been qualified with the system.

Use of an unqualified battery may present a risk of fire, explosion, leakage, or other hazard.

Promptly dispose of used batteries in accordance with local regulations.

Battery usage by children should be supervised.

Avoid dropping the battery. If the battery is dropped, especially on a hard surface, and the user suspects damage, take it to a service center for inspection.

Improper battery use may result in a fire, explosion or other hazard.

Excell Battery Company Charge Instructions

- 2EXL7524 Internal Battery: 3A Constant Current to 4.2V, 4.2V Constant Voltage to termination current of 50mA
- 2EXL7525 Removable Battery: 6A Constant Current to 4.2V, 4.2V Constant Voltage to termination current of 100mA



Wall Charger Warnings

WARNING! To reduce the risk of personal injury, electrical shock, fire or damage to the equipment:

Plug the wall charger into an electrical outlet that is easily accessible at all times.

Do not place anything on the wall charger cord or any of the other cables. Arrange them so that no one may accidentally step on or trip over them.

Do not pull on a cord or cable. When unplugging the wall charger from the electrical outlet, pull on the plug, not the cord.

The AC wall charger must be approved by Sokkia, have an output rating of 12 VDC and a minimum 1.67 A, and be certified or listed by a nationally recognized testing laboratory. The adapter provided with the SHC5000 meets these criteria. Using any other external power source can damage your product and void your warranty.

Certifications and Standards

There are North America and European Union versions of the SHC5000, with different certifications and standards.

United States

In compliance with the FCC rules 47 CFR 15.19(a)(3), the statements that follow must appear on the device or in the user documentation.

This device complies with Part 15 of the FCC Rules. Operation is subject to the following two conditions:

- The device may not cause harmful interference.
- This device must accept any interference received, including interference that may cause undesired operation.

In compliance with the FCC rules, 47 CFR 15.105(b), the user must be notified that this equipment has been tested and found to comply with the limits for a Class B digital device, pursuant to part 15 of the FCC Rules. These limits are designed to provide reasonable protection against harmful interference in a residential installation. This equipment generates, uses and can radiate radio frequency energy and, if not installed and used in accordance with the instructions, may cause harmful interference to radio communications. However, there is no guarantee that interference will not occur in a particular installation. If this equipment does cause harmful interference to radio or television reception, which can be determined by turning the equipment off and on, the user is encouraged to try to correct the interference by one or more of the following measures:

- Reorient or relocate the receiving antenna.
- Increase the separation between the equipment and receiver.
- Connect the equipment into an outlet on a circuit different from that to which the receiver is connected.
- Consult the dealer or an experienced radio/TV technician for help.

In compliance with the FCC rules, 47 CFR 15.21, the user must be notified that changes or modifications to the Ruggedized Field Computer that are not expressly approved by the manufacturer could void the user's authority to operate the equipment.

Only approved accessories may be used with this equipment. In general, all cables must be high quality, shielded, correctly terminated, and normally restricted to two meters in length. Wall chargers approved for this product employ special provisions to avoid radio interference and should not be altered or substituted.

Canada

In compliance with Industry Canada rules, the following statement must appear on the device or in the user documentation:

This Class B digital apparatus complies with
Canadian ICES-003.

This device complies with Industry Canada licence-exempt RSS standard(s). Operation is subject to the following two conditions: (1) this device may not cause interference, and (2) this device must accept any interference, including interference that may cause undesired operation of the device.

Canadian regulations restrict the use of channels in the band 5150 MHz to 5250 MHz to indoor use only. When this product is connected with an access point that is operating in this frequency range, or when using ad-hoc mode, the use of this product is restricted to indoor use only.

Le présent appareil est conforme aux CNR d'Industrie Canada applicables aux appareils radio exempts de licence. L'exploitation est autorisée aux deux conditions suivantes: (1) l'appareil ne doit pas produire de brouillage, et (2) l'utilisateur de l'appareil doit accepter tout brouillage radioélectrique subi, même si le brouillage est susceptible d'en compromettre le fonctionnement.

La réglementation canadienne restreignent l'utilisation des canaux dans la bande 5150 MHz à 5250 MHz pour une

utilisation en intérieur. Lorsque ce produit est connecté à un point d'accès qui fonctionne dans cette gamme de fréquences, ou lorsque vous utilisez le mode ad-hoc, l'utilisation de ce produit est limitée à une utilisation en intérieur.

Radio Frequency Safety

This equipment complies with radiation exposure limits set forth for an uncontrolled environment. This equipment is in direct contact with the body of the user under normal operating conditions. This transmitter must not be co-located or operating in conjunction with any other antenna or transmitter.

Cet équipement est conforme aux limites d'exposition aux radiations dans un environnement non contrôlé. Cet équipement est en contact direct avec le corps de l'utilisateur dans des conditions de fonctionnement normales. Cet émetteur ne doit pas être co-localisées ou opérant en conjonction avec tout autre antenne ou transmetteur.

CE Marking (European Union)



Products bearing the CE marking comply with the EU Directive 2014/53/EU.

CE compliance of this device is valid only if powered with/by a CE-marked wall charger provided by the manufacturer. Cables connecting to the USB host port must use a ferrite core/bead on the cable. The ferrite core must be placed on the cable near the end that connects to the SHC5000.

Declaration of Conformity

The Declaration of Conformity for CE Marking is available at: us.sokkia.com/products/software-field-controllers/field-controller-hardware/shc5000.

Korea

이 기기는 업무용(A급) 전자파 적합기기로서 판매자 또는 사용자는 이 점을 주의하시기 바라며, 가정외의 지역에서 사용하는 것을 목적으로 합니다

Class A device (Broadcasting Communication Device for Office Use): This device obtained EMC registration for office use (Class A), and may be used in places other than home. Sellers and/or users need to take note of this.

Licensing Information

This Product is licensed under the AVC, the VC-1 and the MPEG-4 Part 2 Visual patent portfolio licenses for the personal and non-commercial use of a consumer to (i) encode video in compliance with the above standards ("Video Standards") and/or (ii) decode AVC, VC-1 and MPEG-4 Part 2 Visual that was encoded by a consumer engaged in personal and non-commercial activity or was obtained from a video provider licensed to provide such video. None of the licenses extend to any other product regardless of whether such product is included with this product in a single article. No license is granted or will be implied for any other use. Additional information may be obtained from MPEG LA, LLC. See www.mpegla.com.

No rights are given for Dolby patents used in the Dolby portion of this product. A list of relevant patents may be obtained from Dolby Laboratories, Inc. No rights are granted to any Dolby copyrights, including the right to reproduce or distribute any portions of this product that includes Dolby intellectual property. Licenses for these activities may be obtained from Dolby.

Any use of this product in any manner other than personal use that complies with the MPEG-2 standard for encoding video information for packaged media is expressly prohibited without a license under applicable patents in the MPEG-2 patent portfolio, which license is available from MPEG LA, LLC, 6312 S. Fiddlers Green Circle, Suite 400E, Greenwood Village, Colorado 80111 U.S.A.

Windows 10 is automatically updated, which is always enabled. ISP fees may apply. Additional requirements may apply over time for updates.

Cortana experience may vary by device.

D

Specifications



SHC5000 Specifications

Note: Specifications are subject to change without notice.

FEATURE	SPECIFICATION
Operating System	<ul style="list-style-type: none"> ■ Microsoft® Windows 10 Pro ■ English, French, German, Spanish, Brazilian Portuguese, Dutch, Japanese, and Korean are built in; other languages are available for download
Processor	<ul style="list-style-type: none"> ■ Quad-core Intel® Atom™ Z3745
Memory	<ul style="list-style-type: none"> ■ 4 GB RAM (LPDDR3)
Primary Data Storage	<ul style="list-style-type: none"> ■ 64 GB or 128 GB flash storage (model specific)
Micro SD/SDXC Card Slot	<ul style="list-style-type: none"> ■ SD/SDXC slot, user accessible
Physical Features	<ul style="list-style-type: none"> ■ Dimensions, standard: 5.4" wide x 8.48" long x 1.36" thick (137 mm x 215 mm x 35 mm) ■ Weight: 1.5 to 2.2 lb (680-907 g) depending on battery configuration and internal options installed ■ Durable, chemical- and shock-resistant design ■ Easy-to-grip, impact-absorbing, overmolded bumpers
Display	<ul style="list-style-type: none"> ■ Active viewing area: 7" (178 mm) ■ WXGA 800 x 1280 pixel resolution ■ Backlit LCD ■ Outdoor viewable ■ Landscape or portrait orientation
Touchscreen	<ul style="list-style-type: none"> ■ Capacitive multi-touch interface for use with gloves, small tip stylus, and in wet conditions ■ Chemically-strengthened Dragontrail™ High Ion-Exchange (HIE™) coverglass for impact and scratch resistance ■ Touchscreen profile options

FEATURE	SPECIFICATION
Keyboard	<ul style="list-style-type: none"> ■ Programmable keys ■ Backlit keys
Batteries	<ul style="list-style-type: none"> ■ SHC5000 Rechargeable Li-Ion Bat 3.6 VDC 12000 mAh, 43.2 Whr Sokkia PN 1013591-01 ■ Run time of up to 20 hours ■ Charging time 4 to 6 hours ■ Built-in battery intelligence ■ User-replaceable ■ Internal 19.3 Whr battery provides an additional 50% of runtime and hot-swap capability; not user replaceable (not user accessible)
Connector Ports	<ul style="list-style-type: none"> ■ USB 3.0 Host (full size A connector) ■ Power input is 10 V. - 17 V., nominal 12 VDC ■ 3.5 mm audio jack, supports stereo headset/microphone
Wireless Connectivity	<ul style="list-style-type: none"> ■ <i>Bluetooth</i>[®] wireless technology 4.0 long range ■ <i>Bluetooth</i>[®] wireless technology 2.1 +EDR extended range (select models) ■ Wi-Fi 802.11 a/b/g/n 2.4 GHz and 5 GHz
Audio	<ul style="list-style-type: none"> ■ Mono speaker, loud and clear ■ Microphone, low noise
LED Activity Indicators	<ul style="list-style-type: none"> ■ Red: power applied/charging status ■ Green: application programmable ■ Blue: application programmable ■ Amber Light: Front or rear facing camera is in use
Standard Sensors/Features	<ul style="list-style-type: none"> ■ Ambient light sensor ■ Compass ■ Accelerometer ■ Gyroscope ■ TPM (Trusted Platform Module) v2.0

FEATURE	SPECIFICATION
Temperature Specifications	<ul style="list-style-type: none"> ■ Operating Temperature: -4° to 122° F (-20° to 50° C). Storage Temperature: -22° to 158° F (-30° to 70° C) ■ Battery Charging Temperature: 32°F to 122°F (0°C to 50°C)
Shock Resistance	<ul style="list-style-type: none"> ■ Withstands multiple 4 foot drops to concrete
Environmental Ratings and Standards	<ul style="list-style-type: none"> ■ IP68 rating (1.4 meters for 2 hours), waterproof and dustproof ■ Designed to MIL-STD810G. Tests: ME-60: sand & dust ME-51,53,& 54: X,Y,& Z-axis helicopter vibe ME-55, 56, & 57: X, Y, & Z -axis general vibe ME-52: Water Immersion, 1 meter ME-59: Aggravated Temperature-Humidity cycle ME-67: Temperature cycle ME-62: Temperature shock ME-66: Altitude
Certifications and Standards	<ul style="list-style-type: none"> ■ FCC Class B ■ CE Marking ■ Industry Canada ■ IEC/EN 60950 safety ■ <i>Bluetooth</i> SIG qualification ■ IP68 waterproof and dustproof ■ Designed to MIL-STD 810G ■ RoHS 2 compliant
Warranties	<ul style="list-style-type: none"> ■ 24 months for SHC5000 ■ 90 days for accessories ■ Extended service and maintenance plans

FEATURE	SPECIFICATION
Software Included	<ul style="list-style-type: none"> ■ Alarms & Clock ■ Calculator ■ Calendar ■ Camera ■ Cortana ■ Device Info (config/control) ■ File Explorer ■ Google Chrome ■ Groove Music ■ Keypad (config/control) ■ Magnifier ■ Mail ■ Magnet ■ Maps ■ Messaging ■ Microsoft Edge ■ Narrator ■ OneNote ■ Photos ■ Snipping Tool ■ Sticky Notes ■ Store ■ Task Manager ■ Touchscreen Profiles (config/control) ■ SRU ■ Voice Recorder ■ Windows PowerShell ■ Windows Speech Recognition <p><i>Software on individual units may vary from this list.</i></p>
Configurations	<ul style="list-style-type: none"> ■ Standard features: Wi-Fi, <i>Bluetooth</i>, 4 GB RAM, 64 GB flash storage, front and rear cameras and a GPS/GNSS receiver with internal antenna ■ Optional features: 4G LTE data modem, 128 GB storage, extended range <i>Bluetooth</i>® wireless technology <p>Configured for United States/Canada, European Union, or Australia (model specific).</p>

FEATURE	SPECIFICATION
Camera	<ul style="list-style-type: none"> ■ Resolution: 8 MP rear, 2 MP front ■ Auto focus ■ Video capture ■ JPEG image format ■ Flash
GPS/GNSS	<ul style="list-style-type: none"> ■ 2 to 5 meter typical accuracy ■ u-blox NEO-M8N GNSS receiver and integrated antenna ■ Integrated real-time SBAS receiver (WAAS, EGNOS, etc.) ■ 72 GNSS tracking channels
4G LTE Data Modem (option)	<ul style="list-style-type: none"> ■ Sierra Wireless AirPrime EM7355 or EM7305 (region dependant) ■ Supports micro-SIM card only. Micro-SIM card header inside battery compartment with card detect feature and card retainer. ■ Does not support voice calls or SMS ■ Supports 3G UMTS, HSUPA, HSDPA, HSPA, HSPA+, WCDMA, EVDO, LTE <p><i>* See more details at the end of this chapter</i></p>
Standard Accessories	<ul style="list-style-type: none"> ■ SHC5000 Adjustable Hand Strap (Sokkia PN 1013589-01) ■ Removable Li-Ion battery ■ AC wall charger with international plug kit <ul style="list-style-type: none"> - Input: 100-240 VAC, 50/60 Hz, 0.5 A - Output: 12 VDC, 1.67 A ■ Capacitive fine tip stylus with tether ■ Quick Start Guide ■ Owner's Manual (on our website) ■ Two year warranty on SHC5000

FEATURE	SPECIFICATION
Optional Accessories	<ul style="list-style-type: none"> ■ SHC5000 Docking Station, includes power/charge input, HDMI output, 2 USB 2.0 (full size A), Ethernet (<i>Sokkia PN 1013592-01</i>) ■ SHC5000 Battery Charger (<i>Sokkia PN 1013593-01</i>) ■ SHC5000 Adj Shoulder Strap (<i>Sokkia PN 1014588-01</i>) ■ SHC5000 Ultra-Clear Screen Protector (<i>Sokkia PN 1013584-01</i>) ■ SHC5000 Anti-Glare Screen Protector (<i>Sokkia PN 1013586-01</i>) ■ SHC5000 Polarized Screen Protector (<i>Sokkia PN 1013587-01</i>) ■ Survey/GPS pole clamp and mount ■ Vehicle charger cable, 12 V vehicle power port, 6 ft. ■ Vehicle mounting dock with power and communications ■ Vehicle Dock/Pole mount - dock attachment ■ AC wall charger, 45 W <ul style="list-style-type: none"> - Includes cord with U.S. plug - Input: 120-240 VAC, 50/60 Hz - Output: 12 VDC, 3.75 A ■ Serial cable ■ Holster carrying case ■ Flip cover fitted case ■ 4-point harness ■ SD cards in various sizes ■ Office 365

* 4G LTE Data Modem - Additional Information

<u>Mode</u>	<u>Model/Region</u>	<u>Frequency Bands</u>
LTE	North America	B2, B4, B5, B13, B17, B25
	EU/ROW	B1, B3, B7, B8, B20
UMTS/HSPA+	North America	B1, B2, B4, B5, B8
	EU/ROW	B1, B2, B5, B8
GSM/GPRS/EDGE	North America	GSM 850, EGSM 900, DCS 1800, PCS 1900
	EU/ROW	GSM 850, EGSM 900, DCS 1800, PCS 1900
CDMA 1xRTT/ EV-DO Rev A	North America	BC0, BC1, BC10

Note: ROW = Rest of World, or Non-North America

Index



Index

Symbols

- 4G Data Modem
 - Data Account, Set up With Wireless Provider 26
 - Maintenance of Your Modem 28
 - Set up the Cell Modem 28
 - SIM Card Installation 26

A

- Accessories
 - Optional 57
 - Standard 56
- Action Center 10
- AC wall charger 45
- Anatomy of the SHC5000 2–3
- Audio Features 19
 - Audio Jack 19
 - Microphone 19
 - Speaker 19

B

- Battery Compartment 3
- Battery Door 2–3
- Battery Pack
 - Battery Life 14, 15
 - Charge 5, 14
 - Install 4–5
 - Internal 2, 14–15
 - Removable 3, 4
 - Status 14
 - Storage 34
 - Warnings 44
- Battery Pack, Internal 14–15
- Battery Pack, Removable 3–5, 14–16
- Bluetooth Wireless Communication 22–23

C

- Camera 24
 - Specifications 56

- Care and Maintenance
 - Cleaning 35
 - Storage 34
- Cautions 17, 26, 35, 41
- Certifications and Standards 46
 - Canada 47
 - CE Marking, European Union 48
 - Licensing Information 49
 - Radio Frequency Safety 48
 - United States 46
- Cleaning 35
- Compass 22
- Configurations 55
- Connector Ports 3, 18
- Ctrl-Alt-Delete Function 20

D

- Data Modem 26
 - Set up a Data Account 26
 - Install the SIM Card 26
- Data Storage 52
- Declaration of Conformity 48
- Display
 - Backlight 11
 - Magnifier 11
- Dock. *See* Office Docking Station
- Documentation 3

E

- Environmental Ratings and Standards 54
- Equipment Warnings 45
- Excell Battery Company Charge Instructions 45

F

- Features
 - Optional 26
 - Standard 10

G

- GPS/GNSS 23, 56

H

Hand Strap 7

Hibernate 19

K

Keypad

Backlight Brightness 13

Programmable Keys 13

L

Language Installs 8

LED Activity Indicators 16

Light Sensor 16

Limitation of Liability 40

Locked Up 21

M

Magnifier 11

Memory 52

Microphone 19, 53

O

Office Docking Station 28

Operating System 10, 52

Install Languages 8

Updates 8

P

Physical Features 52

Powering Off and On 20

Power Management

Battery Pack 15

Power Off 20

Product Warnings 44

R

Recovery Image 21

Recycling the SHC5000 and Batteries 36

Removable Battery Pack 3–5

Repairing 41

System Information 42

- Repairs, Upgrades, and Evaluations 41
- Reset 20
- Resetting the SHC5000 21
- Restore 21

S

- Screen Protector 57
- SD Cards 17
- Sensors 22
 - Accelerometer 22
 - Compass 22
 - Gyroscope 22
- Service Plans 41
- Set Up 6
- Set up Tasks, Initial 3
- SIM Card 3, 4, 27
- Sleep 19
- Software Included 55
- Speaker 2
- Specifications 52–59
- Start Menu 10
- Storing the SHC5000 34
- Stylus 3, 7, 18
 - Stylus Storage Slot 2
 - Tether 7
- System Information 10, 42

T

- Tablet mode 6
- Task Manager 20
- Temperature Specifications 54
- Touchscreen 10–12
 - Calibration Tool 12
 - Protecting the Touchscreen 35
- Settings 10
- Specifications 52

U

Updates, Operating System and Documentation 8
USB Host 18

W

Wall Charger 45
Warnings 44–45
 Battery Warnings 44–45
 Wall Charger Warnings 45
Warranty 38–41
 Exclusions 38
 Limitation of Liability 40
 Remedy 39
 Repairs 40
 Services 41
 Warranty Exclusions 38
Wi-Fi Wireless Communication 23
 Connecting to a Wi-Fi Network 23
Windows Start Menu 10
Wireless Safety 28