



ALUMINUM FENCE

VERSATILE/ADAPTABLE/FUNCTIONAL/BEAUTIFUL

PRODUCT CATALOG

Table of Contents

Horizontal Slat Fencing	4
Vertical Slat Fencing	6
3D Vertical Blade Fencing	8
Slat Picket Fencing	10
Louver Slat Fencing	12
Pool Fencing	14
Glass Pool/Balcony Fence	16
Perforated Metal Panel	18
Tubular Fencing	19
Perimeter Fencing	20
Commercial/	20
Residential	21
Raking/Hillside Fencing	22
Laser Cut Panel Fencing	23



SLAT FENCE

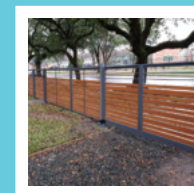

Horizontal slat



Vertical slat

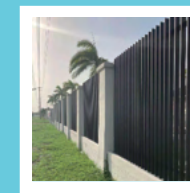

3D Vertical blade



Picket slat



Louver slat

Horizontal slat fence



System

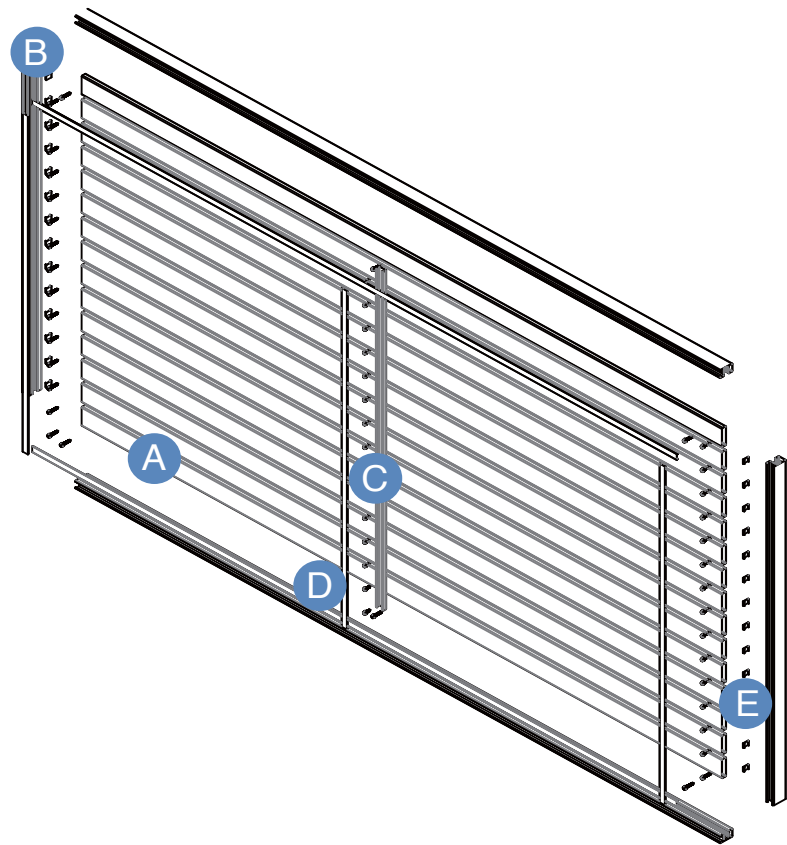

General Notes:
 1. All Dimensions are shown in mm.
 2. All Dimensions are shown before finishing or coating
 3. All Dimensions are ± 0.5mm (unless otherwise noted)

Ref.	Description
A	Slat
B	U-Channel
C	Center Support
D	Channel Caps
E	Screws



PANEL HEIGHT	SLAT Option	STRUCTURE	SURFACE	COLOR
1200mm(48")	65mm slat	DIY/Preassembled	Powder coating	Grey /Black
	100mm slat			
1500mm(60")	65mm/100mm slat	/welded	wood grain	/White /wood grain
1800mm(72")	116mm slat			
	150mm slat			
	150mm T&G slat			/customized

ALUMINUM SLAT FENCE STRUCTURE

1. POST - flanged post or in ground post, with cast aluminum post caps
2. U CHANNEL - connect the the slats and the posts
3. C CHANNEL - Center support

SLATS - 65mm/100mm/116*16mm ventilation/150mm/ 150mm T&G

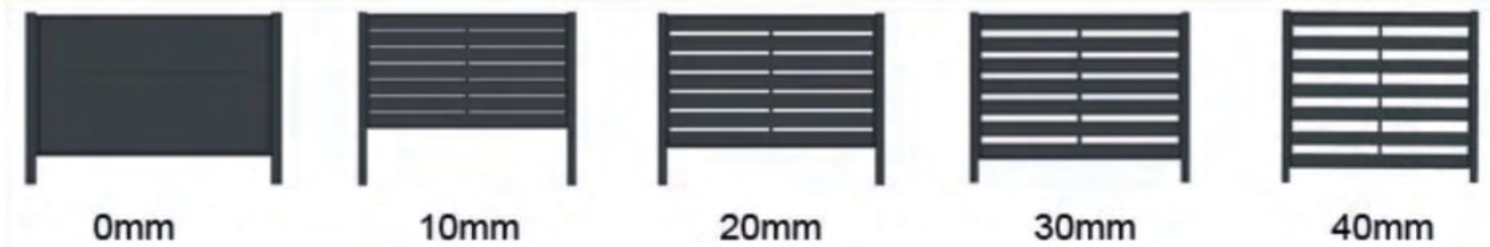

Standard color

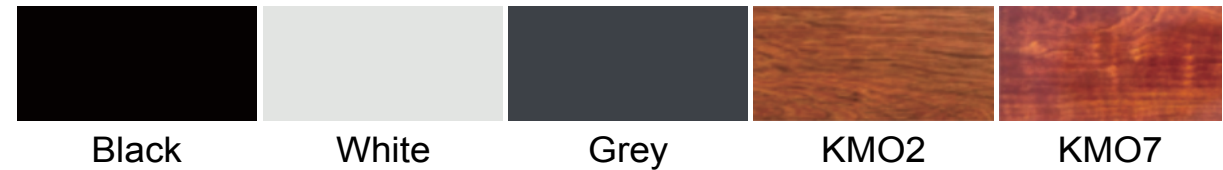

Installation Examples

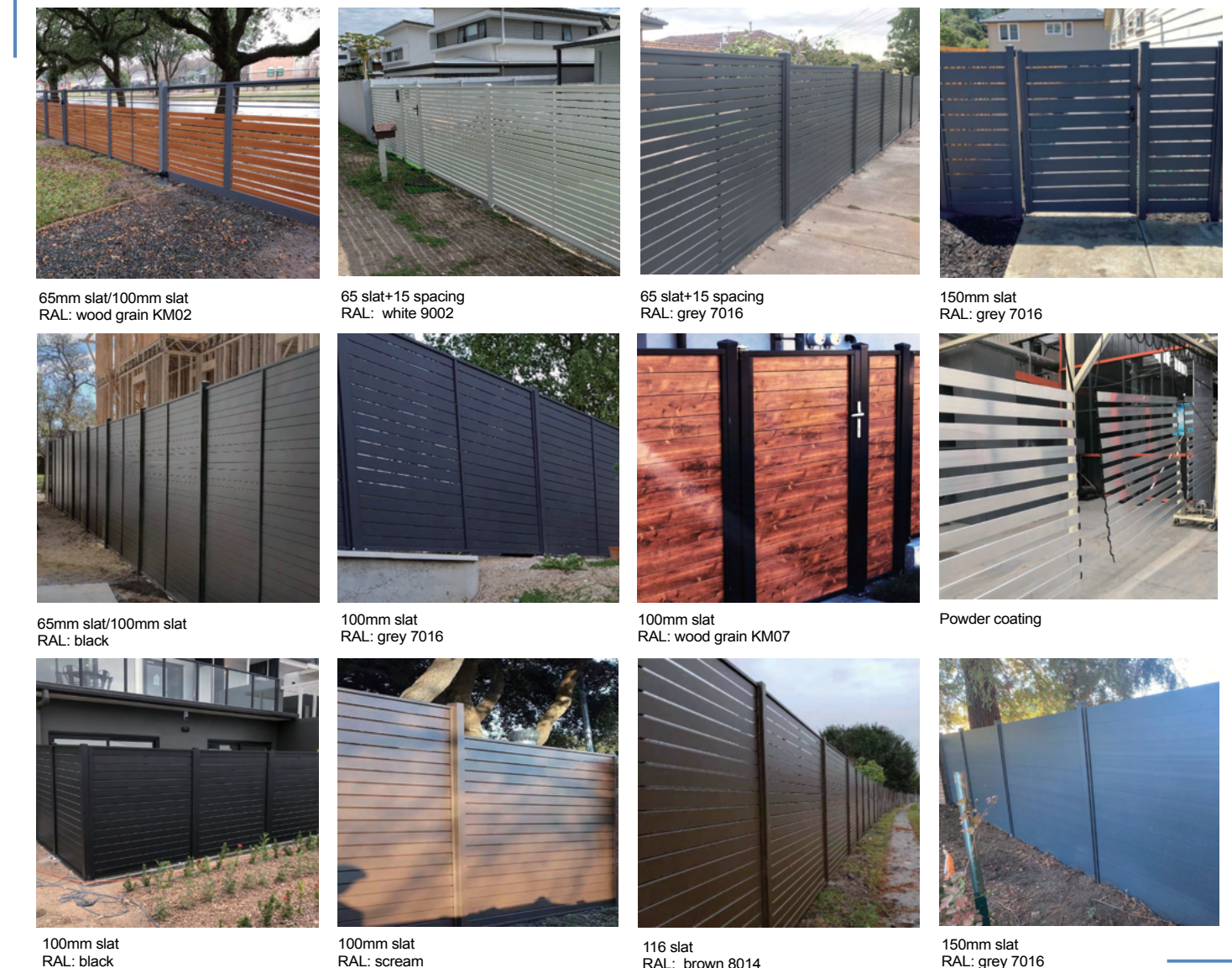

Vertical slat fence

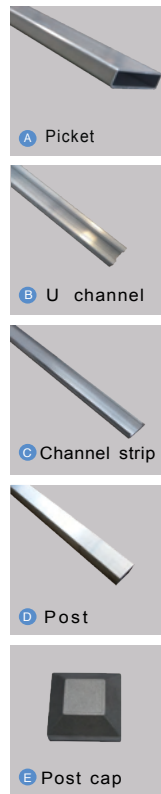
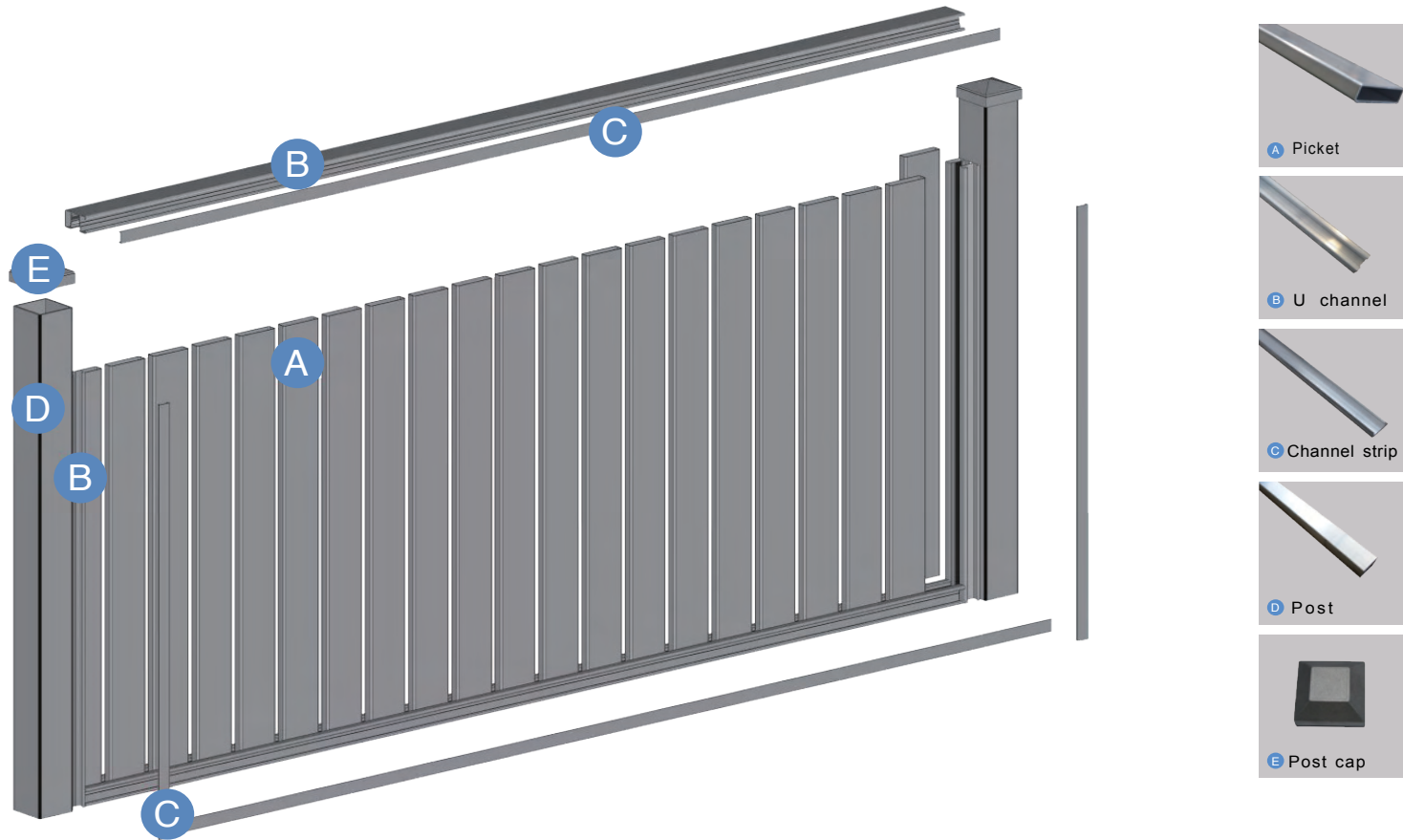

product name	Vertical slat fence
slat size	65x16mm/100x16mm/150x16mm (2.5"x5/8"/ 4"x5/8"/ 6"x5/8")
slat space	0mm/10mm/20mm (0"/ 3/8" / 3/4")
height	1200mm/1500mm/1800 (48" / 60" / 72")
length	2400mm (8')
post type	In-ground post/flanged post
post size	63.5*63.5mm/65*65mm/76*76mm/100*100mm (2 1/2" sq. / 2 3/4" sq./ 3" sq. / 4" sq.)
surface	Powder coating/wood grain
color	Grey /Black /White/customized



Security - defines the perimeter of your property to neighbors and visitors. Adds a dimension of security for your children and pets. Keeps unwanted visitors from entering your property

Style/Design - enhances your home or business with distinctive contemporary designs to match any building style. From wood grain and powder coated finishes in a variety of colors, these stylish extruded aluminum fences will add value and peace of mind

Durable/Low Maintenance - extruded aluminum with durable powder coating finishes will last a lifetime with little or no maintenance. Install and forget!

Standard color

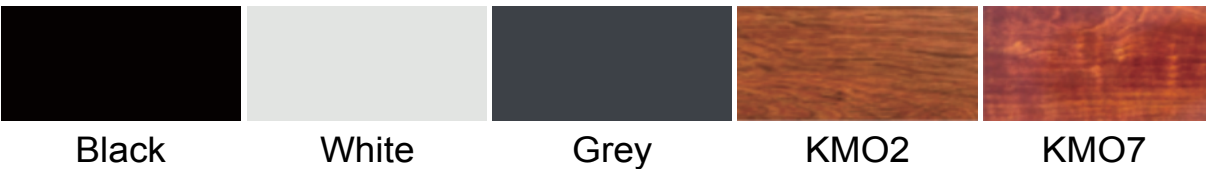

Fence

Gate

Privacy

3D Vertical blade



Type 1 - DIY

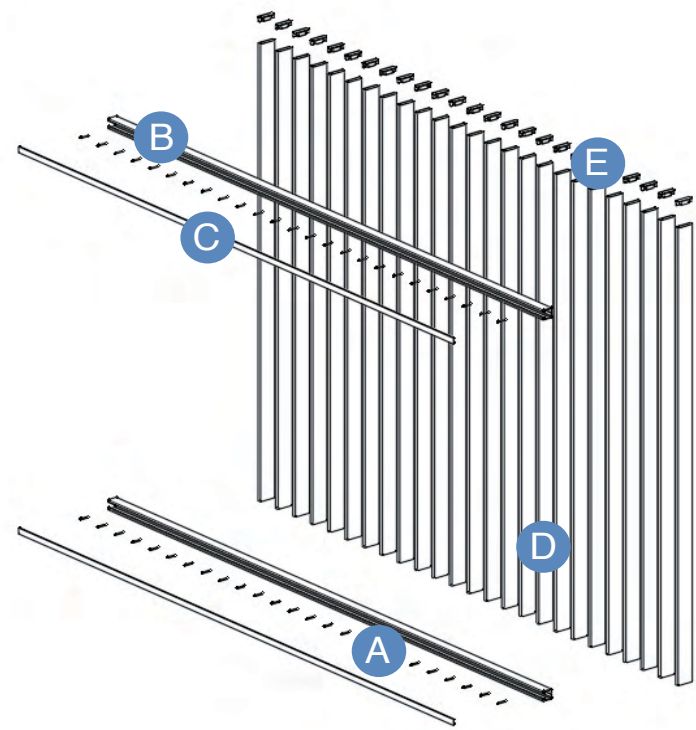

Ref.	Description
A	Screws
B	U channel
C	Channel caps
D	Picket
E	Post cap

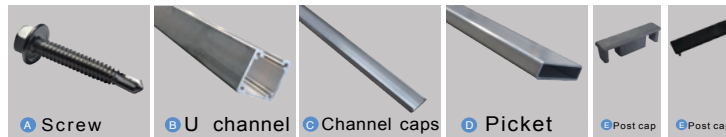

Type 2 - Welded

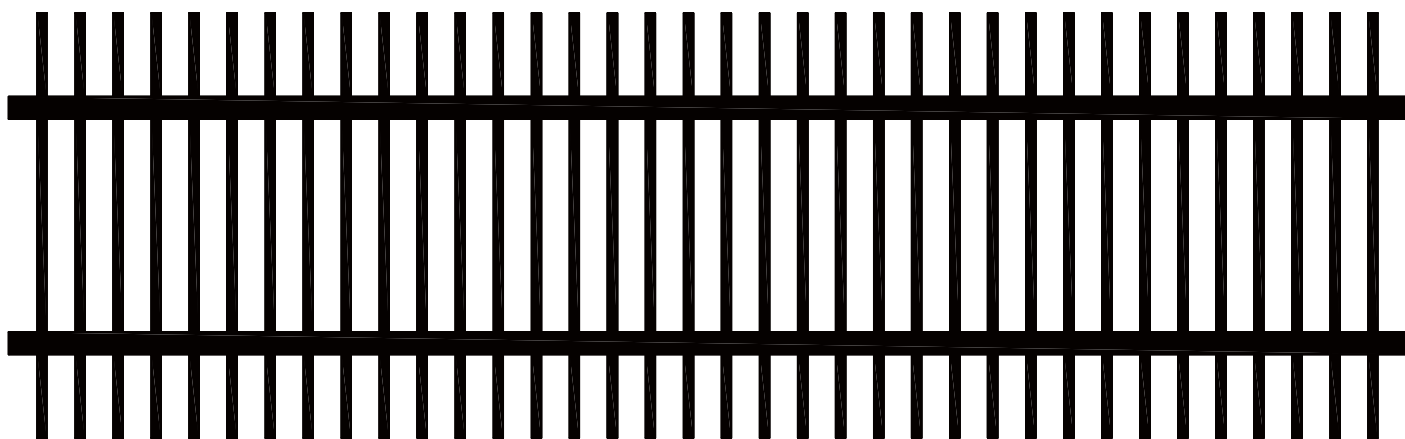

Product name	Aluminum 3D blade fence	Surface	Powder coating
Brand	Princeton	Color	Matte Black, Dark Grey RAL7016
Material	Aluminum 6063 T5	Warranty	10 years
Height	200 mm, 1500 mm, 1800 mm	/	/
Length	400 mm	/	/
Rail size	40*40*2.5mm thick	/	/
Blade size	65*16/50*10	Place of Product	ShanDong Province, China

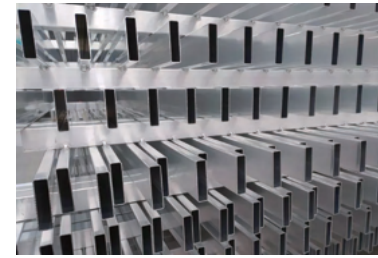

65*16mm

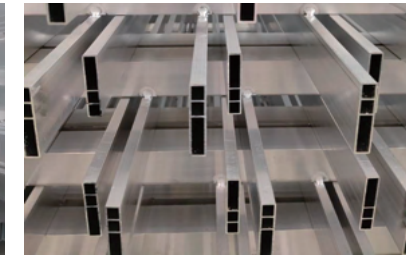

50*10mm

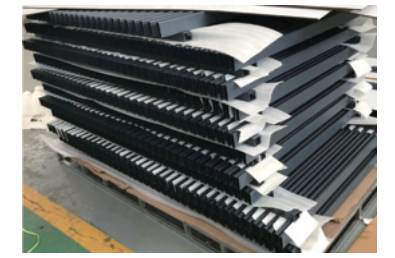

Powder coating standard color



Black

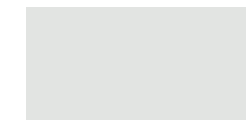

White



Grey

Installation Examples



Slat picket



Type 1 - Welded

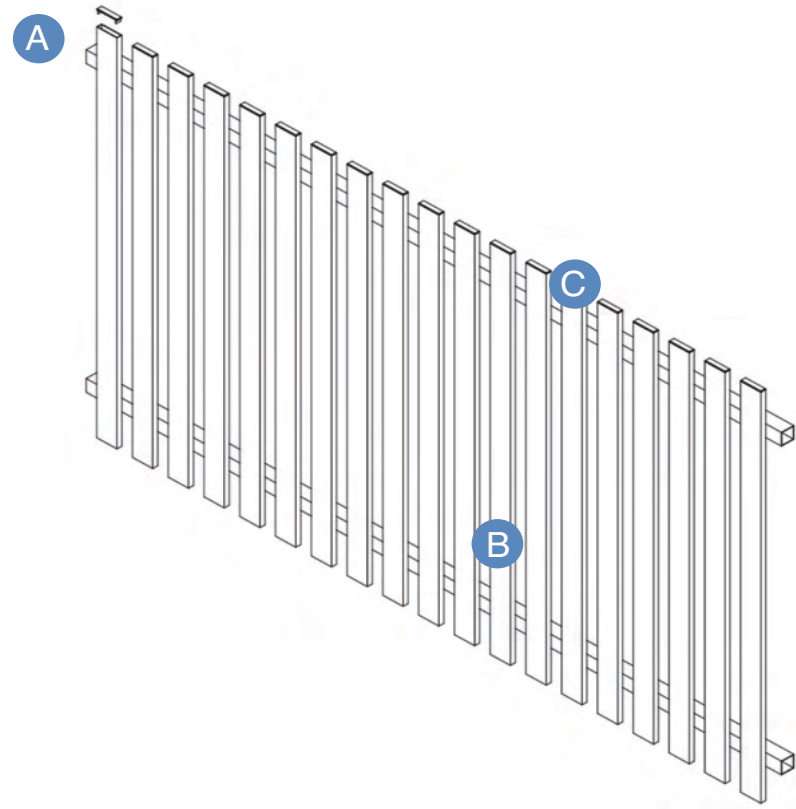

Description	Style	Size
A Rail	40*40*3mm	2235
	1.6"x1.6"x1/8"	89.4"
B Picket	65*16*1.2mm	1200
	2 5/8x5/8x1/16"	48"



Panel size	Slat size	Slat space	Installation type	Warranty	COLOR
1219*1524mm 48 3/4"x 61"	65*16*1.2mm 2 5/8x5/8x1/16"	20mm 3/4"	welded panels	10 years powder coated	Grey /Black /White/ Customized
1524*1829mm 61"x73 1/8"		30mm 1 3/16"		lifetime material	
customized	customized				



Black



White

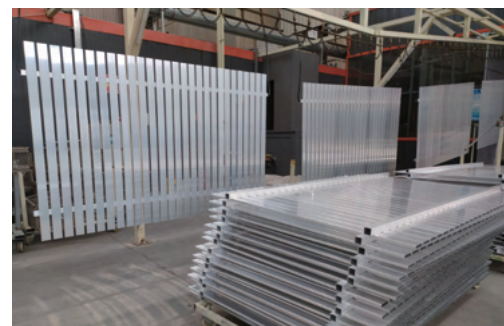

Powder coating

Type 2 - DIY

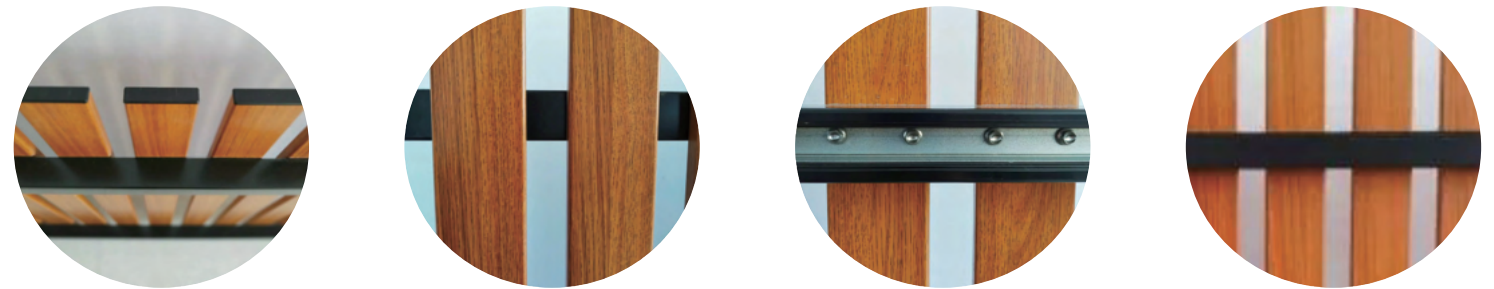
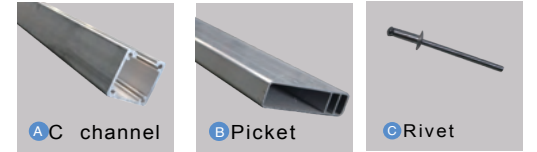
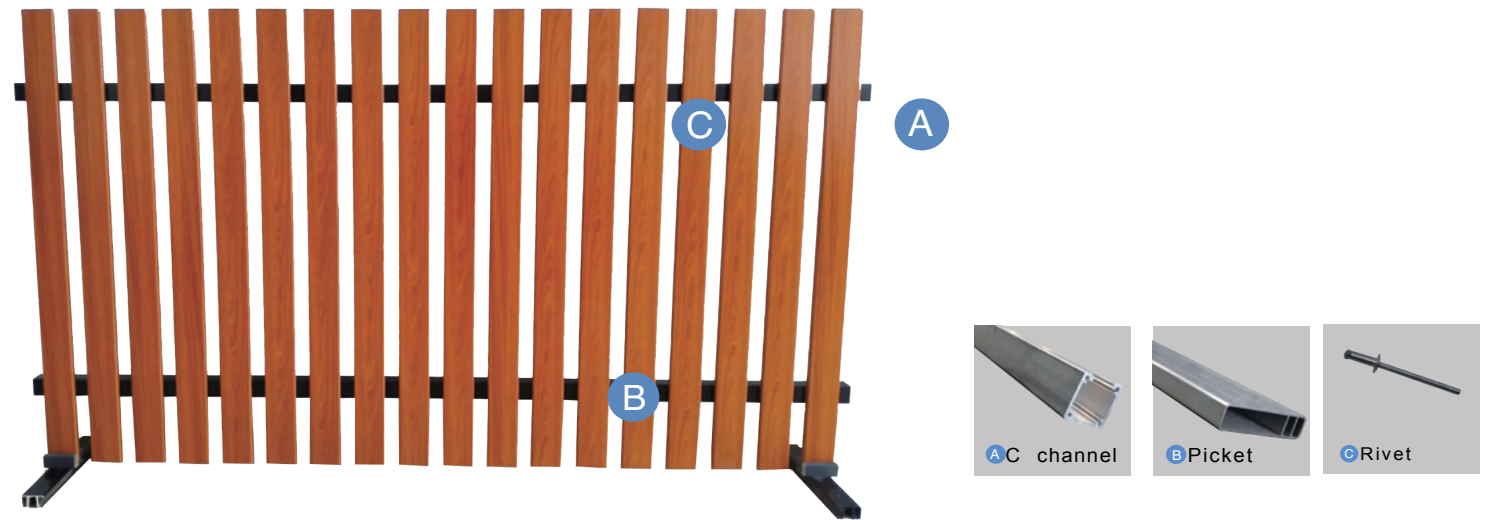

Powder coating standard color



Louver slat fence-PL120



Louver-01

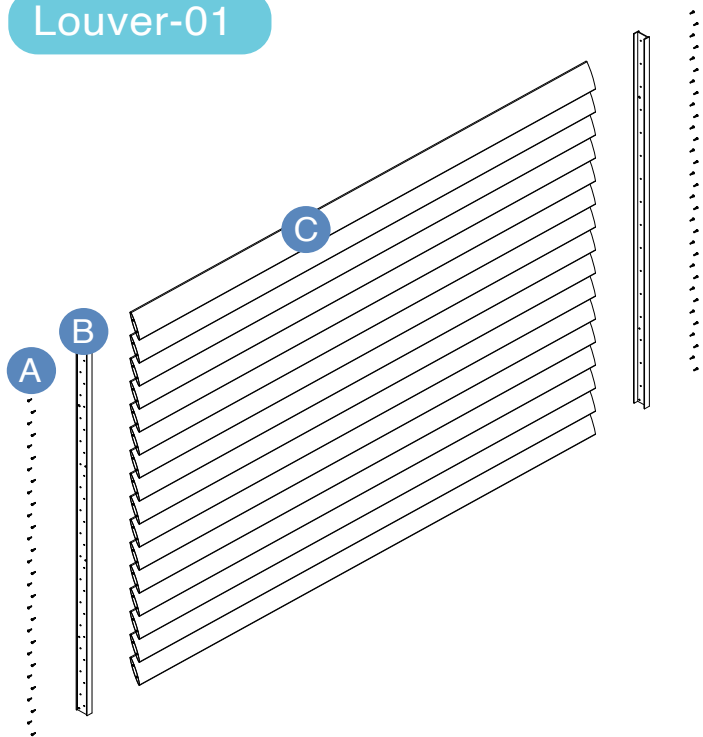

GENERAL NOTES
 1. ALL DIMENSIONS ARE SHOWN IN MM
 2. ALL DIMENSIONS ARE BEFORE FINISHING OR COATING
 3. ALL DIMENSIONS ARE ±0.5MM (UNLESS OTHERWISE STATED)

Ref.	Description
A	Stainless steel self-tapping screw
B	H-Channel
C	Louver Blade

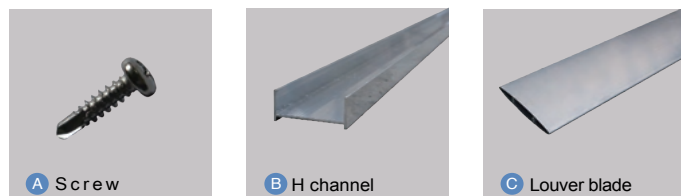

PANEL HEIGHT	SLAT	STRUCTURE	SURFACE	COLOR
1200mm/48" 1500mm/60" 1800mm/72"	Louvre blade	DIY Pre-assembled Welded	Powder coating	Grey /Black /White /Customized

A high-quality extruded aluminum louver fence offers contemporary styling, privacy, low maintenance and life-time durability. All fences included mounting posts (specify flange or in-ground) and come either preassembled, permanently welded or ready for DIY installation with simple tools. Use on windows in place of security bars as a functional, esthetically pleasing alternative to ugly bars.



H channel with pre-drilled holes

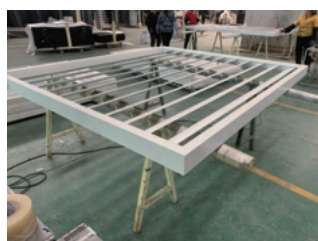

Easy Assembly



Aluminum Blades

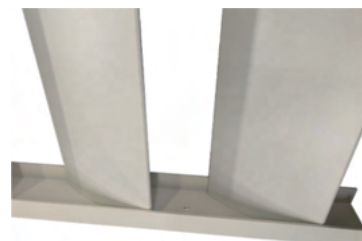

Installation Detail

Powder coating standard color



Black



White



Grey

Application



- 1 Fence and gates
- 2 Dividing screen
- 3 Sunshade
- 4 Window Security
- 5 Pergola

Louvre-02



PRODUCT CODE
 AHSF02 - Welded louver

PANEL HEIGHT
 1200mm/1500mm/1800mm

INSTALLATION METHOD
 Brackets

SLAT
 65mm slat

CONSTRUCTION
 Punched + welded

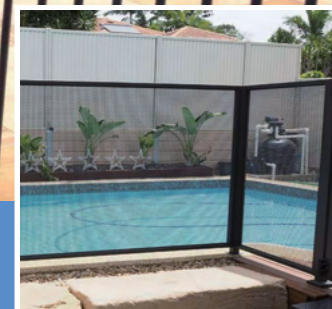
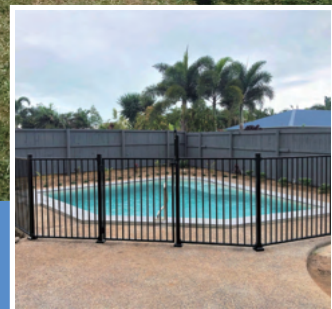

POOL FENCE

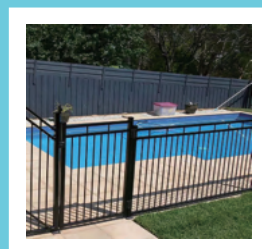

Picket

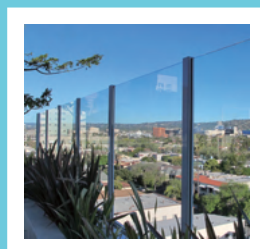

Glass



Perforated

Type 1 - Tubular Pool Fence



38*25mm Rail

16*16mm tube
19*19mm tube

1.5x1.0" Rail

5/8x5/8" tube
3/4x3/4" tube

38*38mm Rail

16*16mm tube
19*19mm tube

1.5x1.5" Rail

5/8x5/8" tube
3/4x3/4" tube

40*40mm Rail

19*19mm tube
25*25mm tube

1.6x1.6" Rail

3/4x3/4" tube
1x1" tube



Relative diameters of 5/8", 3/4" and 1" tube sections

Other styles

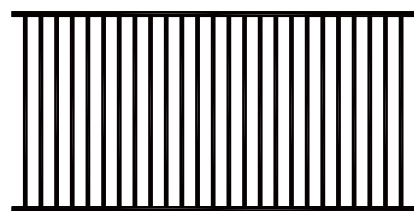

ATF02-1

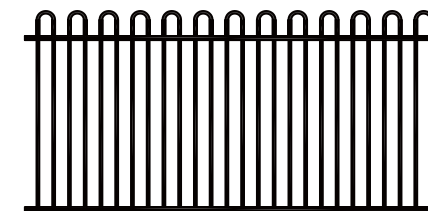

ATF02-2

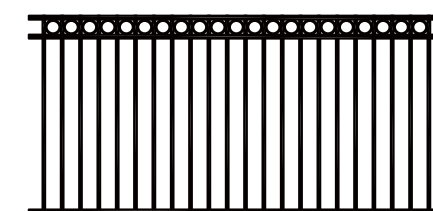

ATF03-1

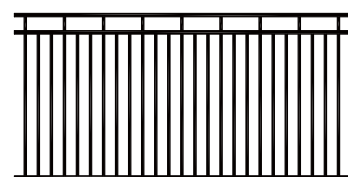

ATF03-2

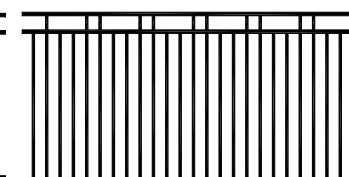

ATF03-3

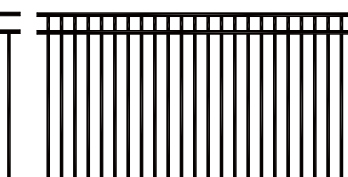

ATF03-4

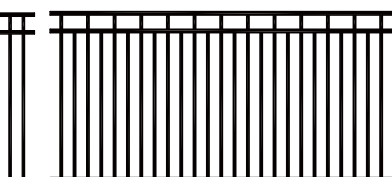

ATF03-5

Installation Examples

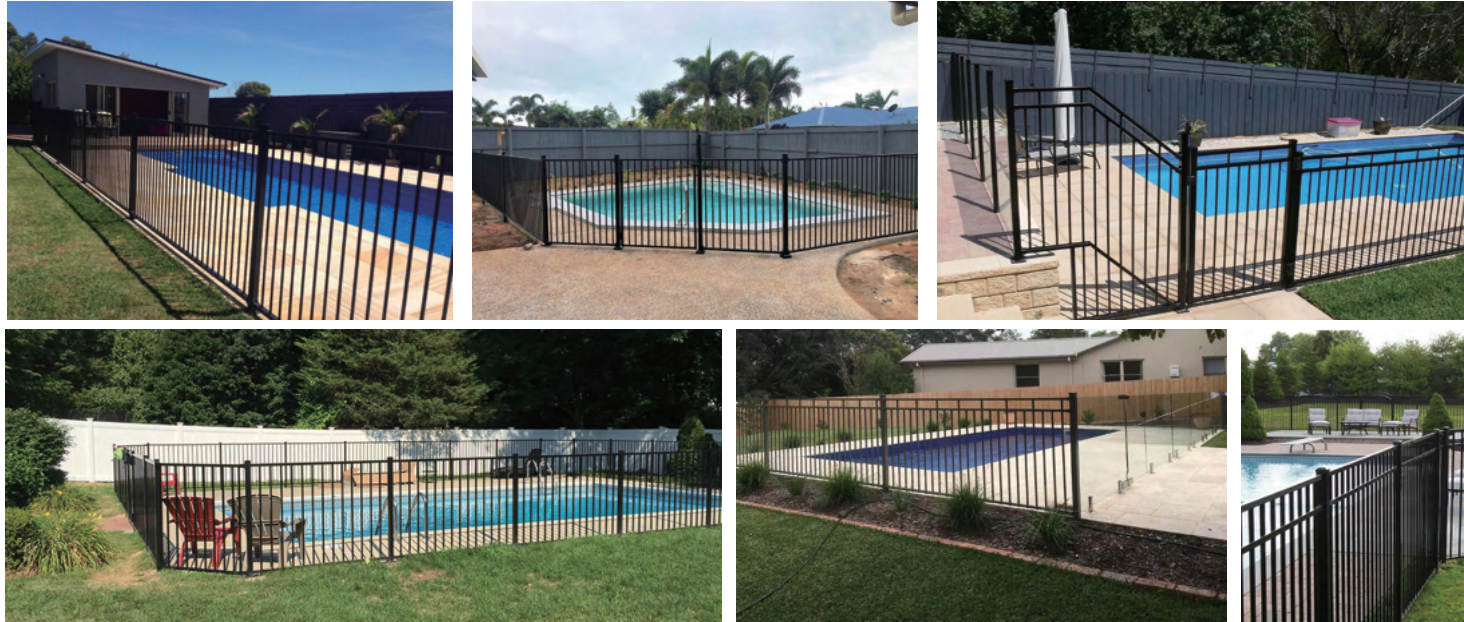

Type 2 - Glass Pool Fence

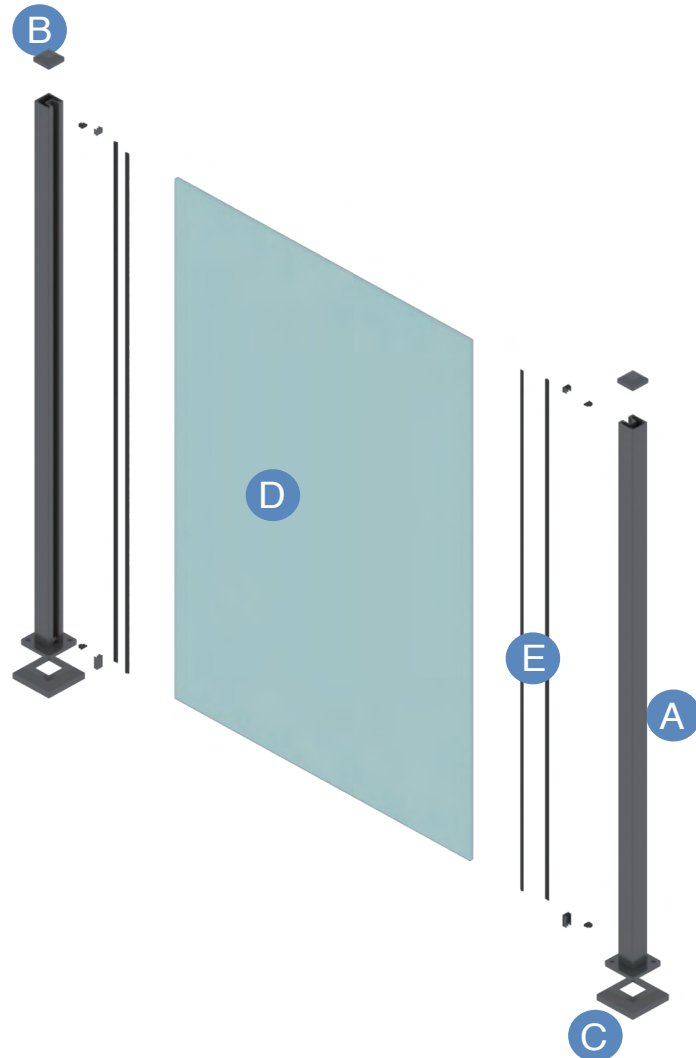

Ref.	Description
A*	Post
B	Post Cap
C	Cover base plate
D	Glass
E	Rubber

***Note regarding posts:**
 There are two types of posts:
 a) flange post for deck installations
 b) in-ground post installations
 Each installation method has the following post types available



Item	Tempered glass pool fence panels
Glass type	Tempered glass/Laminated glass
Color	Clear/ brushed / tinted
Tempered Glass	8mm/10mm/12mm/15mm (3/16"; 3/8"; 1/2"; 5/8")
Laminated Glass*	5+1.14PVB+5; 6+1.14PVB+6; 5+1.52PVB+5; 6+1.52PVB+6; 8+1.52PVB+8; 10+1.52PVB+10
Width	1000mm wide (40" W)
Height	1000mm/1100mm/1200mm (40"; 44"; 48")

* Similar to automotive windshields, our laminated glass is composed of a Polyvinyl layer sandwiched between two outer layers of glass of equal thickness. A 5+1.14+5 glass panel will therefore have a finished thickness of 11.14mm or just under 1/2".

Product Installations

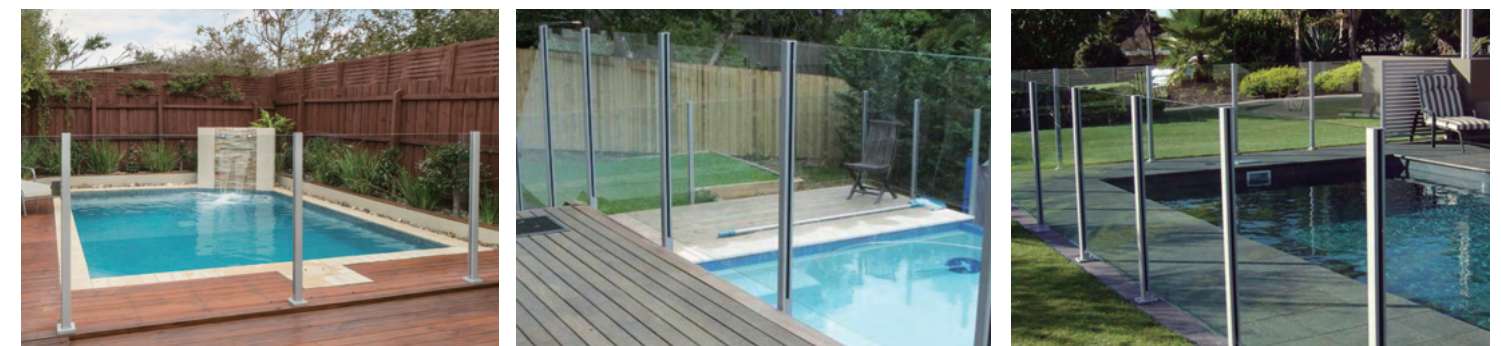
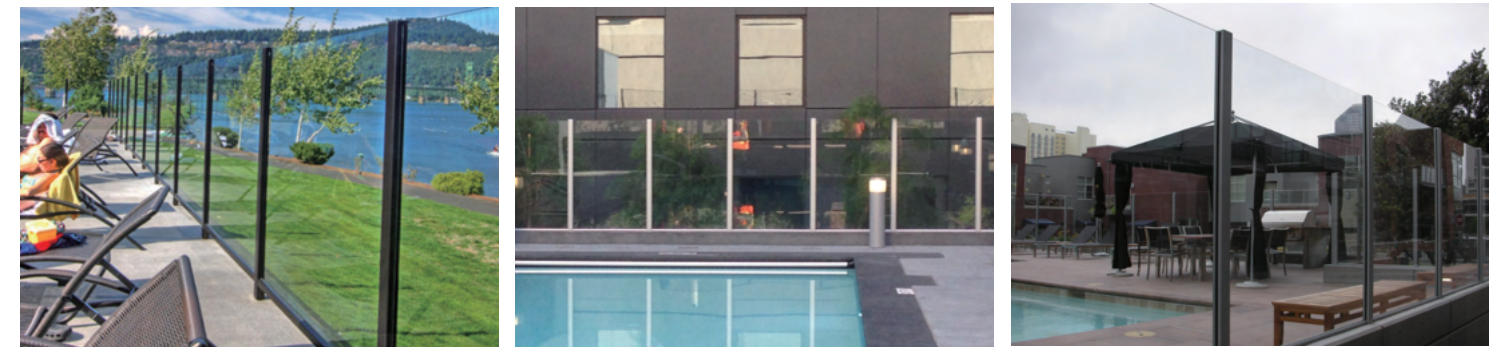

U channel fence



Type 3 - Perforated Pool Fence



TUBULAR FENCE



Garden



Security



Raking

Garden Fence



Residential

38*25mm Rail
16*16mm tube
19*19mm tube

1.5x1.0" Rail
5/8x5/8" tube
3/4x3/4" tube

Commercial

38*38mm Rail
16*16mm tube
19*19mm tube

1.5x1.5" Rail
5/8x5/8" tube
3/4x3/4" tube

Industrial

40*40mm Rail
19*19mm tube
25*25mm tube

1.6x1.6" Rail
3/4x3/4" tube
1.0x1.0" tube

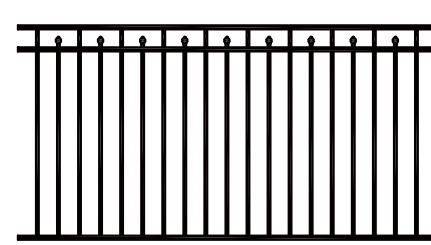

AL03-4

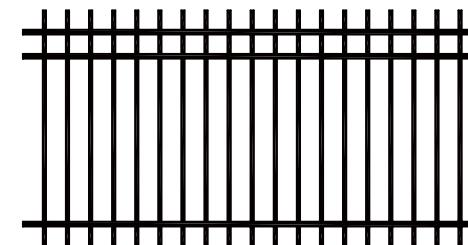

AL03-5

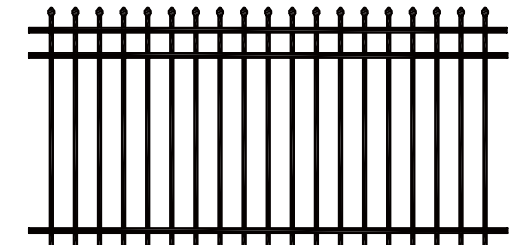

AL03-6

Product Installations



Cast Aluminum Fence Finials



2 Rail



AL02-1



AL02-2



AL02-3



AL02-4

3 Rail



AL03-1



AL03-2



AL03-3



AL03-4



AL03-5



AL03-6



AL03-7



AL03-8

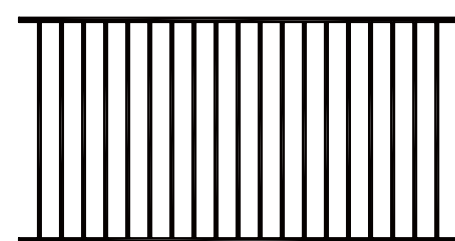

AL02-1

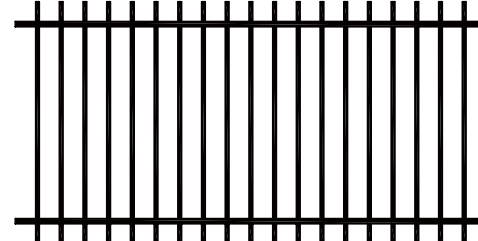

AL02-2

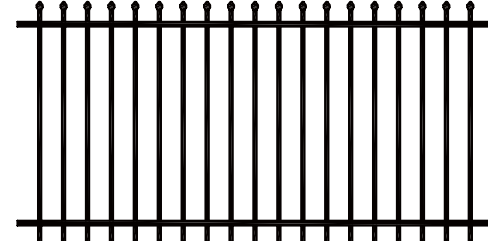

AL02-3

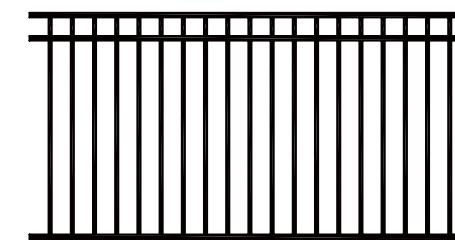

AL03-1

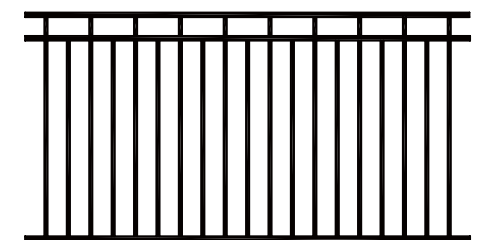

AL03-2

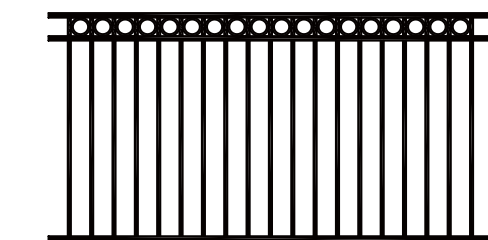

AL03-3

Raking Fence

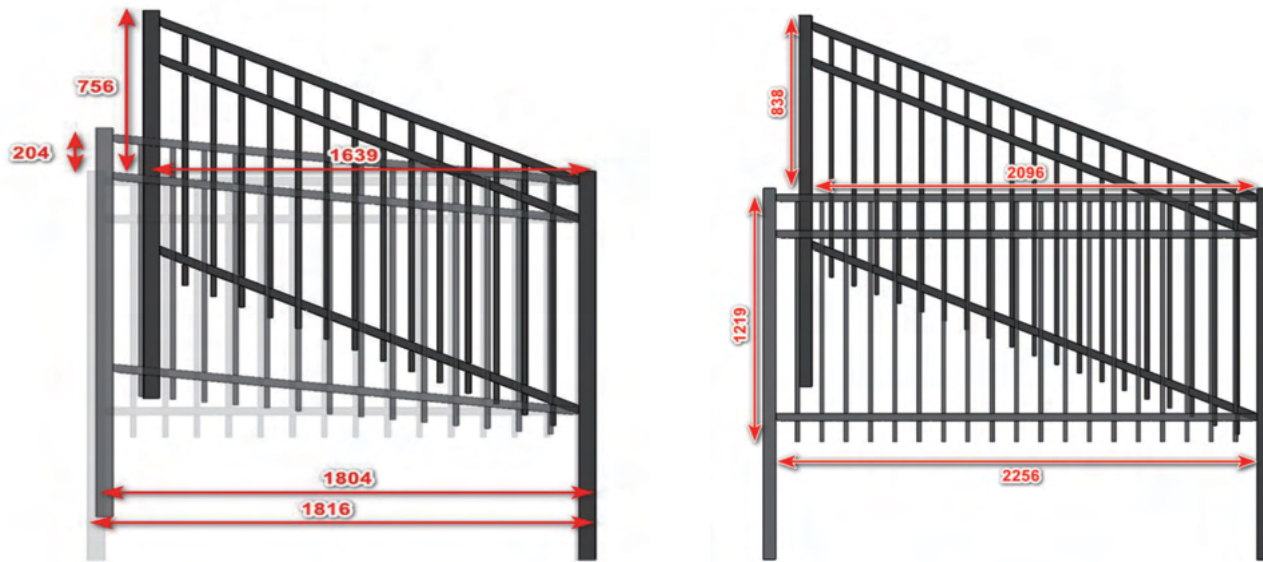

Decorative Garden Fence

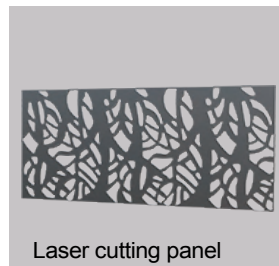
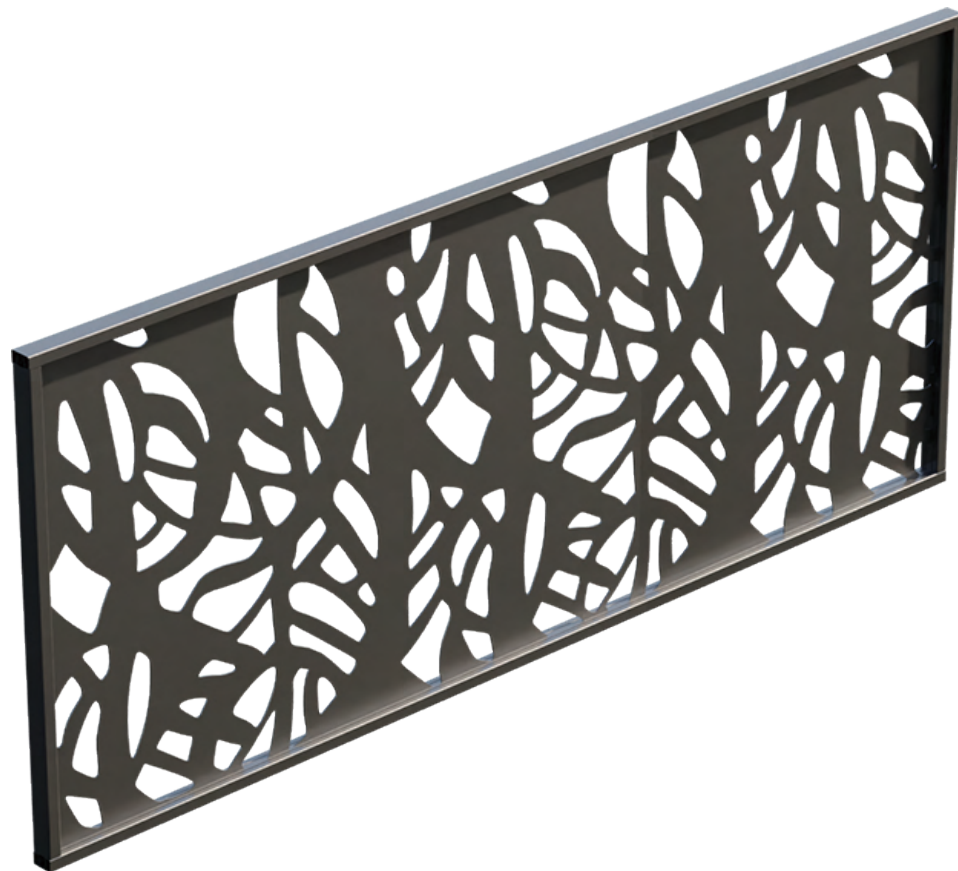

Laser cutting panel



U channel

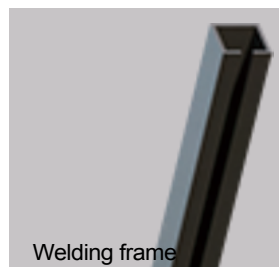

Welding frame

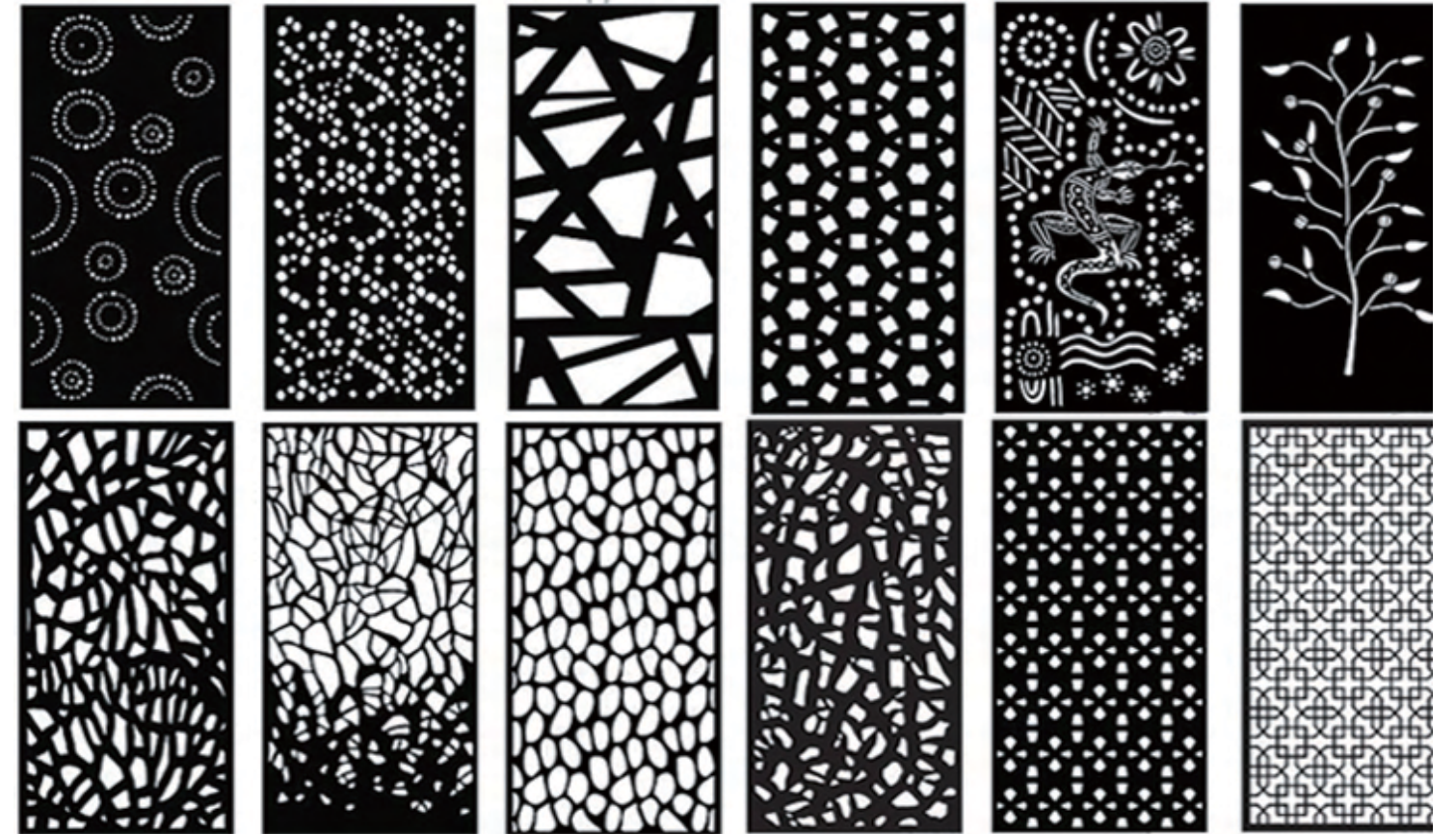

Laser Cut Aluminum Panels

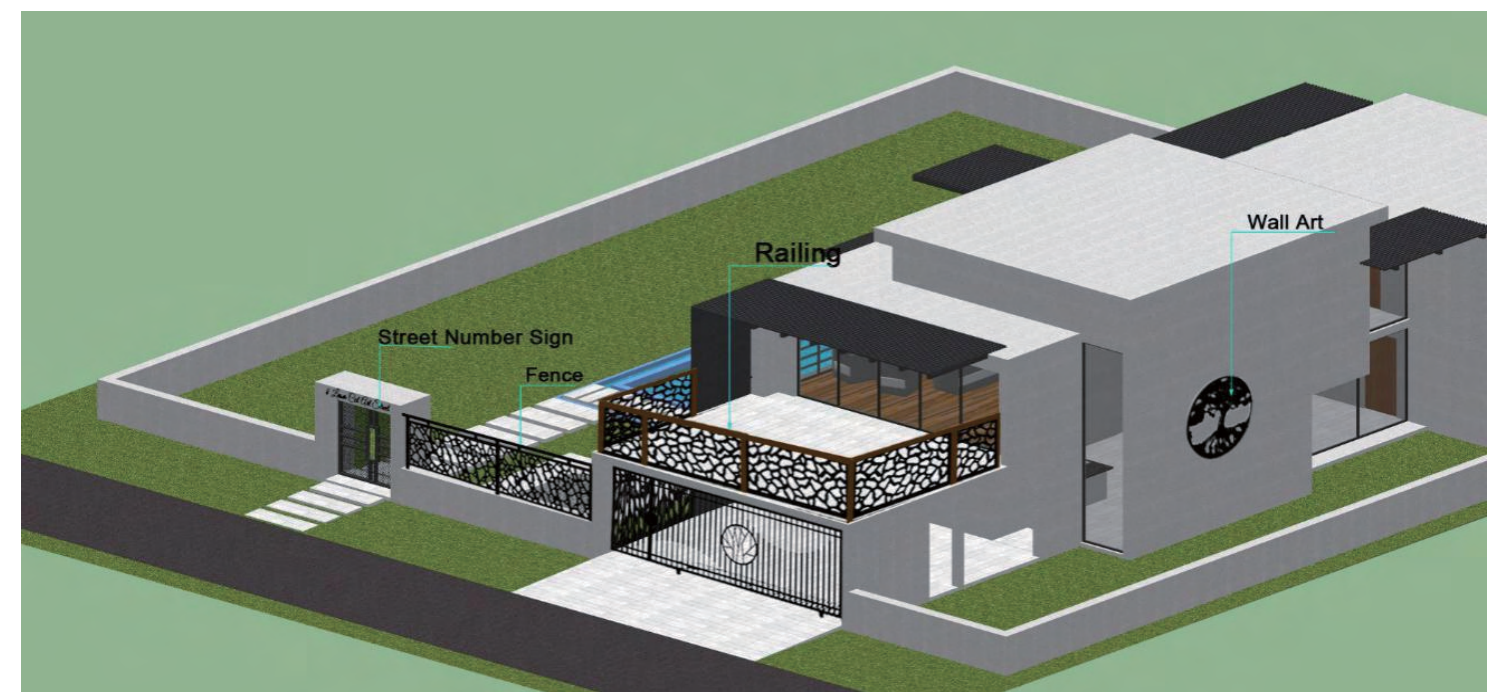

Exclusive US Distribution:



centuryironcraft.com



**PRINCETON
METAL**