

This document was prepared by
and should be returned to:
Robert B. Burr, Esq.
Rossin & Burr, PLLC
1665 Palm Beach Lakes Blvd., Suite 101
West Palm Beach, Florida 33401
(561) 655-8994

**CERTIFICATE OF AMENDMENT TO THE DECLARATION OF CONDOMINIUM
FOR LUCENTE VILLAGE "B", A CONDOMINIUM**

**THIS CERTIFICATE OF AMENDMENT TO THE DECLARATION OF CONDOMINIUM
FOR LUCENTE VILLAGE "B", A CONDOMINIUM is made by the President and Secretary of
LUCENTE VILLAGE CONDOMINIUM ASSOCIATION, INC. ("Association").**

W I T N E S S E T H :

**WHEREAS, the Declaration of Condominium for Lucente Village "B", a
Condominium was originally recorded commencing at Official Records Book 8796, Page
336 of the Public Records of Palm Beach County, Florida, and established covenants
running with the land therein described;**

**WHEREAS, the Association desires that the Amended and Restated Declaration of
Condominium for Lucente Village "B", a Condominium (attached hereto as Composite
Exhibit "1") be certified of record as notice to all current and future owners of property
subject to such Amended and Restated Declaration of Condominium.**

**NOW, THEREFORE, the President and Secretary of the Association hereby certify
that:**

**1. The Amended and Restated Declaration of Condominium (attached hereto
as Composite Exhibit "1") has been properly and duly approved and adopted by the
Association pursuant to the requirements of the Declaration of Condominium.**

**2. The Amended and Restated Declaration of Condominium for Lucente Village
"B", a Condominium (attached hereto as Composite Exhibit "1") shall run with the real
property subject to the Declaration of Condominium and shall be binding on all parties
having any right, title or interest in the real property subject to the Declaration of
Condominium, their heirs, successors and assigns, and shall inure to the benefit of each
owner thereof.**

[remainder of this page intentionally left blank]

IN WITNESS WHEREOF, the undersigned have set their hand and seal this 4th day of March, 2026.

Witnesses:

LUCENTE VILLAGE CONDOMINIUM
ASSOCIATION, INC.

[Signature]

Witness signature
Ray McKee

Printed Name
Post office address:
6131B Lake Worth Road,
Greenacres, FL 33463

By: [Signature]

Beverly Wolf, President
Post office address: 6131B Lake Worth Road,
Greenacres, FL 33463

Attest:

[Signature]

Witness signature
Terone Marsis

Printed name
Post office address:
6131B Lake Worth Road,
Greenacres, FL 33463

[Signature]

John Dietel, Secretary
Post office address: 6131B Lake Worth Road,
Greenacres, FL 33463

STATE OF FLORIDA)

COUNTY OF PALM BEACH)

The foregoing Certificate of Amendment was acknowledged before me this 4 day of March, 2026, by means of [] physical presence or [] online notarization by Beverly Wolf, as President and John Dietel, as Secretary of Lucente Village Condominium Association, Inc., a Florida not-for-profit Corporation, on behalf of said Corporation. The signatories are personally known to me or they have produced _____ as identification.

WITNESS my signature and official seal at _____, in the County of Palm Beach, State of Florida, the date and year last aforesaid.



[Signature]

NOTARY PUBLIC, State of Florida at Large
My Commission Expires:

This instrument was prepared by
and should be returned to:
Robert B. Burr, Esq.
Rossin & Burr, PLLC
1665 Palm Beach Lakes Blvd.
The Forum – Suite 101
West Palm Beach, FL 33401
Tel.: 561-655-8994

**[Substantial rewording of Declaration of Condominium. See existing
Declaration of Condominium for present text.]**

**AMENDED AND RESTATED DECLARATION OF CONDOMINIUM
OF
LUCENTE VILLAGE "B", A CONDOMINIUM**

The LUCENTE VILLAGE CONDOMINIUM ASSOCIATION, INC. ("Association") hereby adopts this Amended and Restated Declaration of Condominium of Lucente Village "B", a Condominium:

This Amended and Restated Declaration of Condominium amends and restates that certain Declaration of Condominium of Lucente Village "B", recorded at Official Records Book 8796, Page 336 of the Public Records of Palm Beach County, Florida.

All the restrictions, reservations, covenants, conditions, easements and limitations of record contained herein shall constitute covenants running with the land or equitable servitudes upon the land, as the case may be, shall run perpetually unless terminated as provided herein, and shall be binding upon all Unit Owners as hereinafter defined. In consideration of receiving and by acceptance of a grant, devise or mortgage all grantees, devisees or mortgagees, their heirs, personal representatives, successors and assigns, and all parties claiming by, through and under such persons, agree to be bound by the provisions hereof, the Articles of Incorporation and the Bylaws of the Association hereinafter defined. Both the benefits provided and the burdens imposed shall run with each Unit and the interests in Common Elements as defined herein.

The Declaration, Articles of Incorporation and Bylaws shall be deemed automatically amended to conform to Chapter 718, Florida Statutes and Chapter 617, Florida Statutes, as Chapter 718 and 617, are amended from time to time.

1. **DEFINITIONS.** As used in this Declaration, in the Articles of Incorporation and in the Bylaws attached hereto, and in all amendments thereto, unless the context requires otherwise:

A. "Assessment" means a share of the funds required for the payment of Common Expenses which from time to time are assessed against any Unit Owner.

B. "Association" or "Corporation" means Lucente Village Condominium Association, Inc., a Florida corporation not for profit responsible for the operation of the Condominium.

C. "Association Property" means that property, real and personal, which is owned or leased by or is dedicated by a recorded plat to the Association for the benefit of its members.

D. "Board of Administration" or "Board" means the board of directors or other representative body responsible for the administration of the Association.

E. "Articles" and "Bylaws" means the Amended and Restated Articles of Incorporation and the Amended and Restated Bylaws of the Association as they may be amended from time to time. The Amended and Restated Articles of Incorporation and Bylaws are separately recorded contemporaneously with this Amended and Restated Declaration.

F. "Central System" means a closed-circuit television system, telecommunication system, a master antenna system and community antenna television system and related ancillary services.

G. "Committee" means a group of Board members and Unit Owners appointed by the Board to make recommendations to the Board or take action on behalf of the Board.

H. "Common Elements" means that portion of the Condominium Property not included in the Units. Common Elements shall include the items described in Article 4 hereof.

I. "Common Expenses" means the expenses of administration, maintenance, operation, repair, replacement, or protection of the Common Elements and Association Property, costs of carrying out the powers and duties of the Association and any other expenses, whether or not included in the foregoing, designated as common expenses by the Condominium Act, or this Declaration, the Articles or the Bylaws.

J. "Common Surplus" means the excess of all receipts of the Association, including but not limited to Assessments, rents, profits and revenues on account of the Common Elements, over the amount of the Common Expenses.

K. "Condominium", "the Condominium", or "this Condominium" means Lucente Village "B", a Condominium.

L. "Condominium Building" means the structures which comprise that part of the Condominium Property within which the Units are located.

M. "Condominium Parcel" means a Unit together with the undivided share in the Common Elements which is appurtenant to the Units.

N. "Condominium Property" means and includes all lands that are subjected hereunder to condominium ownership, whether or not contiguous, and all improvements thereon and all easements and other rights appurtenant thereto intended for use in connection with the Condominium.

O. "Declaration" or "Declaration of Condominium" means this Amended and Restated Declaration of Condominium as it may from time to time be amended.

P. "Easement Property" means the land on which certain parking, pool and other facilities may be located, as described in Article 19. E. hereof.

Q. "Limited Common Elements" means and includes those Common Elements which are reserved for the use of a certain Unit or Units to the exclusion of other Units.

R. "Mortgagee" means a generally recognized and duly authorized institutional lender such as a bank, savings and loan association, insurance company, mortgage company, real estate or mortgage investment, trust, which owns or holds a first mortgage encumbering a Condominium Parcel. "Mortgagee" also includes the Federal National Mortgage Association, Government National Mortgage Association, Federal Home Loan Mortgage Corporation, Veterans Administration and Federal Housing Administration or any other lender, or its loan correspondent or agency of the United States Government holding, guaranteeing or insuring a first mortgage on a Condominium Parcel.

S. "Operation" or "Operation of the Condominium" means and includes the administration and management of the Condominium Property.

T. "Special Assessment" means any assessment levied against Unit Owners other than the Assessment required by a budget adopted annually.

U. "Unit" or "Apartment" means a part of the Condominium Property, which is to be subject to private ownership, as designated in this Declaration, which shall consist of land and/or improvements.

V. "Unit Owner", "Apartment Owner", or "Owner of a Unit" means a record owner of legal title to a Condominium Parcel as shown by the real estate records in the office of the Clerk of Palm Beach, Florida, whether such owner be one or more persons, firms, associations, corporations, or other legal entities. "Owner" shall not mean or refer to the holder of a mortgage or security deed, its successors or assigns, unless and until such holder has acquired title pursuant to foreclosure or a proceeding or deed in lieu of foreclosure; nor shall the term "Owner" mean or refer to any lessee or tenant of an Owner.

W. "Utility Service" as used in the Condominium Act, construed with reference to this Condominium, and as used in this Declaration, the Articles and the Bylaws shall include, but not be limited to, electric power, gas, hot and cold water, trash and sewage disposal.

2. CONDOMINIUM NAME, CONDOMINIUM PARCELS, APPURTENANCES, POSSESSION AND ENJOYMENT.

A. The name of this Condominium is LUCENTE VILLAGE "B", a CONDOMINIUM.

B. There shall pass with each Unit as appurtenances thereto:

(1) An undivided share in the Common Elements;

(2) An exclusive easement for the use of the airspace occupied by the Unit as it exists at any particular time and as the Unit may lawfully be altered or reconstructed from time to time, which easement shall be terminated automatically in any air space which is vacated from time to time;

- (3) An undivided share in the Common Surplus;
- (4) Membership of the Unit Owner(s) in the Association;
- (5) The use of such parking space or spaces as may be assigned for the Unit Owner's exclusive use, as further described in Article 25 hereof; and,
- (6) The use of storage closet or closets, if any, as may be assigned for the Unit Owner's exclusive use. Any damage to a storage closet shall be paid by and/or charged against the Unit.

C. Each Unit Owner is entitled to the exclusive possession of his/her Unit subject to the provisions of this Declaration. He/she shall be entitled to the use of the Common Elements, in accordance with the provisions of this Declaration and the purposes for which they are intended, but no such use shall hinder or encroach upon the lawful rights of other Unit Owners. There shall be a joint use of the Common Elements and a mutual easement for that purpose is hereby created.

D. When a Unit is rented or leased, a tenant(s) shall have all use rights in the Association Property and those Common Elements otherwise readily available for use generally by Unit Owners and the Unit Owner(s) of such rented or leased unit shall not have such rights except as a guest. The foregoing shall not interfere with the Unit Owner(s) rights of access as a landlord under the laws of Florida.

E. Each Unit is identified by a specific numerical designation as set forth in Exhibit "B" attached hereto. In horizontal dimension, each Unit consists of the area bounded by the unfinished interior surfaces of the perimeter walls, doors and windows of such Unit. In vertical dimension, each unit consists of the space between the top of the unfinished concrete floor and the bottom of the unfinished ceiling of each such Unit. Each Unit Owner(s) shall not own the undecorated or unfinished surfaces of the perimeter walls, floors and ceilings surrounding his/her Unit, nor shall he/she own pipes, wires, conduits or other utility lines running through his/her Unit which are utilized for or serve more than 1 (one) Unit, which items are hereby made part of the Common Elements. Said Owner(s), however, shall own the walls and partitions which are contained within his/her Unit, and inner decorated or finished surfaces of the perimeter walls, floor and ceilings, including plaster, paint and wallpaper.

F. Unit Owner(s) shall own and be responsible for the maintenance, repair and replacement of all components for the individual air conditioning unit which services his/her unit.

G. Subject to and except as provided by the provisions of Article 20 of this Declaration, Units shall only be used as single-family residences by the Owner(s) thereof, his/her family member(s) and guest(s) in accordance with Rules and Regulations of the Association.

3. RESTRAINT UPON SEPARATION AND PARTITION OF COMMON ELEMENTS.

A. The undivided share in the Common Elements which is appurtenant to a Unit shall not be separated therefrom and shall pass with the title to a Unit, whether or not separately described.

B. A share in the Common Elements appurtenant to a Unit cannot be conveyed or encumbered except together with the Unit.

C. The shares in the Common Elements appurtenant to Units shall remain undivided, and no action for partition of the Common Elements shall lie, except as provided herein with respect to the termination of the Condominium.

4. COMMON ELEMENTS.

A. Common Elements include the following:

(1) The land on which the improvements are located and any other land included in the Condominium Property, whether or not contiguous.

(2) Any portion of the Condominium Property which is not included within the Units.

(3) Easements through Units for conduits, ducts, plumbing, wiring and other facilities for the furnishing of Utility Services to Units and the Common Elements.

(4) An easement of support which is hereby created in every portion of a Unit which contributes to the support of a Condominium building.

(5) The property and installations required for the furnishing of Utility Services and other services to more than one (1) Unit, the Common Elements or a Unit other than the Unit containing the installation.

(6) The easement rights (but not the Easement property) described in Article 19. D. and E. of this Declaration.

B. The undivided share in the Common Elements, Common Expenses and Common Surplus appurtenant to each Unit is as follows: for Condo B, the share will be 1/24.

5. LIMITED COMMON ELEMENTS.

There may be Limited Common Elements appurtenant to Units in this Condominium as specified herein or reflected by the survey, plot plan, and graphic description of improvements, attached as Exhibit "B" hereto, which may include, but not be limited to, patios, balconies, storage closets and air conditioning compressors or other components, located within the Condominium Property which are specifically designated and delineated. Such Limited Common Elements shall only exist if and to the extent specifically shown as such on Exhibit "B" hereto, or expressly created as such herein. Such Limited Common Elements are reserved for the use of the Units, and there shall pass with a Unit as an appurtenance thereto the exclusive right to use the Limited Common Elements so appurtenant or assigned. Exterior surfaces of patios and balconies (including screening but not including any enclosure constructed by a Unit Owner) together with doors,

windows, skylights and casings and framing therefore shall be Limited Common Elements appurtenant to the Unit which they adjoin.

6. DESCRIPTION OF PROPERTY SUBMITTED TO CONDOMINIUM OWNERSHIP.

A. The legal description of the land hereby submitted to condominium ownership is set forth in Exhibit "A" attached hereto and made a part hereof.

B. Exhibit "B" attached hereto and made a part hereof is a survey of said land, a graphic description of the improvements in which Units are located, and a plot plan thereof. Although the Easement Property is also shown as part of Exhibit "B", such land, and any improvements thereon, if any, is not necessarily part of the Condominium Property.

C. The identification, location and dimensions of each Unit and the Common Elements appear on Exhibit "B". Together with this Declaration, Exhibit "B" includes sufficient detail to identify the Common Elements and each unit and provides adequate representations of their locations and dimensions.

7. AMENDMENTS TO PLANS.

A. No Unit Owner(s) shall make any addition, alteration or improvement in or to the Common Elements or any Limited Common Elements without the prior written consent of the Board of Administration. The proposed additions, alterations and improvements by the Unit Owners shall be made in compliance with authorities having jurisdiction and with any conditions imposed by the Board of Administration, with respect to design, structural integrity, aesthetic appeal, construction details, lien protection or otherwise. The approval of the Board of Administration to any proposals or plans and specifications or drawings for any work done or proposed shall not be deemed to constitute a waiver of any right to withhold approval as to similar proposals, plans and specifications or drawing subsequently or additionally submitted for approval. No member of the Board of Administration shall be liable to any Unit Owner or other person by reason of mistake in judgment, failure to point out deficiencies in proposals or plans and specifications or drawings or any other act or omission in connection with the approval of proposals or plans and specifications and drawings.

B. A Unit Owner(s) making or causing to be made any such additions, alterations or improvements agrees, and shall be deemed to have agreed, for such Owner(s) and his/her heirs, personal representatives, successors and assigns, as appropriate, to hold the Association and all other Unit Owners harmless from any liability or damage to the Condominium Property and expenses arising therefrom, and shall be solely responsible for the maintenance, repair and insurance from and after the date of installation or construction thereof as may be required by the Board of Administration. Unless expressly permitted in writing by the Board of Administration, the installation of any floor covering, other than padded carpeting or well-padded vinyl tile, is prohibited. In either event, Unit Owners in the Upper Units shall have the duty of causing thereto be placed underneath such covering, so as to be between any such covering and the floor of the Unit, generally accepted and approved material for diminution of noise and sound, so that the floors shall be adequately soundproofed according to general architectural and engineering standards presently observed in the community. If a Unit Owner(s) is planning to install ceramic tile, Unit Owner(s) must obtain written approval before any installation

can be made. Approval must be obtained from the Architectural Review Committee indicating specifics of materials to be used in the entire project.

8. AMENDMENT OF DECLARATION. The Declaration shall be amended by approval of a majority of the total voting interests of all Association Members (not on an individual condominium basis), such Association Members either:

(a) Voting in person or by limited proxy at any annual members meeting or special members meeting, or

(b) Submitting written agreements adopting the amendment(s) without a members meeting.

In addition, approval by a majority of the Board Directors shall be required for amendment of the Declaration.

Whenever it shall appear that there is a defect, error, or omission in any of the Association's governing documents or in order to comply with applicable laws or requirements of government entities, or to correct a scrivener's error, the corrective amendment requires approval by the Board of Directors alone.

All amendments shall be evidenced by a certificate executed as required by the Condominium Act and recorded among the Public Records of Palm Beach County, Florida.

Invalidation of any part of this Declaration, any provision contained in any plat of the Condominium Property or in a conveyance of a Unit in the Condominium by judgment, court order or law shall not affect any of the other provisions hereof which shall remain in full force and effect.

9. THE ASSOCIATION, ITS POWERS AND RESPONSIBILITIES.

A. The operation of the Condominium shall be vested in the Association. The Association has been organized as a Florida corporation not for profit, and the Amended and Restated Articles of Incorporation are recorded contemporaneously with this Amended and Restated Declaration.

B. No Unit Owner, except an Officer or Director of the Association, shall have any authority to act for the Association.

C. All Unit Owners shall automatically be members of the Association, and a Unit Owner's membership shall terminate when he/she no longer owns his/her Unit.

D. Unit Owners shall be entitled to one (1) vote for each Unit owned in accordance with the voting privileges set forth in the Articles and Bylaws. Multiple owners of a Unit shall collectively be entitled to one (1) vote for said Unit in accordance with voting privileges set forth in the Articles and Bylaws. There shall be no cumulative voting.

E. The powers and duties of the Association shall include those set forth in the Articles, Bylaws, the Condominium Act, the Florida General Corporation Act, the Florida

Not For Profit Corporation Act, and this Declaration and shall include, but not be limited to, the following:

(1) The irrevocable right of access to each Unit at reasonable hours as may be necessary for the maintenance, repair or replacement of any Common Elements or of any portion of a Unit to be maintained by the Association pursuant to the terms of this Declaration or as necessary to prevent damage to the Common Elements or to a Unit or Units;

(2) The power to levy and collect Assessments from Unit Owners to pay Common Expenses and to lease, maintain, repair and replace the Common Elements;

(3) The power to levy and collect Special Assessments and other charges and surcharges from Unit Owners;

(4) The keeping of accounting records in accordance with good accounting practices and the Condominium Act which records shall be open to inspection by Unit Owners or their authorized representatives at reasonable times and written summaries of which shall be supplied at least annually to Unit Owners or their authorized representatives;

(5) The power to enter into contracts with others for the maintenance, management, operation, repair and servicing of the Condominium Property and the Easement Property and administration of the Association. The service and maintenance contracts referred to herein may delegate the Association's duty to maintain, preserve, repair and replace the Common Elements, but shall not relieve each Unit Owner from his/her personal responsibility to maintain and preserve the interior surfaces of his/her Unit and to paint, clean, decorate, maintain and repair said Unit. Each Unit Owner(s), by his/her acceptance of the deed to his/her Unit, shall bind himself/herself; his/her heirs, personal representatives, successors and assigns any management contract, to the same extent and effect as if he/she had executed such contract for the purposes herein expressed including, but not limited to, adopting, ratifying, confirming and consenting to the execution of the same by the Association, covenanting and promising to perform each and every one of the covenants, promises and undertakings to be performed by the Unit Owners as required under said contract, acknowledging that all of the terms and conditions thereof, including the manager's fee, are reasonable and agreeing that the persons acting as Directors and Officers of the Association entering into such a contract have not breached any of their duties or obligations to the Association by virtue of the execution of said contract. The management contract, if any, and the acts of the Board of Administration and Officers of the Association in entering into such agreement, are hereby ratified, confirmed, approved and adopted;

(6) The power to adopt reasonable Rules and Regulations: (a) for the maintenance and conservation of the Condominium Property; (b) for the health, comfort, safety and welfare of the Unit Owners, all of whom shall be subject to such Rules and Regulations; (c) regarding the frequency, time, location, notice and manner of inspections of records and the copying of such records and; (d) to prohibit dual usage by a Unit Owner(s) and a tenant(s) of Association Property and Common Elements otherwise readily available for use generally by Unit Owners;

(7) The power to purchase Units in the Condominium and to acquire, hold, lease, mortgage and convey the same and the Easement Property;

(8) The power to obtain and maintain adequate insurance to protect the Association and the Common Elements;

(9) The power to charge a use fee against a Unit Owner for the exclusive use of Common Elements or Association Property;

(10) The power to contract with a cable operator and/or communications provider licensed by the County to provide cable television service and/or communications services on a bulk rate basis to Unit Owners;

(11) The power to acquire title to property or otherwise hold, convey, lease and mortgage Association Property for the use and benefit of the Unit Owners;

(12) The power to acquire, hold, convey, lease or encumber personal property and Association real property shall be exercised by the Board of Directors without the need for Unit Owner approval; and,

(13) The power to purchase any land or recreation lease upon the approval of Unit Owners owning not less than 80% (eighty percent) of the Units represented at any meeting at which a quorum has been attained.

F. Except as provided by statute in case of condemnation or substantial loss to the Units and/or Common Elements, unless at least two-thirds (2/3) of the Mortgagees (based upon one (1) vote for each first mortgage owned), or Owners have given their prior written approval, the Association shall not be entitled to:

(1) By act or omission, seek to abandon or terminate the Condominium;

(2) Change the pro rata interest or obligations of any individual Unit for the purpose of: (a) levying assessments or charges or allocating distributions of hazard insurance proceeds or condemnation awards or; (b) determine the pro rata share of ownership of each Unit in the Common Elements;

(3) Partition or subdivide any Unit;

(4) By act or omission, seek to abandon, partition, subdivide, encumber, sell or transfer the Common Elements. (The granting of easements for public utilities or for MATV and or CATV services or for other purposes consistent with the intended use of the Common Elements by the Owners shall not be deemed a transfer within the meaning of this clause.); and,

(5) Use hazard insurance proceeds for losses to any portion of the Condominium for other than the repair, replacement or reconstruction of such portion.

10. BYLAWS.

The administration of the Association and the operation of the Condominium Property shall be governed by the Amended and Restated Bylaws of the Association which are recorded contemporaneously with this Amended and Restated Declaration. No modification of or amendment to the Bylaws shall be deemed valid unless duly adopted as provided in the Bylaws.

11. MAINTENANCE: LIMITATION UPON IMPROVEMENT.

A. The maintenance, repair and replacement of the Common Elements shall be the responsibility of the Association; provided, however, that the Association shall not be responsible for:

(1) The maintenance, repair and replacement of any air conditioning\compressor or other component that serves a particular Unit, which are Limited Common Elements the responsibility for which shall be borne solely by the Owner(s) of each Unit;

(2) The repair or replacement of any of the Common Elements caused by an individual Unit Owner(s) negligence or intentional misconduct, which shall be charged to such Unit Owner(s); and

(3) The following items which are the Unit Owner's responsibility to maintain, repair and replace. To the extent any of the items below in Sections 11(A)(3)(a) through 11(A)(3)(m) are outside the confines of the Unit, then such items are defined as Limited Common Elements. The Owner's responsibilities include, without limitation:

(a) Maintenance, repair, and replacement of screens, windows, and window glass, sliding glass doors and screen doors, threshold doors and screens. The Board of Directors may require a Unit Owner to replace a leaking or faulty window, and if the Owner refuses to do so, the Association can replace the faulty window and impose a Charge against the Owner for the cost thereof.

(b) The main hinged entrance door to the Unit and its interior surfaces. The Unit Owner shall obtain written approval from the Association for a replacement door.

(c) All other doors within or affording access to the Unit. The Unit Owner shall obtain written approval from the Association for a replacement door.

(d) The electrical, mechanical, and plumbing lines, pipes, fixtures, switches, valves, drains, and outlets (including connections) located partially or entirely within the Unit or serving only the Unit.

(e) The circuit breaker panel and all electrical wiring going into the Unit from the panel.

(f) Appliances, water heaters, smoke alarms, and vent fans, water heaters including pans.

(g) All air conditioning and heating equipment (including the pan, and all pipes leading up to the equipment), thermostats, ducts, and installations serving the Unit exclusively. The Association has the right but not the duty to perform maintenance on air conditioning equipment.

(h) Carpeting and other floor coverings.

(i) Door and window hardware and locks.

- (j) Shower pans.
- (k) Other facilities or fixtures that are located or contained entirely within the Unit and serve only that Unit.
- (l) All interior partition walls.
- (m) Balconies, Patios, and Porches. Where the Unit Owner has the right or exclusive use of a balcony, patio, or porch area, the Unit Owner shall be responsible for the day-to-day cleaning and care of the walls, floor, slab surface, and ceiling bounding said area, if any; and all fixed glass and sliding glass doors in portions or the entranceway to said area, if any; and the wiring, electrical outlet(s), and fixture(s) thereon, if any, and the replacement of light bulbs. The Association is responsible for the maintenance, repair, and replacement of all exterior walls of the building and the concrete slabs including repair of deteriorated or spalled concrete on the exterior walls and concrete slabs, and the cost shall be a Common Expense.

B. Material alterations or additions to Common Elements, Limited Common Elements or to real property which is Association Property require approval by two-thirds (2/3) of the entire Board of Directors. Further, if the cost of material alterations or additions will exceed twenty-five percent (25%) of the Association's budget, excluding reserves, then approval by written agreement of a majority of all Association Members (Unit Owners) shall also be required.

C. No Unit Owner(s) shall do anything within his/her Unit or on the Common Elements which would adversely affect the safety or soundness of the Common Elements or any portion of the Association Property or Condominium Property which is to be maintained by the Association.

D. No fence, wall, gate or other structure, addition or improvement may be erected, installed, maintained or removed on the Condominium Property until the design, construction, specifications and a plan showing the location of the structure or improvement have been approved in writing by the Board of Administration (or an architectural review committee appointed by it) as to quality, design and materials, harmony with existing structures, and as to location with respect to topography and finished grade elevation. Nothing contained in this paragraph shall be construed to lessen the obligation of any Unit Owner(s) to make prompt application for and obtain all necessary governmental permits and other approvals with respect to any such structure.

E. All maintenance, repairs and replacements of, in or to any Unit, whether structural or nonstructural, ordinary or extraordinary, including without limitation, maintenance, repair and replacement of screens, windows, the entrance door and all other doors within or affording access to a Unit, and the electrical, plumbing, heating and air-conditioning equipment, fixtures and outlets, if any, within the Unit or belonging to the Unit Owner(s), shall be performed by the Owner(s) of such Unit at the Unit Owner(s) sole cost and expense, except as otherwise expressly provided to the contrary herein, and shall be in accordance with the original plans and specifications therefore or as otherwise directed by the Board of Administration. Additionally, each Unit Owner(s) shall pay all charges for utility services metered directly to his/her Unit.

F. If any of the Unit Owners fail to maintain the Limited Common Elements as provided for in this Declaration, the Association shall have the power to provide for such maintenance and to charge such Unit Owners for the costs of same. If this Declaration is amended to provide for the Association to maintain certain Limited Common Elements at the expense of only those entitled to use the Limited Common Elements, such costs shall be apportioned equally among those Unit Owners entitled to use the Limited Common Elements, and in such event, the Association may use the Provisions of Article 13 of this Declaration to enforce payment of such costs by those Unit Owners entitled to use the Limited Common Elements.

G. The Board, through the ARC Committee, shall adopt hurricane shutter specifications for the Building, which shall include color, style, and other factors deemed relevant by the Board. All specifications adopted by the Board shall comply with the applicable building code. Notwithstanding any provision to the contrary in this Declaration, if approval is required hereunder, the Board shall not refuse to approve the installation or replacement of hurricane shutters conforming to the specifications adopted by the Board. The installation, replacement, and maintenance of such shutters in accordance with the procedures set forth herein shall not be deemed a material alteration to the Common Elements, and shall be maintained by the individual Unit Owner(s).

H. Unit Owner Alteration of Units, Common Elements and Limited Common Elements Restricted; Approval Required for Alterations, Repair, Construction Renovation or Remodeling Work on Units.

(1) Association Approval Required. The Unit Owner shall obtain written approval in advance and in writing from the Board of Directors for all alterations, repair, construction or remodeling of the Unit:

- (a) Which would require municipal permit(s), or**
- (b) Which would involve cutting into, removing or altering wall(s), floor(s) or ceiling(s) of the Unit, or**
- (c) Which would involve removal, replacement or alteration of plumbing, piping or electrical wiring located inside walls, floors or ceilings; or**
- (d) Which would involve replacement of a bathtub or shower.**

(2) UNIT OWNERS ARE ADVISED TO INVESTIGATE WITH PALM BEACH COUNTY WHAT WORK REQUIRES COUNTY PERMITS. The Unit Owner must obtain all necessary municipal and county approvals and permits.

(3) Repair, construction, decorating, or remodeling work will be done only during the hours authorized by the Board, and any Board adopted rules must be complied with. Unit Owners and others shall utilize any forms and follow any procedures required by the Board of Directors. The Board of Directors may delegate to a Committee or to the Association Manager, the authority to approve or deny (on behalf of the Association) requests for repair, construction, renovation or remodeling work on Units provided all necessary permits are obtained and the work complies with all applicable codes.

(4) Prior to the work beginning for any alteration to any portion of the interior or exterior of the Unit, including, but not limited to, the replacement of a Unit window or sliding glass door, the Unit owner must submit to the Association:

(a) A completed and fully executed Alteration Application on the forms adopted by the Board of Directors;

(b) A copy of the necessary plans for any such work;

(c) Payment of application and permit fees, if any;

(d) Proof of the Contractor's License and a Certificate of Insurance (COI) naming the Association as additional insured.

(5) If an Owner is having substantial construction or renovation work done, the Board may require the Owner to provide a reasonable deposit (as determined by the Board from time to time) for clean-up, including but not limited to clean-up of the hallways, elevators and other common elements, or for damage to the Association's common elements, or Condominium property caused as a result of the work. The deposit amount is not a limitation to the Association's recovery or remedies for recovery for damages or clean-up costs, and will be returned when the Manager verifies no clean-up costs have been incurred by the Association and no damage has been observed to have occurred to the Condominium property or Association Property as a result of concerning or regarding the work.

(6) The Owner shall be required to follow any additional rules and policies adopted by the Board.

(7) The planting of plants, flowers, trees, shrubbery and crops of any type is prohibited anywhere on the Common Elements except as follows. The Board of Directors may approve first floor Unit Owners to plant limited numbers of small ornamental plants around the entranceway. The Board may require removal of such plants at the discretion of the Board.

(8) No fencing of the Common Elements by a Unit Owner shall be permitted.

(9) Connecting Units (owned by the same Owner) abutting each other side to side is not prohibited; provided application and prior written Association approval is required. The owner of such joined Units must still pay assessments for both Units. Connecting Units abutting each other above and below is prohibited.

I. Electric Vehicle Charging Stations; Electric Bikes and Scooters. Unit Owners may, in accordance with Florida Statute 718.113(8) as amended from time to time, install electric vehicle charging stations in their assigned parking spaces subject to the following.

Installation of an electric vehicle charging station requires application to the Association and prior written Association approval. The installation may not cause irreparable damage to the Common Elements or any other property the Association is responsible to maintain. The electricity for the electric vehicle charging station must be separately metered or metered by an embedded meter and payable by the unit owner installing such charging or by his or her successor. The Unit Owner who is installing an electric vehicle charging station is responsible for the costs of installation, operation,

maintenance, and repair, including, but not limited to, hazard and liability insurance. The Association may enforce payment of such costs as an assessment and lien. If the Unit Owner or his or her successor decides there is no longer a need for the electric vehicle charging station, such person is responsible for the cost of removal of such charging station. The Association may enforce payment of such costs as an assessment and lien. The Unit Owner installing, maintaining, or removing the electric vehicle charging station is responsible for complying with all federal, state, or local laws and regulations applicable to such installation, maintenance, or removal.

The Association may require the Unit Owner to:

(a) Comply with bona fide safety requirements, consistent with applicable building codes or recognized safety standards, for the protection of persons and property.

(b) Comply with reasonable architectural standards adopted by the Association that govern the dimensions, placement, or external appearance of the electric vehicle charging station.

(c) Engage the services of a licensed and registered firm familiar with the installation or removal and core requirements of an electric vehicle charging station.

(d) To the extent not prohibited by law, the Association may require the Unit Owner to pay an amount determined by the Board towards any upgrade needed in the Condominium's electrical systems to accommodate electric vehicle charging stations.

(e) Provide a certificate of insurance naming the Association as an additional insured on the owner's insurance policy for any claim related to the installation, maintenance, or use of the electric vehicle charging station within 14 days after receiving the Association's approval to install or notice to provide such a certificate.

(f) Reimburse the Association for the actual cost of any increased insurance premium amount attributable to the electric vehicle charging station.

(g) Sign an agreement prepared by the Association which contains provisions determined appropriate by the Board to protect the Association and Condominium.

Electric Bikes and Scooters: Electric bikes, scooters and other vehicles shall not be plugged into any electric outlet where the electric is paid by the Association. Unit Owners are required to get an electrician to install a meter and get a plug installed in the overhead fixture. Association approval is required.

12. COMMON EXPENSES AND COMMON SURPLUS.

A. Common Expenses shall include the expenses of the operation, maintenance, repair, replacement, or protection of the Common Elements and Association Property, the cost of a master antenna television system or duly franchised cable television service obtained pursuant to a bulk contract, costs of carrying out the powers and duties of the Association and any other expense whether or not included in the foregoing, designated as Common Expenses by the Condominium Act, this Declaration, the Articles or the Bylaws.

B. Except as otherwise specifically provided herein, Common Expenses shall be assessed against Unit Owners in a proportion equal to those proportions of ownership in the Common Elements as provided in this Declaration.

C. Common Surplus, if any, shall be owned by Unit Owners in a proportion equal to those proportions of ownership in the Common Elements as provided in this Declaration.

13. ASSESSMENTS: LIABILITY, LIENS, PRIORITY, INTEREST AND COLLECTIONS.

A. The Association, through its Board of Administration, shall have the power to determine and fix the sums necessary to provide for the Common Expenses, including the expense allocable to services being rendered by a management company with whom the Association may contract. Unless specifically waived by the Association in the manner provided in Chapter 718, Florida Statutes, as amended from time to time, the Assessments shall include monies required for the payment of reserves for capital expenditures and deferred maintenance. The Assessment shall initially be made for one (1) year periods, but shall be payable in advance, in quarterly installments, on the first day of each calendar quarter; however. The Board of Administration shall have the power to levy Special Assessments against Units in their respective percentages.

B. Each Unit Owner(s), regardless of how his or her title has been acquired, including by purchase at a foreclosure sale or by deed in lieu of foreclosure, is liable for all assessments that come due while he or she is the Unit Owner. The Unit Owner and grantee are jointly and severally liable for all unpaid assessments that came due up to the time of transfer of title. If ownership of a Unit is divided between a life estate and a remainder interest, both the owner of the life estate and the owner of the remainder interest shall be jointly and severally liable for all assessments. A first mortgagee or its successor or assignee who acquires title to a unit by foreclosure or by deed in lieu of foreclosure for the unpaid assessments that became due before the first mortgagee's acquisition of title is limited to the lesser of:

(1) The Unit's unpaid common expenses and regular periodic assessments that accrued or came due during the twelve (12) months immediately preceding the acquisition of title and for which payment in full has not been received by the Association; or

(2) One percent (1%) of the original first mortgage debt.

The person acquiring title shall pay the amount owed to the Association within thirty (30) days after transfer of title and failure to so pay shall entitle the Association to record a lien and institute foreclosure thereon. The limitation on the obligation of a first mortgagee shall not apply unless the first mortgagee initially joined the Association as a defendant in the foreclosure action. For the purposes of this subsection, the term "successor or assignee" as used with respect to a first mortgagee includes only a subsequent holder of the first mortgage.

If a third party buys a Unit at the foreclosure sale of a first mortgage, the third party is responsible to the Association for all unpaid assessments, interest, late fees, attorneys' fees and costs.

Association assessments are superior in priority to second mortgages regardless of whether the Association's lien was recorded before or after the second mortgage. A Unit Owner's liability for assessments may not be avoided by waiver of the use or enjoyment of any Common Element or by abandonment of the Unit for which the assessments are made.

The Declaration, Articles of Incorporation and Bylaws shall be deemed automatically amended to conform to Chapter 718, Florida Statutes and Chapter 617, Florida Statutes, as Chapter 718 and 617, are amended from time to time.

C. Assessments and installments thereof not paid when due shall bear interest from the due date until paid at the maximum rate allowed under Florida law. If an assessment is not paid within ten (10) days after the date when due, the Association may charge an administrative late fee in addition to such interest, in an amount not to exceed the greater of \$25.00 (twenty-five dollars) or 5% (five percent) of each installment of the Assessment and Special Assessment, for each delinquent installment. If Chapter 718 is amended to allow a different late fee, the Association may adjust the late fee accordingly. Any payment received by the Association shall be applied first to any interest accrued by the Association, then to any administrative late fee, then to any costs and reasonable attorneys' fees incurred in collection, and then to the delinquent Assessment. The foregoing shall be applicable notwithstanding any restrictive endorsement, designation, or instruction placed on or accompanying a payment. A late fee shall neither be subject to the provisions of Florida's interest and usury laws nor the provisions of the Condominium Act dealing with the levy of fines against a Unit. If a Unit Owner becomes delinquent in payment of assessments, the Association may accelerate unpaid assessments for the remainder of the budget year.

D. The Association shall have a lien upon each Condominium Parcel to secure the personal obligation of each Unit Owner(s) thereof for any unpaid Assessment and interest thereon. Such lien shall also secure reasonable attorneys' fees and costs incurred by the Association incident to the collection of such Assessment or enforcement of such lien. The lien relates back to the recording of the original Declaration of Condominium. The claim of lien shall be recorded among the Public Records of Palm Beach County, Florida, in the manner provided by the Condominium Act.

E. Liens for Assessments may be foreclosed by suit brought in the name of the Association in like manner as a foreclosure of a mortgage on real property. The Association may also bring an action to recover a money judgment for unpaid assessments without waiving any claim of lien. The Association shall be entitled to recover its reasonable attorneys' fees and costs incurred in either a lien foreclosure action or an action to recover a money judgment for unpaid assessments. If a Unit Owner(s) remains in possession of the Unit after a foreclosure judgment has been entered the court, the Association, in its discretion, may require the Unit Owner(s) to pay a reasonable rental for the Unit. If the Unit is rented or leased during the pendency of the foreclosure action, the Association is entitled to the appointment of a receiver to collect the rent. The expenses of the receiver shall be paid by the party which does not prevail in the foreclosure action. The Association may bid in the Condominium Parcel at foreclosure sale and apply as a cash credit against its bid all sums due the Association secured by the lien being enforced, and the Association may acquire and hold, lease, mortgage and convey any Condominium Parcel so acquired.

F. Any Mortgagee or other purchaser acquiring title to a Condominium Parcel as a result of foreclosure or a deed in lieu of foreclosure may not during the period of its ownership of such Condominium Parcel, whether or not such Condominium Parcel is unoccupied, be excused from the payment of some or all of the Common Expenses coming due during the period of such ownership.

G. If any unpaid share of Common Expenses or Assessments is extinguished by foreclosure of a first mortgage or by a deed in lieu of foreclosure thereof as provided in Chapter 718, as amended from time to time, the unpaid share of Common Expenses or Assessments are Common Expenses collectible from all the Unit Owners.

14. TERMINATION OF CONDOMINIUM.

This Condominium may be terminated in accordance with the approval requirements and procedures set forth in Florida Statute 718.117, as amended from time to time.

15. EQUITABLE RELIEF.

In the event of "major damage" to or destruction of all or a substantial part of the Condominium Property and if the Property is not repaired, reconstructed or rebuilt within a reasonable period of time, any Unit Owner shall have the right to petition a court of competent jurisdiction for equitable relief which may, but need not, include termination of the Condominium and partition.

16. LIMITATION OF LIABILITY.

A. The liability of each Unit Owner(s) for Common Expenses shall be limited to the amounts assessed against him/her from time to time in accordance with the Condominium Act, this Declaration, the Articles and the Bylaws.

B. A Unit Owner(s) may be personally liable for any damages caused by the Association in connection with the use of the Common Elements, but only to the extent of his/her pro rata share of that liability in the same percentage as his/her interest in the Common Elements and in no event shall said liability exceed the value of his/her Unit. Each Unit Owner shall be liable for injuries or damages resulting from an accident in his/her own Unit to the same extent and degree that the owner of a house or any other property owner would be liable for such an occurrence.

C. In any legal action in which the Association may be exposed to liability in excess of insurance coverage protecting it and the Unit Owners, the Association shall give notice of the exposure within a reasonable time to all Unit Owners, and they shall have a right to intervene and defend.

17. LIENS.

A. Subsequent to the recording hereof and while the Condominium Property remains subject hereto, no liens of any nature shall be valid against the Condominium Property (as distinguished from individual Units) without the unanimous consent of the Unit Owners.

B. Unless a Unit Owner(s) has expressly requested or consented to work being performed or materials being furnished to his/her Unit, such labor or materials may not be the basis for the filing of a lien against same. No labor performed or materials furnished to the Common Elements shall be the basis for a lien hereon unless authorized by the Association, in which event, the same may be the basis for the filing of a lien against all Condominium Parcels in the proportions for which the Unit Owners thereof are liable for Common Expenses.

C. In the event a lien against two (2) or more Condominium Parcels becomes effective, each owner(s) thereof may release his Condominium Parcel from the lien by paying the proportionate amount attributable to his/her Condominium Parcel. Upon such payment, it shall be the duty of the lienor to release the lien of record from such Condominium Parcel.

18. REMEDIES FOR VIOLATION.

Each Unit Owner(s), his/her family, invitee(s) and/or tenant(s), shall be governed by and conform to the provisions of the Condominium Act, this Declaration, the Articles, the Bylaws and the Rules and Regulations of the Association. Failure to do so shall entitle the Association or any other Unit Owner(s) to recover damages or obtain injunctive relief or both, but such relief shall not be exclusive of other remedies provided by law.

19. EASEMENTS.

A. Owners of Units shall have, as an appurtenance to their Units, a perpetual easement for ingress and egress to and from their Units over and upon stairs, elevators, walks and other Common Elements intended for such purposes.

B. The Condominium Property shall be subject to perpetual easements for encroachments presently existing or which may hereafter be caused by settlement or movement of the Condominium Building or minor inaccuracies in construction, which easements shall continue until such encroachments no longer exist. If the Condominium Property is destroyed and then rebuilt, encroachments due to construction shall be permitted and a valid easement for said encroachments shall exist. If any portion of the Common Elements encroaches upon any Unit, or any Unit encroaches upon the Common Elements, as a result of the construction, reconstruction, repair, shifting, settlement or movement of any portion of the improvements contained in the Condominium Property, a valid easement for the encroachment and for the maintenance of the same shall exist so long as the encroachment exists. The Association shall have an easement over all Condominium Property for the maintenance and repair of any Common Elements, provided such activity does not materially adversely affect the substantial use of any Unit by its Owner(s).

C. The Condominium Property shall be subject to such easements for utilities as may be required to properly and adequately serve the Condominium Property as it exists from time to time. Each of the said easements, whether heretofore or hereafter created, shall constitute covenants running with the Condominium Property and, notwithstanding any other provisions of this Declaration, may not be substantially amended or revoked in such a way as to unreasonably interfere with its proper and intended use and purpose and shall survive the termination of the Condominium.

D. An easement shall exist for pedestrian traffic over, through and across that portion of the Common Elements improved with sidewalks, paths and walks (including grass covered open space) and for vehicular and pedestrian traffic over, through and across such portions of the Common Elements as may from time to time be paved and intended for such purposes. All of such easements shall be without charge and shall be for the use and benefit of all members. The Association hereby grants to delivery, including newspaper delivery, pickup, including waste disposal pickup and fire protection services, police and other authorities of the law, United States postal carriers, representatives of electrical, telephone and other utilities authorized by the Association to service the Condominium, and representatives of cable television, and to such other persons as the Association from time-to-time may designate, the non-exclusive, perpetual right of ingress and egress over, through and across such portions of the Common Elements for the purposes of performing their authorized services and investigation. Such easements shall survive any termination of this Declaration.

E. As an appurtenance to the Condominium Property for the use and benefit of all members of the Association, as well as approved renter(s)/lessee(s) and those guests of such members, as the Association shall from time to time permit pursuant to Rules and Regulations duly adopted by the Association, an easement (the "Easement") over the property described in Exhibit "C" is attached hereto (the "Easement Property"). Use of the Easement Property shall be exclusively for members of the Association, as well as approved renter(s)/lessee(s), and their guests as previously provided. A parking area together with related improvements including lighting and landscaping has been constructed on this Easement Property. Use of any portion of the Easement Property by members of the Association, as well as approved renter(s)/lessee(s) and those guests of such members, is limited to those purposes as are reasonably consistent with the nature of the improvement constructed thereon. For example, paved roadways may be used for pedestrian and vehicular traffic, etc. The Association shall be responsible for the cost and performance of maintaining and operating such improvements (parking area, driveways, lighting, landscaping, etc.) and the cost of owning the underlying land (including taxes) and all such costs of the Common Expenses of the Association assessable against all Units owned by all members of the Association (and not limited to Units in the Condominium). An appurtenance to the Condominium Property is for the use and benefit of all members of the Association, as well as approved renter(s)/lessees, and those guests of such members, renter(s)/lessee(s), as shall from time to time be permitted pursuant to Rules and Regulations duly adopted by any entity having jurisdiction thereover, as well as the right to use unassigned parking spaces and paved roadways, if any on the Adjacent Property (described on attached Exhibit "D"), common with owners of resident units, as well as approved renter(s)/lessee(s), and their guests, on such Adjacent Property, for purposes which are reasonably consistent with the nature of any improvements which may be constructed thereon. The Association by action of the Board of Directors and without a Unit Owner vote, has authority to purchase and take title to Easement Property or Adjacent Property.

F. The Board of Administration on behalf of the Association and all Unit Owners, as their attorney-in-fact for this purpose, shall have the right to grant such additional electric, gas, water distribution or waste water collection or other utility or service or other easements, or relocate any existing easements or drainage facilities in any portion of the Condominium Property, and to grant access easements or relocate any access easements in any portion of the Condominium or Association Property, as the Association shall deem necessary or desirable for the proper operation and maintenance of the Condominium

Building, or any portion thereof or the Platina Project or any portion thereof, or for the general health or welfare of the Unit Owners, or for the purpose of carrying out any provisions of this Declaration or otherwise, provided that such easements or the relocation of existing easements will not prevent or unreasonably interfere with the reasonable use of the Units for dwelling purposes. The Board of Administration has the authority without the joinder of any Unit Owners, to grant, modify or move any easement, subject to the provisions of the easement, if the easement constitutes part of or crosses the Common Elements or Association Property or serves the Condominium. The foregoing does not authorize the Board of Administration to modify, move or vacate any easement created in whole or in part for the use or benefit of anyone other than the Unit Owners, or crossing the property of one other than the Unit Owners without the consent or approval or approvals of those other persons having the use or benefit of the easement, as required by law or by having the instrument creating the easement, but does authorize the Board of Administration to act for the Unit Owners with regard to any such easement.

20. SALE, LEASING APPROVAL OF NEW RESIDENTS AND OCCUPANCY. The purpose and object of this section is to maintain a quiet, tranquil, non-transient, and single-family oriented atmosphere with the residents living in compatible coexistence with other financially responsible persons who are of like mind and acceptable both in character and comportment. This objective is considered to be both important and justified because of the necessity of sharing facilities and because of the large personal financial investment of each Owner. Therefore, the conveyance and disposal of Units and leasing of the Units by owners shall be subject to the following provisions:

A. Association Approval Required. No Owner may sell, lease, give, or otherwise transfer ownership of a Unit or any interest therein in any manner without the prior written transfer approval of the Association. The transfer approval shall be a written instrument in recordable form. The approval must be recorded simultaneously in the Palm Beach County, Florida Public Records with the deed or other instrument transferring title to the Unit. It is not the Association's responsibility to record the Association's written approval.

A renewal or extension of a lease to the same extent shall require Association approval, although the Association shall not require the application fee to be paid again for a renewal or extension so long as there are no changes in the tenants or occupants.

B. Devise or Inheritance. If any Unit Owner shall acquire title by devise or inheritance or in any other manner not heretofore considered, the continuance of ownership shall be subject to the approval of the Association. Such Owner shall give the Association notice of the title acquisition together with such additional information concerning the Unit Owner as the Association may reasonably require, together with a copy of the instrument evidencing the Owner's title, and if such notice is not given, the Association, at any time after receiving knowledge of such transfer, may approve or disapprove the transfer of ownership.

C. Multiple Owners. De facto time sharing of Units is not permitted and approval will not be given for the sale of a Unit or an interest in a Unit to multiple persons (e.g., siblings or business associates), who may intend that they and their families would split occupancy of the Unit into different time periods during the year.

D. Approval Procedure. The approval of the Association shall be obtained as follows:

(1) **Application.** The Owner shall properly submit an application to the Association utilizing the application form created or authorized by the Board. The Association may require such information as the name and address of the intended tenant(s), purchaser(s), transferee(s), and all occupants (hereinafter referred to as "applicant(s)") and such other information concerning the applicant(s) that it deems reasonably necessary and may impose an application or transfer fee of \$150 or such other or greater amount determined by the Board up to the maximum amount allowed by law and may require an interview with the applicants. Under no circumstances shall any applicant(s) be permitted to move into a Unit prior to obtaining written approval of the lease from the Board.

(2) **Association's Options.** The Association shall, within 30 days after receipt of all the application and information required above and the interview, if required, either: (1) approve the proposed lease, sale or transfer, or (2) disapprove the proposed lease, sale or transfer for cause. The Board may make the decision by polling its Board members, and there is no obligation to have a Board meeting on the issue.

The Association shall act reasonably and may disapprove a lease, sale, conveyance or residency only for good cause. The Board shall consider the following factors as constituting good cause for such disapproval:

(a) The applicant or any intended occupant of the Unit has been convicted of, pled guilty or pled no contest to a felony or has been charged with a felony and the person was not acquitted of the felony or the felony charges were not dropped;

(b) The applicant or any intended occupant of the Unit is a registered sex offender in any state;

(c) The applicant does not appear to have adequate financial resources available to pay the rent and carrying costs for the Unit;

(d) The tenant or purchaser has a credit score of less than 650. The Association shall be entitled to use the credit score obtained by the Association as determinative;

(e) The occupancy and/or use of the Unit by the applicant or any intended occupant of the Unit would violate the Association's governing documents, rules and regulations or the governing documents or rules and regulations of the Master Association or law;

(f) The application for approval on its face indicates that the applicant or any intended occupant of the Unit intends to conduct himself or herself in a manner inconsistent with the Declaration or rules and regulations of the Association or Master Association. By way of example, but not limitation, an Owner allowing a tenant to take possession of the premises prior to Association approval, as provided for the herein shall constitute a presumption that the applicant's conduct is inconsistent with applicable restrictions;

(g) The applicant or any intended occupant of the Unit has a history of disruptive behavior or disregard for the rights and property of others as evidenced by his or her

conduct in other associations, or by his or her conduct in the Condominium as a tenant, Owner or occupant of a Unit;

(h) The applicant failed to provide the information, fees or appearance required to process the application in a timely manner or included materially inaccurate or false information in the application;

(i) The Owner requesting the transfer or lease has Association fines assessed against him or her which have not been paid; or

(j) All assessments and other charges against the Unit have not been paid in full.

(3) **Notice of Disapproval.** If the Association disapproves the proposed transaction, notice of disapproval shall promptly be sent in writing to the owner or interest holder, and the transaction shall not be made. The Association need not approve any lease, sale or transfer until such time as all unpaid assessments and all court costs and attorneys' fees (if any) incurred by the Association and due and owing for the Unit have been paid.

(4) **Judicial Sales and Property Tax Deed Sales.** Judicial sales and property tax deed sales are exempt from the provisions section requiring Association approval for transfer.

(5) **Unapproved Transactions.** Any transaction that is not approved pursuant to the terms of this Declaration shall be void unless subsequently approved by the Association. If the Association disapproves the lease, sale or conveyance, the lease, sale or conveyance shall be null and void and confer no right, title or interest in the intended tenant(s), purchaser(s) or transferee(s).

(6) **Guest Occupying Unit Where Owner Not Present.** A guest residing in a Unit for longer than thirty (30) days where the Owner is not present shall be deemed to be leasing the Unit subject to all the restrictions on leasing including the application and approval requirements.

Exception: Occupancy by Parents or Children of Owner. A Unit may for estate planning or tax purposes be occupied by the parent(s) or children of the Owner(s) and in such a situation, the parent(s) or children shall not constitute tenant(s). However, in these situations where the Unit is occupied by the parent(s) or children of the Owner(s), the occupancy shall be subject to the tenant screening and approval process, which includes the right of the Board of Directors to disapprove the occupancy.

(7) **Approval of All New Residents.** Association approval is required for every new resident occupying a Unit for longer than thirty (30) days. The new resident shall follow the same application procedure as for lessees or purchasers. This requirement shall apply to all new residents even if the resident is occupying the Unit with the Owner.

If the Association observes that a Unit is occupied by people other than the Owner, based on change in vehicles, or other observations, the Owner and the guests or occupants shall promptly comply with Association requests for identification and information about the occupancy and family relationship of the occupants.

E. Tenant Shall Comply With the Rules. A tenant leasing a Unit is deemed to have agreed to observe and comply with all statutes, ordinances, and the governing documents and rules and regulations of the Association. When Owner(s) submit an application to lease the Unit, the Association may require the prospective tenant(s) and the Owner(s) to sign an agreement specifically agreeing to comply with all statutes, and the governing documents and rules and regulations of the Association.

F. Copy of Deed to Association. The purchaser(s) or other persons receiving title to a Unit shall within ten days after the conveyance, provide the Association's Board with a copy of the deed or other instrument conveying title to the Unit.

G. Form of Lease. All leases shall be in writing. Owners shall provide the prospective tenant, purchaser, or transferee with a complete legible copy of the Declaration, the Association's Articles of Incorporation, Bylaws, and Rules and Regulations, and the Master Association's governing documents and rules and regulations, each as amended, and shall certify in writing that legible photocopies of these documents have been provided to the prospective tenant, purchaser, or transferee.

H. Owner and Tenant Liable to Association for Damage Caused by Tenant. The Owner and Owner's tenants shall be jointly and severally liable to the Association for all damage to persons and property caused by the Owner's tenant or any family members, guests, or invitees of the tenant. If there is any damage to the Common Elements or any other property maintained by the Association, resulting from acts or omissions of the tenants, or any family members, guests, or invitees of the tenants (as determined in the sole discretion of the Association), the Association may impose the cost of repairing such damage as an assessment against the Owner's Unit.

I. Security Deposit; Responsibility for Damage Caused by Tenant. The Association may require an Owner seeking to lease the Owner's Unit to place a security deposit with the Association, in the amount of up to one month's rent, which may be used by the Association to repair any damage to the Common Elements or any other property maintained by the Association, resulting from acts or omissions of the tenants, or any family members, guests, or invitees of the tenants (as determined in the sole discretion of the Association).

J. Default in Payment of Assessments While Unit Leased. If the Owner defaults in payment of Association assessments while the Owner's Unit is leased, then the Association may require the tenant to pay the rent to the Association sufficient to satisfy the assessment obligation, including any interest, late fees and attorneys' fees and costs incurred by the Association. The Owner is deemed to have assigned the rent to the Association if the Owner defaults in payment of assessments. The tenant shall pay the rent to the Association upon written demand by the Association notifying the tenant that the Unit is delinquent in payment of assessments. This remedy is in addition to all other remedies of the Association.

K. Lease terms; Subleasing. Units shall not be leased more than once per twelve (12) month period measured from the commencement of the lease. The minimum permitted lease term is six (6) months. There shall be no subleasing. Only the entire Unit may be leased. No rooms or portions of a Unit may be rented. Units shall not be used for transient, hotel or motel purposes. The Unit Owner shall not lease, rent out, host for a fee

or otherwise allow use a Unit for a fee or portions of a Unit for a fee (whether or not the Owner is in occupancy) through Airbnb, HomeAway, VRBO or any other short term rental or vacation rental arrangement unless there is compliance with all the restrictions on leasing in this Declaration including Association approval for the lease and occupants and minimum term requirements.

L. Limitation on Leasing During First Year of Ownership. No Owner may lease a Unit during the first one (1) year period of ownership measured from the date the Owner received title to the Unit. After the first one (1) year period of ownership, an Owner may lease the Owner's Unit subject to the tenant approval and screening process and the other requirements and limitations of the Declaration and Rules and Regulations.

If an Owner sells or otherwise conveys title to the Unit subject to an existing lease in place, the existing tenant may remain in occupancy to conclude the existing lease term provided the tenant complies with the governing documents and rules and the Unit is not otherwise in violation of the governing documents or rules; however the Owner shall be prohibited from leasing for a one (1) year period measured from the end of the lease or the date the tenant vacates, whichever is later.

If an Owner passes away, and title to a Unit passes from the deceased Owner to another person by inheritance, devise, trust or operation of law, such person is not subject to this restriction on leasing during the first one (1) year period of ownership. If the Association acquires title to a Unit, the Association is not subject to this restriction on leasing during the first one (1) year period of ownership.

M. Regulations. The Board of Directors may supplement these restrictions by reasonable regulations.

N. Remedies if Tenant Violates Restrictions. The Association shall otherwise have the authority to bring an action or eviction action because of the tenants' violation of the governing documents and/or rules and regulations of the Association. The Association may use the summary procedures of Chapter 51, Florida Statutes in any eviction action. The Association may recover its attorneys' fees and costs against the Owner(s) and the tenants jointly and severally regardless of whether or not litigation is commenced, which attorneys' fees and costs shall also constitute and may be collected by the Association as an assessment against the Owner and Owner's Unit.

O. Exceptions to Requirement of Association Approval. The foregoing requirements for Association approval of sales or conveyances shall not apply to:

(1) A transfer to or purchase by a bank, life insurance company or savings and loan association that acquires its title as a result of owning a mortgage upon the Lot concerned, whether the title is acquired by deed from the mortgagor, its successors or assigns, or through foreclosure proceedings; or

(2) A transfer to a purchaser who acquires the title to a Unit at a duly advertised public sale with open bidding that is provided by law, such as, but not limited to, execution sale, foreclosure sale, judicial sale or tax sale.

However, application and written Association approval is required for all occupants occupying the Unit.

P. Single Family Occupancy. Occupancy of a Unit is limited to single family – no more than one family can occupy a Unit. A “family” is defined as:

(1) One person or a group of two or more persons, each of whom is related to each of the others by blood, marriage, adoption who reside together as a single household, or

(2) One unmarried couple and the adult children of either or both of them who reside together as a single household.

Occupancy of a Unit by two or more couples (married or unmarried) is prohibited.

In addition, an Owner or Association approved tenant is permitted to have live-in housekeepers, nannies, or care givers who occupy the Unit with the Owner(s) or Association approved tenant(s).

A Unit shall be occupied by no more than two (2) persons per bedroom, with the number of bedrooms determined as the Unit was originally designed.

Q. Ownership by an Entity. There is concern about problems with an entity (corporation, partnership, limited liability company, trust, etc.) purchasing a Unit, installing actual or de facto tenants as occupants but representing to the Association that the occupants are part of the Owner by virtue of being trust beneficiaries, members of an LLC owner, stockholders or have other ownership rights. This may occur when a Unit is purchased at a foreclosure sale. The entity owner by such method could seek to avoid restrictions on leasing. Further, the entity owner may also fail to pay Association assessments, forcing the other Association to absorb the unpaid debt, often for extended period until a first mortgage holder or Master Association forecloses. The following provisions are intended to avoid improper practice.

If a Unit is owned by an entity (corporation, partnership, limited liability company, trust, etc.), and the entity owner represents to the Association that the occupants are part of the Owner, the Association may require that the occupants, in order to occupy the Unit, own a majority (over 50 percent) of the stock and other ownership interests of the entity owner. The Association may require that the entity owner provide proof, acceptable and satisfactory to the Association, demonstrating such majority ownership interest by the occupants. This may include but is not limited to articles of incorporation, bylaws, limited liability company governing documents, stock certificates, partnership agreements, trust agreements and other evidence of ownership. If the entity is a business trust, the Association may require the owner to show the occupants are the primary and majority owners of the trust. If the entity owner has not provided proof, satisfactory to the Association that the occupants are majority owners of the entity, the occupants shall constitute tenants and subject to all limitations on tenants and leasing. If there is a dispute as to whether the occupants are majority owners of the entity, the Board’s determination shall be binding.

R. Prohibition on Using Unit for Congregate Living Facility. Use of a Unit as a Congregate Living Facility, as defined below, is prohibited. The term “Congregate Living Facility” is defined as assisted living facilities; extended congregate care facilities, transitional living facilities, community residential homes, community transitional

residences; rehabilitative home care services, boarding home, or home for the aged or any other residential structure, whether or not operated for profit, which undertakes for a period exceeding 24 hours: care, housing, food service, and one or more personal services for persons not related to the owner or administrator by blood or marriage. In addition, this term shall include other residential uses such as dormitories, group homes with a central dining facility, and similar bed-based uses.”

21. ENFORCEMENT OF MAINTENANCE.

In the event a Unit Owner(s) or any guest(s), tenant(s) or family member(s) of a Unit Owner(s) causes any damage to the Common Elements, Limited Common Elements, or Easement Property (or any improvements on any of them), the Association shall have the right to charge the Unit Owner and the Unit for the sums necessary to repair such damage.

22. INSURANCE.

A. Purchase of Insurance. The Association shall obtain property insurance on the condominium property as required by the condominium insurance statute, Florida Statute 718.111(11), as that statute is amended from time to time. The premiums for such coverage and other expenses in connection with said insurance shall be assessed against the Unit Owners as part of the Common Expenses. The named insured shall be the Association, individually and as agent for the Unit Owners, without naming them, and as agent for their Mortgagees.

(1) Provision shall be made for the issuance of Mortgagee endorsements and memoranda of insurance to Mortgagees. Such policies shall provide that payments for losses thereunder by the insurer shall be made to the Association.

(2) For purposes of this and the following Article, all buildings located on the Condominium Property, as described in Exhibits "A" and "B" attached hereto, shall collectively be deemed one (1) building and shall include any additional buildings as a part thereof which may hereafter become a part of this Condominium.

B. Coverage. The following coverage shall be required:

(1) **Casualty.** All buildings and improvements upon the property described in Exhibit "A" attached hereto shall be insured in an amount equal to the maximum insurable replacement value, as required by the condominium insurance statute, Florida Statute 718.111(11), as that statute is amended from time to time.

(2) **Public liability** in such amounts and with such coverage as shall be required by the Board of Administration.

(3) **Workers' compensation** insurance meeting all the requirements of the laws of Florida if determined necessary.

(4) **Directors and officers liability** insurance, if available.

(5) **Such other insurance** as the Board of Administration shall determine from time to time to be desirable including, without limitation, insurance for the benefit of Association employees, flood insurance for Common Elements, Association Property and

the Units, and such insurance as may be required by any agency of the United States government which holds a first mortgage encumbering a Unit or insures the holder thereof the payment of the same.

C. Premiums. Premiums upon insurance policies purchased by the Association shall be assessed by the Association against the Unit Owners as part of the Common Expenses.

D. Share of Proceeds. All insurance policies purchased by the Association shall be for the benefit of the Association, the Unit Owners and their Mortgagees, as their interest may appear.

(1) **Common Elements.** Proceeds on account of damage to Common Elements shall be administered in accordance with the condominium insurance statute, Florida Statute 718.111(11), as that statute is amended from time to time.

(2) **Units.** Proceeds on account of damage to Units shall be administered in accordance with the condominium insurance statute, Florida Statute 718.111(11), as that statute is amended from time to time.

E. Distribution of Proceeds.

(1) **Reconstruction or repair.** If the damage for which the proceeds are paid is to be repaired or reconstructed, the proceeds shall be administered in accordance with the condominium insurance statute, Florida Statute 718.111(11), as that statute is amended from time to time.

(2) **Failure to reconstruct or repair.** If it is determined in the manner elsewhere provided that the damage for which the proceeds are paid shall not be reconstructed or repaired, the remaining proceeds shall be distributed to the beneficial Owners thereof, remittance to Unit Owners and their Mortgagee being payable jointly to them. This is a covenant for the benefit of any Mortgagee of any Unit and may be enforced by such Mortgagee. However, the proceeds shall be administered in accordance with the condominium insurance statute, Florida Statute 718.111(11), as that statute is amended from time to time.

F. Association as Agent. The Association is hereby irrevocably appointed agent for each Unit Owner(s), for each holder of a mortgage or other lien upon a Unit and for each owner of any other interest in the Condominium Property with power to adjust all claims arising under insurance policies purchased by the Association and to execute and deliver releases upon the payment of claims.

G. Unit Owner's Obligation. Each Unit Owner(s) shall have the obligation to purchase and maintain insurance on the Owner's Unit in the form set forth in the condominium insurance statute, Florida Statute 718.111(11), as that statute is amended from time to time. The Unit Owner shall be obligated to provide the Association with written proof of such insurance upon request.

23. RECONSTRUCTION OR REPAIR AFTER CASUALTY.

A. Determination to Reconstruct or Repair. If any part of the Condominium Property is damaged by casualty, whether it shall be reconstructed or repaired shall be determined in the following manner:

(1) **Condominium Property Insured by Association.** If the damaged improvement is part of the condominium property insured by the Association, the damaged property shall, consistent with the condominium insurance statute, Florida Statute 718.111(11), as that statute is amended from time to time, be reconstructed or repaired unless it is determined in the manner elsewhere provided that the Condominium shall be terminated.

B. Plans and Specifications. Any reconstruction or repair must be substantially in accordance with the plans and specifications for the original Condominium Property; or, if not, then in accordance with plans and specifications approved by the Board of Administration.

C. Estimate of Costs. Immediately after a determination is made to rebuild or repair damage to property for which the Association has the responsibility for reconstruction and repair, the Association shall obtain reliable and detailed estimates of the cost to rebuild or repair.

D. Assessments. If the proceeds of insurance are not sufficient to defray the estimated costs of reconstruction and repair by the Association, or if at any time during reconstruction and/or repair, or upon completion of reconstruction or repair, the funds for the payment of the costs thereof are insufficient, the Association may impose regular or special assessments consistent with the condominium insurance statute, Florida Statute 718.111(11), as that statute is amended from time to time.

E. Construction Funds. The funds for payment of costs of reconstruction and repair after casualty, which shall consist of insurance proceeds held by the Association and funds collected by the Association from Assessments against Unit Owners, shall be disbursed by the Association for the reconstruction and repair of the condominium property in a manner consistent with the condominium insurance statute, Florida Statute 718.111(11), as that statute is amended from time to time.

24. EMINENT DOMAIN OR CONDEMNATION PROCEEDING.

If eminent domain or condemnation proceedings are successfully litigated against all or any part of the Condominium Property, the entire eminent domain or condemnation award is to be secured to the Association in accordance with the ratio of ownership herein provided as it pertains to the Common Elements, and shall be disbursed to Unit Owners and their Mortgagees as their interests appear of record. The Association shall give to each Mortgagee requesting same in writing, prompt written notice of any such eminent domain or condemnation proceedings.

25. GENERAL PROVISIONS.

A. USE RESTRICTIONS. The use of the property of the Condominium shall be in accordance with the following provisions:

1. **Lawful Use.** All valid laws, zoning ordinances, and regulations of all governmental bodies having jurisdiction shall be observed. The responsibility of meeting the requirements of governmental bodies that require maintenance, modification, or repair on Condominium property shall be the same as the responsibility for the repair and maintenance of the property as expressed earlier in this Amended and Restated Declaration.

2. **Single Family Residence.** Units shall be used only as a single family residence and not for business or commercial purposes. However, these use restrictions shall not be construed in such a manner as to prohibit a Unit Owner from maintaining a personal professional library, keeping personal business or professional records or accounts, or handling personal, business, or professional telephone calls or correspondence in and from Owner's Unit. Such uses are expressly declared customarily incident to the principal residential use.

3. **Access to Units.** The Association has an irrevocable right of access to the Units during reasonable hours when necessary for the purpose of maintenance, repair, and replacement of the Common Elements or of any portion of a Unit to be maintained by the Association pursuant to this Amended and Restated Declaration or for making emergency repairs that are necessary to prevent damage to the Common Elements or to another Unit or Units or to investigate potentially dangerous conditions or other matters which might affect the health, safety and welfare of the residents. The Association has the right but not the duty to inspect, with reasonable notice, the condition of a Unit toilet, water heater, washing machine water supply and drain lines, and other plumbing fixtures or pipes which a Unit Owner is responsible to maintain. The Owner of a Unit has a right of access to any adjoining Unit as and if it is reasonably necessary (with accompaniment of a Board representative) in order to maintain, repair, or replace parts of the Owner's Unit. The right or access to a Unit shall be exercised after reasonable notice to the Unit Owners, unless such notice is not possible or practical under the circumstances, and with due respect for the occupants' rights to privacy and freedom from unreasonable annoyance, with reasonable precautions to protect the personal property within the Unit. The Association requires and shall retain an entry key to all Units. No Unit Owner shall install or alter any lock that prevents access while the Unit is unoccupied without providing the Association with a key.

4. **Vehicles and Parking.** The only vehicles that are permitted at the Condominium are the following vehicles set forth in the below paragraphs (a) through (e):

(a) Passenger automobiles;

(b) Sport utility vehicles where the rear area is an enclosed air conditioned passenger area, with tires no larger than standard original equipment for the vehicle and no longer than can fit within the confines of the parking space;

(c) Vans with no visible external signage or commercial paint scheme and no exterior racks, ladders or equipment, which are not commercial vehicles as defined below, which are used only for carrying passengers, and are not longer than can fit within the confines of the parking space;

(d) Motorcycles, with original equipment exhaust equipment;
(e) Pickup trucks (and vehicles with open or convertible beds between the front and rear bumpers such as open-bed Sport Utility Vehicles) which satisfy all the following requirements may be parked at the Condominium:

- (1) Used as personal passenger vehicles;
- (2) Are not commercial vehicles as defined below;
- (3) Have the bed covered by a commercially manufactured cover designed to fit the particular vehicle;
- (4) Have no ladders, racks or external tool boxes;
- (5) Cannot have dual wheels;
- (6) Cannot be longer than parking space; and
- (7) Complies with all other Association requirements regarding vehicles.

(f) Commercial vehicles are prohibited which shall include, but not be limited to vehicles with any of the following: commercial lettering, signs, ladders, racks or equipment, etc.

(g) These restrictions on trucks, vans and commercial vehicles shall not apply to temporary parking of trucks, vans and commercial vehicles for pick-up, delivery and other commercial services provided to a resident or the Association.

(h) Unsightly vehicles are prohibited. All vehicles must be well maintained in a clean, neatly painted condition. The Association may have prohibited vehicles or improperly parked vehicles towed at the expense of the vehicle owner.

(i) No repair of vehicles or vehicle maintenance shall be made on the Condominium Property, Easement Property or Adjacent Property except for car washing in a Board designated area. All vehicles must be currently licensed, insured, and in operating condition. No vehicle which cannot operate on its own power shall remain on the Condominium Property for more than twenty-four (24) hours. No repair of vehicles shall be made on the Condominium Property. Unsightly vehicles are prohibited. The Association may have prohibited vehicles or improperly parked vehicles towed at the expense of the vehicle owner.

(j) Parking for Unit Owners shall be located on the Easement Property. The Association shall have the right to assign and modify the exclusive parking assignments; provided, however, at least one (1) parking space is assigned for the exclusive use of each Unit at all times. Only one vehicle may be parked in each assigned or guest parking space.

(k) Vehicles shall be parked only in the parking space assigned to that Owner's Unit or in a guest parking space. Nothing in this section shall preclude service and delivery vehicles from using the roads, right-of-way, and guest parking spaces for servicing units or the building with the permission of the Association via the Association Manager.

(l) If the Board determines that the number of available parking spaces becomes limited, the Board of Directors, by adoption of a Rule, may limit the number of vehicles allowed per Unit.

(m) Overnight guests of a Unit Owner or an Association approved tenant may park a maximum of one (1) vehicle for the limited duration of their stay. With regard to temporary non-overnight guests and visitors coming for social visits, the Owner or Association approved tenant is limited to five (5) guest/visitor vehicles total; and/or if more guest spaces are required for a special event, the Owner must request and obtain permission from the Board.

(n) Owners are responsible for their parking space cleanliness. Oil drippings or other car fluids shall immediately be removed by the Owner and the source of the leak repaired and corrected. Any damage to a parking space shall be paid by and charged against the Unit associated with the vehicle.

5. Nuisances Prohibited. No person shall engage in any practice, exhibit any behavior, nor permit any condition to exist that will constitute a nuisance or unreasonable source of annoyance or disturbance to any occupant of the Condominium.

6. Antennas. No exterior radio, television, or data reception antennas satellite dishes or any exterior wiring for any purpose may be installed without the written consent of a majority of the Board. The Association may erect antennas by approval of a majority of the entire Board.

7. Obstruction of Common Elements. In order to enhance the beauty of the Units and to provide safe Units, the sidewalk, entrances, passages, elevators, stairways and all of the Common Elements must not be obstructed or encumbered or used for any purpose other than ingress and egress to and from the premises; nor shall any carts, carriages, chairs, tables or any other similar objects be stored therein. Bicycles may be stored only in designated areas.

8. Storage of Personal Property; Use of Balconies; Windows. The personal property of all Unit Owners shall be stored either in their enclosed Units or in assigned storage areas. Personal property shall not be stored on the Common Elements. Unit Owners shall not place potted plants, statues and other items on steps, as such items can create impede exit from the building in an emergency.

The only personal property kept on a balcony, terrace or patio shall be minimal well maintained patio furniture and minimal patio decorations. No garbage cans, supplies or other articles shall be placed on the balconies or patios nor shall any linens, cloths, clothing, curtains, rugs, mops or laundry of any kind, or other articles, be shaken or hung from any of the windows, doors or balconies or exposed on any part of the Common Elements.

So as to maintain the cleanliness of the grounds, no Unit Owner shall allow anything whatsoever to fall from the window, balcony or doors of the Units nor shall any Unit Owner sweep or throw any dirt or other substance upon the grounds. Unit Owners shall not use a hose on a balcony or patio or otherwise allow water (other than natural rainwater) to drip down on the balcony or patio.

Unit Owners; tenants; contractors and workers of Owners; and guests and visitors shall not throw cigarette butts or cigar butts from a balcony, window, catwalk or other part of the building.

9. **Signs and Flags.** No sign, advertisement, notice or other lettering shall be exhibited, displayed, inscribed, painted or affixed in, on or upon any part of the Condominium Property by any Unit Owner or occupant.

Unit Owners are prohibited from displaying flags except for those flags which Florida Statute 718.113, as amended from time to time, allows Unit Owners to display. This includes the official United States flag and certain other flags.

The Board may allow Unit Owners to display minimal seasonal decorations, so long as such decorations are temporary.

The Board may allow small signs recommended by the fire department for safety purposes, such as an indication that the occupant uses oxygen or that there is a pet in the Unit.

10. **Pets.** The Owners of a Unit are limited to keeping in the Unit -- one (1) common domestic dog or one (1) common domestic cat. It is understood and agreed the keeping of pets on the premises is a privilege, but not a right, and may be revoked by the Board of Directors upon 30 days written notice.

No pets, dogs or cats shall be allowed to occupy the Unit prior to obtaining approval in writing from the Board of Directors. Owners are required to properly register all pets kept in a Unit including existing pets, with the Association, by the time limits established by the Board. The registration shall require Owners to provide the Association with relevant, descriptive information regarding all pets residing in the Units by completing a registration form created by the Association, and submitting other information required by the Association including a photograph and a veterinarian certificate of health and inoculations.

A tenant, guest or visitor bringing and keeping a pet is subject to Association approval which may include a requirement that the pet is only temporarily kept at the Condominium.

All dogs and cats shall be under leash when walked or exercised on the Condominium Property outside the Unit. No pet shall be permitted in the recreational areas. A pet shall not be left unattended on the screened patio or balcony unless the Owner or a responsible adult is at home. A pet shall not be left in a Unit for a period of time exceeding ten (10) hours, such as a weekend, without attendance by a responsible adult.

Unit Owner(s) and/or the individuals walking a dog or cat shall: (1) immediately clean up after the animal and properly dispose of the animal's fecal matter, wherever it occurs, in a plastic bag which is then placed in the Unit Owner's trash receptacle or in the dumpsters, and (2) at all times carry a plastic bag for proper disposal of the animal's fecal matter.

A Unit Owner shall not allow a pet to create a nuisance or become a nuisance as may be determined by the Board of Directors of the Association in its sole discretion. The term nuisance in this paragraph shall include but not be limited to aggressive behavior and disturbances to other residents by barking, scratching, screeching, howling and other sounds, or allowing the pet to defecate or urinate in areas not designated for such purpose by the Board. Further, a Unit Owner with a pet shall properly maintain the pet's living

conditions in the Unit, to prevent an unsanitary condition from developing. A Unit Owner shall not allow fecal matter to accumulate in the Unit. A Unit Owner shall not allow an offensive odor to develop in the Unit in connection with keeping an animal.

If a pet becomes a nuisance as may be determined by the Board of Directors of the Association in its sole discretion, or if the Unit Owner repeatedly fails to abide by these restrictions regarding pets, then the Unit Owner shall permanently remove the pet from the Unit and the condominium. This remedy is in addition to all other remedies available to the Association.

If a pet defecates or urinates on interior Common elements or otherwise displays aggressive or other behavior which is disturbing to residents, the Association, in addition to other remedies, may require the pet to be hand carried or placed in a pet carrier while on the interior Common Elements. The Association shall, prior to making such requirement, give the Owner or tenant a prior written warning and an opportunity to stop further incidents.

The Owner of the Unit housing a pet shall be strictly liable for all damages to the Common Elements, to another Unit, and for all injury to any other person resulting from the pet. The Owner of the Unit housing a pet shall hold the Association harmless and indemnify the Association against any and all claims and demands, costs and expenses (including all attorneys' fees and costs at all levels trial and appellate) which may be sustained by or asserted against the Association and/or the members of its Board of Directors by reasons of acts of said pets committed in or about the Condominium Property.

If an assistance animal (ESA, service animal, etc.) is requested, written Association approval is required, and the Unit Owner or tenant shall follow the Association's procedures for application and approval. These restrictions and any other rules and regulations on keeping of pets apply to assistance animals except as specifically limited by law. In all events, the Owner or handler of an assistance animal must at all times pick up after the assistance animal, as stated above for pets.

Pets and assistance animals may be further restricted and regulated by rules and regulations adopted by the Board of Directors.

11. Carrying of Firearms on Common Elements or Association Property. The Association is a private party not a governmental agency. Further, the Common Elements and Association Property of the Lucente Village Condominium is private property. The Association adopts the following restrictions regarding the carrying of firearms on the Common Elements or Association Property.

A. The "open carry" of firearms on the Common Elements or Association Property is prohibited. The term "open carry" is the practice of carrying a firearm in a way that is fully or partially visible to others.

B. The "concealed carry" of firearms is prohibited on the Common Elements or Association Property. The term "concealed carry" means carrying the firearm such that it is hidden from view.

C. Firearms may be transported over the Common Elements or Association Property when being brought to the destination, such as hunting, shooting range, or other

destination provided the gun owner complies with the following. The firearms shall be unloaded, the firearm must be fully enclosed in a soft or hard gun case completely shut and latched or zippered up. A holster does not constitute a gun case.

D. If any portion of this Article 11 should be invalidated by a Court or administrative body, the remaining portions of this Article 11 shall remain in full force and effect.

12. Rules and Regulations. The Board of Directors may adopt Rules and Regulations in addition to the use restrictions contained in this Amended and Restated Declaration.

A. If any provision of this Declaration, the Articles, the Bylaws or the Condominium Act, or any section, sentence, clause, phrase or word, or the application thereof, in any circumstances is held invalid, the validity of the remainder of this Declaration, the Articles, the Bylaws, or the Condominium Act, and the application of any such-invalid provision, section, sentence, clause, phrase or word in other circumstances shall not be affected thereby.

B. Notices to Unit Owners shall be sent by regular mail or hand delivery to their place of residence in the Condominium Building, unless the Unit Owner(s) has, by written notice to the Secretary of the Association, or its authorized representative, specified a different address. All notices shall be deemed and considered sent when actually delivered, or two (2) business days following mailing, whichever occurs first.

C. The failure of the Association or any Unit Owner(s) to enforce any covenant, restriction or other provision of the Condominium Act, this Declaration, the Articles of Incorporation of the Association, the Bylaws, or the Rules and Regulations adopted pursuant thereto, shall not constitute a waiver of the right to do so thereafter. The Association may levy against any Owner a fine in an amount provided for in the Bylaws, and any amendments thereto, for any single violation of the requirements of this Declaration, the Bylaws, or any Rule or Regulation promulgated thereunder, after having been notified by the Association of such violation, provide notice and opportunity to be heard is provided as required by Rules of the Department of Business and Professional Regulation, State of Florida.

D. The remedies for violations provided by the Condominium Act shall be in full force and effect. In addition, thereto, should the Association find it necessary to institute legal proceedings, upon a finding by a court in favor of the Association, the defendant Unit Owner(s) shall reimburse the Association for its costs of suit, including reasonable attorneys' fees at both trial and appellate level, incurred by it in bringing such action.

E. Whenever the context so requires, the use of any gender shall be deemed to include all genders, the use of the plural shall include the singular and the singular shall include the plural.

F. The provisions of this Declaration shall be liberally construed to effectuate its purpose of creating a uniform plan for the operation of the Condominium.

G. Developer recorded that certain Declaration of Covenants, Restrictions and Easements for Platina ("Master Association") in the public records of Palm Beach County, Florida. Article 3 of the Master Declaration provides that the Condominium Property may

be subjected to said declaration by filing in the public records of Palm Beach County, Florida, an appropriate supplemental declaration to the Condominium Property. Accordingly, Developer does hereby declare that the Master Declaration and the covenants, conditions and constrictions contained therein shall be covenants running with the Condominium Property, shall be binding upon all parties having and/or acquiring any right, title or interest in the Condominium or in any part thereof, and all inure to the benefit of each and every person or entity, from time to time owning or holding an interest in the Condominium Property.

H. Except as provided by statute in case of condemnation or substantial loss to the Units and/or Common Elements, unless at least two-thirds (2/3) of the Mortgagees (based upon one (1) vote for each first mortgage owned), or Owners have given their prior written approval, the Association shall not be entitled to:

- (1) By act or omission seek to abandon or terminate the Condominium;
- (2) Partition or subdivide any Unit; and

(3) By act or omission, seek to abandon, partition, subdivide, encumber, sell or transfer the Common Elements. (The granting of easements for public utilities or for other public purposes consistent with the intended use of the Common Elements by the Owners shall not be deemed a transfer within the meaning of this clause.)

I. The Association shall be required to maintain (e.g. cleanup, landscape and landscape maintenance) property adjacent to the Condominium Property owned by state, county, or municipal authorities, or by any other party which has granted to the Association and the Association has accepted an easement to maintain such property, to the extent that:

(1) The deterioration of such adjacent property would adversely affect the appearance of the Condominium Property;

(2) The standard of maintenance of the governmental or other entity owning such property is less than the standard of maintenance adopted by the Association for Condominium Property; and

(3) Appropriate approval of consent is available from the owner(s) of such adjacent property to allow the Association to maintain it.

J. The Association reserves and retains to itself, its successors and assigns:

(1) The title to any closed circuit television system, telecommunication system, master antennae system, community antennae television system (collectively the "CATV Service", which comprises part of the Central System, hereinafter defined) and related ancillary services and to the equipment including but not limited to conduits, wires, amplifiers, towers, antennae and related apparatus and electronic equipment both active and passive (the "Central System") in and upon the Condominium Property and a perpetual easement for the placement and location of the Central System, including, but not limited to conduits, wires, amplifiers, towers, antennae and related apparatus and electronic equipment, both active and passive; and,

ORB 8.796 Ps 381

EXHIBIT "A"

-10-

DECLARATION OF CONDOMINIUM
OF
LUCENTE VILLAGE "B", A CONDOMINIUM

LEGAL DESCRIPTION OF CONDOMINIUM PROPERTY

ORB 8796 Ps 382

NICK MILLER, INC.

Surveying

Planning & Development Consultants

**DESCRIPTION OF LUCENTE VILLAGE "B"
A CONDOMINIUM**

A PARCEL OF LAND LYING WITHIN TRACT C OF PLATINA PLAT No. 1, AS RECORDED IN PLAT BOOK 63, PAGES 83 THROUGH 85 OF THE PUBLIC RECORDS OF PALM BEACH COUNTY, FLORIDA, SAID PARCEL BEING DESCRIBED AS FOLLOWS:

COMMENCING AT THE SOUTHEAST CORNER OF TRACT C OF PLATINA PLAT No. 1, AS RECORDED IN PLAT BOOK 63, PAGES 83 THROUGH 85 OF THE PUBLIC RECORDS OF PALM BEACH COUNTY, FLORIDA, SAID SOUTHEAST CORNER BEING THE INTERSECTION OF THE EAST LINE OF SAID TRACT C WITH THE NORTH LINE OF TRACT B-2 AS SHOWN ON PLATINA PLAT No. 1; THENCE NORTH 0°05'07" WEST ALONG SAID EAST LINE OF TRACT C, A DISTANCE OF 307.18 FEET; THENCE SOUTH 89°54'53" WEST, A DISTANCE OF 80.0 FEET; THENCE CONTINUE SOUTH 89°54'53" WEST, A DISTANCE OF 74.80 FEET; THENCE SOUTH 0°05'07" EAST, A DISTANCE OF 124.49 FEET TO THE POINT OF CURVATURE OF A CURVE CONCAVE TO THE NORTHWEST WITH A RADIUS OF 45.0 FEET; THENCE SOUTHERLY, SOUTHWESTERLY AND WESTERLY ALONG THE ARC OF SAID CURVE, THROUGH A CENTRAL ANGLE OF 89°23'35", A DISTANCE OF 70.21 FEET TO THE POINT OF TANGENCY; THENCE SOUTH 89°18'28" WEST, A DISTANCE OF 260.07 FEET; THENCE CONTINUE SOUTH 89°18'28" WEST, A DISTANCE OF 16.0 FEET TO THE POINT OF BEGINNING; THENCE CONTINUE SOUTH 89°18'28" WEST, A DISTANCE OF 50.51 FEET; THENCE NORTH 45°41'32" WEST, A DISTANCE OF 9.43 FEET; THENCE SOUTH 89°18'28" WEST, A DISTANCE OF 9.65 FEET; THENCE SOUTH 44°18'28" WEST, A DISTANCE OF 9.43 FEET; THENCE SOUTH 89°18'28" WEST, A DISTANCE OF 45.50 FEET; THENCE NORTH 66°35'52" WEST, A DISTANCE OF 36.74 FEET; THENCE SOUTH 89°18'28" WEST, A DISTANCE OF 243.08 FEET; THENCE SOUTH 0°41'32" EAST, A DISTANCE OF 74.80 FEET; THENCE NORTH 89°18'28" EAST, A DISTANCE OF 248.08 FEET; THENCE SOUTH 58°11'17" EAST, A DISTANCE OF 27.91 FEET; THENCE NORTH 89°18'28" EAST, A DISTANCE OF 124.0 FEET; THENCE NORTH 0°41'32" WEST, A DISTANCE OF 74.80 FEET TO THE POINT OF BEGINNING.

CONTAINING: 0.682 ACRE MORE OR LESS.

88025FX-4
JUNE 28, 1994

ORB 8794 Pg 383

EXHIBIT "B"

-10-

**DECLARATION OF CONDOMINIUM
OF
LUCENTE VILLAGE "B", A CONDOMINIUM**

SURVEY, PLOT PLAN, AND GRAPHIC DESCRIPTION OF IMPROVEMENTS

ORB 8796 Pg 384

NICK MILLER, INC.
Surveying
Planning & Development Consultants

**EXHIBIT "B" TO THE DECLARATION OF CONDOMINIUM
OF LUCENTE VILLAGE "B", A CONDOMINIUM**

CERTIFICATION:

I HEREBY CERTIFY THAT THE CONSTRUCTION OF THE IMPROVEMENTS TO COMPRISE BUILDINGS 39 AND 40, LUCENTE VILLAGE "B", A CONDOMINIUM, IS SUBSTANTIALLY COMPLETE SO THAT THE MATERIAL WHICH COMPRISES THIS EXHIBIT "B" TO THE DECLARATION OF CONDOMINIUM OF LUCENTE VILLAGE "B", A CONDOMINIUM TOGETHER WITH THE PROVISIONS OF SAID DECLARATION OF CONDOMINIUM DESCRIBING THE CONDOMINIUM PROPERTY, ARE AN ACCURATE REPRESENTATION OF THE LOCATION AND DIMENSIONS OF SAID IMPROVEMENTS, AND THE IDENTIFICATION, LOCATION, AND DIMENSIONS OF THE COMMON ELEMENTS WITHIN THE CONDOMINIUM AND OF EACH UNIT WITHIN THE CONDOMINIUM CAN BE DETERMINED FROM SAID MATERIALS. FURTHER ALL PLANNED IMPROVEMENTS, INCLUDING BUT NOT LIMITED TO LANDSCAPING, UTILITY SERVICES AND ACCESS TO BUILDINGS 39 AND 40 AND COMMON ELEMENT FACILITIES SERVING BUILDINGS 39 AND 40 AS SET FORTH IN SAID DECLARATION ARE SUBSTANTIALLY COMPLETED.

NICK MILLER, INC.

May 31, 1995

DATE

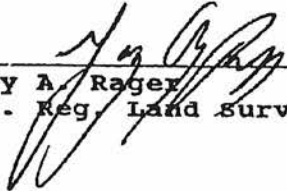

Gary A. Rager
Fla. Reg. Land Surveyor No. 8828



ORB 8796 Ps 385

NICK MILLER, INC.
Surveying
Planning & Development Consultants

**EXHIBIT "B" TO THE DECLARATION OF CONDOMINIUM
OF LUCENTE VILLAGE "B", A CONDOMINIUM**

NOTES:

1. REPRODUCTIONS OF THIS DRAWING ARE NOT VALID UNLESS SIGNED AND SEALED WITH AN EMBOSSED SURVEYOR'S SEAL.
2. LANDS SHOWN HEREON WERE ABSTRACTED FOR EASEMENTS AND/OR RIGHTS-OF-WAY OF RECORD BY GOLD COAST TITLE COMPANY.
3. THIS SURVEY MEETS THE MINIMUM TECHNICAL STANDARDS FOR LAND SURVEYS IN THE STATE OF FLORIDA (F.A.C., Chapter 61G17-6).
4. ALL LAND AND ALL PORTIONS OF CONDOMINIUM PROPERTY NOT WITHIN ANY UNIT OR UNITS, AND/OR PARKING SPACES, ARE PARTS OF THE COMMON ELEMENTS.
5. LEGAL DESCRIPTION ATTACHED HERETO IS IN ACCORDANCE WITH INSTRUMENTS OF RECORD.
6. THIS PLAN IS COMPILED FROM PLANS AND DATA FURNISHED BY MINTO BUILDERS (FLORIDA), INC., ARCHITECTURAL FLOOR PLANS, SUPPLEMENTED BY SUCH FIELD SURVEY AND MEASUREMENTS AS DEEMED NECESSARY BY NICK MILLER, INC.

ORB 8796 Ps 386

NICK MILLER, INC.

Surveying

Planning & Development Consultants

**DESCRIPTION OF LUCENTE VILLAGE "B"
A CONDOMINIUM**

A PARCEL OF LAND LYING WITHIN TRACT C OF PLATINA PLAT No. 1, AS RECORDED IN PLAT BOOK 63, PAGES 83 THROUGH 85 OF THE PUBLIC RECORDS OF PALM BEACH COUNTY, FLORIDA, SAID PARCEL BEING DESCRIBED AS FOLLOWS:

COMMENCING AT THE SOUTHEAST CORNER OF TRACT C OF PLATINA PLAT No. 1, AS RECORDED IN PLAT BOOK 63, PAGES 83 THROUGH 85 OF THE PUBLIC RECORDS OF PALM BEACH COUNTY, FLORIDA, SAID SOUTHEAST CORNER BEING THE INTERSECTION OF THE EAST LINE OF SAID TRACT C WITH THE NORTH LINE OF TRACT B-2 AS SHOWN ON PLATINA PLAT No. 1; THENCE NORTH 0°05'07" WEST ALONG SAID EAST LINE OF TRACT C, A DISTANCE OF 307.18 FEET; THENCE SOUTH 89°54'53" WEST, A DISTANCE OF 80.0 FEET; THENCE CONTINUE SOUTH 89°54'53" WEST, A DISTANCE OF 74.80 FEET; THENCE SOUTH 0°05'07" EAST, A DISTANCE OF 124.49 FEET TO THE POINT OF CURVATURE OF A CURVE CONCAVE TO THE NORTHWEST WITH A RADIUS OF 45.0 FEET; THENCE SOUTHERLY, SOUTHWESTERLY AND WESTERLY ALONG THE ARC OF SAID CURVE, THROUGH A CENTRAL ANGLE OF 89°23'35", A DISTANCE OF 70.21 FEET TO THE POINT OF TANGENCY; THENCE SOUTH 89°18'28" WEST, A DISTANCE OF 260.07 FEET; THENCE CONTINUE SOUTH 89°18'28" WEST, A DISTANCE OF 16.0 FEET TO THE POINT OF BEGINNING; THENCE CONTINUE SOUTH 89°18'28" WEST, A DISTANCE OF 50.51 FEET; THENCE NORTH 45°41'32" WEST, A DISTANCE OF 9.43 FEET; THENCE SOUTH 89°18'28" WEST, A DISTANCE OF 9.65 FEET; THENCE SOUTH 44°18'28" WEST, A DISTANCE OF 9.43 FEET; THENCE SOUTH 89°18'28" WEST, A DISTANCE OF 45.50 FEET; THENCE NORTH 66°35'52" WEST, A DISTANCE OF 36.74 FEET; THENCE SOUTH 89°18'28" WEST, A DISTANCE OF 243.08 FEET; THENCE SOUTH 0°41'32" EAST, A DISTANCE OF 74.80 FEET; THENCE NORTH 89°18'28" EAST, A DISTANCE OF 248.08 FEET; THENCE SOUTH 58°11'17" EAST, A DISTANCE OF 27.91 FEET; THENCE NORTH 89°18'28" EAST, A DISTANCE OF 124.0 FEET; THENCE NORTH 0°41'32" WEST, A DISTANCE OF 74.80 FEET TO THE POINT OF BEGINNING.

CONTAINING: 0.682 ACRE MORE OR LESS.

88025FX-4
JUNE 28, 1994

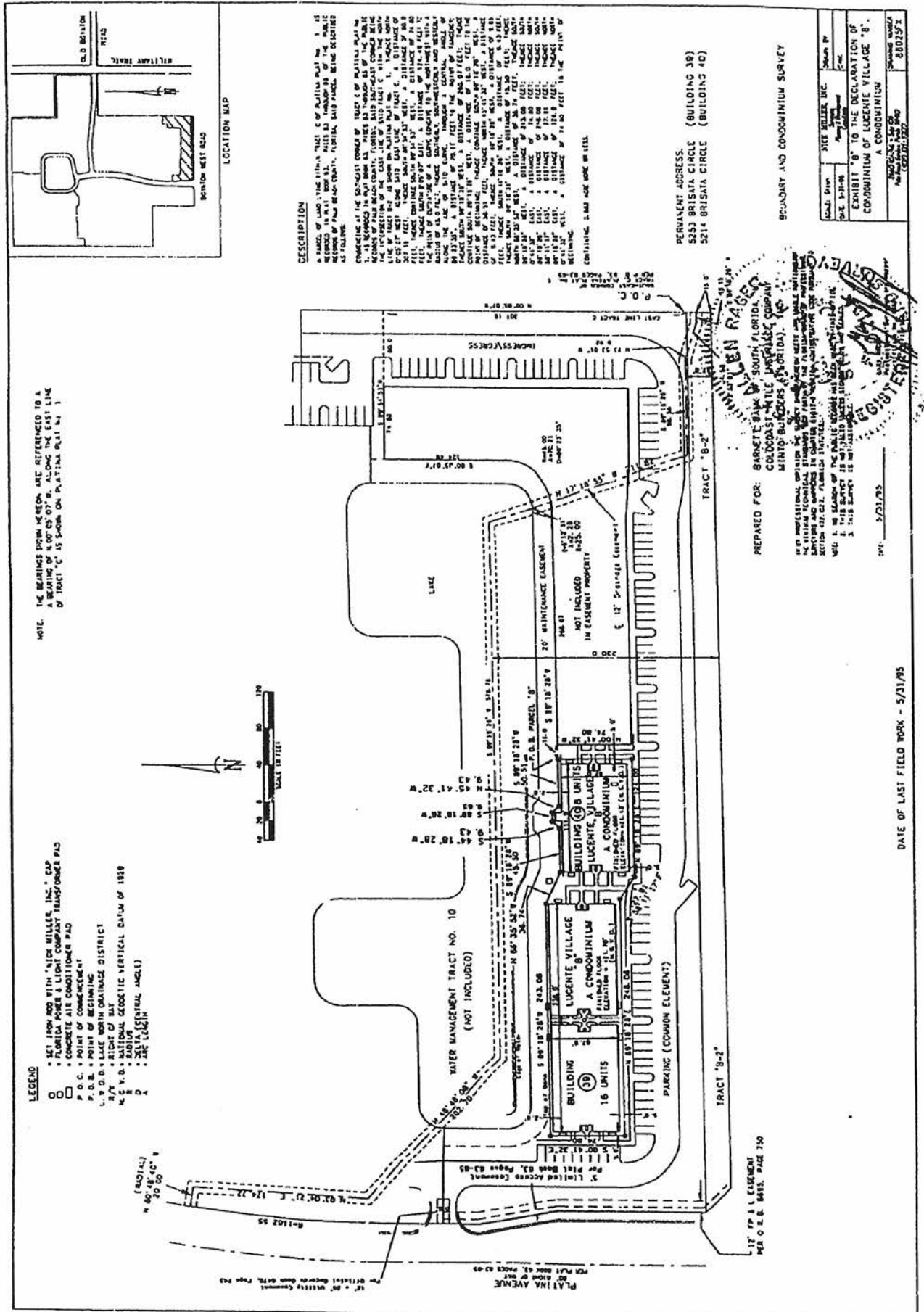

NOTE: THE BEARINGS FROM HEREON ARE REFERENCED TO A POINT OF BEGINNING ALONG THE EAST LINE OF TRACT 'C' AS SHOWN ON PLAT IN PLAT NO. 1

- LEGEND**
- SET 1000' ROD WITH "NICK MILLER, INC." CAP
 - FLORIDA POWER & LIGHT COMPANY TRANSFORMER PAD
 - CONCRETE AIR CONDITIONER PAD
 - P.C.C. • POINT OF COMMENCEMENT
 - P.O.B. • POINT OF BEGINNING
 - L.S.D. • LAKE NORTH DRAINAGE DISTRICT
 - R/W • RIGHT OF WAY
 - N.C. • NATIONAL GEODETIC VERTICAL DATUM OF 1988
 - Δ • DELTA (CENTRAL ANGLE)
 - D • DEGREE

DESCRIPTION

TRACT 'B' OF PLAT NO. 10, 11, 12, 13, 14, 15, 16, 17, 18, 19, 20, 21, 22, 23, 24, 25, 26, 27, 28, 29, 30, 31, 32, 33, 34, 35, 36, 37, 38, 39, 40, 41, 42, 43, 44, 45, 46, 47, 48, 49, 50, 51, 52, 53, 54, 55, 56, 57, 58, 59, 60, 61, 62, 63, 64, 65, 66, 67, 68, 69, 70, 71, 72, 73, 74, 75, 76, 77, 78, 79, 80, 81, 82, 83, 84, 85, 86, 87, 88, 89, 90, 91, 92, 93, 94, 95, 96, 97, 98, 99, 100, 101, 102, 103, 104, 105, 106, 107, 108, 109, 110, 111, 112, 113, 114, 115, 116, 117, 118, 119, 120, 121, 122, 123, 124, 125, 126, 127, 128, 129, 130, 131, 132, 133, 134, 135, 136, 137, 138, 139, 140, 141, 142, 143, 144, 145, 146, 147, 148, 149, 150, 151, 152, 153, 154, 155, 156, 157, 158, 159, 160, 161, 162, 163, 164, 165, 166, 167, 168, 169, 170, 171, 172, 173, 174, 175, 176, 177, 178, 179, 180, 181, 182, 183, 184, 185, 186, 187, 188, 189, 190, 191, 192, 193, 194, 195, 196, 197, 198, 199, 200, 201, 202, 203, 204, 205, 206, 207, 208, 209, 210, 211, 212, 213, 214, 215, 216, 217, 218, 219, 220, 221, 222, 223, 224, 225, 226, 227, 228, 229, 230, 231, 232, 233, 234, 235, 236, 237, 238, 239, 240, 241, 242, 243, 244, 245, 246, 247, 248, 249, 250, 251, 252, 253, 254, 255, 256, 257, 258, 259, 260, 261, 262, 263, 264, 265, 266, 267, 268, 269, 270, 271, 272, 273, 274, 275, 276, 277, 278, 279, 280, 281, 282, 283, 284, 285, 286, 287, 288, 289, 290, 291, 292, 293, 294, 295, 296, 297, 298, 299, 300, 301, 302, 303, 304, 305, 306, 307, 308, 309, 310, 311, 312, 313, 314, 315, 316, 317, 318, 319, 320, 321, 322, 323, 324, 325, 326, 327, 328, 329, 330, 331, 332, 333, 334, 335, 336, 337, 338, 339, 340, 341, 342, 343, 344, 345, 346, 347, 348, 349, 350, 351, 352, 353, 354, 355, 356, 357, 358, 359, 360, 361, 362, 363, 364, 365, 366, 367, 368, 369, 370, 371, 372, 373, 374, 375, 376, 377, 378, 379, 380, 381, 382, 383, 384, 385, 386, 387, 388, 389, 390, 391, 392, 393, 394, 395, 396, 397, 398, 399, 400, 401, 402, 403, 404, 405, 406, 407, 408, 409, 410, 411, 412, 413, 414, 415, 416, 417, 418, 419, 420, 421, 422, 423, 424, 425, 426, 427, 428, 429, 430, 431, 432, 433, 434, 435, 436, 437, 438, 439, 440, 441, 442, 443, 444, 445, 446, 447, 448, 449, 450, 451, 452, 453, 454, 455, 456, 457, 458, 459, 460, 461, 462, 463, 464, 465, 466, 467, 468, 469, 470, 471, 472, 473, 474, 475, 476, 477, 478, 479, 480, 481, 482, 483, 484, 485, 486, 487, 488, 489, 490, 491, 492, 493, 494, 495, 496, 497, 498, 499, 500, 501, 502, 503, 504, 505, 506, 507, 508, 509, 510, 511, 512, 513, 514, 515, 516, 517, 518, 519, 520, 521, 522, 523, 524, 525, 526, 527, 528, 529, 530, 531, 532, 533, 534, 535, 536, 537, 538, 539, 540, 541, 542, 543, 544, 545, 546, 547, 548, 549, 550, 551, 552, 553, 554, 555, 556, 557, 558, 559, 560, 561, 562, 563, 564, 565, 566, 567, 568, 569, 570, 571, 572, 573, 574, 575, 576, 577, 578, 579, 580, 581, 582, 583, 584, 585, 586, 587, 588, 589, 590, 591, 592, 593, 594, 595, 596, 597, 598, 599, 600, 601, 602, 603, 604, 605, 606, 607, 608, 609, 610, 611, 612, 613, 614, 615, 616, 617, 618, 619, 620, 621, 622, 623, 624, 625, 626, 627, 628, 629, 630, 631, 632, 633, 634, 635, 636, 637, 638, 639, 640, 641, 642, 643, 644, 645, 646, 647, 648, 649, 650, 651, 652, 653, 654, 655, 656, 657, 658, 659, 660, 661, 662, 663, 664, 665, 666, 667, 668, 669, 670, 671, 672, 673, 674, 675, 676, 677, 678, 679, 680, 681, 682, 683, 684, 685, 686, 687, 688, 689, 690, 691, 692, 693, 694, 695, 696, 697, 698, 699, 700, 701, 702, 703, 704, 705, 706, 707, 708, 709, 710, 711, 712, 713, 714, 715, 716, 717, 718, 719, 720, 721, 722, 723, 724, 725, 726, 727, 728, 729, 730, 731, 732, 733, 734, 735, 736, 737, 738, 739, 740, 741, 742, 743, 744, 745, 746, 747, 748, 749, 750, 751, 752, 753, 754, 755, 756, 757, 758, 759, 760, 761, 762, 763, 764, 765, 766, 767, 768, 769, 770, 771, 772, 773, 774, 775, 776, 777, 778, 779, 780, 781, 782, 783, 784, 785, 786, 787, 788, 789, 790, 791, 792, 793, 794, 795, 796, 797, 798, 799, 800, 801, 802, 803, 804, 805, 806, 807, 808, 809, 810, 811, 812, 813, 814, 815, 816, 817, 818, 819, 820, 821, 822, 823, 824, 825, 826, 827, 828, 829, 830, 831, 832, 833, 834, 835, 836, 837, 838, 839, 840, 841, 842, 843, 844, 845, 846, 847, 848, 849, 850, 851, 852, 853, 854, 855, 856, 857, 858, 859, 860, 861, 862, 863, 864, 865, 866, 867, 868, 869, 870, 871, 872, 873, 874, 875, 876, 877, 878, 879, 880, 881, 882, 883, 884, 885, 886, 887, 888, 889, 890, 891, 892, 893, 894, 895, 896, 897, 898, 899, 900, 901, 902, 903, 904, 905, 906, 907, 908, 909, 910, 911, 912, 913, 914, 915, 916, 917, 918, 919, 920, 921, 922, 923, 924, 925, 926, 927, 928, 929, 930, 931, 932, 933, 934, 935, 936, 937, 938, 939, 940, 941, 942, 943, 944, 945, 946, 947, 948, 949, 950, 951, 952, 953, 954, 955, 956, 957, 958, 959, 960, 961, 962, 963, 964, 965, 966, 967, 968, 969, 970, 971, 972, 973, 974, 975, 976, 977, 978, 979, 980, 981, 982, 983, 984, 985, 986, 987, 988, 989, 990, 991, 992, 993, 994, 995, 996, 997, 998, 999, 1000.

PERMANENT ADDRESS:
 5253 BRISATA CIRCLE (BUILDING 38)
 5214 BRISATA CIRCLE (BUILDING 40)

BOUNDARY AND CONDOMINIUM SURVEY

DATE	5/11/95
BY	DAVID L. BARNETT
FOR	BARNETT BANK SOUTH FLORIDA
PROJECT	CONDOMINIUM SURVEY
TRACT	TRACT 'B' OF PLAT NO. 10
SECTION	SECTION 17, T. 27 N., R. 20 E., S. 1
COUNTY	DADE COUNTY, FLORIDA
CITY	MIRAGE, FLORIDA
STATE	FLORIDA

DATE OF LAST FIELD WORK - 5/31/95

ORR 8796 P5 387

EXHIBIT "B" TO THE DECLARATION OF CONDOMINIUM OF
LUCENTE VILLAGE "B", A CONDOMINIUM

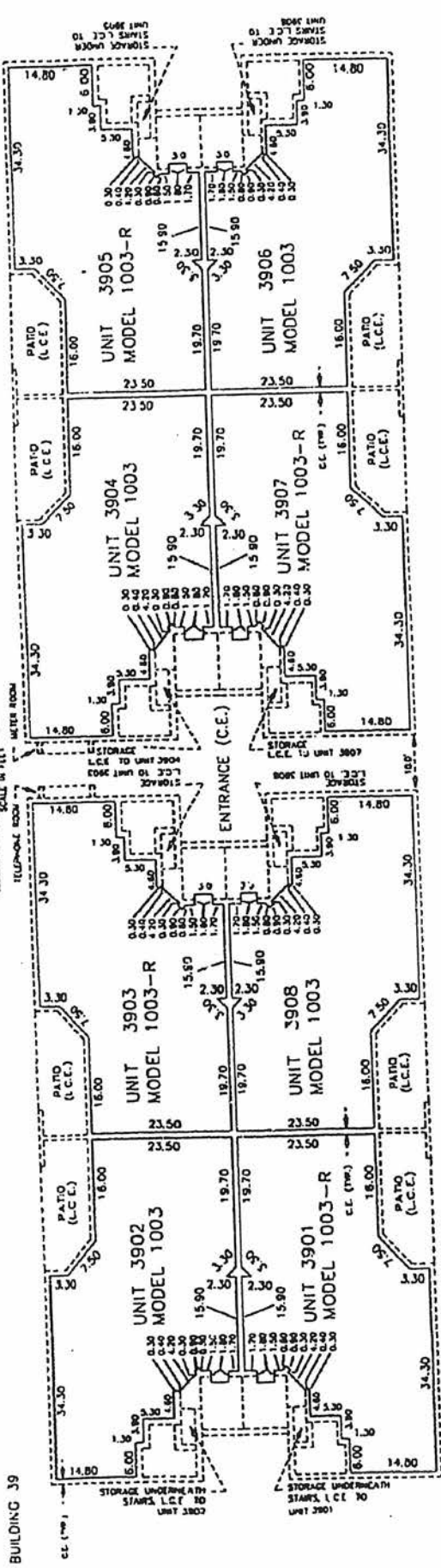

LEGEND

- INDICATES UNIT BOUNDARIES
- (C.E.) INDICATES COMMON ELEMENTS
- (L.C.E.) INDICATES LIMITED COMMON ELEMENTS
- (S.E.) INDICATES STORAGE
- (S.C.E.) INDICATES STAIRS

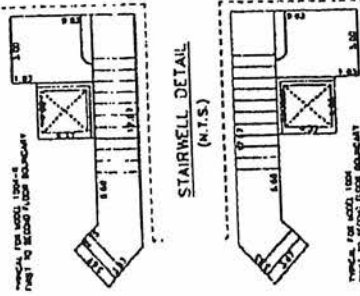

FIRST FLOOR

UNITS 3901-3908 ARE 10'0" HIGH. (N.C.V.D.)
 UNITS 3903-R, 3904, 3905-R, 3907 ARE 10'0" HIGH. (N.C.V.D.)

BUILDING 39

DATE SHOWN	REVISED BY
MAY '95	REVISED BY
EXHIBIT "B" TO THE DECLARATION OF CONDOMINIUM OF "LUCENTE VILLAGE - B" A CONDOMINIUM	
SCALE	DATE
1/8" = 1'-0"	05/01/95

ORR 8796 R 388

- NOTES**
1. THIS PLAN IS COMPILED FROM PLANS AND DATA FURNISHED BY UNITS OWNERS (LORDS), INC. ARCHITECTURAL CONSULTANTS BY BOB MILLER, INC. FIELD SURVEY AND MEASUREMENTS AS REQUIRED ACCESSIBLE BY BOB MILLER, INC.
 2. ALL WALLS ARE 057 FEET THICK UNLESS OTHERWISE NOTED.
 3. DIMENSIONS (WHERE DESIGNATED) SHOWN IN FEET ARE BASED UPON NATIONAL GEODETIC VERTICAL DATUM.
 4. FOR FURTHER INFORMATION REGARDING BOUNDARIES OF THIS UNIT, REFER TO THE DECLARATION OF CONDOMINIUM.
 5. THE DIMENSIONS SET FORTH IN THE DECLARATION ARE INCORPORATED HEREIN.

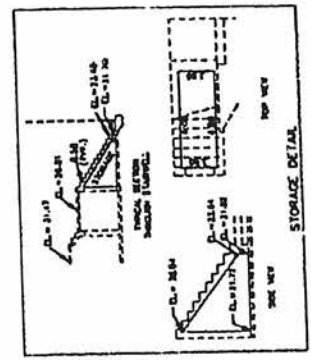

- DESCRIPTION OF COMMON ELEMENTS**
1. ALL LAWN AND ALL PORTIONS OF CONDOMINIUM PROPERTY NOT WITHIN ANY UNIT OR UNITS, ARE PUBLIC COMMON ELEMENTS.
 2. ALL BEARING WALLS TO THE UNITS AND BRACES OF SAID WALLS LOCATED WITHIN A UNIT, CONSTITUTE PART OF THE COMMON ELEMENTS.
 3. ALL CORNERS AND AREAS TO CURBLINE, ALL OTHER UTILITY LINES TO UNITS, AND ALL PARTS OF COMMON ELEMENTS, UNLESS OTHERWISE SPECIFIED IN THIS DECLARATION, ARE SUBJECT TO CERTAIN EASEMENTS SET FORTH IN THE DECLARATION INCLUDING WORKS AND EGRESS TO PUBLIC WAYS.

EXHIBIT "B" TO THE DECLARATION OF CONDOMINIUM OF
 LUCENTE VILLAGE "B", A CONDOMINIUM

BUILDING 39

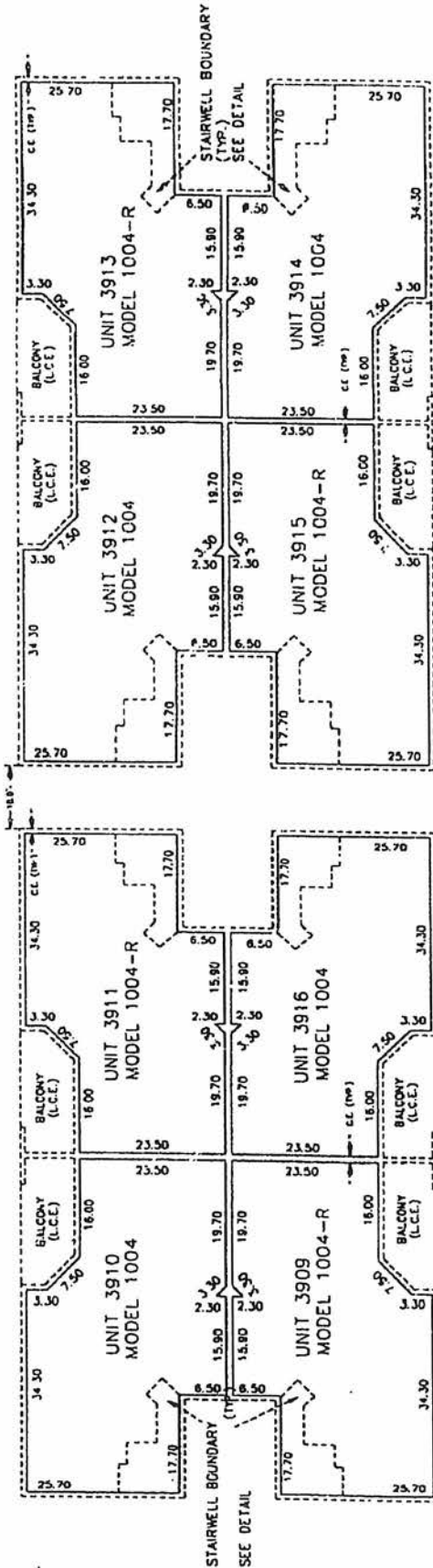

SECOND FLOOR

MINIMUM UNIT OF UNITS 3919 ELEV. (E.C.E.V.)
 MINIMUM UNIT OF UNITS 3919 ELEV. (E.C.E.V.)

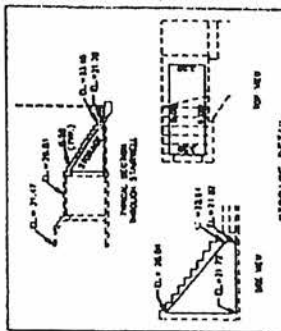

DESCRIPTION OF COMMON ELEMENTS

1. ALL UNITS AND ALL PORTIONS OF COMMON ELEMENTS NOT WITHIN A UNIT OR UNIT, ARE PARTS OF THE COMMON ELEMENTS.
2. ALL BEARING WALLS TO THE UNIMPOSED SURFACE OF BALCONIES LOCATED WITHIN A UNIT, CONSTITUTE PART OF THE COMMON ELEMENTS.
3. ALL STAIRS AND WALKS TO OUTLETS, ALL OTHER UTILITY LINES TO UNITS, AND ALL PORTIONS OF COMMON ELEMENTS, CONSTITUTE PART OF THE COMMON ELEMENTS.
4. THE COMMON ELEMENTS ARE SUBJECT TO CERTAIN EASEMENTS SET FORTH IN THE DECLARATION INCLUDING EGRESS AND ACCESS TO PUBLIC WAYS.

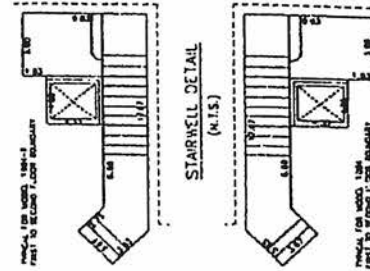

LEGEND

- INDICATES UNIT BOUNDARIES
- (C.E.) INDICATES COMMON ELEMENTS
- (L.C.C.) INDICATES LIMITED COMMON ELEMENTS
- (B.A.L.C.) INDICATES BALCONY

BUILDING 39

DATE SHOWN	DATE REVISION	REVISION
08/15/24	08/15/24	REVISED PER COMMENTS
EXHIBIT "B" TO THE DECLARATION OF CONDOMINIUM OF LUCENTE VILLAGE "B", A CONDOMINIUM		
PROJECT: 20260080687		
DRAWN BY: [Name]		
CHECKED BY: [Name]		
DATE: 08/15/24		

088 8796 9628 880

EXHIBIT "B" TO THE DECLARATION OF CONDOMINIUM OF
 LUCENTE VILLAGE "B", A CONDOMINIUM

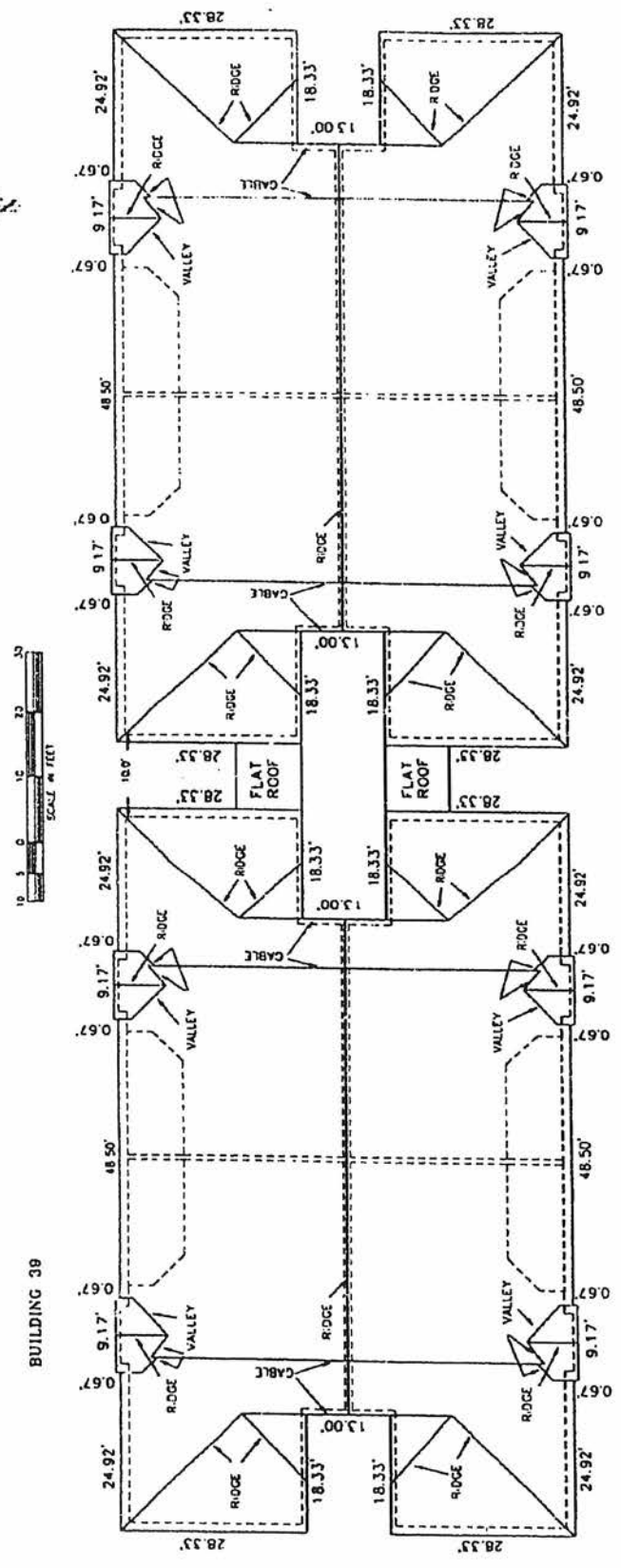

ROOF PLAN
 U.S. UPPER LIMIT OF ROOF 54.44 ELEV. (N.G.V.D.)
 U.S. LOWER LIMIT OF ROOF 39.15 ELEV. (N.G.V.D.)

LEGEND
 --- INCLUDES UNIT BOUNDARIES
 (G.L.) INDICATES COMMON ELEMENTS
 (S.C.E.) INDICATES UNIT COMMON ELEMENTS
 (B.A.C.) INDICATES BALCONY

NOTE
 1. THIS PLAN IS COMPILED FROM PLANS AND DATA FURNISHED BY UNIT HOLDERS (FLOOR), ARCHITECTURAL RECORDS, AND FIELD SURVEY AND VOUCHERS AS NECESSARY BY JACK WALKER, INC.
 2. ALL WALLS ARE 6.57 FEET THICK UNLESS OTHERWISE NOTED
 3. ELEVATIONS (WORK DISCREPANCY) SHOWN IN FEET, ARE BASED UPON NATIONAL GEODETIC VERTICAL DATUM.
 4. FOR FURTHER INFORMATION REGARDING BOUNDARIES OF THIS UNIT, REFER TO THE DECLARATION OF CONDOMINIUM.
 5. THE DEFINITIONS SET FORTH IN THE DECLARATION ARE INCORPORATED BY REFERENCE.

DESCRIPTION OF COMMON ELEMENTS
 1. ALL LAND AND ALL PORTIONS OF CONDOMINIUM PROPERTY NOT WITHIN ANY UNIT OR UNIT WALL PORTION OF THE COMMON ELEMENTS.
 2. ALL BUILDING WALLS TO THE UNFINISHED SURFACE OF EXISTING WALLS LOCATED WITHIN A UNIT, CONSTITUTE PART OF THE COMMON ELEMENTS.
 3. ALL CONDUITS AND LINES TO OR FROM ALL OTHER UTILITIES BASED TO THE COMMON ELEMENTS, INCLUDING BUT NOT LIMITED TO, ELECTRICAL, GAS, WATER AND SEWER LINES, CONSTITUTE PART OF THE COMMON ELEMENTS.
 4. THE COMMON ELEMENTS INCLUDING ACCESS AND EGRESS TO PUBLIC WAYS.

SCALE	AS SHOWN	DATE	10/15/05
DESIGNED BY	ARCHITECT	DATE	10/15/05
DRAWN BY	ARCHITECT	DATE	10/15/05
CHECKED BY	ARCHITECT	DATE	10/15/05
APPROVED BY	ARCHITECT	DATE	10/15/05

ORR 8796 Ps 390

EXHIBIT "B" TO THE DECLARATION OF CONDOMINIUM OF
 LUCENTE VILLAGE "B", A CONDOMINIUM

BUILDING 40

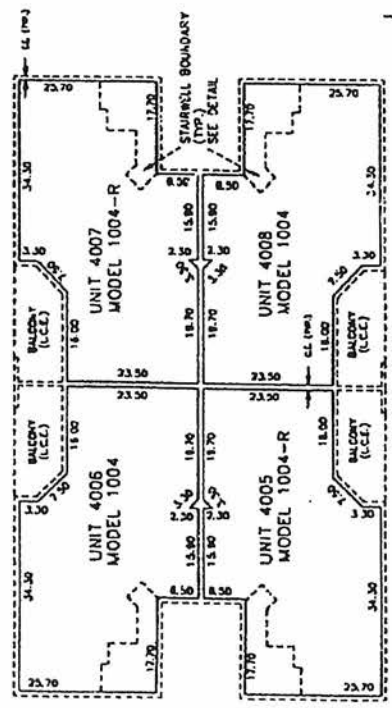
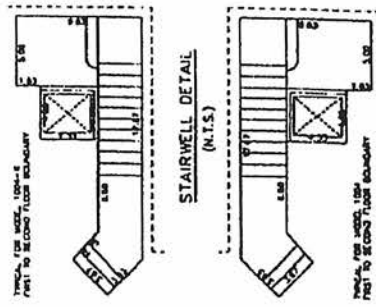
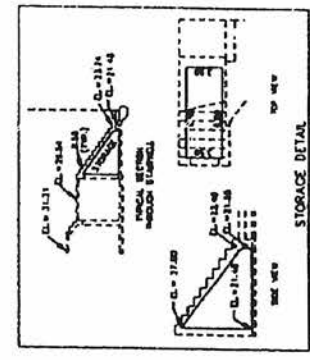

SECOND FLOOR
 MAXIMUM LOWER LIMIT OF UNITS 19.31 ELEV. (N.C.V.B.)
 MAXIMUM LOWER LIMIT OF UNITS 21.48 ELEV. (N.C.V.B.)

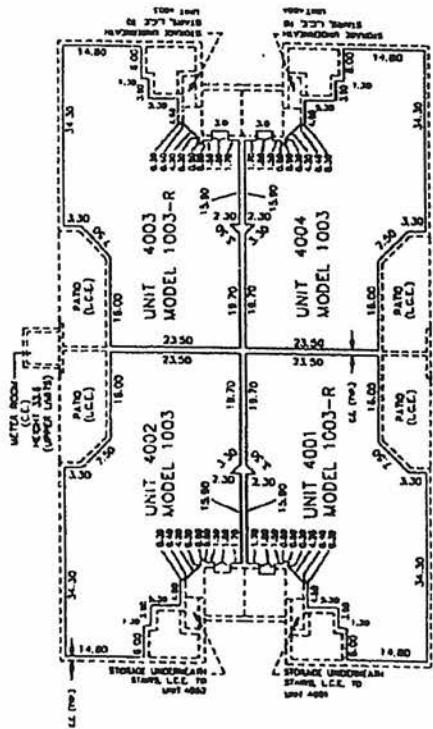

FIRST FLOOR
 MAXIMUM LOWER LIMIT OF UNITS 20.82 ELEV. (N.C.V.B.)
 MAXIMUM LOWER LIMIT OF UNITS 21.48 ELEV. (N.C.V.B.)

DESCRIPTION OF COMMON ELEMENTS

1. ALL LOTS AND ALL PORTIONS OF CONDOMINIUM PROPERTY NOT WITHIN ANY UNIT OR LOT, ARE PARTS OF THE COMMON ELEMENTS.
2. ALL REAR WALLS TO THE UNIMPOVED SURFACE OF SAID WALLS LOCATED WITHIN A UNIT, CONSTITUTE PART OF THE COMMON ELEMENTS.
3. ALL CORNERS AND MARKS TO CURBS, ALL OTHER UTILITY LINES, TO UTILITIES AND ALL WASTE PIPES, REGARDLESS OF LOCATION, CONSTITUTE PARTS OF THE COMMON ELEMENTS.
4. THE COMMON ELEMENTS ARE SUBJECT TO CERTAIN EASEMENTS SET FORTH IN THE DECLARATION INCLUDING WAYS AND EGRESS TO PUBLIC WAYS.

NOTES

1. THIS PLAN IS COMPILED FROM PLANS AND DATA FURNISHED BY WAID BUILDERS (LORISS), INC. ARCHITECTURAL PLANS, PREPARED BY SAID FIELD SURVEY AND MEASUREMENTS AS DELETED NECESSARY BY THIS PLAN. ALL ELEVATIONS (WHEN DESIGNATED) SHOWN IN FEET, ARE BASED UPON NATIONAL GEODETIC VERTICAL DATUM.
2. ALL WALLS ARE 0.87 FEET THICK UNLESS OTHERWISE NOTED.
3. FOR FURTHER INFORMATION REGARDING BOUNDARIES OF THIS UNIT, REFER TO THE DECLARATION OF CONDOMINIUM.
4. THE DEFINITIONS SET FORTH IN THE DECLARATION ARE INCORPORATED HEREIN.

LEGEND

- INDICATES UNIT BOUNDARIES
- (C.C.) INDICATES COMMON ELEMENTS
- (L.C.E.) INDICATES LOT-TO COMMON ELEMENTS
- (B.A.L.C.) INDICATES BALCONY

BUILDING 40

DATE SHOWN	DATE REVISED	BY
JULY '93		

EXHIBIT "B" TO THE DECLARATION OF CONDOMINIUM OF LUCENTE VILLAGE "B", A CONDOMINIUM

ORB 8796 Ps 391

EXHIBIT "B" TO THE DECLARATION OF CONDOMINIUM OF
 LUCENTE VILLAGE "B", A CONDOMINIUM

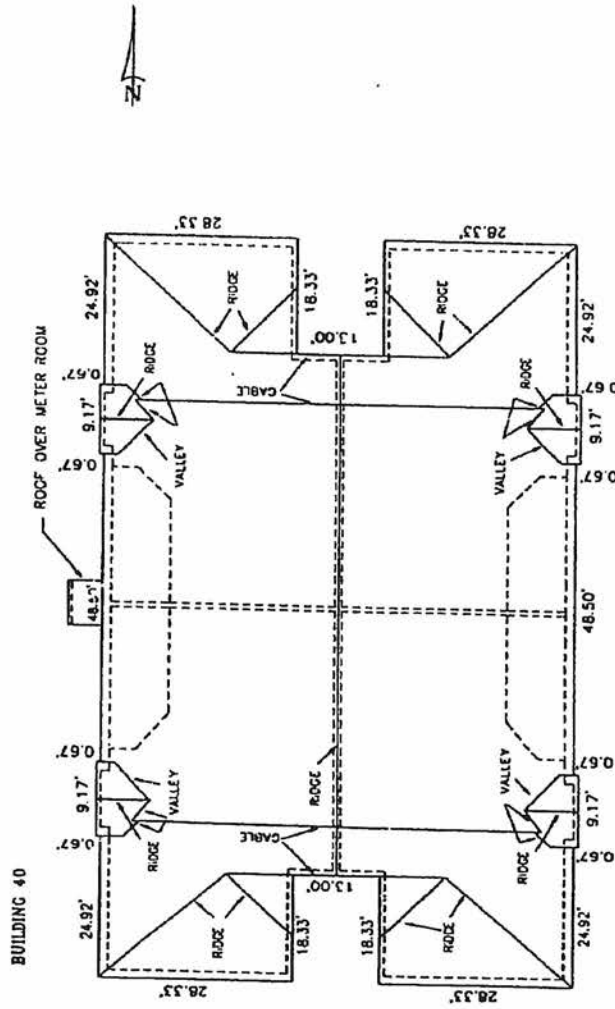

ROOF PLAN

MIN. UPPER LIMIT OF ROOF 53.80 ELEV. (N.G.V.D.)
 U.S. LOWER LIMIT OF ROOF 36.51 ELEV. (N.G.V.D.)

DESCRIPTION OF COMMON ELEMENTS

1. ALL LAND AND ALL PORTIONS OF CONDOMINIUM PROPERTY NOT WITHIN ANY UNIT OR UNITS, ARE PARTS OF THE COMMON ELEMENTS.
2. ALL BEARING WALLS TO THE IMPROVED SURFACE OF SLO WALLS LOCATED WITHIN A UNIT, CONSTITUTE PART OF THE COMMON ELEMENTS.
3. ALL CORNERS AND WALLS TO OUTLETS, ALL OTHER UTILITY LINES TO UNITS AND ALL OTHER UTILITY LINES TO UNITS, CONSTITUTE PARTS OF THE COMMON ELEMENTS.
4. THE COMMON ELEMENTS ARE SUBJECT TO CERTAIN EASEMENTS SET FORTH IN THE DECLARATION INCLUDING ROADS AND LINES TO PUBLIC WAYS.

NOTES

1. THIS PLAN IS DERIVED FROM PLANS AND DATA FURNISHED BY THE ARCHITECT (LOCAL ARCHITECTURAL FIRM) AND THE ENGINEER (LOCAL ENGINEERING FIRM) AND MEASUREMENTS AS DERIVED NECESSARY BY MCK MILLER, INC.
2. ALL WALLS ARE 0.67 FEET THICK UNLESS OTHERWISE NOTED.
3. ELEVATIONS (UNLESS DESIGNATED) SHOWN IN FEET, ARE BASED UPON NATIONAL GEODETIC VERTICAL DATUM.
4. FOR FURTHER INFORMATION REGARDING BOUNDARIES OF THIS UNIT, REFER TO THE DECLARATION OF CONDOMINIUM.
5. THE CONDITIONS SET FORTH IN THE DECLARATION ARE INCORPORATED HEREIN.

LEGEND

- LOCATES UNIT BOUNDARIES
- (C.E.) LOCATES COMMON ELEMENTS
- (L.C.E.) LOCATES LIMITED COMMON ELEMENTS
- (S.E.) LOCATES STORAGE
- (S.C.E.) LOCATES SLOTTED

BUILDING 40
 ROOF PLAN

DATE	REV	BY	CHK
JULY '95	1		
EXHIBIT "B" TO THE DECLARATION OF CONDOMINIUM OF LUCENTE VILLAGE "B", A CONDOMINIUM			
MCK MILLER, INC.			
10000 N. W. 11th Ave., Suite 100, Ft. Lauderdale, FL 33309			
86-02525X			

ORR E796 Pg 392

ORB 8796 Pg 440

Exhibit "C"

-to-

DECLARATION OF CONDOMINIUM
OF
LUCENTE VILLAGE "B", A CONDOMINIUM

LEGAL DESCRIPTION OF EASEMENT PROPERTY

ORB 8796 Ps 4:1

NICK MILLER, INC.

Surveying

Planning & Development Consultants

**DESCRIPTION OF LUCENTE VILLAGE
CONDOMINIUM ASSOCIATION, INC. EASEMENT PROPERTY**

A PARCEL OF LAND LYING WITHIN TRACT C OF PLATINA PLAT No. 1, AS RECORDED IN PLAT BOOK 63, PAGES 83 THROUGH 85 OF THE PUBLIC RECORDS OF PALM BEACH COUNTY, FLORIDA, SAID PARCEL BEING DESCRIBED AS FOLLOWS:

BEGINNING AT THE SOUTHEAST CORNER OF TRACT C OF PLATINA PLAT No. 1, AS RECORDED IN PLAT BOOK 63, PAGES 83 THROUGH 85 OF THE PUBLIC RECORDS OF PALM BEACH COUNTY, FLORIDA, SAID SOUTHEAST CORNER BEING THE INTERSECTION OF THE EAST LINE OF SAID TRACT C WITH THE NORTH LINE OF TRACT B-2 AS SHOWN ON PLATINA PLAT No. 1; THENCE NORTH 0°05'07" WEST ALONG SAID EAST LINE OF TRACT C, A DISTANCE OF 390.08 FEET; THENCE SOUTH 89°54'53" WEST, A DISTANCE OF 121.0 FEET; THENCE SOUTH 0°05'07" EAST, A DISTANCE OF 68.98 FEET; THENCE SOUTH 89°54'53" WEST, A DISTANCE OF 53.80 FEET; THENCE SOUTH 0°05'07" EAST, A DISTANCE OF 138.41 FEET TO THE POINT OF CURVATURE OF A CURVE CONCAVE TO THE NORTHWEST WITH A RADIUS OF 25.0 FEET; THENCE SOUTHERLY, SOUTHWESTERLY AND WESTERLY ALONG THE ARC OF SAID CURVE, THROUGH A CENTRAL ANGLE OF 89°23'25", A DISTANCE OF 39.01 FEET TO THE POINT OF TANGENCY; THENCE SOUTH 89°18'28" WEST, A DISTANCE OF 318.30 FEET; THENCE NORTH 45°41'32" WEST, A DISTANCE OF 9.43 FEET; THENCE SOUTH 89°18'28" WEST, A DISTANCE OF 26.22 FEET; THENCE SOUTH 44°18'28" WEST, A DISTANCE OF 9.43 FEET; THENCE SOUTH 89°18'28" WEST, A DISTANCE OF 32.95 FEET; THENCE NORTH 66°35'52" WEST, A DISTANCE OF 36.74 FEET; THENCE SOUTH 89°18'28" WEST, A DISTANCE OF 214.24 FEET TO THE POINT OF CURVATURE OF A CURVE CONCAVE TO THE NORTHEAST WITH A RADIUS OF 25.0 FEET; THENCE WESTERLY, NORTHWESTERLY AND NORTHERLY ALONG THE ARC OF SAID CURVE, THROUGH A CENTRAL ANGLE OF 90°43'35", A DISTANCE OF 39.59 FEET TO THE POINT OF TANGENCY; THENCE NORTH 0°02'03" EAST, A DISTANCE OF 62.64 FEET; THENCE NORTH 88°34'05" WEST, A DISTANCE OF 50.01 FEET; THENCE NORTH 89°57'57" WEST, A DISTANCE OF 52.50 FEET; THENCE SOUTH 0°02'03" WEST ALONG THE EAST RIGHT OF WAY LINE OF PLATINA AVENUE AS SHOWN ON SAID PLATINA PLAT No. 1, A DISTANCE OF 35.0 FEET; THENCE SOUTH 10°28'57" EAST ALONG SAID EAST RIGHT OF WAY LINE, A DISTANCE OF 82.18 FEET; THENCE SOUTH 0°02'03" WEST ALONG SAID EAST RIGHT OF WAY LINE, A DISTANCE OF 149.30 FEET; THENCE NORTH 89°18'28" EAST ALONG THE SOUTH LINE OF SAID TRACT C AND NORTH LINE OF SAID TRACT B-2, A DISTANCE OF 951.48 FEET TO THE POINT OF BEGINNING, LESS THE FOLLOWING DESCRIBED PARCELS;

88025FX-5
SHEET 1 OF 3
JUNE 28, 1994

ORB 8796 Pg 442

PARCEL "A", BEING;

A PARCEL OF LAND LYING WITHIN TRACT C OF PLATINA PLAT No. 1, AS RECORDED IN PLAT BOOK 63, PAGES 83 THROUGH 85 OF THE PUBLIC RECORDS OF PALM BEACH COUNTY, FLORIDA, SAID PARCEL BEING DESCRIBED AS FOLLOWS:

COMMENCING AT THE SOUTHEAST CORNER OF TRACT C OF PLATINA PLAT No. 1, AS RECORDED IN PLAT BOOK 63, PAGES 83 THROUGH 85 OF THE PUBLIC RECORDS OF PALM BEACH COUNTY, FLORIDA, SAID SOUTHEAST CORNER BEING THE INTERSECTION OF THE EAST LINE OF SAID TRACT C WITH THE NORTH LINE OF TRACT B-2 AS SHOWN ON PLATINA PLAT No. 1; THENCE NORTH 0°05'07" WEST ALONG SAID EAST LINE OF TRACT C, A DISTANCE OF 307.18 FEET; THENCE SOUTH 89°54'53" WEST, A DISTANCE OF 80.0 FEET TO THE POINT OF BEGINNING; THENCE CONTINUE SOUTH 89°54'53" WEST, A DISTANCE OF 74.80 FEET; THENCE SOUTH 0°05'07" EAST, A DISTANCE OF 124.49 FEET TO THE POINT OF CURVATURE OF A CURVE CONCAVE TO THE NORTHWEST WITH A RADIUS OF 45.0 FEET; THENCE SOUTHERLY, SOUTHWESTERLY AND WESTERLY ALONG THE ARC OF SAID CURVE, THROUGH A CENTRAL ANGLE OF 89°23'35", A DISTANCE OF 70.21 FEET TO THE POINT OF TANGENCY; THENCE SOUTH 89°18'28" WEST, A DISTANCE OF 260.07 FEET; THENCE SOUTH 0°41'32" EAST, A DISTANCE OF 74.80 FEET; THENCE NORTH 89°18'28" EAST, A DISTANCE OF 248.08 FEET; THENCE SOUTH 86°09'44" EAST, A DISTANCE OF 53.65 FEET; THENCE NORTH 89°54'53" EAST, A DISTANCE OF 77.0 FEET; THENCE NORTH 0°05'07" WEST, A DISTANCE OF 248.08 FEET TO THE POINT OF BEGINNING,

PARCEL "B", BEING;

A PARCEL OF LAND LYING WITHIN TRACT C OF PLATINA PLAT No. 1, AS RECORDED IN PLAT BOOK 63, PAGES 83 THROUGH 85 OF THE PUBLIC RECORDS OF PALM BEACH COUNTY, FLORIDA, SAID PARCEL BEING DESCRIBED AS FOLLOWS:

COMMENCING AT THE SOUTHEAST CORNER OF TRACT C OF PLATINA PLAT No. 1, AS RECORDED IN PLAT BOOK 63, PAGES 83 THROUGH 85 OF THE PUBLIC RECORDS OF PALM BEACH COUNTY, FLORIDA, SAID SOUTHEAST CORNER BEING THE INTERSECTION OF THE EAST LINE OF SAID TRACT C WITH THE NORTH LINE OF TRACT B-2 AS SHOWN ON PLATINA PLAT No. 1, THENCE NORTH 0°05'07" WEST ALONG SAID EAST LINE OF TRACT C, A DISTANCE OF 307.18 FEET; THENCE SOUTH 89°54'53" WEST, A DISTANCE OF 80.0 FEET; THENCE CONTINUE SOUTH 89°54'53" WEST, A DISTANCE OF 74.80 FEET; THENCE SOUTH 0°05'07" EAST, A DISTANCE OF 124.49 FEET TO THE POINT OF CURVATURE OF A CURVE CONCAVE TO THE NORTHWEST WITH A RADIUS OF 45.0 FEET; THENCE SOUTHERLY, SOUTHWESTERLY AND WESTERLY ALONG THE

88025FX-5
SHEET 2 OF 3
JUNE 28, 1994

ORB 8796 Pg 4/3

ARC OF SAID CURVE, THROUGH A CENTRAL ANGLE OF 89°23'35", A DISTANCE OF 70.21 FEET TO THE POINT OF TANGENCY; THENCE SOUTH 89°18'28" WEST, A DISTANCE OF 260.07 FEET; THENCE CONTINUE SOUTH 89°18'28" WEST, A DISTANCE OF 16.0 FEET TO THE POINT OF BEGINNING; THENCE CONTINUE SOUTH 89°18'28" WEST, A DISTANCE OF 50.51 FEET; THENCE NORTH 45°41'32" WEST, A DISTANCE OF 9.43 FEET; THENCE SOUTH 89°18'28" WEST, A DISTANCE OF 9.65 FEET; THENCE SOUTH 44°18'28" WEST, A DISTANCE OF 9.43 FEET; THENCE SOUTH 89°18'28" WEST, A DISTANCE OF 45.50 FEET; THENCE NORTH 66°35'52" WEST, A DISTANCE OF 36.74 FEET; THENCE SOUTH 89°18'28" WEST, A DISTANCE OF 243.08 FEET; THENCE SOUTH 0°41'32" EAST, A DISTANCE OF 74.80 FEET; THENCE NORTH 89°18'28" EAST, A DISTANCE OF 248.08 FEET; THENCE SOUTH 58°11'17" EAST, A DISTANCE OF 27.91 FEET; THENCE NORTH 89°18'28" EAST, A DISTANCE OF 124.0 FEET; THENCE NORTH 0°41'32" WEST, A DISTANCE OF 74.80 FEET TO THE POINT OF BEGINNING.

CONTAINING: 3.025 ACRES MORE OR LESS.

88025FX-5
SHEET 3 OF 3
JUNE 28, 1994

ORB 8796 Pg 445

Exhibit "D"

-to-

**DECLARATION OF CONDOMINIUM
OF
LUCENTE VILLAGE "B", A CONDOMINIUM**

ADJACENT PROPERTY

ORB 8796 Pg 446
COROTHY H. WILKEN, CLERK PB COUNTY, FL

NICK MILLER, INC.
Surveying
Planning & Development Consultants

EXHIBIT "F"
DESCRIPTION OF ADJACENT PROPERTY TO LUCENTE VILLAGE

TRACT C OF PLATINA PLAT No. 1, AS RECORDED IN PLAT BOOK 63, PAGES 83 THROUGH 85 OF THE PUBLIC RECORDS OF PALM BEACH COUNTY, FLORIDA, LESS THE FOLLOWING DESCRIBED PARCEL:

BEGINNING AT THE SOUTHEAST CORNER OF TRACT C OF PLATINA PLAT No. 1, AS RECORDED IN PLAT BOOK 63, PAGES 83 THROUGH 85 OF THE PUBLIC RECORDS OF PALM BEACH COUNTY, FLORIDA, SAID SOUTHEAST CORNER BEING THE INTERSECTION OF THE EAST LINE OF SAID TRACT C WITH THE NORTH LINE OF TRACT B-2 AS SHOWN ON PLATINA PLAT No. 1; THENCE NORTH 0°05'07" WEST ALONG SAID EAST LINE OF TRACT C, A DISTANCE OF 390.08 FEET; THENCE SOUTH 89°54'53" WEST, A DISTANCE OF 121.0 FEET; THENCE SOUTH 0°05'07" EAST, A DISTANCE OF 68.98 FEET; THENCE SOUTH 89°54'53" WEST, A DISTANCE OF 53.80 FEET; THENCE SOUTH 0°05'07" EAST, A DISTANCE OF 138.41 FEET TO THE POINT OF A CURVATURE OF A CURVE CONCAVE TO THE NORTHWEST WITH A RADIUS OF 25.0 FEET; THENCE SOUTHERLY, SOUTHWESTERLY AND WESTERLY ALONG THE ARC OF SAID CURVE, THROUGH A CENTRAL ANGLE OF 89°23'25", A DISTANCE OF 39.01 FEET TO THE POINT OF TANGENCY; THENCE SOUTH 89°18'28" WEST, A DISTANCE OF 318.30 FEET; THENCE NORTH 45°41'32" WEST, A DISTANCE OF 9.43 FEET; THENCE SOUTH 89°18'28" WEST, A DISTANCE OF 26.22 FEET; THENCE SOUTH 44°18'28" WEST, A DISTANCE OF 9.43 FEET; THENCE SOUTH 89°18'28" WEST, A DISTANCE OF 32.95 FEET; THENCE NORTH 66°35'52" WEST, A DISTANCE OF 36.74 FEET; THENCE SOUTH 89°18'28" WEST, A DISTANCE OF 214.24 FEET TO THE POINT OF CURVATURE OF A CURVE CONCAVE TO THE NORTHEAST WITH A RADIUS OF 25.0 FEET; THENCE WESTERLY, NORTHWESTERLY AND NORTHERLY ALONG THE ARC OF SAID CURVE, THROUGH A CENTRAL ANGLE OF 90°43'35", A DISTANCE OF 39.59 FEET TO THE POINT OF TANGENCY; THENCE NORTH 0°02'03" EAST, A DISTANCE OF 62.64 FEET; THENCE NORTH 88°34'05" WEST, A DISTANCE OF 50.01 FEET; THENCE NORTH 89°57'57" WEST, A DISTANCE OF 52.50 FEET; THENCE SOUTH 0°02'03" WEST ALONG THE EAST RIGHT OF WAY LINE OF PLATINA AVENUE AS SHOWN ON SAID PLATINA PLAT No. 1, A DISTANCE OF 35.0 FEET; THENCE SOUTH 10°28'57" EAST ALONG SAID EAST RIGHT OF WAY LINE, A DISTANCE OF 82.18 FEET; THENCE SOUTH 0°02'03" WEST ALONG SAID EAST RIGHT OF WAY LINE, A DISTANCE OF 149.30 FEET; THENCE NORTH 89°18'28" EAST ALONG THE SOUTH LINE OF SAID TRACT C AND NORTH LINE OF SAID TRACT B-2, A DISTANCE OF 951.48 FEET TO THE POINT OF BEGINNING.

CONTAINING: 23.236 ACRES MORE OR LESS.

88025FX-2
JUNE 28, 1994