

2011 GUIDE TO TOWING

A Supplement to **TRAILER
LIFE**

HUNDREDS OF LISTINGS!



Tow-Vehicle Selection
Hitching Basics
Trailer-Brake Controls
Towing Tips

It's simple.
**BURN LESS
FUEL.**
Burn less cash.



3.7L | 5.0L | 6.2L | **ECO**
BOOST™**
4 NEW ENGINES



Best-in-class fuel economy*
23 highway mpg. More go. More green.

This is the future of truck
THE NEW 2011 F-150

FIND OUT MORE AT **FORD.COM**

Ford Motor Company, go to www.trailerlife.com/info

*EPA-estimated 17 city/23 highway/19 combined mpg, 3.7L V6 4x2. Class is Full-Size Pickups under 8,500 lbs. GVWR, non-hybrid. **Available early 2011.



EDITORIAL

PUBLISHER
BOB LIVINGSTON

EDITOR
KRISTOPHER BUNKER

SENIOR MANAGING EDITOR
MARLEEN CANNIFF

ASSOCIATE EDITOR
MEAGHAN ALFIER

**CREATIVE
ART DIRECTOR**
MIRANTE ALMAZAN

EDITORIAL/BUSINESS OFFICE
2575 VISTA DEL MAR DRIVE, VENTURA, CA 93001
■ TEL. (805) 667-4100 ■ FAX (805) 667-4484

**ADVERTISING
Ventura, California**
VP/NATIONAL SALES
TERRY THOMPSON

BUSINESS MANAGER
DENIELLE STERNBURG

P.O. Box 8510, VENTURA, CA 93002
■ TEL. (805) 667-4100 ■ FAX (805) 667-4379

Elkhart, Indiana
MIDWEST SALES DIRECTOR
CHUCK LASLEY

NATIONAL ADVERTISING SALES
TACY HENDERSHOT

NATIONAL ADVERTISING SALES
LOU CIRELLI

2901 E BRISTOL STREET, SUITE D, ELKHART, IN 46514
■ TEL. (574) 262-4728 ■ FAX (574) 262-4798

Seattle, Washington
NATIONAL ADVERTISING SALES
SCOTT OAKES, JOHN MARCIANO

1818 WESTLAKE AVENUE N, #420
SEATTLE, WA 98109
■ TEL. (206) 283-9545 ■ FAX (206) 283-9571

Detroit, Michigan
CROMPTON HOLDINGS
SCOTT CROMPTON
2031 FERNWAY DRIVE
MONTGOMERY, AL 36111
■ TEL. (334) 613-2040 ■ FAX (334) 356-7740

TRAILER LIFE IS A REGISTERED TRADEMARK OF AFFINITY GROUP INC. COPYRIGHT 2011 BY AFFINITY GROUP INC. ALL RIGHTS RESERVED. **TRAILER LIFE** (USPS #454-970) IS PUBLISHED MONTHLY BY AFFINITY GROUP INC. SUBSCRIPTION PRICE, U.S. AND POSSESSIONS: 1 YEAR, \$15.97; 2 YEARS, \$27.97. ALL OTHER COUNTRIES, ADD \$12 PER YEAR.

FOR MORE INFORMATION, VISIT OUR WEBSITE AT
www.trailerlife.com

**2011 Guide to
Towing Sponsors**
Ford Motor Company
(800) 392-3673
www.ford.com
KZRV LP
(800) 768-4016
www.kzrv.com

Special thanks to:
Lake Casitas Recreation Area,
(805) 649-2233,
www.casitaswater.org

CONTENTS

6 Choosing the Correct Tow Vehicle

Selecting the tow vehicle that works best for your needs requires careful consideration and a bit of research

10 Towing 2011

Many popular tow vehicles get an upgrade — including a major overhaul on the Ford F-150 powertrain

14 How to Use This Guide

16 2011 Tow Ratings Guide

28 Hitching Basics

An examination of hitch types, their uses and tried-and-true maintenance techniques

33 Trailer-Brake Control

Latest technology improves safety, reliability and stopping power

36 Towing Packages

There's much more to it than a hitch ball and electrical umbilical cord

40 Towing Tips

Plenty of patience, practice and defensive driving will benefit you while on the road



Why our customers *“Come Home to KZ”..*

Some RV manufacturers are only interested in numbers. At KZ, we're interested in **our customers**. They know us, and we know them. They know we produce **high quality** vehicles and we stand behind them with **integrity** and one of the best warranty programs in the industry. Most importantly, KZ customers know that we **respect** and will always support them. Our success isn't possible without your satisfaction.

KZ and you
worth coming home to.



Visit us on the web at www.kz-rv.com

K-Z Inc., go to www.trailerlife.com/info



CHOOSING THE CORRECT TOW VEHICLE

Keeping within manufacturer-assigned tow ratings is critical in making the appropriate model and option choices

BY DUNCAN O'NEAL

So, you want to tow a trailer? There are many variables to consider when selecting the proper tow vehicle for your application — including budget, brand and towing capacity — and it's important to examine them all carefully before making a purchase. Going through the effort to better understand each variable and to account for all of them up front will lead to a more pleasant trailering experience.

Weight

The tow-ratings guide in this section lists the maximum tow ratings for vehicles with specific equipment, but many buyers interpret the maximum vehicles' tow ratings with far too much optimism. Always check the manufacturer's figures before making a purchase. The following is an explanation of the terms you need to know which, when combined with readings from a public scale and from your

own calculator, should help you determine the correct tow rating for the tow vehicle you plan to buy.

Gross Combination Weight Rating (gcwr): The total allowable weight of the tow vehicle, the trailer, the cargo in each, fluids and occupants.

Gross Vehicle Weight Rating (gvwr): The total allowable weight for the vehicle, including occupants, fluids, options, hitch hardware, cargo and trailer-hitch weight.

Gross Axle Weight Rating (gawr): The total allowable weight on an individual axle. This includes the weight of the tires, wheels, brakes and the axle itself.

Maximum Tow Rating: The manufacturer's weight limit for towed loads. For conventional trailers, this normally includes a hitch-weight limit as well; for fifth-wheels, the pin weight is applied to the truck's gvwr and its rear-axle gawr.



MANUFACTURED BY/FABRIQUÉ PAR: KZRV, LP SHPSHEWANA, IN DATE: 11/2010
GVWR/PNBV: 3591 KG (7900 LB)
GAWR (EACH AXLE) / PNBE (CHAQUE ESSEU) 2000 KG (4400 LB) TIRE/PNEU 5T2Z5/75R15 D
RM/JANTE 15 X 6 JJ
COLD INFL. PRESS. /PRESS. DE GONFL. À FROID: 448 KPA (65 PSI/LPC)
THIS VEHICLE CONFORMS TO ALL APPLICABLE U.S. FEDERAL MOTOR VEHICLE SAFETY STANDARDS IN EFFECT ON THE DATE OF MANUFACTURE SHOWN ABOVE. THIS VEHICLE CONFORMS TO ALL APPLICABLE STANDARDS PRESCRIBED UNDER CANADIAN MOTOR VEHICLE SAFETY REGULATIONS IN EFFECT ON THE DATE OF MANUFACTURE. - CE VÉHICULE EST CONFORME À TOUTES LES NORMES QUI LUI SONT APPLICABLES EN VERTU DU RÈGLEMENT SUR LA SÉCURITÉ DES VÉHICULES AUTOMOBILES DU CANADA EN VIGUEUR À LA DATE DE SA FABRICATION.
TYPE/TYPE DE VÉHICULE: TRAILER TRA/REM TRA

Matching up the Tow Vehicle and Trailer



The gvwr and gawr for all motor vehicles are listed on the data plate, typically affixed to the driver's door frame, fuel door, glove box, end of the dashboard or other easy-to-access location. Brochures and window stickers may be inaccurate; always look for the data plate. All trailers should have a weight sticker on the left front side wall. There should also be a sticker in an interior cabinet that lists the trailer's unloaded vehicle weight (uvw), gvwr, weight added by freshwater and LP-gas and the resulting cargo carrying capacity (ccc).

In many cases, especially on older trailers, optional equipment — such as air-conditioning units and AC-generators — sneaks onboard after weighing, and may not be reflected on the sticker. (And don't forget the fuel-fill tanks that some SURVs offer for campsite refueling of motorcycles and ATVs.)

Recreational Vehicle Industry Association (RVIA) weight label requirements are more inclusive of dealer-added options and make it much easier for buyers to have access to more accurate weight figures.

The gvwr figures are neither guidelines nor estimates; they are limits, and there are numerous valid reasons the manufacturer arrived at these figures. If you think the figures are "close enough" or have a fudge-factor percentage built in, think again. Your warranty coverage, and your safety, may be at risk.

The only surefire way to find out what your trailer weighs is to load it as usual for a trip and weigh it at a public scale. There you can get the hitch weight, axle weight and total weight. Assuming that the axle weight is lower than the gawr, the total is within the gvwr and the hitch weight is lower than the maximum given for your tow vehicle, you can then move on to tow-vehicle selection.

When purchasing a trailer, consult the weight sticker on the unit of your choice on a dealer's lot and refer to the uvw and ccc.

Estimate how much cargo you will add, being mindful of the gvwr, and use that number while selecting a tow vehicle.

To a lesser extent, tow-vehicle weight is variable as well. Brochures and tow guides frequently list how much a tow vehicle weighs, but this number generally applies to the most basic model in that configuration, without any options. In some cases, distinctions are made by engine, transmission, drive system (2WD or 4WD/AWD) and, in other cases, by cab or bed styles. If the dealer does not have a vehicle equipped as you want that is available to weigh, or cannot provide option weights, you can form rough estimates — but exact figures are the only way to be certain.

Bigger engines add weight, diesels more so because they come with additional accessories (up to 700 pounds more than the standard gas engine is common). Add up to 175 pounds for an optional transmission, about 400 pounds for 4WD and a bit less than 300 pounds for longer beds. Then add other options like luxury-trim levels, as all those electric motors add up. The towing package and hitch could add another 100 pounds, and larger wheels and tires can also have an effect.

Following is how to calculate the realistic towing capacity of a vehicle. For example, consider a fictional one-ton longbed, diesel, extended-cab, 2WD, single-rear-wheel pickup

set up for towing. We'll arbitrarily assign it a gvw of 9,900 pounds, a front gawr of 5,000 pounds, a rear gawr of 6,824 pounds, a gcwr of 23,000 pounds and a quoted maximum tow rating of 17,000 pounds.

As is often the case in single-rear-wheel trucks, the rear axle's gawr on this truck is derived from each tire's maximum load of 3,412 pounds. Pickups such as this normally start at more than 6,000 pounds, and with a diesel, automatic and nice trim, figure that with a full tank of fuel and hitch, this unit weighs at least 7,000 pounds. If we add two "standard-size" people (154 pounds each), a few tools and some cargo, it weighs 7,500 pounds. That is split to 4,000 pounds on the front axle, and 3,500 pounds on the rear axle.

The first thing you should have noticed is that the maximum tow rating cannot apply with the truck fully loaded because gcwr (23,000) minus gvw (9,900) leaves 13,100 pounds — about 4,000 pounds less than quoted towing ability. After adding options and people to the example truck, and subtracting that value (7,500) from gcwr (23,000), the effective working tow rating of the truck becomes 15,500 pounds, about 1,500 pounds less than the truck's quoted maximum towing rating.

However, you have yet to check all the numbers and verify that a 15,500-pound trailer will work. If that trailer is a fifth-wheel and has 20 percent of its weight on the pin, that adds 3,100 pounds to the back of the truck. This would make the truck overweight — its 7,500-pound ready-to-roll weight plus the 3,100 pounds on the pin equals 10,600 pounds — 700 pounds more than the truck's gvw, and just 224 pounds shy of the rear-axle limit of 6,824 pounds.

SUVs and other non-pickup tow rigs cannot escape scrutiny. The vehicle's loaded weight, with the anticipated load of passengers aboard, must be subtracted from the gcwr to determine the realistic tow rating.

Other Factors

The tow-ratings chart lists vehicle-towing maximums segregated by engine, cab style, drive and single- or dual-rear wheels as appropriate. In general, assume the maximum tow rating always requires a towing package — and special towing equipment (see "Towing Packages," beginning on page 36) — and the highest numerical axle ratio offered, and as the example shows, maximums can be confusing. You can do your own estimates by starting with the information given and keeping the following generalizations in mind.



Transmission: For the majority of vehicles, automatic transmissions offer the higher tow ratings when they vary by transmission. On heavy-duty (HD) models, the difference may be 1,000 pounds or less, and on lighter-duty vehicles, a manual tranny might rate a 2,000-pound lower tow rating. Exceptions include high-output engines that are available only with manual gearboxes, vehicles where the manual transmission weighs more than the automatic and transmissions in vehicles designed for high performance and not towing.

Axle Ratio: Lower gearing (the numerically higher ratios, e.g. 4.10:1, 4.56:1, as opposed to 3.31:1, 3.42:1), typically produces greater tow ratings because of greater torque multiplication. There is a wide variance in the axle ratio's effect on the tow rating, with some diesel-powered pickups varying only a few hundred pounds. On others, changing from a 3.73:1 to a 4.30:1 sometimes increases the tow rating by 3,500 pounds. In the past, some ratings have increased by a factor greater than three (from 2,000 to 7,100 pounds) simply by using a different axle ratio. Lower gearing will also make your vehicle accelerate quicker up to 50-55 mph. In general, a one-step drop in axle ratio (4.10:1 to 3.73:1) on an HD pickup will drop tow rating and gcwr by a ton.

Lower gearing has an adverse effect on fuel economy, but it's usually not proportional to the gain in towing ability. Under the best circumstances, the difference between the highest and lowest gear ratios offered (say, 3.42:1 and 4.10:1) results in a 1.5-mpg decrease in non-towing, steady state-highway cruising. In most conditions that change is less than 1 mpg, and if you tow a relatively heavy trailer a lot, there's no question that the lowest gearing is best.

Drive System: Vehicles that drive only two wheels, be they front or rear, generally have higher tow ratings (all other things being equal). Even though modern 4WD and AWD systems are quite efficient, a small amount of



parasitic loss uses up energy. More importantly, 4WD systems add weight — easily up to 400 pounds on some HD pickups — and that weight frequently comes off the tow rating. Unless the gcwr and gwwr are higher, a 4WD version will probably tow a few hundred pounds less than its 2WD counterpart.

Towing Package: If you can order a towing package, do so. Not only is it usually required to get the top tow rating, but the contents rarely can be duplicated for the original cost — and it will add to resale value. You can plainly see the hitch receiver or electrical receptacle, but there are often other changes to the wiring system (including up-rated wire and fuses), alternator, battery, cooling system, power steering and lubricants. In some cases, integrated brake controllers are also offered.

Bed Length/Style: If there's a difference, a longbed truck may rate slightly lower in tow capacity — about 150-250 pounds — because the longer bed adds weight. In other cases there is no change because the longer wheelbase is beneficial. Note that the more "styled" beds marketed under a variety of names typically are heavier than conventional slab-sided



beds, and that cab-and-chassis figures do not reflect any bed unless otherwise noted. A steel bed for a medium-duty cab-and-chassis could quickly eat up an entire ton of its gcwr.

Single or Dual Rear Wheels: Most people assume that a dually pickup will have a higher tow rating than a single-rear-wheel unit, but this is not always so. In many cases the gcwr is limited by factors other than the number of rear wheels and does not change, and in those cases the weight of the wider axle, bigger brakes and two more tires and wheels is subtracted from the gcwr. The dually no doubt provides a more stable towing platform for the heavier trailers, although not always with the highest tow rating. A dually will have a higher gwwr because the dual-wheel rear axle might have a 10,000-pound gawr, for example, compared to the single-rear-wheel truck's 6,824-pound gawr. Gawr is not always an exact calculation of the tire capacity times the number of tires. A dually-equipped truck will be better for hauling a heavy slide-in truck camper and handling heavy fifth-wheel pin weights because of the weight concentrated on the rear axle as compared to the conventional trailer's hitch weight.

Tires: Wheel sizes continue to grow commensurate with their popularity, with some tow vehicles offering 20-inch wheels as factory options. However, using a larger wheel and lower-profile tire means a smaller air cushion and lower tire sidewall, to the extent that tow ratings generally drop whenever the wheel size increases — and ride comfort can be compromised. Read the fine print on the packaging carefully.

Research

Before purchasing any vehicle for towing, ensure that the equipment required is available for your vehicle. You may find that the new-kid-on-the-block is a very capable tow vehicle, but no one makes a fifth-wheel hitch for it. (Ford remedied this quandary on 2011 Super Duty trucks; GM also offers the option). Also beware of hitch-ball and receiver ratings, as some trucks are rated for heavier loads than any easily found hardware can handle, and therefore may require special-order parts.

Before purchasing a vehicle, we suggest you acquire the manufacturer's comprehensive towing guide, available online or at dealerships. Be sure to read the fine print because in many cases the maximum rating may apply only to one particular version and be for a fifth-wheel trailer; many larger pickups may have their actual tow rating limited by the hitch and hardware. 🚚

TOWING 2011

It's been a rocky few years, but the automotive industry is coming back — and bringing some exciting tow vehicles with it

BY CHRIS HEMER

Like the housing market, Wall Street and the fashion industry, the automotive industry has memorable years, and some we'd rather not recall.

It's as cyclical as hurricane season — uneventful one year, tumultuous the next — but having weathered one of the worst economic storms in modern history, it appears the skies are clearing. The Big Three are once again in contention for bragging rights in the heavy-duty truck segment, and there are many new models and powertrains to talk about — including some exciting power upgrades for Ford's F-150 pickups. Indeed, if you've been waiting for the "right" year to buy a new tow vehicle, 2011 is it.

Ford

America's best-selling truck, the venerable Ford F-150, has undergone the most extensive powertrain overhaul in its 62-year history. Consisting of an all-new 3.7-liter V-6 (302 hp), 5.0-liter and 6.2-liter V-8s (360 hp and 411 hp, respectively), Ford claims the engines offer best-in-class power and fuel economy.

That includes the new twin-turbocharged EcoBoost 3.5-liter V-6 option, which delivers



365 hp and 420 lb-ft of torque. The EcoBoost uses direct-fuel injection twin independent variable cam timing (Ti-VCT) to produce torque early on, with a broad plateau. The EcoBoost is capable of towing 11,300 pounds — as is Ford's co-class-leading 6.2-liter engine.

Each new engine will be mated to an equally new six-speed automatic transmission with an available SelectShift feature that allows the driver to manually select a desired gear, and "progressive range select" which allows the driver to lock out the available gears while in Drive.

Also new is the available 4.2-inch in-dash LCD display productivity screen, which includes helpful and informative menus on a variety of



10 | 2011 TRAILER LIFE Towing Guide



vehicle-related topics, most notably trailer towing. The trailer-towing menu allows users to name a particular trailer in order to track mileage, as well as to store the integrated trailer-brake control settings on the instrument panel. Combined with the menu's info on the tow/haul mode and even a handy trailer-connection checklist, the F-150 is striving to be the most trailer-friendly vehicle on the market.



The Super Duty is also all-new for 2011, highlighted by a Ford-designed, Ford-engineered and Ford-built 6.7-liter Power Stroke diesel that delivers 800 lb-ft of torque at 1,600 rpm and 400 hp at 2,800 rpm — 150 lb-ft and 50 hp more than the previous engine. Ford also claims best-in-class fuel economy, and biodiesel compatibility up to B20. The all-new 6.2-liter gas engine also boasts best-in-class grunt with 385 hp and 405 lb-ft of torque in this application, which is 85 more horses and 40 lb-ft more than the 5.4-liter Triton V-8 it replaces. Both engines are backed by an all-new TorqShift six-speed automatic

transmission. The new powertrains, along with a robust chassis, bestow the Super Duty with a class-leading towing capacity of 24,400 pounds and best-in-class payload capacity of 7,070 pounds. No new truck would be complete without a raft of tech features, and the Super Duty's got those, too. Hill start assist, hill descent control, an electronic locking rear differential and side airbags/air curtains are among the truck's standard and available equipment.



The SUV that started it all, the Explorer, is also (finally) all-new for 2011. Handsome styling is combined with reduced weight, improved driving dynamics and increased off-road capability, not to mention a new, standard 3.5-liter V-6 with Ti-VCT and a six-speed automatic transmission. The use of Ti-VCT allows individually optimized camshaft timing of valve opening and closing events to improve mechanical efficiency while delivering increased power and reducing part-throttle emissions, according to Ford. Combined with the new transmission, Ford projects that the new engine will deliver more than 20 percent better fuel economy than the previous Explorer V-6 model, all while laying down 290 hp and 255 lb-ft of torque. V-6 models are available with an intelligent 4WD that includes driver-selectable terrain management. Settings include Normal, Mud, Sand and Snow. For



those who consider fuel economy a priority, the Explorer is also available with a turbo-charged and intercooled 2.0-liter EcoBoost engine that employs direct injection as well as Ti-VCT to deliver a projected 237 horsepower and 250 lb-ft of torque.

Dodge/Jeep



After a year's absence, Dodge re-enters the SUV fray with an all-new Durango. And by all-new, we mean the whole shootin' match — exterior, interior and a new standard engine: a 3.6 Pentastar V-6. With a bold new front fascia that shares design cues with other Dodge products like the Charger and Challenger, the Durango is also available with the venerable 5.7-liter Hemi V-8 with fuel saving Multi Displacement System. An elegant new interior was designed by the same studio that created the interiors in the new Ram trucks and all-new Jeep Cherokee (more on that later). In total, the Durango offers consumers 45 safety and security features, including standard front seat-mounted side air bags, standard side-curtain air bags and all-new standard active head restraints. Electronic Stability Control is also standard. Other available safety and security technologies include Blind-spot Monitoring, Rear Cross Path detection, Forward Collision Warning, Adaptive Cruise Control and Keyless Enter-N-Go.



The Dodge Ram we're all familiar with is now just known as Ram — Chrysler Corporation has elected to make it a separate brand, like Chrysler and Jeep. A new addition to the lineup is the Outdoorsman trim level, which reportedly takes all of the features most useful to hunters, fishermen, campers and boaters and bundles them into one model. Outdoorsman trim is available in 1500, 2500/3500 HD single rear wheel, Regular Cab, Quad Cab,

Crew Cab and Mega Cab; four-wheel drive and two-wheel drive; short- and long-wheel-base models. It will replace the TRX4 trim level in the 2011 Ram Truck lineup. Some noteworthy features include heavy-duty cooling, a Class IV hitch receiver, limited-slip differential, trailer-sway control (1500 only), fog lights and remote start. New features across the Ram lineup include power folding mirrors, an available factory spray-in bedliner and Garmin navigation. Ram 2500, 3500, 4500 and 5500 Chassis Cabs, meanwhile, receive numerous revisions for 2011, including an all-new Crew cab, updated exterior styling, a standard exhaust brake, the largest standard fuel tank (52 gallons) and more.



We touched on it last year — and by now, you've likely seen the commercials. The Jeep Grand Cherokee is all-new for 2011 and is chock full of features that make it more capable on and off road. Three 4 x 4 systems are offered, along with a new Jeep Selec-Terrain system with five terrain settings and a Quadra-Lift air suspension system with five height settings for a lift range of 4.1 inches. The new Pentastar 3.6-liter V-6 and 5.7-liter Hemi engines are offered, along with more than 45 safety and security features including electronic stability control, side-curtain and seat-mounted side air bags and active head restraints. Optional safety features include a Blind Spot Monitoring/Rear Cross Path detection system, Adaptive Cruise Control and forward collision monitoring. Of course, the new Grand Cherokee is also offered with a variety of convenience and entertainment features, such as Bluetooth hands-free calling and streaming audio, Uconnect Web, FLO TV and Sirius Backseat TV.

General Motors

Not to be outdone, GM has redesigned its HD line-up and made it broader than ever, with 10 2500 HD models and eight single/dual rear wheel 3500 HD models, including a new 3500HD Crew Cab with a 6.5-foot bed. New, fully boxed frames and tougher suspensions contribute to a towing capacity of up to 21,700 pounds, a payload of up to 6,335 pounds, and improved ride quality. A revised



6.6-liter Duramax develops a best-in-class 397 hp and 765 lb-ft of torque, is B20 compatible and features a new “smart” exhaust brake for greater control when descending grades. Brake performance and feel have been improved courtesy of 14-inch rotors front and rear, and safety/convenience features have been added to single-rear-wheel models, including StabiliTrak stability control, trailer-sway control and hill-start assist.

On the GMC side, a Denali HD is being offered for the first time. Available in the 2500 series 2WD and 4WD configurations, as well as the 3500 Series 2WD and 4WD in both single-rear-wheel and dually versions (standard or long box), the Denali HD comes equipped with a Vortec 6.0-liter gas engine and six-speed automatic, with the 6.6-liter Duramax diesel and Allison 1000 offered as an option. From a visual standpoint, the Denali distinguishes itself with a four-bar chrome grille, body-color bumpers, chrome door handles and either 17- (dually) 18 or 20-inch polished forged aluminum wheels. Inside, the Denali HD features Denali-specific brushed aluminum trim, power-adjustable pedals, a Bose premium surround audio system and 12-way power seats. A heated steering wheel and heated/cooled leather appointed seats are optional. Like other Denali models, the color selection is limited, and includes Black, Stealth Gray and White.

Toyota

Toyota's tow ratings have been lowered on some models this year due to a new SAE towing regulation called SAE J2807. SAE J2807 establishes a new standard to determine the tow rating of all tow vehicles and defines the performance requirements for determining both the gross combination weight rating (gcwr) and tow rating. It isn't scheduled to go into effect until the 2013 model year, but Toyota put the new standard into effect early — hence some tow ratings are lower than last year's (see the article about the new SAE regulations in *Trailer Life*, February 2011).

That said, Toyota has streamlined the Tundra full-size pickup line for 2011, focusing on



the 28 most in-demand configurations. In addition, the Tundra's base 4.0-liter V-6 engine gains Dual Variable Valve Timing with intelligence (VVT-i) for 2011, increasing power and performance. The 310-hp 4.6-liter and 381-hp 5.7-liter V-8s continue across the Tundra line. The midsize Tacoma is offered with limited production T|X and T|X Pro Packages on V-6 Access Cab or V-6 Double Cab models with the TRD Off-Road Package. The T|X package adds TRD 16-inch black alloy bead-lock wheels and 265/70R16 BF Goodrich Rugged Trail tires, black tube side steps, a stainless-steel exhaust tip and unique exterior graphics. T|X Pro takes the performance envelope further with a TRD cat-back performance exhaust system.

Before last year's guide went to press, the industry barely had information about the all-new 2010 4Runner — and now it's in its second model year. That's the auto business for you. Now in its fifth generation, the 4Runner features truck-style body-on-frame construction, a standard 270-hp V-6 engine and your choice of 2WD, part-time 4WD or full-time, multi-mode 4WD with a locking center differential. Riding on the same platform as the capable FJ Cruiser, the 4Runner comes standard with A-TRAC traction control, and offers technologies previously reserved for the top-shelf Land Cruiser, such as Kinetic Dynamic Suspension and Crawl Control (Trail Grade model). With the transfer case shifted into low range, Crawl Control regulates engine speed and output, along with braking force, to make traversing difficult terrain easier and safer. The Trail Grade model also features a Multi-Terrain Select system that dials in wheel slip control to match the terrain. All 4Runner 4 × 4 models feature standard Downhill Assist Control and Hill Start Assist. 

HOW TO USE THIS GUIDE

F-250/F-350/F-450 Super Duty, Fifth-Wheel Towing		
F-250/350 Reg. Cab SRW 2WD	6.2L V-8	12,700 (i)
F-250/350 Reg. Cab SRW 2WD	6.2L V-8	15,700 (i)
F-250/350 Reg. Cab SRW 2WD	6.7L V-8 TD	16,500 (all)
F-250/350 Reg. Cab SRW 4WD	6.2L V-8	12,200 (i)
F-250/350 Reg. Cab SRW 4WD	6.2L V-8	15,200 (i)
F-250/350 Reg. Cab SRW 4WD	6.7L V-8 TD	16,100 (all)
F-350 Reg. Cab DRW 2WD	6.2L V-8	12,700 (i)
F-350 Reg. Cab DRW 2WD	6.2L V-8	15,700 (i)
F-350 Reg. Cab DRW 2WD	6.7L V-8 TD	22,600
F-350 Reg. Cab DRW 4WD	6.2L V-8	12,200 (i)
F-350 Reg. Cab DRW 4WD	6.2L V-8	15,200 (i)
F-350 Reg. Cab DRW 4WD	6.7L V-8 TD	22,100
F-350 Reg. Chassis Cab DRW 2WD	6.7L V-8 TD	15,000 (i/k)
F-350 Reg. Chassis Cab DRW 4WD	6.2L V-8	11,800 (i)
F-350 Reg. Chassis Cab DRW 4WD	6.2L V-8	14,800 (i)
F-350 Reg. Chassis Cab DRW 4WD	6.7L V-8 TD	15,000 (i/k)
F-450 Reg. Chassis Cab DRW 2WD	6.8L V-10	16,000
F-450 Reg. Chassis Cab DRW 2WD	6.7L V-8 TD	16,000
F-450 Reg. Chassis Cab DRW 4WD	6.8L V-10	16,000
F-450 Reg. Chassis Cab DRW 4WD	6.7L V-8 TD	16,000
F-550 Reg. Chassis Cab DRW 2WD	6.8L V-10	16,000
F-550 Reg. Chassis Cab DRW 2WD	6.7L V-8 TD	16,000
F-550 Reg. Chassis Cab DRW 4WD	6.8L V-10	16,000
F-550 Reg. Chassis Cab DRW 4WD	6.7L V-8 TD	16,000
F-350 Super Chassis Cab SRW 2WD	6.2L V-8	12,000 (i)
F-350 Super Chassis Cab SRW 2WD	6.2L V-8	12,500 (i)

Tow ratings for all vehicle manufacturers are listed in alphabetical order, and are organized by model type and configuration. In most instances, you will find a letter (or letters) which identify the equipment that the rating is based on, i.e. automatic or manual transmission, gear ratio, towing package, etc. You will find the meaning for each of these letters in the "Key to Charts" section on page 16.

If there is no letter after the rating, that means there is only one rating available. Likewise, you may find the word "all" in the engine column; that means all available engines are capable of that particular tow rating.

Because each manufacturer lists its vehicles differently, we have found it necessary to make some changes in an effort to keep this guide consistent and concise. For example, Ram trucks are listed with separate tow ratings for each trim level; while we understand that equipment adds weight and

therefore reduces towing capacity, we simply don't have room to publish separate ratings based on a 50-pound weight difference.

Likewise, GM doesn't have separate conventional and fifth-wheel tow ratings, and instead simply indicates a separate rating for models that are equipped to tow a fifth-wheel. So in the GM section, you'll note that some models have two ratings separated by a slash; the first rating is for conventional towing, the second is for fifth-wheel towing.

Where applicable, we've also included relevant manufacturer's notes for a particular vehicle or model line, but always check with your dealer for details on the model you plan to purchase, including tow rating, payload capacity, gross vehicle weight rating (gvwr), gross combined weight rating (gcwr) and gross axle weight ratings (gawr). 🚚



SAVING PEOPLE MONEY

on more than just car insurance.SM

Your RV policy could even include:

- **Multi-Policy Discount** when you insure your car and your other vehicles with GEICO
- **Vacation Liability** for others that may be injured in your RV or campsite
- **Emergency Expense Allowance** to cover temporary living expenses after an accident



GEICO[®]

Call 1-877-434-2678 today or visit your local office.

Motorcycle and ATV coverages are underwritten by GEICO Indemnity Company. Boat and PWC coverages are written through non-affiliated insurance companies and are secured through the GEICO Insurance Agency, Inc. Some discounts, coverages, payment plans and features are not available in all states or all GEICO companies. Government Employees Insurance Co. • GEICO General Insurance Co. • GEICO Indemnity Co. • GEICO Casualty Co. These companies are subsidiaries of Berkshire Hathaway Inc. GEICO: Washington, DC 20076. © 2011 GEICO

Geico, go to www.trailerlife.com/info

Go To: **TRAILER**
LIFE.com

User Guide

Contents

TRAILER TOW RATING

COMPILED BY CHRIS HEMER

Key to Charts

a = Automatic transmission
a4 = Automatic transmission, Four Speeds
a5 = Automatic transmission, Five Speeds
a6 = Automatic transmission, Six Speeds
m = Manual transmission
m5 = Manual transmission, Five Speeds
m6 = Manual transmission, Six Speeds

b = 3.08:1
c = 3.15:1
d = 3.21:1
e = 3.23:1
f = 3.31:1
g = 3.42:1
h = 3.55:1

i = 3.73:1
j = 3.92:1
k = 4.10:1
l = 4.30:1
n = 4.44:1
o = 4.56:1
q = 4.88:1
r = 5.38:1

p = Cooling or other accessory package required
t = Towing package required

AWD = All Wheel Drive
CC = Crew Cab
CV = Cargo Van
DRW = Dual Rear Wheels

KC = King Cab
LB = Longbed
LWB = Long Wheelbase
NA = Not applicable, or not available
PV = Passenger Van
SB = Shortbed
SC = Supercharged
SRW = Single Rear Wheel
SWB = Short Wheelbase
Std Bed = Standard Bed
TC = Turbocharged
TD = Turbodiesel

A forward slash (/) denotes either/or; a comma indicates more than one footnote applies. No footnote present indicates only one tow rating assigned to that particular vehicle or model.

Vehicle	Engine	Tow Limit (lb)
---------	--------	----------------

ACURA

MDX	3.7L V-6	5,000
-----	----------	-------

AUDI

Q5	All	4,400
Q7	All	5,500*
Q7	3.6L V-6	6,600 (t)

*With dealer installed hitch.

BMW

X3 xDrive28i	3.0L I-6	3,000
X3 xDrive35i	3.0L I-6	3,000
X5 xDrive35i	3.0L I-6	6,000
X5 xDrive50i	4.8L V-8	6,000
X5 xDrive35d	3.0L I-6 TD	6,000
X6 xDrive35i	3.0L I-6	6,000
X6 xDrive50i	4.4L V-8	6,000
X6 Active Hybrid	4.4L V-8	6,000

BUICK

Enclave FWD	3.6L V-6	2,000
Enclave FWD	3.6L V-6	4,500 (t)

CADILLAC

Escalade 2WD	6.2L V-8	8,300
Escalade AWD	6.2L V-8	8,100
Escalade ESV 2WD	6.2L V-8	8,000
Escalade ESV AWD	6.2L V-8	7,700
Escalade EXT AWD	6.2L V-8	7,600
Escalade Two Mode Hybrid 2WD	6.0L V-8	5,800
Escalade Two Mode Hybrid 4WD	6.0L V-8	5,600
SRX AWD	2.8L V-6 TC	3,500
SRX AWD	3.0L V-6	2,500
SRX AWD	3.0L V-6	3,500 (t)
SRX FWD	3.0L V-6	2,500
SRX FWD	3.0L V-6	3,500 (t)

CHEVY/GMC

Avalanche 1500 2WD	5.3L V-8	5,100 (b)
Avalanche 1500 2WD	5.3L V-8	5,600 (g)
Avalanche 1500 2WD	5.3L V-8	8,100 (g,p)
Avalanche 1500 4WD	5.3L V-8	4,900 (b)

LIFE 2011 INGS GUIDE

Avalanche 1500 4WD	5.3L V-8	5,400 (g)
Avalanche 1500 4WD	5.3L V-8	7,900 (g,p)
Traverse/Acadia FWD	3.6L V-6	2,000
Traverse/Acadia FWD	3.6L V-6	5,200 (t)
Traverse/Acadia AWD	3.6L V-6	2,000
Traverse/Acadia AWD	3.6L V-6	5,200 (t)
Colorado/Canyon Reg Cab 2WD	2.9L I-4	3,400 (a,i)
Colorado/Canyon Reg Cab 2WD	2.9L I-4	2,400 (m,i)
Colorado/Canyon Reg Cab 2WD	3.7L I-5	4,000 (a,i)
Colorado/Canyon Ext Cab 2WD	2.9L I-4	3,200 (a,i)
Colorado/Canyon Ext Cab 2WD	2.9L I-4	2,200 (m,i)
Colorado/Canyon Ext Cab 2WD	3.7L I-5	5,500 (a,i)
Colorado/Canyon Ext Cab 2WD	5.3L V-8	6,000 (a,g/i)
Colorado/Canyon Ext Cab 2WD	5.3L V-8	4,000 (a,g)*

*With ZQ8 Sport Suspension.

Colorado/Canyon CC 2WD	2.9L I-4	3,000 (a,i)
Colorado/Canyon CC 2WD	2.9L I-4	2,100 (m,i)
Colorado/Canyon CC 2WD	3.7L I-5	5,500 (a,i)
Colorado/Canyon CC 2WD	5.3L V-8	6,000 (a,g/i)
Colorado/Canyon CC 2WD	5.3L V-8	3,800 (a,g)*
Colorado/Canyon Reg Cab 4WD	2.9L I-4	3,100 (a,i)
Colorado/Canyon Reg Cab 4WD	2.9L I-4	2,100 (m,i)
Colorado/Canyon Reg Cab 4WD	3.7L I-5	4,000 (a,i)
Colorado/Canyon Ext Cab 4WD	2.9L I-4	2,900 (a,i)
Colorado/Canyon Ext Cab 4WD	3.7L I-5	5,500 (a,i)
Colorado/Canyon Ext Cab 4WD	5.3L V-8	6,000 (a,g/k)
Colorado/Canyon CC 4WD	3.7L I-5	5,500 (a,i)
Colorado/Canyon CC 4WD	5.3L V-8	6,000 (a,g/k)
Equinox/Terrain	3.0 V-6	3,500
Express/Savana 1500 SWB CV 2WD	4.3L V-6	4,300
Express/Savana 1500 SWB CV 2WD	5.3L V-8	6,800 (g/i)
Express/Savana 1500 SWB CV AWD	5.3L V-8	6,500
Express/Savana 1500 SWB PV 2WD	5.3L V-8	6,200
Express/Savana 1500 SWB PV AWD	5.3L V-8	6,000
Express/Savana 2500 SWB CV 2WD	4.8L V-8	7,400
Express/Savana 2500 SWB CV 2WD	6.0L V-8	10,000
Express/Savana 2500 SWB CV 2WD	6.6 TD V-8	10,000
Express/Savana 2500 SWB PV 2WD	6.0L V-8	6,700
Express/Savana 2500 SWB PV 2WD	6.0L V-8	9,800
Express/Savana 2500 LWB CV 2WD	4.8L V-8	7,200
Express/Savana 2500 LWB CV 2WD	6.0L V-8	10,000

Express/Savana 2500 LWB CV 2WD	6.6 TD V-8	10,000
Express/Savana 3500 SWB CV 2WD	4.8L V-8	7,400
Express/Savana 3500 SWB CV 2WD	6.0L V-8	10,000
Express/Savana 3500 SWB CV 2WD	6.6 TD V-8	10,000
Express/Savana 3500 SWB PV 2WD	6.0L V-8	9,700
Express/Savana 3500 SWB PV 2WD	6.6 TD V-8	10,000
Express/Savana 3500 LWB CV 2WD	4.8L V-8	7,100
Express/Savana 3500 LWB CV 2WD	6.0L V-8	10,000
Express/Savana 3500 LWB CV 2WD	6.6 TD V-8	10,000
Express/Savana 3500 LWB PV 2WD	6.0L V-8	9,300
Express/Savana 3500 LWB PV 2WD	6.6 TD V-8	10,000

Silverado/Sierra 1500 Reg Cab, Std Bed

1500 Reg Cab Std Bed 2WD	4.3L V-6	4,800 (e)
1500 Reg Cab Std Bed 2WD	4.3L V-6	5,400 (a,i)
1500 Reg Cab Std Bed 2WD	4.3L V-6	4,100 (m,i)
1500 Reg Cab Std Bed 2WD	4.8L V-8	4,700 (e)
1500 Reg Cab Std Bed 2WD	4.8L V-8	7,200 (i)
1500 Reg Cab Std Bed 2WD	5.3L V-8	6,600 (b)
1500 Reg Cab Std Bed 2WD	5.3L V-8	7,400 (b,p)
1500 Reg Cab Std Bed 2WD	5.3L V-8	9,100/9,100 (g,p)
1500 Reg Cab Std Bed 4WD	4.3L V-6	5,100 (i)
1500 Reg Cab Std Bed 4WD	4.8L V-8	6,000 (g)
1500 Reg Cab Std Bed 4WD	5.3L V-8	6,400 (b)
1500 Reg Cab Std Bed 4WD	5.3L V-8	7,100 (b,p)
1500 Reg Cab Std Bed 4WD	5.3L V-8	8,900/8,100 (g,p)

Silverado/Sierra 1500 Ext Cab, Std Bed

1500 Ext Cab Std Bed 2WD	4.3L V-6	4,400 (e)
1500 Ext Cab Std Bed 2WD	4.8L V-8	4,700 (e)
1500 Ext Cab Std Bed 2WD	4.8L V-8	6,700 (i)
1500 Ext Cab Std Bed 2WD	5.3L V-8	6,200 (b)
1500 Ext Cab Std Bed 2WD	5.3L V-8	6,900 (b,p)
1500 Ext Cab Std Bed 2WD	5.3L V-8	9,700/9,200 (g,p)
1500 Ext Cab Std Bed 2WD	6.2L V-8	9,700/9,300 (g,p)
1500 Ext Cab Std Bed 2WD	6.2L V-8	10,700/10,200 (i,t)
1500 Ext Cab Std Bed 4WD	4.8L V-8	5,500 (g)
1500 Ext Cab Std Bed 4WD	5.3L V-8	6,100 (b)
1500 Ext Cab Std Bed 4WD	5.3L V-8	6,800 (b,p)
1500 Ext Cab Std Bed 4WD	5.3L V-8	9,600 (g)
1500 Ext Cab Std Bed 4WD	6.2L V-8	9,400/8,900 (g,p)
1500 Ext Cab Std Bed 4WD	6.2L V-8	10,400/9,900 (i,t)

Silverado/Sierra 1500 CC, Shortbed

1500 CC Short Box 2WD	4.8L V-8	4,700 (e)
1500 CC Short Box 2WD	4.8L V-8	6,700 (i)
1500 CC Short Box 2WD	5.3L V-8	6,100 (b)
1500 CC Short Box 2WD	5.3L V-8	6,800 (h,p)
1500 CC Short Box 2WD (XFE)	5.3L V-8	7,000 (h,p)
1500 CC Short Box 2WD	5.3L V-8	9,600 (g,p)
1500 CC Short Box 2WD	6.2L V-8	6,700 (g)
1500 CC Short Box 2WD	6.2L V-8	9,700 (g,p)
1500 CC Short Box 2WD	6.2L V-8	10,600 (i,t)
1500 CC Short Box 4WD	4.8L V-8	5,500 (g)
1500 CC Short Box 4WD	5.3L V-8	6,000 (b)
1500 CC Short Box 4WD	5.3L V-8	6,700 (h,p)
1500 CC Short Box 4WD	5.3L V-8	9,500 (g,p)
1500 CC Short Box 4WD	6.2L V-8	6,400 (g)
1500 CC Short Box 4WD	6.2L V-8	9,400 (g,p)
1500 CC Short Box 4WD	6.2L V-8	10,400 (i,t)

Sierra Denali CC Shortbed, 1500 2WD and AWD

Sierra Denali CC SB 2WD	6.2L V-8	6,600
Sierra Denali CC SB 2WD	6.2L V-8	9,600 (p)
Sierra Denali CC SB AWD	6.2L V-8	6,400
Sierra Denali CC SB AWD	6.2L V-8	9,400 (p)

Silverado/Sierra 1500 Reg Cab Longbed

1500 Reg Cab LB 2WD	4.3L V-6	4,700 (e)
1500 Reg Cab LB 2WD	4.3L V-6	5,200 (i)
1500 Reg Cab LB 2WD	4.8L V-8	5,100 (e)
1500 Reg Cab LB 2WD	4.8L V-8	7,100 (i)
1500 Reg Cab LB 2WD	5.3L V-8	7,200 (h,p)
1500 Reg Cab LB 2WD	5.3L V-8	6,500 (g)
1500 Reg Cab LB 2WD	5.3L V-8	10,000/8,800 (g,p)
1500 Reg Cab LB 4WD	4.3L V-6	4,900 (i)
1500 Reg Cab LB 4WD	4.8L V-8	5,800 (g)
1500 Reg Cab LB 4WD	5.3L V-8	6,300 (b)
1500 Reg Cab LB 4WD	5.3L V-8	7,000 (h,p)
1500 Reg Cab LB 4WD	5.3L V-8	9,800/9,700 (g,p)

Silverado/Sierra 1500 Ext Cab Longbed

1500 Ext Cab LB 2WD	5.3L V-8	6,000 (b)
1500 Ext Cab LB 2WD	5.3L V-8	6,700 (h,p)
1500 Ext Cab LB 2WD	5.3L V-8	9,500/8,900 (g,p)

Silverado/Sierra Two-Mode Hybrid

Two-mode hybrid 2WD	6.0L V-8	6,100
Two-mode hybrid 4WD	6.0L V-8	5,900

Silverado/Sierra 2500 Ext Cab Std Bed

2500 Ext Cab Std Bed 2WD	6.0L V-8	9,800 (i)
2500 Ext Cab Std Bed 2WD	6.0L V-8	13,000/14,300 (k)
2500 Ext Cab Std Bed 2WD	6.6L V-8 TD	17,500
2500 Ext Cab Std Bed 4WD	6.0L V-8	9,500 (i)
2500 Ext Cab Std Bed 4WD	6.0L V-8	13,000/14,000 (k)
2500 Ext Cab Std Bed 4WD	6.6L V-8 TD	17,200

Silverado/Sierra 2500 CC Std Bed

2500 CC Std Bed 2WD	6.0L V-8	9,700 (i)
2500 CC Std Bed 2WD	6.0L V-8	13,000/14,200 (k)
2500 CC Std Bed 2WD	6.6L V-8 TD	17,400
Sierra Denali 2500 2WD	6.6L V-8 TD	17,200
2500 CC Std Bed 4WD	6.0L V-8	9,400 (i)
2500 CC Std Bed 4WD	6.0L V-8	13,000/13,900 (k)
2500 CC Std Bed 4WD	6.6L V-8 TD	16,700
Sierra Denali 2500 4WD	6.0L V-8	9,300/9,300 (i)
Sierra Denali 2500 4WD	6.6L V-8 TD	15,600

Silverado/Sierra 2500 Reg Cab Longbed

2500 Reg Cab LB 2WD	6.0L V-8	10,200 (i)
2500 Reg Cab LB 2WD	6.0L V-8	13,000/14,700 (k)
2500 Reg Cab LB 2WD	6.6L V-8 TD	17,800
2500 Reg Cab LB 4WD	6.0L V-8	9,900 (i)
2500 Reg Cab LB 4WD	6.0L V-8	13,000/14,400 (k)
2500 Reg Cab LB 4WD	6.6L V-8 TD	17,500

Silverado/Sierra 2500 Ext Cab Longbed

2500 Ext Cab LB 2WD	6.0L V-8	9,700 (i)
2500 Ext Cab LB 2WD	6.0L V-8	13,000/14,200 (k)
2500 Ext Cab LB 2WD	6.6L V-8 TD	17,400
2500 Ext Cab LB 4WD	6.0L V-8	9,400 (i)
2500 Ext Cab LB 4WD	6.0L V-8	13,000/13,900 (k)
2500 Ext Cab LB 4WD	6.6L V-8 TD	16,500

Silverado/Sierra 2500 CC Longbed

2500 CC LB 2WD	6.0L V-8	9,600 (i)
2500 CC LB 2WD	6.0L V-8	13,000/14,100 (k)
2500 CC LB 2WD	6.6L V-8 TD	17,200
2500 CC LB 4WD	6.0L V-8	9,300 (i)
2500 CC LB 4WD	6.0L V-8	13,000/13,800 (k)
2500 CC LB 4WD	6.6L V-8 TD	15,600

Silverado/Sierra 3500 Reg Cab

3500 Reg Cab SRW 2WD	6.0L V-8	13,000/14,500 (k)
3500 Reg Cab DRW 2WD	6.0L V-8	9,600 (i)
3500 Reg Cab DRW 2WD	6.0L V-8	14,100 (k)
3500 Reg Cab SRW 4WD	6.0L V-8	9,700 (i)
3500 Reg Cab SRW 4WD	6.0L V-8	13,000/14,200 (k)
3500 Reg Cab SRW 4WD	6.6L V-8 TD	17,400
3500 Reg Cab DRW 4WD	6.0L V-8	9,300 (i)
3500 Reg Cab DRW 4WD	6.0L V-8	13,800 (k)
3500 Reg Cab DRW 4WD	6.6L V-8 TD	21,700

Silverado/Sierra 3500 Ext Cab

3500 Ext Cab SRW 2WD	6.0L V-8	9,500 (i)
3500 Ext Cab SRW 2WD	6.0L V-8	13,000/14,000 (k)
3500 Ext Cab SRW 2WD	6.6L V-8 TD	17,300
3500 Ext Cab DRW 2WD	6.0L V-8	9,100 (i)
3500 Ext Cab DRW 2WD	6.0L V-8	13,600 (k)
3500 Ext Cab DRW 2WD	6.6L V-8 TD	21,500
3500 Ext Cab SRW 4WD	6.0L V-8	9,200 (i)

3500 Ext Cab SRW 4WD	6.0L V-8	13,000/13,700 (k)
3500 Ext Cab SRW 4WD	6.6L V-8 TD	16,900
3500 Ext Cab DRW 4WD	6.0L V-8	8,900 (i)
3500 Ext Cab DRW 4WD	6.0L V-8	13,400 (k)
3500 Ext Cab DRW 4WD	6.6L V-8 TD	21,300

Silverado/Sierra 3500 CC

3500 CC Std Bed SRW 2WD	6.0L V-8	9,500 (j)
3500 CC Std Bed SRW 2WD	6.0L V-8	13,000/14,000 (k)
3500 CC Std Bed SRW 2WD	6.6L V-8 TD	17,200
3500 CC Std Bed SRW 2WD Denali	6.6L V-8 TD	17,100
3500 CC Std Bed SRW 4WD	6.0L V-8	9,200 (j)
3500 CC Std Bed SRW 4WD	6.0L V-8	13,000/13,700 (k)
3500 CC Std Bed SRW 4WD	6.6L V-8 TD	17,000
3500 CC Std Bed SRW 4WD Denali	6.6L V-8 TD	16,800
3500 CC LB SRW 2WD	6.0L V-8	9,400 (j)
3500 CC LB SRW 2WD	6.0L V-8	13,000/13,900 (k)
3500 CC LB SRW 2WD	6.6L V-8 TD	17,300
3500 CC LB DRW 2WD	6.0L V-8	9,000 (j)
3500 CC LB DRW 2WD	6.0L V-8	13,500 (k)
3500 CC LB DRW 2WD	6.6L V-8 TD	21,500
3500 CC LB DRW 2WD Denali	6.6L V-8 TD	21,300
3500 CC LB SRW 4WD	6.0L V-8	9,100 (j)
3500 CC LB SRW 4WD	6.0L V-8	13,000/13,600 (k)
3500 CC LB SRW 4WD	6.6L V-8 TD	16,800
3500 CC LB DRW 4WD	6.0L V-8	8,700 (j)
3500 CC LB DRW 4WD	6.0L V-8	13,200 (k)
3500 CC LB DRW 4WD & Denali	6.6L V-8 TD	21,000

Chevy Tahoe and Suburban, GMC Yukon, Yukon XL, Yukon and Yukon XL Denali 1500 Series

Tahoe/Yukon 2WD	5.3L V-8	5,600 (b)
Tahoe/Yukon 2WD	5.3L V-8	6,000 (g)
Tahoe/Yukon 2WD	5.3L V-8	8,500 (g,p)
Tahoe/Yukon Two-Mode Hybrid, 2WD	6.0L V-8	6,200
Tahoe/Yukon 4WD	5.3L V-8	5,200 (b)
Tahoe/Yukon 4WD	5.3L V-8	5,700 (g)
Tahoe/Yukon 4WD	5.3L V-8	8,200 (g,p)
Tahoe/Yukon Two-Mode Hybrid, 4WD	6.0L V-8	5,900
Suburban/Yukon XL 2WD	5.3L V-8	5,100 (b)
Suburban/Yukon XL 2WD	5.3L V-8	5,600 (g)
Suburban/Yukon XL 2WD	5.3L V-8	8,100 (g,p)
Suburban/Yukon XL 4WD	5.3L V-8	5,000 (b)
Suburban/Yukon XL 4WD	5.3L V-8	5,500 (g)
Suburban/Yukon XL 4WD	5.3L V-8	8,000 (g,p)
Yukon Denali 2WD	6.2L V-8	8,300
Yukon Denali AWD	6.2L V-8	8,100
Yukon XL Denali 2WD	6.2L V-8	7,900
Yukon XL Denali AWD	6.2L V-8	7,800

Chevy Suburban, GMC Yukon XL 2500

2500 Long Wheelbase 2WD	6.0L V-8	9,600
2500 Long Wheelbase 4WD	6.0L V-8	9,400

CHRYSLER/DODGE

Grand Caravan	3.6L V-6	3,600 (t)
Journey	3.6L V-6	2,500
Town and Country	3.8L V-6	3,600 (t)

Dodge Dakota

Dakota Ext Cab SB 2WD	3.7L V-6	3,350 (m6,d)
Dakota Ext Cab SB 2WD	3.7L V-6	4,650 (a4,h)
Dakota Ext Cab SB 2WD	3.7L V-6	4,950 (a4,j)
Dakota Ext Cab SB 2WD	4.7L V-8	6,050 (a5,h)
Dakota Ext Cab SB 2WD	4.7L V-8	7,250 (a5,j)
Dakota Ext Cab SB 4WD	3.7L V-6	3,950 (m6,h)
Dakota Ext Cab SB 4WD	3.7L V-6	3,900 (a4,h)
Dakota Ext Cab SB 4WD	3.7L V-6	4,750 (a4,j)
Dakota Ext Cab SB 4WD	4.7L V-8	5,850 (a5,h)
Dakota Ext Cab SB 4WD	4.7L V-8	7,050 (a5,j)
Dakota CC SB 2WD	3.7L V-6	4,450 (a4,h)
Dakota CC SB 2WD	3.7L V-6	4,750 (a4,j)
Dakota CC SB 2WD	4.7L V-8	5,800 (a5,h)
Dakota CC SB 2WD	4.7L V-8	7,000 (a5,j)
Dakota CC SB 4WD	3.7L V-8	3,750 (m6,h)
Dakota CC SB 4WD	3.7L V-8	4,600 (a4,j)
Dakota CC SB 4WD	4.7L V-8	5,600 (a5,h)
Dakota CC SB 4WD	4.7L V-8	6,800 (a5,j)
Durango RWD	3.6L V-6	6,200
Durango RWD	5.7L V-8	7,400
Durango AWD	3.6L V-6	6,200
Durango AWD	5.7L V-8	7,200

Ram 1500 Regular Cab

1500 Reg Cab SB 2WD	3.7L V-6	3,750 (a4,h/j)
1500 Reg Cab SB 2WD	4.7L V-8	7,600 (a5,h/j)
1500 Reg Cab SB 2WD	5.7L V-8	7,100 (a5,d)
1500 Reg Cab SB 2WD	5.7L V-8	9,100 (a5,h/j)
1500 Reg Cab SB 2WD R/T model	5.7L V-8	5,000 (a5,k)
1500 Reg Cab SB 4WD	4.7L V-8	7,450 (a5,h/j)
1500 Reg Cab SB 4WD	5.7L V-8	8,900 (a5,h/j)

Ram 1500 Regular Cab Longbed

1500 Reg Cab LB 2WD	3.7L V-6	3,600 (a4,h/j)
1500 Reg Cab LB 2WD	4.7L V-8	7,450 (a5,h/j)
1500 Reg Cab LB 2WD	5.7L V-8	6,900 (a5,d)
1500 Reg Cab LB 2WD	5.7L V-8	8,900 (a5,h)
1500 Reg Cab LB 2WD	5.7L V-8	10,400 (a5,j)
1500 Reg Cab LB 4WD	4.7L V-8	7,300 (a5,h/j)
1500 Reg Cab LB 4WD	5.7L V-8	8,750 (a5,h)
1500 Reg Cab LB 4WD	5.7L V-8	10,450 (a5,j)

Ram 1500 Quad Cab

Ram 1500 Quad Cab 2WD	3.7L V-6	3,450 (a4,h/j)
Ram 1500 Quad Cab 2WD	4.7L V-8	7,300 (a5,h/j)
Ram 1500 Quad Cab 2WD	5.7L V-8	6,750 (a5,d)
Ram 1500 Quad Cab 2WD	5.7L V-8	8,700 (a5,h)
Ram 1500 Quad Cab 2WD	5.7L V-8	10,250 (a5,j)

Ram 1500 Quad Cab 4WD	4.7L V-8	7,150 (a5,h/j)
Ram 1500 Quad Cab 4WD	5.7L V-8	8,550 (a5,h)
Ram 1500 Quad Cab 4WD	5.7L V-8	10,050 (a5,i)

Ram 1500 Crew Cab

Ram 1500 CC 2WD	4.7L V-8	7,250 (a5,h/j)
Ram 1500 CC 2WD	5.7L V-8	6,700 (a5,d)
Ram 1500 CC 2WD	5.7L V-8	8,700 (a5,h)
Ram 1500 CC 2WD	5.7L V-8	10,200 (a5,i)
Ram 1500 CC 4WD	4.7L V-8	7,050 (a5,h/j)
Ram 1500 CC 4WD	5.7L V-8	8,500 (a5,h)
Ram 1500 CC 4WD	5.7L V-8	10,000 (a5,i)

Ram 2500 Regular Cab Longbed

Ram 2500 LB 2WD	5.7L V-8	9,300 (a5,i)
Ram 2500 LB 2WD	5.7L V-8	12,300 (a5,k)
Ram 2500 LB 2WD	6.7L I-6 TD	12,350 (m6,g)
Ram 2500 LB 2WD	6.7L I-6 TD	13,350 (m6,i)
Ram 2500 LB 2WD	6.7L I-6 TD	10,450 (a6,g)
Ram 2500 LB 2WD	6.7L I-6 TD	13,450 (a6,i)
Ram 2500 LB 2WD	6.7L I-6 TD	15,450 (a6,k)
Ram 2500 LB 4WD	5.7L V-8	8,850 (a5,i)
Ram 2500 LB 4WD	5.7L V-8	11,850 (a5,k)
Ram 2500 LB 4WD	6.7L I-6 TD	12,000 (m6,g)
Ram 2500 LB 4WD	6.7L I-6 TD	13,000 (m6,i)
Ram 2500 LB 4WD	6.7L I-6 TD	10,050 (a6,g)
Ram 2500 LB 4WD	6.7L I-6 TD	13,050 (a6,i)
Ram 2500 LB 4WD	6.7L I-6 TD	15,050 (a6,k)

Ram 2500 Crew Cab Shortbed

Ram 2500 Crew Cab SB 2WD	5.7L V-8	9,100 (a5,i)
Ram 2500 Crew Cab SB 2WD	5.7L V-8	12,100 (a5,k)
Ram 2500 Crew Cab SB 2WD	6.7L I-6 TD	12,100 (m6,g)
Ram 2500 Crew Cab SB 2WD	6.7L I-6 TD	13,100 (m6,i)
Ram 2500 Crew Cab SB 2WD	6.7L I-6 TD	10,200 (a6,g)
Ram 2500 Crew Cab SB 2WD	6.7L I-6 TD	13,200 (a6,i)
Ram 2500 Crew Cab SB 2WD	6.7L I-6 TD	15,200 (a6,k)
Ram 2500 Crew Cab SB 4WD	5.7L V-8	8,600 (a5,i)
Ram 2500 Crew Cab SB 4WD	5.7L V-8	11,600 (a5,k)
Ram 2500 Power Wagon 4WD	5.7L V-8	10,100 (a5,o)
Ram 2500 Crew Cab SB 4WD	6.7L I-6 TD	11,600 (m6,g)
Ram 2500 Crew Cab SB 4WD	6.7L I-6 TD	12,600 (m6,i)
Ram 2500 Crew Cab SB 4WD	6.7L I-6 TD	9,700 (a6,g)
Ram 2500 Crew Cab SB 4WD	6.7L I-6 TD	12,700 (a6,i)
Ram 2500 Crew Cab SB 4WD	6.7L I-6 TD	14,700 (a6,k)

Ram 2500 Crew Cab Longbed

Ram 2500 Crew Cab LB 2WD	5.7L V-8	8,850 (a5,i)
Ram 2500 Crew Cab LB 2WD	5.7L V-8	11,850 (a5,k)
Ram 2500 Crew Cab LB 2WD	6.7L I-6 TD	11,950 (m6,g)
Ram 2500 Crew Cab LB 2WD	6.7L I-6 TD	12,950 (m6,i)
Ram 2500 Crew Cab LB 2WD	6.7L I-6 TD	10,050 (a6,g)
Ram 2500 Crew Cab LB 2WD	6.7L I-6 TD	13,050 (a6,i)
Ram 2500 Crew Cab LB 2WD	6.7L I-6 TD	15,050 (a6,k)
Ram 2500 Crew Cab LB 4WD	5.7L V-8	8,500 (a5,h)
Ram 2500 Crew Cab LB 4WD	5.7L V-8	11,500 (a5,k)

Ram 2500 Crew Cab LB 4WD	6.7L I-6 TD	11,550 (m6,g)
Ram 2500 Crew Cab LB 4WD	6.7L I-6 TD	12,550 (m6,i)
Ram 2500 Crew Cab LB 4WD	6.7L I-6 TD	9,650 (a6,g)
Ram 2500 Crew Cab LB 4WD	6.7L I-6 TD	12,650 (a6,i)
Ram 2500 Crew Cab LB 4WD	6.7L I-6 TD	14,650 (a6,k)

Ram 2500 Mega Cab

Ram 2500 Mega Cab 2WD	5.7L V-8	8,550 (a5,i)
Ram 2500 Mega Cab 2WD	5.7L V-8	11,550 (a5,k)
Ram 2500 Mega Cab 2WD	6.7L I-6 TD	11,700 (m6,g)
Ram 2500 Mega Cab 2WD	6.7L I-6 TD	12,700 (m6,i)
Ram 2500 Mega Cab 2WD	6.7L I-6 TD	9,800 (a6,g)
Ram 2500 Mega Cab 2WD	6.7L I-6 TD	12,800 (a6,i)
Ram 2500 Mega Cab 2WD	6.7L I-6 TD	14,800 (a6,k)
Ram 2500 Mega Cab 4WD	5.7L V-8	8,150 (a5,i)
Ram 2500 Mega Cab 4WD	5.7L V-8	11,150 (a5,k)
Ram 2500 Mega Cab 4WD	6.7L I-6 TD	11,200 (m6,g)
Ram 2500 Mega Cab 4WD	6.7L I-6 TD	12,200 (m6,i)
Ram 2500 Mega Cab 4WD	6.7L I-6 TD	9,300 (a6,g)
Ram 2500 Mega Cab 4WD	6.7L I-6 TD	12,300 (a6,i)
Ram 2500 Mega Cab 4WD	6.7L I-6 TD	14,300 (a6,k)

Ram 3500 Regular Cab Longbed

Ram 3500 Regular Cab LB DRW 2WD	6.7L I-6 TD	12,000 (m6,g)
Ram 3500 Regular Cab LB DRW 2WD	6.7L I-6 TD	14,000 (m6,i)
Ram 3500 Regular Cab LB DRW 2WD	6.7L I-6 TD	10,100 (a6,g)
Ram 3500 Regular Cab LB DRW 2WD	6.7L I-6 TD	14,100 (a6,i)
Ram 3500 Regular Cab LB DRW 2WD	6.7L I-6 TD	17,600 (a6,k)
Ram 3500 Regular Cab LB DRW 4WD	6.7L I-6 TD	11,700 (m6,g)
Ram 3500 Regular Cab LB DRW 4WD	6.7L I-6 TD	13,700 (m6,i)
Ram 3500 Regular Cab LB DRW 4WD	6.7L I-6 TD	9,800 (a6,g)
Ram 3500 Regular Cab LB DRW 4WD	6.7L I-6 TD	13,800 (a6,i)
Ram 3500 Regular Cab LB DRW 4WD	6.7L I-6 TD	17,300 (a6,k)

Ram 3500 Crew Cab Shortbed

Ram 3500 Crew Cab SB SRW 2WD	6.7L I-6 TD	12,000 (m6,g)
Ram 3500 Crew Cab SB SRW 2WD	6.7L I-6 TD	14,000 (m6,i)
Ram 3500 Crew Cab SB SRW 2WD	6.7L I-6 TD	10,100 (a6,g)
Ram 3500 Crew Cab SB SRW 2WD	6.7L I-6 TD	14,100 (a6,i)
Ram 3500 Crew Cab SB SRW 2WD	6.7L I-6 TD	17,100 (a6,k)
Ram 3500 Crew Cab SB SRW 4WD	6.7L I-6 TD	11,800 (m6,g)
Ram 3500 Crew Cab SB SRW 4WD	6.7L I-6 TD	13,800 (m6,i)
Ram 3500 Crew Cab SB SRW 4WD	6.7L I-6 TD	9,900 (a6,g)
Ram 3500 Crew Cab SB SRW 4WD	6.7L I-6 TD	13,900 (a6,i)
Ram 3500 Crew Cab SB SRW 4WD	6.7L I-6 TD	16,900 (a6,k)

Ram 3500 Crew Cab Longbed

Ram 3500 Crew Cab LB SRW 2WD	6.7L I-6 TD	11,900 (m6,g)
Ram 3500 Crew Cab LB SRW 2WD	6.7L I-6 TD	13,900 (m6,i)
Ram 3500 Crew Cab LB SRW 2WD	6.7L I-6 TD	10,000 (a6,g)
Ram 3500 Crew Cab LB SRW 2WD	6.7L I-6 TD	14,000 (a6,i)
Ram 3500 Crew Cab LB SRW 2WD	6.7L I-6 TD	17,000 (a6,k)
Ram 3500 Crew Cab LB DRW 2WD	6.7L I-6 TD	11,500 (m6,g)
Ram 3500 Crew Cab LB DRW 2WD	6.7L I-6 TD	13,500 (m6,i)
Ram 3500 Crew Cab LB DRW 2WD	6.7L I-6 TD	9,550 (a6,g)
Ram 3500 Crew Cab LB DRW 2WD	6.7L I-6 TD	13,550 (a6,i)

Ram 3500 Crew Cab LB DRW 2WD	6.7L I-6 TD	17,050 (a6,k)
Ram 3500 Crew Cab LB SRW 4WD	6.7L I-6 TD	11,700 (m6,g)
Ram 3500 Crew Cab LB SRW 4WD	6.7L I-6 TD	13,700 (m6,i)
Ram 3500 Crew Cab LB SRW 4WD	6.7L I-6 TD	9,800 (a6,g)
Ram 3500 Crew Cab LB SRW 4WD	6.7L I-6 TD	13,800 (a6,i)
Ram 3500 Crew Cab LB SRW 4WD	6.7L I-6 TD	16,800 (a6,k)
Ram 3500 Crew Cab LB DRW 4WD	6.7L I-6 TD	11,350 (m6,g)
Ram 3500 Crew Cab LB DRW 4WD	6.7L I-6 TD	13,350 (m6,i)
Ram 3500 Crew Cab LB DRW 4WD	6.7L I-6 TD	9,400 (a6,g)
Ram 3500 Crew Cab LB DRW 4WD	6.7L I-6 TD	13,400 (a6,i)
Ram 3500 Crew Cab LB DRW 4WD	6.7L I-6 TD	16,900 (a6,k)

Ram 3500 Mega Cab

Ram 3500 Mega Cab SRW 2WD	6.7L I-6 TD	11,700 (m6,g)
Ram 3500 Mega Cab SRW 2WD	6.7L I-6 TD	13,700 (m6,i)
Ram 3500 Mega Cab SRW 2WD	6.7L I-6 TD	9,800 (a6,g)
Ram 3500 Mega Cab SRW 2WD	6.7L I-6 TD	13,800 (a6,i)
Ram 3500 Mega Cab SRW 2WD	6.7L I-6 TD	16,800 (a6,k)
Ram 3500 Mega Cab DRW 2WD	6.7L I-6 TD	11,350 (m6,g)
Ram 3500 Mega Cab DRW 2WD	6.7L I-6 TD	13,350 (m6,i)
Ram 3500 Mega Cab DRW 2WD	6.7L I-6 TD	9,450 (a6,g)
Ram 3500 Mega Cab DRW 2WD	6.7L I-6 TD	13,450 (a6,i)
Ram 3500 Mega Cab DRW 2WD	6.7L I-6 TD	19,950 (a6,k)
Ram 3500 Mega Cab SRW 4WD	6.7L I-6 TD	11,250 (m6,g)
Ram 3500 Mega Cab SRW 4WD	6.7L I-6 TD	13,250 (m6,i)
Ram 3500 Mega Cab SRW 4WD	6.7L I-6 TD	9,300 (a6,g)
Ram 3500 Mega Cab SRW 4WD	6.7L I-6 TD	13,300 (a6,i)
Ram 3500 Mega Cab SRW 4WD	6.7L I-6 TD	16,300 (a6,k)
Ram 3500 Mega Cab DRW 4WD	6.7L I-6 TD	10,950 (m6,g)
Ram 3500 Mega Cab DRW 4WD	6.7L I-6 TD	12,950 (m6,i)
Ram 3500 Mega Cab DRW 4WD	6.7L I-6 TD	9,000 (a6,g)
Ram 3500 Mega Cab DRW 4WD	6.7L I-6 TD	13,000 (a6,i)
Ram 3500 Mega Cab DRW 4WD	6.7L I-6 TD	16,500 (a6,k)

Ram 3500, 4500, 5500 Chassis Cabs

Ram 3500 Reg. Chassis Cab SRW 2WD	6.7L I-6 TD	12,250 (m6,g)
Ram 3500 Reg. Chassis Cab SRW 2WD	6.7L I-6 TD	17,250 (m6,i/k)
Ram 3500 Reg. Chassis Cab SRW 2WD	6.7L I-6 TD	17,150 (a6,k)
Ram 3500 Reg. Chassis Cab SRW 4WD	6.7L I-6 TD	12,000 (m6,g)
Ram 3500 Reg. Chassis Cab SRW 4WD	6.7L I-6 TD	17,000 (m6,i/k)
Ram 3500 Reg. Chassis Cab SRW 4WD	6.7L I-6 TD	16,950 (a6,k)
Ram 3500 Reg. Chassis Cab DRW 2WD	5.7L V-8	10,850 (a5,k)
Ram 3500 Reg. Chassis Cab DRW 2WD	6.7L I-6 TD	11,750 (m6,g)
Ram 3500 Reg. Chassis Cab DRW 2WD	6.7L I-6 TD	16,750 (m6,i)
Ram 3500 Reg. Chassis Cab DRW 2WD	6.7L I-6 TD	18,750 (m6,k)
Ram 3500 Reg. Chassis Cab DRW 2WD	6.7L I-6 TD	18,700 (a6,k)
Ram 3500 Reg. Chassis Cab DRW 4WD	5.7L V-8	10,600 (a5,k)
Ram 3500 Reg. Chassis Cab DRW 4WD	6.7L I-6 TD	11,650 (m6,g)
Ram 3500 Reg. Chassis Cab DRW 4WD	6.7L I-6 TD	16,650 (m6,i)
Ram 3500 Reg. Chassis Cab DRW 4WD	6.7L I-6 TD	18,650 (m6,k)
Ram 3500 Reg. Chassis Cab DRW 4WD	6.7L I-6 TD	18,550 (a6,k)
Ram 3500 Crew Chassis Cab SRW 2WD	6.7L I-6 TD	11,900 (m6,g)
Ram 3500 Crew Chassis Cab SRW 2WD	6.7L I-6 TD	16,900 (m6,i/k)
Ram 3500 Crew Chassis Cab SRW 2WD	6.7L I-6 TD	16,800 (a6,k)
Ram 3500 Crew Chassis Cab SRW 4WD	6.7L I-6 TD	11,600 (m6,g)
Ram 3500 Crew Chassis Cab SRW 4WD	6.7L I-6 TD	16,600 (m6,i/k)

Ram 3500 Crew Chassis Cab SRW 4WD	6.7L I-6 TD	16,550 (a6,k)
Ram 3500 Crew Chassis Cab DRW 2WD	5.7L V-8	10,350 (a5,k)
Ram 3500 Crew Chassis Cab DRW 2WD	6.7L I-6 TD	11,350 (m6,g)
Ram 3500 Crew Chassis Cab DRW 2WD	6.7L I-6 TD	16,350 (m6,i)
Ram 3500 Crew Chassis Cab DRW 2WD	6.7L I-6 TD	18,350 (m6,k)
Ram 3500 Crew Chassis Cab DRW 2WD	6.7L I-6 TD	18,250 (a6,k)
Ram 3500 Crew Chassis Cab DRW 4WD	5.7L V-8	10,100 (a5,k)
Ram 3500 Crew Chassis Cab DRW 4WD	6.7L I-6 TD	11,050 (m6,g)
Ram 3500 Crew Chassis Cab DRW 4WD	6.7L I-6 TD	16,050 (m6,i)
Ram 3500 Crew Chassis Cab DRW 4WD	6.7L I-6 TD	18,050 (m6,k)
Ram 3500 Crew Chassis Cab DRW 4WD	6.7L I-6 TD	18,000 (a6,k)

Note: Maximum weights for shortest wheelbase chassis shown. Weights for longer wheelbase models may be less.

Ram 4500 Reg. Chassis Cab 2WD	6.7L I-6 TD	18,350 (m6,k/n)
Ram 4500 Reg. Chassis Cab 2WD	6.7L I-6 TD	18,300 (a6,n/q)
Ram 4500 Reg. Chassis Cab 4WD	6.7L I-6 TD	17,800 (m6,k/n)
Ram 4500 Reg. Chassis Cab 4WD	6.7L I-6 TD	17,750 (a6,n/q)
Ram 4500 Crew Chassis Cab 2WD	6.7L I-6 TD	17,650 (m6,k/n)
Ram 4500 Crew Chassis Cab 2WD	6.7L I-6 TD	17,600 (a6,n/q)
Ram 4500 Crew Chassis Cab 4WD	6.7L I-6 TD	17,250 (m6,k/n)
Ram 4500 Crew Chassis Cab 4WD	6.7L I-6 TD	17,200 (a6,n/q)
Ram 5500 Reg. Chassis Cab 2WD	6.7L I-6 TD	18,300 (m6,n)
Ram 5500 Reg. Chassis Cab 2WD	6.7L I-6 TD	18,250 (a6,g)
Ram 5500 Reg. Chassis Cab 4WD	6.7L I-6 TD	17,800 (m6,n)
Ram 5500 Reg. Chassis Cab 4WD	6.7L I-6 TD	17,750 (a6,q)
Ram 5500 Crew Chassis Cab 2WD	6.7L I-6 TD	17,600 (m6,n)
Ram 5500 Crew Chassis Cab 2WD	6.7L I-6 TD	17,550 (a6,q)
Ram 5500 Crew Chassis Cab 4WD	6.7L I-6 TD	17,200 (m6,n)
Ram 5500 Crew Chassis Cab 4WD	6.7L I-6 TD	17,150 (a6,q)

FORD

E-Series Van/Wagon

E-150 Van	4.6L V-8	6,000 (i)
E-150 Van	4.6L V-8	6,500 (k)
E-150 Van	5.4L V-8	7,500 (i/k)
E-150 Extended Van	4.6L V-8	5,900 (i)
E-150 Extended Van	4.6L V-8	6,400 (k)
E-150 Extended Van	5.4L V-8	7,300 (i/k)
E-250 Van	4.6L V-8	6,000 (i)
E-250 Van	4.6L V-8	6,500 (k)
E-250 Van	5.4L V-8	7,400 (i/k)
E-250 Extended Van	4.6L V-8	5,900 (i)
E-250 Extended Van	4.6L V-8	6,400 (k)
E-250 Extended Van	5.4L V-8	7,300 (i/k)
E-350 Super Duty Van	5.4L V-8	7,400 (i/k)
E-350 Super Duty Van	6.8L V-10	9,100 (i)
E-350 Super Duty Van	6.8L V-10	10,000 (k)
E-350 Super Duty Extended Van	5.4L V-8	7,200 (i/k)
E-350 Super Duty Extended Van	6.8L V-10	9,000 (i)
E-350 Super Duty Extended Van	6.8L V-10	10,000 (k)
E-150 Wagon	4.6L V-8	5,600 (i)
E-150 Wagon	4.6L V-8	6,100 (k)
E-150 Wagon	5.4L V-8	7,000 (i/k)
E-350 Super Duty Wagon	5.4L V-8	6,700 (i/k)

E-350 Super Duty Wagon	6.8L V-10	8,500 (i)
E-350 Super Duty Wagon	6.8L V-10	10,000 (k)
E-350 Super Duty Ext. Wagon	5.4L V-8	6,500 (i/k)*
E-350 Super Duty Ext. Wagon	6.8L V-10	8,300 (i)*
E-350 Super Duty Ext. Wagon	6.8L V-10	10,000 (k)*

*Ratings for 11-passenger van. Ratings for 14- to 15-passenger van up to 200 pounds less.

Edge, Escape, Explorer, Expedition, Flex

Edge	All	2,000
Edge	All	3,500 (t)
Escape	3.0L V-6	3,500 (t)
Explorer	2.0L TC	2,000
Explorer	3.5L V-6	2,000
Explorer	3.5L V-6	5,000 (t)
Expedition 2WD/4WD	5.4L V-8	6,000 (all)
Expedition 2WD	5.4L V-8	9,200 (t)
Expedition 4WD	5.4L V-8	8,900 (t)
Expedition EL 2WD	5.4L V-8	6,000
Expedition EL 2WD	5.4L V-8	8,900 (t)
Expedition EL 4WD	5.4L V-8	6,000
Expedition EL 4WD	5.4L V-8	8,700 (t)
Flex	3.5L V-6	2,000
Flex	3.5L V-6	4,500 (t)

Ranger

Ranger Regular Cab SB 2WD	2.3L I-4	2,160
Ranger Regular Cab LB 2WD	2.3L I-4	2,160
Ranger Regular Cab LB 2WD	4.0L V-6	5,960
Ranger SuperCab 2WD	2.3L I-4	2,000
Ranger SuperCab 2WD	4.0L V-6	3,340 (m)
Ranger SuperCab 2WD	4.0L V-6	3,280 (m*)
Ranger SuperCab 2WD	4.0L V-6	5,800
Ranger SuperCab 2WD	4.0L V-6	5,740*

*Ranger Sport.

Ranger SuperCab 4WD	4.0L V-6	3,100 (m)
Ranger SuperCab 4WD	4.0L V-6	5,560

F-150

F-150 Reg. Cab Std Bed 2WD	3.7L V-6	5,500 (h)
F-150 Reg. Cab Std Bed 2WD	3.7L V-6	6,000 (i)
F-150 Reg. Cab Std Bed 2WD	5.0L V-8	7,900 (f)
F-150 Reg. Cab Std Bed 2WD	5.0L V-8	8,300 (h)
F-150 Reg. Cab LB 2WD	3.7L V-6	5,600 (h)
F-150 Reg. Cab LB 2WD	3.7L V-6	6,100 (i)
F-150 Reg. Cab LB 2WD	5.0L V-8	8,400 (f)
F-150 Reg. Cab LB 2WD	5.0L V-8	9,800 (h)
F-150 Reg. Cab LB 2WD	5.0L V-8	10,000 (i)
F-150 Reg. Cab LB 2WD	3.5L V-6 TC	8,800 (c)
F-150 Reg. Cab LB 2WD	3.5L V-6 TC	9,800 (h)
F-150 Reg. Cab LB 2WD	3.5L V-6 TC	11,300 (i,t)*
F-150 Reg. Cab Std Bed 4WD	3.7L V-6	5,700 (i)
F-150 Reg. Cab Std Bed 4WD	5.0L V-8	7,600 (h)
F-150 Reg. Cab Std Bed 4WD	5.0L V-8	8,000 (i)
F-150 Reg. Cab LB 4WD	3.7L V-6	5,800 (i)

F-150 Reg. Cab LB 4WD	5.0L V-8	8,200 (h)
F-150 Reg. Cab LB 4WD	5.0L V-8	9,800 (i)
F-150 Reg. Cab LB 4WD	3.5L V-6 TC	8,600 (f)
F-150 Reg. Cab LB 4WD	3.5L V-6 TC	9,800 (h/i)
F-150 Reg. Cab LB 4WD	3.5L V-6 TC	11,300 (i,t)*
F-150 SuperCab Std Bed 2WD	3.7L V-6	5,800 (i)
F-150 SuperCab Std Bed 2WD	5.0L V-8	8,100 (f)
F-150 SuperCab Std Bed 2WD	5.0L V-8	9,500 (h)
F-150 SuperCab Std Bed 2WD	3.5L V-6 TC	8,600 (c)
F-150 SuperCab Std Bed 2WD	3.5L V-6 TC	9,800 (h)
F-150 SuperCab Std Bed 2WD	3.5L V-6 TC	11,300 (i,t)
F-150 SuperCab LB 2WD	5.0L V-8	9,600 (i)
F-150 SuperCab LB 2WD	3.5L V-6 TC	11,300 (i,t)*
F-150 SVT Raptor SuperCab SB 4WD	6.2L V-8	6,000 (k)
F-150 SuperCab Std Bed 4WD	3.7L V-6	5,500 (i)
F-150 SuperCab Std Bed 4WD	5.0L V-8	7,800 (h)
F-150 SuperCab Std Bed 4WD	5.0L V-8	9,400 (i)
F-150 SuperCab Std Bed 4WD	3.5L V-6 TC	8,400 (f)
F-150 SuperCab Std Bed 4WD	3.5L V-6 TC	9,800 (h/i)
F-150 SuperCab Std Bed 4WD	3.5L V-6 TC	11,300 (i,t)
F-150 SuperCab LB 4WD	5.0L V-8	9,300 (i)
F-150 SuperCab LB 4WD	3.5L V-6 TC	11,200 (i,t)*
F-150 SuperCrew Cab SB 2WD	3.7L V-6	5,700 (i)
F-150 SuperCrew Cab SB 2WD	5.0L V-8	8,000 (h)
F-150 SuperCrew Cab SB 2WD	5.0L V-8	9,400 (i)
F-150 SuperCrew Cab SB 2WD	3.5L V-6 TC	8,500 (c)
F-150 SuperCrew Cab SB 2WD	3.5L V-6 TC	9,800 (h)
F-150 SuperCrew Cab SB 2WD	3.5L V-6 TC	11,300 (i,t)
F-150 SuperCrew Cab SB 2WD	6.2L V-8	11,300 (i,t)
F-150 SuperCrew Cab H-D Edition/Lariat Ltd.	6.2L V-8	7,500 (i)
F-150 SuperCrew Cab Std Bed 2WD	5.0L V-8	7,900 (h)
F-150 SuperCrew Cab Std Bed 2WD	5.0L V-8	9,300 (i)
F-150 SuperCrew Cab Std Bed 2WD	3.5L V-6 TC	8,400 (c)
F-150 SuperCrew Cab Std Bed 2WD	3.5L V-6 TC	9,700 (h)
F-150 SuperCrew Cab Std Bed 2WD	3.5L V-6 TC	11,300 (i,t)
F-150 SuperCrew Cab SB 4WD	5.0L V-8	7,700 (h)
F-150 SuperCrew Cab SB 4WD	5.0L V-8	9,300 (i)
F-150 SuperCrew Cab SB 4WD	3.5L V-6 TC	8,200 (f)
F-150 SuperCrew Cab SB 4WD	3.5L V-6 TC	9,700 (h/i)
F-150 SuperCrew Cab SB 4WD	3.5L V-6 TC	11,300 (i,t)
F-150 SuperCrew Cab SB 4WD	6.2L V-8	11,100 (i,t)
F-150 SuperCrew H-D Edition/Lariat Ltd. 4WD	6.2L V-8	7,200 (i)
F-150 SVT Raptor SuperCrew Cab SB 4WD	6.2L V-8	8,000 (k)
F-150 SuperCrew Cab Std Bed 4WD	5.0L V-8	7,500 (h)
F-150 SuperCrew Cab Std Bed 4WD	5.0L V-8	9,100 (i)
F-150 SuperCrew Cab Std Bed 4WD	3.5L V-6 TC	8,000 (f)
F-150 SuperCrew Cab Std Bed 4WD	3.5L V-6 TC	9,600 (h/i)
F-150 SuperCrew Cab Std Bed 4WD	3.5L V-6 TC	11,200 (i,t)

*Requires heavy-duty payload package.

F-250/F-350/F-450 Super Duty, Conventional Towing

F-250/350 Reg. Cab SRW 2WD	6.2L V-8	12,500 (all)
F-250/350 Reg. Cab SRW 2WD	6.7L V-8 TD	12,500 (all)
F-250/350 Reg. Cab SRW 4WD	6.2L V-8	12,400 (i)
F-250/350 Reg. Cab SRW 4WD	6.2L V-8	12,500 (i)

F-250/350 Reg. Cab SRW 4WD	6.7L V-8 TD	12,500 (all)
F-350 Reg. Cab DRW 2WD	6.2L V-8	12,900 (i)
F-350 Reg. Cab DRW 2WD	6.2L V-8	15,000 (l)
F-350 Reg. Cab DRW 2WD	6.7L V-8 TD	15,000 (all)
F-350 Reg. Cab DRW 4WD	6.2L V-8	12,400 (k)
F-350 Reg. Cab DRW 4WD	6.2L V-8	15,000 (l)
F-350 Reg. Cab DRW 4WD	6.7L V-8 TD	15,000 (all)
F-250/F350 SC SRW 2WD	6.2L V-8	12,500 (all)
F-250/F350 SC SRW 2WD	6.7L V-8 TD	14,000 (all)
F-250 SC SRW 4WD	6.2L V-8	12,200 (i)
F-250 SC SRW 4WD	6.2L V-8	12,500 (l)
F-250 SC SRW 4WD	6.7L V-8 TD	13,800 (all)
F-350 SC SRW 4WD	6.2L V-8	12,100 (i)
F-350 SC SRW 4WD	6.2L V-8	12,500 (l)
F-350 SC SRW 4WD	6.7L V-8 TD	14,000 (all)
F-350 SC DRW 2WD	6.2L V-8	12,500 (i)
F-350 SC DRW 2WD	6.2L V-8	15,000 (l)
F-350 SC DRW 2WD	6.7L V-8 TD	15,000 (all)
F-350 SC DRW 4WD	6.2L V-8	12,100 (i)
F-350 SC DRW 4WD	6.2L V-8	15,000 (l)
F-350 SC DRW 4WD	6.7L V-8 TD	15,000 (all)
F-250/350 CC SRW 2WD	6.2L V-8	12,400 (i)
F-250/350 CC SRW 2WD	6.2L V-8	12,500 (k)
F-250/350 CC SRW 2WD	6.7L V-8 TD	14,000 (all)
F-250 CC SRW 4WD	6.2L V-8	12,000 (i)
F-250 CC SRW 4WD	6.2L V-8	12,500 (l)
F-250 CC SRW 4WD	6.7L V-8 TD	14,000 (all)
F-350 CC SRW 4WD	6.2L V-8	11,900 (i)
F-350 CC SRW 4WD	6.2L V-8	12,500 (l)
F-350 CC SRW 4WD	6.7L V-8 TD	14,000 (all)
F-350 CC DRW 2WD	6.2L V-8	12,200 (i)
F-350 CC DRW 2WD	6.2L V-8	15,000 (l)
F-350 CC DRW 2WD	6.7L V-8 TD	16,000 (all)
F-350 CC DRW 4WD	6.2L V-8	11,800 (i)
F-350 CC DRW 4WD	6.2L V-8	14,800 (l)
F-350 CC DRW 4WD	6.7L V-8 TD	16,000 (all)
F-450 DRW 4WD	6.7L V-8 TD	16,000 (all)

F-250/F-350/F-450 Super Duty, Fifth-Wheel Towing

F-250/350 Reg. Cab SRW 2WD	6.2L V-8	12,700 (i)
F-250/350 Reg. Cab SRW 2WD	6.2L V-8	15,700 (l)
F-250/350 Reg. Cab SRW 2WD	6.7L V-8 TD	16,500 (all)
F-250/350 Reg. Cab SRW 4WD	6.2L V-8	12,200 (i)
F-250/350 Reg. Cab SRW 4WD	6.2L V-8	15,200 (l)
F-250/350 Reg. Cab SRW 4WD	6.7L V-8 TD	16,100 (all)
F-350 Reg. Cab DRW 2WD	6.2L V-8	12,700 (i)
F-350 Reg. Cab DRW 2WD	6.2L V-8	15,700 (l)
F-350 Reg. Cab DRW 2WD	6.7L V-8 TD	22,600
F-350 Reg. Cab DRW 4WD	6.2L V-8	12,200 (i)
F-350 Reg. Cab DRW 4WD	6.2L V-8	15,200 (l)
F-350 Reg. Cab DRW 4WD	6.7L V-8 TD	22,100
F-250/350 SC SRW 2WD	6.2L V-8	12,500 (i)
F-250/350 SC SRW 2WD	6.2L V-8	15,500 (l)
F-250/350 SC SRW 2WD	6.7L V-8 TD	16,400 (f,h)
F-250 SC SRW 4WD	6.2L V-8	12,200 (i)

F-250 SC SRW 4WD	6.2L V-8	15,200 (l)
F-250 SC SRW 4WD	6.7L V-8 TD	16,100 (f,h)
F-350 SC SRW 4WD	6.2L V-8	12,100 (i)
F-350 SC SRW 4WD	6.2L V-8	15,100 (l)
F-350 SC SRW 4WD	6.7L V-8 TD	16,000 (f,h)
F-350 SC DRW 2WD	6.2L V-8	12,300 (i)
F-350 SC DRW 2WD	6.2L V-8	15,300 (l)
F-350 SC DRW 2WD	6.7L V-8 TD	22,100
F-350 SC DRW 4WD	6.2L V-8	11,800 (i)
F-350 SC DRW 4WD	6.2L V-8	14,800 (l)
F-350 SC DRW 4WD	6.7L V-8 TD	21,500
F-250/350 CC SRW 2WD	6.2L V-8	12,400 (i)
F-250/350 CC SRW 2WD	6.2L V-8	15,400 (l)
F-250/350 CC SRW 2WD	6.7L V-8 TD	16,000 (f,h)
F-250 CC SRW 4WD	6.2L V-8	12,000 (i)
F-250 CC SRW 4WD	6.2L V-8	15,000 (l)
F-250 CC SRW 4WD	6.7L V-8 TD	15,700 (f,h)
F-350 CC SRW 4WD	6.2L V-8	11,900 (i)
F-350 CC SRW 4WD	6.2L V-8	14,900 (l)
F-350 CC SRW 4WD	6.7L V-8 TD	15,800 (f,h)
F-350 CC DRW 2WD	6.2L V-8	12,000 (i)
F-350 CC DRW 2WD	6.2L V-8	15,000 (l)
F-350 CC DRW 2WD	6.7L V-8 TD	21,800
F-350 CC DRW 4WD	6.2L V-8	11,600 (i)
F-350 CC DRW 4WD	6.2L V-8	14,600 (l)
F-350 CC DRW 4WD	6.7L V-8 TD	21,300
F-450 CC DRW 4WD	6.7L V-8 TD	24,400

F-350/F-450/F-550 Super Duty Chassis Cab, Conventional Towing

F-350 Reg. Chassis Cab SRW 2WD	6.2L V-8	12,300 (i)
F-350 Reg. Chassis Cab SRW 2WD	6.2L V-8	12,500 (l)
F-350 Reg. Chassis Cab SRW 2WD	6.7L V-8 TD	12,500 (i)
F-350 Reg. Chassis Cab SRW 4WD	6.2L V-8	11,800 (i)
F-350 Reg. Chassis Cab SRW 4WD	6.2L V-8	12,500 (l)
F-350 Reg. Chassis Cab SRW 4WD	6.7L V-8 TD	12,500 (i)
F-350 Reg. Chassis Cab DRW 2WD	6.2L V-8	13,300 (i)
F-350 Reg. Chassis Cab DRW 2WD	6.2L V-8	15,000 (l)
F-350 Reg. Chassis Cab DRW 2WD	6.7L V-8 TD	15,000 (l/k)
F-350 Reg. Chassis Cab DRW 4WD	6.2L V-8	11,800 (i)
F-350 Reg. Chassis Cab DRW 4WD	6.2L V-8	14,800 (l)
F-350 Reg. Chassis Cab DRW 4WD	6.7L V-8 TD	15,000 (l/k)
F-450 Reg. Chassis Cab DRW 2WD	6.8L V-10	16,000
F-450 Reg. Chassis Cab DRW 2WD	6.7L V-8 TD	16,000
F-450 Reg. Chassis Cab DRW 4WD	6.8L V-10	16,000
F-450 Reg. Chassis Cab DRW 4WD	6.7L V-8 TD	16,000
F-550 Reg. Chassis Cab DRW 2WD	6.8L V-10	16,000
F-550 Reg. Chassis Cab DRW 2WD	6.7L V-8 TD	16,000
F-550 Reg. Chassis Cab DRW 4WD	6.8L V-10	16,000
F-550 Reg. Chassis Cab DRW 4WD	6.7L V-8 TD	16,000
F-350 Super Chassis Cab SRW 2WD	6.2L V-8	12,000 (i)
F-350 Super Chassis Cab SRW 2WD	6.2L V-8	12,500 (l)
F-350 Super Chassis Cab SRW 2WD	6.7L V-8 TD	12,500
F-350 Super Chassis Cab SRW 4WD	6.2L V-8	11,500 (i)
F-350 Super Chassis Cab SRW 4WD	6.2L V-8	12,500 (l)
F-350 Super Chassis Cab SRW 4WD	6.7L V-8 TD	12,500

F-350 Super Chassis Cab DRW 2WD	6.2L V-8	12,000 (i)
F-350 Super Chassis Cab DRW 2WD	6.2L V-8	15,000 (l)
F-350 Super Chassis Cab DRW 2WD	6.7L V-8 TD	15,000
F-350 Super Chassis Cab DRW 4WD	6.2L V-8	11,500 (i)
F-350 Super Chassis Cab DRW 4WD	6.2L V-8	14,500 (l)
F-350 Super Chassis Cab DRW 4WD	6.7L V-8 TD	15,000
F-450 Super Chassis Cab DRW 2WD	6.8L V-10	16,000
F-450 Super Chassis Cab DRW 2WD	6.7L V-8 TD	16,000
F-450 Super Chassis Cab DRW 4WD	6.8L V-10	16,000
F-450 Super Chassis Cab DRW 4WD	6.7L V-8 TD	16,000
F-550 Super Chassis Cab DRW 2WD	6.8L V-10	16,000
F-550 Super Chassis Cab DRW 2WD	6.7L V-8 TD	16,000
F-550 Super Chassis Cab DRW 4WD	6.8L V-10	16,000
F-550 Super Chassis Cab DRW 4WD	6.7L V-8 TD	16,000
F-350 Crew Chassis Cab SRW 2WD	6.2L V-8	11,700 (i)
F-350 Crew Chassis Cab SRW 2WD	6.2L V-8	12,500 (l)
F-350 Crew Chassis Cab SRW 2WD	6.7L V-8 TD	12,500
F-350 Crew Chassis Cab SRW 4WD	6.2L V-8	11,300 (i)
F-350 Crew Chassis Cab SRW 4WD	6.2L V-8	12,500 (l)
F-350 Crew Chassis Cab SRW 4WD	6.7L V-8 TD	12,500
F-350 Crew Chassis Cab DRW 2WD	6.2L V-8	11,700 (i)
F-350 Crew Chassis Cab DRW 2WD	6.2L V-8	14,700 (l)
F-350 Crew Chassis Cab DRW 2WD	6.7L V-8 TD	15,000
F-350 Crew Chassis Cab DRW 4WD	6.2L V-8	11,300 (i)
F-350 Crew Chassis Cab DRW 4WD	6.2L V-8	14,300 (l)
F-350 Crew Chassis Cab DRW 4WD	6.7L V-8 TD	15,000
F-450 Crew Chassis Cab DRW 2WD	6.8L V-10	16,000
F-450 Crew Chassis Cab DRW 2WD	6.7L V-8 TD	16,000
F-450 Crew Chassis Cab DRW 4WD	6.8L V-10	16,000
F-450 Crew Chassis Cab DRW 4WD	6.7L V-8 TD	16,000
F-550 Crew Chassis Cab DRW 2WD	6.8L V-10	16,000
F-550 Crew Chassis Cab DRW 2WD	6.7L V-8 TD	16,000
F-550 Crew Chassis Cab DRW 4WD	6.8L V-10	16,000
F-550 Crew Chassis Cab DRW 4WD	6.7L V-8 TD	16,000

F-350/F-450/F-550 Super Duty Chassis Cab, Fifth-Wheel Towing

F-350 Reg. Chassis Cab SRW 2WD	6.2L V-8	12,300 (i)
F-350 Reg. Chassis Cab SRW 2WD	6.2L V-8	15,300 (i)
F-350 Reg. Chassis Cab SRW 2WD	6.7L V-8 TD	16,000
F-350 Reg. Chassis Cab SRW 4WD	6.2L V-8	11,800 (i)
F-350 Reg. Chassis Cab SRW 4WD	6.2L V-8	14,800 (l)
F-350 Reg. Chassis Cab SRW 4WD	6.7L V-8 TD	15,500
F-350 Reg. Chassis Cab DRW 2WD	6.2L V-8	13,300 (i)
F-350 Reg. Chassis Cab DRW 2WD	6.2L V-8	16,300 (l)
F-350 Reg. Chassis Cab DRW 2WD	6.7L V-8 TD	16,500
F-350 Reg. Chassis Cab DRW 4WD	6.2L V-8	11,800 (i)
F-350 Reg. Chassis Cab DRW 4WD	6.2L V-8	14,800 (l)
F-350 Reg. Chassis Cab DRW 4WD	6.7L V-8 TD	16,100
F-450 Reg. Chassis Cab DRW 2WD	6.8L V-10	18,300
F-450 Reg. Chassis Cab DRW 2WD	6.7L V-8 TD	17,400 (k)
F-450 Reg. Chassis Cab DRW 2WD	6.7L V-8 TD	21,400 (l,t)
F-450 Reg. Chassis Cab DRW 4WD	6.8L V-10	17,900
F-450 Reg. Chassis Cab DRW 4WD	6.7L V-8 TD	17,000 (k)
F-450 Reg. Chassis Cab DRW 4WD	6.7L V-8 TD	21,000 (l,t)
F-550 Reg. Chassis Cab DRW 2WD	6.8L V-10	18,200

F-550 Reg. Chassis Cab DRW 2WD	6.7L V-8 TD	17,400 (k)
F-550 Reg. Chassis Cab DRW 2WD	6.7L V-8 TD	26,400 (l,t)
F-550 Reg. Chassis Cab DRW 2WD	6.7L V-8 TD	17,200 (q)
F-550 Reg. Chassis Cab DRW 2WD	6.7L V-8 TD	26,200 (q,t)
F-550 Reg. Chassis Cab DRW 4WD	6.8L V-10	17,900
F-550 Reg. Chassis Cab DRW 4WD	6.7L V-8 TD	17,000 (k)
F-550 Reg. Chassis Cab DRW 4WD	6.7L V-8 TD	26,000 (l,t)
F-550 Reg. Chassis Cab DRW 4WD	6.7L V-8 TD	16,900 (q)
F-550 Reg. Chassis Cab DRW 4WD	6.7L V-8 TD	25,900 (q,t)
F-350 Super Chassis Cab SRW 2WD	6.2L V-8	12,000 (i)
F-350 Super Chassis Cab SRW 2WD	6.2L V-8	15,000 (l)
F-350 Super Chassis Cab SRW 2WD	6.7L V-8 TD	15,500
F-350 Super Chassis Cab SRW 4WD	6.2L V-8	11,500 (i)
F-350 Super Chassis Cab SRW 4WD	6.2L V-8	14,500 (l)
F-350 Super Chassis Cab SRW 4WD	6.7L V-8 TD	15,000
F-350 Super Chassis Cab DRW 2WD	6.2L V-8	12,000 (i)
F-350 Super Chassis Cab DRW 2WD	6.2L V-8	15,000 (l)
F-350 Super Chassis Cab DRW 2WD	6.7L V-8 TD	16,200
F-350 Super Chassis Cab DRW 4WD	6.2L V-8	11,500 (i)
F-350 Super Chassis Cab DRW 4WD	6.2L V-8	14,500 (l)
F-350 Super Chassis Cab DRW 4WD	6.7L V-8 TD	15,600
F-450 Super Chassis Cab DRW 2WD	6.8L V-10	17,800
F-450 Super Chassis Cab DRW 2WD	6.7L V-8 TD	17,000 (k)
F-450 Super Chassis Cab DRW 2WD	6.7L V-8 TD	21,000 (l,t)
F-450 Super Chassis Cab DRW 4WD	6.8L V-10	17,400
F-450 Super Chassis Cab DRW 4WD	6.7L V-8 TD	16,600 (k)
F-450 Super Chassis Cab DRW 4WD	6.7L V-8 TD	20,600 (l,k)
F-550 Super Chassis Cab DRW 2WD	6.8L V-10	17,800
F-550 Super Chassis Cab DRW 2WD	6.7L V-8 TD	17,000 (k)
F-550 Super Chassis Cab DRW 2WD	6.7L V-8 TD	26,000 (l,t)
F-550 Super Chassis Cab DRW 2WD	6.7L V-8 TD	16,800 (q)
F-550 Super Chassis Cab DRW 2WD	6.7L V-8 TD	25,800 (q,t)
F-550 Super Chassis Cab DRW 4WD	6.8L V-10	17,400
F-550 Super Chassis Cab DRW 4WD	6.7L V-8 TD	16,600 (k)
F-550 Super Chassis Cab DRW 4WD	6.7L V-8 TD	25,600 (l,t)
F-550 Super Chassis Cab DRW 4WD	6.7L V-8 TD	16,500 (q)
F-550 Super Chassis Cab DRW 4WD	6.7L V-8 TD	25,500 (q,t)
F-350 Crew Chassis Cab SRW 2WD	6.2L V-8	11,700 (i)
F-350 Crew Chassis Cab SRW 2WD	6.2L V-8	14,700 (l)
F-350 Crew Chassis Cab SRW 2WD	6.7L V-8 TD	15,300
F-350 Crew Chassis Cab SRW 4WD	6.2L V-8	11,300 (i)
F-350 Crew Chassis Cab SRW 4WD	6.2L V-8	14,200 (l)
F-350 Crew Chassis Cab SRW 4WD	6.7L V-8 TD	14,800
F-350 Crew Chassis Cab DRW 2WD	6.2L V-8	11,700 (i)
F-350 Crew Chassis Cab DRW 2WD	6.2L V-8	14,700 (l)
F-350 Crew Chassis Cab DRW 2WD	6.7L V-8 TD	15,900
F-350 Crew Chassis Cab DRW 4WD	6.2L V-8	11,300 (i)
F-350 Crew Chassis Cab DRW 4WD	6.2L V-8	14,300 (l)
F-350 Crew Chassis Cab DRW 4WD	6.7L V-8 TD	15,500
F-450 Crew Chassis Cab DRW 2WD	6.8L V-10	17,600
F-450 Crew Chassis Cab DRW 2WD	6.7L V-8 TD	16,800 (k)
F-450 Crew Chassis Cab DRW 2WD	6.7L V-8 TD	20,800 (l,t)
F-450 Crew Chassis Cab DRW 4WD	6.8L V-10	17,200
F-450 Crew Chassis Cab DRW 4WD	6.7L V-8 TD	16,300 (k)
F-450 Crew Chassis Cab DRW 4WD	6.7L V-8 TD	20,300 (l,t)
F-550 Crew Chassis Cab DRW 2WD	6.8L V-10	17,600

F-550 Crew Chassis Cab DRW 2WD	6.7L V-8 TD	16,800 (k)
F-550 Crew Chassis Cab DRW 2WD	6.7L V-8 TD	25,800 (l,t)
F-550 Crew Chassis Cab DRW 2WD	6.7L V-8 TD	16,600 (q)
F-550 Crew Chassis Cab DRW 2WD	6.7L V-8 TD	25,600 (q,t)
F-550 Crew Chassis Cab DRW 2WD	6.8L V-10	17,200
F-550 Crew Chassis Cab DRW 2WD	6.7L V-8 TD	16,300 (k)
F-550 Crew Chassis Cab DRW 2WD	6.7L V-8 TD	25,300 (l,t)
F-550 Crew Chassis Cab DRW 2WD	6.7L V-8 TD	16,300 (q)
F-550 Crew Chassis Cab DRW 2WD	6.7L V-8 TD	25,300 (q,t)

HONDA

Odyssey	3.5L V-6	3,500
Pilot 2WD	3.5L V-6	3,500
Pilot 4WD	3.5L V-6	4,500
Ridgeline	3.5L V-6	5,000

HYUNDAI

Santa Fe	2.4 I-4	2,000
Santa Fe	3.5 V-6	3,500
Tucson	All	2,000
Veracruz (all)	3.8L V-6	3,500 (t)

INFINITI

QX56	5.6L V-8	8,500
FX35 AWD	3.5L V-6	2,000
FX50	5.0L V-8	3,500

JEEP

Grand Cherokee 2WD	3.6L V-6	5,000
Grand Cherokee 2WD	5.7L V-8	7,400 (t)
Grand Cherokee 4WD	3.6L V-6	5,000
Grand Cherokee 4WD	5.7L V-8	7,200 (t)
Liberty 2WD	3.7L V-6	5,000 (t)
Liberty 4WD	3.7L V-6	5,000 (t)
Patriot	2.4L I-4	2,000 (t)
Wrangler	3.8L V-6	2,000
Wrangler Unlimited	3.8L V-6	3,500
Wrangler Unlimited Rubicon	3.8L V-6	3,500

KIA

Sedona	3.8L V-6	3,500
Sorento	3.5L V-6	3,500
Sportage	2.4 I-4	2,000

LAND ROVER

Land Rover LR2	3.2L I-6	3,500
Land Rover LR4	5.0L V-8	7,716
Range Rover	5.0L V-8	7,716
Range Rover Sport	All	7,716

LEXUS

RX 350	3.5L V-6	3,500
RX 450h (Hybrid)	3.5L V-6	3,500
GX 470	4.6L V-8	6,500
LX 570	5.7L V-8	7,000

LINCOLN-MERCURY

Mariner	3.0L V-6	3,500 (t)
MKT	All	2,000
MKT	All	4,500 (t)
MKX	All	2,000
MKX	All	3,500 (t)
Navigator 2WD	5.4L V-8	6,000
Navigator 2WD	5.4L V-8	9,000 (t)
Navigator L 2WD	5.4L V-8	6,000
Navigator L 2WD	5.4L V-8	8,700 (t)
Navigator 4WD	5.4L V-8	6,000
Navigator 4WD	5.4L V-8	8,700 (t)
Navigator L 4WD	5.4L V-8	6,000
Navigator L 4WD	5.4L V-8	8,500 (t)

MAZDA

CX7 (all)	2.3L TC	2,000
CX9 (all)	3.7L V-6	3,500
Tribute	3.0L V-6	3,450

MERCEDES-BENZ

G550	5.5L V-8	3,500
G55 AMG	5.4L V-8	3,500
GLK	3.5L V-6	3,500
GL320 BlueTEC	3.0L TD V-6	7,500
GL450	4.6L V-8	7,500
GL550	5.5L V-8	7,500
ML320 BlueTEC	3.0L TD V-6	7,200
ML350 2WD	3.5L V-6	4,600
ML350 4WD	3.5L V-6	7,200
ML450 Hybrid	3.5L V-6	5,000
ML550	5.5L V-8	7,200
ML63 AMG	6.3L V-8	7,200

MITSUBISHI

Outlander 2WD	3.0L V-6	2,000
Outlander 4WD	3.0L V-6	3,500
Endeavor	3.8L V-6	3,500

NISSAN

Armada 2WD	5.6L V-8	8,200
Armada 4WD	5.6L V-8	9,000
Frontier KC 2WD	2.5L I-4	3,500
Frontier KC SV V-6, Pro-4X V-6 2WD	4.0L V-6	6,500
Frontier KC SV V-6, Pro-4X V-6 4WD	4.0L V-6	6,300
Frontier CC 2WD	4.0L V-6	6,300
Frontier CC 4WD	4.0L V-6	6,100
Murano	3.5L V-6	3,500
Pathfinder	4.0L V-6	6,000
Pathfinder	5.6L V-8	7,000
Quest	3.5L V-6	3,500
Titan KC 2WD SB	5.6L V-8	7,400
Titan KC 4WD SB	5.6L V-8	9,400
Titan CC 2WD	5.6L V-8	9,400
Titan CC 4WD	5.6L V-8	9,100

Titan LB CC 2WD	5.6L V-8	9,400
Titan LB CC 4WD	5.6L V-8	9,100
Xterra	4.0L V-6	5,000

PORSCHE

Cayenne	All	7,716
---------	-----	-------

SUBARU

Tribeca	3.6L H6	2,400
Tribeca	3.6L H6	3,500 (t)
Forester	2.5L H4	2,400
Outback	2.5L H4	2,700
Outback	3.6R H6	3,000

SUZUKI

Equator Extended Cab	2.5L I-4	3,500
Equator Extended Cab	4.0L V-6	6,500
Equator Crew Cab 2WD	4.0L V-6	6,300
Equator Crew Cab 4WD	4.0L V-6	6,100
Grand Vitara	2.4L I-4	3,000

TOYOTA

4Runner 2WD	2.7L I-4	2,000
-------------	----------	-------

4Runner 4WD	4.0L V-6	5,000
FJ Cruiser	4.0L V-6	5,000
Highlander	2.7L I-4	3,500 (t)
Highlander	3.5L V-6	2,000
Highlander	3.5L V-6	5,000 (t)
Highlander Hybrid	3.3L V-6	3,500
Land Cruiser	5.7L V-8	8,200
RAV4	3.5L V-6	2,000
RAV4	3.5L V-6	3,500 (t)
Sienna	3.5L V-6	3,500
Sequoia 2WD SR5	4.6L V-8	6,900
Sequoia 4WD SR5	4.6L V-8	6,600
Sequoia 2WD SR5	5.7L V-8	7,400
Sequoia 4WD SR5	5.7L V-8	7,100
Sequoia 2WD Ltd	5.7L V-8	7,300
Sequoia 4WD Ltd	5.7L V-8	7,100
Sequoia 2WD Platinum	5.7L V-8	7,200
Sequoia 4WD Platinum	5.7L V-8	7,000
Tacoma Reg. Cab	2.7L I-4	3,500
Tacoma Access Cab/X-Runner	2.7L I-4	3,500
Tacoma Access Cab 2WD/4WD	4.0L V-6	5,000
Tacoma Access Cab 2WD/4WD	4.0L V-6	6,500 (t)
Tacoma Double Cab 2WD/4WD	4.0L V-6	5,000



Tacoma Double Cab 2WD/4WD	4.0L V-6	6,500 (t)
Tundra Reg. Cab SB	4.0L V-6	4,900
Tundra Reg. Cab LB	4.0L V-6	4,800
Tundra Double Cab SB	4.0L V-6	4,500
Tundra Reg. Cab SB 2WD	4.6L V-8	7,000
Tundra Reg. Cab SB 2WD	4.6L V-8	8,600 (t)
Tundra Reg. Cab SB 4WD	4.6L V-8	7,200
Tundra Reg. Cab SB 4WD	4.6L V-8	8,700 (t)
Tundra Reg. Cab LB 2WD	4.6L V-8	7,400
Tundra Reg. Cab LB 2WD	4.6L V-8	8,900 (t)
Tundra Reg. Cab LB 2WD	5.7L V-8	10,500 (t)
Tundra Reg. Cab LB 4WD	4.6L V-8	7,100
Tundra Reg. Cab LB 4WD	4.6L V-8	8,600 (t)
Tundra Reg. Cab LB 4WD	5.7L V-8	10,800 (t)
Tundra Double Cab SB 2WD	4.6L V-8	8,200
Tundra Double Cab SB 2WD	4.6L V-8	8,600 (t)
Tundra Double Cab SB 4WD	4.6L V-8	7,900
Tundra Double Cab SB 4WD	4.6L V-8	8,300 (t)
Tundra Double Cab Std Bed 2WD	4.6L V-8	7,100
Tundra Double Cab Std Bed 2WD	4.6L V-8	8,600 (t)
Tundra Double Cab LB 2WD	4.6L V-8	8,500
Tundra Double Cab Std Bed 4WD	4.6L V-8	6,800
Tundra Double Cab Std Bed 4WD	4.6L V-8	8,300 (t)

Tundra Double Cab LB 4WD	4.6L V-8	8,200
Tundra Reg. Cab 2WD	5.7L V-8	10,400
Tundra Reg. Cab 4WD	5.7L V-8	10,100
Tundra Double Cab 2WD	5.7L V-8	10,100
Tundra Double Cab 4WD	5.7L V-8	9,800
Tundra CrewMax 2WD	4.6L V-8	8,100
Tundra CrewMax 4WD	4.6L V-8	7,700 (t)
Tundra CrewMax 2WD	5.7L V-8	9,900
Tundra CrewMax 4WD	5.7L V-8	9,000

VOLKSWAGEN

Tiguan	2.0L I-4TC	2,200
Touareg	All	7,716

Volvo

C30	5TC	2,000
S40	All	2,000
S80	All	3,300
V50	All	2,000
XC60	All	3,300
XC70	All	3,300
XC90 FWD	All	3,300
XC90 AWD	All	3,300



HITCHING BASICS

Selecting and maintaining the proper hardware for tow vehicle and trailer

BY JOEL DONALDSON

The process of buying a new travel trailer or fifth-wheel is filled with choices. Negotiating a price; arranging financing; settling on a fair trade-in value for your old rig; and choosing insurance, floorplans, décor schemes and optional equipment are only the beginning. However, one of the most important choices may be considered an afterthought: namely, choosing the proper trailer hitch.

Fortunately, selecting the right hitch isn't difficult, nor is its installation, after locating a competent shop, that is. Maintaining proper adjustment of the hitch on an ongoing basis is important, and it has a large bearing on the safety and ease of trailer towing.

Trailers are available in two different designs, a travel trailer that's coupled to the rear of the tow vehicle by a conventional hitch ball, and a fifth-wheel trailer that utilizes a fifth-wheel (or gooseneck) hitch mounted in the truck bed, centered over the rear axle. The hitching methods are as different as the trailers and require specific knowledge by the installer and trailer owner.

Conventional Hitches

All hitches are rated by their respective manufacturers to safely handle up to a specific gross vehicle weight (gvw), which is the weight of the trailer with full water and LP-gas cylinders and all supplies aboard. Several weight classes exist for hitches designed for towing conventional travel trailers.

Weight-carrying hitches are intended for lighter trailers because the entire trailer's hitch weight is carried on the ball and transferred to the rear axle of the tow vehicle, whereas weight-distributing hitches are designed to distribute the trailer's hitch weight to all axles of the tow vehicle and trailer, making larger, heavier trailers with considerably higher hitch weights towable without destabilizing the tow vehicle.

A travel trailer with ideal weight distribution will have a minimum hitch weight of about 10 percent of the gross weight, and the



maximum can range upward to about 15 percent, provided it does not violate the rating of the hitch.

Except for the lightest folding trailers, hitches rated Class II and higher are used for recreational towing, and they use a receiver bolted to the tow vehicle's frame. The hitch receiver — which may have box dimensions of 1¼ inches square, 2 inches square or 2½ inches square, with the larger boxes for higher load ratings — accepts a slide-in ball mount (or draw bar), which is secured with a pin.

Besides serving as the trailer/receiver attachment point, the ball mount also is used in varying heights (known as "drop") to couple the trailer in a level fashion (frame parallel to the road surface), which is desirable for best stability and trailer-brake performance. Some ball mounts are fixed, while others are adjustable.

Ball mounts used for weight-carrying



hitches are quite different than those used for weight-distributing. The need for weight-distributing hitches varies with tow-vehicle type and trailer weight. A trailer with 350 pounds of hitch weight may present no challenge for a stiffly sprung, long-wheelbase HD pickup, while it may destabilize a softly sprung compact SUV. In general, a weight-distributing hitch will improve stability in most situations because weight resting on a hitch ball (when a weight-carrying hitch is used) loads the rear axle excessively by placing all of the hitch weight on that axle in addition to weight that is transferred from the front axle to the rear in a see-saw lever action.

Because many receivers are usable in either weight-carrying or weight-distributing configurations, depending on the ball mount, the receiver manufacturer may list both ratings.

Weight-distributing hitches should be

used in many weight situations of Class II, and in most situations of Class III and above. Unlike their weight-carrying counterparts, these hitches typically use a much heavier ball mount (that's height-adjustable), plus a pair of spring bars that provide the leverage needed to distribute weight fore and aft.

Hitch Adjustment

After having a weight-distributing hitch of proper weight rating installed, owners may take the rest for granted, which can be a costly error because an improperly adjusted weight-distributing hitch can contribute to trailer sway, which is a very undesirable, and unsafe, handling trait.

The keys to happy towing are proper hitch-ball height and proper tension on the spring bars. When all aspects are correct, the tow vehicle and the trailer are at the proper ride height, which in most cases is level. One exception will be described later. Proper hitch adjustment helps prevent rear-axle overloading and improves braking and steering response.

Evaluating the proper adjustment of a weight-distributing hitch is relatively simple: The tow vehicle should maintain the same attitude before hitching that it does after hitching, measured at reference points at the front and rear bumpers or wheel wells. If it is level before hitching, it should be level afterward, although slightly lower due to the addition of hitch weight. A level attitude means the adequate load has been placed on the spring bars to distribute portions of the hitch weight equally to the front and rear axles. If the rear of the tow vehicle sags after hitching, then the spring-bar loading isn't adequate.

The exception to level attitude: If the tow vehicle is a stiffly sprung pickup and the rear of the truck is higher than the front, that attitude should be maintained after hitching. Such trucks often will carry heavy loads without the need for weight-distributing hitches and without sagging. But care must be exercised here. Although the truck may not look like it's sagging visually, the hitch weight carried by the rear axle may still create an unstable situation.

If the trailer is not level after the spring bars have been adjusted to create the proper tow-vehicle attitude, the ball height should be corrected.

Trailer sway can be a problem if trailer balance or hitch adjustment are not correct because the trailer exerts steering leverage on the tow vehicle by virtue of being connected to the tow vehicle 3 or 4 feet behind the rear axle. With correct hitching, trailer balance

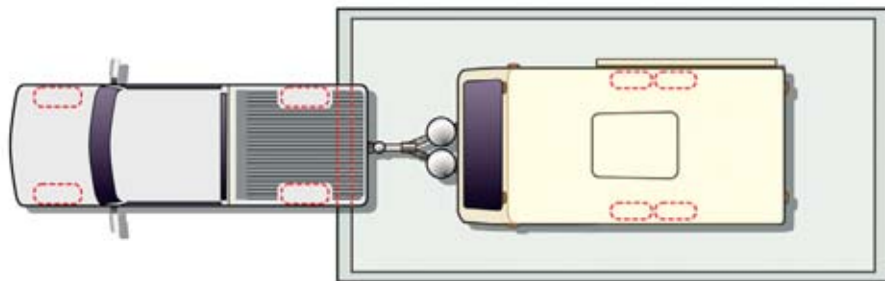

To determine weight, first get a reading on axle weight, then unhitch the trailer for a total weight reading (with the tow vehicle's wheels off the scale), and then subtract the two.

may be a problem if the hitch weight is less than 10 percent of gross weight. It should be more than 10 percent (we recommend a minimum of 12 percent) for best stability.

Even with a well-balanced trailer and a properly adjusted hitch, use of a sway-control device is highly recommended. Often called sway bars (not to be confused with anti-roll bars fitted to axles of tow vehicles), sway-control devices are designed to damp rotation of the coupler on the hitch ball. They improve the handling characteristics of the trailer/tow vehicle combination whether the hitch method is weight-carrying or weight-distributing.

Sway-control devices are available in two different configurations, the most popular of which is one that employs a steel bar, attached to the ball mount, that is encased in a rail or tube attached to a small ball on the trailer A-frame. Inside the rail or tube is friction material that is clamped against the steel bar. Any pivoting of the trailer coupler on the bar causes the bar to slide within the rail, creating drag and damping sway. On larger trailers, it's often possible to use a pair of friction-type units for additional sway control.

One popular hitch, the Equal-i-zer, includes a friction feature in the hitch design in that the tips of spring bars create friction on trailer-frame brackets. Cam-type sway units work by modifying the operation of the spring bars on a weight-distributing hitch. As the trailer turns, a cam increases the tension on one of the bars, creating a force that tends to pull the trailer back into a straight line. The harder the trailer turns, the stronger this self-centering force becomes. Since this scheme relies on spring-bar tension, it's generally most effective on trailers with relatively high hitch weights (e.g., trailers requiring considerable spring-bar tension).

The Hensley Arrow and PullRite hitch systems offer different approaches to controlling sway.

The Hensley unit prevents sway through use of trapezoidal hitch linkages that make the tow vehicle and trailer act as a single unit, with no pivoting of the coupler on the ball unless the tow vehicle turns. Thus, during typical highway travel the tow vehicle and trailer are connected as non-articulated vehicles, and tend to function as a single unit. Even so, there is no restriction on the tow vehicle's capability for turns.

The PullRite, in effect, moves the hitch-pivot point to a location immediately aft of the tow vehicle's rear axle, dramatically reducing the leverage the trailer can exert on the tow vehicle.

Fifth-Wheel Hitches

Fifth-wheel towing is a different story altogether. The trailer's kingpin serves as the pivot point for the fifth-wheel hitch, which is centered slightly ahead or over the truck's rear





Using a weight-carrying hitch



Using a weight-distributing hitch

A weight-distributing hitch distributes weight to all axles of the tow vehicle and the trailer.

axle. The trailer's kingpin slides into the hitch saddle, where it is secured by latching jaws or some other mechanism. This saddle is attached to a support base, which transfers the towing forces to the truck frame.

The design prevents the trailer from having any steering effect on the tow vehicle, and is what gives fifth-wheel trailers such good road manners. Wind gusts and road irregularities have little or no effect on tow-vehicle stability.

Most hitches are secured to the bed with a pair of mounting rails, while other underbed systems leave the truck bed flat after the hitch is removed.

Until recently, fifth-wheel hitches have been strictly aftermarket add-ons. But Ford upped the ante on 2011 Super Duty trucks with the introduction of a factory-installed fifth-wheel (and gooseneck) hitch, providing clean installation and a factory warranty. The trailer's electrical connection has been mounted into

the side of the bed for added convenience.

Most removable aftermarket systems use permanently mounted rails with pins to secure the hitch saddle. The underbed style of the fifth-wheel-hitch mount is completely different in that the entire hitch mechanism is removed by simply pulling a lever in the wheel well. PullRite also uses an underbed system with removable connection pins. Some systems, such as the B&W Turnover Ball and Companion, allow the hitch saddle and support base to be removed separately, making it easier on the back when lifting the hardware.

Many fifth-wheel hitches are mounted so they tilt fore and aft; however, having only the fore-and-aft pivot restricts side-to-side movement.

Some hitches have heads that pivot in multiple directions, allowing the pinbox to move in any direction with respect to the pickup, while still maintaining a tight mechanical connection. This also makes it easier to hitch or unhitch the trailer on uneven ground.

Another strategy for improving trailer-truck flexibility involves the use of air springs as part of the hitch design. Typically, the hitch is suspended on multiple bladder-type air bags, which support most of the trailer's kingpin weight. Aside from providing considerable articulation, these bags are also capable of smoothing out much of the road shocks and vibration that would otherwise be transmitted from the trailer to the tow vehicle. Adjustments to the system can be accomplished by varying the amount of air pressure in the bags.

Other suspension-type hitches use a hinged pivot arm and a single airbag setup or a rubber spring in shear to provide truck-to-trailer impact damping while the hitch-saddle mechanism provides the side- and fore/aft head tilting.

Shortbed pickups are now more popular than ever, particularly among extended-cab models. However, a short bed often causes





Hensley Cub



Equal-i-zer Sway-Control Hitch



Draw-Tite W-D Hitch

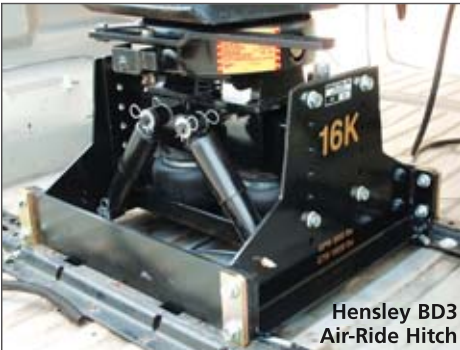

Hensley BD3
Air-Ride Hitch



Reese Sidewinder

complications when using the truck for towing a fifth-wheel because the proper hitch-mounting location is far enough forward to cause trailer-to-cab collisions during sharp turns. Installing an extended pinbox provides a workable solution with smaller trailers with modest pin weights; however, owners should first check with the pinbox manufacturer before adding any extension.

One solution is a conventional hitch that can be manually unlocked and moved aft on a special set of rails before making tight turns. PullRite offers a hitch that performs this motion automatically, returning to the forward-towing position after the turn is completed. Rearward travel can be as much as 22 inches for some models, which is generally adequate for accommodating 102-inch-wide trailers. Turns as tight as 90 degrees are possible.

Some companies offer manually moving hitches to accommodate sharp turns, but the owner is responsible for unlatching the mechanism. Another system, the Reese Sidewinder, uses a special pin box that automatically handles clearance problems.

Maximum weight ratings for fifth-wheel hitches range up to 25,500 pounds gross weight, with as much as 25 percent of it on the hitch (most fivers have 20 percent hitch weight or less), and it's best to choose a unit that not only will handle the trailer it will be used to tow, but also any possibility of a larger trailer, although a higher-rated hitch will cost more and will be slightly heavier.

Whether towing a conventional trailer or a fifth-wheel, the use of a properly rated hitch, adjusted correctly, will aid in creating a safer and more manageable towing experience. 🚚

TRAILER-BRAKE CONTROL



Technological advances help smooth out the process and improve safety and reliability

BY CHUCK HAMMOCK

Electric-brake systems have been employed for several decades on most trailers that have any significant weight. Each trailer with electric brakes, in turn, also requires that the tow vehicle be fitted with a brake controller.

For years, brake-controller choices have been extensive — all aftermarket and all electronic. Ford changed the game in 2005 with the first trailer-brake-control (TBC) system included as a factory-installed integral part of the tow vehicle's design, and both GM and Dodge have since followed suit. The TBC synchronizes vehicle and trailer brakes for seamless braking, even under heavy load, to provide added driving control and confidence.

Until the advent of anti-lock brake systems (ABS), most brake controllers were tapped directly into the hydraulic lines of the tow vehicle's on-board hydraulic-braking system. They were often described as hydraulic/electric brake controllers, as they converted hydraulic pressure in the tow vehicle's brake system to an electric signal used to activate the trailer's brakes directly proportional to hydraulic pressure in the vehicle's braking system. A significant factor in elimination of this system was the advent of ABS because the tow vehicle manufacturers cautioned against tapping into the hydraulic system.

Ford's TBC System

As Ford was first to offer a factory-installed brake controller in the tow vehicle, let's look at its system. Ford's integrated controller electronically tracks hydraulic pressure inside the vehicle's master cylinder and uses the pressure, along with vehicle speed, to modulate the amount of current produced for trailer brakes. Thus, the system accurately follows tow-vehicle braking with more at high pedal pressure, less at low, even to the point of using ABS. If the wheels of the tow vehicle are slipping, ABS goes into action for the tow vehicle as well as the trailer. The Ford system doesn't give the trailer the same functions and characteristics of true ABS, but when the truck's ABS is activated, the trailer-brake application is reduced to avoid wheel lockup, just as with true ABS. A dash monitor indicates the level of trailer braking, and a manual override is provided so the trailer brakes can be applied independently of tow-vehicle brakes. TBC-equipped 2011 Ford Super Duty trucks also enjoy an added element of safety; if the trailer is swaying, the TBC will actually apply the trailer brakes to help stabilize the trailer.

While the Ford brake control uses brake pressure sensing, both the GM and Dodge integrated controllers use inertia-type sensing to regulate trailer brake action. None of the

2011 **TRAILER LIFE** Towing Guide | 33



Hensley TruControl Gold



Tekonsha Prodigy P2

systems can be retrofitted to earlier truck models, and aftermarket controllers still must be used for most other vehicles, so the demand for those aftermarket controllers remains quite large. Accordingly, it's helpful to understand what's out there, and how to make a good choice.

In essence, all electronic brake controllers fall into two general categories: timer-based brake controllers and inertia-based proportional brake controllers. All brake controllers generate an output signal to a trailer-brake system when a user first touches the tow vehicle's brake pedal or activates the brake controller's manual control, if so equipped. What happens next varies greatly, depending on whether you're using a timer-based or proportional brake controller.

While most manufacturers identify their proportional brake controllers as such, you usually won't see the words "timer-based" in the literature for a nonproportional brake controller. Instead, marketers will sometimes advertise timer-based controllers as having the advantage of requiring no leveling, but even that idea is confusing. Several proportional brake controllers do not require leveling. Timer-based controllers are also touted as being microprocessor-operated, but all brake controllers contain a processor of some kind. Even the most sophisticated timer-based microprocessor doesn't determine how hard you are braking, only how long you've been braking. A good rule of thumb is that if it doesn't say the word "proportional" somewhere in the literature, it's probably a timer-based brake controller.

Timer-Based vs. Proportional

A timer-based brake controller has a timer that generates an output signal for your RV's brakes that increases with the amount of time

you keep your foot on the brake pedal. It doesn't know whether you're braking gently on a gradual downhill grade, or if you're in a panic stop. The rate of increase in output (the slope of the voltage ramp) has no bearing on pedal effort, but can usually be adjusted for braking aggressiveness.

An inertia-based proportional controller generates an output that is, as the name suggests, directly proportional to your braking needs. Most proportional brake controllers measure the tow vehicle's rate of deceleration by means of a pendulum. The quicker you slow, the farther the pendulum is displaced, via inertia, from its at-rest position. This creates an electric signal to your trailer's brakes that is proportional to your deceleration rate.

Tekonsha and its sister companies use a series of LEDs and photoelectric detectors in their proportional controllers to determine the position of the displaced pendulum, and therefore determine the deceleration rate. Hayes Lemmerz uses the Hall effect, a physics principal involving moving magnets, to determine the pendulum's position.

All pendulum controllers are subject to some inaccuracies, as the pendulum can tilt slightly forward or backward on steep grades. Most such controllers employ a damping device to stabilize the sensor against vibrations, and the damper helps reduce the effect of the fore-or-aft-tilt problem.

The pendulum's position is adjusted through the level-control knob, which allows the pendulum to be oriented to a true vertical resting position to compensate for the angle of the brake-controller body (the "leveling" referred to in some timer-based-controller advertising). The level adjustment also allows the driver to pitch the pendulum slightly forward or aft of its normal resting position to set up the trailer so its braking is aggressive or delayed.



Hayes Lemmerz Energize XPC



Valley Blackbird

Most drivers prefer some braking effect from the trailer's brakes on the initial touch of the brake pedal, and adjust the brake controller accordingly to provide this so-called threshold voltage. This adjustment produces some output (typically 2 volts), without the initial time period having passed or deceleration having occurred in the two electric brake-controller types. This time period, or deceleration event, is normally needed to activate the timer-based controller or the proportional pendulum-based controller, respectively.

With dozens of different models of brake controllers on the market, many RVers may find the selection of the right controller difficult without some form of guidance. While budgetary considerations may force a user into one category of controller, this is a critical system where pinching pennies may not be advisable.

When faced with the need for a panic stop, most drivers want a controller that will respond in proportion to their braking needs at that moment. Keep in mind that a timer-based controller can't respond in this manner, as its output is fixed for a certain timed duration.

Among more recent developments, solid-state accelerometers are being used to measure braking force. Tekonsha has embraced this technology in its Prodigy P2 brake control. Hensley Manufacturing also uses accelerometers in its high-tech TruControl trailer brake control.

Some brake controllers aren't compatible with disc-brake systems on trailers; in such cases, the installation of a controller module — such as the Carlisle HydraStar — is necessary on the trailer in order to ensure functional braking.

Aftermarket Installation

Critical to every successful brake-controller installation is the proper tow-vehicle wiring. While you should carefully follow the manu-

facturer's recommendations, there are certain common elements to almost every controller.

A reliable power source is a priority, which may include a vehicle's built-in circuitry for an aftermarket brake controller. The main power line should be at least a 10 AWG wire from a circuit breaker at the fuse box, or the battery, to the brake controller's power-input connection (follow specific instructions for your controller). The circuit should continue from the controller, without any splices, and terminate at the seven-pin connector found at the rear of your tow vehicle. Most manufacturers advise against grounding the controller to the vehicle's firewall, but recommend routing a 10 AWG (or larger) separate ground wire directly to the battery; the controller may not function properly if the ground connection is not made directly to the battery terminal.

The other connection is made to the brake-light circuit, downstream of the brake-light switch mounted to the brake-pedal assembly, so the controller senses when the brakes have been activated.

Later-model vehicles with towing packages have brake-control wiring bundled under the dash with a plug-in connector attached. A pigtail with the mating part of the connector is supplied with the vehicle and is ready for connection to the brake-control wiring. This setup avoids most of the complexity and possible mistakes with locating the correct wiring among that maze under the dash.

Today's RVer has many choices in brake controllers from many manufacturers. It's important to carefully select the controller that is right for your needs and capable of handling the weight and number of axles on your trailer.

Be sure to follow the manufacturer's written instructions about every aspect of the brake controller's installation, operation, adjustment and maintenance for optimal performance. 🗨️

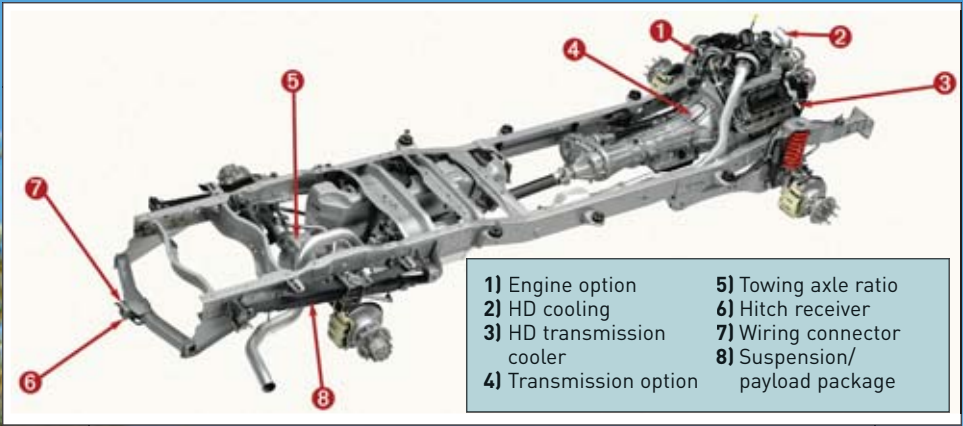

TOWING-PACKAGE COMPONENTS

Overall packages vary by model, but here are some components that may be included:

- Hitch receiver (or fifth-wheel hitch)
- 4- and/or 7-pin connector
- Larger alternator
- Larger battery
- Larger radiator
- Additional electric fan(s)
- Transmission-oil cooler
- Engine-oil cooler
- Rear anti-sway bar
- Extendible mirrors
- Vehicle Dynamic Control
- Integrated brake controller
- Brake controller (or unit pre-wire)
- Synthetic lubricants
- Lower axle ratio
- Re-valved shock absorbers

TOWING PACKAGES

Exactly what's included in these must-have tow-vehicle options?

BY JEFF JOHNSTON

There are many bells and whistles available when choosing a new tow vehicle, but there's one option that is an absolute necessity: The towing package.

Plenty of advantages are involved in choosing factory-installed towing hardware. First, you have full warranty coverage on the equipment. Also, it was designed by the best engineering minds at a major auto manufacturer, which is reassuring when considering the hardware is tying your truck and trailer safely together. You'll probably save money over the cost of aftermarket hardware. And perhaps best of all, use of the factory options means being ready for the road is a turnkey operation that calls for few or no trips to specialty shops after leaving the dealership.

In many cases, you don't have a choice. If the vehicle is to be rated for its highest towing capacity, the towing-package option is mandatory to give the tow vehicle its optimum performance potential. For less-strenuous duty, the towing package is optional.

Check with the dealer to determine the content of the towing-package option. Following are some of the items you will likely encounter.

Axle Ratio: Most packages include a lower (numerically higher) axle ratio; for example, a 3.31:1 or 3.42:1 instead of the 3.55:1 that comes with the stock vehicle. A lower ratio results in greater torque multiplication at the rear wheels, which means more power for towing. It also means the engine turns somewhat faster for a given road speed, but that's the tradeoff for improved towing performance.

Hitch Receiver: If the tow vehicle already has a receiver, all you need to select is the proper ball mount and the associated hardware, such as a load-distributing hitch. The receiver will be properly matched to the tow vehicle's trailer-towing rating, so you needn't worry

2011 **TRAILER LIFE** Towing Guide | 37



about any hitch-overloading situations — as long as you pay attention to the numbers. You'll also avoid interference problems with the exhaust pipe(s), the fuel tank and the spare tire. Some trucks — such as 2011 Ford Super Duty pickups — also feature a factory-installed fifth-wheel hitch.

Wiring Package: The wiring package is a group of color-coded pigtailed near the back bumper that's ready for installation of the trailer-plug receptacle. It can be as complete as a plug or two installed out back, or a pre-wired pigtail for brake-control installation under the dash and full integration with the tow vehicle's electric system.

Alternator: It takes extra charging current to keep a trailer's battery(ies) charged in addition to handling the electrical-power needs of the tow vehicle. The battery itself may also be larger.

Heavy-Duty Suspension: The trailer and its hitch weight add load on the tow-vehicle suspension, so the normal reaction among dealership sales staff and buyers alike is to order the optional heavy-duty (HD) suspension, particularly when fifth-wheel towing is involved. In fact, when the trailer is a conventional ball-type trailer, it's often best not to order a heavy-spring option if there is a choice (if the towing package does not include HD suspension) for trucks rated 8,600 pounds and above because stiff ride and the tendency of the rear springs to do some or most of the

work of the load-distributing hitch can be the result. A stiff ride is a very common complaint among owners of $\frac{3}{4}$ -ton and one-ton pickups not towing fifth-wheels.

A case can be made for not ordering an HD suspension even for fifth-wheel towing — except in very high pin-weight situations — opting instead to install auxiliary springs or air bags





after delivery to support the pin weight (if necessary), which allows a more civilized ride on standard rear springs while not towing. It's necessary to compare the standard and optional rear-axle-weight ratings relative to the anticipated trailer pin weight. It's easy to upgrade rear suspensions after a truck is built, but nearly impossible to soften the ride of an oversprung

truck without replacing the suspension. SUVs have enough of their body weight on the rear axle, so that's generally not an issue.

Brake Control: Ford, Ram and GM HD pickups — and Ford half-ton trucks — all have factory-installed fully integrated trailer brake controls optionally available. This option is a no-brainer. If available, select it, as it's a terrific piece of equipment from the factory. Otherwise, towing packages usually include a trailer-wiring harness with a circuit for an aftermarket brake-control unit, a very worthwhile component of the package (see page 33).

Stability Control: More manufacturers are now offering electronic stability control. In addition, all Ford F-150 2011 trucks include Trailer Sway Control (TSC), which can determine the yaw motion (sway) of the truck and take action, from applying precise braking to reducing engine torque.

Mirrors: Many towing packages offer mirrors designed to be extended outward while towing trailers. Some Ford mirrors even collapse electronically.

Extra Cooling: The largest possible radiator, a larger transmission-oil cooler and often a power-steering-fluid cooler are essential parts of the usual HD cooling component of a towing package, and we advise that no tow vehicle should be ordered without them.

These components will not only help the tow vehicle avoid overheating any vital functional parts, but they will also lead to longer trouble-free component service life. 🚚





TOWING TIPS

Plenty of practice and defensive driving skills lead to a safe and enjoyable RV experience

BY BRAD CLAYTON

Trailer towing isn't exactly rocket science, but it does represent a step up in complexity from driving a solo vehicle. Towing requires new awareness of combined vehicle length, trailer width, braking distance, turning characteristics and several other important factors that must be considered while on the road.

Most of us drive trucks, SUVs or passenger cars daily, and tow an RV only occasionally while vacationing. Thus, it's always necessary to make a mental transition and try to keep the size and handling characteristics of the larger rig in mind.

Allowing solo-vehicle habits to take over may result in a tendency to make turns too tightly, to run over curbs, to hit stationary objects such as overhanging tree limbs or to follow too closely.

Pay Attention

The first towing precautions are those that precede towing — matching the tow vehicle and trailer correctly, adhering to weight limits and making sure hitch selection and adjustment are correct, as described elsewhere in this guide. It's also important to refresh defensive driving skills. From



there, the real fun begins.

The combined length of the tow vehicle and the trailer, as well as the combined weight, must be in the front of your mind, right from the start. Maintaining extended following distances is one of the most important towing-related driving habits that initially is difficult to adhere to.

Even though trailer brakes may be functional, braking distances almost always are extended. It's also important to make lane changes carefully and slowly, and to allow extended distances for passing. High-quality, properly adjusted towing mirrors with large reflective areas are also essential. Some manufacturers have factory-installed extendible towing mirrors available, and most such factory mirrors work well these days, such as those seen on many Ford trucks. If you need aftermarket portable mirrors, solidly mounted units like those from McKesh are a good idea.

Speedy traffic seems more tolerant of slower 18-wheelers than of slower RVs, which makes courtesy an important safety factor for RV owners because an irate driver trying to pass can pose a serious safety threat. Frequent monitoring of rearview mirrors is necessary while towing; when a vehicle is tailgating and trying to pass, we should help by driving slightly to the right to give the other driver a better view of the road ahead, even if a passing opportunity does not exist at the time. We should use turnouts whenever possible and avoid following another vehicle so closely that a vehicle overtaking from the rear cannot return to the proper lane.

Braking

While tow-vehicle and trailer brakes are adequate for most situations, care is necessary to avoid overheating, which can lead to brake fade. If brake fade occurs, it will likely be on steep downgrades. Brake fade happens when friction raises the temperature of brake pads and linings to extremely high levels, resulting in temporary loss of braking.

The only known cure is prevention, such as downshifting to a gear range that is low enough to retard speed sufficiently that brakes need not be used more than occasionally. This way, enough braking performance is reserved to make an emergency stop, should it become necessary.

When braking on a grade is necessary, apply the brakes intermittently, with moderate pressure, and release the pedal to allow the brakes to cool.

The action of electric trailer brakes should be apparent to the driver, and sufficient to

handle the trailer's weight. The controller should be adjusted so that maximum braking action does not cause trailer-wheel lockup. Improper controller adjustment is a major cause of inadequate braking, so it's wise to study the manufacturer's instructions. Travel-trailer instability (fishtailing) should not occur in a well-balanced, well-hitched combination, but if it does, independent actuation of trailer brakes usually will bring the trailer back into line. Ford, GM and Dodge all offer factory-installed fully integrated brake controls on full-size pickups, and these units all work very nicely and are valuable safety components.

When towing with a diesel, an aftermarket exhaust brake can be extremely beneficial, and many newer diesel trucks now offer fully integrated exhaust-brake control.

Trailer Maneuvering

All trailers require more space for turns, and travel trailers follow the tow-vehicle track more closely than do fifth-wheels, which track farther to the inside of a turn. There is need for continual awareness, which should eventually become second-nature after a modest amount of on-the-road experience.

Fifth-wheel trailers are different to back than conventional trailers, and require more practice for someone accustomed to backing a conventional trailer. A well-used technique involves placing one's hand at the bottom of the steering wheel and moving it in the same direction the trailer is intended to go. It's more effective with travel trailers than with fifth-wheels, which often require more turning of the steering wheel.

Handheld two-way radios can allow an assistant to more effectively relay backing instructions to the driver. Plus back-up cameras, such as available on many 2011 Ford and other trucks, help ease the difficulty of hitching up when a helper isn't available.

Before each trip, it's essential to check the tires to assure that inflation pressures match those molded on tire sidewalls (cold), or that they are appropriate for your load (consult both the tire and vehicle load/inflation tables). Also, be sure to inspect all vehicle fluids, per standard maintenance procedure during heavy-duty vehicle use cycles, and make sure trailer-wheel lug nuts are tightened to factory specifications.

Trailering is a great way to explore the new horizons and a great way to check out the wonderful camping destinations that are available to owners of recreational trailers. And always keep in mind that defensive driving will pay off in safe travel. 🚚



**2 Year
Warranty**
ask your dealer
for details

DURANGO



Another Reason
Why Our Customers
“Come Home to KZ”...

At KZ, we're interested in our customers. They know us, and we know them. The lightweight Durango 1500 has eight floorplans to choose from and the luxurious Durango 2500 has nine floorplans available. At KZ, all our products are built with quality, integrity, and one of the best warranty programs in the industry...
just for you

KZ and you
worth coming home to.



Visit us on
the web at
www.kz-rv.com

KZ Inc., go to www.trailerlife.com/info

Yeah,
it's good to be
KING.



Best-in-class towing power. 11,300 lbs.* Full steam ahead.

This is the future of truck
THE NEW 2011 F-150

FIND OUT MORE AT FORD.COM



3.7L | 5.0L | 6.2L | **ECO****
BOOST

4 NEW ENGINES

Ford Motor Company, go to www.trailerlife.com/info

*Properly equipped. Class is Full-Size Pickups under 8,500 lbs. GVWR. **Available early 2011.

Go To: **TRAILER**
FOLLOW THE ROAD TO ADVENTURE
LIFE.com

User Guide

Contents



Welcome to our digital edition of Trailer Life Magazine. This format makes it easy for you to navigate the magazine and provides direct links to Internet sites of our advertisers, our TrailerLife.com Web site, and many Web sites to supplement our editorial features.

Here are some tips on how to use Digital Trailer Life:



- Click on the TrailerLife.com button to go directly to our Web site.
- Click on the User Guide button on any page to bring you back to this page.
- Click on the Contents button to take you to the Table of Contents page from anywhere in the magazine.

- When the hand icon changes to a pointing  finger, it indicates a link to a Web site or to another page in the magazine.

- Use the Zoom  tool to zoom in on the page. Use the Zoom-out tool  and hold down the option (Macintosh) or Windows key to toggle back and forth.

- Click and drag using the Dynamic Zoom  tool to infinitely control the zoom.

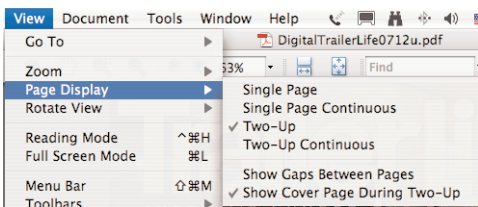

We recommend a Page Layout view of Two-Up (or Facing, depending on the version of Reader), Showing Cover Page, however, Adobe Reader provides several options you may prefer.

We hope you enjoy reading our Digital *Trailer Life* magazine, and we encourage your comments and suggestions to our editor at kbunker@affinitygroup.com