

# Urban

---

**VALENTINO**

BY CERAMICHE PIEMME

# Urban

---



Una linea attuale dall'inconfondibile fascino metropolitano.  
Urban arreda con stile e originalità gli spazi del vivere contemporaneo.

A modern line with an unmistakable metropolitan appeal.  
Urban furnishes contemporary living areas with style and originality.

Eine aktuelle Linie mit dem besonderen Flair der Großstadt.  
Urban gestaltet die Lebensräume von heute originell und stilvoll.

Une ligne actuelle au charme métropolitain incomparable.  
Urban habille avec style et originalité les espaces de la vie contemporaine.

# Colori - Colors

**bianco**

80x80cm 31<sup>1</sup>/<sub>2</sub>" x 31<sup>1</sup>/<sub>2</sub>"  
60x120cm 24" x 48"  
60x60cm 24" x 24"  
30x60cm 12" x 24"

**sabbia**

80x80cm 31<sup>1</sup>/<sub>2</sub>" x 31<sup>1</sup>/<sub>2</sub>"  
60x120cm 24" x 48"  
60x60cm 24" x 24"  
30x60cm 12" x 24"

**terra**

80x80cm 31<sup>1</sup>/<sub>2</sub>" x 31<sup>1</sup>/<sub>2</sub>"  
60x120cm 24" x 48"  
60x60cm 24" x 24"  
30x60cm 12" x 24"

**grigio**

80x80cm 31<sup>1</sup>/<sub>2</sub>" x 31<sup>1</sup>/<sub>2</sub>"  
60x120cm 24" x 48"  
60x60cm 24" x 24"  
30x60cm 12" x 24"

**nero**

80x80cm 31<sup>1</sup>/<sub>2</sub>" x 31<sup>1</sup>/<sub>2</sub>"  
60x60cm 24" x 24"  
30x60cm 12" x 24"

**ciottoli** nat/grip R11

30x60cm 12" x 24"



Look **minimal** e tonalità  
sobrie per gli ambienti  
in cui è il **design**  
il vero protagonista.

**Minimal look** and sober colours  
for interiors where **design** plays lead role.

**Minimalistischer Look** und schlichte Farben  
für Räume, die ganz im Zeichen des **Designs** stehen.

**Look minimaliste** et teintes sobres pour tout environnement  
où le **design** joue un rôle de premier plan.

grigio nat/ret 60x60 cm - 24"x24"



## Residential



bianco nat/ret 60x60 cm - 24"x24"

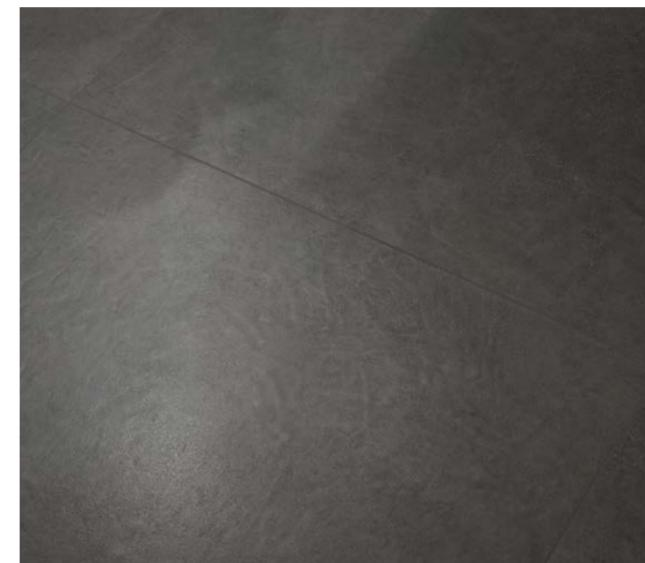

nero nat/ret 60x60 cm - 24"x24"

## Urban

---

L'Urban Style nel  
**grande formato 80x80**  
è ideale per le ampie  
superfici commerciali.

---

Urban Style in **large 80x80 size**  
is ideal for large commercial surface areas.

---

Urban Style im **Großformat 80x80**  
ist ideal für große Gewerbeflächen.

---

Avec son **grand format 80x80**, Urban Style  
est l'idéal pour les grands espaces commerciaux.



# Residential



grigio nat/ret 60x60 cm - 24"x24"



nero nat/ret 80x80 cm - 31<sup>1</sup>/<sub>2</sub>" x 31<sup>1</sup>/<sub>2</sub>"



## Public Spaces

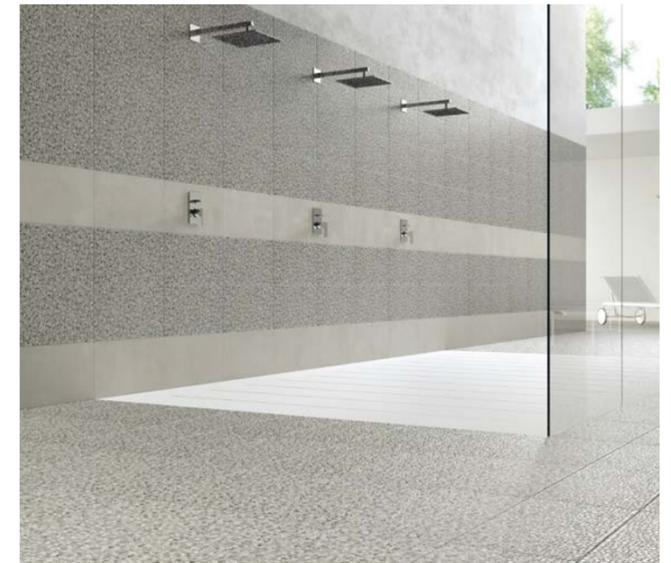

grigio nat/ret 30x60 cm - 12"x24"  
ciottoli ne - gri - te nat/ret 30x60 cm - 12"x24" / grip 30x60 cm - 12"x24"



nero nat/ret 60x60 cm - 24"x24" / nero nat/ret 30x60 cm - 12"x24"  
listello titanio 1,5x60 cm - 5/8"x24"

Urban

---

Tecnologia innovativa e  
cura del **dettaglio**  
creano "Ciottoli",  
una superficie ideale  
per il moderno **outdoor**.

---

Innovative technology and care for **detail** create "Ciottoli",  
an ideal modern **outdoor** surface.

---

Aus **innovativer Technologie** und Sorgfalt im **Detail** entsteht "Ciottoli",  
die perfekte Fläche für das moderne **Outdoor**.

---

La **technologie innovante** alliée au soin du **détail** fait de "Ciottoli"  
le revêtement idéal des **espaces extérieurs** modernes.

---

ciottoli ne - gr - 1è grip 30x60 cm - 12' x24'

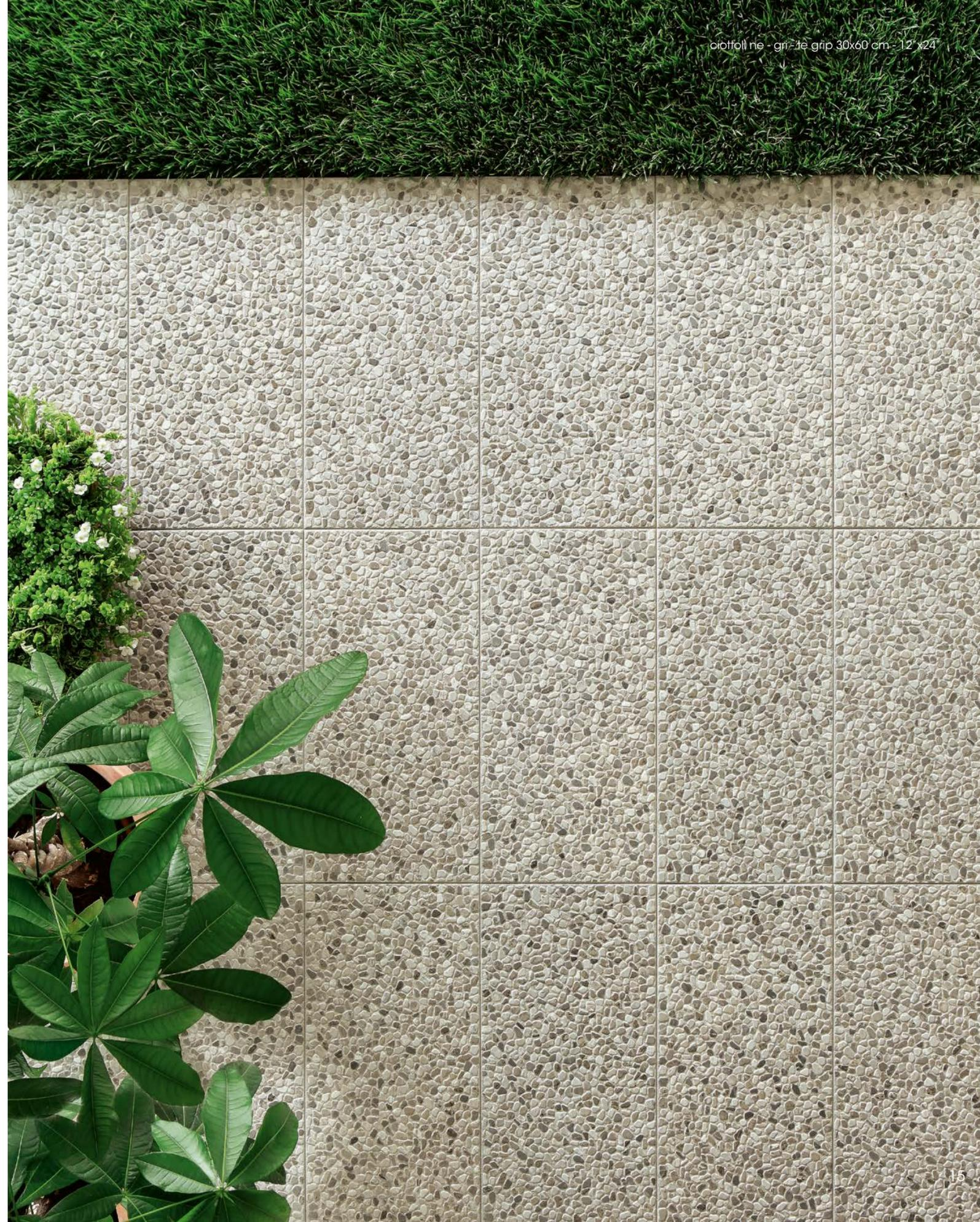

## Urban

---

La versione in **spessore 20 mm**, posata su massetto con **idonei collanti** rende la superficie **resistente e carrabile**.

---

The **20 mm thick version**, laid on screed using **suitable adhesives** makes the surface **resistant and transitable**.

---

Die Version mit **20 mm Stärke** macht die Fläche bei Verlegung mit **geeigneten Klebern** auf Estrich **widerstandsfähig und befahrbar**.

---

Posée sur un lit à l'aide de **colles appropriées**, la version de **20 mm d'épaisseur** rend la surface **résistante et carrossable**.

---

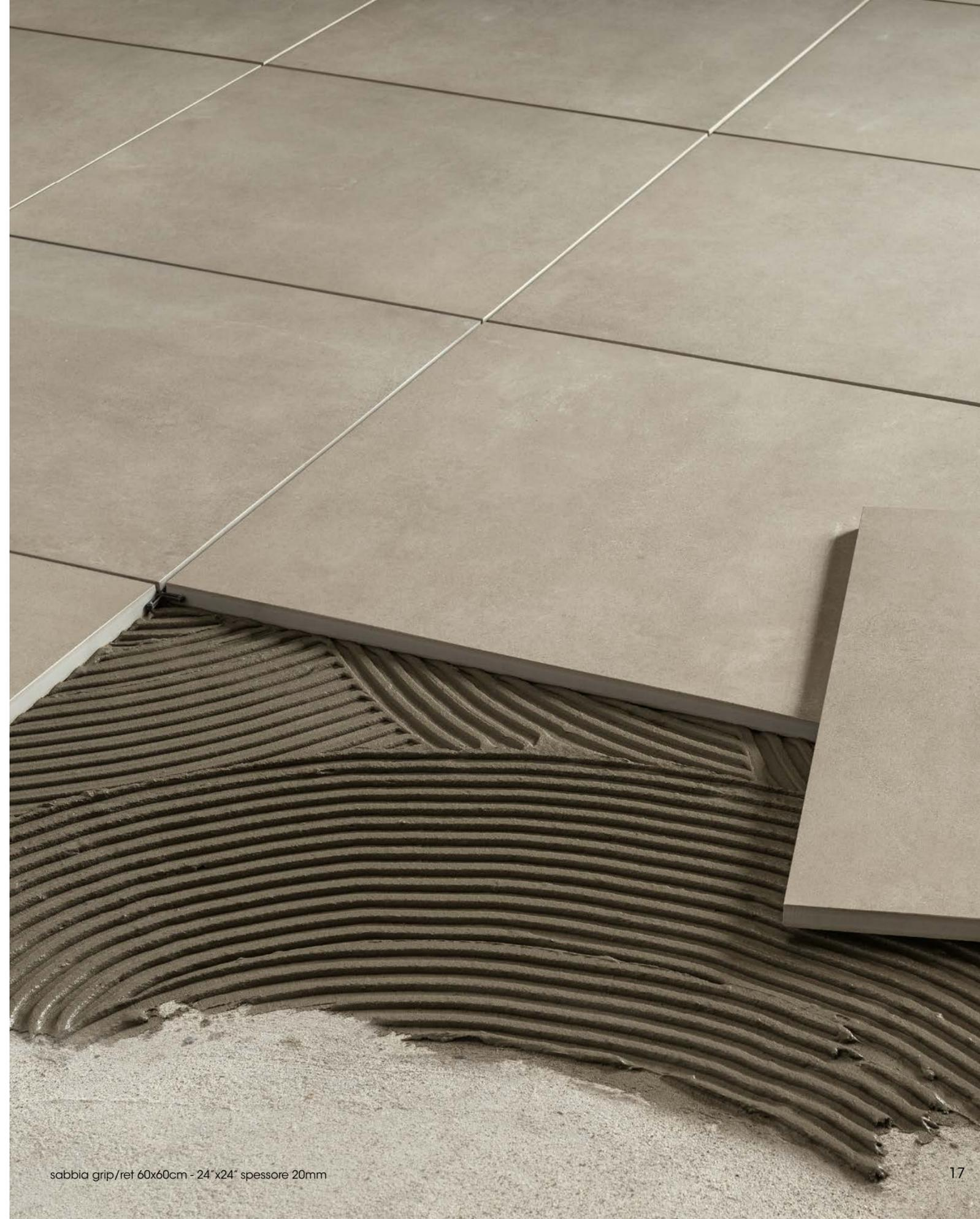

20mm



grigio grip/ret 60x60cm - 24"x24" spessore 20mm



sabbia grip/ret 60x60cm - 24"x24" spessore 20mm 19

# Colori e Formati

Sizes and colors - Formate und Farben - Formats et couleurs

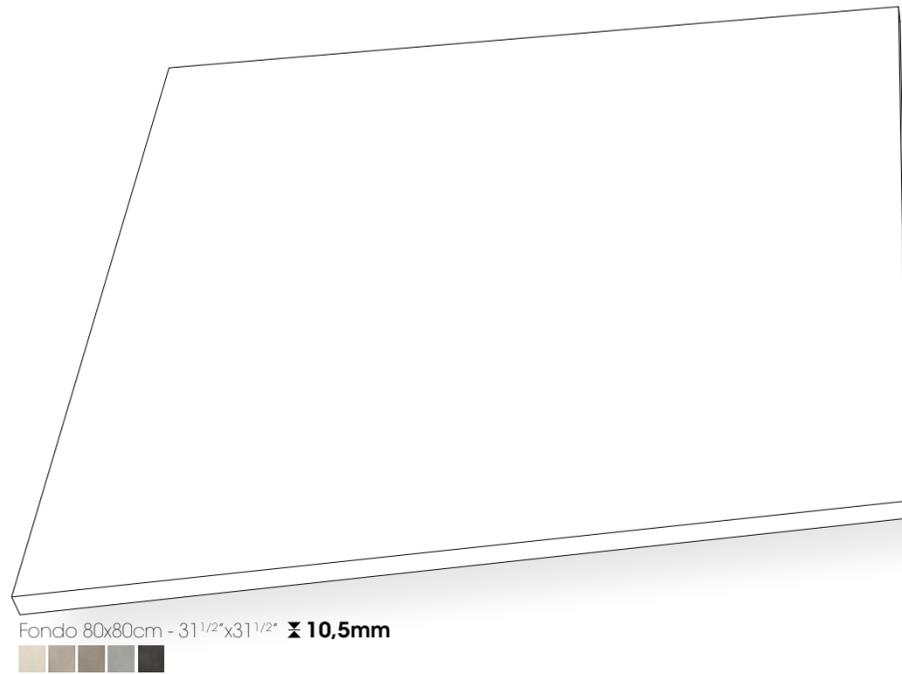
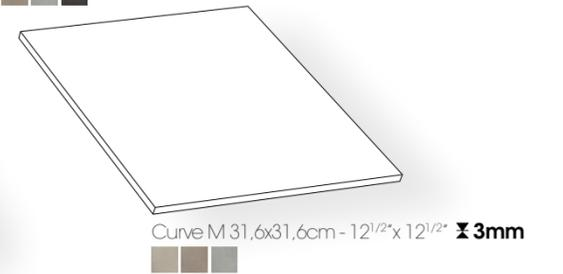
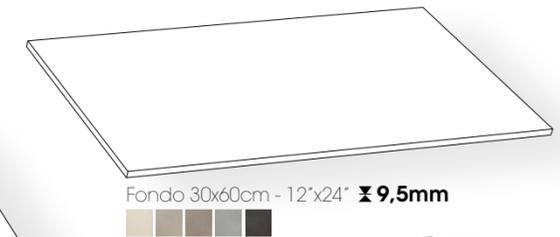
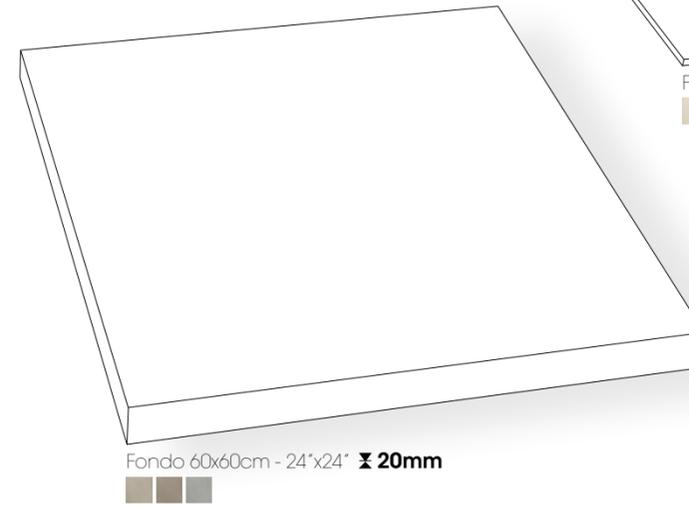
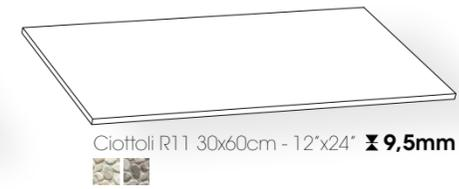
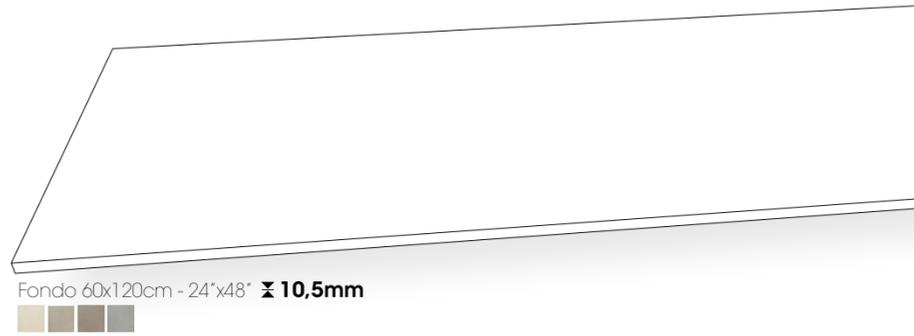

Bianco



Sabbia



Terra



Grigio



Nero

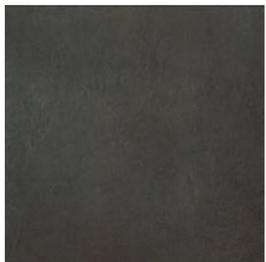

# Bianco

GRES FINE PORCELLANATO AD IMPASTO COLORATO  
 COLOURED-BODY FINE PORCELAIN STONWARE  
 FEINSTEINZEUG AUS FARBIGER MASSE  
 GRÈS CÉRAME FIN À PÂTE COLORÉE

TECNOLOGIA DIGITALE  
 DIGITAL TECHNOLOGY  
 DIGITAL TECHNOLOGIE  
 TECHNOLOGIE NUMÉRIQUE

60x60 cm  
 24"x24"  
 30x60 cm  
 12"x24"

9,5 mm



34170 URBAN BIANCO NAT U4 P4 E3 C2 560  
 34220 URBAN BIANCO NAT/RET 590  
 60x60 - 24"x24" PEI V V2



34270 URBAN BIANCO NAT U4 P3 E3 C2 420  
 34320 URBAN BIANCO NAT/RET 490  
 30x60 - 12"x24" PEI V V2



35610 CIOTTOLI BI - SA - TE NAT/RET 560  
 36050 CIOTTOLI BI - SA - TE GRIP R11 440  
 30x60 - 12"x24"



00308 MOSAICO BIANCO NAT/RET 140  
 30x30 - 12"x12" pz. box: 5



39640 LISTELLO TITANIO NAT/RET 330  
 1,5x60 - 5/8"x24" pz. box: 6



90570 TRIANGOLO FIRMA 420  
 5x5 - 2"x2" pz. box: 2

# Sabbia

GRES FINE PORCELLANATO AD IMPASTO COLORATO  
COLOURED-BODY FINE PORCELAIN STONEWARE  
FEINSTEINZEUG AUS FARBIGER MASSE  
GRÈS CÉRAME FIN À PÂTE COLORÉE

TECNOLOGIA DIGITALE  
DIGITAL TECHNOLOGY  
DIGITAL TECHNOLOGIE  
TECNOLOGIE NUMÉRIQUE

60x60 cm  
24"x24"  
30x60 cm  
12"x24"  
9,5 mm



34180 URBAN SABBIA NAT U4 P4 E3 C2 560  
34230 URBAN SABBIA NAT/RET 590  
60x60 - 24"x24" PEI V V2



34280 URBAN SABBIA NAT U4 P3 E3 C2 420  
35480 URBAN SABBIA NAT/RET 490  
30x60 - 12"x24" PEI V V2



35610 CIOTTOLI BI - SA - TE NAT/RET 560  
36050 CIOTTOLI BI - SA - TE GRIP R11 440  
30x60 - 12"x24"



00309 MOSAICO SABBIA NAT/RET 140  
30x30 - 12"x12" pz. box: 5

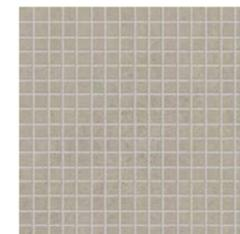

00319 CURVE M SABBIA NAT/RET 210  
31,6x31,6 - 12<sup>1/2</sup>"x12<sup>1/2</sup>" pz. box: 10



39640 LISTELLO TITANIO NAT/RET 330  
1,5x60 - 5/8"x24" pz. box: 6



90570 TRIANGOLO FIRMA 420  
5x5 - 2"x2" pz. box: 2

# Terra

GRES FINE PORCELLANATO AD IMPASTO COLORATO  
COLOURED-BODY FINE PORCELAIN STONWARE  
FEINSTEINZEUG AUS FARBIGER MASSE  
GRÈS CÉRAME FIN À PÂTE COLORÉE

TECNOLOGIA DIGITALE  
DIGITAL TECHNOLOGY  
DIGITAL TECHNOLOGIE  
TECHNOLOGIE NUMÉRIQUE

60x60 cm  
24"x24"  
30x60 cm  
12"x24"  
9,5 mm



34190 URBAN TERRA NAT U4 P4 E3 C2 560  
34240 URBAN TERRA NAT/RET 590  
60x60 - 24"x24" PEI V V2



34290 URBAN TERRA NAT U4 P3 E3 C2 420  
35490 URBAN TERRA NAT/RET 490  
30x60 - 12"x24" PEI V V2



35610 CIOTTOLI BI - SA - TE NAT/RET 560  
36050 CIOTTOLI BI - SA - TE GRIP R11 440  
30x60 - 12"x24"



00311 MOSAICO TERRA NAT/RET 140  
30x30 - 12"x12" pz. box: 5

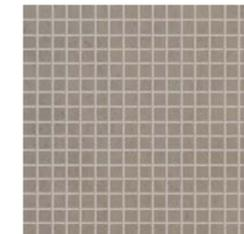

00321 CURVE M TERRA NAT/RET 210  
31,6x31,6 - 12<sup>1/2</sup>"x12<sup>1/2</sup>" pz. box: 10



39640 LISTELLO TITANIO NAT/RET 330  
1,5x60 - 5/8"x24" pz. box: 6



90570 TRIANGOLO FIRMA 420  
5x5 - 2"x2" pz. box: 2

# Grigio

GRES FINE PORCELLANATO AD IMPASTO COLORATO  
COLOURED-BODY FINE PORCELAIN STONWARE  
FEINSTEINZEUG AUS FARBIGER MASSE  
GRÈS CÉRAME FIN À PÂTE COLORÉE

TECNOLOGIA DIGITALE  
DIGITAL TECHNOLOGY  
DIGITAL TECHNOLOGIE  
TECNOLOGIE NUMÉRIQUE

60x60 cm  
24"x24"  
30x60 cm  
12"x24"

9,5 mm



34200 URBAN GRIGIO NAT U4 P4 E3 C2 560  
34250 URBAN GRIGIO NAT/RET 590  
60x60 - 24"x24" PEI V V2



34300 URBAN GRIGIO NAT U4 P3 E3 C2 420  
35590 URBAN GRIGIO NAT/RET 490  
30x60 - 12"x24" PEI V V2



36040 CIOTTOLI NE - GRI - TE NAT/RET 560  
36060 CIOTTOLI NE - GRI - TE GRIP R11 440  
30x60 - 12"x24"



00312 MOSAICO GRIGIO NAT/RET 140  
30x30 - 12"x12" pz. box: 5

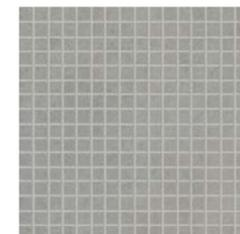

00322 CURVE M GRIGIO NAT/RET 210  
31,6x31,6 - 12<sup>1/2</sup>"x12<sup>1/2</sup>" pz. box: 10



39640 LISTELLO TITANIO NAT/RET 330  
1,5x60 - 5/8"x24" pz. box: 6



90570 TRIANGOLO FIRMA 420  
5x5 - 2"x2" pz. box: 2

# Nero

GRES FINE PORCELLANATO AD IMPASTO COLORATO  
 COLOURED-BODY FINE PORCELAIN STONWARE  
 FEINSTEINZEUG AUS FARBIGER MASSE  
 GRÉS CÉRAME FIN À PÂTE COLORÉE

TECNOLOGIA DIGITALE  
 DIGITAL TECHNOLOGY  
 DIGITAL TECHNOLOGIE  
 TECHNOLOGIE NUMÉRIQUE

60x60 cm  
 24"x24"  
 30x60 cm  
 12"x24"

9,5 mm



34210 URBAN NERO NAT U4 P4 E3 C2 570  
 34260 URBAN NERO NAT/RET 600  
 60x60 - 24"x24" PEI IV V2



34310 URBAN NERO NAT U4 P3 E3 C2 440  
 35600 URBAN NERO NAT/RET 520  
 30x60 - 12"x24" PEI IV V2



36040 CIOTTOLI NE - GRI - TE NAT/RET 560  
 36060 CIOTTOLI NE - GRI - TE GRIP R11 440  
 30x60 - 12"x24"



00313 MOSAICO NERO NAT/RET 140  
 30x30 - 12"x12" pz. box: 5



39640 LISTELLO TITANIO NAT/RET 330  
 1,5x60 - 5/8"x24" pz. box: 6



90570 TRIANGOLO FIRMA 420  
 5x5 - 2"x2" pz. box: 2

# Maxi Formati

Maxi Sizes - Maxi Formats - Maxiformate

GRES FINE PORCELLANATO AD IMPASTO COLORATO  
COLOURED-BODY FINE PORCELAIN STONEWARE  
FEINSTEINZEUG AUS FARBIGER MASSE  
GRÈS CÉRAME FIN À PÂTE COLORÉE

TECNOLOGIA DIGITALE  
DIGITAL TECHNOLOGY  
DIGITALTECHNOLOGIE  
TECHNOLOGIE NUMÉRIQUE

60x120 cm  
24"x48" 10,5 mm

80x80 cm  
31"x31" 10,5 mm

## Bianco

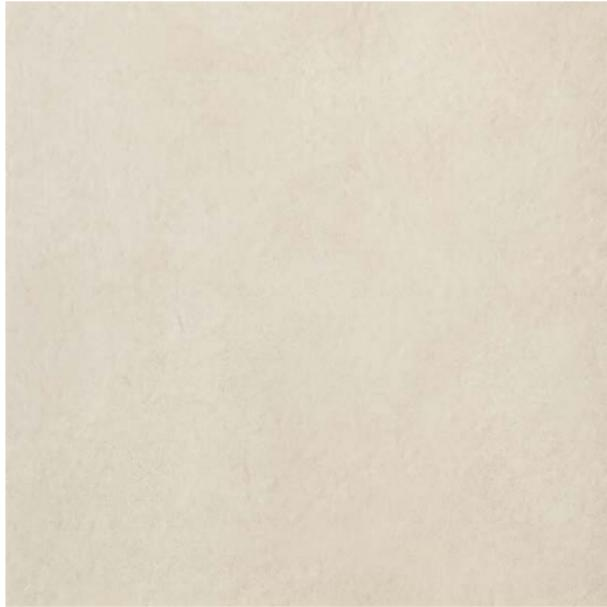

34120 URBAN BIANCO NAT/RET  
80x80 - 31 1/2"x31 1/2"

U4 P3 E3 C2 PEI V V2



01407 URBAN BIANCO NAT/RET  
60x120 - 24"x48"

U4 P3 E3 C2 PEI V V2

## Sabbia

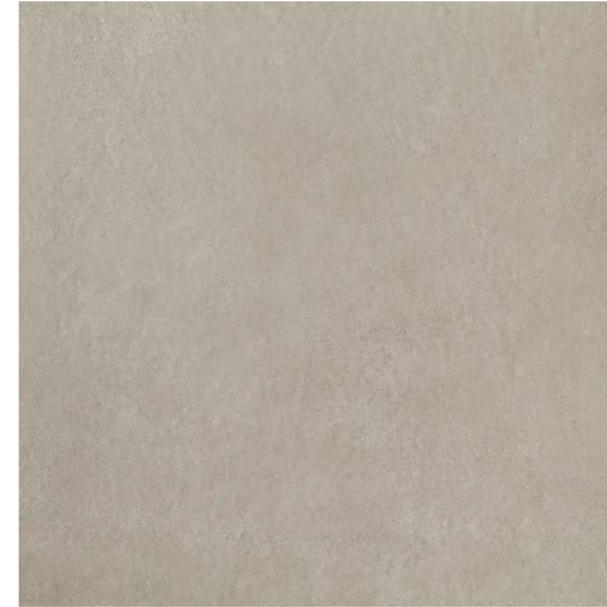

34130 URBAN SABBIA NAT/RET  
80x80 - 31 1/2"x31 1/2"

U4 P3 E3 C2 PEI V V2



01408 URBAN SABBIA NAT/RET  
60x120 - 24"x48"

U4 P3 E3 C2 PEI V V2

GRES FINE PORCELLANATO AD IMPASTO COLORATO  
COLOURED-BODY FINE PORCELAIN STONEWARE  
FEINSTEINZEUG AUS FARBIGER MASSE  
GRÈS CÉRAME FIN À PÂTE COLORÉE

TECNOLOGIA DIGITALE  
DIGITAL TECHNOLOGY  
DIGITALTECHNOLOGIE  
TECHNOLOGIE NUMÉRIQUE

60x120 cm  
24"x48" 10,5 mm

80x80 cm  
31"x31" 10,5 mm

# Maxi Formati

Maxi Sizes - Maxi Formats - Maxiformate

GRES FINE PORCELLANATO AD IMPASTO COLORATO  
COLOURED-BODY FINE PORCELAIN STONWARE  
FEINSTEINZEUG AUS FARBIGER MASSE  
GRÈS CÉRAME FIN À PÂTE COLORÉE

TECNOLOGIA DIGITALE  
DIGITAL TECHNOLOGY  
DIGITALTECHNOLOGIE  
TECHNOLOGIE NUMÉRIQUE

60x120 cm  
24"x48" 10,5 mm

80x80 cm  
31"x31" 10,5 mm

GRES FINE PORCELLANATO AD IMPASTO COLORATO  
COLOURED-BODY FINE PORCELAIN STONWARE  
FEINSTEINZEUG AUS FARBIGER MASSE  
GRÈS CÉRAME FIN À PÂTE COLORÉE

TECNOLOGIA DIGITALE  
DIGITAL TECHNOLOGY  
DIGITALTECHNOLOGIE  
TECHNOLOGIE NUMÉRIQUE

60x120 cm  
24"x48" 10,5 mm

80x80 cm  
31"x31" 10,5 mm

## Terra



34140 URBAN TERRA NAT/RET  
80x80 - 31 1/2"x31 1/2"

U4 P3 E3 C2 PEI V V2



01411 URBAN TERRA NAT/RET  
60x120 - 24"x48"

U4 P3 E3 C2 PEI V V2

## Grigio

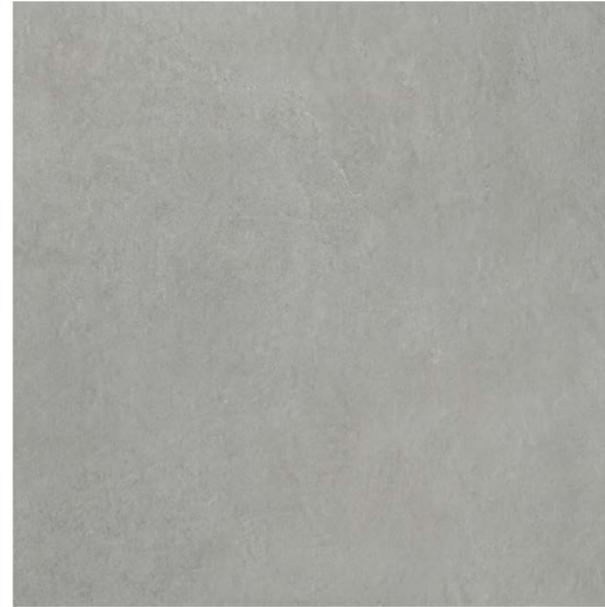

34150 URBAN GRIGIO NAT/RET  
80x80 - 31 1/2"x31 1/2"

U4 P3 E3 C2 PEI V V2



01409 URBAN GRIGIO NAT/RET  
60x120 - 24"x48"

U4 P3 E3 C2 PEI V V2

## Nero



34160 URBAN NERO NAT/RET  
80x80 - 31 1/2"x31 1/2"

U4 P3 E3 C2 PEI IV V2

# Pezzi Speciali

Special Pieces - Pièces Spéciales - Formteile

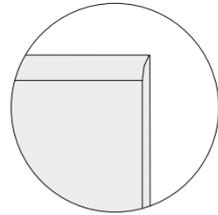
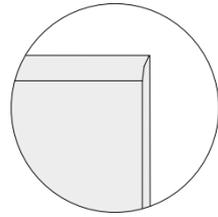
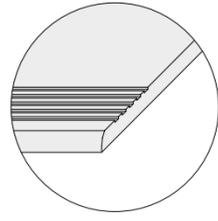
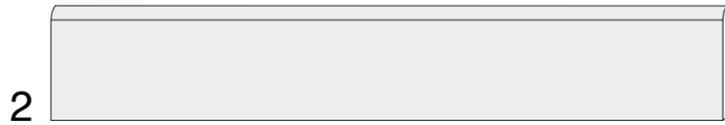

## 1 GRADINO 30x60cm

pz. box:6

36120	GRADINO URBAN BIANCO NAT	▲140
36130	GRADINO URBAN SABBIA NAT	▲140
36140	GRADINO URBAN TERRA NAT	▲140
36150	GRADINO URBAN GRIGIO NAT	▲140
36160	GRADINO URBAN NERO NAT	▲140

## 2 BATTISCOPA 8x80cm

pz. box:7

37000	BATT. URBAN BIANCO NAT/RET	▲100
37010	BATT. URBAN SABBIA NAT/RET	▲100
37020	BATT. URBAN TERRA NAT/RET	▲100
37030	BATT. URBAN GRIGIO NAT/RET	▲100
37120	BATT. URBAN NERO NAT/RET	▲100

## 3 BATTISCOPA 8x60cm

pz. box:10

36170	BATTISCOPA URBAN BIANCO NAT	▲60
00216	BATT. URBAN BIANCO NAT/RET	▲90
36180	BATTISCOPA URBAN SABBIA NAT	▲60
00217	BATT. URBAN SABBIA NAT/RET	▲90
36190	BATTISCOPA URBAN TERRA NAT	▲60
00218	BATT. URBAN TERRA NAT/RET	▲90
36200	BATTISCOPA URBAN GRIGIO NAT	▲60
00219	BATT. URBAN GRIGIO NAT/RET	▲90
36210	BATTISCOPA URBAN NERO NAT	▲60
00220	BATT. URBAN NERO NAT/RET	▲90



# 20mm

GRES FINE PORCELLANATO  
PORCELAIN STONWARE  
FEINSTEINZEUG  
GRÈS CÉRAME

TECNOLOGIA DIGITALE  
DIGITAL TECHNOLOGY  
DIGITAL TECHNOLOGIE  
TECHNOLOGIE NUMÉRIQUE

60x60 cm  
24"x24"

20 mm

## Sabbia R11



01713 URBAN SABBIA GRIP/RET R11 770  
60x60 - 24"x24"

## Terra R11



01714 URBAN TERRA GRIP/RET R11 770  
60x60 - 24"x24"

## Grigio R11



01715 URBAN GRIGIO GRIP/RET R11 770  
60x60 - 24"x24"

# Pezzi Speciali 20mm

Special Pieces 20mm - Formteile 20mm - Pièces Spéciales 20mm

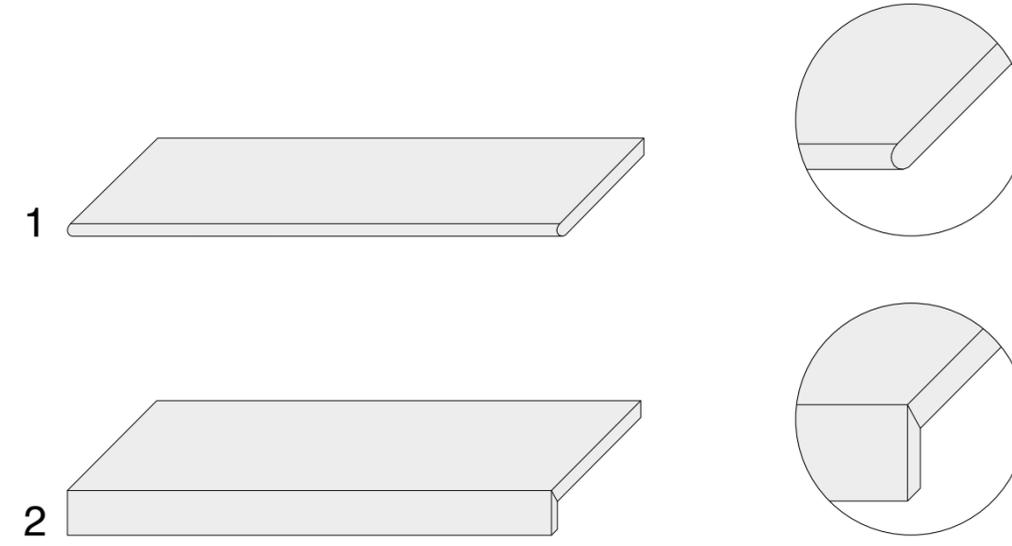

### 1 GRADONE 30x60cm

- 00562 GRADONE SABBIA GRIP/RET ▲730
- 00563 GRADONE TERRA GRIP/RET ▲730
- 00564 GRADONE GRIGIO GRIP/RET ▲730

### 2 ELEMENTO AD L 30x60cm

- 00559 ELEM. AD L SABBIA GRIP/RET ▲730
- 00560 ELEM. AD L TERRA GRIP/RET ▲730
- 00561 ELEM. AD L GRIGIO GRIP/RET ▲730

# Piemme 20mm

Piemme amplia la gamma produttiva introducendo il nuovo spessore 20mm. L'estrema versatilità di questo nuovo materiale consente di soddisfare ogni esigenza progettuale per l'outdoor. Piemme 20mm è una nuova superficie di design, resistente, sicura ed inalterabile nel tempo.

Piemme is extending its product range with the new 20 mm thickness. The extreme versatility of this new material permits catering to all outdoor planning requirements. Piemme 20mm is a new design surface, strong, reliable and unchanging over time.

Die Firma Piemme erweitert ihre Produktionspalette durch Einführung der neuen 20-mm-Stärke. Die extreme Vielseitigkeit dieses neuen Materials erlaubt es, allen Entwurfserfordernissen für Freiräume gerecht zu werden. Piemme 20 mm ist eine neue widerstandsfähige, sichere und der Zeit trotzende Designeroberfläche.

Piemme élargit sa gamme de production en ajoutant une nouvelle épaisseur: 20 mm. La grande polyvalence de ce nouveau matériau permet de répondre à toutes les exigences de l'aménagement extérieur. Piemme 20 mm est une nouvelle surface de design, résistante, fiable et inaltérable dans le temps.

Destinazioni d'uso - Intended uses  
Verwendungszwecke - Domaines d'application



Vialetti  
Walkways  
Wege  
Allées



Terrazze  
Terraces  
Terrassen  
Terrasses



Parchi pubblici  
Public parks  
Öffentliche Parks  
Parcs publics

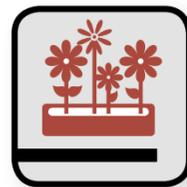

Giardini  
Gardens  
Gärten  
Jardins



Parcheggi  
Parking areas  
Parkplätze  
Parkings



Arredo urbano  
Street furnishing  
Stadtmoiliar  
Ameublement urbain



Zone industriali  
Industrial areas  
Industriebereiche  
Espaces Industriels



Stabilimenti balneari  
Beach resorts  
Badeanlagen  
Stations balnéaires

Applicazioni - Applications  
Verlegungsbeispiele - Applications



Posa a secco su erba, ghiaia e sabbia - Dry laying on grass, gravel and sand  
Trockene Verlegung auf Gras, auf Kies und Splitt, auf Sand - Pose à sec sur herbe, gravier et sable



Posa su massetto con colla - Laying on screed with adhesive  
Traditionelle Verlegung auf Estrich - Pose à la colle sur dalle



Posa sopraelevata - Laying as raised paving  
Trockene Verlegung auf Stützen - Pose surélevée

# Imballi

Packing - Verpackung - Emballage

FORMATI SIZES	SPESSORI THICKNESS	SUPERFICIE SURFACE						IMBALLI PACKING	Pezzi/Scatola Pcs/Box Stk./Karton Carreaux/Boîtes	Mq/Scatola SqM/Box M <sup>2</sup> /Karton Om/Boîtes	Kg/Scatola Kgs/Box Kg/Karton Kg/Boîtes	Scatola/Paletta Boxes/Pallet Karton/Palette Boîtes/Pallet	Mq/Paletta SqM/Pallet M <sup>2</sup> /Palette Om/Pallet	Kg/Paletta Kgs/Pallet Kg/Palette Kg/Pallet
			BIANCO	SABBIA	TERRA	GRIGIO	NERO							
 80x80 / 31 <sup>1/2</sup> "x31 <sup>1/2</sup> "	10,5mm	NAT / RET	●	●	●	●	●	2	1,28	31,5	40	51,2	1260	
 *60x120 / 24"x48" *60x119,5 / 24"x47 <sup>5/8</sup> "	10,5mm 9,5mm	NAT / RET	●	●	●	●	●	2	1,44	34	27	38,88	918	
									1,434	31	30	43,02	930	
 60x60 / 24"x24"	9,5mm	NAT	●	●	●	●	●	3	1,08	23	40	43,2	920	
		NAT / RET	●	●	●	●	●						860	
 60x60 / 24"x24"	20mm	GRIP / RET R11	-	●	●	●	●	2	0,72	34	32	23,04	1088	
 30x60 / 12"x24"	9,5mm	NAT	●	●	●	●	●	6	1,08	22	48	51,84	1056	
		NAT / RET	●	●	●	●	●			21,5			1032	
 CIOTTOLI 30x60 / 12"x24"	9,5mm	NAT / RET	●	●	●	●	●	6	1,08	21,5	48	51,84	1032	
		GRIP	●	●	●	●	●			22			1056	
 MOSAICO 30x30 / 12"x12"	9,5mm	NAT / RET	●	●	●	●	●	5	0,45	8	-	-	-	
 CURVE M 31,6x31,6 / 12 <sup>5/8</sup> "x12 <sup>5/8</sup> "	3mm	NAT / RET	-	●	●	●	●	10	1	9	-	-	-	
 LISTELLO TITANIO 1,5x60 / 5/8"x24"	9,5mm	NAT / RET	LISTELLO TITANIO					6	0,054	0,5	-	-	-	
 TRIANGOLO FIRMA 5x5 / 2"x2"	9,5mm	RET	TRIANGOLO FIRMA					2	0,003	0,1	-	-	-	

\*Attenzione: verificare in fase di ordine il formato e l'imballo (60x120-60x119,5)  
 \*Note: In the ordering phase please check size and packaging (60x120-60x119,5)  
 \*Bitteachten: Beim Bestellen bitte das Format und die Verpackung kontrollieren (60x120-60x119,5)  
 \*Attention: Merci de vérifier emballage et format au moment de la commande (60x120-60x119,5)

FORMATI SIZES	SPESSORI THICKNESS	SUPERFICIE SURFACE						IMBALLI PACKING	Pezzi/Scatola Pcs/Box Stk./Karton Carreaux/Boîtes	Mq/Scatola SqM/Box M <sup>2</sup> /Karton Om/Boîtes	Kg/Scatola Kgs/Box Kg/Karton Kg/Boîtes	Scatola/Paletta Boxes/Pallet Karton/Palette Boîtes/Pallet	Mq/Paletta SqM/Pallet M <sup>2</sup> /Palette Om/Pallet	Kg/Paletta Kgs/Pallet Kg/Palette Kg/Pallet
			BIANCO	SABBIA	TERRA	GRIGIO	NERO							
PEZZI SPECIALI - SPECIAL PIECES														
 GRADINO 30x60 / 12"x24"	9,5mm	NAT	●	●	●	●	●	6	1,08	22	36	-	-	
 BATTISCOPA 8x60 / 3 <sup>1/8</sup> "x24"	9,5mm	NAT	●	●	●	●	●	10	mq 0,48 ml 6,00	11	72	-	-	
		NAT / RET	●	●	●	●	●							
 BATTISCOPA 8x80 / 3 <sup>1/8</sup> "x24"	10,5mm	NAT / RET	●	●	●	●	●	7	mq 0,448 ml 5,6	11	65	-	-	
 GRADONE 30x60 / 12"x24"	20mm	GRIP / RET R11	-	●	●	●	●	2	0,36	17	30	-	-	
 ELEMENTO AD L 30x60 / 12"x24"	20mm	GRIP / RET R11	-	●	●	●	●	2	0,36	17	30	-	-	

\*Attenzione: verificare in fase di ordine il formato e l'imballo (60x120-60x119,5)  
 \*Note: In the ordering phase please check size and packaging (60x120-60x119,5)  
 \*Bitteachten: Beim Bestellen bitte das Format und die Verpackung kontrollieren (60x120-60x119,5)  
 \*Attention: Merci de vérifier emballage et format au moment de la commande (60x120-60x119,5)

Gli spessori riportati in questo catalogo sono nominali e possono variare a seconda dei formati e delle finiture.  
 The thickness mentioned on this catalogue are nominal and can be different according to the sizes and the finishes.  
 Die angegebene Fliesenstärke sind Nominal und können verschieden sein je nach Format oder Oberfläche.  
 Les épaisseurs reportées sur ce catalogue sont nominales et peuvent varier suivant les formats et les finitions.

Per una migliore resa estetica Piemme consiglia stucature colorate in tinta con le piastrelle.  
 For a better aesthetic finish, Piemme recommends using jointing colours that match the tiles.  
 Für ein optisch perfektes Ergebnis empfiehlt Piemme, die Fugen farblich auf die Fliesen abzustimmen.  
 Pour parfaire l'effet esthétique obtenu, Piemme conseille de confectionner des joints de la même couleur que les carreaux.

Per i prodotti rettificati consigliamo una fuga di 2 mm per un migliore risultato di posa.  
 For better installation results of rectified products, we suggest 2 mm joint.  
 Damit sich eine bessere Verlegung von geschliffenen Produkten ergibt, empfehlen wir eine Fugenbreite von 2 mm.  
 Pour obtenir le meilleur résultat de pose de produits rectifiés, il est conseillé de réaliser un joint de 2 mm.

 Fascia prezzo al metro quadro  
 Square meter price range  
 Quadratmeter preisgruppe  
 Niveau de prix au mètre carré

 Fascia prezzo al pezzo  
 Price range per piece  
 Stück preisgruppe  
 Niveau de prix à la pièce

 Spessore mm  
 Thickness mm  
 Stärke mm  
 Epaisseur mm

Le tonalità dei colori sono indicative  
 The colour shades are indicative  
 Die farbtöne sind annähernd  
 Les tonalités des couleurs sont indicatives

# Caratteristiche Tecniche

Technical Characteristics - Technische Daten - Caracteristiques Techniques

Classificazione secondo norme CEN/ISO gruppo B1a EN 14411 - Iso 13006 - Classification in accordance with CEN/ISO standards B1a EN 14411 - Iso 13006  
 Klassifizierung gemäß CEN/ISO-Normen Gruppe B1a EN 14411 - Iso 13006 - Classification selon les normes CEN/ISO groupe B1a EN 14411 - Iso 13006

	<b>Caratteristica Tecnica</b> Technical Characteristic Technische Date Caractéristique Technique	<b>Norma</b> Norm Norm Norme	<b>Valore prescritto</b> Value required Normvorgabe Valeur prescrite	<b>Valore medio</b> Mean value Mittelwert Valeur moyenne	<b>USA tests</b> 	<b>Valore medio</b> Mean value Mittelwert Valeur moyenne
	<b>Lunghezza e larghezza</b> Length and width / Länge und Breite  <b>Spessore</b> Thickness / Stärke / Epaisseur  <b>Rettilineità lati</b> Warpages of edges / Geradheit der Kanten / Réctitude des arêtes  <b>Ortogonalità</b> Wedging / Rechtwinkligkeit / Orthogonalité  <b>Planarità</b> Flatness / Planität / Planimétrie	ISO 10545.2	±0,6% (±2,00 mm)  ±5% (±0,5 mm)  ±0,5% (±1,5 mm)  ±0,5% (±2,00 mm)  ±0,5% (±2,00 mm)	<b>Conforme</b> In accordance Erfüllt Conforme	ASTM C-499 ASTM C-485 ASTM C-502	In accordance
	Assorbimento % d'acqua Water absorption Wasseraufnahme % Absorption d'eau %	ISO 10545.3	≤ 0,5%	<b>Conforme</b> In accordance Erfüllt Conforme	ASTM C-373	In accordance
	Resistenza alla flessione Bending strength Biegezugfestigkeit Résistance à la flexion	ISO 10545.4	≥ 35N/mm <sup>2</sup>	<b>Conforme</b> In accordance Erfüllt Conforme	ASTM C-648 250 LBS or greater	In accordance
	Dilatazione termica lineare tra 20° e 100° C Linear thermal expansion between 20° and 100° C Lineare Wärmeausdehnung zwischen 20° und 100° C Dilatation thermique linéaire entre 20° et 100° C	ISO 10545.8	<b>Secondo i dati del costruttore</b> According to builder's specifications Lautangaben des Herstellers Selon les éléments du constructeur	≈ 7x10 <sup>-6</sup> C <sup>-1</sup>		
	Resistenza agli sbalzi termici Thermal shock resistance Temperaturwechselbeständigkeit Résistance aux écarts de température	ISO 10545.9	<b>Richiesta</b> Request Bitte Demande	<b>Resistente</b> Resistant Widerstehend Résistant		
	Resistenza al gelo Frost resistance Frostbeständigkeit Résistance au gel	ISO 10545.12	<b>Richiesta</b> Request Bitte Demande	<b>Resistente</b> Resistant Widerstehend Résistant	ASTM C-1026	In accordance
	Resistenza all'attacco chimico Resistance to chemical attack Beständigkeit gegen Chemikalien Résistance à l'attaque chimique	ISO 10545.13	<b>Secondo i dati del costruttore</b> According to builder's specifications Lautangaben des Herstellers Selon les éléments du constructeur	<b>Resistente</b> Resistant Widerstehend Résistant	ASTM C-650	In accordance
	Resistenza dei colori alla luce Colours resistance to light Lichtbeständigkeit Résistance des couleurs à la lumière	DIN 51094	<b>Nessuna alterazione</b> No alteration Keine Veränderung Aucune altération	<b>Conforme</b> In accordance Erfüllt Conforme		
	Resistenza alle macchie Stain resistance Fleckenfestigkeit Résistance aux taches	ISO 10545.14	≥ Classe 3 Metodo di prova disponibile Test method available Verfügbare prüfmethode Méthode d'essai disponible	<b>Conforme</b> In accordance Erfüllt Conforme		
	Resistenza allo scivolamento Slippage resistance Rutschsicherheit Résistance au glissement	DIN 51130 *	9 ≤ R ≤ 13	NAT CIOTTOLI NAT CIOTTOLI GRIP 20 MM	ASTM C-1028 * COF  ≥ 0,6 Dry ≥ 0,6 Wet	NAT Dry / Wet > 0.6  CIOTTOLI NAT CIOTTOLI GRIP 20 MM
		DIN 51097 *	A,B,C	NAT CIOTTOLI NAT CIOTTOLI GRIP 20 MM	ANSI * 137.1-2012 DCOF  > 0,42 Wet	NAT CIOTTOLI NAT CIOTTOLI GRIP 20 MM  > 0.42
	Pendulum slip test	BS EN 7976-2*	> 36 Dry > 36 Wet	NAT CIOTTOLI NAT CIOTTOLI GRIP 20 MM		

\*Trattandosi di normative nazionali, i metodi di prova, i requisiti e le classificazioni variano da paese a paese. Il valore atteso dalla resistenza allo scivolamento della produzione di Industrie Ceramiche Piemme S.p.a., può variare in base al lotto produttivo. Specifica documentazione è disponibile su richiesta. ELENCO DELLE SERIE CERTIFICATE E CLASSIFICAZIONI DISPONIBILI A RICHIESTA.

Test methods, requirements and classifications differ from country to country, according to the national regulations. The expected value of slippage resistance of products by Industrie Ceramiche Piemme S.p.a. may vary depending on the production batch. Specific documents are available upon request. LIST OF CERTIFIED SERIES AND CLASSIFICATIONS AVAILABLE UPON REQUEST.

Prüfverfahren, Erfordernisse und Klassifikationen sind verschieden von Land zu Land, gemäß der nationalen Vorschriften. Der Erwartungswert der Rutschsicherheit der Produkte von Industrie Ceramiche Piemme S.p.a. kann sich je nach der Produktionspartie - verändern. Spezifische Unterlagen sind auf Verlangen zur Verfügung. LISTE DER GEPRÜFTEN SERIE UND KLASSIFIZIERUNGEN AUF ANFRAGE ERHÄLTICH.

Les méthodes d'essai, les réquisitions et les classifications changent de pays à pays, selon les réglementations nationales. La valeur attendue de résistance au glissement des produits de Industrie Ceramiche Piemme S.p.a. peut varier en fonction du lot de production. Une documentation spécifique est disponible sur demande. LISTE DES SERIES CERTIFIÉES ET DES CLASSEMENTS DISPONIBLES SUR DEMANDE.

LISTE DES SERIES CERTIFIÉES ET DES CLASSEMENTS DISPONIBLES SUR DEMANDE. CONCERNANT LA NORME UPEC, VEUILLEZ SVP VERIFIER DIRECTEMENT SUR INTERNET EN TAPANT "UPEC PIEMME"  
 LES REFERENCES ET/OU FINITIONS EVENTUELLEMENT PAS ENCORE A CE JOUR CERTIFIÉES.



# Norme per la posa e la manutenzione

Installation and maintenance instructions - Verlegung, reinigung und pflege

Guide a la pose et l'entretien

	<b>TIPO DI SPORCO</b>	<b>INDICAZIONI PER LA PULIZIA</b>
<ul style="list-style-type: none"> <li>- Per i prodotti rettificati consigliamo una fuga di 2 mm per un migliore risultato di posa.</li> <li>- Per una migliore resa estetica Piemme consiglia stuccature colorate in tinta con le piastrelle.</li> <li>- <b>Verificare, prima dell'utilizzo, la compatibilità ed idoneità dei riempitivi per fughe con il prodotto ceramico.</b></li> <li>- <b>Rimuovere le eccedenze dei riempitivi per fughe quando gli stessi sono ancora freschi.</b></li> <li>- <b>Attenersi scrupolosamente alle istruzioni indicate dai produttori dei riempitivi per fughe.</b></li> <li>- Per eliminare completamente i residui di posa, che potrebbero compromettere la manutenzione ordinaria e le caratteristiche del prodotto, a posa ultimata, procedere con la pulizia utilizzando prodotti adeguati, a base Acida max 3%, rispettando le indicazioni del produttore. Osservare assolutamente i limiti di tempo indicati nelle istruzioni: un contatto troppo prolungato con questi prodotti potrebbe provocare il danneggiamento della superficie.</li> <li>- Gli eventuali aloni che si dovessero presentare dopo la posa di materiali lappati o levigati si potranno facilmente eliminare utilizzando un prodotto idoneo, a base Alcalina.</li> <li>- Riguardo l'utilizzo di materiali ceramici all'esterno, pure riconfermando l'ingelività dei prodotti Piemme in gres porcellanato, in conformità alle vigenti normative europee EN 14411/ISO 13006-ISO 10545.12, occorre attenersi ad alcune fondamentali norme previste per la posa all'esterno, atte a rendere inattaccabili al gelo i predetti pavimenti. Le condizioni più importanti da rispettare sono: le opportune pendenze, le impermeabilizzazioni, i giunti di dilatazione, e l'uso di idonei materiali per la posa.</li> <li>- <b>Decorazioni realizzati con smalti e metalli preziosi</b> E' indispensabile proteggere la superficie durante la posa, non utilizzare assolutamente prodotti abrasivi e/o acidi, ma solo acqua e sapone neutro. Il produttore non risponde di eventuali danni a questi preziosi materiali causati da "sfregamenti" durante la posa in opera. Per nessun motivo saranno accettate contestazioni relative a materiale posato.</li> </ul>	<p>Birra - Caffè - Gelato - Vino Gomma Pneumatico - Grassi vegetali e animali - Inchiostri - Lamposti Olii Meccanici - Residui di scotch Olio di lino - Pennarello - Resine Smalti - Tintura per capelli</p> <p>Cera protettiva anti-abrasione Depositi calcarei Macchie di ruggine</p> <p>Cera di candela Residui di scotch</p> <p><b>Prodotti a Base Alcalina</b></p> <p><b>Prodotti a Base Acida</b></p> <p><b>Solventi</b></p> <p>Per ulteriori informazioni specifiche consultare l'area tecnica sul sito Piemme: <b>www.ceramichepiemme.it</b></p>	

	<b>TYPE OF STAIN</b>	<b>CLEANING SUGGESTIONS</b>
<ul style="list-style-type: none"> <li>- For better installation results of rectified products, we suggest 2 mm joint.</li> <li>- For a better aesthetic finish, Piemme recommends using jointing colours that match the tiles.</li> <li>- <b>Please check, before using, the compatibility and suitability of grouting material with the ceramic tile.</b></li> <li>- <b>Clean away the excess of grouting materials while they are still fresh.</b></li> <li>- <b>Follow carefully the instructions pointed out by the producers of tile grouting materials.</b></li> <li>- To completely eliminate installation residues, which could negatively affect routine maintenance and product characteristics once installation has terminated, proceed to clean using adequate products, with max. 3% Acid base, following the manufacturer's instructions. Always closely abide by the time limits indicated in the instructions: prolonged contact with these products may cause damage to the surface.</li> <li>- Any rims that appear after installing lapped or polished materials can be easily eliminated using a suitable Alkaline-based product.</li> <li>- With regard to the use of ceramic materials outdoors, while once more reiterating that Piemme porcelain stoneware products are frost-proof, in compliance with applicable European standards EN 14411/ISO 13006-ISO 10545.12, a number of fundamental procedures must be followed for outdoor installation, suitable for making the aforementioned floors resistant to frost. The most important aspects are: suitable gradients, waterproofing, expansion joints, and the use of suitable installation materials.</li> <li>- <b>Decorations made with glazes and precious metals</b> It is most important to protect the surface during installation. Never use abrasive and/or acid products, only water and neutral soap. The manufacturer disclaims liability in case of any damage to these precious materials caused by "rubbing" during installation. Under no circumstances will disputes be accepted relating to the installed material.</li> </ul>	<p>beer - coffee - wine - ice cream vegetable and animal fats - rubber remains of scotch tape - grease from machines - linseed oil - felt tip pens - paints - inks - hair dye</p> <p>protective anti-abrasion wax calcareous residuals rust stains</p> <p>candle wax remains of scotch-tape</p> <p><b>Alkaline-based detergent</b></p> <p><b>Acid-based detergent</b></p> <p><b>Solvent</b></p> <p>For further specific details please visit the technical area on Piemme website: <b>www.ceramichepiemme.it</b></p>	

	<b>VERSCHMUTZUNGSART</b>	<b>REINIGUNGSHINWEISE</b>
<ul style="list-style-type: none"> <li>- Damit sich eine bessere Verlegung von geschliffenen Produkten ergibt, empfehlen wir eine Fugenbreite von 2 mm.</li> <li>- Für ein optisch perfektes Ergebnis empfiehlt Piemme, die Fugen farblich auf die Fliesen abzustimmen.</li> <li>- <b>Prüfen sie bitte, vor der Verwendung, die Zweckmäßigkeit und die Verträglichkeit des Fugenfüllmittels mit den Keramikfliesen.</b></li> <li>- <b>Bitte entfernen sie das überflüssige Fugenfüllmittel wenn es noch frisch ist.</b></li> <li>- <b>Folgen sie bitte sorgfältig die von dem Herstellern des Fugenfüllmittels angegebenen Bedienungsvorschriften.</b></li> <li>- Zur vollkommenen Entfernung der Verlegerückstände, die die normale Pflege erschweren und die Merkmale des Produkts beeinträchtigen könnten, nach der Verlegung geeignete Reinigungsmittel auf max. 3% Säurebasis verwenden und bei der Reinigung die Hinweise des Herstellers beachten. Die angegebenen Zeiten keinesfalls überschreiten: ein zu lange andauernder Kontakt mit diesen Produkten kann Beschädigungen der Oberfläche verursachen.</li> <li>- Eventuelle nach der Verlegung von geläppter oder geschliffenem Material sichtbare Schleier lassen sich einfach mit entsprechenden, alkalischen Produkten entfernen.</li> <li>- Auch wenn die Piemme-Feinsteinzeugprodukte gemäß den europäischen Normen EN 14411/ISO 13006-ISO 10545.12 frostbeständig sind, müssen beim Einsatz keramischer Materialien im Freien einige Grundregeln beachtet werden, damit die Bodenbeläge nicht vom Frost angegriffen werden können. Die wichtigsten Voraussetzungen sind: korrektes Gefälle, Abdichtung, Dehnungsfugen sowie geeignetes Verlegematerial.</li> <li>- <b>Dekore mit Glasuren und Edelmetallen</b> Während der Verlegung muss die Oberfläche unbedingt abgedeckt werden. Es dürfen keine scheuernden und/oder säurehaltigen Produkte verwendet werden, sondern ausschließlich Wasser und neutrale Seife. Der Hersteller haftet nicht für eventuelle, während der Verlegung durch Abrieb entstandene Schäden an diesen hochwertigen Materialien. Reklamationen von bereits verlegtem Material werden in keinem Fall akzeptiert.</li> </ul>	<p>Bier - Wein - Eis - Kaffee Tierische oder pflanzliche Fette Gummi - Kleberbandresten Schmieröl - Tinte - Leilöl - Filzstift - Harz oder Lack - Haarfarbe</p> <p>Kratzenschutz-Wachs Kalkablagerunge Rostflecken</p> <p>Kerzenwachs Kleberbandresten</p> <p><b>Alkalische Reinigungsmittel</b></p> <p><b>Säure-Reinigungsmittel</b></p> <p><b>Lösungsmittel</b></p> <p>Weitere Einzelheiten finden Sie in dem technischen Bereich des Piemme Website: <b>www.ceramichepiemme.it</b></p>	

	<b>TYPE DE TACHE</b>	<b>NETTOYAGE CONSEIL</b>
<ul style="list-style-type: none"> <li>- Pour obtenir le meilleur résultat de pose de produits rectifiés, il est conseillé de réaliser un joint de 2 mm.</li> <li>- Pour parfaire l'effet esthétique obtenu, Piemme conseille de confectionner des joints de la même couleur que les carreaux.</li> <li>- <b>Vérifier avant la pose la compatibilité et convenance des remplissages pour joints avec le produit céramique.</b></li> <li>- <b>Enlever les surplus des remplissages pour joints alors qu'ils sont encore frais.</b></li> <li>- <b>Respecter scrupuleusement les instructions indiquées par les fabricants de remplissages pour joints.</b></li> <li>- Pour éliminer complètement tout résidu de pose pouvant gêner l'entretien courant et altérer les caractéristiques du produit, il est conseillé, à la fin de la pose, de procéder au nettoyage du carrelage avec des produits à base acide maximum 3% et de respecter les consignes du fabricant. Suivre impérativement les délais indiqués dans la notice car le contact trop prolongé de ces produits pourrait endommager la surface.</li> <li>- Pour éliminer facilement la présence éventuelle de cernes après la pose de carreaux rodés ou polis, utiliser un produit à base alcaline.</li> <li>- Pour ce qui est de la pose à l'extérieur, bien que les produits Piemme en grès cérame soient ingélifs, conformément aux normes européennes EN 14411/ISO 13006-ISO 10545.12, il convient cependant de respecter quelques règles fondamentales de manière à rendre le carrelage inattaquable au gel. Les conditions les plus importantes à remplir sont: le degré d'inclinaison, l'imperméabilisation, les joints de dilatation et l'utilisation de matériaux de pose appropriés.</li> <li>- <b>Décorés réalisés avec des émaux et des métaux précieux</b> Il est indispensable de protéger la surface pendant la pose. N'utiliser en aucun cas des produits abrasifs et/ou acides mais uniquement de l'eau et du savon neutre. Le fabricant ne répond pas des dommages éventuels de ces matériaux précieux causés par le frottement pendant la pose. Aucune réclamation, quelle qu'elle soit, concernant le matériau posé ne sera acceptée.</li> </ul>	<p>Bière - Vin - Glace - Café - Graisses végétales et animales - Encres Résidus de scotch - Huile de graissage - Hile de lin Crayon feutre Emaux - Teinture pour cheveux Caoutchouc pour pneus</p> <p>Cire de protection anti abrasion Dépôts de calcaire Tache de rouille</p> <p>Cire de bougie Résidus de scotch</p> <p><b>Détergents à base alcaline</b></p> <p><b>Détergents à base d'acide</b></p> <p><b>Solvant</b></p> <p>Pour d'ultérieures informations spécifiques consulter le département technique du site Piemme: <b>www.ceramichepiemme.it</b></p>	

# Voci di capitolato

Specifications - Technische Beschreibung - Caractéristiques

<b>GRES FINE PORCELLANATO</b>  Superficie ceramica formata da un supporto compatto derivato da una miscela di pregiati minerali e decorato in superficie con smalti particolarmente resistenti. Resistente agli sbalzi termici, al gelo, all'attacco degli acidi e delle basi e tecnologicamente avanzato, trova impiego in condizioni di traffico medio pesanti. In base alle norme UNI EN 14411, viene classificato nel gruppo Bla ed è conforme ai requisiti della norma UNI EN 14411-G.	Assorbimento d'acqua	ISO 10545.3	≤ 0,5%
	Resistenza alla flessione	ISO 10545.4	≥ 35N/mm <sup>2</sup>
	Resistenza all'attacco chimico	ISO 10545.13.14	Resistente
	Resistenza al gelo	ISO 10545.12	Resistente
	Resistenza agli sbalzi termici	ISO 10545.9	Resistente
	Resistenza dei colori alla luce	DIN 51094	Conforme
	Resistenza allo scivolamento	DIN 51130	R11 (ciottoli grip)

<b>PORCELAIN STONEWARE</b>  Ceramic surface consisting of a compact substrate made of a mix of precious materials and decorated on surface with particularly resistant glazes. Resistant against heat fluctuations, frost, acid and base attack, and technologically advanced, it is ideal for use in medium-heavy traffic situations. According to UNI EN 14411 standards, it is classified in the Bla group and complies with UNI EN 14411-G standard requirements.	Water absorption	ISO 10545.3	≤ 0,5%
	Bending strength	ISO 10545.4	≥ 35N/mm <sup>2</sup>
	Resistance to chemical attack	ISO 10545.13.14	Resistant
	Frost resistance	ISO 10545.12	Resistant
	Thermal shock resistance	ISO 10545.9	Resistant
	Colours resistance to light	DIN 51094	In accordance
	Slippage resistance	DIN 51130	R11 (ciottoli grip)

<b>FEINSTEINZEUG</b>  Keramikoberfläche mit einer kompakten Unterlegplatte aus einer Mischung hochwertiger Mineralstoffe und mit besonders beständigen Glasuren dekorierter Oberfläche. Beständig gegen Temperaturschocks, Frost, Säuren und Laugen sowie technologisch ausgereift für den Einsatz in mittlerem bis hohem Verkehr ausgesetzten Bereichen. Entspricht den Normen UNI EN 14411, zur Gruppe Bla gehörig und den Voraussetzungen der Norm UNI EN 14411-G konform.	Wasseraufnahme	ISO 10545.3	≤ 0,5%
	Biegezugfestigkeit	ISO 10545.4	≥ 35N/mm <sup>2</sup>
	Beständigkeit gegen Chemikalien	ISO 10545.13.14	Widerstehend
	Frostbeständigkeit	ISO 10545.12	Widerstehend
	Temperaturwechselbeständigkeit	ISO 10545.9	Widerstehend
	Lichtbeständigkeit	DIN 51094	Erfüllt
	Rutschsicherheit	DIN 51130	R11 (ciottoli grip)

<b>GRÈS CÉRAME</b>  Surface céramique formée d'un tesson compact issu d'un mélange de minéraux précieux; décor réalisé en surface avec des émaux particulièrement résistants. Résistance aux écarts thermiques, au gel, à l'attaque des acides et des bases. Matériau obtenu grâce à des technologies de pointe dont l'utilisation est indiquée en cas de passage moyennement intense. Aux termes des normes UNI EN 14411, ce matériau est classé dans le groupe Bla et il est conforme aux exigences de la norme UNI EN 14411-G.	Absorption d'eau	ISO 10545.3	≤ 0,5%
	Résistance à la flexion	ISO 10545.4	≥ 35N/mm <sup>2</sup>
	Résistance à l'attaque chimique	ISO 10545.13.14	Résistant
	Résistance au gel	ISO 10545.12	Résistant
	Résistance aux écarts de température	ISO 10545.9	Résistant
	Résistance des couleurs à la lumière	DIN 51094	Conforme
	Résistance au glissement	DIN 51130	R11 (ciottoli grip)

Gennaio 2019

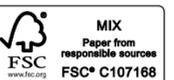

FSC® è una certificazione che consente al consumatore finale di riconoscere i prodotti fabbricati con materie prime che vengono da foreste gestite in modo responsabile anche dal punto di vista sociale.

FSC® is a certification that allows the consumer to identify products manufactured with raw materials from forests that are managed in a responsible manner from the point of view of social issues.

VALENTINO

BY CERAMICHE PIEMME

A BRAND OF:

INDUSTRIE CERAMICHE PIEMME S.P.A  
VIA DEL CROCIALE 42/44 - 41042 FIORANO (MO) - ITALY  
TEL. +39 0536.849.111 - FAX +39 0536.849.402  
WWW.CERAMICHEPIEMME.IT - INFO@CERAMICHEPIEMME.IT