

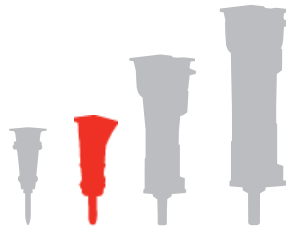





Rammer® 155E

EXCELLENCE LINE
SMALL RANGE HAMMER



APPLICATIONS

 Excavation	 Building Construction	 Recycling
 Special	 Crushing & Screening	 Demolition

MAIN FEATURES AND BENEFITS

OPTIMUM PRODUCTIVITY WITH EVERY BLOW

Harness the power of data to maximize the hammer's uptime and performance.

SUCCESS THROUGH WHOLE LIFECYCLE

Strong Rammer network support and 10 years spare parts availability guaranteed.

BEST POWER-WEIGHT RATIO IN THE MARKET

Reduced fuel usage for optimum productivity and more savings in money.

DURABLE LIKE NO OTHER

Extreme durability for any application to ensure longest life span.



Rammer® 155E

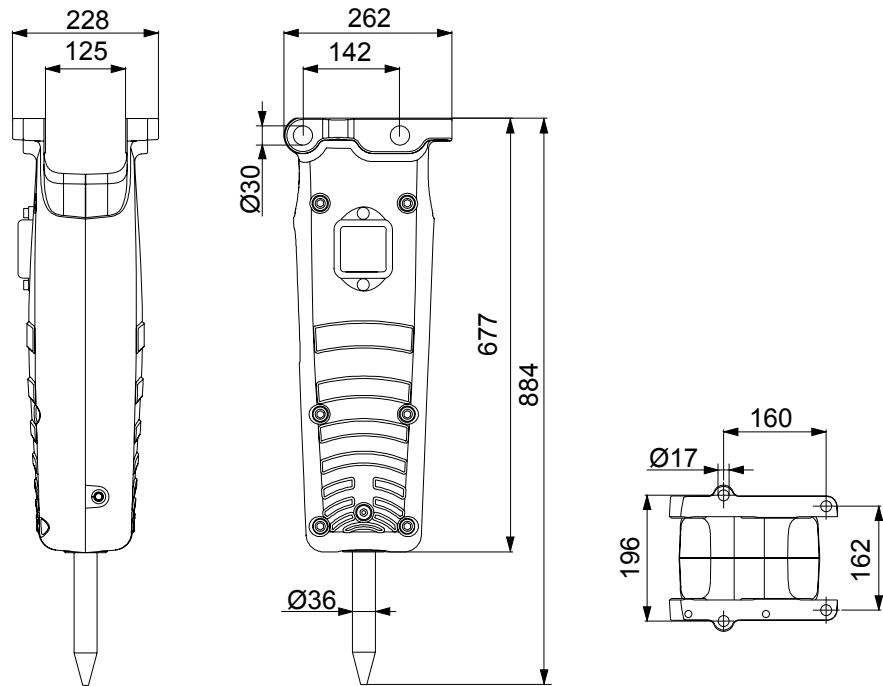

Specifications

Minimum working weight, flange mounted, kg (lb)	90 (200)
Impact rate, bpm	1000-2600
Operating pressure, bar (psi)	80-130 (1160-1885)
Pressure relief, max bar (psi)	220 (3190)
Oil flow range, l/min (gal/min)	15-33 (4.0-8.7)
Back pressure, max bar (psi)	20 (290)
Input power, kW (hp)	7.2 (10)
Tool diameter, mm (in)	36 (1.42)
Miniexcavator weight, allowed range t (lb)	0.8-1.8 (1800-4000)
Skid steer, robot weight, allowed range t (lb)	0.6-1.3 (1300-2900)
Noise level, measured sound power level, LWA dB	115
Noise level, guaranteed sound power level, LWA dB	119

Specifications are subject to change without notice



Developed and tested in the harshest of conditions, the foundations of Rammer products are quality, operational reliability and maximized productivity. Long working life and durability ensure our attachments can be used efficiently and economically no matter the challenge at hand, making Rammer a sustainable choice.

Sandvik Mining and Construction Oy

www.rammer.com

Rammer®