



OmniPL®

Pool Automation and Chlorination

Installation Manual



Contents

Before You Begin.....2

Overview.....3

Mounting Equipment.....7

Plumbing.....10

Electrical Wiring.....14

Preparing Pool/Spa Water.....26

System Startup.....29

Configuration.....29

HLPRO4SW
HLPRO4W

HLPRO4S
HLPRO4

Hayward Industries
 1415 Vantage Park Dr., Suite 400
 Charlotte, NC 28203
 Phone: (908) 355-7995
www.hayward.com



HAYWARD®

IMPORTANT SAFETY INSTRUCTIONS

When using this electrical equipment, basic safety precautions should always be followed, including the following:

- READ AND FOLLOW ALL INSTRUCTIONS
- **WARNING:** Disconnect all AC power during installation.
- **WARNING:** Water in excess of 100 degrees Fahrenheit may be hazardous to your health.
- **WARNING:** To reduce the risk of injury, do not permit children to use this product unless they are closely supervised at all times.
- **WARNING:** Do not use the OmniPL to control fire pits or related equipment.
- A green colored terminal marked "Grounding" is located inside the wiring compartment. To reduce the risk of electric shock, this terminal must be connected to the grounding means provided in the electric supply service panel with a continuous copper wire equivalent in size to the circuit conductors supplying the equipment.
- One bonding lug for US models (two for Canadian models) is provided on the external surface. To reduce the risk of electric shock, connect the local common bonding grid in the area of the swimming pool, spa, or hot tub to these terminals with an insulated or bare copper conductor not smaller than 8 AWG US / 6 AWG Canada.
- All field installed metal components such as rails, ladders, drains, or other similar hardware within 3 meters of the pool, spa or hot tub shall be bonded to the equipment grounding bus with copper conductors not smaller than 8 AWG US / 6 AWG Canada.

SAVE THESE INSTRUCTIONS



HAYWARD®

FCC Statement

This device complies with part 15 of the FCC rules. Operation is subject to the following two conditions: (1) This device may not cause harmful interference, and (2) this device must accept any interference received, including interference that may cause undesired operation.

Changes or modifications not expressly approved by Hayward could void the user's authority to operate this equipment.

NOTE: This equipment has been tested and found to comply with the limits for a Class B digital device, pursuant to Part 15 of the FCC Rules. These limits are designed to provide reasonable protection against harmful interference in a residential installation. This equipment generates, uses and can radiate radio frequency energy and, if not installed and used in accordance with the instructions, may cause harmful interference to radio communications. However, there is no guarantee that interference will not occur in a particular installation. If this equipment does cause harmful interference to radio or television reception, which can be determined by turning the equipment off and on, the user is encouraged to try to correct the interference by one or more of the following measures:

- Reorient or relocate the receiving antenna.
- Increase the separation between the equipment and receiver.
- Connect the equipment into an outlet on a circuit different from that to which the receiver is connected.
- Consult the dealer or an experienced radio / TV technician for help.

Industry Canada Statement

This Class B digital apparatus complies with Canadian ICES-003.

Cet appareil numérique de la classe B est conforme à la norme NMB-003 du Canada.

The term "IC" before the certification / registration number only signifies that the Industry Canada technical specifications were met.



Table of Contents

Introduction	Installation Steps.....	5
Preparing Mounting Equipment	OmniPL Wiring Panel.....	7
	OmniPL Controller.....	7
	Smart Relay.....	8
	Temperature Sensors.....	9
	Optional Chlorination.....	9
	Optional HL-CHEM Sensing Kit.....	9
	Optional AQL-CHEM2 pH Dispensing.....	9
Optional Valve Actuators.....	10	
Plumbing	Pool/Spa Configuration.....	10
	TurboCell.....	13
	Flow Switch.....	13
Electrical Wiring	Main Service.....	15
	Grounding and Bonding.....	15
	Circuit Breaker Installation and Wiring.....	15
	OmniPL Power.....	15
	Pool Equipment Connection Table.....	16
	High Voltage Pool Equipment.....	17
Low Voltage Wiring.....	20	
Pool/Spa Water	General Water Chemistry.....	26
	Salt.....	27
Final Steps	System Startup.....	29
Startup and Configuration	Startup and Configuration Wizard.....	29
	Bodies of Water.....	32
	Filter Pumps.....	33
	Heaters/Chillers.....	35
	HL-CHEM.....	39
	Chlorinator.....	40
	Cleaners.....	41
	Water Features.....	43
	Lights.....	45
	Accessories.....	45
	Shared Equipment.....	47
	Sensors.....	48
Backyard Accessories.....	49	
Interlocks.....	50	
Quick Edit.....	52	
Warranty	OmniPL Limited Warranty.....	64



HAYWARD®

Before you Begin

What's Included

Check that the following components have been included in your package:

- OmniPL Wiring Panel
- OmniPL Controller
- 2 Temperature Sensors

What's NOT Included

Some of the additional items that you may need to complete an installation include:

Wire

- Wire/conduit for incoming power and high voltage connections
- Wire for remote variable speed pump control and other low voltage devices
- Ethernet cable (if not using wifi)

Miscellaneous

- Valve actuator to automate pool functions
- Flow switch (included with some models) for optional pump protection/flow monitoring (required if using chlorination or Sense and Dispense accessories)
- Mounting hardware for mounting Wiring Panel and Controller
- Cable/cord connectors to provide knockout strain relief
- Wire nut connectors

Tools Needed

Phillips and flat screwdrivers	Wire cutters and strippers	Knife to cut conduit
Drill and drill bits (including 3/8")	Pliers	Level

Accessory Products - Order Separately

GLX-FLO	Flow Switch used to detect water flow
GVA-24	Valve Actuator
2PC	Temperature Sensor for 3rd input
HLSPASIDE	Wired Spa Remote
HLRELAY	Single High Voltage relay kit
HLH485RELAY	Single RS485 Smart Relay kit
HLWALLMOUNT	Wired Wall Mount Remote Terminal
HLWIRELESS	Portable Wireless Remote Terminal
HL-CHEM	ORP & pH Sensing Kit for monitoring and controlling pool chemistry (requires GLX-FLO flow switch)
HL-CHEM4-ACID	Liquid acid feeder (requires GLX-FLO flow switch)
HL-CHEM4-CHLOR	Liquid chlorine feeder (requires GLX-FLO flow switch)
TCELLS325	Chlorinator Cell - generates chlorine for pools up to 25k gallons
TCELLS340	Chlorinator Cell - generates chlorine for pools up to 40k gallons
P-KIT	Chlorination plumbing kit containing flow switch and cell unions



HAYWARD®

AQR940/AQR925 Aqua Rite chlorine generator for additional chlorination (requires HLAQRPCB)
V&A-xx Valve & Actuator (xx=1P (1.5" pos. seal), -2P (2" pos. seal))
CL200 Chlorine tablet feeder

Overview

The Hayward OmniPL is a web enabled pool automation control with a convenient touchscreen interface. Automatically and remotely control pumps, heaters, valve actuators, pool and yard lighting, pool chemistry equipment and more. The OmniPL offers the next generation of technology to manage pool/spa equipment, allowing communication to web connected computers and mobile devices. You can now conveniently monitor your pool/spa and change settings anytime, and from anywhere.

The various OmniPL models offer different functions and features. Refer to the information below to determine your model's capability. This manual may refer to instructions that are not relevant to your particular model. In those cases, skip those sections. For example, if your model doesn't offer salt chlorination, you can skip all references to setting up the pool for chlorination as well as configuration and operation of the chlorinator.

Model	Salt Chlorination	Web Access	Includes TurboCell
HLPLUS4W	Yes	Yes	Yes
HLPLUS4	Yes	No	Yes
HLPRO4SW	Yes	Yes	No
HLPRO4S	Yes	No	No
HLPRO4W	No	Yes	No
HLPRO4	No	No	No

Please read this manual thoroughly before attempting to install, configure or operate this unit. The functions and features described in this manual assume that the OmniPL is using the latest firmware version available from Hayward.

Features

The Hayward OmniPL offers the following functionality:

- 100A service subpanel with 8 circuit breaker capacity
- 4 high voltage (120/240V) relays to control pumps, pool lights, yard lights, water features, chemical dispensers and more (2 additional internal relays and 2 external Smart Relays can be added for up to 8 total)
- control up to 4 automatic valve actuators including pool and spa valves, water feature valves, cleaner valves and more
- control up to 2 heaters or low voltage equipment including gas heaters, electric heat pumps, and solar heaters as well as various low voltage devices
- controls up to 8 variable speed pumps* (VSPs) and Smart Heaters without the use of a relay
- up to 5 external inputs; 3 for temperature sensing, 2 for external input devices



HAYWARD®

- built-in wireless and Ethernet port for connection to the home's router/access point allowing communication to devices on the home network or on the web (some models)
- connection for Hayward TurboCell used to generate chlorine (some models)
- connection for a flow switch to detect water flow (GLX-FLO)
- input for ORP and pH sensing (HL-CHEM)
- control an optional Hayward Aqua Rite salt chlorinator for additional chlorination. If controlled by the OmniPL, the Aqua Rite must have a HLAQRPCB communication board installed (some models)

Optional accessories (page 2) can expand the functionality of the OmniPL. Determine your needs and select the necessary accessories before you begin the installation.

Equipment

OmniPL Wiring Panel

The Wiring Panel contains a 100A subpanel which will be connected to the main service. The included high voltage relays (and optional external Smart Relays) are used to automate high voltage pool equipment like lights, water features, pumps and more. The remaining connections to the Wiring Panel, including the Controller, are all low voltage. Depending on your installation, these connections could be to a variable speed pump, Smart Relays, heaters, temperature sensors, actuator, flow switch and more.

OmniPL Controller

The Controller is weather resistant and comes with a 15 ft cord. Its resistive touch screen with flip down cover is designed to function year round directly in the elements. Because it plugs into the Wiring Panel, it should be mounted close by, but in a location that is convenient for the user to periodically view and change pool/spa settings. Lastly, the Controller contains the wifi radio and for models that offer web access, its location should be considered if planning to use a wireless connection to the home router or access point. A wireless mobile device (phone, tablet, etc.) can be used to test the signal strength at the intended mounting location. The Controller features an Ethernet connector for an optional direct wire connection to your router (if wifi won't be used).

Temperature Sensors

Depending on your installation, up to 3 temperature sensors may be used. The OmniPL requires a water temperature sensor for heater operation. If freeze protection is desired, an air temperature sensor is also required. For solar heating systems, a solar sensor is necessary. If your installation doesn't require the use of temperature sensors, consider installing water and air sensors as they provide a convenience to the user, especially during remote use.

Flow Switch (included with some models)

Up to two optional flow switches can be used to detect leaks or clogs in the pool/spa plumbing. A flow switch is required for salt chlorination or if using chemistry Sense and Dispense accessories.

* If a non-Hayward brand VSP or an older non-supported Hayward VSP will be used, the pump can only operate at one speed. The pump must be locally programmed to run 24 hrs/day at a fixed speed and the OmniPL will turn it on and off based on the desired programmed time. Follow instructions to install and function like a single speed pump.

For some Pentair VSP pumps, a Hayward HLPMPCONV communication board can be used for full speed control.



HAYWARD®

Overview

Before attempting to install the OmniPL, familiarize yourself with the installation steps on the following pages. Also refer to the sample overview diagram on page 6. In this example the high voltage to the variable speed pump (VSP), heater and Smart Relay come directly from circuit breakers in the electrical panel. Low voltage communication from the OmniPL turns these devices on and off. If there were a single speed pump in the system, the power would come from one of the OmniPL's internal relays or a Smart Relay. In that scenario, the relay would turn the pump on and off.

Depending on your model, the OmniPL offers connectivity to the web through the home's network. Once connected, web enabled devices such as a PC, laptop, tablet or phone can be used to control and monitor the OmniPL.

The overview diagram on page 6 is offered as a guide and it's likely that your installation will differ. Refer to the following pages for specific wiring information. Be aware of each circuit breaker's rating and don't exceed their rated load.

Installation Steps

DANGER of Death, Injury or Property Damage if procedure not followed. Dead front panel removal is required for this installation. Power to the OmniPL electrical panel **MUST** be shut off before the dead front is removed.

Details on each installation step are presented on the following pages:

1. Mounting the equipment (page 7)
2. Plumbing (page 10)
3. Electrical Wiring (page 14)
4. Prepare the pool water (page 26)
5. System Startup, Firmware Upgrade and Configuration (page 29)

NOTE: If replacing a Pro Logic Controller using networked ColorLogic Lights, the lights must be put into "Standalone" (default) mode before disconnecting the Pro Logic. The OmniPL can only control ColorLogic lights in "Standalone" mode.



HAYWARD®

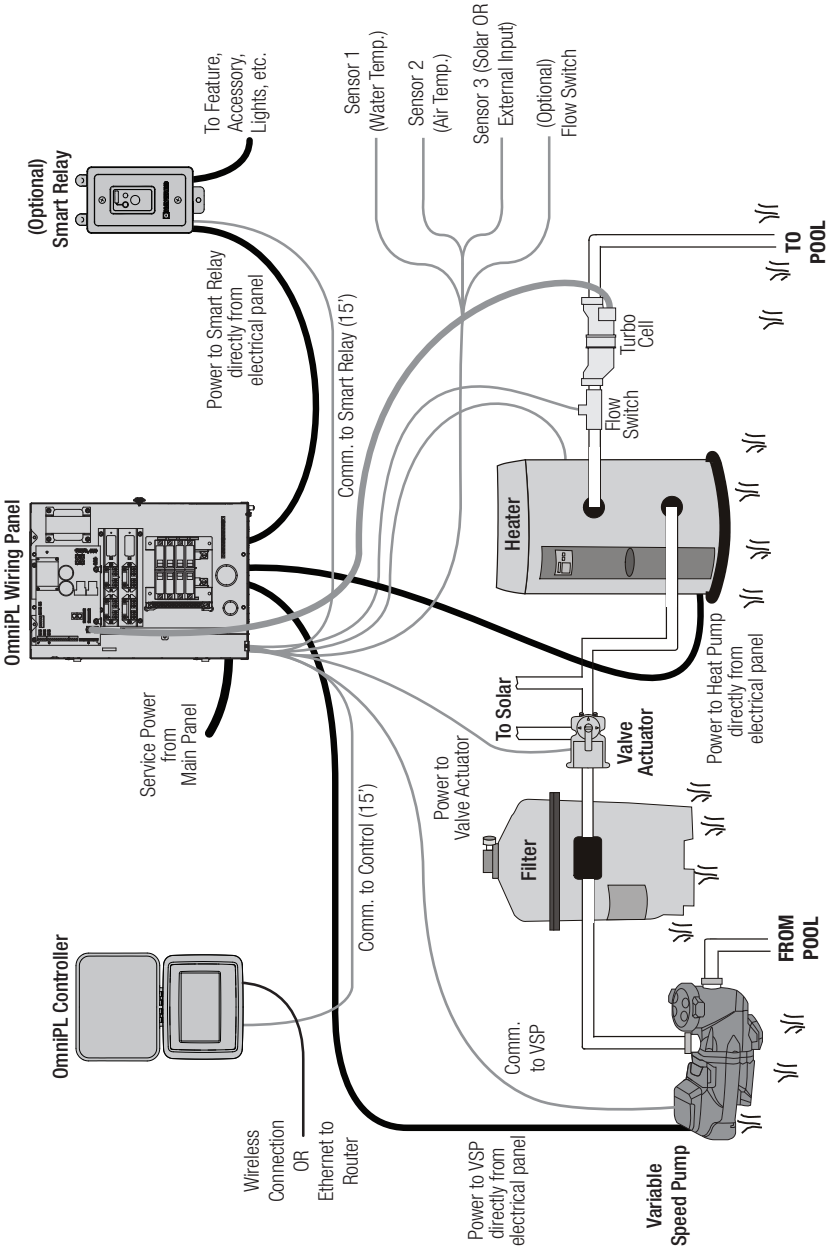



HAYWARD®

Mounting the Equipment

OmniPL Wiring Panel

The OmniPL Wiring Panel is contained in a raintight enclosure that is suitable for outdoor mounting. The control must be mounted a minimum of 6 ft. (2 meters) horizontal distance from the pool/spa (more, if local codes require). The Wiring Panel is designed to mount vertically on a flat surface with the knockouts facing downward. Because the enclosure also acts as a heat sink (disperses heat from inside the box), it is important not to block the four sides of the control. Do not mount the Wiring Panel inside a panel or tightly enclosed area.

When selecting a location, note that the standard cables lengths for flow switches and temperature sensors, as well as optional accessories like Hayward TurboCells and actuators are all 15 ft. (5m) long.

The Wiring Panel is heavy and may require two people to position and install. Select the proper location and mounting hardware given the size and weight of the unit. The Wiring Panel mounting brackets require a total of 6 mounting bolts to fasten to the mounting surface.

OmniPL Controller

The Controller comes with a 15 ft cord and plugs into the Wiring Panel. It should be mounted in a location that is convenient for the user to view and change pool/spa settings. When considering the mounting location, make sure there is enough clearance above the enclosure so that the flip door is able to be opened fully. Also be sure to allow enough clearance below the Controller to access the Ethernet connector if used. For best viewing results, position the Controller where it won't be subjected to direct sunlight.

The Controller has two keyhole cutouts on the back of its enclosure. To mount, screw the two provided fasteners into the mounting surface at the desired location as shown. A mounting template can be found on the back cover of this manual. Tighten until the bottom of the screw heads are 1/8" off the mounting surface. Position the Controller cutouts over the screw and slide the unit downward. You may have to tighten or loosen the screws slightly to fully engage the screw heads to get a snug fit.

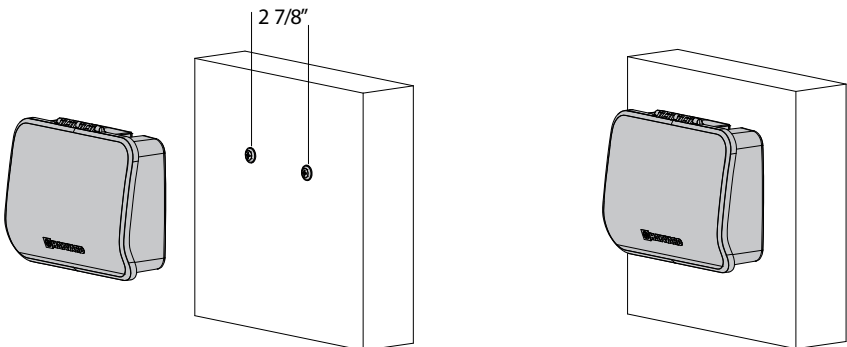



HAYWARD®

Smart Relay (HLH485RELAY)

The OmniPL can control up to 6 internal high voltage relays (with the addition of 2 HLRELAYS sold separately) and up to 2 additional external Smart Relays. Smart Relays are sold separately and are packaged with a single gang electrical box. They can also be used with any existing comparable standard electrical box with a minimum volume of 16.2 in³. If using 115 VAC, make sure that there is a neutral line inside the box before installation. If not, you must run a separate neutral wire to power the Smart Relay. This is not a concern if using 230 VAC. Note that conduit and connections to the included plastic box must be non-metallic.

Find a location within 15 ft of the Wiring Panel with convenient access to the pool equipment that you intend to control with the Smart Relay. Three threaded 1/2" NPT knockouts are provided for high voltage power coming into the relay and for power out to the pool equipment. A Wiring Whip is included with the Smart Relay and will aid in the installation.

The Smart Relay has a manual On/Off button that can be used if communication is lost with the Wiring Panel. Although this button is not functional during normal operation, mount the Smart Relay in an accessible location to use this feature in case of communication loss.

Mount the Smart Relay to a wall or other flat surface using the mounting holes which are designed to accommodate #8 screws.

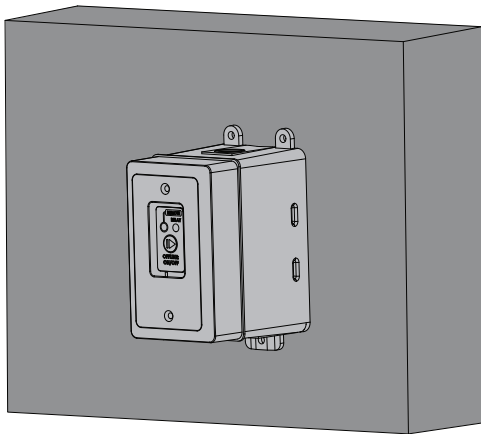



HAYWARD®

Temperature Sensors

Water Sensor

This sensor is used to measure the pool/spa temperature and is installed in the filtration plumbing after the filter but before either the solar or conventionally fueled heaters—refer to the plumbing overview diagram.

1. Drill a 3/8" (10mm) diameter hole in the PVC piping and remove all chips and burrs.
2. Insert sensor until O-ring collar sits flush on the hole.
3. Position hose clamp over the sensor and gently tighten until O-ring makes an adequate seal. Do not overtighten.

Air Sensor

Mount the air sensor outdoors. **IMPORTANT:** The air sensor must not be mounted in direct sunlight.

Solar Sensor (not included)

For solar applications, mount the solar temperature sensor near the solar collector array so that it is exposed to the same sunlight as the collectors. Use additional cable (20 AWG) if necessary.

Chlorination Function (refer to your model)

Some OmniPL models can generate chlorine using a Hayward chlorinator cell and plumbing kit. These items may be included with the OmniPL or can be purchased separately if your model supports chlorination. Choose a chlorinator cell model based on the size of your pool; models are shown below. If not supplied with your model, in addition to the chlorinator cell, a plumbing kit (P-KIT) must be purchased. This kit contains the cell unions and flow switch. Refer to page 13 for plumbing instructions.

TCELLS340 for pools up to 40,000 gallons

TCELLS325 for pools up to 25,000 gallons

Optional HL-CHEM Sensing Kit

The HL-CHEM is an ORP and pH sensing kit for the OmniPL. When chlorination is enabled (requires chlorinator cell, liquid chlorine feeder or tablet feeder), the OmniPL senses the pool's ORP and pH levels and generates/dispenses the correct amount of chlorine to keep your pool properly sanitized. Wiring and plumbing requirements for the HL-CHEM should be considered before installing the OmniPL. Refer to the HL-CHEM manual for specific installation information. **NOTE:** OmniPL is not compatible with AQL-CHEM.

Optional AQL-CHEM2 CO₂ Dispensing Kit

The AQL-CHEM2 is a CO₂ dispensing device that connects directly to the OmniPL. When used with an HL-CHEM, the OmniPL will sense the pool's pH level and automatically dispense the correct amount of CO₂ to control the pool's pH. Wiring and plumbing requirements for the AQL-CHEM2 should be considered before installing the OmniPL. Refer to the AQL-CHEM2 manual for specific installation information.



HAYWARD®

Optional Valve Actuators

For installation, refer to the mounting instructions included with the Hayward GVA-24 actuator or equivalent. After configuring and first operating the valve, note that the internal cams in the actuator may have to be adjusted depending on the way the actuator is mounted on the valve and the desired valve action.

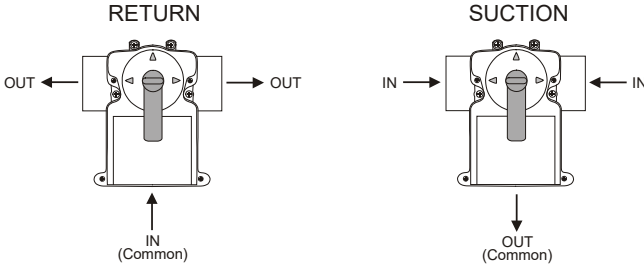

Plumbing

Pool/Spa System Configuration

These systems use a single filter pump and filter. Pool or spa operation is controlled by two 3-way valves (suction and return). Refer to the diagram below.

High Voltage Relays	Valve Outputs
Filter Pump	Pool/Spa Suction
Lights	Pool/Spa Return
Aux 1	Valve 3
Aux 2	Valve 4

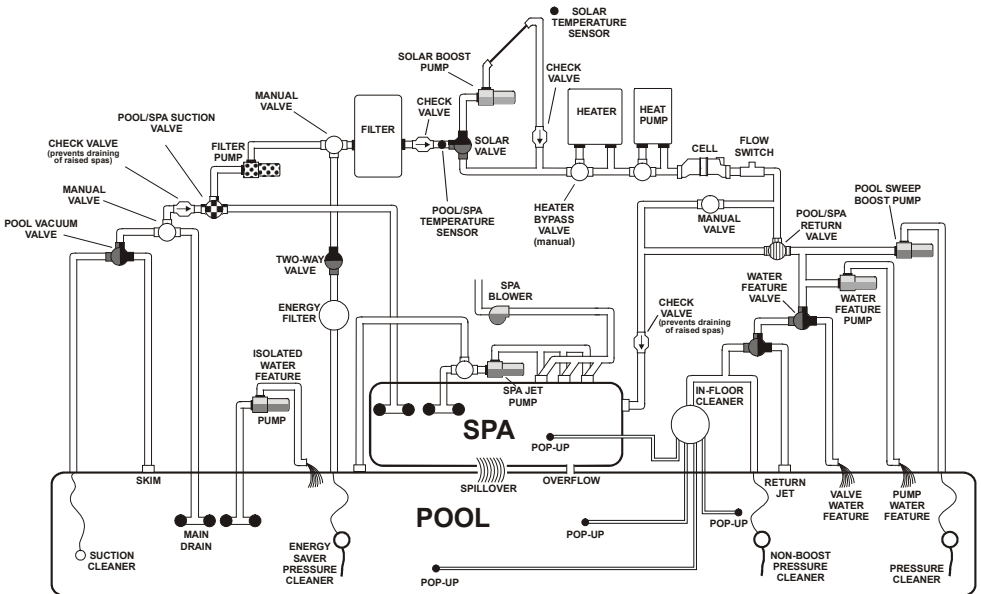
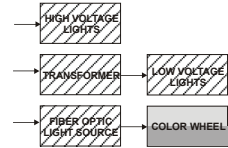



Some important notes regarding standard Pool/Spa systems:

1. The OmniPL can be programmed to accommodate spa spillover, if desired.
2. A conventional heater (gas or heat pump) and solar can be used to heat both the pool and the spa.
3. If the chlorinator cell is plumbed prior to the pool/spa return valve, then both the pool and the spa can be chlorinated.
4. The water sensor should be installed prior to any heater or solar and will display either the pool or the spa temperature, depending on the current operation of the pool. The temperature will only be displayed when the filter pump is running.
5. If any water feature or pressure side cleaner boost pumps are used, be sure to enable the “interlock” feature (see CONFIGURATION for details) to ensure that the pumps operate only when the filter pump is on.
6. The plumbing diagram above is intended to be used as a general guideline and is not a complete plumbing schematic for the pool.
7. The air sensor must be installed if the freeze protection feature is enabled for the filter, valves, chlorinator, other pool functions.

“Dual Equipment - Separate Heaters” for Pool/Spa Configuration

These systems have 2 complete sets of equipment (filter pump, filter, heater)—1 set for the pool and the other set for the spa. Refer to the diagram below:

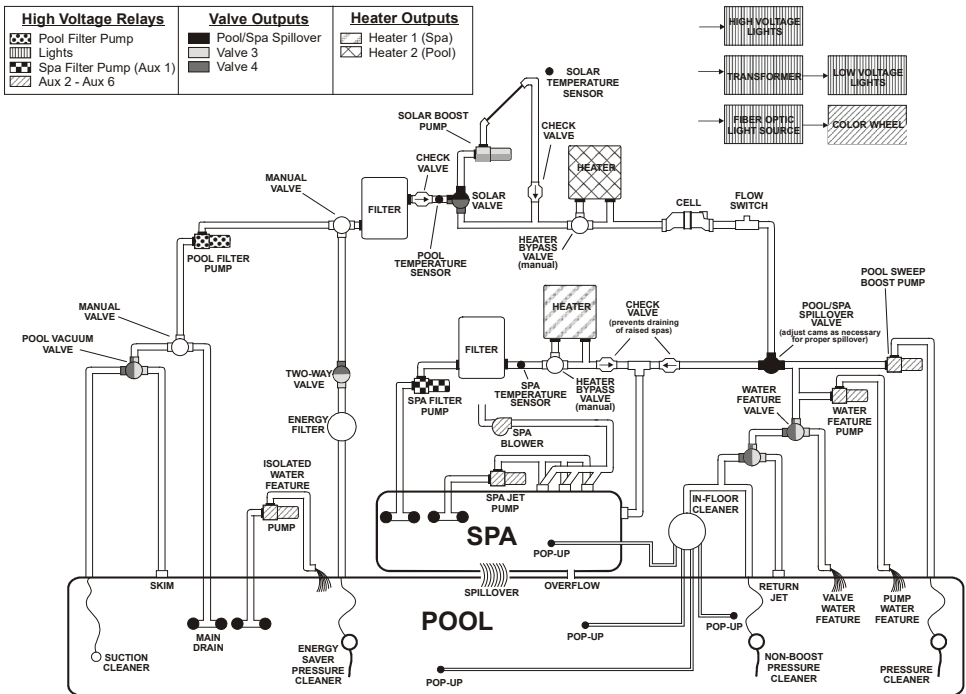



Some important notes regarding the control of Dual Equipment Pool/Spa with separate heaters:

1. When the system is configured for Dual Equipment:
 - a. The pool filter can be a one, two or variable speed pump.
 - b. The spa filter can be a one, two or variable speed pump.
2. The water sensor should be installed on the pool loop prior to the heater and will display the pool temperature whenever the "Pool Filter" pump is running.
3. The dual equipment spa sensor should be installed on the spa loop prior to the heater and will display the spa temperature whenever the "Spa Filter" pump is running.
4. The OmniPL can be programmed to accommodate spillover if desired. Note that spillover operation will be automatically suspended whenever the spa filter pump is turned on.
5. The chlorinator cell must be installed in the pool plumbing. If spillover is enabled, then the OmniPL can chlorinate both the pool and spa (during spillover operation). If not using spillover, the OmniPL can control an AquaRite (purchased separately) for chlorination of both bodies of water.
6. If any water feature or pressure side cleaner boost pumps are used, be sure to enable the "interlock" feature (see CONFIGURATION for details) to ensure that the pumps operate only when the "Pool Filter" pump is on.
7. The plumbing diagram above is intended to be used as a general guideline and is not a complete plumbing schematic for the pool.

"Dual Equipment - Shared Heaters" for Pool/Spa Configuration

These systems have 2 complete sets of equipment (filter pump, filter) and shared heaters. Refer to the diagram below:

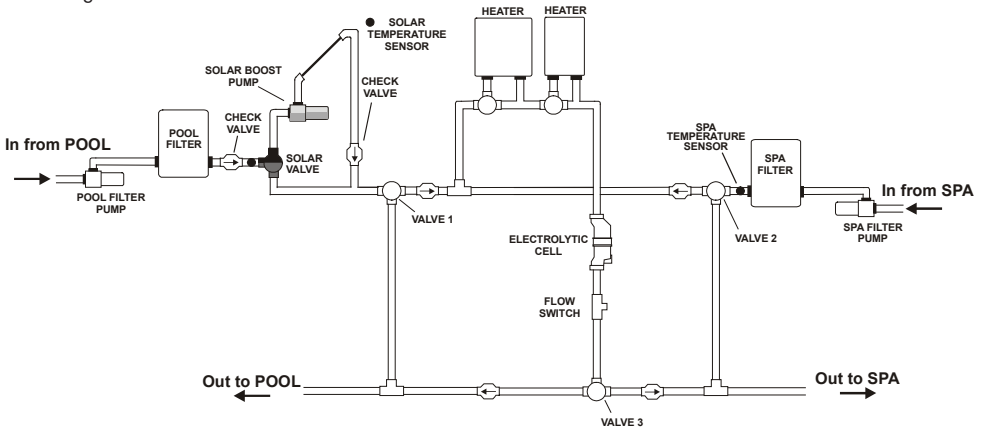

Notes regarding the control of Dual Equipment Pool/Spa systems with shared heaters:

In the Pool/Spa Config., select:

1. When the system is configured for Dual Equipment:
 - a. The pool filter can be a one, two or variable speed pump.
 - b. The spa filter can be a one, two or variable speed pump.
 - c. The heater(s) will be dedicated to the spa whenever the spa filter is on and the spa temperature setting is not off.



HAYWARD®

2. The water sensor should be installed on the pool loop prior to the heater(s) and will display the pool temperature whenever the "Pool Filter" pump is running.
3. The dual equipment spa sensor should be installed on the spa loop prior to the heater(s) and will display the spa temperature whenever the "Spa Filter" pump is running.
4. The OmniPL can be programmed to accommodate spillover if desired. Note that spillover operation will be automatically suspended whenever the spa filter pump is turned on.
5. The chlorinator cell and flow switch must be installed in the heater return path. If spillover is enabled, then the OmniPL can chlorinate both the pool and spa (during spillover operation). If not using spillover, the OmniPL can control an AquaRite (purchased separately) for chlorination of both bodies of water.
6. If any water feature or pressure side cleaner boost pumps are used, be sure to enable the "interlock" feature (see CONFIGURATION for details) to ensure that the pumps operate only when the "Pool Filter" pump is on.
7. The plumbing diagram above is intended to be used as a general guideline and is not a complete plumbing schematic for the pool.

TurboCell (for models supporting chlorination)

The TurboCell must be plumbed AFTER the filter and heater. If installed on a pool/spa combination system, the cell must be plumbed BEFORE the pool/spa return valve in order to allow proper chlorination of both the pool and the spa. Refer to the plumbing diagram below:

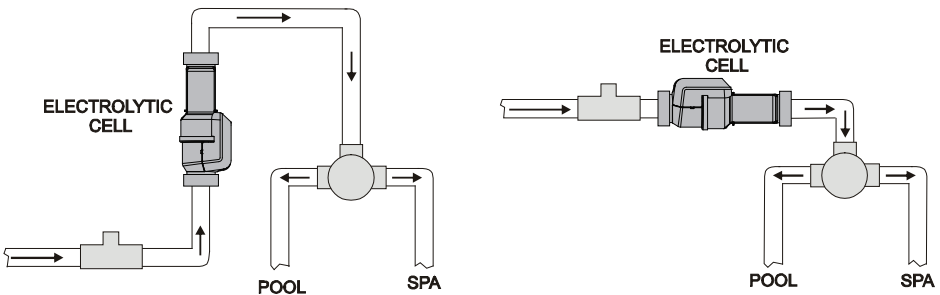

The cell may be mounted vertically or horizontally, and water can move in either direction through the cell. Install using the 2" unions provided. Tighten unions BY HAND for a watertight seal. For systems with 1½" plumbing use adapters (provided by installer).

Flow Switch

A Hayward GLX-FLO flow switch is required if chlorination or an HL-CHEM ORP & pH Sensing Kit will be used. If no chemistry equipment is installed, the GLX-FLO is optional and can be used to detect leaks or clogs in your pool's plumbing system. If using the GLX-FLO, it must be plumbed in line with any chemistry sensing/dispensing equipment at the very end of the return plumbing. This will ensure that the OmniPL will detect a leak if it occurs anywhere at the pool pad. Understand that if a leak occurs after the flow switch (downstream), the OmniPL will not sense a "no-flow" condition.

IMPORTANT: There must be at least a 12" (30cm) straight pipe run before (upstream) the flow switch.



HAYWARD®

IMPORTANT: To ensure proper operation, verify that the arrow on the flow switch points in the direction of water flow.

Electrical Wiring

The OmniPL requires both high and low voltage connections. Low voltage connections will be made to variable speed pumps, actuators, sensors, remote keypad, etc. High voltage connections will be made to pumps, lights, etc., as well as providing direct input power to the OmniPL wiring panel. Always:

- Ensure that Power is disconnected prior to performing any wiring
- Follow all local and NEC (CEC if applicable) codes
- Use copper conductors only
- Remove power to the OmniPL subpanel before removing the deadfront

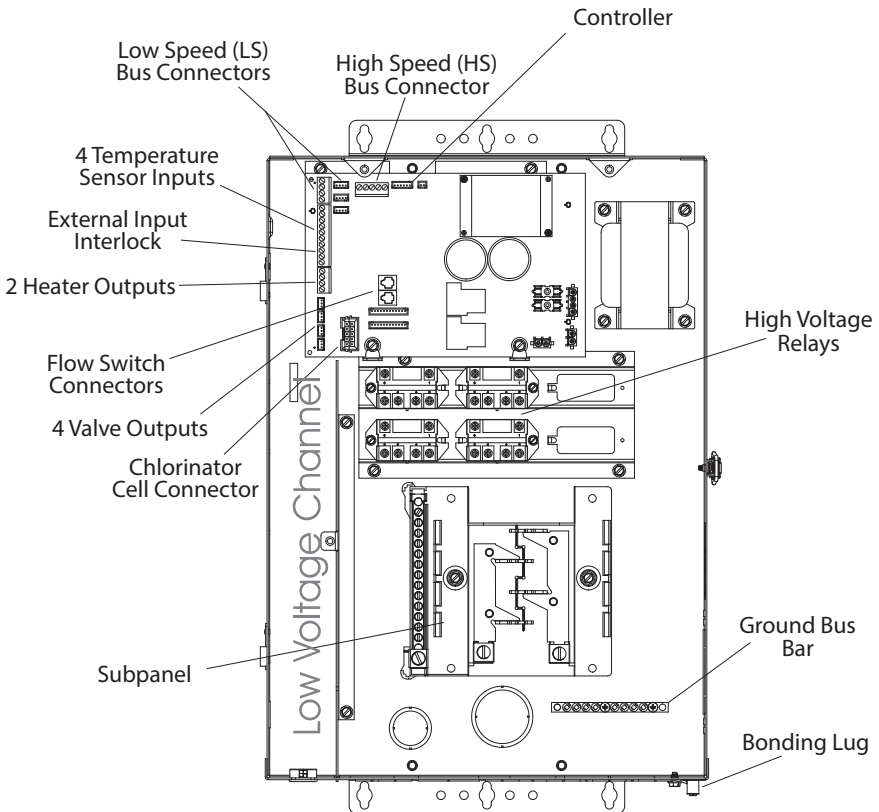



Main Service (Power to the Circuit Breaker Subpanel)

The OmniPL circuit breaker subpanel can accommodate up to 8 circuit breakers and is rated for 100A service. Run properly rated conductors (L1, L2, N, and ground) from the primary house electrical panel to the main power connections on the OmniPL circuit breaker base. The connection at the main house panel should be to a 240 VAC circuit breaker rated at 100A maximum.

Grounding and Bonding

Connect a ground wire from the primary electrical panel to the OmniPL ground bus bar. Also ground each piece of high voltage equipment (120 or 240 VAC) that is connected to the OmniPL control relays or circuit breakers. The OmniPL should also be connected to the pool bonding system by an 8AWG (6AWG for Canada) wire. A lug for bonding is provided on the outside/bottom of the OmniPL enclosure.

Circuit Breaker Installation and Wiring

Circuit breakers are to be supplied by the installer. Refer to the circuit breaker chart below for a list of suitable circuit breakers that can be used. Follow the code and the circuit breaker manufacturer's rating requirements regarding the size and temperature rating for wiring. Note that some pool equipment may be required to be connected to ground fault circuit breakers—check local and NEC (CEC) codes.

SUITABLE LISTED BREAKERS							Tightening Torque
Manufacturer	Single	Double	Twin	Quad	GFCB	Filler Plates	
Cutler-Hammer	BR	BR	BRD	BRD		BRFP	25lb-in
Murray	MP-T	MP-T	MH-T	MH-T	MP-GT	LX100FP	25lb-in
Siemens	QP	QP	QT	QT	QPF	QF3	25lb-in
Square D	HOM	HOM	HOMT	HOMT	HOM-GFI	HOMFP	25lb-in

OmniPL Power

The OmniPL requires 120 VAC, 5A power to operate the control logic circuits and the chlorinator. This power should be connected to a dedicated circuit breaker.

WARNING: 120 VAC only (permanent damage will occur if connected to 240V)

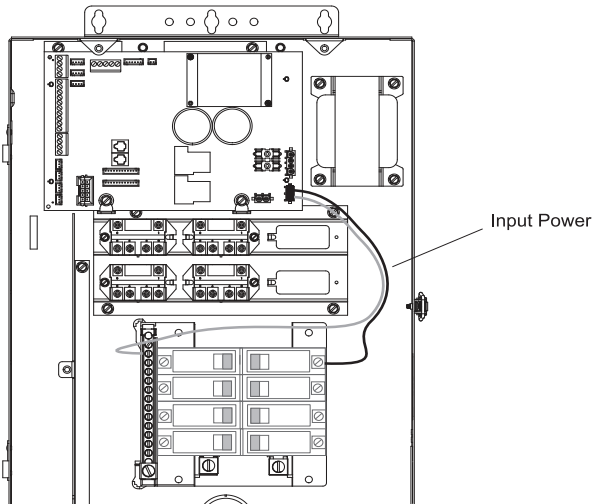



Connection Table

The OmniPL includes 4 high voltage relays (HVR1-HVR4), 2 low voltage/heater relays (LVR1-LVR2), 4 valve outputs (VLV1-VLV4) and 4 temperature sensors/1 external input sensor (SENS1-SENS5). Two additional HLRELAYS (HVR9 and HVR10) as well as two additional Smart Relays (HVR1) can be added. When wiring pool equipment to the OmniPL, keep a record of all connections. You'll need to record which input/output is used and what equipment is attached. To aid in this process, use the table below. To identify the various inputs/outputs, refer to the diagram on the side of the table. After attaching equipment to the OmniPL, fill in the appropriate information in the table.

Connection Table

Connection	Pool Equipment	Description
High Voltage Relays		
HVR1		
HVR2		
HVR3		
HVR4		
HVR1 Smart Relay		
HVR1 Smart Relay		
HVR9		
HVR10		

Low Voltage Relays/Heaters		
LVR1		
LVR2		

Valve Actuators		
VLV1		
VLV2		
VLV3		
VLV4		

Temperature Sensors		
SENS1 POOL		
SENS2 AIR		
SENS3 SOLAR		
SENSE4 EXT INP		
SENS5 DE SPA		



Optional Smart Relays



Optional Internal High Voltage Relays

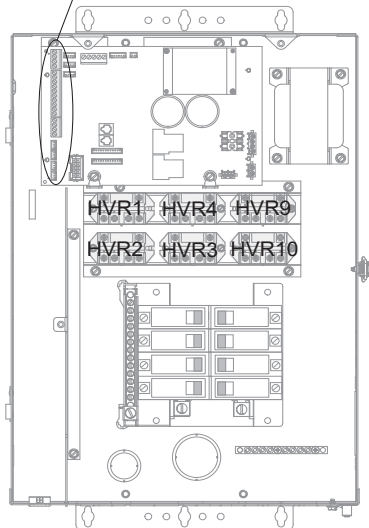
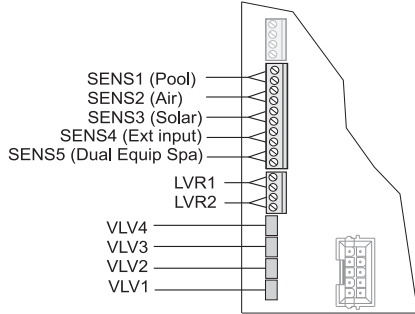



High Voltage Wiring

High Voltage Relays - (120/240V) Pool Equipment

All OmniPL relays are double pole (they make/break both "legs" of 240V circuits) and are rated at 3HP/20A at 240V (1½HP/20A at 120V) using wire with a minimum insulation rating of 90° C. Refer to the diagram below for typical relay wiring. Record all connections using the table on page 16.

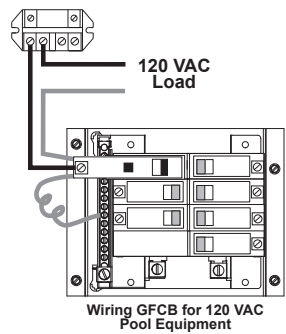
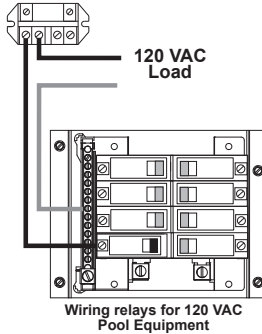
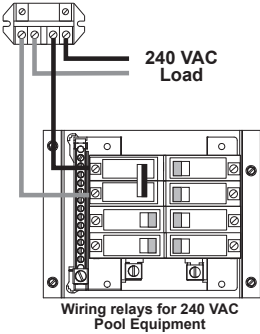

WARNING: Do not use the OmniPL to control an automatic pool cover. Swimmers may become entrapped underneath the cover.

WARNING: Do not use the OmniPL to control fire pits or fire features.

Two speed filter pump

Requires two relays for proper operation of both speeds.

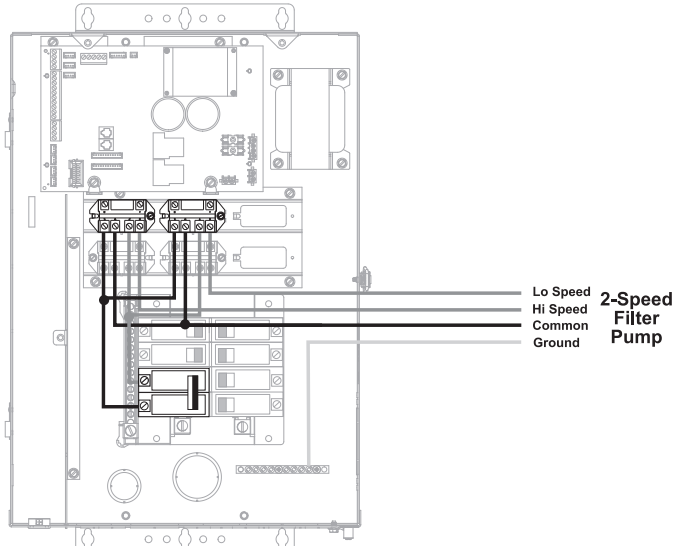



HAYWARD®

Lights

A ground fault circuit breaker (GFCB) must be used to supply power for high voltage pool/spa lighting. Low voltage lights will require an external transformer. For lighting systems that have both a light source and color wheel, connect the light source to one relay and then connect the color wheel to a different relay.

Universal ColorLogic Lights (UCL): The OmniPL can be configured to synchronize multiple UCLs, even if their low voltage transformers are not wired to the same relay. If UCL(s) will be running in Omni Direct mode (lights built after June 2018), the transformer(s) can be wired to either an internal relay or a Smart Relay. Refer to your Universal ColorLogic manual for more information about Omni Direct mode.

Hayward Variable Speed Pump

Proper installation of a Hayward Variable Speed Pump (VSP) includes high voltage input wiring, low voltage communication wiring, and menu configuration/settings. The OmniPL can control up to 16 EcoStar VSPs without the use of a relay. Refer to the diagram below for proper 230 VAC input wiring to the VSP. Refer to "Low Voltage Wiring" section in this manual for information on communication wiring. Refer to the VSP manual(s) for detailed wiring information.

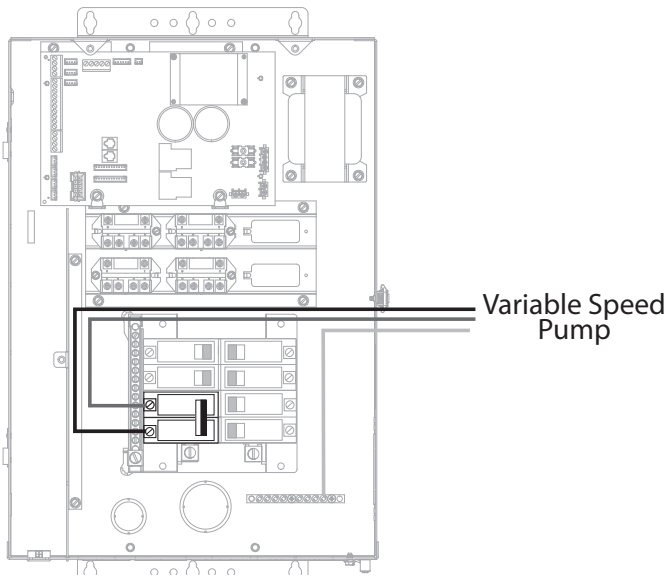



Smart Relay Load Wiring

Like the OmniPL's internal relays, a Smart Relay can be used to control either 115 or 230 VAC pool equipment. Refer to the wiring information below.

Smart Relays are sold separately and include an electrical box and Wiring Whip. If not using the included box, install the Smart Relay (HLH485RELAY) into an electrical box with a minimum volume of 16.2 in³. Use the included Wiring Whip if the electrical box will be mounted within 6 ft of the power source. Red, black and green conductors are included for 230 VAC wiring. A white conductor is supplied if using 115 VAC input power. Use the included wire nuts for wiring connections. Use proper threaded strain relief fittings when attaching conduit to knockouts. After wiring is complete, carefully insert the cover with connections into the box and secure.

115 VAC	Smart Relay Wire Colors	230 VAC
Line in	Black	Line 1 in
Load out	Black/White	Load 1 out
Neutral	Gray	Connect Gray & Red to Line 2 in
No Connection	Red	
No Connection	Red/White	Load 2 out

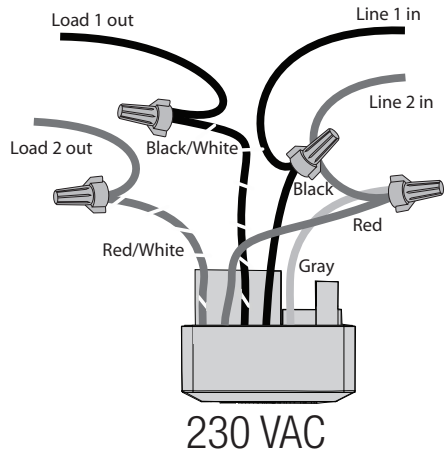
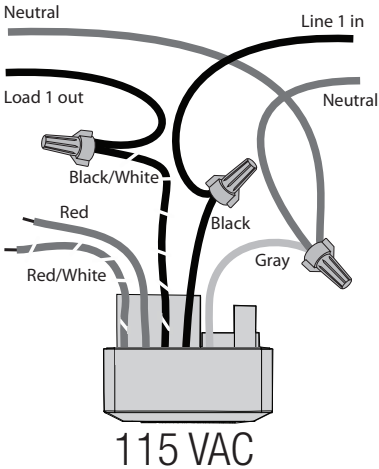



Low Voltage Wiring

Temperature Sensors

The OmniPL utilizes 10K ohm thermistor type sensors and provides four inputs. If the OmniPL is being used to control a solar heating system, the solar sensor is required. If dual equipment will be used, the dual equipment spa sensor is required. If both solar and dual equipment are desired, another temperature sensor must be purchased separately. The sensors are provided with a 15 ft. cable. If a longer cable is required, contact the Hayward service dept. (908-355-7995) for information on suitable cable types and splices. Refer to the diagram for sensor wire connections. Record all connections using the table on page 16.

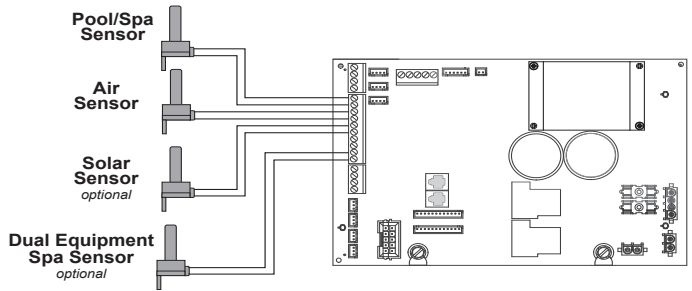

Controller

The Controller has a 15 ft cable with a connector that plugs into the designated connector as shown on page 14. There are rubber plugs covering USB port and Ethernet port on the bottom of the Controller enclosure. For models supporting web access, the Ethernet port is available if a wired connection to the access point is desired over the built-in wifi. The USB port is used for firmware upgrades.

Low Speed Bus Jumper

The large low speed (LS) bus connector shown on page 14 is used for communication to various equipment like variable speed pumps, Smart Relays, and more. The connector can accommodate multiple connections but if more capacity is needed, a jumper can be made using Wago lever nuts or standard electrical wire nuts as shown. Use a jumper if you have difficulty making multiple connections at the Low Speed Bus connector.

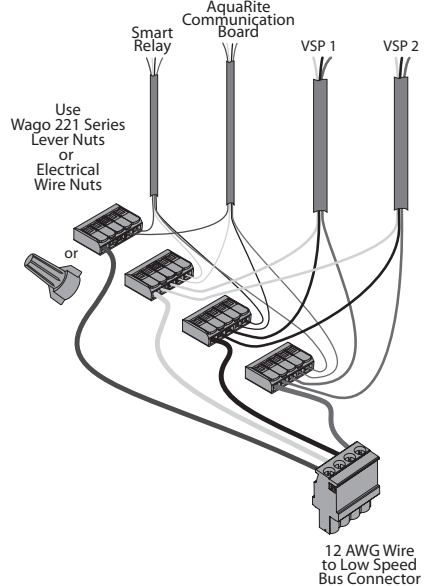



Hayward Variable Speed Pump (VSP) Wiring

If using a Hayward TriStar 950, TriStar 900, Super Pump 700 or MaxFlo 500, the pump can be fully controlled (schedules and speeds) by the OmniPL. Refer to the VSP Communication Wiring table as well as the diagrams below for low voltage communication wiring instructions. Up to three VSPs can be controlled by the OmniPL.

Pump Model	Hub Conn.	Pump Conn.
TriStar® VS 950 Omni (before Jan 2019)	2	7
	3	8
	4	1
TriStar® VS 950 Omni (after Jan 2019)	2	A
TriStar® VS 900 Omni	3	B
Super Pump® VS 700 Omni	4	COM
MaxFlo VS 500 Omni		

*Disconnect onboard display and set all dip-switches to OFF position.

TriStar VS 900, Super Pump VS 700, MaxFlo VS 500

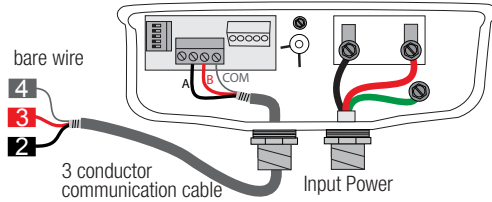

Low Speed Bus

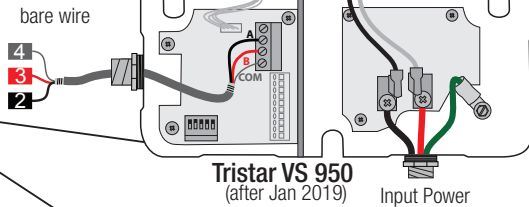
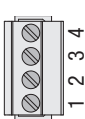

For pump models with dip switches, set all switches to OFF position (as shown). Remove the display cable. Use the spare connector taped to the display cable for the communication cable connection.

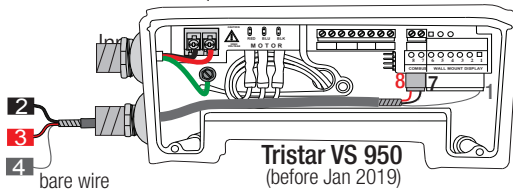

General Heater Control

The OmniPL provides two sets of low voltage dry contacts that can be connected to most gas heaters or heat pumps with 24V control circuits. Refer to the diagram below for a generic heater connection. The manuals supplied with most heaters also include specific wiring instructions for connecting the heater to an external control (usually identified as “2-wire” remote control). For millivolt or line voltage heaters, contact Hayward Tech support, 908-355-7995. Refer to the diagram on page 14 for the location of heater connections on the OmniPL Main Board. Record all connections in the Connection Table.

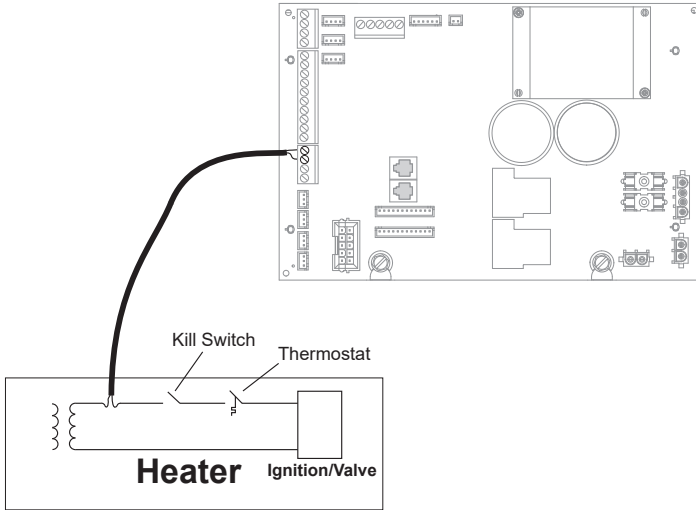

Smart Heater Control

Smart Heaters are programmed with a Hayward Unique Address (HUA) which allows it to be fully controlled by a Hayward Omni pool automation control. Similar to other Smart Devices such as select Hayward variable speed pumps, you will be able to remotely create schedules and setpoints for both heating and cooling while displaying real time heater status and diagnostics for the Smart Heater. The Omni family of products provide a 3 wire cable connection used to communicate with the Smart Heater and requires firmware revision R4.3.0 or later.

See the following page for wiring diagram and instructions.

Disconnect power to both the Smart Heater and the Omni control before removing their panels. Use a proper outdoor rated 3 conductor 22 AWG cable (20 AWG for runs over 30 ft) for the connection from the Omni control to the Smart Heater. Route the cable through appropriate knockouts making sure they are not shared with high voltage wiring. Refer to the diagram below showing a Hayward OmniPL control wired to the Smart Heater. Note that the position of each colored conductor is the same at both ends of the communication cable. Refer to your Smart Heater manual for specific wiring instructions. After the communication cable is fastened and secure, refasten the panels.

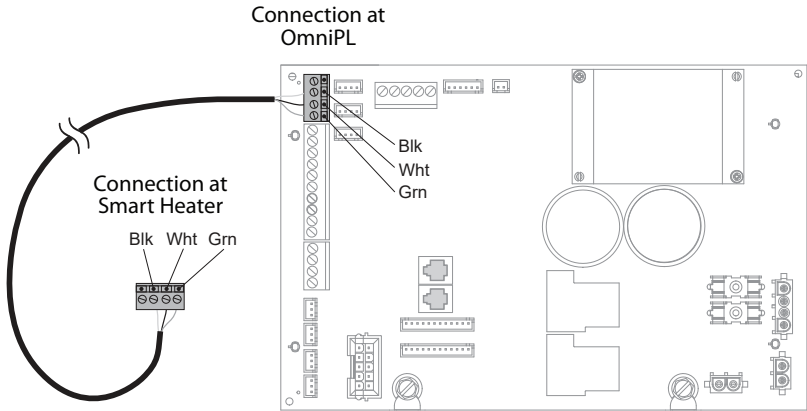

External Input Interlock

The External Input Interlock provides a means to turn the filter pump or other component on/off when certain conditions exist. A normally open or normally closed on/off external device must be connected to the OmniPL as shown below. After properly configuring the OmniPL (see Configuration Wizard), the filter pump and/or desired pool component(s) will be forced on or off when the device is active. Record all connections using the table on page 16.

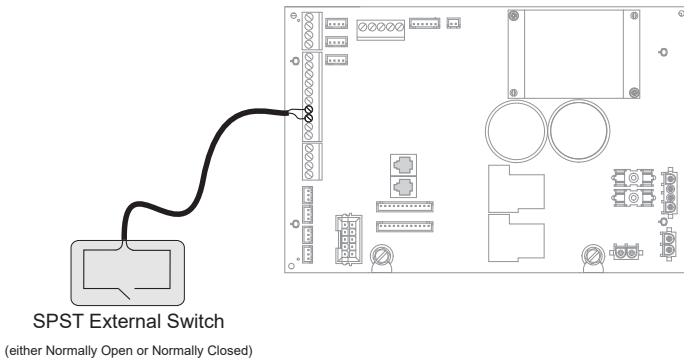



HL-CHEM ORP and pH Sensing Kit (Optional)

Plug in the connector from the HL-CHEM into one of the Low Speed Bus connectors on the main PCB in the OmniPL Control Center as shown below. Refer to the HL-CHEM manual for complete installation instructions.

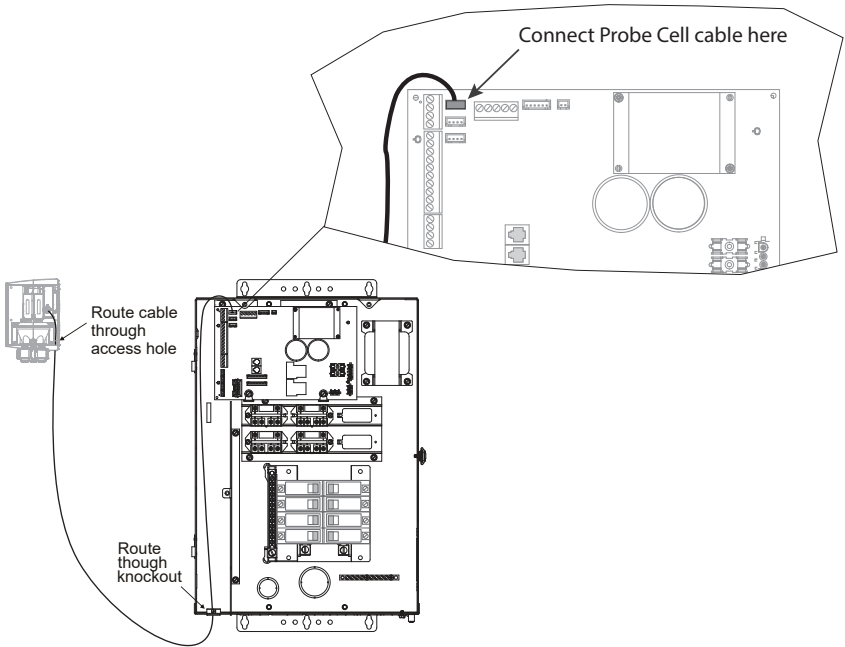

Home Router

If web enabled devices such as PCs, laptops, tablets or phones will be used to access the OmniPL, an Ethernet or wireless connection must be made to the home router. For models that don't support web access, a connection to your home network is needed for firmware updates and if using an HL-WIRELESS remote terminal. For wireless connections, a 2.4GHz connection to the router is required. For Ethernet connections, use outdoor rated Cat5e or Cat6 Ethernet cable. Connect one end to the Controller and the other to an available LAN port (not WAN) on the home router or access point.

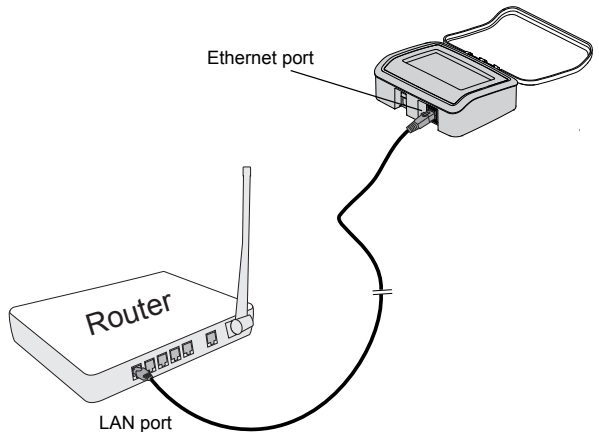



HAYWARD®

Smart Relays

Like VSPs, Smart Relays rely on communication from the Wiring Panel. Their 4 conductor cable is wired to the same connector as a VSP. Wire the cable as shown below. Up to two Smart Relays can be controlled by the OmniPL.

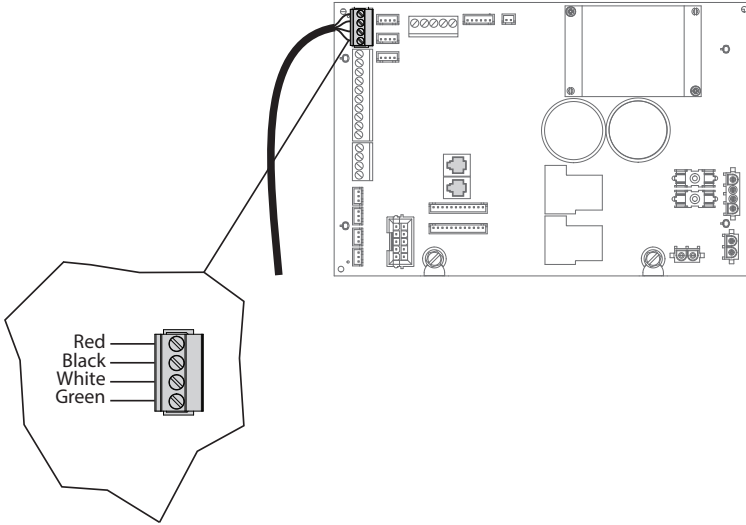

Valve Actuators

The OmniPL can control up to four automatic valve actuators. Two of the valve outputs are normally used for the pool/spa suction (Valve2) and return (Valve1) valves. Valve3 and Valve4 are for general purpose use (solar, water feature, in-floor cleaner, etc.).

For installations with solar heating, Hayward offers the AQ-SOL-KIT-xx solar kit that contains a valve, actuator, and extra temperature sensor. The "xx" indicates the valve type from the 2 choices below:

- 1P 1.5" Positive Seal
- 2P 2" Positive Seal

The OmniPL is compatible with standard valve actuators manufactured by Hayward, Pentair/Com-pool, and Jandy. Actuators will connect to the VLV outputs on the Main Board. Refer to the diagram on page 14 for the location of valve connectors (VLV) on the OmniPL Main Board. Record all connections in the Connection Table on page 16.



HAYWARD®

Flow Switch

The 15 ft flow switch cable plugs into the flow switch connector shown on page 14. Ensure that the connector catch “snaps” into place in order to provide a reliable connection.

TurboCell

Only applicable if the chlorinator function is enabled on models that support it. The TurboCell should be plugged in AFTER the OmniPL cover panel is installed. Refer to page 14 for the location of the chlorinator cell connector.

HLRELAY

The HLRELAY is a single high voltage relay designed to be mounted in the #9 and/or #10 positions near the four on-board relays (see page 14). After installing the HLRELAY, a wire connection must be made at the OmniPL Main Board. At startup, the OmniPL will detect the HLRELAY and allow the user to configure the additional relay(s) in the Configuration Wizard. Refer to the HLRELAY manual for installation and wiring instructions.

Preparing Pool/Spa Water

Salt Chlorination

When used with an optional Hayward TurboCell and P-KIT, the OmniPL can generate all the chlorine needs for pools up to 40,000 gallons (150,000 liters), or the needs of most commercial pools up to 25,000 gallons (95,000 liters). If enabled (see Configuration Wizard), this operation requires a low concentration of salt (sodium chloride) in the pool/spa water. The OmniPL automatically converts salt into free chlorine which kills bacteria and algae in the pool/spa. Chlorine will revert back to sodium chloride after killing bacteria. These reactions will continuously recycle, virtually eliminating the need to add sanitizing chemicals to your pool/spa. The only time you may need to add more salt to the pool/spa is when water is replenished due to backwashing, draining, or splashing (not evaporation). The actual amount of chlorination required to properly sanitize a pool varies due to bather load, rainfall, temperature, and the pool's cleanliness.

General Water Chemistry

Salt is required only if you are using the chlorinator features on the OmniPL Control Center. If you are NOT using the chlorinator, it is recommended that you follow all of the other chemistry recommendations besides salt.

Water Chemistry

This table summarizes the levels that are recommended by the Association of Pool and Spa Professionals (APSP). The only special requirements for the OmniPL are the salt level and stabilizer.

CHEMICAL	IDEAL LEVELS
Salt	2700 to 3400 ppm
Free Chlorine	1.0 to 3.0 ppm
pH	7.2 to 7.8
Cyanuric Acid (Stabilizer)	30 to 50 ppm
Total Alkalinity	80 to 120 ppm
Calcium Hardness	200 to 400 ppm
Metals	0 ppm
Saturation Index	-.2 to .2 (0 best)



Saturation index

The saturation index (Si) relates to the calcium and alkalinity in the water and is an indicator of the pool water “balance”. Your water is properly balanced if the Si is 0 ± 0.2 . If the Si is below -0.2 , the water is corrosive and plaster pool walls will be dissolved into the water. If the Si is above $+0.2$, scaling and staining will occur. Use the chart below to determine the saturation index.

$$Si = pH + Ti + Ci + Ai - TDS$$

°C	°F	Ti	Hardness Calcium	Ci	Total alkalinity	Ai	Total Dissolved Solids	TDS
12	53	0.3	75	1.5	75	1.9	0-1000	12.10
16	60	0.4	100	1.6	100	2.0	1001-2000	12.29
19	66	0.5	125	1.7	125	2.1		
24	76	0.6	150	1.8	150	2.2	2001-3000	12.35
29	84	0.7	200	1.9	200	2.3		
34	94	0.8	250	2.0	250	2.4	3001-4000	12.41
39	102	0.9	300	2.1	300	2.5		
			400	2.2	400	2.6	4001-5000	12.44
			600	2.4	600	2.8		
			800	2.5	800	2.9		

Use: Measure the pH of the pool water, the temperature, water hardness, total alkalinity, and total dissolved solids. Use the table above to determine Ti, Ci, Ai, and TDS in the formula shown above. If the Si is equal to 0.2 or more, stains may appear. If the Si is equal to -0.2 or less, corrosion or deterioration may occur.

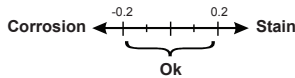

The pool's chemistry must be balanced BEFORE activating the OmniPL's optional chlorinator function. NOTE: If the pool does not have new water, add metal remover and non-copper based algicide to the pool, per manufacturer's instructions. This ensures a quick, troublefree transfer to the OmniPL system.

Salt (When using chlorinator function)

Use the chart on the bottom of the page to determine how much salt in pounds or (Kgs) should be added to reach the recommended levels. Use the Pool Sizing Formula below (measurements are in feet/gallons and meters/liters) if pool size is unknown.

	Gallons (pool size in feet)	Liters (pool size in meters)
Rectangular	Length x Width x Average Depth x 7.5	Length x Width x Average Depth x 1000
Round	Diameter x Diameter x Average Depth x 5.9	Diameter x Diameter x Average Depth x 785
Oval	Length x Width x Average Depth x 6.7	Length x Width x Average Depth x 893



HAYWARD®

The operating salt level is between 2700-3400 PPM (parts per million) with 3200 PPM being optimal. Before adding any salt, test the salt level. This is especially important for retrofit installation to older pools where all of the chlorine added to the pool over time is ending up as salt. If the level is low, determine the number of gallons in the pool and add salt according to the chart below. A low salt level will reduce the efficiency of the sanitization and result in low chlorine production. A high salt level can cause the OmniPL to stop chlorinating. The salt in your pool/spa is constantly recycled and the loss of salt throughout the swimming season should be minimal. This loss is due primarily to the addition of water because of splashing, backwashing, or draining (because of rain). Salt is not lost due to evaporation.

POUNDS and (Kg) OF SALT NEEDED FOR 3200 PPM

Current salt level ppm	Gallons and (Liters) of Pool/Spa water																
	8,000 (30,000)	10,000 (37,500)	12,000 (45,000)	14,000 (52,500)	16,000 (60,000)	18,000 (67,500)	20,000 (75,000)	22,000 (82,500)	24,000 (90,000)	26,000 (97,500)	28,000 (105,000)	30,000 (112,500)	32,000 (120,000)	34,000 (127,500)	36,000 (135,000)	38,000 (142,500)	40,000 (150,000)
0	213 (97)	267 (121)	320 (145)	373 (170)	427 (194)	480 (218)	533 (242)	587 (267)	640 (291)	693 (315)	747 (339)	800 (364)	854 (388)	907 (412)	960 (436)	1013 (460)	1067 (484)
200	200 (91)	250 (114)	300 (136)	350 (159)	400 (182)	450 (205)	500 (227)	550 (250)	600 (273)	650 (295)	700 (318)	750 (341)	800 (363)	850 (385)	900 (408)	950 (430)	1000 (453)
400	187 (85)	233 (106)	280 (127)	327 (148)	373 (170)	420 (191)	467 (212)	513 (233)	560 (255)	607 (276)	653 (297)	700 (318)	747 (339)	793 (360)	840 (382)	887 (403)	933 (424)
600	173 (79)	217 (98)	260 (118)	303 (138)	347 (158)	390 (177)	433 (197)	477 (217)	520 (236)	563 (256)	607 (276)	650 (297)	693 (317)	737 (337)	780 (358)	823 (378)	867 (398)
800	160 (73)	200 (91)	240 (109)	280 (127)	320 (145)	360 (164)	400 (182)	440 (200)	480 (218)	520 (236)	560 (255)	600 (273)	640 (310)	680 (310)	720 (328)	760 (346)	800 (364)
1000	147 (67)	183 (83)	220 (100)	257 (117)	293 (133)	330 (150)	367 (167)	403 (183)	440 (200)	477 (217)	513 (233)	550 (250)	587 (267)	623 (283)	660 (300)	697 (317)	733 (333)
1200	133 (61)	167 (76)	200 (91)	233 (106)	267 (121)	300 (136)	337 (152)	373 (167)	400 (182)	433 (197)	467 (212)	500 (227)	533 (243)	567 (258)	600 (274)	633 (289)	667 (304)
1400	120 (55)	150 (68)	180 (82)	210 (95)	240 (109)	270 (123)	300 (136)	330 (150)	360 (164)	390 (177)	420 (191)	450 (205)	480 (218)	510 (232)	540 (246)	570 (259)	600 (263)
1600	107 (48)	133 (61)	160 (73)	187 (85)	213 (97)	240 (109)	267 (121)	293 (133)	320 (145)	347 (158)	373 (170)	400 (182)	427 (195)	453 (207)	480 (219)	507 (231)	533 (243)
1800	93 (42)	117 (53)	140 (64)	163 (74)	187 (85)	210 (95)	233 (106)	257 (117)	280 (127)	303 (138)	327 (148)	350 (159)	373 (169)	397 (180)	420 (190)	443 (201)	467 (211)
2000	80 (36)	100 (45)	120 (55)	140 (64)	160 (73)	180 (82)	200 (91)	220 (100)	240 (109)	260 (118)	280 (127)	300 (136)	320 (145)	340 (154)	360 (163)	380 (172)	400 (181)
2200	67 (30)	83 (38)	100 (45)	117 (53)	133 (61)	150 (68)	167 (76)	183 (83)	200 (91)	217 (98)	233 (106)	250 (114)	267 (121)	283 (129)	300 (137)	317 (144)	333 (152)
2400	53 (24)	67 (30)	80 (36)	93 (42)	107 (48)	120 (55)	133 (61)	147 (67)	160 (73)	173 (79)	187 (85)	200 (91)	213 (98)	227 (104)	240 (110)	253 (117)	267 (123)
2600	40 (18)	50 (23)	60 (27)	70 (32)	80 (36)	90 (41)	100 (45)	110 (50)	120 (55)	130 (59)	140 (64)	150 (68)	160 (73)	170 (77)	180 (81)	190 (86)	200 (90)
2800	27 (12)	33 (15)	40 (18)	47 (21)	53 (24)	60 (27)	67 (30)	73 (33)	80 (36)	87 (39)	93 (42)	100 (45)	107 (48)	113 (51)	120 (54)	127 (57)	133 (60)
3000	13 (6)	17 (8)	20 (9)	23 (11)	27 (12)	30 (14)	33 (15)	37 (17)	40 (18)	43 (20)	47 (21)	50 (23)	53 (24)	57 (26)	60 (27)	63 (29)	67 (30)
3200	Ideal	Ideal	Ideal	Ideal	Ideal	Ideal	Ideal	Ideal	Ideal	Ideal	Ideal	Ideal	Ideal	Ideal	Ideal	Ideal	Ideal
3400	OK	OK	OK	OK	OK	OK	OK	OK	OK	OK	OK	OK	OK	OK	OK	OK	OK
3600+	Dilute	Dilute	Dilute	Dilute	Dilute	Dilute	Dilute	Dilute	Dilute	Dilute	Dilute	Dilute	Dilute	Dilute	Dilute	Dilute	Dilute

Type of Salt to Use

It is important to use only sodium chloride (NaCl) salt that is greater than 99.0% pure. This can be found at most pool stores in 40-80 lb. bags labeled "for use in swimming pools". Alternatively, use common food quality or water softener salt that is at least 99.0% pure. It is also acceptable to use water conditioning salt pellets, however, it will take longer for them to dissolve. Do not use rock salt, or salt with more than 1% of yellow prussiate of soda, salt with anti-caking additives, or iodized salt.

How to Add Salt

For new plaster pools, wait 10-14 days before adding salt to allow the plaster to cure. Turn the circulating pump on and add salt directly into the pool. Brush the salt around to speed up the dissolving process—do not allow salt to pile up on the bottom of the pool. Run the filter pump for 24 hours with the suction coming from the main drain (use pool vacuum if there is no main drain) to allow the salt to evenly disperse throughout the pool. The salt display may take 24 hours to respond to the change in salt concentration.



HAYWARD®

Always check stabilizer (cyanuric acid), when checking salt. These levels will most likely decline together. Use the chart below to determine how much stabilizer must be added to raise the level to 40 ppm.

POUNDS and (Kg) OF STABILIZER (CYANURIC ACID) NEEDED FOR 40 PPM

Current Stabilizer level (ppm)	Gallons and (Liters) of Pool Water																
	8,000 (30000)	10,000 (37500)	12,000 (45000)	14,000 (52500)	16,000 (60000)	18,000 (67500)	20,000 (75000)	22,000 (82500)	24,000 (90000)	26,000 (97500)	28,000 (105000)	30,000 (112500)	32,000 (120000)	34,000 (127500)	36,000 (135000)	38,000 (142500)	40,000 (150000)
0 ppm	2.7 (1.2)	3.4 (1.5)	4.0 (1.8)	4.7 (2.2)	5.4 (2.5)	6.0 (2.7)	6.7 (3.0)	7.4 (3.4)	8.0 (3.6)	8.7 (4.0)	9.4 (4.3)	10.0 (4.5)	10.8 (5.0)	11.4 (5.2)	12 (5.4)	12.7 (5.7)	13.4 (6)
10 ppm	2.0 (.9)	2.5 (1.1)	3.0 (1.4)	3.5 (1.6)	4.0 (1.8)	4.5 (2.0)	5.0 (2.3)	5.5 (2.5)	6.0 (2.7)	6.5 (3.0)	7.0 (3.2)	7.5 (3.4)	8 (3.8)	8.5 (3.8)	9 (4.0)	9.5 (4.3)	10 (4.6)
20 ppm	1.3 (.59)	1.7 (.77)	2.0 (.90)	2.3 (1.1)	2.7 (1.3)	3.0 (1.3)	3.3 (1.5)	3.7 (1.6)	4.0 (1.8)	4.3 (2.0)	4.6 (2.1)	4.9 (2.2)	5.4 (2.4)	5.7 (2.5)	6 (2.6)	6.3 (2.8)	6.6 (3.0)
30 ppm	0.7 (.31)	0.8 (.36)	1.0 (.45)	1.2 (.54)	1.4 (.64)	1.5 (.68)	1.7 (.77)	1.8 (.82)	2.0 (.91)	2.2 (.97)	2.4 (1.1)	2.6 (1.2)	2.8 (1.3)	2.9 (1.3)	3.0 (1.4)	3.2 (1.4)	3.4 (1.5)
40 ppm	0.0	0.0	0.0	0.0	0.0	0.0	0.0	0.0	0.0	0.0	0.0	0.0	0.0	0.0	0.0	0.0	0.0

System Startup

Before Startup

Before starting the OmniPL for the first time, be sure that the following items have been completed:

1. Pool/spa chemicals are within the recommended levels according to the chart on page 26.
2. If using chlorinator function, pool/spa salt level is between 2700 – 3400 PPM Standard Salt or 1200-1800 PPM Low Salt (see page 40).
3. Properly rated circuit breakers are installed in the OmniPL subpanel.
4. All wiring is performed according to NEC and local codes.
5. The OmniPL is properly grounded and bonded.

Firmware Upgrade

The OmniPL's firmware is the basic operating system that runs the unit. The OmniPL was shipped with the version of firmware that was available at the time of release. There may be a newer version available and if so, we encourage you to upgrade. Also, if you have experienced problems, Hayward Technical Support may advise you to upgrade your OmniPL firmware. To upgrade the OmniPL firmware, refer to the procedure shown in the OmniPL Operation Manual. Upgrading firmware can be performed before or after Configuration but should be done before the OmniPL begins operation.

Configuration

Initial Configuration

When all input and pool related wiring is complete, replace and secure the deadfront. The OmniPL can now be powered on for the first time. Apply power at the main panel and wait for the OmniPL to completely start. This may take a full minute or two. Because this is the first time that the OmniPL has been powered on, it will bring you directly to the initial configuration screen shown below. Note that the OmniPL uses a resistive touchscreen that is appropriate for a pool environment. It requires a deliberate push when selecting a button. At the initial configuration screen, touch the Configuration button in the center of the screen. On the following screen, touch the Configuration Wizard button as shown below.

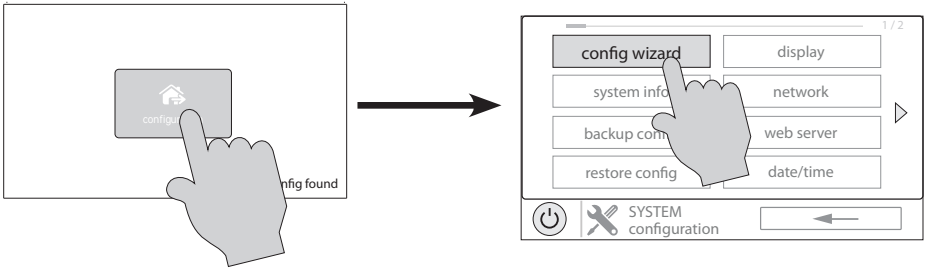







About the Configuration Wizard

The OmniPL uses a Configuration Wizard to assist in the configuration of the OmniPL. The Configuration Wizard will ask you general questions relating to your pool/spa and specific questions about connected pool equipment. Because this process may take some time, do not begin to configure the OmniPL unless you can dedicate at least 15 minutes or more. Configuring the OmniPL requires knowledge of all of the connected pool equipment so have the Connection Table (page 16) handy while configuring the OmniPL.

If you are asked a question and don't know the answer, in many cases you'll be able to skip the question and proceed. In some cases the Configuration Wizard will require an answer. Answer the question to the best of your ability and take note as you'll be able to go back into the Configuration Wizard at a later time to make changes.

Navigation

The Configuration Wizard has been designed to be intuitive allowing most users the ability to navigate with little instruction. Below, a list of commonly used buttons are explained..

-  **Done** - Touch this button to complete your selection.
-  **Cancel** - Touch this button to cancel your selection.
-  **Advance** - Touch this button to advance to the next screen.
-  **Back** - Touch this button to return to the previous screen.
-  **Add** - Touch this button to add an item
-  **Delete** - Touch this button to delete a highlighted item.

After being prompted to make a selection or answer a question, touch the Done button (if available) and then the Advance button to go to the next screen. To go back to a previous screen, touch the Back button. Many selections will require you to touch the Done button before allowing you to advance. If a wrong selection has been made, touch the Delete button or Cancel. Some settings can be made by sliding a bar left or right to decrease or increase a value. You may be required to assign names to equipment. In this case, a keyboard will be displayed and you'll be able to type the desired name. After naming the equipment, save then advance. This method is repeated throughout the Configuration Wizard.

Begin the Configuration Wizard

In the Configuration Wizard, select “New” to create a new Configuration file for the OmniPL. Once underway, keep advancing until you have completed the Wizard. At the end of the Wizard, you’ll have the opportunity to save your settings or exit without saving.

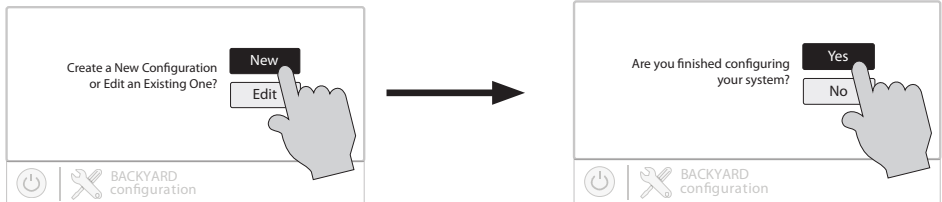

At the end of the Wizard, save your configuration by answering “Yes” to this screen.

If additional pool or backyard equipment is added after initial configuration, or you’d like to make a change to an existing configuration setting, re-enter the Configuration Wizard and select “Edit”. The initial configuration settings will be retained and you’ll have an opportunity to make changes or additions. Be sure to save your configuration when exiting. See page 52 for a Quick Edit Guide.

Configuration Wizard Guide

As you progress through the Configuration Wizard, refer to the following information to help answer questions and make selections.

Would you like to set up a network connection now? Select the type of connection you would like to setup/modify or select “Not Now”. For external antenna connections, you must have a Hayward HLWLAN connected to the OmniPL. “Wired” requires an ethernet connection to the router.

Wireless - From the Network Connections screen that follows, select the desired access point. Note that a 2.4GHz connection to the router is required. You will then be prompted to input the password for that access point. Once you input the password and press the check mark to continue, a Network Diagnostic screen will appear and the OmniPL will run through a series of checks to verify connection to the access point. When the system is done running through the diagnostics, press the check mark to continue to the next section of the Configuration Wizard.

Wired - For a wired connection, run an Ethernet cable from the Controller to the router (page 24). After selecting “Wired”, the system will display the ip address and other network properties. Press the check mark and the OmniPL will verify the network connection. You can now exit back to the main menu and continue with the Configuration Wizard.

External Antenna - Make this selection when setting up a Hayward HLWLAN. Note that a 2.4GHz connection to the router is required. Once the system is done running through the diagnostics, press the check mark to continue to the next section of the Configuration Wizard.

Not Now - Skip network setup and continue with Configuration Wizard.



HAYWARD®

Enable Screen Color Changes For System Alerts? - To alert the user of warning conditions (no flow, failed sensor, etc.), the OmniPL can change its screen color. The screen can display yellow or red depending on the severity of the condition.

Time and Date - “Automatically get time and date from internet” and “Automatically adjust for daylight savings time” are enabled by default. It is recommended that you leave them enabled if your OmniPL system has an internet connection. Disabling “Automatically get time and date from internet” will allow you to set the current date and time using a 12hr clock (AM/PM) or 24hr clock (military time). Save by touching the Done button when finished. NOTE: When registering the OmniPL and creating a web account, you’ll be prompted to enter a Time Zone. Be sure to enter the same time zone as the physical location of the OmniPL, otherwise schedules and timers will be inaccurate.

Select Desired Units of Measure - If Standard is selected, temperatures will be displayed in Fahrenheit. If Metric is selected, temperatures will be displayed in Celsius.

MSP ID - The OmniPL MSP ID number will be displayed. This unique number is used to identify your OmniPL when setting up a web account. A web account is needed to access the OmniPL over the web by mobile devices. **IMPORTANT:** write down the MSP ID number for future use. The MSP ID number will be needed when entering the configuration wizard after initial configuration as well as entering and exiting Simple Mode. Simple Mode is a customizable screen that can be set up for quick access to pool/spa functions and features.

How many Bodies of Water? The OmniPL can support one or two bodies of water, typically a pool and spa. Select the number and advance. You’ll be brought to a screen where you can add, delete or edit a Body of Water. When initially configuring the OmniPL, a “?” will appear in the Body of Water button. You will have to configure this body of water by selecting it and then touching the Advance button. When finished configuring bodies of water, you’ll be returned to this same screen. Touch the Done button and advance to the next section of configuration.

IMPORTANT: The following instructions are for Body of Water 1 configuration. When finished with the first Body of Water, you’ll follow the same instructions for the second Body of Water. When configuring the second Body of Water, you’ll have the option of using “Shared Equipment”. If Shared Equipment is enabled, the second Body of Water will use the filter pump as well as other equipment (heater, chlorinator, etc.) that has been assigned to the first Body of Water. Additionally, you will have the option for using “Shared Heaters”. If you have dual equipment with shared heaters, this can be configured from the second Body of Water’s configuration menu. See page 47 for more information regarding Shared Equipment in the second Body of Water configuration menu.

What is the Body of Water type? Select the type of Body of Water that you would like to configure. The choices are Pool and Spa.

Name of Body of Water - Selecting the box will allow you to edit the name. During initial configuration, the box will be blank. Select the box and then use the keyboard to enter the desired name of the body of water.

Size of Body of Water - Enter the Body of Water size in gallons. If you’re not certain the size of your pool, refer to the chart on page 27 to help determine the pool capacity.



HAYWARD®

How Many Filter Pumps? - This question is for THIS BODY OF WATER ONLY. For example: If you have 2 pumps; one for the pool Body of Water and one for the spa Body of Water, you would answer "1" to this question.

If "1" or more is selected:

Name Filter Pump - Touch the box and use the keyboard to name the filter pump.

What Type - Depending on your answer, the OmniPL will use one relay (single speed pumps), two relays (two speed pumps) or the low speed communication bus (VSP pumps) for pump control. Select the type of pump and advance.

If one speed or two speed pump is selected:

Which Relay is it Wired to? If using a single speed or two speed pump, you'll be asked which relay(s) is wired to the pump. If a value is already shown in the box(es), advance to the next screen. If no value is shown, selecting the box will bring you to a table showing all detected relays. Select the proper relay(s) from the table and touch the Done button to proceed. The relay(s) should now be shown in the box(es) and you can advance to the next screen to continue the pump configuration.

Filter Pump Off for Valve Change? When Yes is selected, the pump will shut off for 35 seconds whenever the valve(s) change position.

Flow Monitoring Enabled? *Requires use of a Hayward flow switch.* This feature will help protect the filter pump from damage due to no flow. When Yes is selected, the OmniPL will monitor the state of water flow when the filter pump is on. If no flow is detected for more than 15 minutes, the OmniPL will shut down the pool pump and will indicate an error. The error will be cleared the next time the pump is turned on.

Would You Like to Enable Priming? Select whether you want the filter pump to prime when turned on. This will turn the pump on at high speed for a set amount of time to establish normal water flow every time the pump is activated after being off for at least 30 seconds. If **Yes** is selected, the following screen will allow you to choose the length of time the pump will prime. This option only appears if the filter pump is configured as a 2-Speed pump.

Freeze Protection Enabled? Freeze protection is used to protect the pool and plumbed equipment against freeze damage during cold temperatures. If freeze protection is enabled AND the air temperature falls below the freeze threshold, the OmniPL will turn on the filter pump to circulate the water. If two Bodies of Water are configured, the valves will also alternate between the pool and spa every 30 minutes and the filter pump will turn off while the valves are turning. The chlorinator will not operate if freeze protection is the only reason the pump is running.

If Yes is selected:

Freeze Protection Temperature? Select the temperature to be used for freeze protection. Temperature is adjustable from 33°F-42°F (1°C-6°C). 38°F (3°C) is default. This threshold will be used for all outputs that have freeze protection enabled.



HAYWARD®

If VSP is selected:

Which Hayward Unique Address? If using a VSP, you'll be asked what is the Hayward Unique Address (HUA). If a value is already shown in the box, advance to the next screen. If no value is shown, selecting the box will bring you to a table showing all detected devices. Select the proper HUA from the table and touch the Done button. If unsure of the HUA, refer to the pump's manual for instructions on how to determine the pump's HUA. Once selected, the address should now be shown in the box and you can advance to the next screen to continue the VSP configuration.

Pump Capacity - Set the minimum and maximum RPM of the pump. Refer to your pump manual for more information.

Permitted User Setting - The OmniPL will automatically calculate these values based on the minimum and maximum RPM that were previously entered. They can be changed as desired.

Speed Presets - Set the Low Pump Speed %, Medium Pump Speed %, and High Pump Speed %, presets. These presets will be used when setting schedules for your pump.

Filter Pump Off for Valve Change? When Yes is selected, the pump will shut off for 35 seconds whenever the valve(s) change position.

Flow Monitoring Enabled? *Requires use of a Hayward flow switch.* This feature will help protect the filter pump from damage due to no flow. When Yes is selected, the OmniPL will monitor the state of water flow when the filter pump is on. If no flow is detected for more than 15 minutes, the OmniPL will shut down the pool pump and will indicate an error. The error will be cleared the next time the pump is turned on.

Would You Like to Enable Priming? Select whether you want the filter pump to prime when turned on. This will turn the pump on at high speed for a set amount of time to establish normal water flow every time the pump is activated after being off for at least 30 seconds. If **Yes** is selected, the following screen will allow you to choose the length of time the pump will prime.

Freeze Protection Enabled? Freeze protection is used to protect the pool and plumbed equipment against freeze damage during cold temperatures. If freeze protection is enabled AND the air temperature falls below the freeze threshold, the OmniPL will turn on the filter pump to circulate the water. If two Bodies of Water are configured, the valves will also alternate between the pool and spa every 30 minutes and the filter pump will turn off while the valves are turning. The chlorinator will not operate if freeze protection is the only reason the pump is running.



HAYWARD®

If Yes is selected:

Freeze Protect Temperature? Select the temperature to be used for freeze protection. Temperature is adjustable from 33°F-42°F (1°C-6°C). 38°F (3°C) is default. This threshold will be used for all outputs that have freeze protection enabled.

Freeze Protect Speed? This is the speed of the pump while freeze protection is active. Select the desired pump speed %.

How many Heaters? This question is for THIS BODY OF WATER ONLY. For example: If you have 2 heaters, one for the pool Body of Water and one for the spa Body of Water, you would answer "1" to this question. Note that you can have a maximum of 5 heaters/chillers per Body of Water.

If "1" or more is selected:

Heater Cooldown Enabled? This feature ensures that the heater cools down before water circulation is stopped. When enabled, the OmniPL will continue to run the filter pump for 5 minutes after the heater turns off.

Heater Extend Enabled? If "Enabled", the filter extend logic keeps the filter pump running beyond the normal turn-off time until the pool (or spa) is heated up to the desired temperature setting. Heater extend will NOT cause the filter pump to turn on, it will only delay the turn off time when the heater is operating.

Settable Water Temperature Range? This is the maximum and minimum allowed settings for heating and/or cooling.

Select and Configure a Heater At this screen, you can add, delete and configure your heater(s). Select the desired heater, then touch the Advance button. When finished configuring heater(s), you'll be returned to this same screen. Touch the Done button and advance to the next section of configuration. Refer to the following information when configuring heater(s):

Do you want to configure a Smart Heater? This option only appears if you have a heater with OmniPL remote control capability connected to your OmniPL and powered on. Select "Yes" if you would like to configure this heater now or "No" if you would like to configure a different heater.

If Yes is selected:

Which Hayward Unique Address? Select the HUA of the Smart Heater that you would like to configure.

Name Heater Select the box, then type the desired name for your heater. This name will be used when referring to this particular heater.

Does Heater Have a Valve? Select whether or not the heater has an associated valve that will turn on when the heater is activated. If **Yes** is selected, the following screen will ask where the valve is wired (refer to Connection Table for this information).



HAYWARD®

Minimum Allowed Air Temperature for Heater? If the air temperature falls below this setting, the heater will be prevented from running, regardless of conditions. This feature is especially useful for heat pumps which become less efficient as the outdoor ambient temperature falls.

Minimum Operation Speed? For variable speed pumps, select the lowest pump speed that is allowed while heating. Set a speed that will ensure that there will be sufficient flow for the heater to operate properly. For two speed pumps, you can select if you want to allow the filter pump to run at low speed during heater operation.

What Type? Heater choices are Solar, Heat Pump, Gas, Geothermal, and Electric. Make your selection and advance.

If Gas or Electric Heater is selected:

Name Heater Select the box, then type the desired name for your heater. This name will be used when referring to this particular heater.

Which Relay is it Wired to? Selecting the box will bring you to a table showing all detected relays. Select the low voltage relay that is wired to the heater (refer to the Connection Table for this information), then advance. The relay should now be shown in the box. Advance to the next screen to continue gas heater configuration.

Does Heater Have a Valve? Select whether or not the heater has an associated valve that will turn on when the heater is activated. If **Yes** is selected, the following screen will ask where the valve is wired (refer to Connection Table for this information).

Heater Priority Duration? This question will appear if more than one heater is configured. Set the amount of time that you will allow the priority heater to heat before allowing the next heater to start. If the priority heater meets the demand within this time frame, the next heater will not be used. Note that a time interval setting of "0" will eliminate priority and always run both heaters at the same time. If a time interval setting of "24" is selected, the next priority heater will not turn on until the first priority heater becomes invalid to run.

Minimum Operation Speed? For variable speed pumps, select the lowest pump speed that is allowed while heating. Set a speed that will ensure that there will be sufficient flow for the heater to operate properly. For two speed pumps, you can select if you want to allow the filter pump to run at low speed during heater operation.

If Heat Pump or Geothermal is selected:

Name Heater Select the box, then type the desired name for your heater. This name will be used when referring to this particular heater.



HAYWARD®

Which Relay is it Wired to? Selecting the box will bring you to a table showing all detected relays. Select the low voltage relay that is wired to the heater (refer to the Connection Table for this information), then advance. The relay should now be shown in the box. Advance to the next screen to continue heat pump configuration.

Does Heater Have a Valve? Select whether or not the heater has an associated valve that will turn on when the heater is activated. If **Yes** is selected, the following screen will ask where the valve is wired (refer to Connection Table for this information).

Does Heater Support Cooling? If your Heat Pump or Geothermal Heater supports cooling and you would like to use it to chill your pool/spa water, select **Yes** to this question. If **Yes** is selected, the following screen will ask where the cooling relay is located (refer to Connection Table for this information).

Heater Priority Duration? This question will appear if more than one heater is configured. Set the amount of time that you will allow the priority heater to heat before allowing the next heater to start. If the priority heater meets the demand within this time frame, the next heater will not be used. Note that a time interval setting of "0" will eliminate priority and always run both heaters at the same time. If a time interval setting of "24" is selected, the next priority heater will not turn on until the first priority heater becomes invalid to run.

Minimum Allowed Air Temperature for Heater? (Heat Pump Only) If the air temperature falls below this setting, the heater will be prevented from running, regardless of conditions. This feature is especially useful for heat pumps which become less efficient as the outdoor ambient temperature falls.

Minimum Operation Speed? For variable speed pumps, select the lowest pump speed that is allowed while heating. Set a speed that will ensure that there will be sufficient flow for the heater to operate properly. For two speed pumps, you can select if you want to allow the filter pump to run at low speed during heater operation.

If Solar is selected:

Name Heater Select the box, then type the desired name for your heater. This name will be used when referring to this particular heater.

Does the Solar Heater Have a Pump? Select whether the solar heating system has a dedicated recirculation pump. If so, the OmniPL will turn this pump on when the pool temperature is below the heater setting and there is solar heat available.

If Yes is selected:

Which Relay is it Wired to? Selecting the box will bring you to a table showing all detected relays. Select the high voltage relay that



HAYWARD®

is wired to the heater (refer to the Connection Table in for this information), then advance. The relay should now be shown in the box. Advance to the next screen to continue solar heater configuration.

Does the Solar Heater Have a Valve? Select whether the solar heating system has a diverter valve to route pool/spa water through the solar collectors. If so, the OmniPL will rotate this valve when the pool temperature is below the heater setting and there is solar heat available.

If Yes is selected:

Where is the valve wired? Selecting the box will bring you to a table showing all detected low voltage relays. Select the relay that is wired to the solar valve, then advance. The relay should now be shown in the box. Advance to the next screen to continue solar heater configuration.

Where is the Solar Temperature Sensor Located? Selecting the box will bring you to a table showing all detected sensors. Select the solar sensor (usually SENS3), then advance. The sensor should now be shown in the box. Advance to the next screen to continue solar heater configuration.

Heater Priority Duration? This question will appear if more than one heater is configured. Set the amount of time that you will allow the priority heater ("1") to heat before allowing the next heater to start. If the priority heater meets the demand within this time frame, the next heater will not be used. Note that a time interval setting of "0" will eliminate priority and always run both heaters at the same time. If a time interval setting of "24" is selected, the next priority heater will not turn on until the first priority heater becomes invalid to run.

Does Solar Require the Filter Pump to Prime When it First Turns On? If *Yes* is selected, the filter pump will turn on in high speed for 3 minutes to circulate water to the solar panels when the heater is activated. This setting is especially useful if you do not have a boost pump to push the pool/spa water to the roof.

Minimum Operation Speed? Select the lowest pump speed that is allowed while solar heating. Set a speed that will ensure that there will be sufficient flow for the solar heating system to operate properly. For two speed pumps, you can select if you want to allow the filter pump to run at low speed during heater operation.

Would You Like To Prioritize The Use Of Solar Heating Over Any Other Types? Select *Yes* if you would like your solar heater to always be the number 1 heater priority if multiple heaters are configured.

How Many Chillers? This question is for THIS BODY OF WATER ONLY. For example: If you have 2 chillers, one for the pool and one for the spa, you would answer "1" to this question. Note that you can have a maximum of 5 heaters/chillers per Body of Water.



HAYWARD®

If “1” or more is selected:

Name Chiller Select the box, then type the desired name for your chiller. This name will be used when referring to this particular chiller.

Is Chiller Wired to a Relay? Select whether or not the Chiller is wired to a relay. If **Yes** is selected, the following screen will ask you to select where the relay is wired (refer to Connection Table for this information).

Does Chiller Have a Valve? Select whether or not the Chiller has an associated valve. If **Yes** is selected, the following screen will ask you to select where the valve is wired (refer to Connection Table for this information).

Chiller Priority Duration? This question will appear if more than one chiller is configured. Set the amount of time that you will allow the priority chiller to cool before allowing the next chiller to start. If the priority chiller meets the demand within this time frame, the next chiller will not be used. Note that a time interval setting of “0” will eliminate priority and always run both chillers at the same time. If a time interval setting of “24” is selected, the next priority chiller will not turn on until the first priority chiller becomes invalid to run.

Minimum Operation Speed? Select the lowest pump speed that is allowed while solar heating. Set a speed that will ensure that there will be sufficient flow for the solar heating system to operate properly. For two speed pumps, you can select if you want to allow the filter pump to run at low speed during heater operation.

Do you have a Sense & Dispense Module? Select Yes if a Hayward HL-CHEM (sold separately) is connected to the OmniPL.

If Yes is selected:

The next few screens will configure the OmniPL to use Sense and Dispense. The OmniPL automatically detects smart components like the HL-CHEM, and assigns a Hayward Unique Address. If multiple components are detected, the OmniPL will show a table of devices and prompt you to select the proper device.

Which Hayward Unique Address? If a Hayward Unique Address (HUA) is already shown in the box, touch the Advance button. If no address is shown, selecting the box will bring you to a table showing all detected Sense and Dispense devices. Select the HL-CHEM from the table and touch the Done button to advance. The address should now be shown. Touch the Advance button to continue configuring the OmniPL for use with the HL-CHEM.

Does ORP Control Chlorination? If you say Yes to this, the HL-CHEM will constantly measure ORP and will adjust the pool’s chlorine based on a predetermined setpoint that you will select. The system will monitor ORP and automatically generate/dispense the correct amount of chlorine to maintain a desired level. Alternatively, if you say No to this question and select a TurboCell, the HL-CHEM will monitor ORP, but the amount of chlorine generated will be based on a manual setting that you will select.

If Yes is selected:

ORP Setpoint - Set the desired ORP level which is measured in mV. 650mV is the default. The OmniPL will continuously measure ORP and generate/dispense the proper amount of chlorine to maintain this setpoint.



HAYWARD®

ORP Timeout - Select a timeout interval. If the OmniPL has been chlorinating for more than the selected ORP timeout without reaching the desired level, the chlorinator will turn off and display an alarm. The user must clear the alarm to resume chlorination.

Type of Chlorinator? Select the Hayward TurboCell model, liquid chlorinator or tablet feeder that is installed in your system. A flow switch must be installed when using a chlorinator.

If TurboCell model is selected (requires a connected Hayward TurboCell or AquaRite with HLAQRPCB communication board):

Select Salt Monitoring Level - Select Standard Salt or Low Salt. If running the system using a low salt level (1200 PPM-1800 PPM, 1500 PPM optimal) select Low Salt. If running the system using standard salt level (2700 PPM - 3400 PPM, 3200 PPM optimal), select Standard Salt.

Where is the Cell Located? If an entry is already shown in the box, touch the Advance button. If no entry is shown, selecting the box will bring you to a table showing the detected cells. The OmniPL will detect a directly connected TurboCell and/or a TurboCell that is connected to an AquaRite (requires HLAQRPCB communication board). The table will display "Main Panel" under device type for directly connected TurboCells and "AquaRite", if a AquaRite is used.

If Liquid Chlorinator is selected:

Select Relay - Selecting the box will bring you to a table showing all HV relays. Find the relay that is connected to the Liquid Chlorinator. Select the relay and select Done.

If Tablet Feeder is selected:

Where is the Valve Wired? - Selecting the box will bring you to a table showing all valve outputs. Find the valve that is connected to the Tablet Feeder. Select the valve and select Done.

If No is selected:

Do You Have a Salt Water Chlorine Generator? (requires a connected Hayward TurboCell or AquaRite with HLAQRPCB communication board)

If Yes is selected:

Type of Cell? Select the type of Hayward TurboCell that is installed in your system.

Where is the Cell Located? If an entry is already shown in the box, touch the Advance button. If no entry is shown, selecting the box will bring you to a table showing the detected cells. The OmniPL will detect a directly connected TurboCell and/or a TurboCell that is connected to an AquaRite (requires HLAQRPCB communication board). The table will display "Main Panel" under device type for directly connected TurboCells and "AquaRite", if a AquaRite is used.



HAYWARD®

Percentage of Output? The OmniPL can only generate chlorine while the filter pump is operating. Set the percentage of run time that you desire chlorine generation. Raise this value to generate more chlorine. Lower this value to generate less.

Is pH Reduction Enabled? Select Yes if you have a dispenser to lower pH connected to the OmniPL.

If Yes is selected:

Are you Using Acid or CO₂? Select one.

How Many Acid/CO₂ Dispensers? Select the number of Acid/CO₂ dispensers in your system.

Which relay is it Wired to? Select the box to advance to the High Voltage Table. This table lists all of the high voltage relays that are installed in the OmniPL. Select the relay that is wired to the pH dispense unit. Refer to the Connection Table for this information.

pH Setpoint - Selecting the box will allow you to change the setpoint (7.5 default). Touch the Advance button when finished.

pH Dispensing Timeout - Select a timeout interval. If the unit has been dispensing for more than the selected timeout without reaching the desired level, pH dispensing will turn off and an alarm will be displayed. Check the chemical supply and the feeder. If both are OK, the timeout may need to be increased. The user must clear the alarm to resume pH dispensing.

pH Extend Enabled - If enabled, the OmniPL will continue to run the filter pump regardless of schedule until the pH level in the pool has reached the setpoint.

How Many Cleaners? - This question is for THIS BODY OF WATER ONLY. For example: If you have 2 cleaners; one for the pool Body of Water and one for the spa Body of Water, you would answer "1" to this question.

If "1" or more is selected:

Select and Configure a Cleaner At this screen you can add, delete and configure your cleaner(s). Select the desired cleaner, then touch the Advance button. When finished configuring cleaner(s), you'll be returned to this same screen. Touch the Done button to advance to the next section of configuration. Refer to the following information when configuring cleaner(s):

Type of Cleaner? Touch the box and select the type of cleaner used. Choices are Pressure, Suction, Robotic and In-Floor.

Name of Cleaner - Touch the box and use the keyboard to name the cleaner.

Does Cleaner Have a Pump? Select whether the cleaner has a dedicated pump. If so, the OmniPL will turn this pump on when the cleaner is scheduled to run.



HAYWARD®

If Yes is selected:

What Type? Select the type of pump used. The choices are Single Speed, Two Speed and VSP.

If single speed or two speed pump is selected:

Which Relay is it Wired to? If using a single speed or two speed pump, you'll be asked which relay(s) is wired to the pump. If a value is already shown in the box(es), advance to the next screen. If no value is shown, selecting the box will bring you to a table showing all detected relays. Select the proper relay(s) from the table and touch the Done button. The relay should now be shown in the box(es) and you can advance to the next screen to continue the pump configuration.

Would You Like to Enable Priming? Select whether you want the pump to prime when turned on. This will turn the pump on at high speed for a set duration to establish normal water flow every time the pump is activated after being off for at least 30 seconds. This option only appears if the pump is configured as a 2-speed pump.

If VSP is selected:

Which Hayward Unique Address? If using a VSP for your cleaner pump, you'll be asked what is the Hayward Unique Address (HUA). If a value is already shown in the box, advance to the next screen. If no value is shown, selecting the box will bring you to a table showing all detected devices. Select the proper HUA from the table and touch the Done button. The address should now be shown in the box and you can advance to the next screen to continue the VSP configuration.

Pump Capacity - Set the minimum and maximum RPM of the pump. Refer to your pump manual for more information.

Permitted User Setting - The OmniPL will automatically calculate these values based on the minimum and maximum RPM that were previously entered. They can be changed as desired.

Speed Presets - Set the Low Pump Speed %, Medium Pump Speed %, and High Pump Speed %, presets. These presets will be used when setting schedules for your pump.

Would You Like to Enable Priming? Select whether you want the pump to prime when turned on. This will turn the pump on at high speed for a set duration to establish normal water flow every time the pump is activated after being off for at least 30 seconds.

Does Cleaner have a Valve? Select whether the cleaner requires a valve to change position when in use.



HAYWARD®

If Yes is selected:

How Many? Select how many valves are used for the cleaner.

Where is the Valve(s) Wired? Selecting the box will bring you to a table showing all detected low voltage relays. Select the relay(s) that is wired to the cleaner valve(s), then advance. The valve(s) should now be shown in the box(es). Advance to the next screen to continue cleaner configuration.

Would you like your valve(s) to cycle On and Off at a set interval? If you would like the cleaner valve(s) to cycle to a set interval while cleaning, select Yes. Set the interval on the next screen.

Freeze Protection Enabled? Freeze protection is used to protect the pool and plumbed equipment against freeze damage during cold temperatures. If freeze protection is enabled AND the air temperature falls below the freeze threshold (refer to pump configuration), the OmniPL will turn on the cleaner pump to circulate the water.

How Many Water Features? - This question is for THIS BODY OF WATER ONLY. For example: If you have 2 water features; one for the pool Body of Water and one for the spa Body of Water, you would answer "1" to this question.

If "1" or more is selected:

Select and Configure a Water Feature At this screen you can add, delete and configure your water features. Select the desired water feature, then touch the Advance button. When finished configuring water features, you'll be returned to this same screen. Touch the Done button and advance to the next section of configuration. Refer to the following information when configuring water features:

Type of Water Feature? Touch the box and select the type of water feature used. Choices are Water Feature, Water Slide, Waterfall, and Fountain.

Name of Water Feature - Touch the box and use the keyboard to name the water feature.

Does Water feature Have a Pump? Select whether the water feature has a dedicated pump. If so, the OmniPL will turn this pump on when the water feature is scheduled to run.

If Yes is selected:

What Type? Select the type of pump used. The choices are Single Speed, Two Speed and VSP.

If single speed or two speed pump is selected:

Which Relay is it Wired to? If using a single speed or two speed pump, you'll be asked which relay(s) is wired to the pump. If a value is already shown in the box(es), advance to the next screen. If no value is shown, selecting the box will bring you to a table showing all detected relays. Select the proper relay(s) from the table and touch the Done. The relay(s) should now be shown in the box(es) and you can advance to the next screen to continue the pump configuration.



HAYWARD®

Would You Like to Enable Priming? Select whether you want the pump to prime when turned on. This will turn the pump on at high speed for a set duration to establish normal water flow every time the pump is activated after being off for at least 30 seconds. This option only appears if the pump is configured as a 2-speed pump.

If VSP is selected:

Which Hayward Unique Address? If using a VSP for your water feature pump, you'll be asked what is the Hayward Unique Address (HUA). If a value is already shown in the box, advance to the next screen. If no value is shown, selecting the box will bring you to a table showing all detected devices. Select the proper HUA from the table and touch the Done button. If unsure of the HUA, refer to the pump's manual for instructions on how to determine the pump's HUA. Once selected, the address should now be shown in the box and you can advance to the next screen to continue the VSP configuration.

Pump Capacity - Set the minimum and maximum RPM of the pump. Refer to your pump manual for more information.

Permitted User Setting - The OmniPL will automatically calculate these values based on the minimum and maximum RPM that were previously entered. They can be changed as desired.

Speed Presets - Set the Low Pump Speed %, Medium Pump Speed %, and High Pump Speed %, presets. These presets will be used when setting schedules for your pump.

Would You Like to Enable Priming? Select whether you want the pump to prime when turned on. This will turn the pump on at high speed for a set duration to establish normal water flow every time the pump is activated after being off for at least 30 seconds.

Water Feature Wired to a Relay? Select whether the water feature requires the use of a high voltage relay.

If Yes is selected:

Select Relay - Touching the box will bring you to a table showing all detected relays. Select the relay(s) that is connected to the water feature and touch the Done button. The relay should now be shown in the box and you can advance to the next screen to continue water feature configuration.

Does Water Feature have a Valve? Select whether the water feature requires a valve to change position when in use.

If Yes is selected:

How Many? Select how many valves are used for the water feature.



HAYWARD®

Where is the Valve(s) Wired? Selecting the box will bring you to a table showing all detected low voltage relays. Select the relay(s) that is wired to the water feature valve(s), then advance. The valve(s) should now be shown in the box. Advance to the next screen to continue water feature configuration.

Freeze Protection Enabled? Freeze protection is used to protect the pool and plumbed equipment against freeze damage during cold temperatures. If freeze protection is enabled AND the air temperature falls below the freeze threshold (refer to pump configuration), the OmniPL will turn on the water feature pump to circulate the water.

Would You Like To Configure A Default Startup Speed For Water Feature? If the water feature has a valve and the system uses a VSP filter pump, the OmniPL allows you to set a startup pump speed for the water feature, regardless of the pump's schedule. The speed will change at the next scheduled interval.

Do You Want to Configure Any Lights? Select yes if you are using any type of pool or spa lights. The options are Universal ColorLogic (UCL), ColorLogic 4.0 (CL4.0), ColorLogic 2.5 (CL2.5), WaterBowl, Pentair Color LED (P-COLOR), Jandy Color LED (Z-Color), Incandescent, and Other. Transformers powering Universal ColorLogic lights must all be connected to the same high voltage relay for synchronization to function properly. If using Omni Direct mode, you must use an internal relay, not an HLRELAYBANK.

If Yes is selected:

What Kind of Lights? Touch the box to select the type of lights that will be used. The options are UCL (14V), CL4.0 (115V), CL2.5 (14V), WaterBowl, P-Color, Z-Color, Incandescent, and Other.

Name the Group of Lights - Touch the box and use the keyboard to name the lights.

How Many Relays are Lights Wired to? Select the number of relays used by the lights.

Which Relay is it Wired to? Touching the box(es) will bring you to a table showing all detected relays. Select the relay(s) that are connected to the lights and touch the Done button. If the lights are connected to a Smart Power Transformer, select the zone(s) that the lights are wired to. The relay(s) should now be shown in the box(es) and you can advance to the next screen to continue the configuration.

If UCL was previously selected:

Would you like to test for Omni Direct capability? For UCL lights manufactured after June 2018, you can select Yes and the OmniPL will test your lights to confirm. If your lights blink white after the test, you can enable Omni Direct mode. If not, the UCL light will default to UCL Standalone mode. Note that if you are configuring a WaterBowl light, the Flicker feature will only be available if the light is set to OmniDirect mode.

How Many Accessories? Select the number of accessories that will be used for this Body of Water only. You'll have an opportunity to configure accessories for the spa and also the backyard at a later point.



HAYWARD®

If "1" or more is selected:

Select and Configure Accessories At this screen you can add, delete and configure your accessories. Select the desired accessory, then touch the Advance button. When finished configuring accessories, you'll be returned to this same screen. Touch the Done button and advance to the next section of configuration. Refer to the following information when configuring accessories:

Type of Accessory? Touch the box and select the type of accessory used. Choices are Laminars, Jets, Blower and Other.

Name of Accessory - Touch the box and use the keyboard to name the accessory.

Does Accessory Have a Pump? Select whether the accessory has a dedicated pump. If so, the OmniPL will turn this pump on when the accessory is scheduled to run.

If Yes is selected:

What Type? Select the type of pump used. The choices are Single Speed, Two Speed and VSP.

If single speed or two speed pump is selected:

Which Relay is it Wired to? If using a single speed or two speed pump, you'll be asked which relay(s) is wired to the pump. If a value is already shown in the box(es), advance to the next screen. If no value is shown, selecting the box will bring you to a table showing all detected relays. Select the proper relay(s) from the table and touch the Done button. The relay(s) should now be shown in the box(es) and you can advance to the next screen to continue the pump configuration.

Would You Like to Enable Priming? Select whether you want the pump to prime when turned on. This will turn the pump on at high speed for a set duration to establish normal water flow every time the pump is activated after being off for at least 30 seconds. This option only appears if the pump is configured as a 2-Speed pump.

If VSP is selected:

Which Hayward Unique Address? If using a VSP for your accessory pump, you'll be asked what is the Hayward Unique Address (HUA). If a value is already shown in the box, advance to the next screen. If no value is shown, selecting the box will bring you to a table showing all detected devices. Select the proper HUA from the table and touch the Done button. The address should now be shown in the box and you can advance to the next screen to continue the VSP configuration.

Pump Capacity - Set the minimum and maximum RPM of the pump. Refer to your pump manual for more information.

Permitted User Setting - The OmniPL will automatically calculate



HAYWARD®

these values based on the minimum and maximum RPM that were previously entered. They can be changed as desired.

Speed Presets - Set the Low Pump Speed %, Medium Pump Speed %, and High Pump Speed %, presets. These presets will be used when setting schedules for your pump.

Would You Like to Enable Priming? Select whether you want the pump to prime when turned on. This will turn the pump on at high speed for a set duration to establish normal water flow every time the pump is activated after being off for at least 30 seconds.

Accessory Wired to Relay? Select whether the accessory requires the use of a high voltage relay.

If Yes is selected:

Select Relay - Touching the box will bring you to a table showing all detected relays. Select the relay that is connected to the accessory and touch the Done button. The relay should now be shown in the box and you can advance to the next screen to continue the accessory configuration.

Does Accessory have a Valve? Select whether the accessory requires a valve to change position when in use.

If Yes is selected:

How Many? Select how many valves are used for the accessory.

Where is the Valve(s) Wired? Selecting the box will bring you to a table showing all detected low voltage relays. Select the relay(s) that is wired to the accessory valve(s), then advance. The valve(s) should now be shown in the box. Advance to the next screen to continue accessory configuration.

Freeze Protection Enabled? Freeze protection is used to protect the pool and plumbed equipment against freeze damage during cold temperatures. If freeze protection is enabled AND the air temperature falls below the freeze threshold (refer to pump configuration), the OmniPL will turn on the accessory pump to circulate the water.

Would You Like To Configure A Default Startup Speed For the Accessory? If the accessory has a valve and the system uses a VSP filter pump, the OmniPL allows you to set a startup pump speed for the accessory, regardless of the pump's schedule. The speed will change at the next scheduled interval.

NOTE: The following configuration settings are specific to the second Body of Water regarding Shared Equipment and Dual Equipment with shared heaters setup.

As you advance through the second Body of Water's configuration settings, note that most of the questions asked are the same as the first Body of Water with the exception of the following:

Does Body of Water 2 share its equipment with Body of Water 1?



HAYWARD®

If Yes is selected:

Your system will be “fully shared” which means your filter pump/heaters/chemistry will be shared between both Bodies of Water. You can now set your filter pump and heater settings for this body of water.

If No is selected:

You will begin dual equipment setup for you second Body of Water. This means that your filter pump and chemistry will not be shared between both Bodies of Water, but you will still have the option of configuring shared heaters and spillover. You can now configure a filter pump and heaters for this body of water.

Are any of Body of Water 2's heaters shared with Body of Water 1?

If Yes is selected:

Which body of water is heated in the event that both are running? Select the Body of Water that you would like to have heating priority if both Bodies of Water are running. This question only appears if you have a Pool/Pool or Spa/Spa setup. If you have a Pool/Spa setup, then the Spa Body of Water will automatically have heating priority.

Select Shared Heater Valves - Select Body of Water 1's return valve, Body of Water 2's return valve, and the Heater return valve in your system. The selections will also affect spillover operation.

Select the heaters you wish to share - Select the heaters that you configured in Body of Water 1 that you would like to be shared with Body of Water 2 and press advance.

Does this body of water have any additional heaters? Select whether you have any additional heaters in Body of Water 2 that you would like to configure that are not shared with Body of Water 1.

Do you have Spillover? Select yes to this question if you have Spillover in your system. If yes is selected, choose the valves that will operate Spillover from the following screen.

NOTE: The remaining configuration settings are not specific to a Body of Water.

Do You Have an Air Temperature Sensor? Select whether there is an air temperature sensor wired to the OmniPL.

If Yes is selected:

Where is the Sensor Wired?

Touching the box will bring you to a table showing all detected sensors connections. Select the sensor connection used for the air sensor (typically SENS2) and touch the Done button. The sensor connection should now be shown in the box and you can advance to the next screen to continue configuration.

Do You Have a Water Temperature Sensor? Select whether there is a water temperature sensor wired to the OmniPL.

If Yes is selected:

Where is the Sensor Wired?



HAYWARD®

Touching the box will bring you to a table showing all detected sensors connections. Select the sensor connection used for the water sensor (typically SENS1) and touch the Done button. The sensor connection should now be shown in the box and you can advance to the next screen to continue configuration.

Do You Have a Flow Switch? Select whether there is a flow switch wired to the OmniPL.

If Yes is selected:

Where is the Sensor Wired?

Touching the box will bring you to a table showing all detected sensors connections. Select the sensor connection used for the (typically FLOW SWITCH 1) and touch the Done button. The sensor connection should now be shown in the box and you can advance to the next screen to continue configuration.

Select and Configure Sensors At this screen you can add, delete and configure your sensors. Select the desired sensor, then touch the Advance button. When finished configuring sensors, you'll be returned to this same screen. Touch the Done button and advance to the next section of configuration. Refer to the following information when configuring sensors:

Where is the Sensor Located? Touch the box and go to the table showing the Bodies of Water and the Backyard. Select the location where the sensor is installed.

What Type of Sensor? Select the type of sensor. Choices are Air, Water, Flow or Solar.

Name Sensor - Touch the box and use the keyboard to name the sensor.

Where is the Sensor Wired? Touching the box will bring you to a table showing all detected sensors connections. Select the sensor connection used for the sensor and touch the Done button. The sensor connection should now be shown in the box and you can advance to the next screen to continue configuration.

Do You Want to Configure Any Backyard Lights? Select yes if you are using any type of pool, spa or outdoor lights. The options are Universal ColorLogic (UCL), ColorLogic 4.0 (CL4.0), ColorLogic 2.5 (CL2.5), WaterBowl, Pentair Color LED (P-COLOR), Jandy Color LED (Z-Color), Incandescent, and Other. Transformers powering Universal ColorLogic lights must all be connected to the same high voltage relay for synchronization to function properly. If using Omni Direct mode, you must use an internal relay, not an HLRELAYBANK.

If Yes is selected:

What Kind of Lights? Touch the box to select the type of lights that will be used. The options are UCL (14V), CL4.0 (115V), CL2.5 (14V), WaterBowl, P-Color, Z-Color, Incandescent, and Other.

Name the Group of Lights - Touch the box and use the keyboard to name the lights.

How Many Relays are Lights Wired to? Select the number of relays used by the lights.

Which Relay is it Wired to? Touching the box(es) will bring you to a table showing all detected relays. Select the relay(s) that are connected to the lights and touch the Done button. If the



HAYWARD®

lights are connected to a Smart Power Transformer, select the zone(s) that the lights are wired to. The relay(s) should now be shown in the box(es) and you can advance to the next screen to continue the configuration.

If UCL was previously selected:

Would you like to test for Omni Direct capability? For UCL lights manufactured after June 2018, you can select Yes and the OmniPL will test your lights to confirm. If your lights blink white after the test, you can enable Omni Direct mode. If not, the UCL light will default to UCL Standalone mode. Note that if you are configuring a WaterBowl light, the Flicker feature will only be available if the light is set to Omni-Direct mode.

How Many Accessories are in the Backyard? Select the number of accessories that will be used for the backyard.

If "1" or more is selected:

Select and Configure Accessories At this screen you can add, delete and configure your accessories. Select the desired accessory, then touch the Advance button. When finished configuring accessories, you'll be returned to this same screen. Touch the Done button and advance to the next section of configuration. Refer to the following information when configuring accessories:

Name of Accessory - Touch the box and use the keyboard to name the accessory.

Which Relay is it Wired to? Touching the box will bring you to a table showing all detected relays. Select the relay that is connected to the accessory and touch the Done button. The relay should now be shown in the box and you can advance to the next screen to continue the accessory configuration.

NOTE: Do not use the OmniPL to control fire pits or any other fire related equipment.

Would You Like to Add an Interlock? An interlock will allow the OmniPL to turn on or off pool equipment (affected) based on the state of other pool equipment (monitored). An example of this is would be the desire to turn on walkway lighting (affected) every time the pool deck lights (monitored) are turned on. This equipment could have been wired together to accomplish the same function, but by interlocking the walkway lights to the deck lights, you'll maintain the ability to turn on the walkway lights independently. An interlock can also control pool equipment based on the state of a temperature sensor, flow switch or external input (normally open/closed switch). An example of this would be to turn on a cabana fan (affected) whenever the outside temperature sensor reads above 90°F. Or, turning on a bug lamp (affected) when a photo sensor (monitored) detects that it is dusk.

If Yes is selected:

Select an Interlock Type - From this screen, select the type of interlock that you would like to configure. The choices are: Equipment to Equipment, Equipment to Sensor, Equipment to Mode, Theme to Sensor, Spillover to External Input and Pool Cover Interlock. Note that interlocks are only selectable if the equipment/features used in that interlock are available. For example, if there are no Themes configured, the Theme to Sensor interlock is not selectable.

If Equipment to Equipment is selected:

To configure the interlock, you'll be asked a series of questions. The questions will vary depending on the equipment that will be configured and cannot all be cov-



HAYWARD®

ered in this manual. In general, you'll select equipment that will be monitored and equipment that will be affected. The equipment could be pumps, valves, heaters, lights, etc. The affected equipment will activate/deactivate depending on the state of the monitored equipment. Advance through the configuration and when finished, a summary screen will be displayed. The summary will describe how the interlocked equipment will function. Read through the description and make sure the equipment will function as desired.

If Equipment to Sensor is selected:

This interlock is similar to above, but the monitored equipment will be a sensor. The monitored sensor can be any sensor, flow switch or external input that has been configured for use with the OmniPL. The affected equipment will activate/deactivate depending on the state of the monitored sensor. For flow switch sensors, affected equipment will turn on/off when the flow switch detects flow or no flow. For temperature sensors, affected equipment will activate/deactivate when the temperature is higher or lower than a desired setpoint. For external inputs, affected equipment will turn on/off when the switch is actuated. Advance through the configuration and when finished, a summary screen will be displayed. The summary will describe how the interlocked equipment will function. Read through the description and make sure the equipment will function as desired.

If Equipment to Mode is selected:

With Equipment to Mode interlock, affected equipment will activate/deactivate based on which mode the OmniPL is in; Pool, Spa or Spillover. You can configure this interlock to turn on/off equipment whenever the OmniPL goes into one of these available modes. Advance through the configuration and when finished, a summary screen will be displayed. The summary will describe how the interlocked equipment will function. Read through the description and make sure the equipment will function as desired.

If Theme to Sensor is selected (at least one Theme must be configured, see Operation Manual):

This interlock is similar to the Equipment to Sensor interlock but a Theme is affected instead. As explained in the Operation manual, Themes are created to execute many pool functions with a single button. With a Theme to Sensor interlock, the Theme will run or stop depending on the state of the monitored sensor. For flow switch sensors, the Theme will run or stop when the flow switch detects flow or no flow. For temperature sensors, the Theme will run or stop when the temperature is higher or lower than a desired setpoint. For external inputs, the Theme will run or stop when the switch is actuated. Advance through the configuration and when finished, a summary screen will be displayed. The summary will describe how the interlocked Theme will function. Read through the description and make sure the equipment will function as desired.

If Spillover to External Input is selected (requires that you have an external input configured):

This interlock prevents Spillover mode when an external input (most commonly a pool cover sensor) is actuated. By interlocking Spillover to the pool cover sensor, you'll



HAYWARD®

ensure that water cannot spill into the pool when the cover is in the closed position. A summary screen will be displayed after configuring this interlock. Read through the description and make sure the interlock will function as desired.

If Pool Cover Interlock is selected (if using an automatic pool cover):

This interlock makes it easy to assign specific pool settings when the cover is closed. Pump speed, heater temperature and chlorination percentage can all be preset for periods when the pool cover sensor (external input) detects that the cover is closed. Some or all of these options may not appear if you don't have a variable speed pump, heater or if not using chlorination. An alternative to this interlock is using a Theme to Sensor interlock. Create a Theme using desired settings when the pool cover is closed, then interlock the Theme to the pool cover sensor. A summary screen will be displayed after configuring this interlock. Read through the description and make sure the interlock will function as desired.



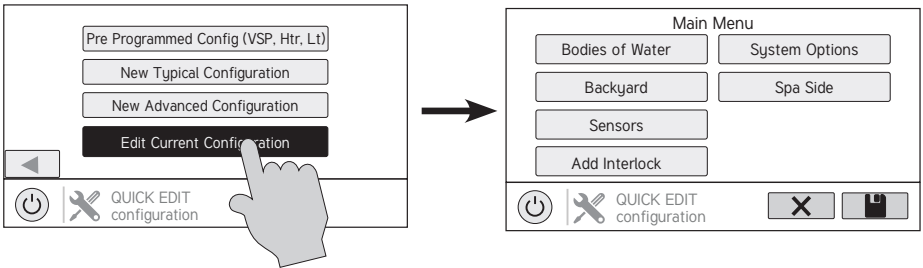

Quick Edit Guide

If additional pool or backyard equipment is added after initial configuration, or you'd like to make a change to an existing configuration setting, re-enter the Configuration Wizard and select "Edit". After selecting "Edit", you will be brought to the Quick Edit Main Menu screen as shown below. Quick Edit allows you to go directly to the equipment that you'd like to add/remove/configure. When you have finished editing the configuration, you will return to this screen to save your changes.



Navigation

There are a number of additional buttons that appear in Quick Edit that either have functions unique to Quick Edit or do not appear anywhere else in the system. These buttons are as follows:

-  **Save** - Touch this button to save the configuration edit. This button only appears on the Quick Edit Home screen.
-  **Cancel** - Touch this button to cancel any changes made to the configuration and exit Quick Edit. This button only appears on the Quick Edit Home Screen.
-  **Home** - Touch this button to quickly jump back to the Quick Edit Main Menu Screen to save your changes. This button appears at the end of every configuration pathway.
-  **Back** - Touch this button to go back to the previous set of configurable items.



HAYWARD®

As you are using Quick Edit, you will notice that at the end of each pathway, a Home button and a back arrow will appear. If you are finished making changes, press the Home button and then press the Save button to save your configuration. If you would like to make more changes to the same device, press the back arrow. This will take you back to the last screen of configurable items for that device. If you would like to continue to make changes, but to a different device, press the Home button and then follow the pathway to the new device. The following pages will explain each configuration pathway.

Begin Using Quick Edit

From the Quick Main Menu Screen, select one of the following buttons and follow the directions on the next page to configure your equipment.

- Bodies of Water
- Backyard
- Sensors
- Interlocks/Add Interlock
- System Options
- Spa Side

If Bodies of Water is selected:

Select the body of water - Select the Body of Water that you would like to make changes to. Both bodies of water will have the same equipment options for Quick Edit.

Body of Water is selected:

Select the Equipment that you would like to configure - The options are as follows: Filter Pumps, Heaters, Chemistry, Cleaners, Water Features, Standalone Lights, Accessories, and Other Options. If the equipment is not already configured, then the buttons will appear as Add Heater, Add Chemistry, etc. When the button is pressed with the word "Add" before it, then you will be taken through the full configuration for that equipment as appears in the Configuration Wizard portion of this manual. Otherwise:

If Filter Pumps is selected:

Select a Filter Pump - Once you select a filter pump, all of the options for that filter pump will appear on the next screen. These options are as follows:

Name - Rename the Filter Pump to whatever name you desire.

Type - Change the type of Filter Pump that is configured (Single Speed, 2-Speed, or VSP)

HUA - Match the HUA (Hayward Unique Address) to the configured Filter Pump. This option only appears if the Filter Pump is configured as a Variable Speed Pump.

Speed - Change the Minimum and Maximum Allowed Speeds of the Filter Pump as well as the Low, Medium and High speed settings. This option only appears if the Filter Pump is configured as a Variable Speed Pump.



HAYWARD®

Relay - Select the relay(s) that the Filter Pump is wired to. This option only appears if the Filter Pump is configured as a single speed or 2-Speed pump.

Off for Valve Change - Select whether you want the Filter Pump to shut off while valves are turning.

Flow Monitoring - Select whether you want flow to be monitored in this Body of Water.

Priming - Select whether you want the Filter Pump to prime and the desired duration. This option only appears if the Filter Pump is configured as a 2-Speed or Variable Speed Pump.

Freeze Protect - Select whether you want the Filter Pump to turn on for Freeze Protection. Also set the Freeze Protect air temperature threshold from this menu. Freeze protect operation can be overridden for a 60 minute period. (See Operation manual for more information).

If Heating/Cooling is selected:

Add a Heater - Pressing “Add a Heater” from this screen will take you through the full configuration for adding a new heater. These steps are described in the Configuration Wizard portion of this manual.

Add a Chiller - Pressing “Add a Chiller” from this screen will take you through the full configuration for adding a new chiller. These steps are described in the Configuration Wizard portion of this manual.

General Heater Options - Pressing this button will take you to a screen with the following general options for heater operation:

Extend - Select whether you want Heater Extend enabled for this Body of Water.

Cooldown - Select whether you want Heater Cooldown enabled for this Body of Water.

Max Temperature - Select the Maximum Allowed Heater Setpoint Temperature for this Body of Water.

Select a Heater/Chiller - Once you select a heater/chiller, all of the options for that heater/chiller will appear on the next screen. These options are as follows:

Name - Rename the heater/chiller to whatever name you desire.

HUA - Select the HUA of the Smart Heater. This option only appears if a Smart Heater is configured.



HAYWARD®

Type - Select the type of heater that is configured (Solar, Heat Pump, Gas, Geothermal, Electric).

Relay - Select the relay that the heater/chiller is wired to. Option not available for Solar heaters.

Valve - Configure the heating/cooling valve, if used.

Min Filter Speed - Select the minimum speed that the Filter Pump will run while the heater/chiller is active.

Min Air Temperature - Select the minimum air temperature that the heater will be allowed to run at. This option is only available if the heater is configured as a Heat Pump.

Priority Duration - Select the number of hours that this heater/chiller will run before the next priority heater/chiller turns on.

Pump - Configure the boost pump for the heater. This option is only available if the heater is configured as a Solar heater.

Solar Sensor - Configure the solar sensor. This option is only available if the heater is configured as a Solar heater.

Require Priming - Configure whether or not the filter pump will turn on for 3 minutes to prime during solar heating.

Delete a Heater/Chiller - From this screen, if you wish to delete a heater/chiller that is currently configured, select the trash can on the right of the name of the heater/chiller that you wish to delete.

If Chemistry is selected:

pH - Once you select pH, all of the options for pH dispensing will appear on the next screen. These options are as follows:

Reduction ON - Select whether you want pH reduction to be enabled.

Chemical Type - Select the type of chemical that is being dispensed (acid or CO₂).

pH Dispensers - Configure the pH dispense unit.

pH Timeout - Choose the pH timeout time.

pH Extend - Select whether you want pH extend enabled for this Body of Water.



HAYWARD®

Chem Sense Module - Once you select Chem Sense Module, you will be able to select the HUA of your Chem Sense Module you are using from the next screen.

Chlorination - A flow switch must be installed for this function. Once you select Chlorination, all of the options for chlorination will appear on the next screen. These options are as follows:

Dispenser Type - Select the type of dispenser used (T-CELL model, liquid chlorinator or tablet feeder).

Dispenser Relay or Valve - Depending on your dispenser type, select the output that controls the dispenser.

ORP Timeout - Choose the ORP timeout time and desired ORP setpoint. This option is only available if ORP controls chlorination.

Delete Chem Sense Module/Chlorination - From this screen, if you wish to delete any currently configured chemistry options, select the trash can on the right of the name of the item that you wish to delete.

NOTE: If either pH dispensing or chlorination are not configured, then this screen will give you the option to "Add CSM" or "Add Chlorination." If either of those options are selected, then you will be taken through the full configuration for that equipment as appears in the Configuration Wizard portion of this manual.

If Cleaners is selected:

Add Cleaner - Pressing "Add Cleaner" from this screen will take you through the full configuration for adding a new cleaner. These steps are described in the Configuration Wizard portion of this manual.

Select a Cleaner - Once you select a cleaner, all of the options for that cleaner will appear on the next screen. These options are as follows:

Name - Rename the cleaner to whatever name you desire.

Type - Select the type of cleaner that is configured (Pressure, Suction, Robotic, In Floor).

Pump - Configure the cleaner pump, if used.

Relay - Select the relay that the cleaner is wired to. This option only appears if the cleaner does not have an associated pump configured.

Valve - Configure the cleaner valve, if used.

Freeze Protect - Select whether you want the cleaner to turn on for Freeze Protection. Also set the Freeze Protect air temperature threshold from this menu.



HAYWARD®

Valve Cycle - Configure the valve cycling time period for the cleaner. This option is only available if the cleaner has an assigned valve.

Speed - Change the Minimum and Maximum Allowed Speeds of the cleaner as well as the Low, Medium and High speed settings. This option only appears if the cleaner pump is configured as a Variable Speed Pump.

Priming - Select whether you want the cleaner pump to prime and the desired duration. This option only appears if the cleaner pump is configured as a 2-Speed or Variable Speed Pump.

Delete a Cleaner - From this screen, if you wish to delete a cleaner that is currently configured, select the trash can on the right of the name of the cleaner that you wish to delete.

If Water Features is selected:

Add Water Feature - Pressing "Add Water Feature" from this screen will take you through the full configuration for adding a new water feature. These steps are described in the Configuration Wizard portion of this manual.

Select a Water Feature - Once you select a water feature, all of the options for that water feature will appear on the next screen. These options are as follows:

Name - Rename the water feature to whatever name you desire.

Type - Change the type of water feature that is configured (Waterfall, Water-slide, etc.).

Pump - Configure the water feature pump, if used.

Relay - Select the relay that the water feature is wired to. This option appears only if the water feature does not have an associated pump configured.

Valve - Configure the water feature valve, if used.

Speed - Change the Minimum and Maximum Allowed Speeds of the water feature pump as well as the Low, Medium and High speed settings. This option only appears if the water feature pump is configured as a Variable Speed Pump.

Priming - Select whether you want the water feature pump to prime and the desired duration. This option is only available if the water feature pump is configured as a 2-Speed or Variable Speed Pump.

Freeze Protect - Select whether you want the water feature to turn on for Freeze Protection. Also set the Freeze Protect air temperature threshold from this menu.



HAYWARD®

Default Startup Speed - Select the speed that the filter pump will run at when the water feature is turned on.

Delete a Water Feature - From this screen, if you wish to delete a water feature that is currently configured, select the trash can on the right of the name of the water feature that you wish to delete.

If Standalone Lights is selected:

Add Standalone Light - Pressing "Add Standalone Light" from this screen will take you through the full configuration for adding new lights. These steps are described in the Configuration Wizard portion of this manual.

Select an Existing Group of Lights - Once you select a group of existing lights, all of the options for those lights will appear on the next screen. These options are as follows:

Name - Rename the group of lights to whatever name is desired.

Type - Select the type of lights configured.

Relay - Select the relay(s) that the group of lights is wired to. If using a Smart Power Transformer, select the zone(s) that the lights are wired to.

Set Mode - Set the mode of the lights configured.

Omni Direct - If UCL was previously selected, this button will appear and allow you to test whether your UCL lights are Omni Direct compatible (lights built after June 2018). Note that if you are configuring a WaterBowl light, the Flicker feature will only be available if the light is set to OmniDirect mode.

Delete an Existing Group of Lights - From this screen, if you wish to delete a group of lights that is currently configured, select the group and then select the trash can button next to it.

If Accessories is selected:

Add Accessory - Pressing "Add Accessory" from this screen will take you through the full configuration for adding a new accessory. These steps are described in the Configuration Wizard portion of this manual.

Select an Accessory - Once you select an accessory, all of the options for that accessory will appear on the next screen. These options are as follows:

Name - Rename the accessory to whatever name you desire.

Type - Select the type of accessory configured (Laminar, Water Feature, etc.).

Pump - Configure the accessory pump, if used.

Valve - Configure the accessory valve, if used.



HAYWARD®

Speed - Change the Minimum and Maximum Allowed Speeds of the accessory pump as well as the Low, Medium and High Speed settings. This option only appears if the accessory pump is configured as a Variable Speed Pump.

Priming - Select whether you want the accessory pump to prime and the desired duration. This option is only available if the accessory pump is configured as a 2-Speed or Variable Speed Pump.

Freeze Protect - Select whether you want the accessory to turn on for Freeze Protection. Also set the Freeze Protect air temperature threshold from this menu.

Relay - Select the relay that the accessory is wired to. This option only appears if the accessory does not have an associated pump configured.

Default Startup Speed - Select the speed that the filter pump will run at when the accessory is turned on.

Delete an Accessory - From this screen, if you wish to delete an accessory that is currently configured, select the trash can on the right of the name of the accessory that you wish to delete.

If Other Options is selected:

Name - This is where you will be allowed to rename the Body of Water that you are currently configuring to whatever name you desire.

If Backyard is selected:

Select the Equipment that you would like to configure - The options are Add Standalone Light and Add Accessory. The configuration for these are described in the Configuration Wizard portion of this manual.

If Standalone Light is selected:

Add Standalone Light - Pressing "Add Standalone Light" from this screen will take you through the full configuration for adding new lights. These steps are described in the Configuration Wizard portion of this manual.

Select an Existing Group of Lights - Once you select a group of existing lights, all of the options for those lights will appear on the next screen. These options are as follows:

Name - Rename the group of lights to whatever name is desired.

Type - Select the type of lights configured.

Relay - Select the relay(s) that the group of lights is wired to. If using a Smart Power Transformer, select the zone(s) that the lights are wired to.

Set Mode - Set the mode of the lights configured.



HAYWARD®

Omni Direct - If UCL was previously selected, this button will appear and allow you to test whether your UCL lights are Omni Direct compatible (lights built after June 2018). Note that if you are configuring a WaterBowl light, the Flicker feature will only be available if the light is set to OmniDirect mode.

Delete an Existing Group of Lights - From this screen, if you wish to delete a group of lights that is currently configured, select the group and then select the trash can button next to it.

If Accessories is selected:

Add Accessory - Pressing "Add Accessory" from this screen will take you through the full configuration for adding a new accessory to the Backyard. These steps are described in the Configuration Wizard portion of this manual.

Select an Accessory - Once you select an accessory, all of the options for that Backyard accessory will appear on the next screen. These options are as follows:

Name - Rename the accessory to whatever name is desired.

Relay - Select the relay that the accessory is wired to.

Delete an Accessory - From this screen, if you wish to delete an accessory that is currently configured, select the trash can on the right of the name of the accessory that you wish to delete.

NOTE: The system does not allow you to configure a pump or a valve to accessory equipment in the Backyard.

If Sensors is selected:

Add Sensor - Pressing "Add Sensor" from this screen will take you through the full configuration for adding a new sensor. These steps are described in the Configuration Wizard portion of this manual.

Select a Sensor - Once you select a sensor, all of the options for that sensor will appear on the next screen. These options are as follows:

Name - Rename the sensor to whatever name is desired.

Location - Select the location that the sensor is wired to.

Delete a sensor - From this screen, if you wish to delete a sensor that is currently configured, select the trash can on the right of the name of the sensor that you wish to delete.

If Interlocks is selected:

Add Interlock - Pressing "Add Interlock" from this screen will take you through the full configuration for adding a new interlock. These steps are described in the Configuration Wizard portion of this manual.



Select an Interlock - Selecting an interlock from this screen will allow you to view that interlock's configuration. However, you cannot edit a pre-existing interlock. In order to change an interlock's configuration, you have to delete the obsolete interlock and create a new one.

Delete an Interlock - From this screen, if you wish to delete an interlock that is currently configured, select the trash can on the right of the name of the interlock that you wish to delete.

NOTE: If there are currently no interlocks configured on your system, then the button will appear as "Add Interlock" instead of "Interlocks". In this case, pressing "Add Interlock" will take you through the full configuration for adding a new interlock. These steps are described in the Configuration Wizard portion of this manual. Once an interlock has been created, the button will say "Interlocks".

If System Options is selected:

Modify Network Setup - Press this button to modify or setup a wired or wireless connection.

Would you like to set up a network connection now? Select the type of connection you would like to setup/modify or select "Not Now". For external antenna connections, you must have a Hayward HLWLAN connected to the OmniPL. "Wired" requires an ethernet connection to the router.

Wireless - If not connected to a network, selecting this button will run a scan of all available wifi networks. Select the desired network and enter a password to connect. Note that a 2.4GHz connection to the router is required. If already connected to a wifi network, selecting this button will present these four options:

Forget Network - This selection allows you to delete saved access points and will prevent the OmniPL from automatically connecting to the deleted wifi network.

Change Password - This selection will allow you to enter a new wifi password. Use this option if you've changed the wifi password on your router/access point.

Network Properties - Network properties will allow you to set a static ip address for the OmniPL. The OmniPL will default to a dynamic ip connection and display current network information such as the local/gateway ip addresses. If a static connection is desired, select "Static" and enter the required network information.

Diagnostic - This selection will re-establish a connection to your wireless network and display current network information such as wifi SSID, signal strength, and the local/gateway ip addresses.

Wired - For a wired connection, run an Ethernet cable from the Controller to the router (page 24). After selecting "Wired", the system will display the ip address and other network properties. Press the check mark and the OmniPL will verify the network connection. You can now exit back to the main menu and continue with the Configuration Wizard.



HAYWARD®

External Antenna - Make this selection when setting up a Hayward HLWLAN. Note that a 2.4GHz connection to the router is required. Once the system is done running through the diagnostics, press the check mark to continue to the next section of the Configuration Wizard.

Not Now - Skip network setup and continue with Configuration Wizard.

Mood Color - To alert the user of warning conditions (no flow, failed sensor, etc.), the OmniPL can change its screen color. The screen can display yellow or red depending on the severity of the condition.

Simple Mode - Use this selection to enable and disable icons to be displayed while in Simple Mode screen. For more information, refer to the Simple Mode section in the Operation manual.

If Spa Side is selected (requires HLSPASIDE):

Spa Side - Press this button to setup or modify a HLSPASIDE remote control.

Select an Aux button to configure - The 3 Aux buttons on the HLSPASIDE can be configured to run equipment, favorites or themes. In some cases, these buttons may be assigned to default functions. To change functions or assign a new function, select the button that you'd like to configure.

If an Aux button is selected:

Select Function - There are 4 options available.

Equipment - Pressing this button will bring you to a screen that shows all available equipment. Select the desired equipment that you want to assign to the Aux button.

Favorite - Pressing this button will bring you to a screen that shows all available Favorites. These Favorites had to have been defined prior to configuring the Aux buttons. Select the desired Favorite that you want to assign to the Aux button.

Theme - Pressing this button will bring you to a screen that shows all available Themes. These Themes had to have been defined prior to configuring the Aux buttons. Select the desired Theme that you want to assign to the Aux button

Unconfigured - If set to "Unconfigured", the Aux button will have no function.



HAYWARD®



HAYWARD®

LIMITED WARRANTY (effective 03/01/12) Hayward warrants its OmniLogic, OmniHub, OmniPL, Pro Logic, OnCommand and E-Command pool automation products as well as its Aqua Rite, Aqua Rite Pro, Aqua Plus and SwimPure chlorination products to be free of defects in materials and workmanship, under normal use and service, for a period of three (3) years. Hayward also warrants its Aqua Trol chlorination products to be free of defects in materials and workmanship, under normal use and service for a period of one (1) year. These warranties are applicable from the initial date of purchase on private residential swimming pools in the US and Canada. Installations of product for use on commercial pools in the US and Canada is covered for a period of one (1) year for defects in materials and workmanship. Hayward warrants all accessories and replacement parts for the above-identified pool automation and chlorination products for a period of one (1) year. Accessories also include remotes, actuators, base stations, temperature sensors, flow switches and chemistry probes. Each of these warranties is not transferable and applies only to the original owner.

Hayward shall not be responsible for cartage, removal, repair or installation labor or any other such costs incurred in obtaining warranty replacements or repair.

Proof of purchase is required for warranty service. If written proof of purchase is not provided, the manufacturing date code will be the sole determinant of the date of installation of the product. To obtain warranty service or repair, please contact the place of purchase or the nearest Hayward authorized warranty service center. For more information on authorized service centers please contact the Hayward Technical Service Support Center (61 Whitecap Road, North Kingstown RI, 02852) or visit the Hayward web site at www.hayward.com.

WARRANTY EXCLUSIONS:

1. Material supplied or workmanship performed by others in process of installation.
2. Damage resulting from improper installation including installation on pools larger than the product rating.
3. Problems resulting from failure to install, operate or maintain the product(s) in accordance with the recommendations contained in the owners manual(s).
4. Problems resulting from failure to maintain pool water chemistry in accordance with the recommendations in the owners manual(s).
5. Problems resulting from tampering, accident, abuse, negligence, unauthorized repairs or alternations, fire, flood, lightning, freezing, external water, degradation of natural stone used in or immediately adjacent to a pool or spa, war or acts of God.
6. Use of a non-genuine Hayward replacement salt chlorination cell on any Hayward automation or chlorination product will void the warranty for that product.

The express limited warranty above constitutes the entire warranty of Hayward Pool Products with respect to its products and is in lieu of all other warranties expressed or implied, including warranties of merchantability or fitness for a particular purpose. In no event shall Hayward Pool products be responsible for any consequential, special or incidental damages of any nature. Some states do not allow a limitation on how long an implied warranty lasts, or the exclusion of incidental or consequential damages, so the above limitation may not apply to you. This warranty gives you specific legal rights, and you may also have other rights, which vary from state to state.

For further information or consumer
technical support, visit our website at
www.hayward.com



Hayward is a registered trademark and OmniPL is a trademark of Hayward Industries, Inc. © 2023 Hayward Industries, Inc.

All other trademarks not owned by Hayward are the property of their respective owners. Hayward is not in any way affiliated with or endorsed by those third parties. For patent information, refer to www.hayward.com/patents.

USE ONLY HAYWARD GENUINE REPLACEMENT PARTS