

BSF Guidance Manual #1
Installation and Commissioning of
the
Concrete BioSand Water Filter

January 2009

Dr. David H. Manz, P. Eng., P. Ag.

Copyright claimed by David H. Manz January 2009

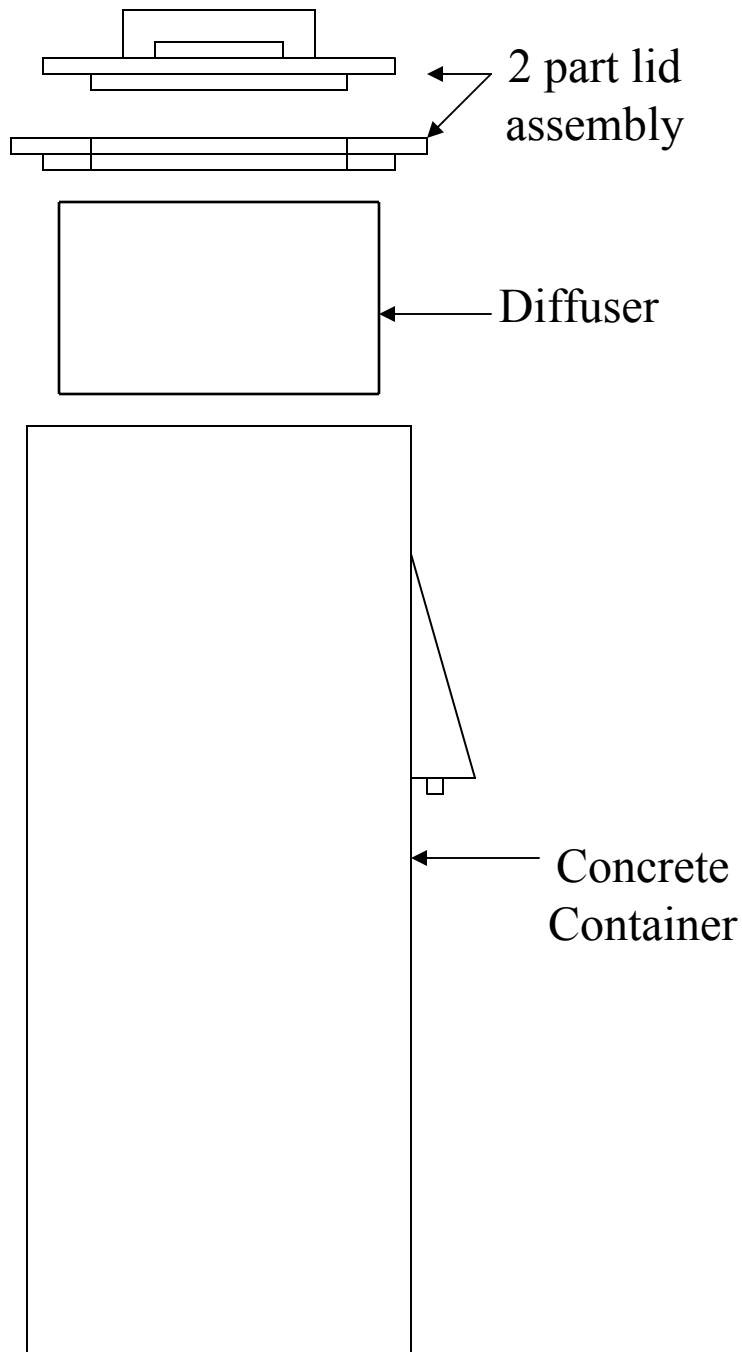

Concrete BioSand Water Filter Components

Media Set

4 – Layer System

- 1. Underdrain gravel – sufficient to cover filter outlet by 2 cm.**
- 2. Separation media – sufficient to cover underdrain gravel by 2.5 to 3 cm.**
- 3. Fine filter media – as previously determined to provide correct flow rate.**
- 4. Very fine filter media – as previously determined to provide correct flow rate.**

Cross-section of Concrete BioSand Water Filter

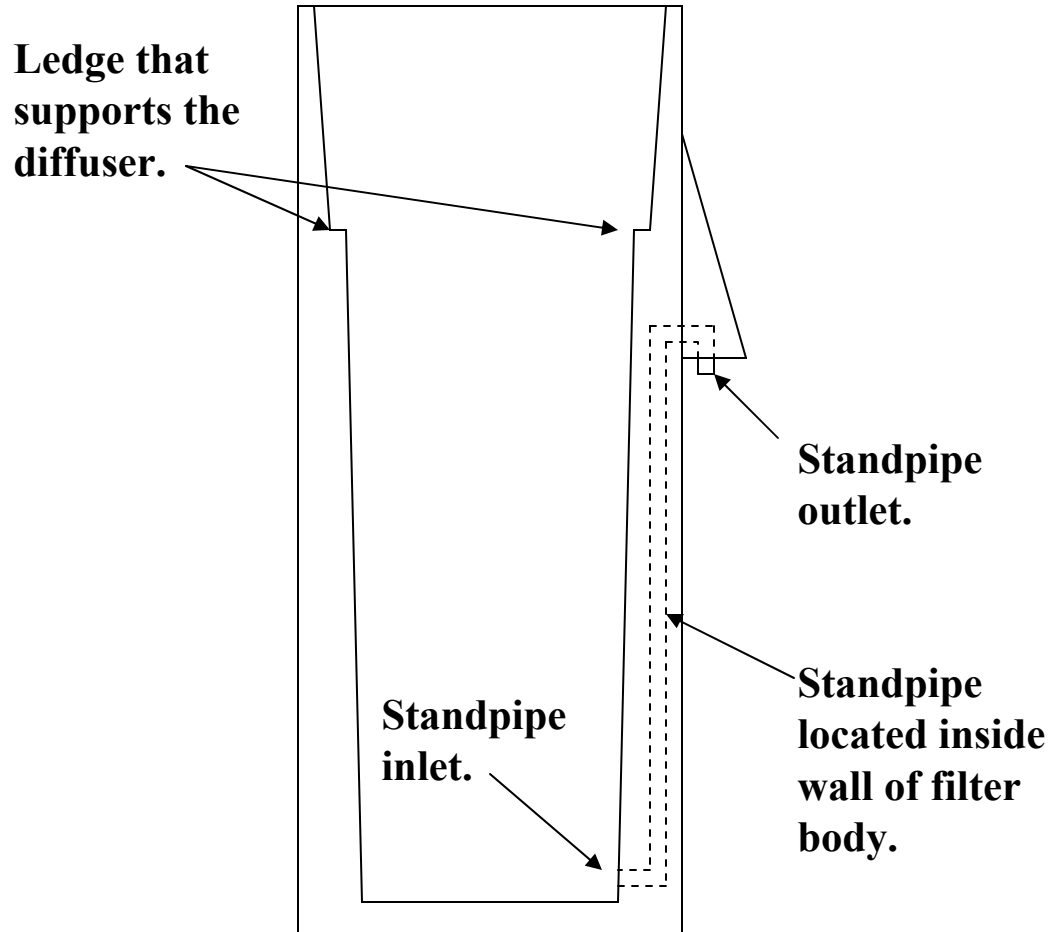

Assembly of Concrete BioSand Water Filter Elements

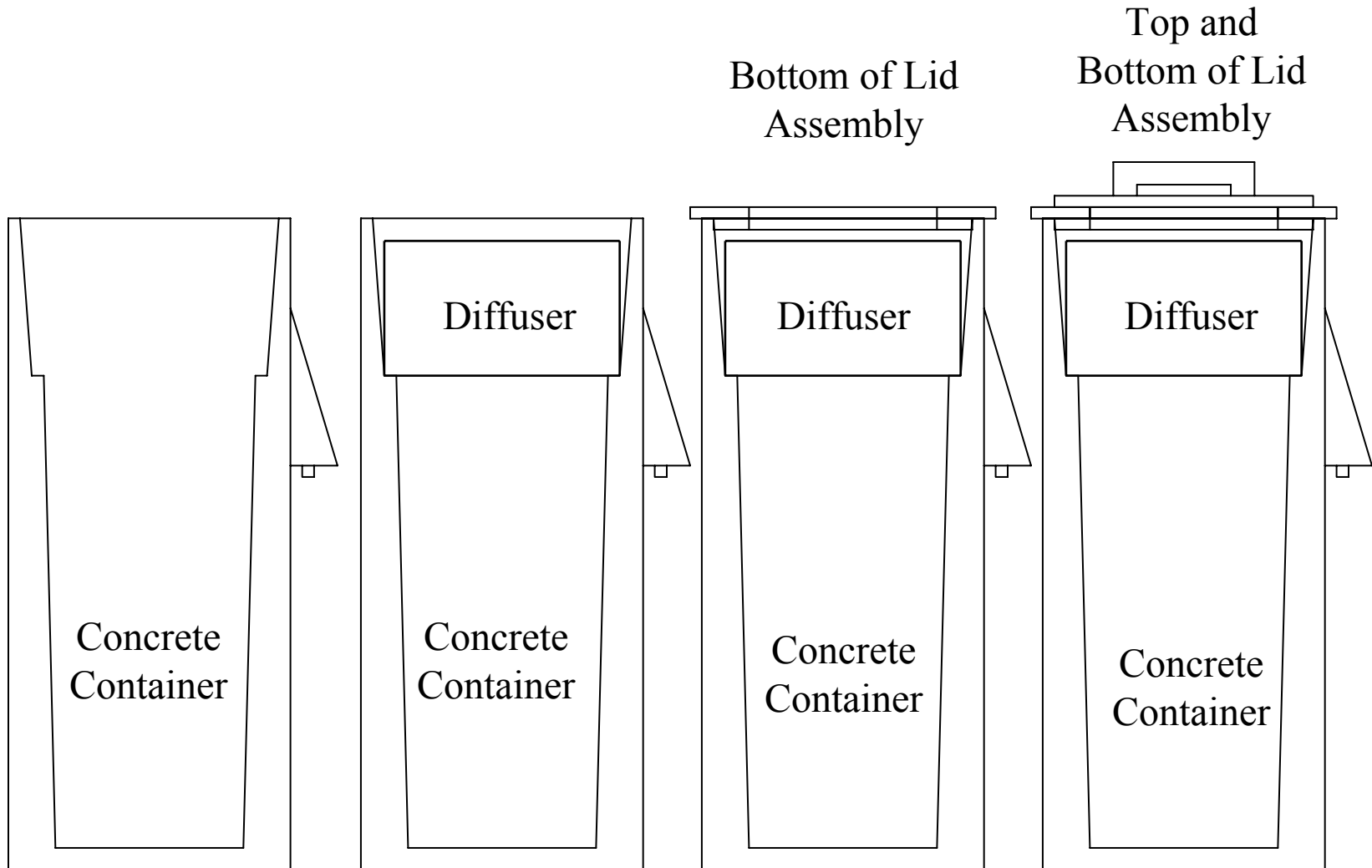

Construction of Measuring Stick

Used to assist in
installation media into
BioSand Water Filter.

Select two slender, straight
pieces of wood such that the
longer piece (measuring
stick) will extend 20 to 30
cm above the filter top when
touching the bottom of the
filter and the shorter piece
(cross piece) long enough to
extend across the top of the
filter. The cross piece
should have squared edges
like a ruler.

Insert measuring stick
such that it touches the
bottom of the filter and
make Mark #1.

(Use a waterproof
marker.)

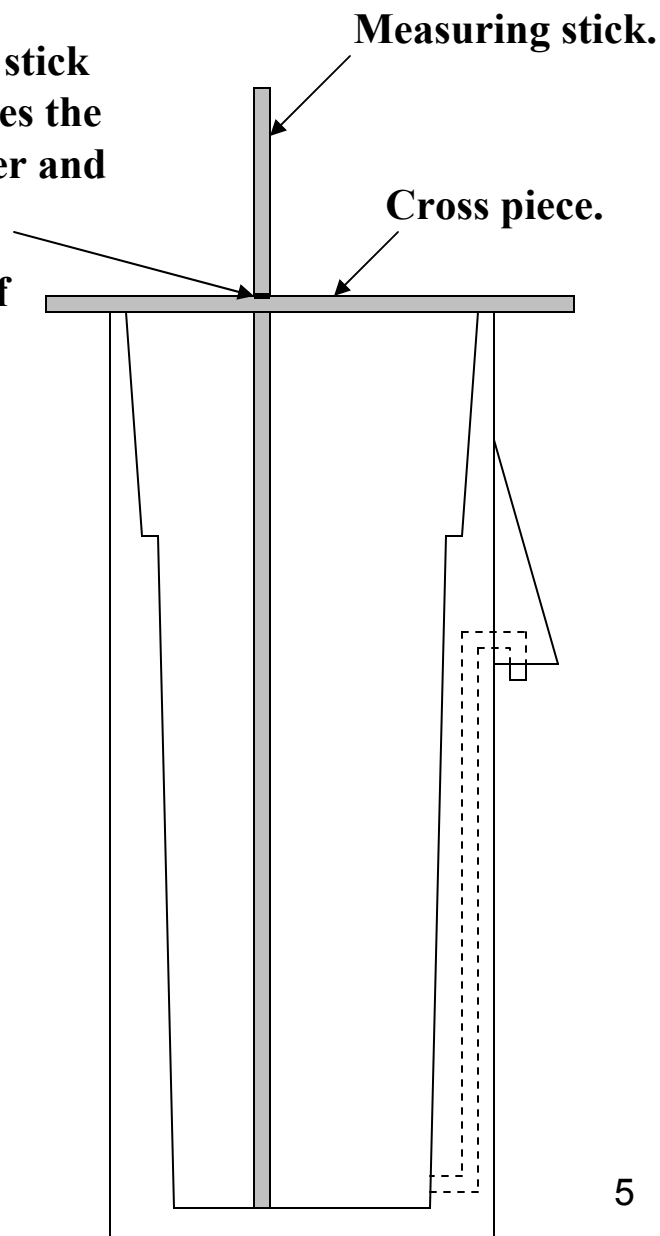

Fill filter with water until it flows from outlet.

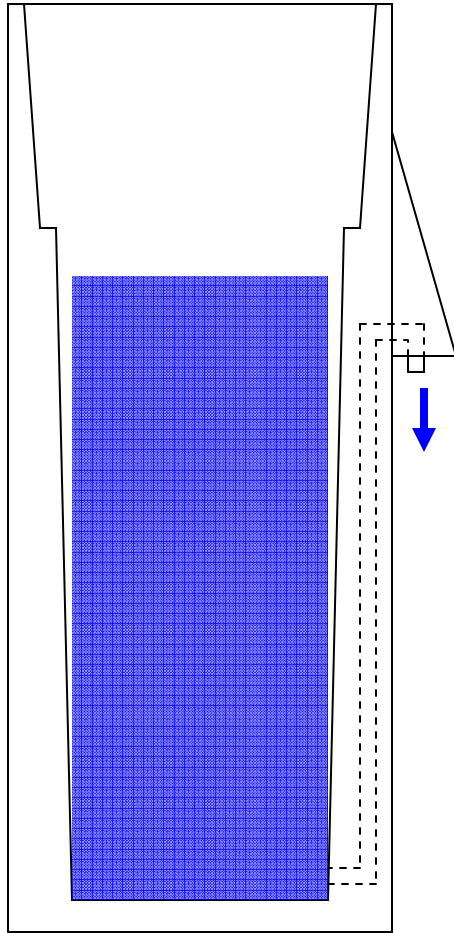

Allow flow to stop.

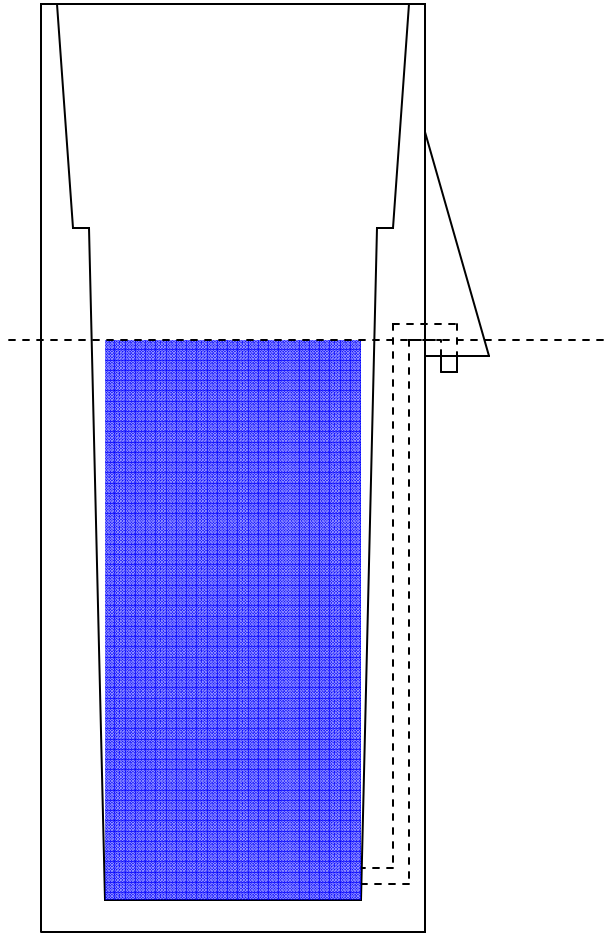

Insert measuring stick into filter such that it JUST touches the top of the water and make Mark #2.

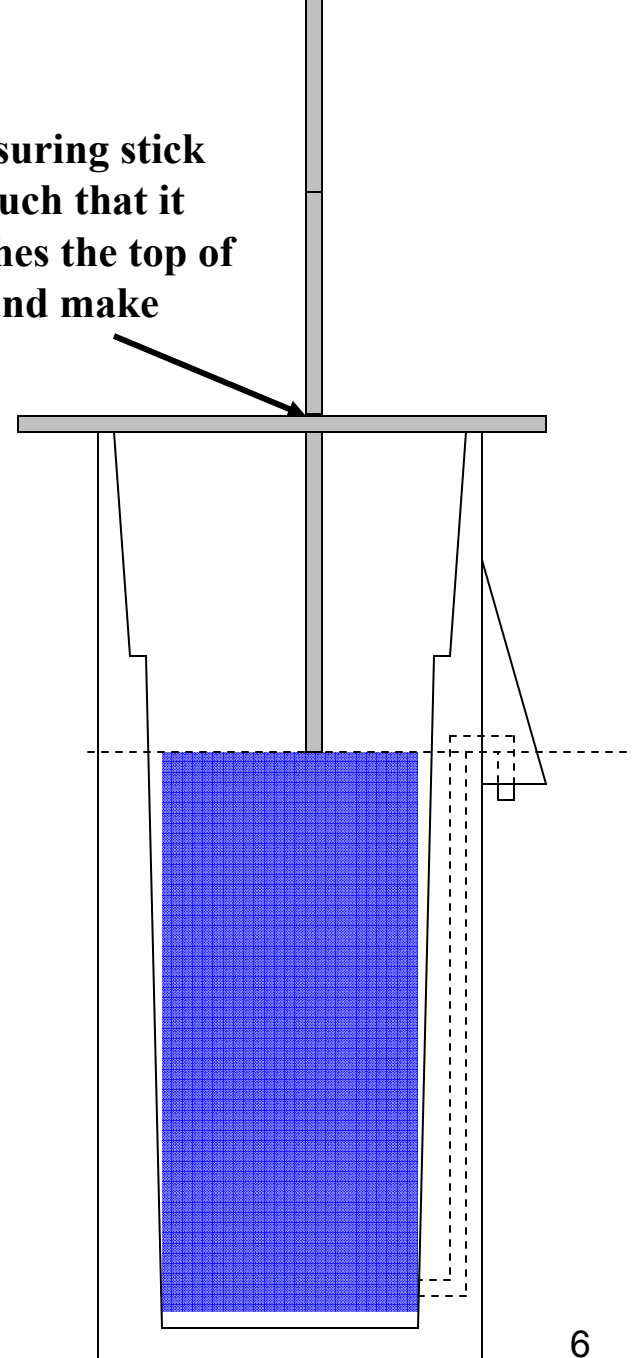

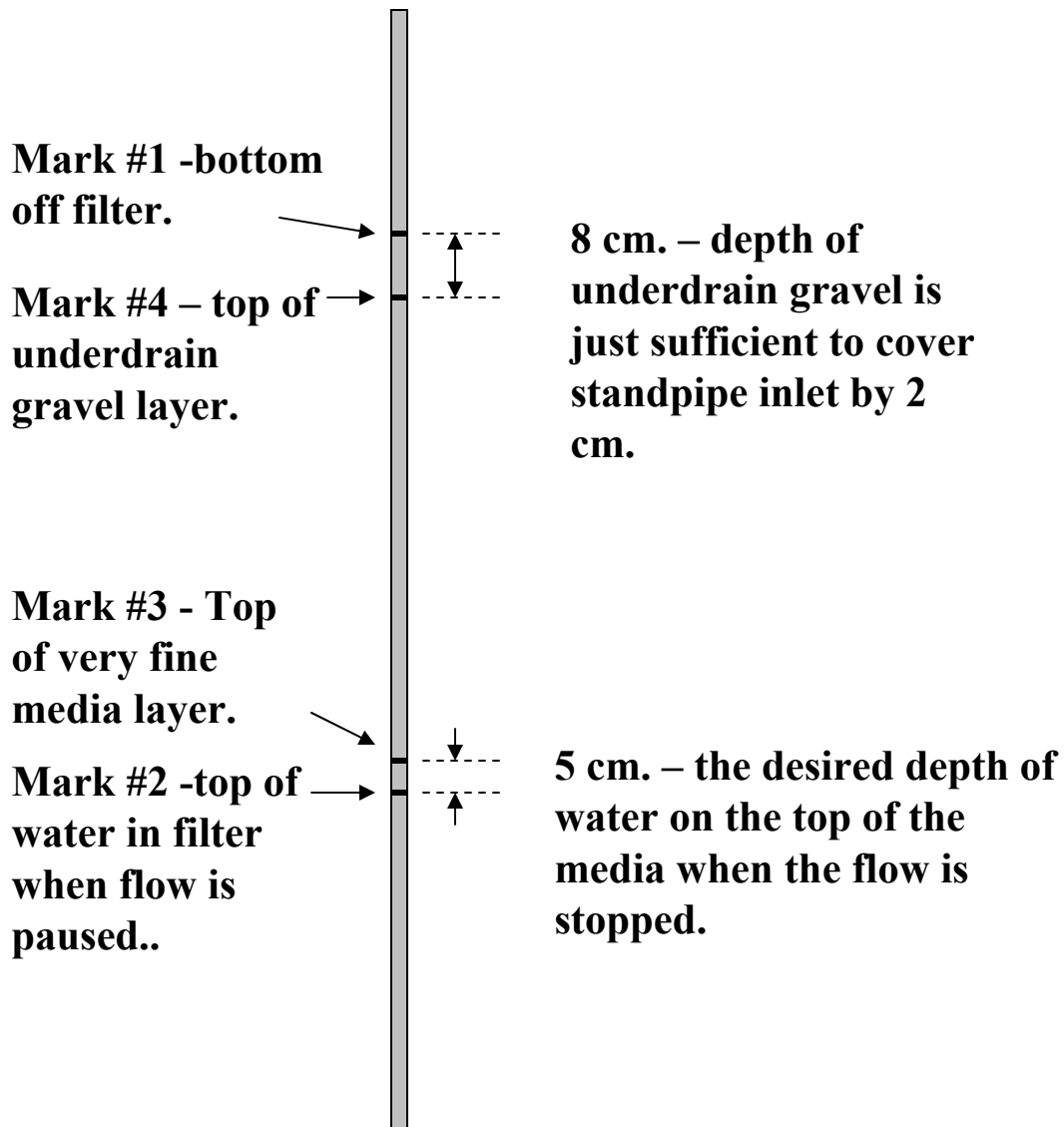

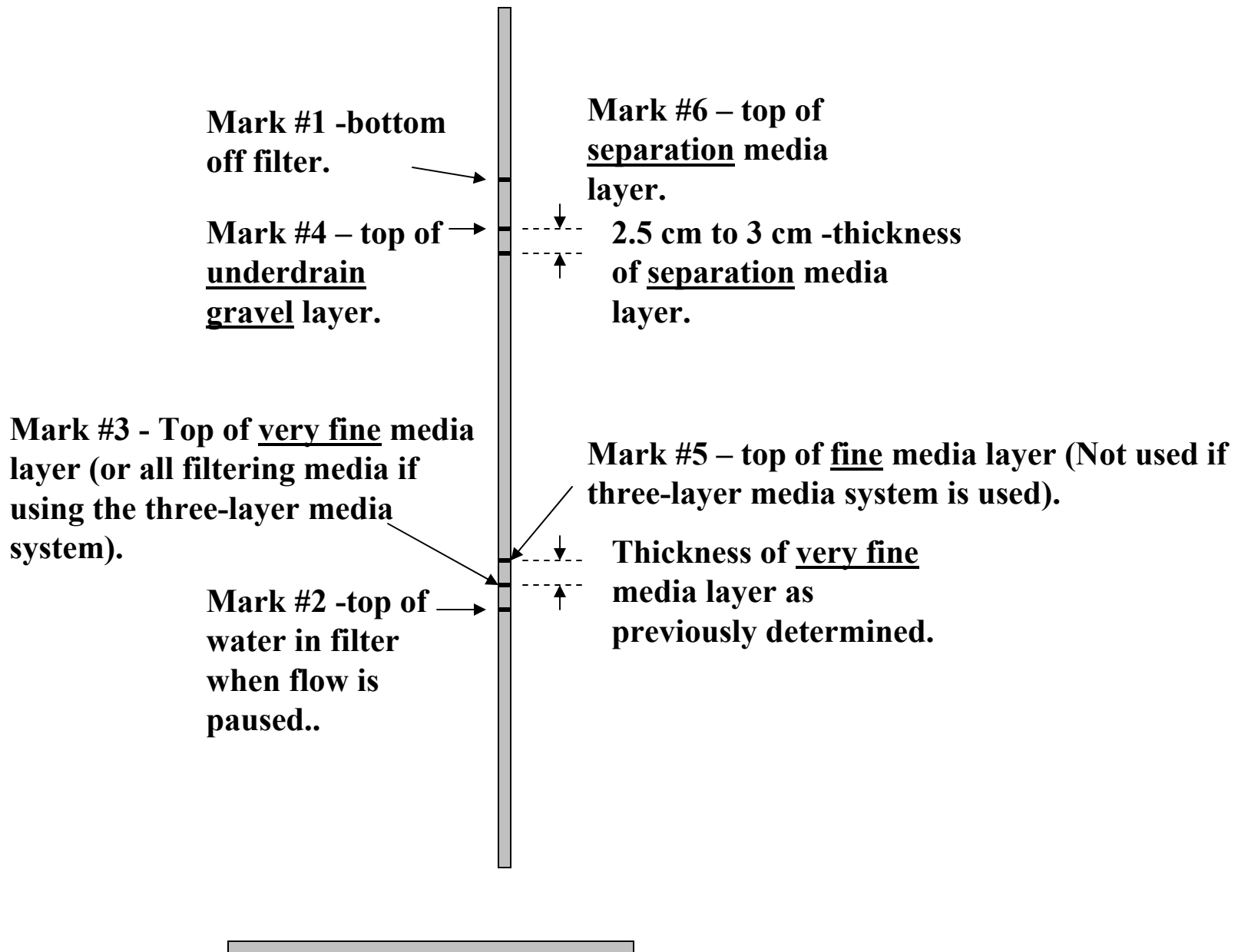

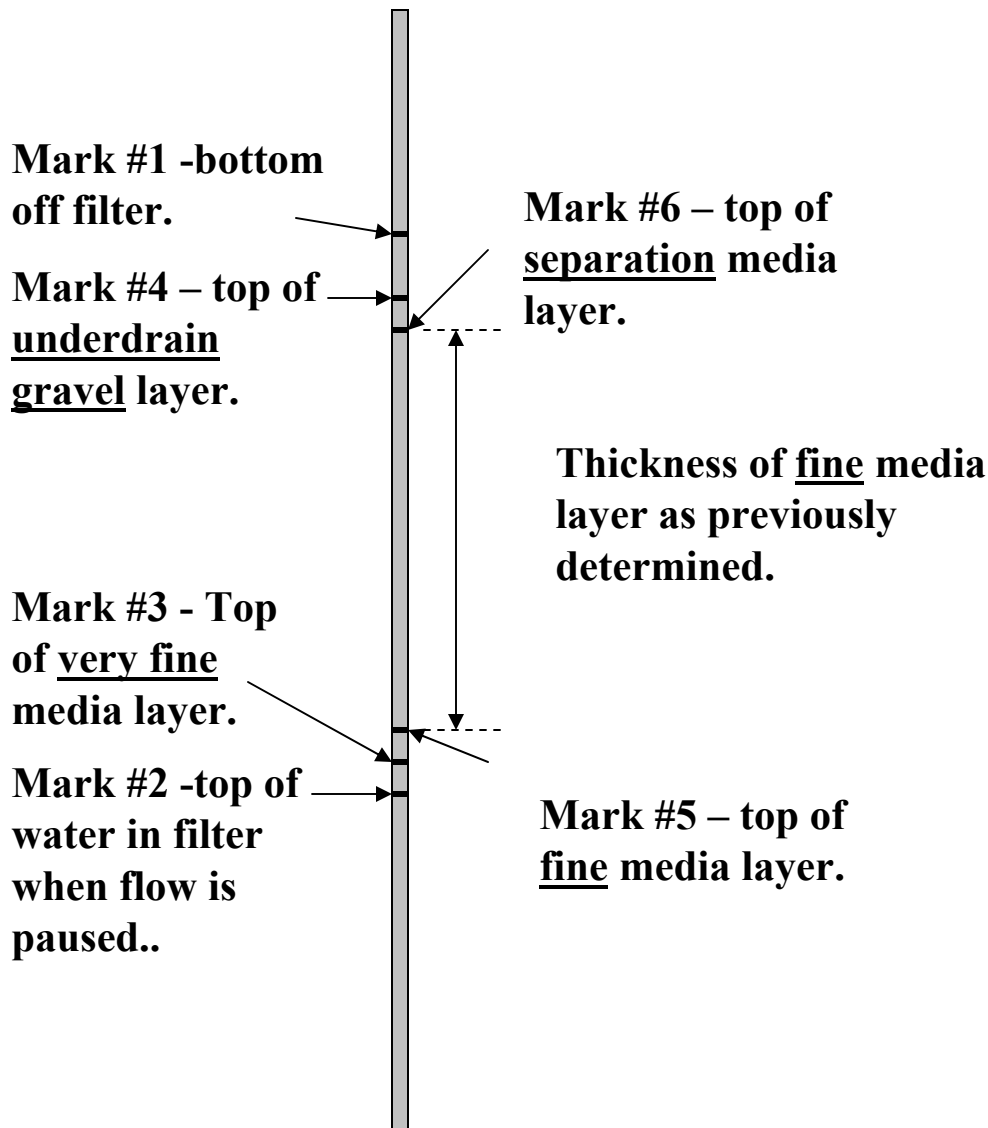

Measuring Stick
ready for use.

**It takes approximately
30 minutes to construct
one measuring stick.**

**A measuring stick is an
invaluable tool when
installing BioSand
Water Filters.**



Installation of Media.

Installation of Underdrain Gravel

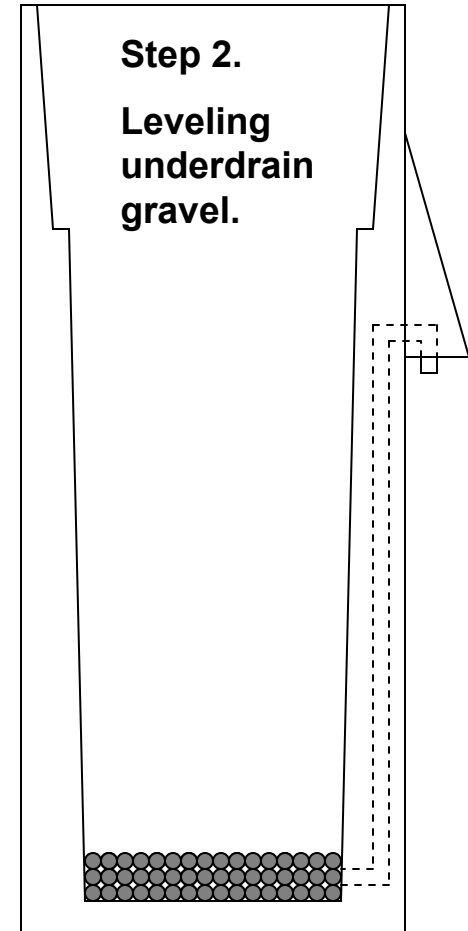
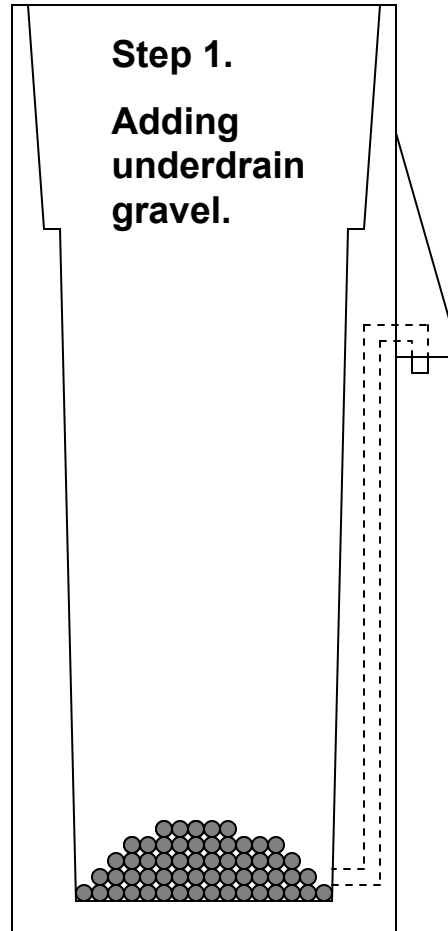
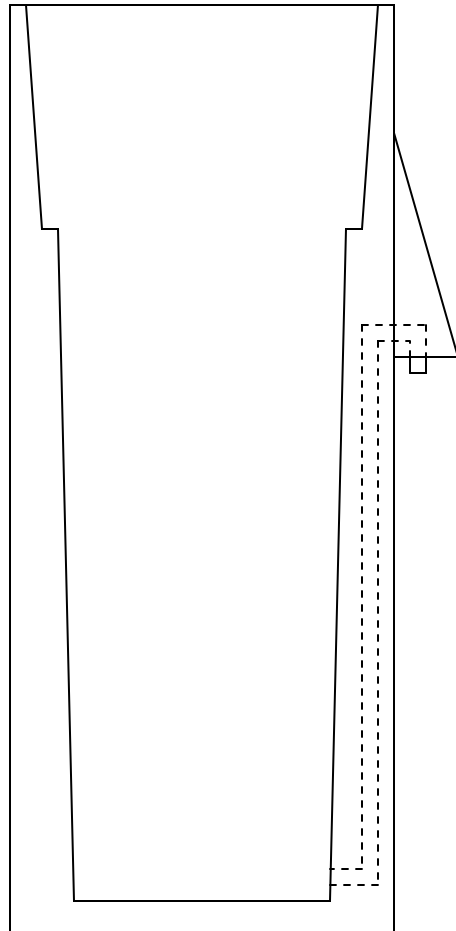

Installation of Underdrain Gravel Continued

Step 3.

Check
Depth.

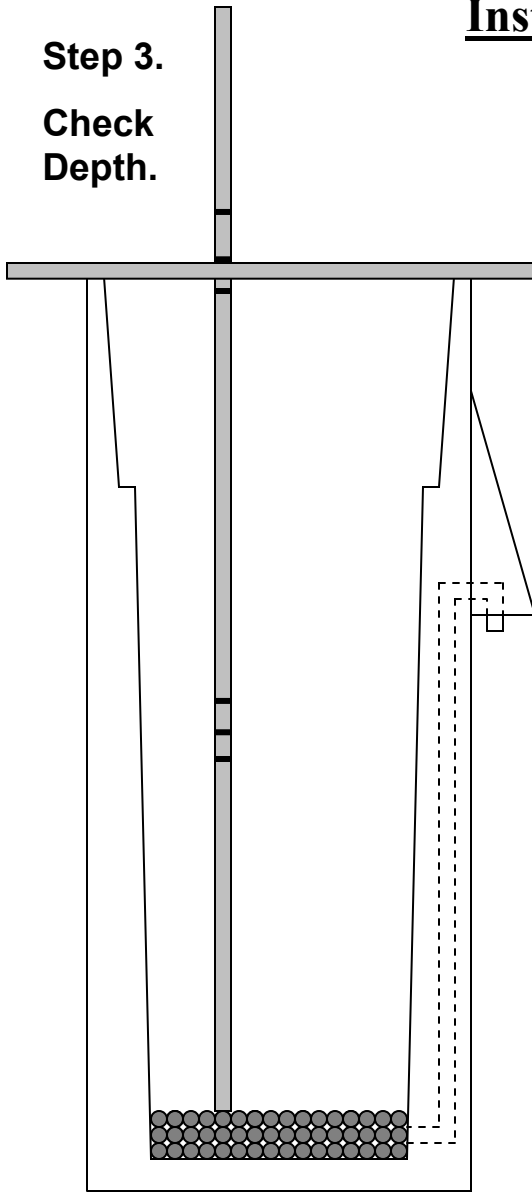

**Add or subtract
underdrain material as
necessary to achieve
desired thickness.**

Installation of Separation Media.

Step 4.
Placing Diffuser.

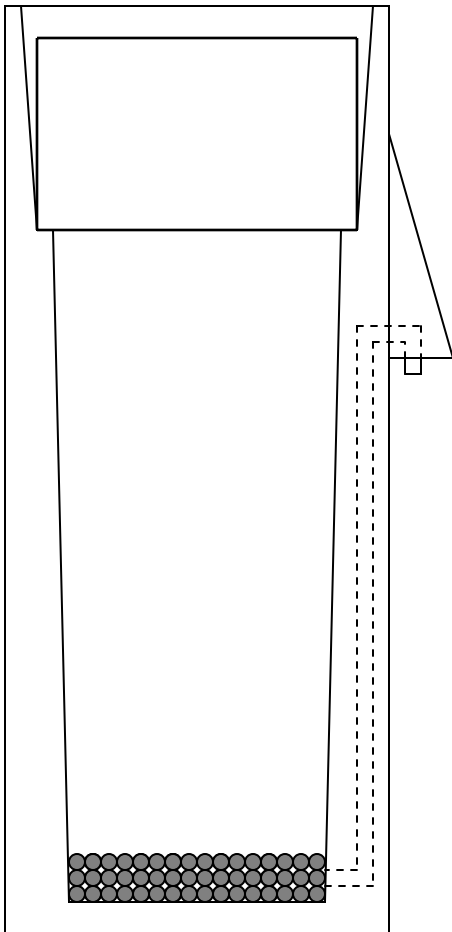

Step 5.
Add Untreated
Water Through
Diffuser.

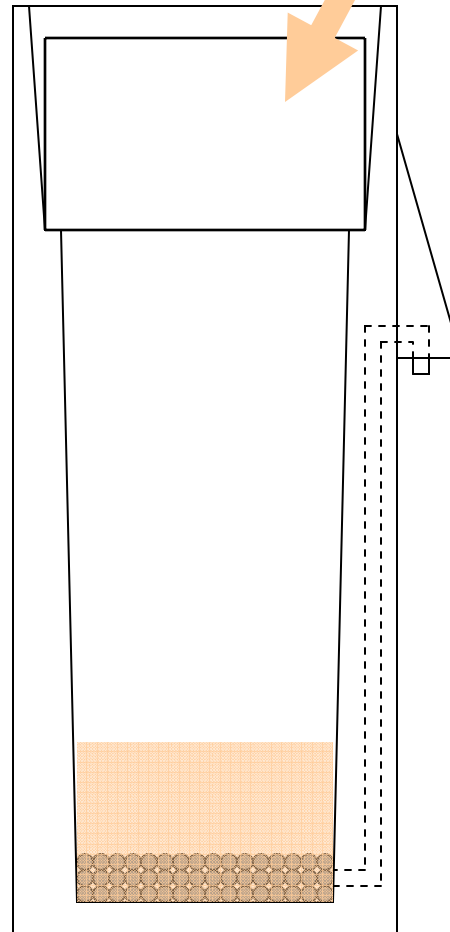

Step 6.
Remove Diffuser.

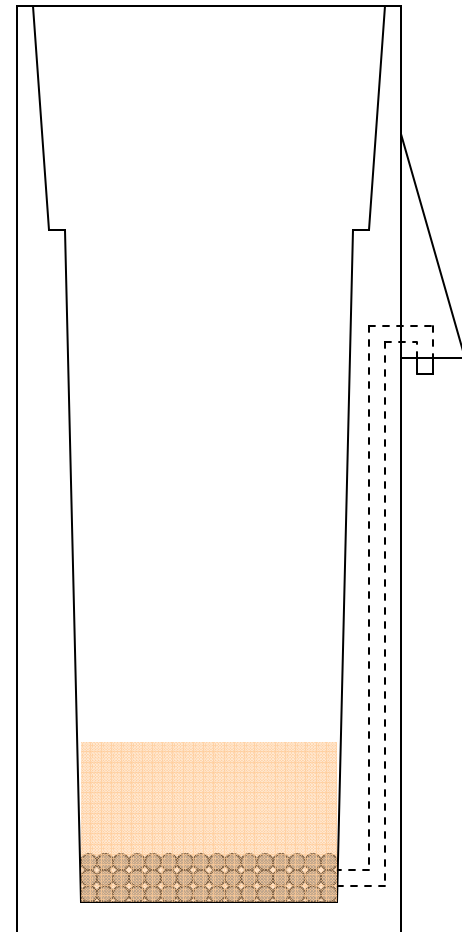

Installation of Separation Media Continued.

Step 7.

Add Separation Media.

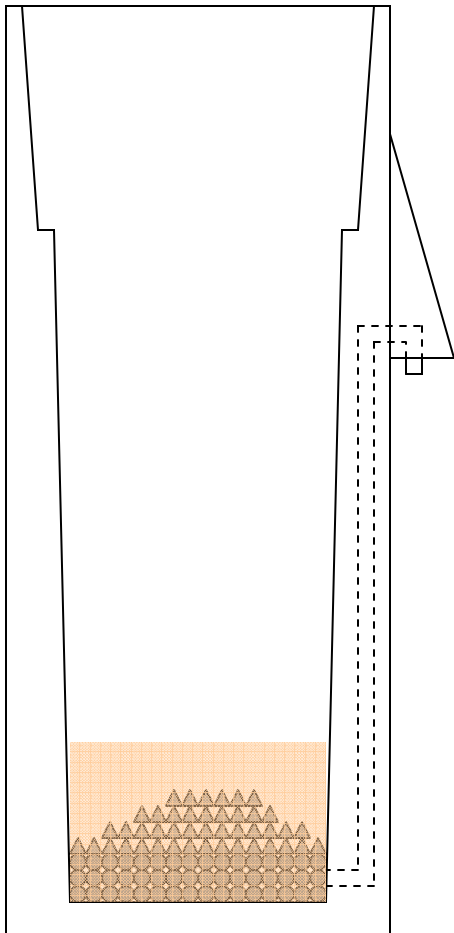

Step 8.

Level Separation Media

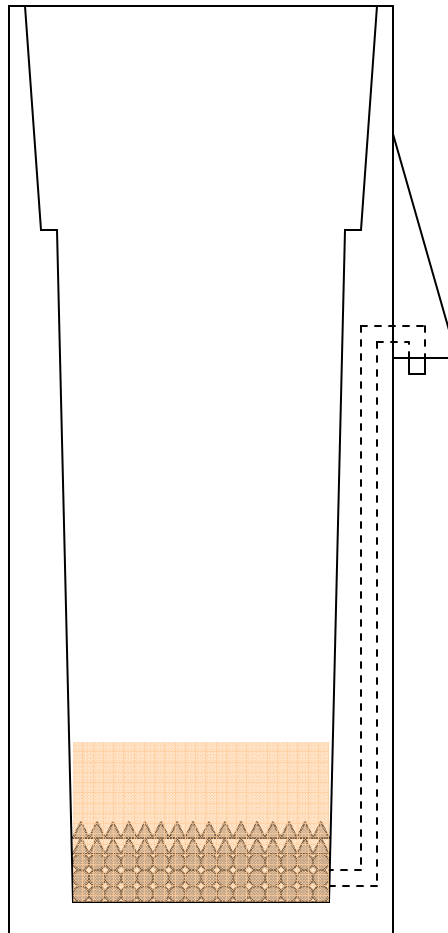

Step 9.

Check and adjust thickness as required.

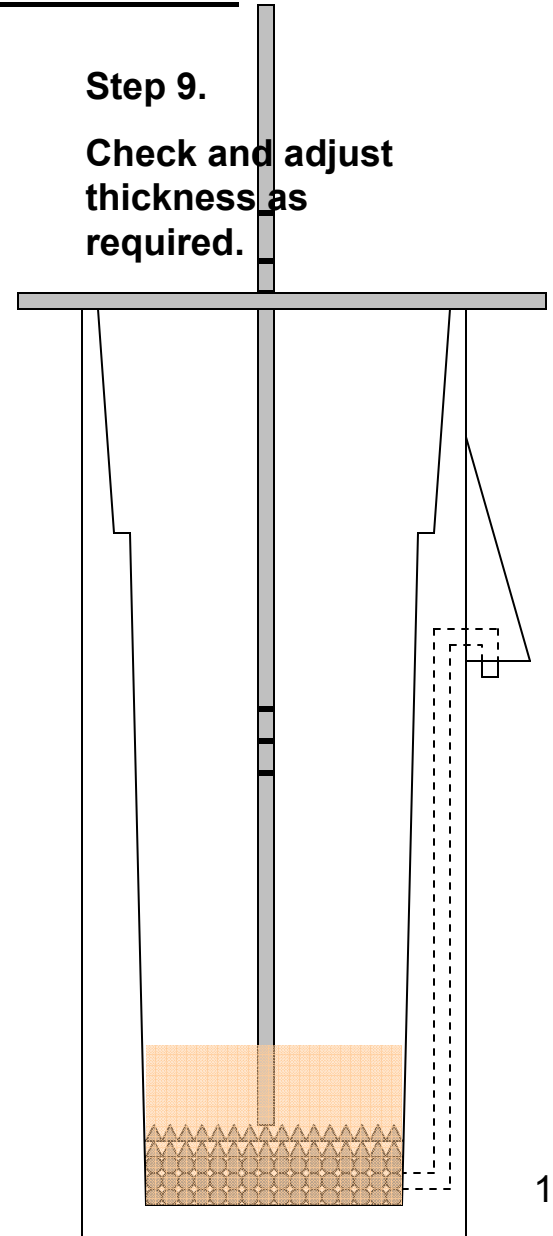

Installation of Fine Filter Media.

Step 10.
Placing Diffuser.

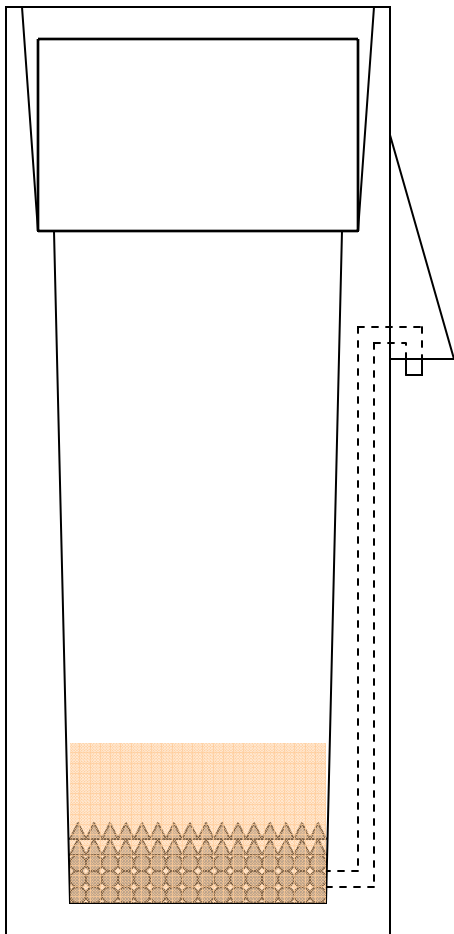

Step 11.
Add Untreated
Water.

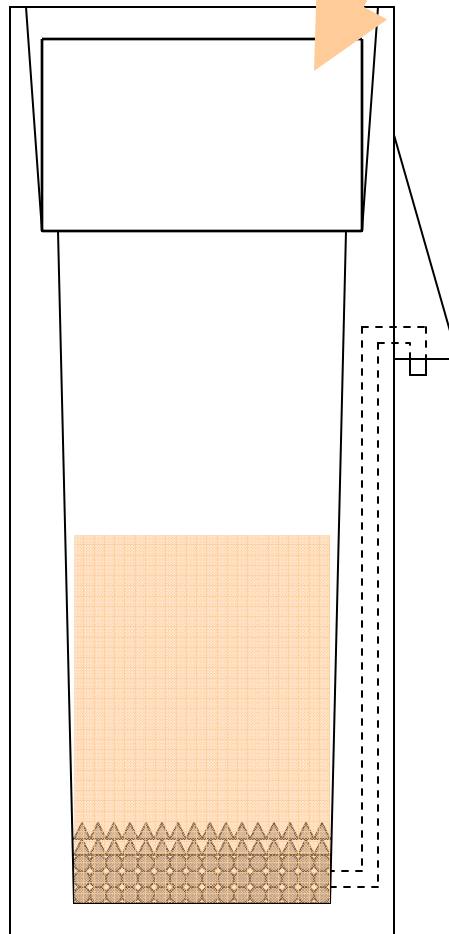

Step 12.
Remove Diffuser.

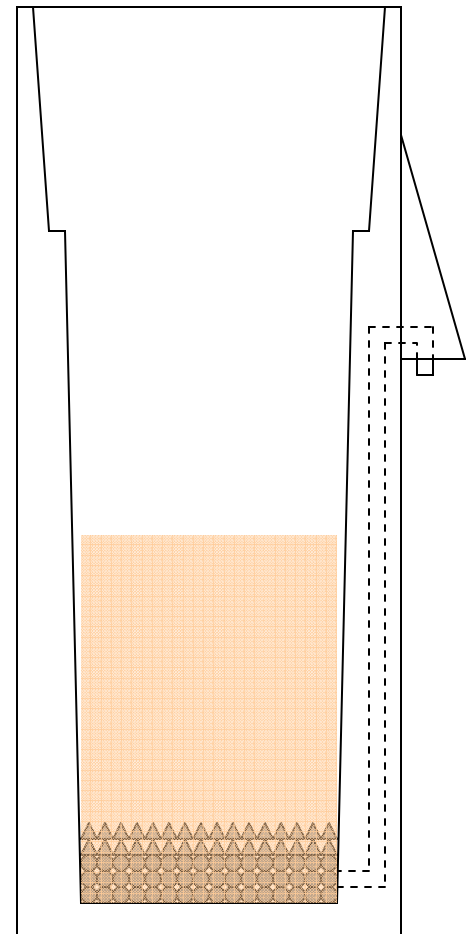

Installation of Fine Filter Media.

Step 13.

Rapidly add 1/3 to 1/2 of fine filter media.

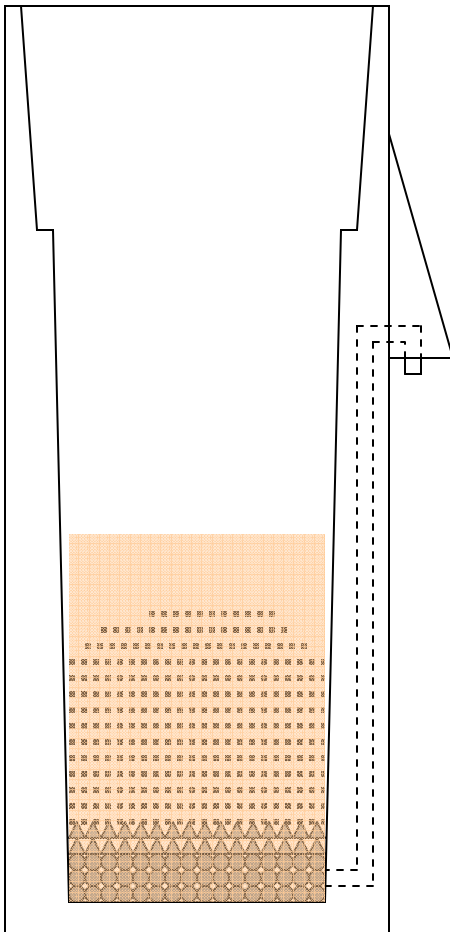

Step 14.

Placing diffuser.

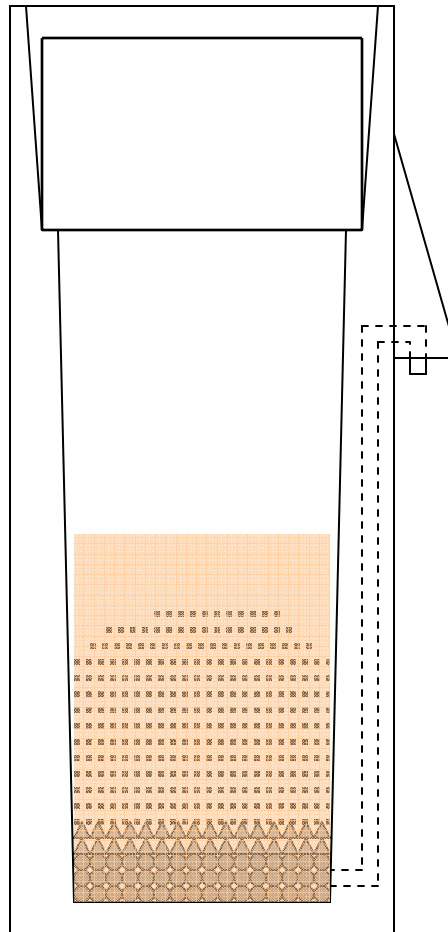

Step 15.

**Adding untreated water to filter.
(Note that some water may start flowing from filter outlet.)**

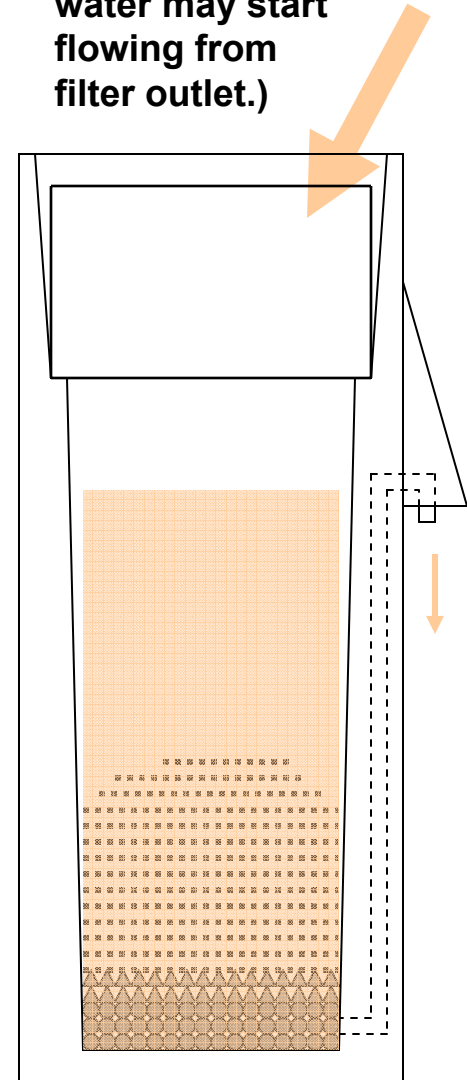

CAUTION.

Do not add too much water or add media too slowly or media will stratify as it is poured into the filter.

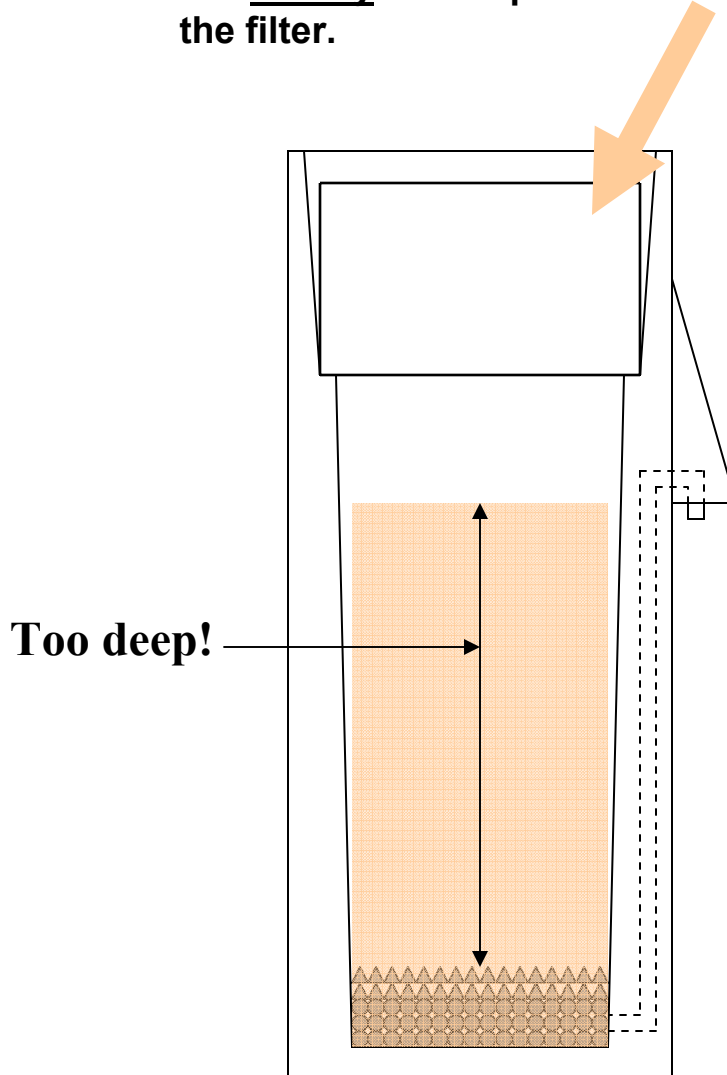

Stratification of Media

If media is added slowly to a deep water column the larger particles have time to settle first followed by the finer particles forming layers.

The effect is to dramatically decrease flow.

Should this occur the only remedy is to remove the filter media and discard as it can no longer be used.

New filter media can then be added according to the preceding instructions.

Step 16.

Remove diffuser.

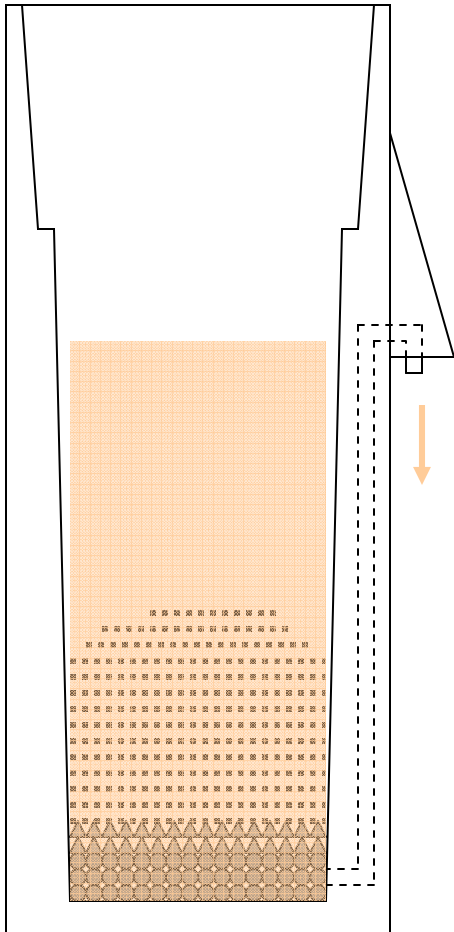

Step 17.

Rapidly add more fine filter media.

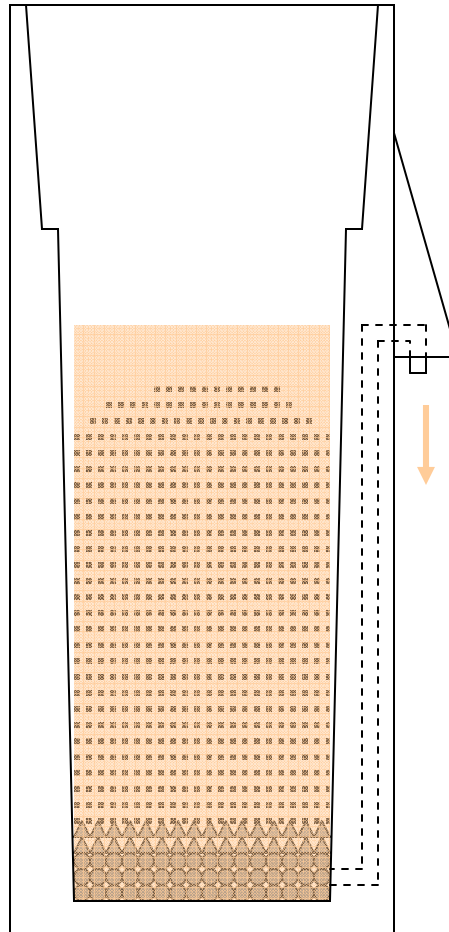

Step 18.

Level surface of fine filter media.

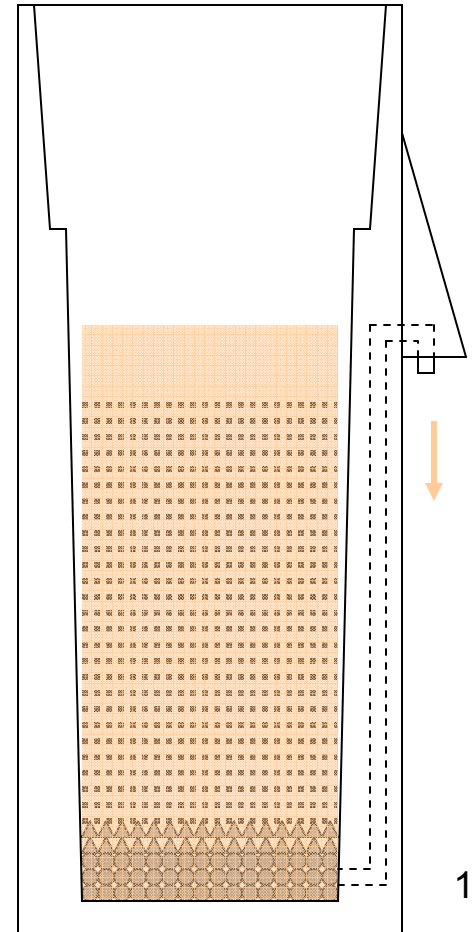

Step 19.
Check and adjust
depth of fine
filter media as
required.

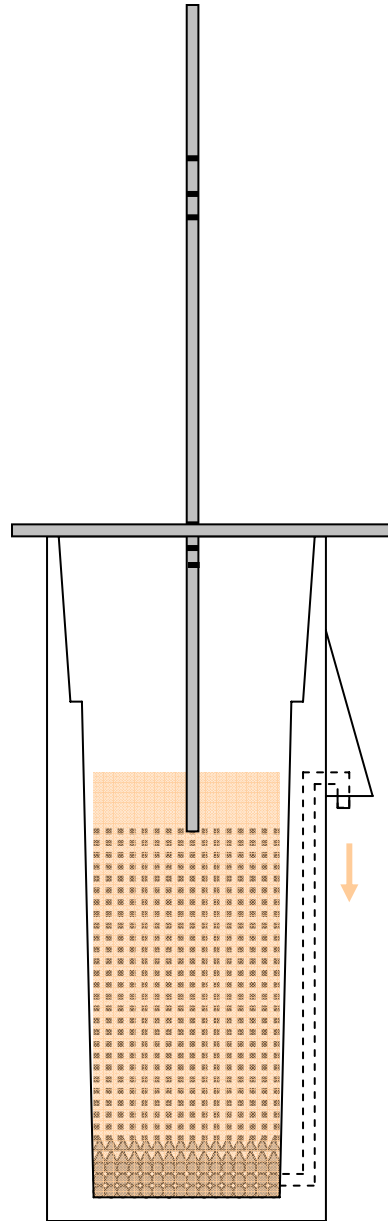

Installation of Very Fine Filter Media.

Step 20.

Add very fine filter media.
(Add more water if necessary.)

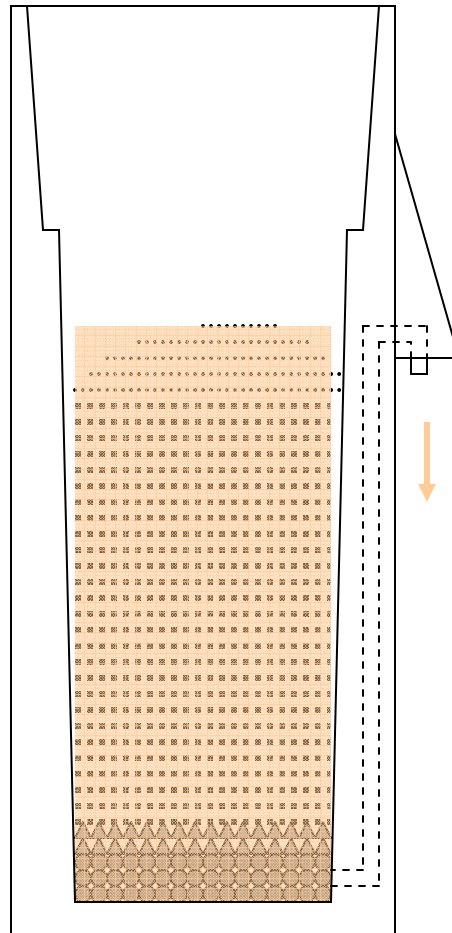

Step 21.

Level surface of very fine media.

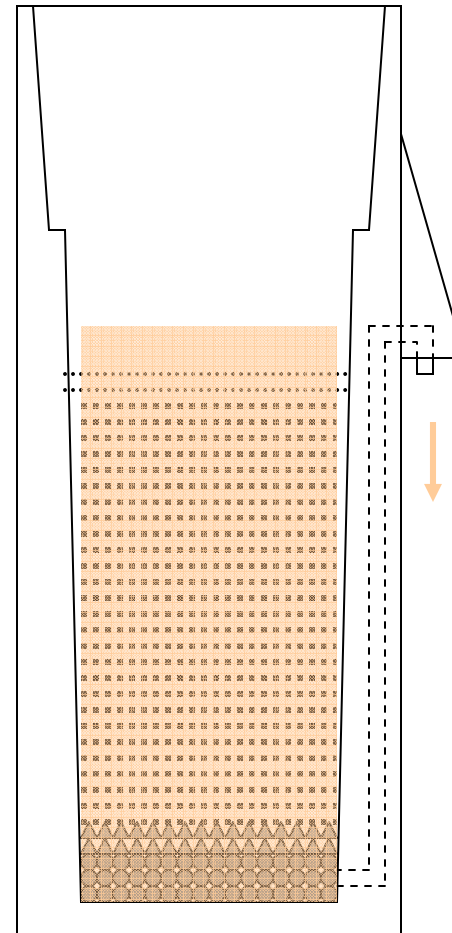

Step 22.

**Check and adjust
thickness of very
fine filter media as
necessary.**

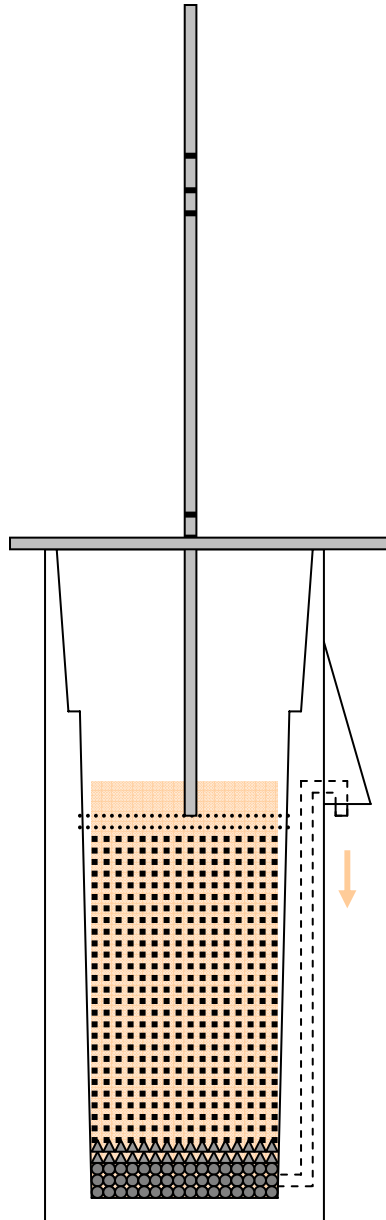

**All media has been placed
and is now ready to be
flushed of fines.**

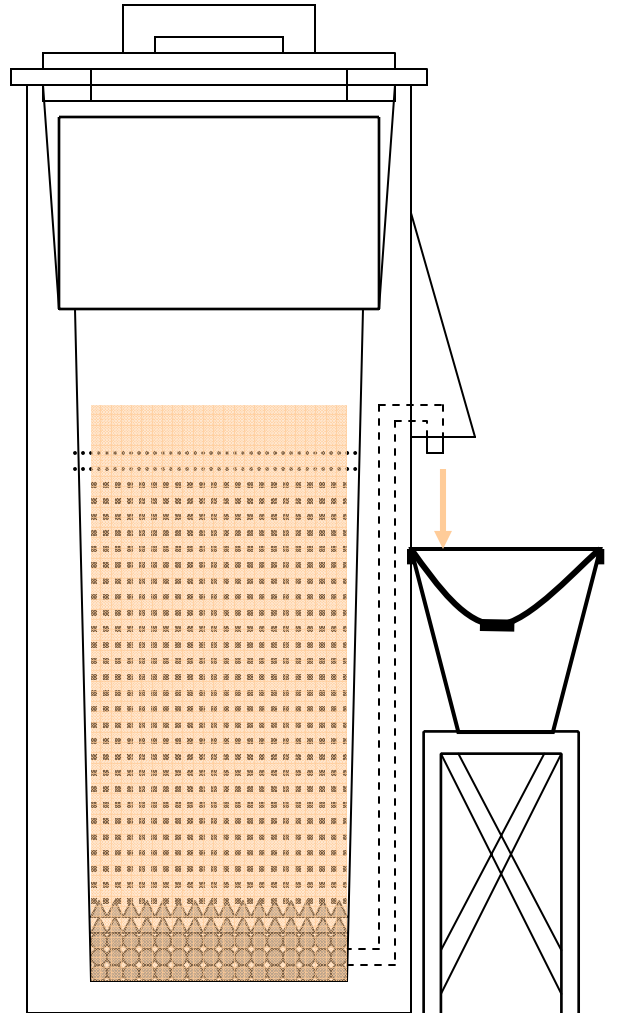

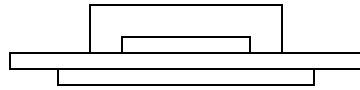

**Add 'raw' or
'untreated' water
from source.**

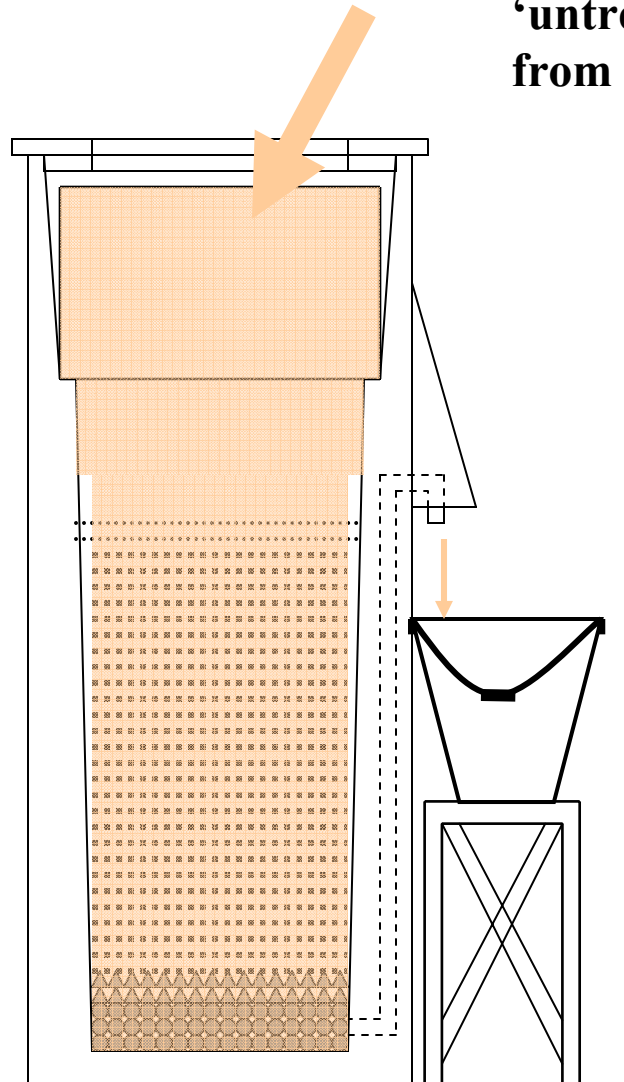

NOTE

**Water is ALWAYS
added through
diffuser through lid
so as not to disturb
media.**

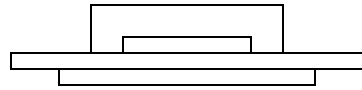

Untreated water added through lid.

Note that filtration occurs at or just below the 'surface' (within the top 1/2 cm of the actual surface) of the filter media.

Once water passes through the surface it is 'filtered'.

The filtered water moves down vertically as a 'plug'; that is the filtered water and untreated water do not mix.

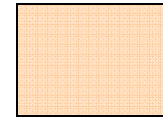
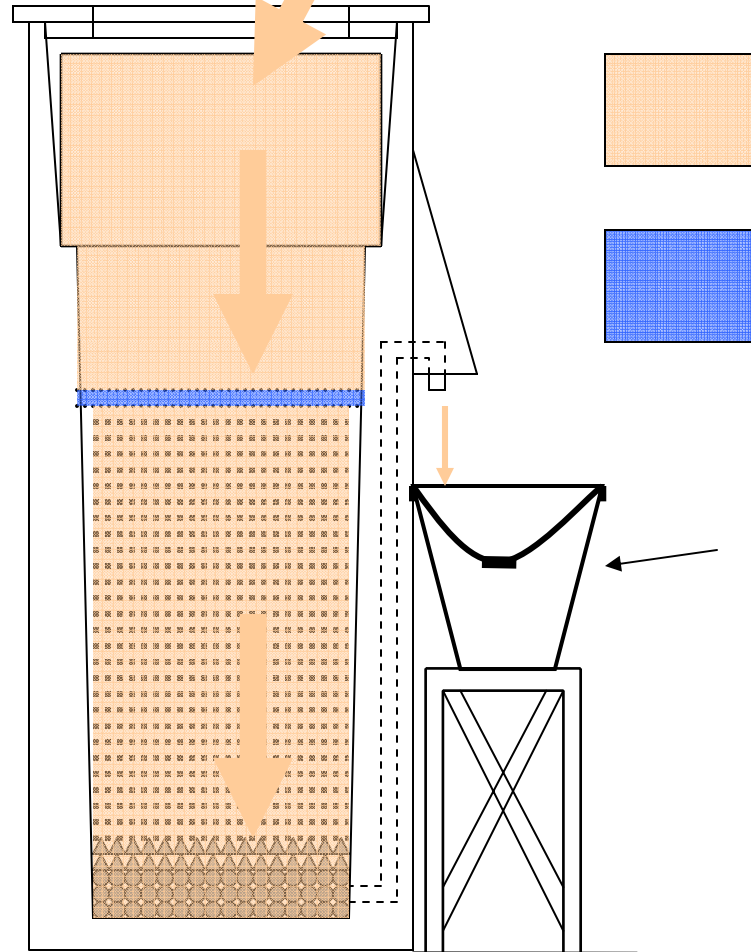

Untreated water.

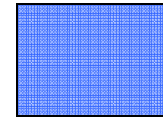

Filtered water.

Waste water should not be reused for flushing. It can be set aside to allow sediment to settle and then filtered for actual use.

Untreated water added through lid.

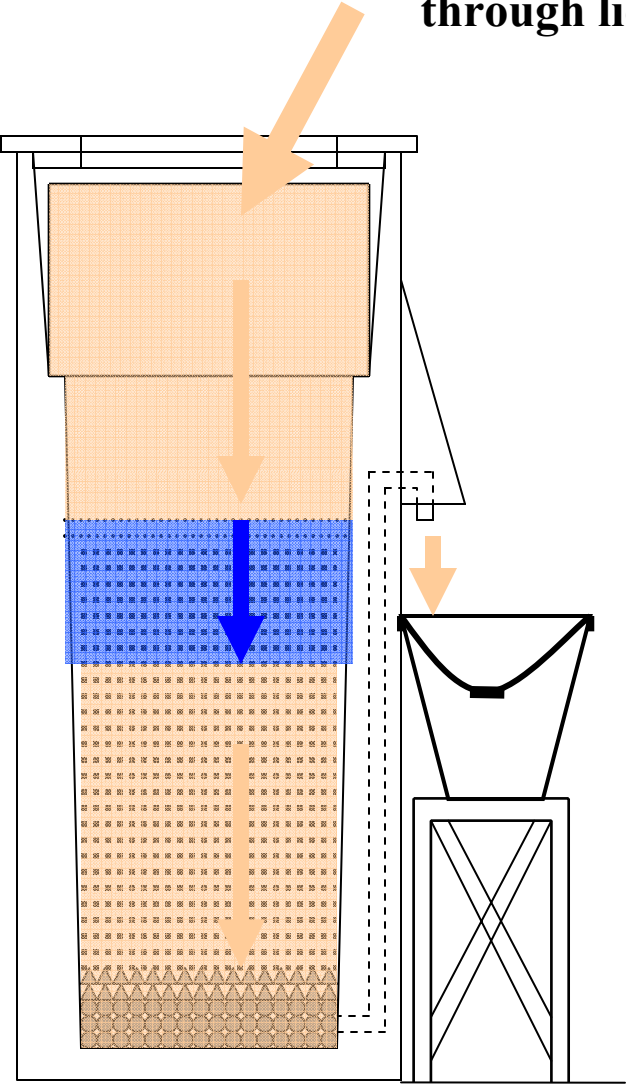

Zone of filtered water gradually increases in depth.

Untreated water added through lid.

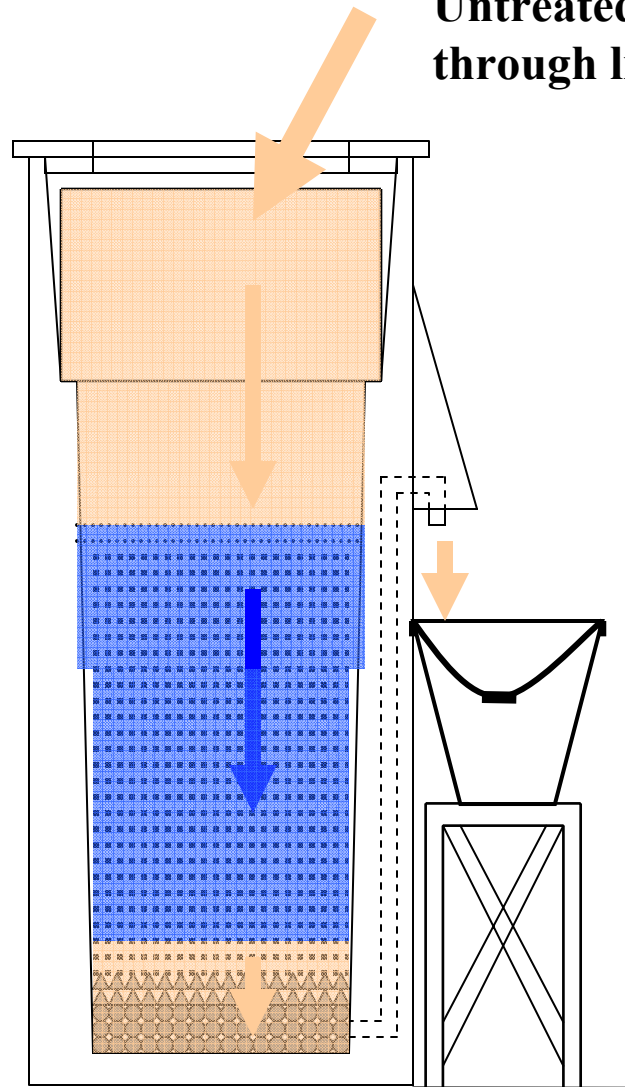

**Zone of
filtered water
gradually
increases in
depth.**

Zone of filtered water has completely displaced the untreated water in the media.

This process may take several ‘buckets’ of water. (Recall that water used for flushing can be allowed to clarify by letting the sediment settle after which it may be filtered and consumed.)

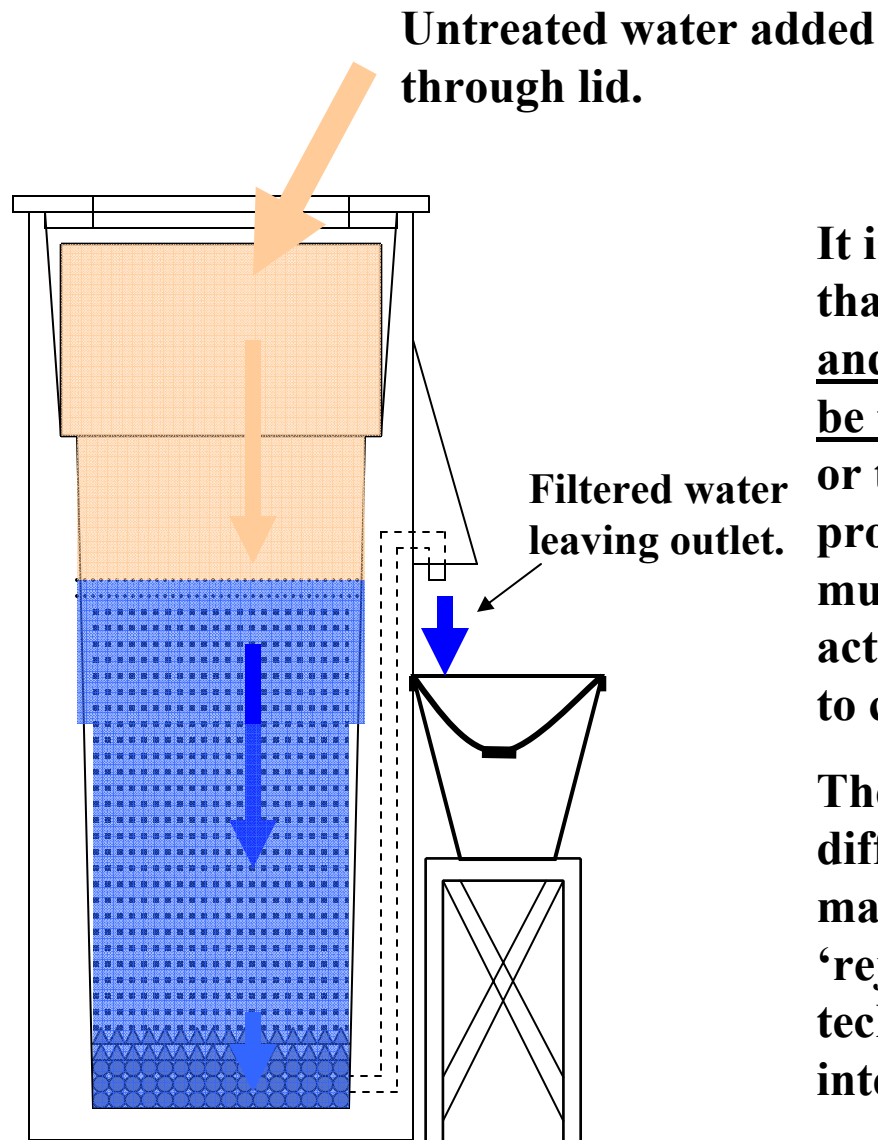

Note

It is very important that the underdrain and separation layers be thoroughly washed or the flushing process may require much more water and actually require days to complete.

The increased difficulty in flushing may result in ‘rejection’ of BSF technology by intended consumers.

After flushing the flow through the filter may be quite slow and cleaning will be required.

Initial cleaning procedure: Insure that there is approximately 15 cm of water on top of the media surface. Vigorously agitate the surface without penetrating the filter media more that 1/2 cm or so. At the beginning of the process the surface will 'feel' hard. After agitating it will feel soft.

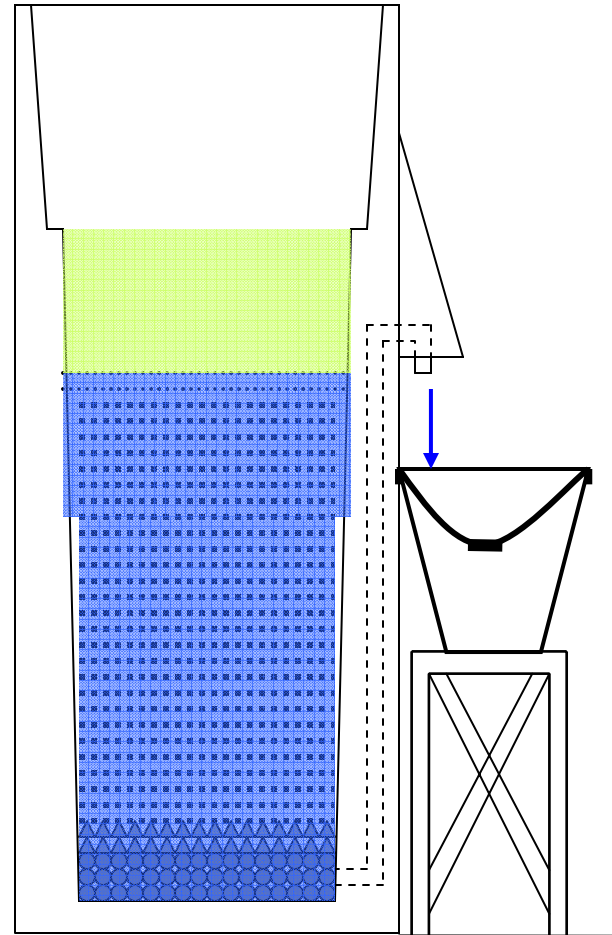
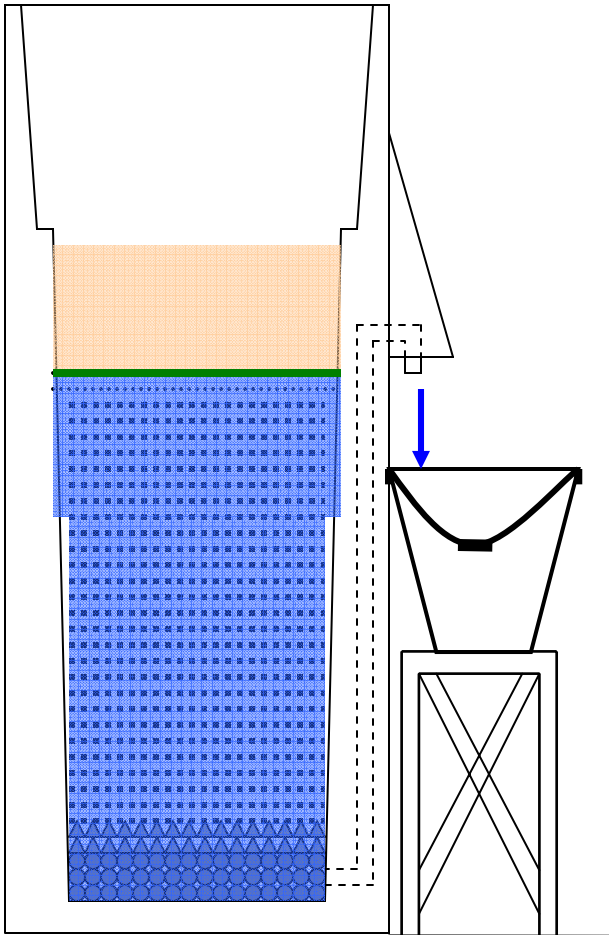

Water is removed from the filter using a ladle or cup and the surface of the media is carefully leveled.

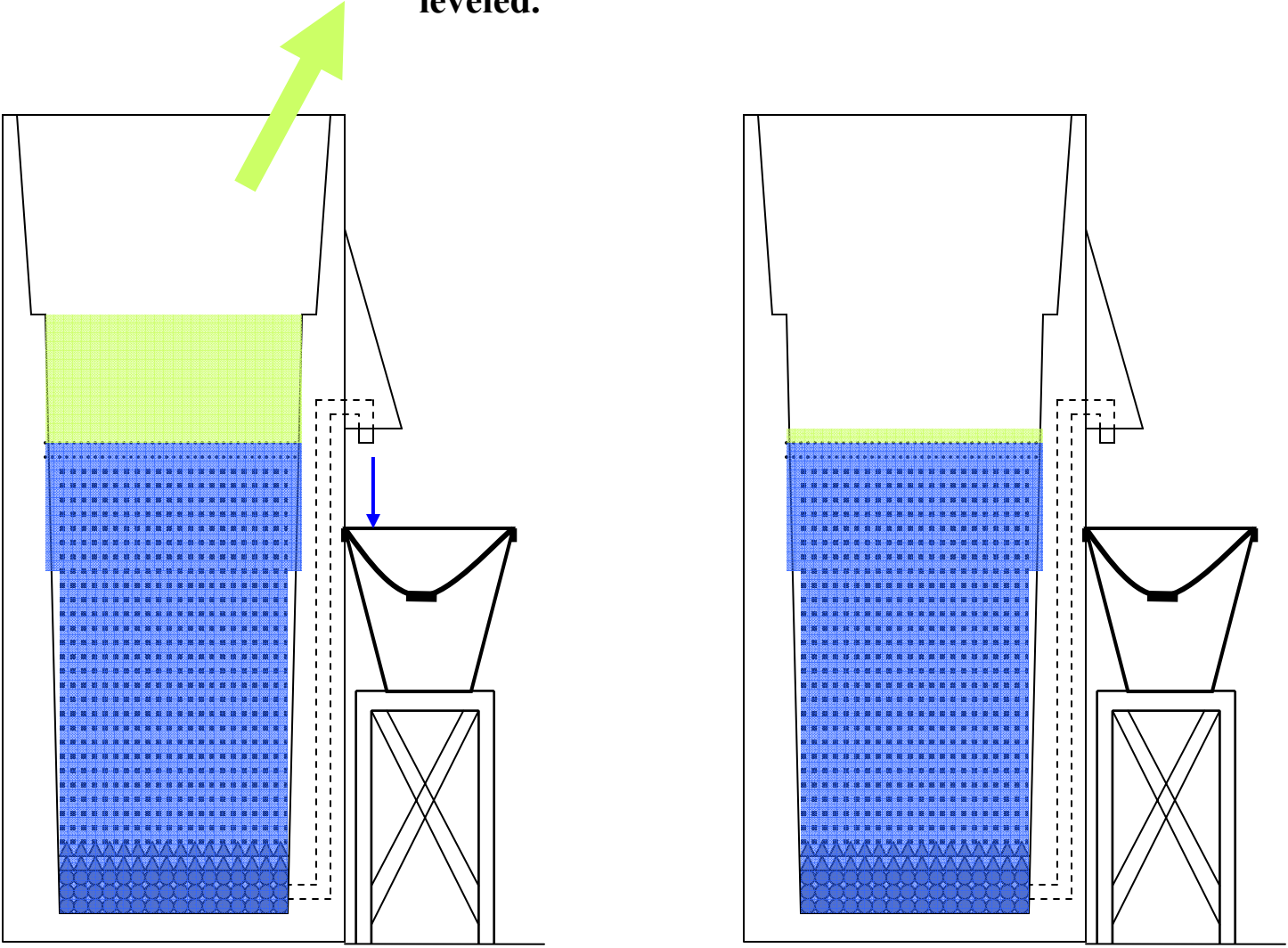

Final Adjustment of Flow through Filter.

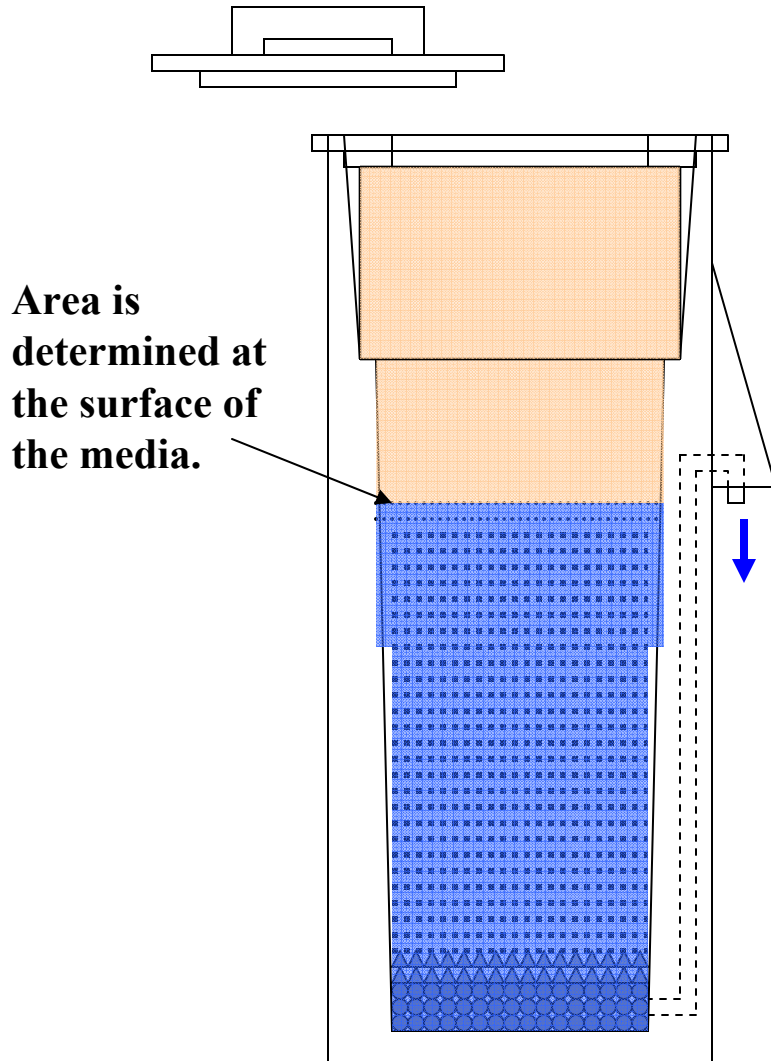

Maximum flow rate through the filter measured in litres per hour should be equal to the area of the top surface of the media (measured in square metres) times 400.

Example:

Area = 0.09 square metres

**Maximum flow rate = 0.09×400
= 36 litres per hour.**

Final Adjustment of Flow through Filter.

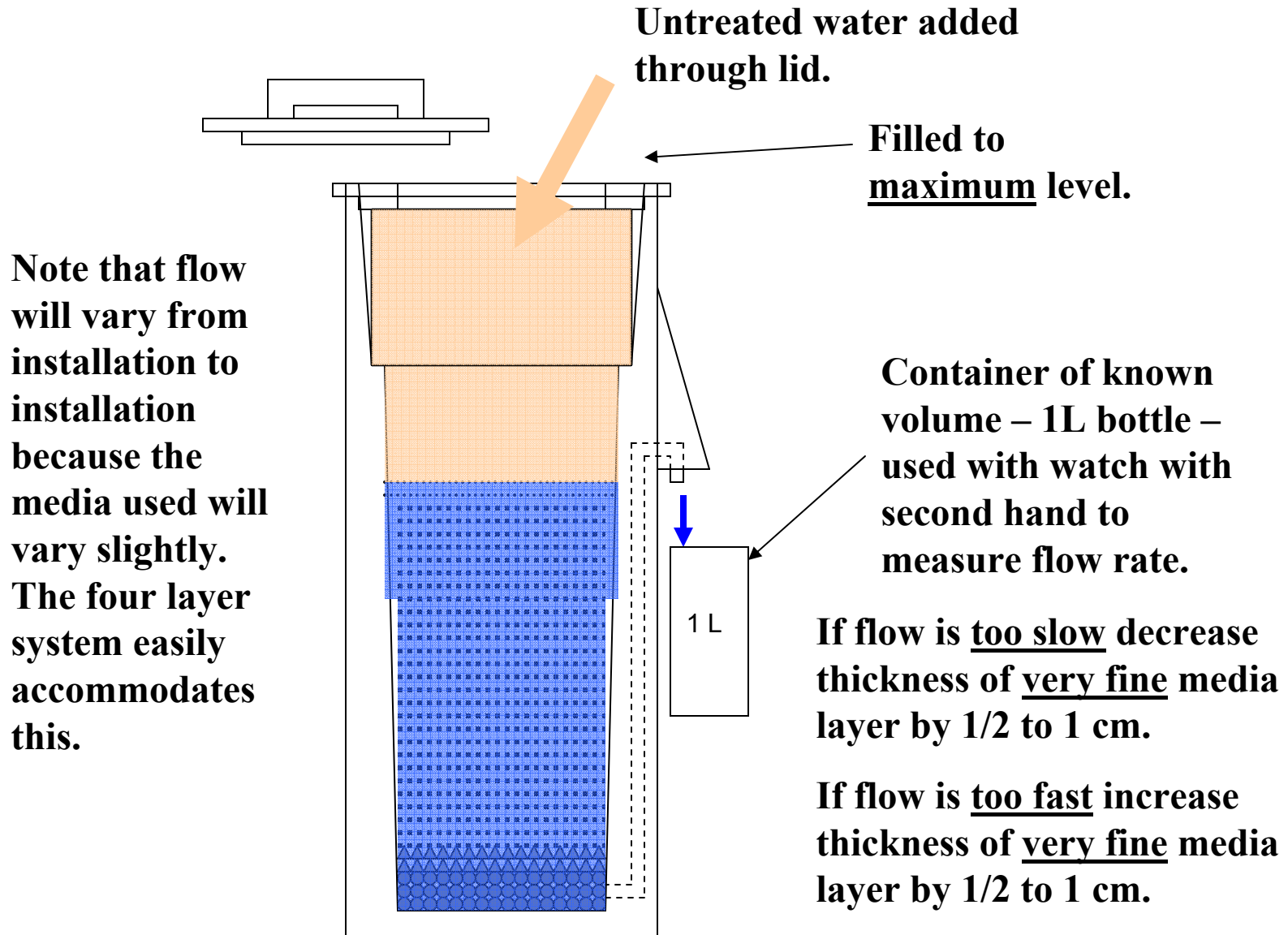

Disinfection of Filter Standpipe.

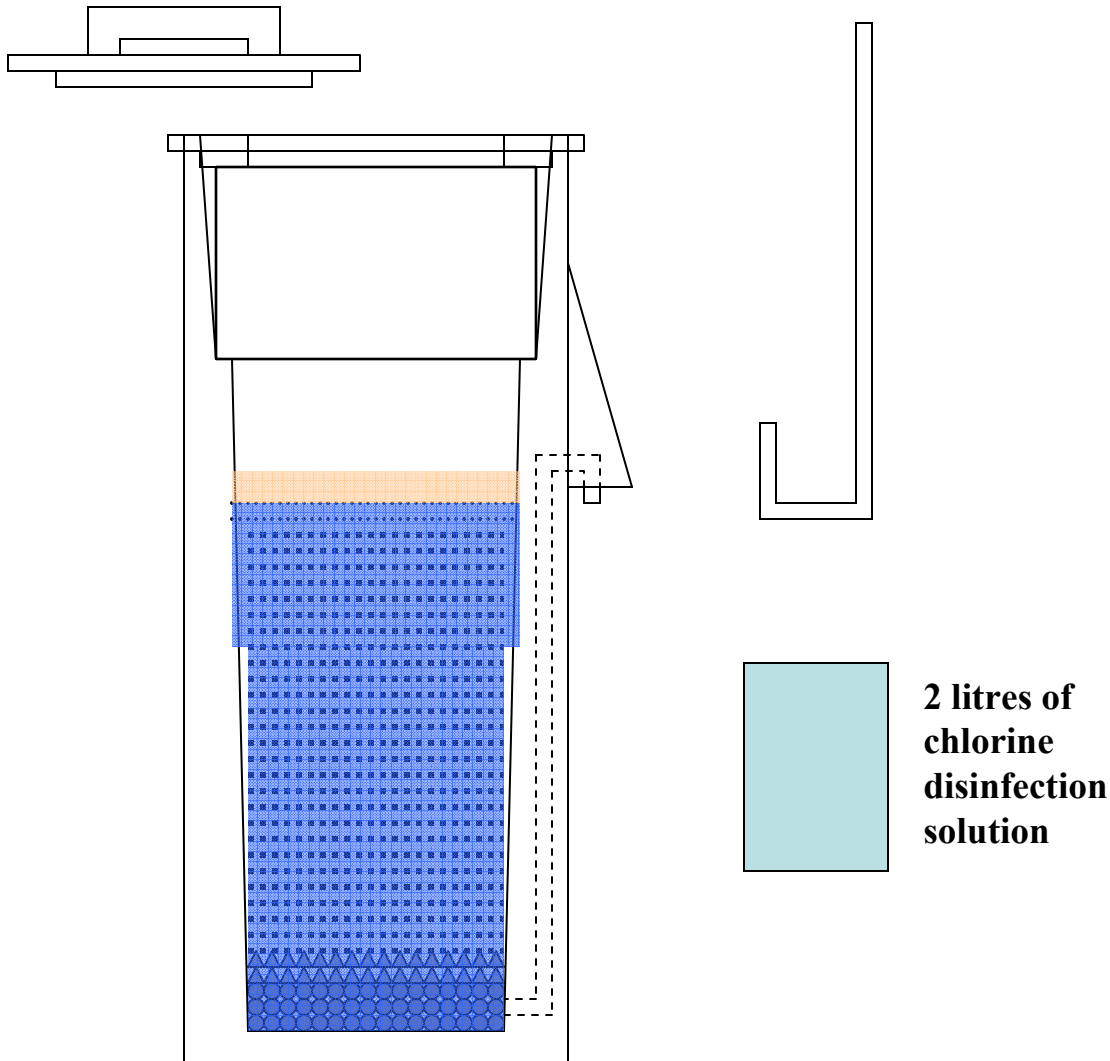

Construct a disinfection tube as shown. This will attach to the filter outlet and extend above the filter lid as shown.

Prepare a disinfection solution using unperfumed, liquid household bleach.

Disinfection of Filter Standpipe.

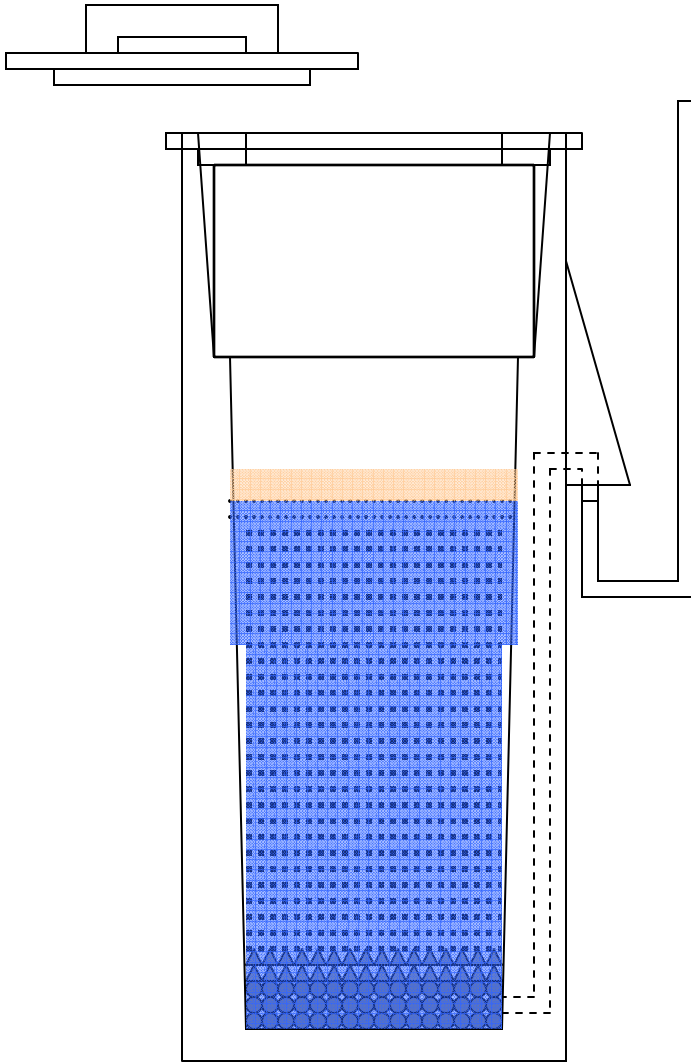

**Attach disinfection
tube to filter outlet.**

Disinfection of Filter Standpipe.

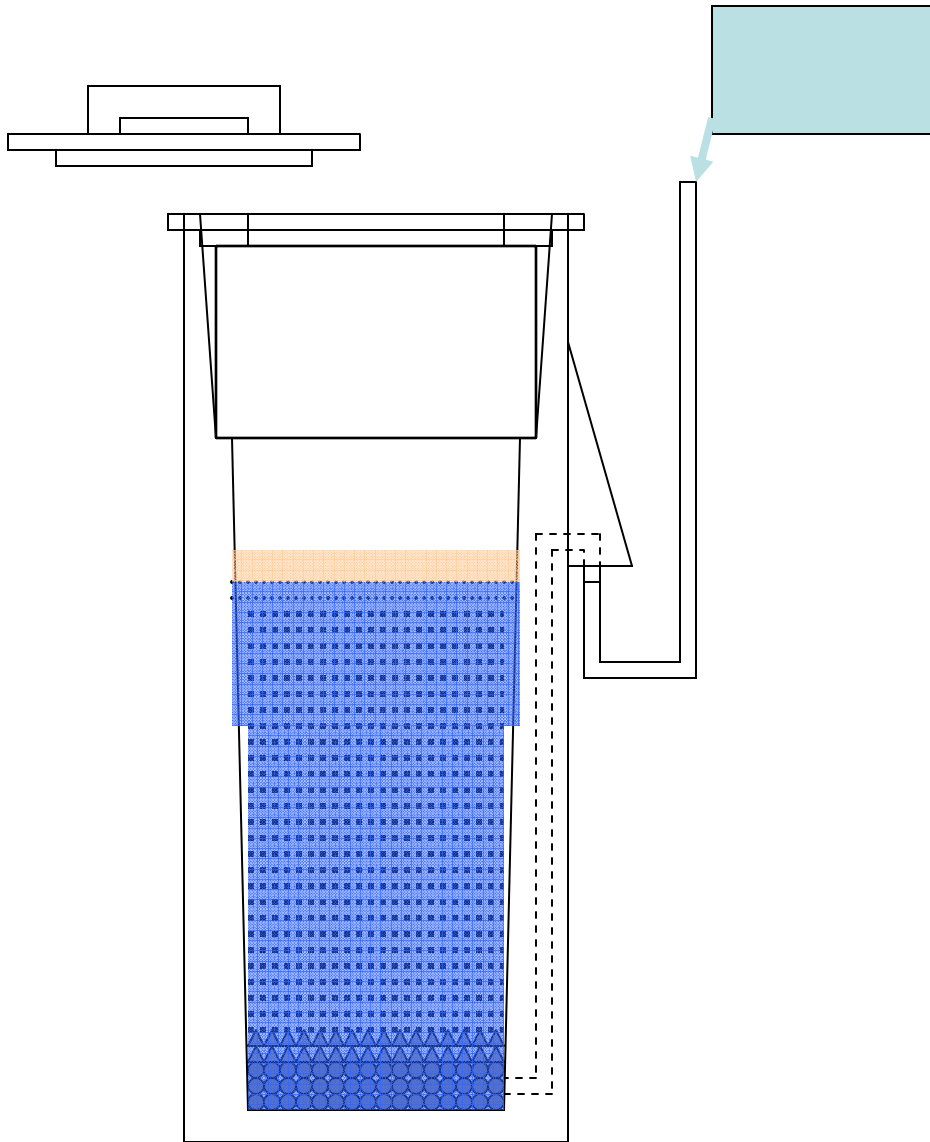

Pour disinfection solution into top of disinfection tube and leave for 20 minutes or more.

Disinfection of Filter Standpipe.

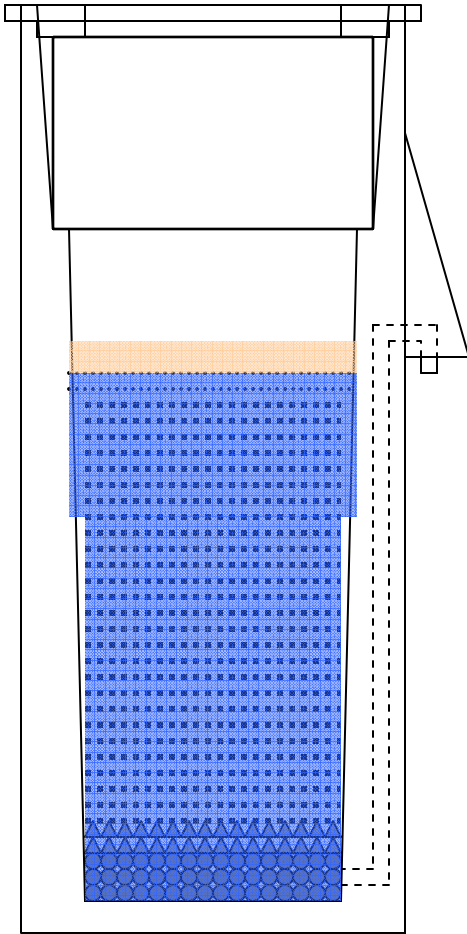
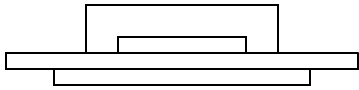

Remove disinfection tube.

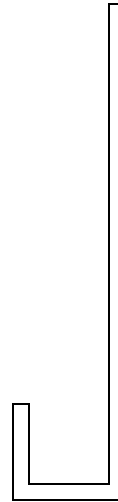

Disinfection of Filter Standpipe.

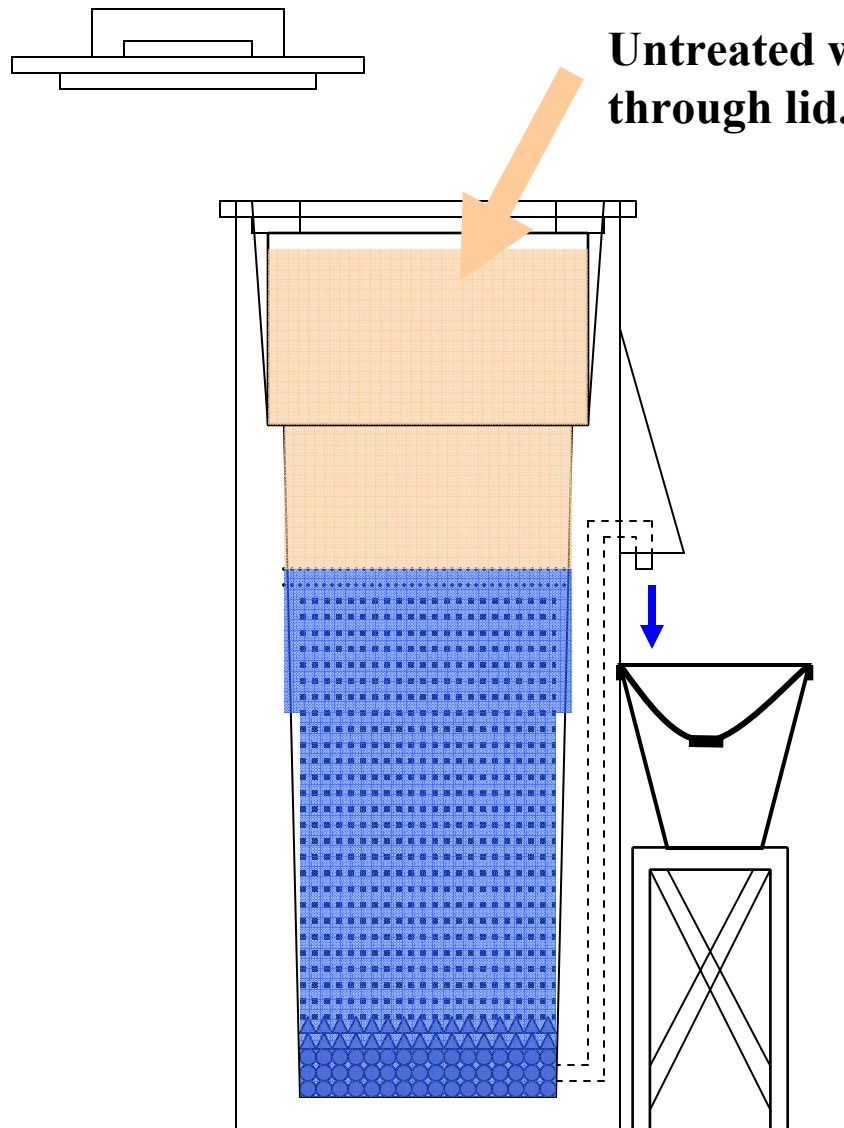

Untreated water added through lid.

Flush with one or two buckets of untreated water. Water coming from the filter will have a strong chlorine taste and smell. The chlorine will leave the water if it is allowed to stand overnight.

Filter is Ready for Use.

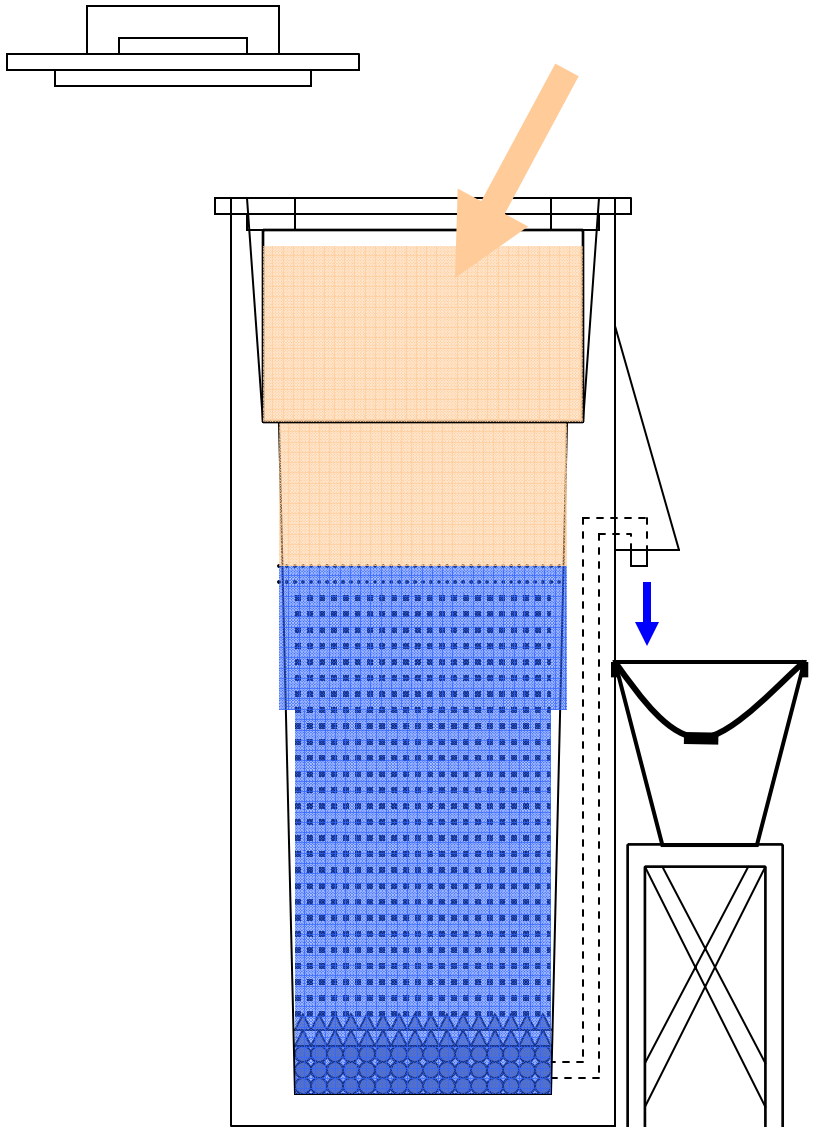

Disinfection of Filtered Water

Filtered water will gradually improve in quality with use provided media is prepared as recommended.

100% of parasites and larger organisms are removed immediately.

Initially, bacteria and viruses will be removed at a rate of 60% gradually increasing to 95% or more as the biological layer forms on the media surface. See following graph illustrating development of biolayer.

Disinfect filtered water using dilute solution of liquid, unperfumed, chlorine bleach or using chlorine tablets is recommended.

Operation of BSF.

Beginning of operation of the BSF – no biofilm around particles and no biolayer.

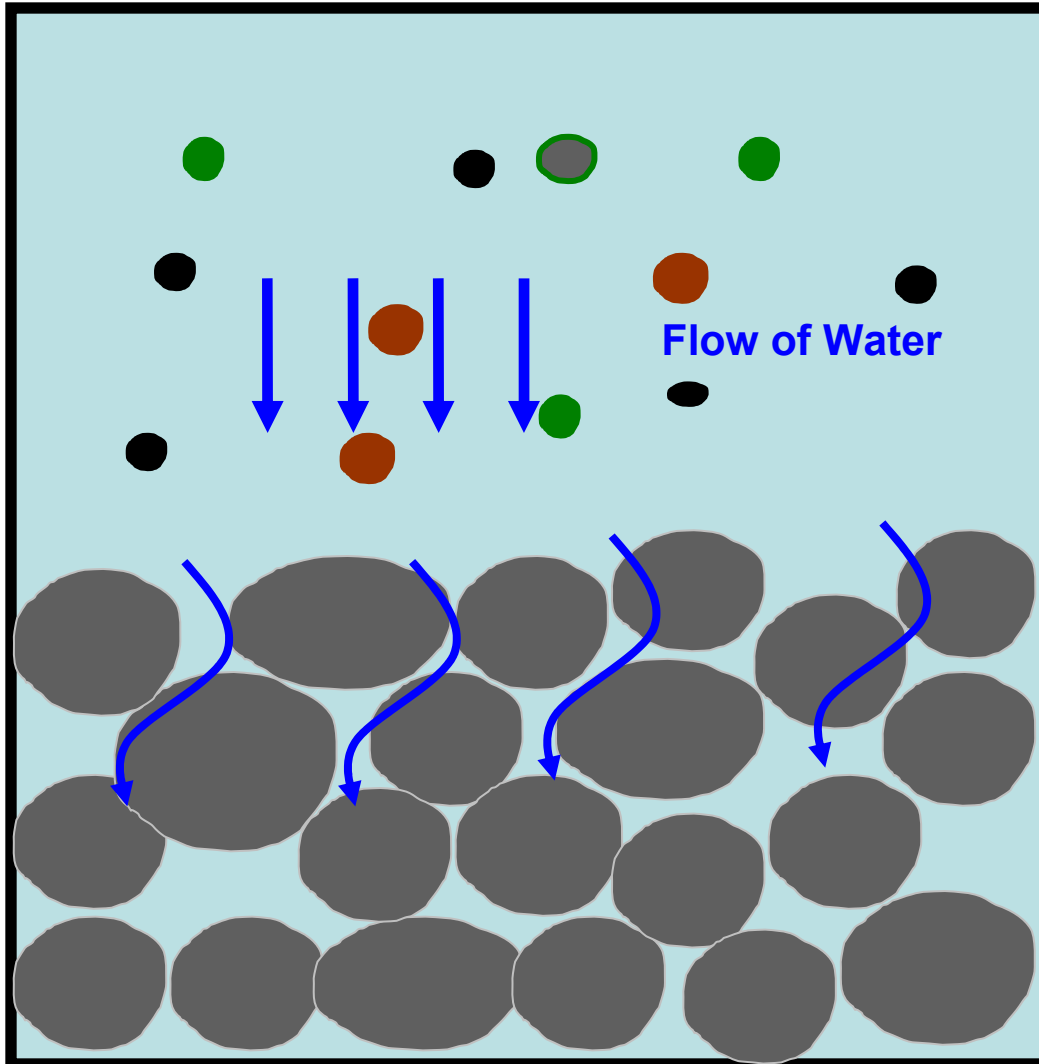

 Media particle without surface biofilm.

 Other mineral and organic particles or flocs of particles.

 Also includes large living organisms such as algae, helminthes and the cysts of parasites.





Operation of BSF.

Beginning of operation of the BSF

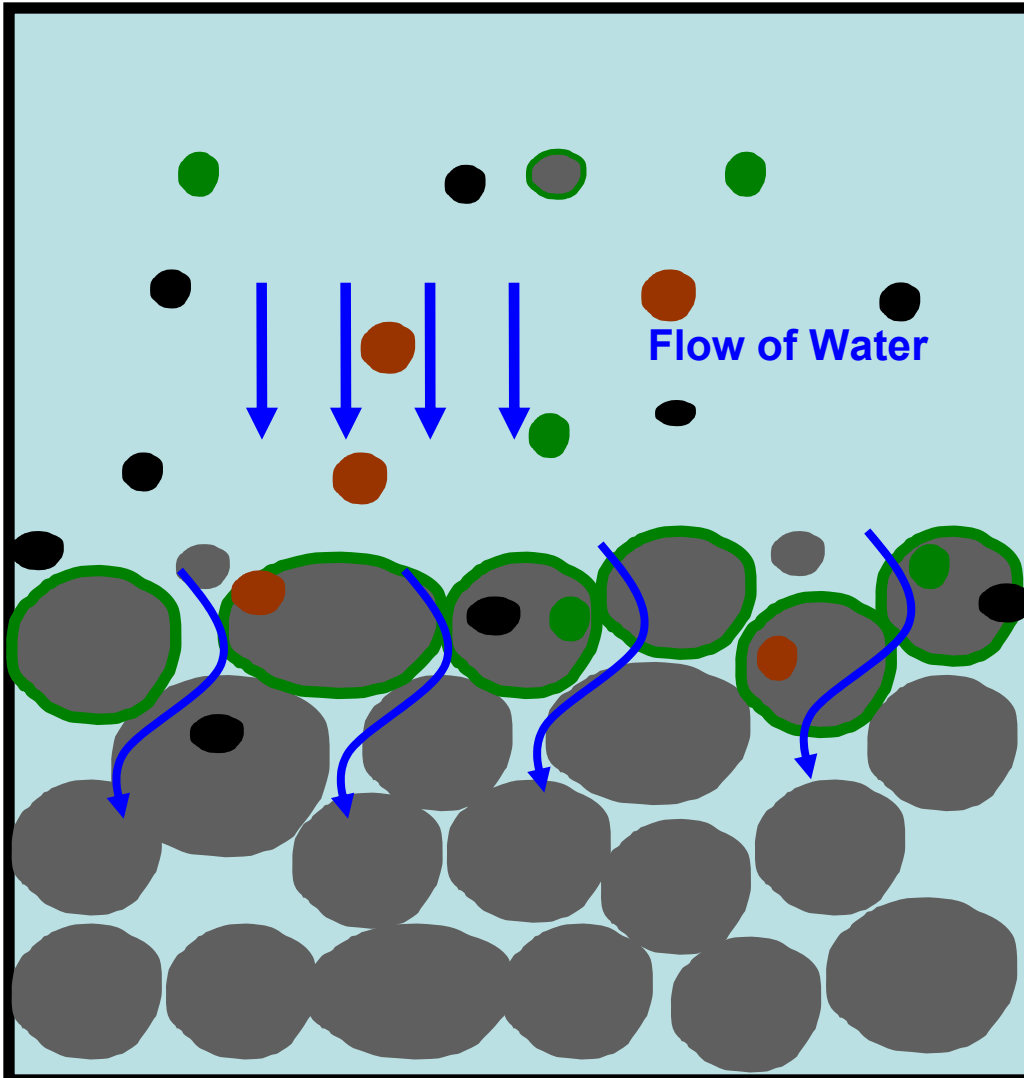

No biolayer is necessary for removal of parasites and larger organic material and mineral particles including oxidized iron and manganese.

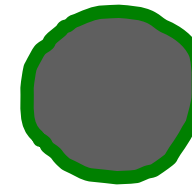

Media particle covered with a surface biofilm including bacteria and organic matter.

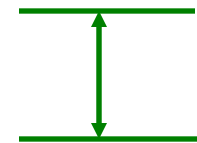

Biolayer (Mineral particles covered with a biofilm).

Formation of biofilm on the mineral particles is exactly the same as that observed in 'trickling filters' used for aerobic treatment of wastewater. ³⁹

Operation of BSF.

Biolayer thickens with use and time.

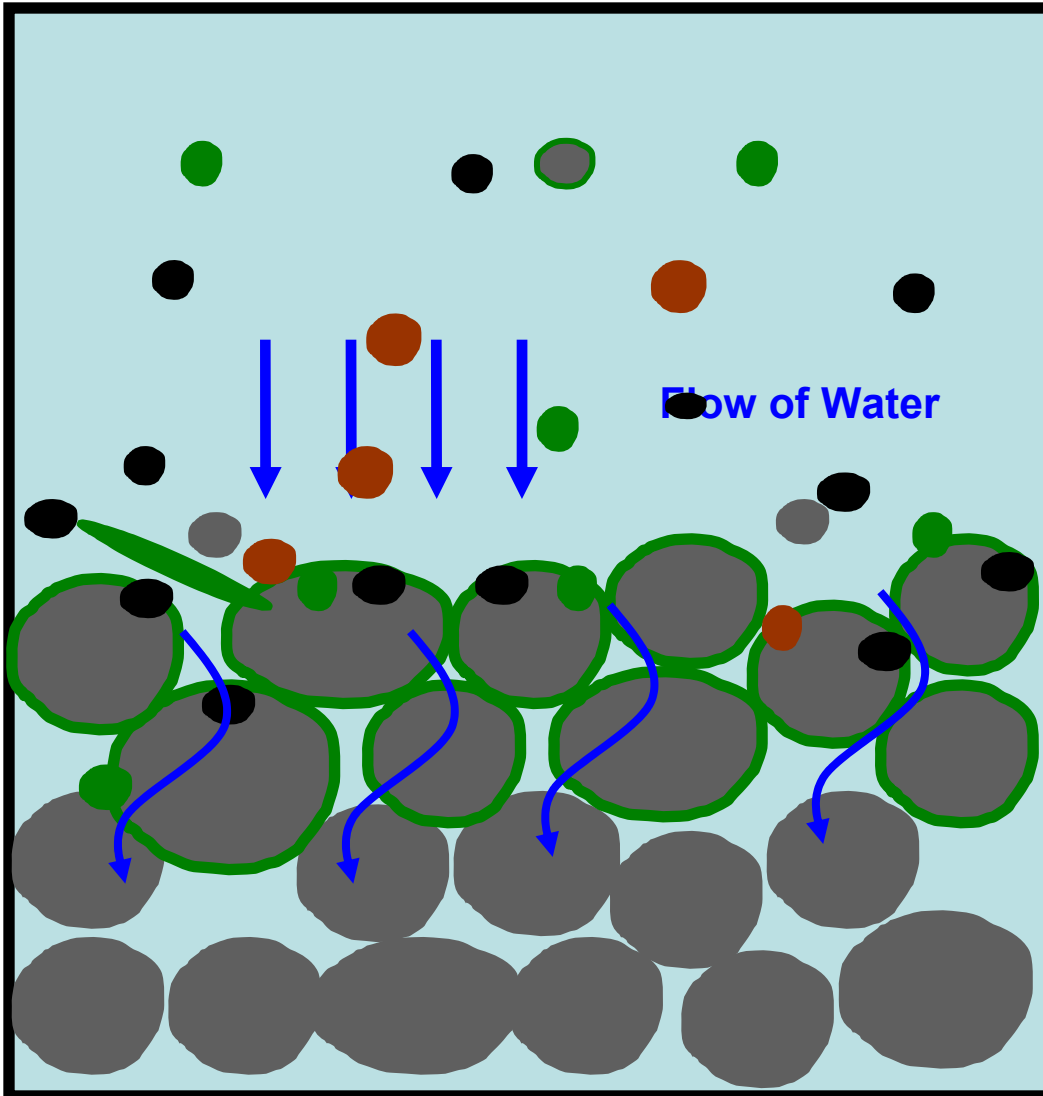

Biolayer
thickens.

Operation of BSF.

Biolayer thickens with use and time.

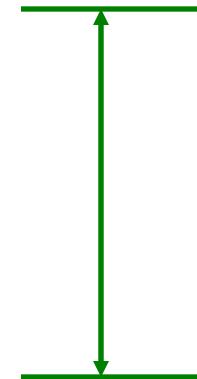
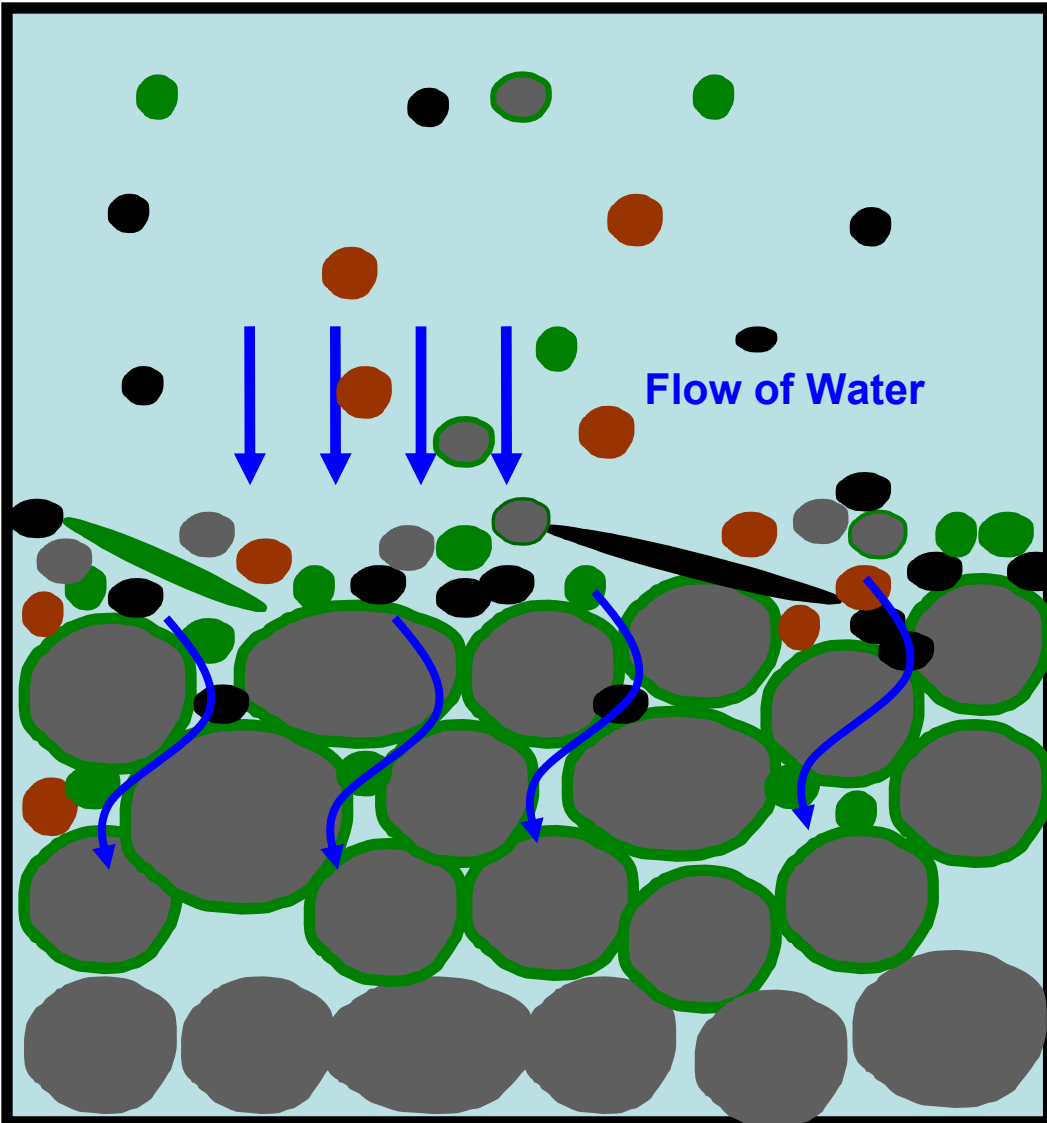

**Biolayer
thickens and
captured
material
accumulates.**

Operation of BSF.

Biolayer thickens with use and time.

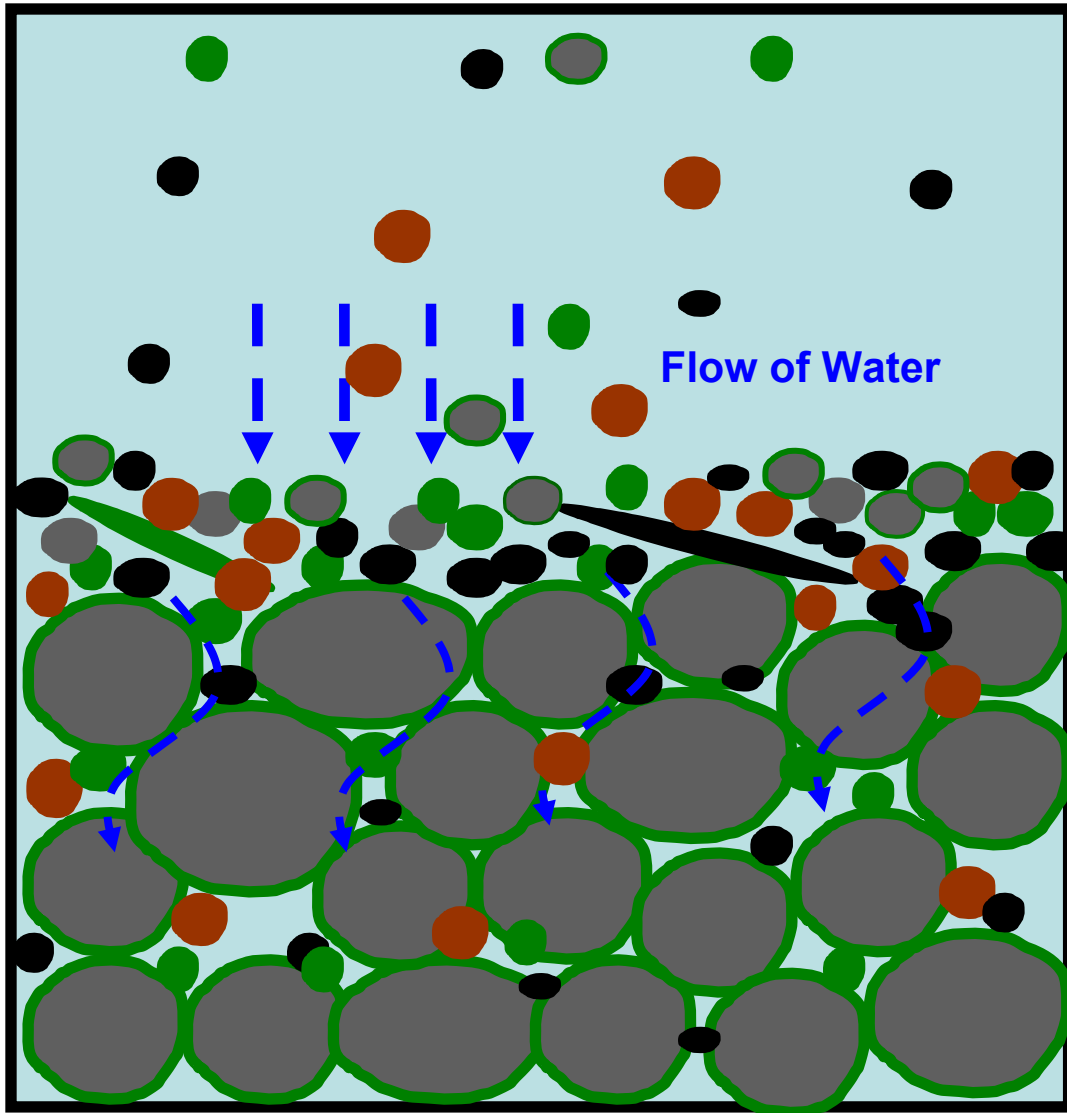

Biolayer
thickens and
captured
material
accumulates
and starts to
restrict flow.

Operation of BSF.

Biolayer thickens with use and time.

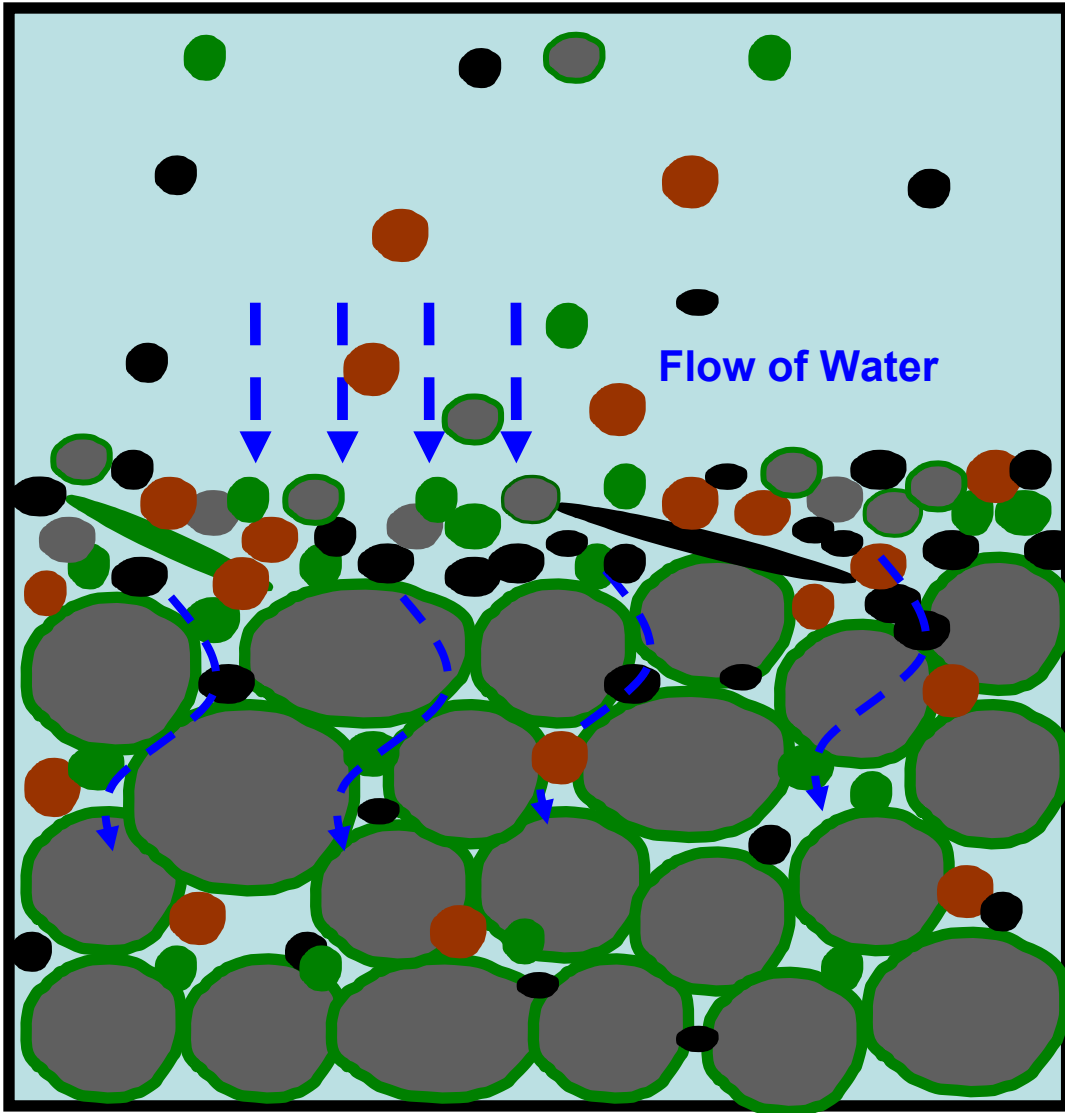

Formation of biolayer will depend on the ecology of the water being treated and the quantity of water being treated. The greater the concentration of aquatic life and the greater the quantity of water being treated the faster the biolayer will form.

Biolayer
thickens and
captured
material
accumulates
and starts to
restrict flow.

Typical Performance of a BSF Water Filtration Technology

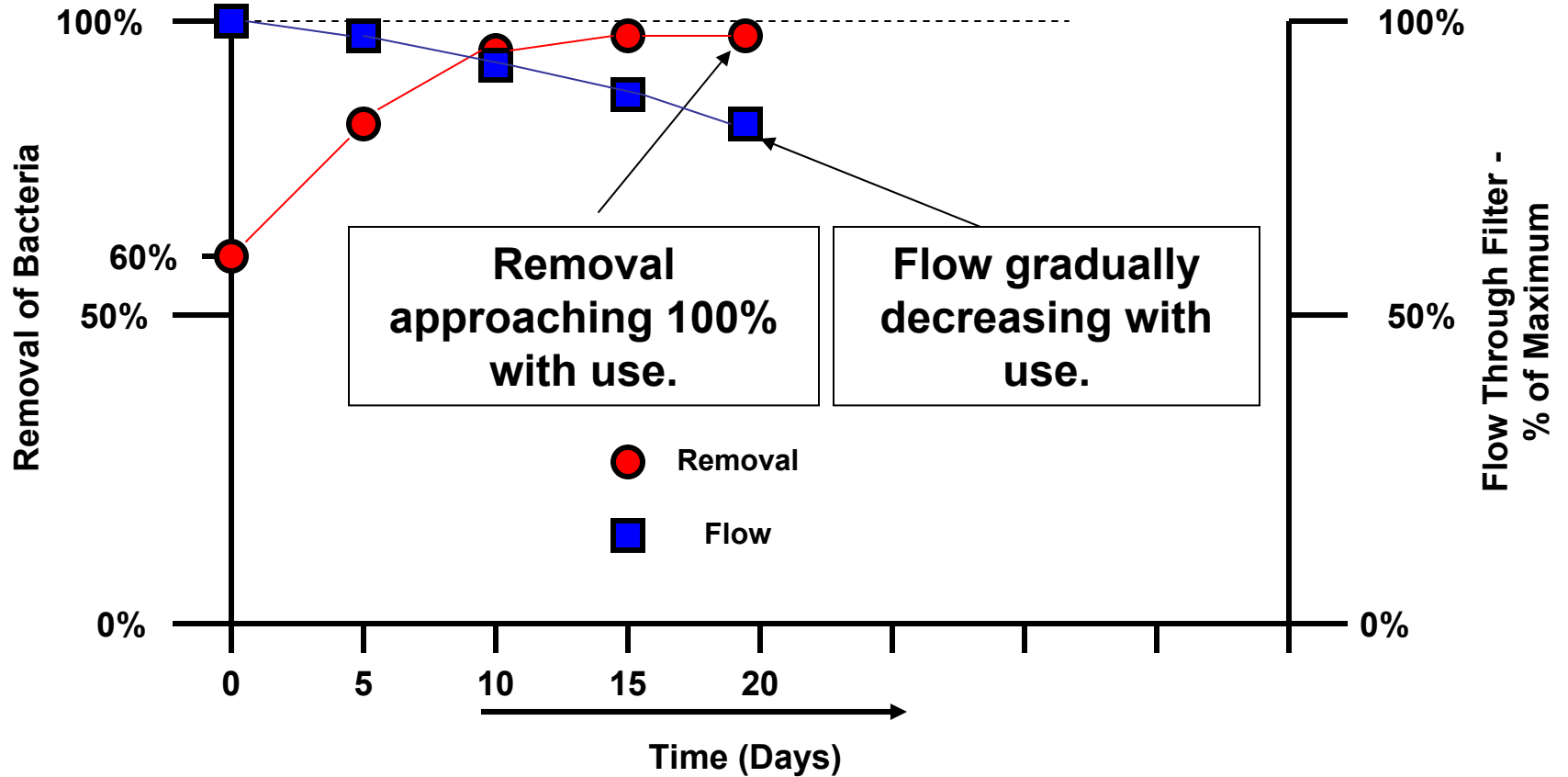

Comments

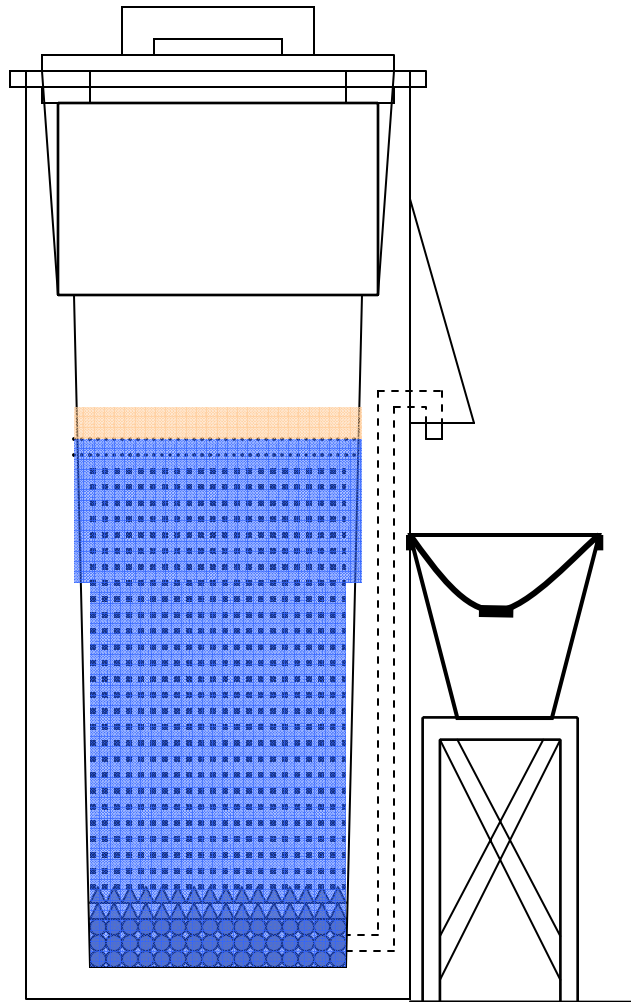

1. Use of accelerants to speed-up development of biolayer. There is no practical way of ‘accelerating’ the development of the biological layer. Adding water that contains large concentrations of dissolved organic material will result in ALL of the media particles in the filter to be coated with what amounts to ‘food’ for bacteria. The resulting performance of a filter treated in this manner would be similar to that of filter filled with contaminated media. Initially and for a very long (unpredictable) time the concentration of bacteria in filtered water will be greater than that of the untreated water being added to the filter.
2. Filtered water is cloudy. Occasionally the filtered water will remain cloudy. This is due to the presence of colloidal material in the untreated water which the filter will reduce in concentration but not eliminate. This water still fully benefits from the filtration process; however, consumers may wish perfectly clear water. The solution is to select a source without colloidal particles or pretreat the water using a small amount of coagulant prior to filtration.
3. Filtered water storage. Filtered water **MUST** be stored and dispensed in a manner which prevents recontamination.

Good luck!