

Proform Metals LTD

Proform 2" Panel

Product Data

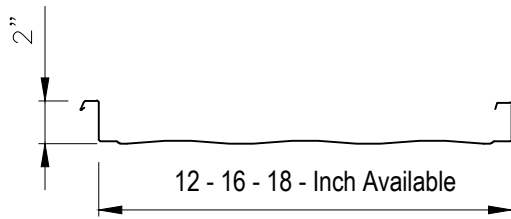

STRIATED PROFILE
(Standard)

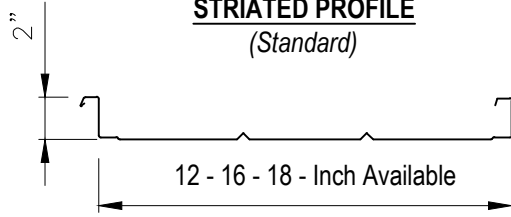

BEAD (PENCIL RIB) PROFILE
(Option)

***NOTE:**
12" wide panel has a single Pencil Rib

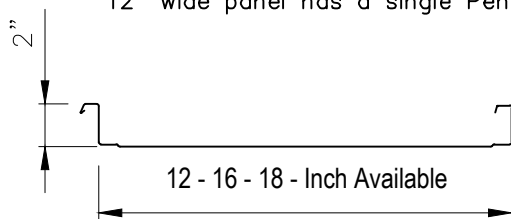

FLAT PAN PROFILE
(Option)

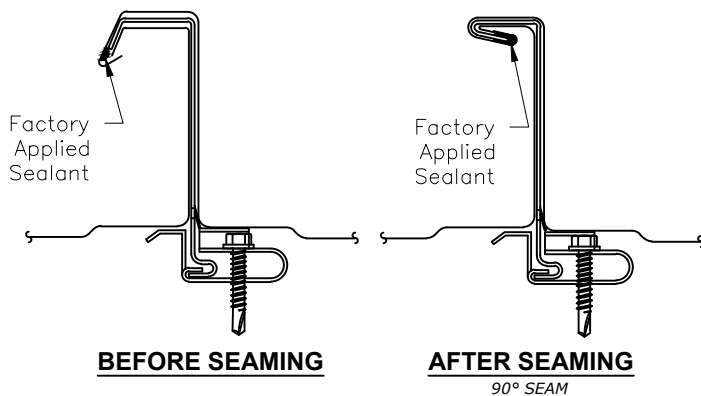

NOTE:
Factory applied seam sealant can only be ordered on panels that will NOT be curved. If curving these panels, the installer must field apply 3/32" x 3/8" Roll Tape Butyl Sealant.

Applications

Mechanically Seamed roof/wall panel used on slopes down to 1/2:12. Continuous length up to 80'.

Substrates

Solid Wood Decking, Metal Deck, Rigid Insulation/Metal Deck or Open Framing.

Material

Standard – 24 GA. ASTM A792 (50 ksi steel) AZ55 – Bare
AZ50 – Painted
Optional – 22 GA. ASTM A792 (50 ksi steel) AZ55 – Bare
AZ50 – Painted
– .032 Aluminum (Sunnyvale Plant Only)

Manufacturing

Roll formed in factory or at jobsite.
Available Factory Eave Notching of 1 1/2"

Finishes

Acrylic Coated Galvalume®
Fluoropolymer (Kynar 500® PVDF resin-based)

Pan Conditions

Striated, Pencil Rib, or Flat
Oil canning is inherent in all metal panels and is not cause for panel rejection. A signed oil canning acknowledgement will be required for all orders prior to production.

Testing *

Uplift: UL 580 Class 90, ASTM E1592,
Waterhead: ASTM E2140 (218 panel only)
Air & Water Infiltration: ASTM E1680, ASTM E1646
Fire Resistance: UL 263 & UL 790 Class A
Impact Testing: UL 2218 Class 4
Miami Dade Approval (216 panel only)
FM 4471 (1-90 Rated)
Florida Product Approval: FL 1747.3 and FL 1832.4
Testing and Approvals are product specific. Please inquire for details.

NOTE:

All data represented on this sheet may not be applicable to all widths and gauges. Please contact McElroy Metal for more information.

Requires a Mechanical Seamer and Hand Seamer to finish seam.

Proform Metals LTD

Proform 2" Panel (Continued)

Product Data

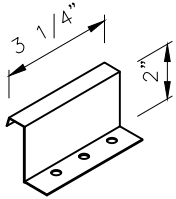

UTILITY FIXED CLIP

22 GA. Galv. G90 - ASTM A653 (50 ksi)
22 GA. Stainless Steel - ASTM A666 (50 ksi)

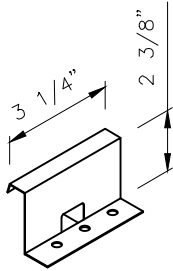

LOW FIXED CLIP

22 GA. Galv. G90 - ASTM A653 (50 ksi)
22 GA. Stainless Steel - ASTM A666 (50 ksi)

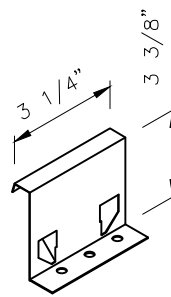

HIGH FIXED CLIP

22 GA. Galv. G90 - ASTM A653 (50 ksi)
22 GA. Stainless Steel - ASTM A666 (50 ksi)

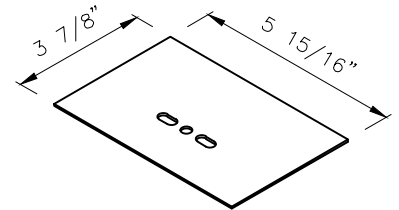

BEARING PLATE

16 GA.
RED PRIMED - ASTM A1011 (55 ksi)
GALVANIZED - ASTM A653 (55 ksi)

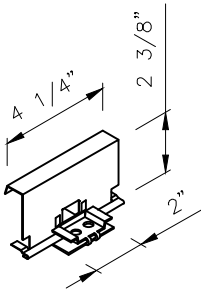

LOW FLOATING CLIP

2-Piece

Clip: 22 GA. Galvanized G90 - ASTM A653 (50 ksi)
Clip: 22 GA. Stainless Steel - ASTM A666 (50 ksi)
Base: 16 GA. Galvanized G90 - ASTM A653 (50 ksi)

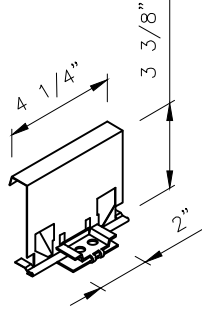

HIGH FLOATING CLIP

2-Piece

Clip: 22 GA. Galvanized G90 - ASTM A653 (50 ksi)
Clip: 22 GA. Stainless Steel - ASTM A666 (50 ksi)
Base: 16 GA. Galvanized G90 - ASTM A653 (50 ksi)

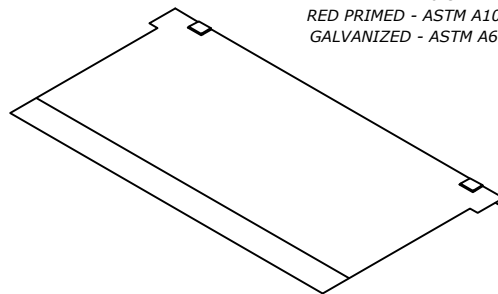

BACK-UP PLATE

16 GA.

GALVANIZED - ASTM A653 (55 ksi)
USE WITH 16" OR 18" PANELS ONLY

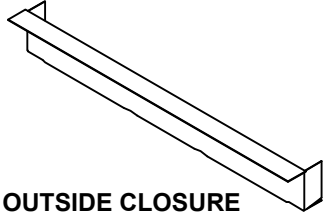

OUTSIDE CLOSURE

24 GA. - ASTM A792 (50 ksi)
USE WITH 16" AND 18"
WIDE PANELS

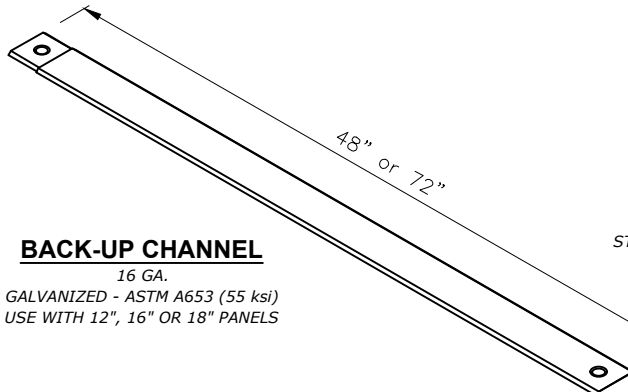

BACK-UP CHANNEL

16 GA.

GALVANIZED - ASTM A653 (55 ksi)
USE WITH 12", 16" OR 18" PANELS

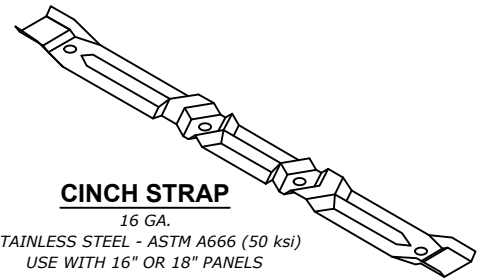

CINCH STRAP

16 GA.

STAINLESS STEEL - ASTM A666 (50 ksi)
USE WITH 16" OR 18" PANELS

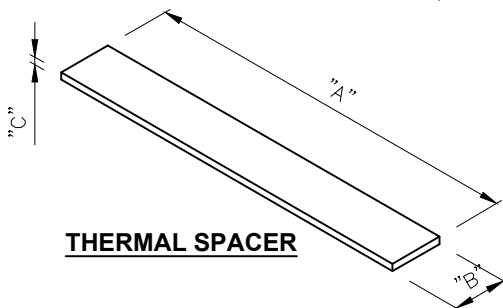

THERMAL SPACER

THERMAL SPACER SIZE CHART

| PANEL | "A" | "B" | "C" |
|-------|----------|--------|--------------------------|
| 12" | *14 7/8" | 2 1/2" | 3/8", 5/8", 1" or 1 3/8" |
| 16" | 14 7/8" | 2 1/2" | 3/8", 5/8", 1" or 1 3/8" |
| 18" | 16 7/8" | 2 1/2" | 3/8", 5/8", 1" or 1 3/8" |

*NOTE: FOR 12" PANELS, FIELD CUT 14 7/8" SPACERS
DOWN TO 10 7/8" LONG.

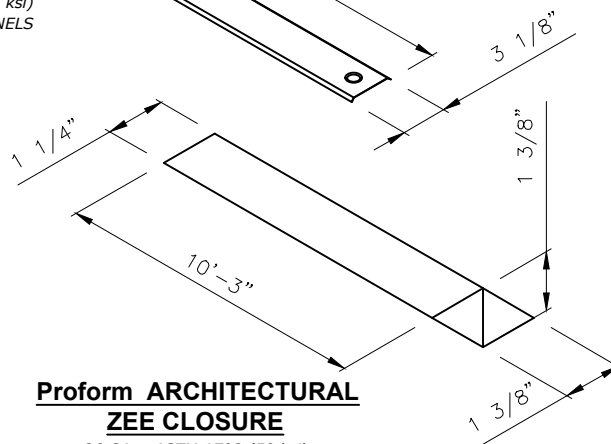

Proform ARCHITECTURAL ZEE CLOSURE

26 GA. - ASTM A792 (50 ksi)
FIELD CUT TO FORM OUTSIDE CLOSURES FOR
12", 16" AND 18" WIDE PANELS