



National Governing Body

THE OFFICIAL RULES OF INLINE HOCKEY



Grass Roots Organization

All rights reserved. This book may not be reproduced in whole or in part in any form by any means, electronic or mechanical, including photocopying, recording or by any information storage and retrieval system now known or hereafter invented, without permission from USA Roller Sports, the National Governing Body.

All Rights Reserved. Use with written permission. Contact USARS at info@usarollersports.org © Copyright 2010 USA Roller Sports, 4730 South Street- Lincoln, Nebraska 68506 Executive Director: Richard Hawkins rhawkins@usarollersports.org.

Contents

Section 1 – Playing Area

Rule 1 – Rink.....	9
Rule 2 – Goal Posts and Nets.....	11
Rule 3 – Benches.....	12
Rule 4 – Signal and Timing Devices.....	13

Section 2 – Teams

Rule 5 – Team.....	17
Rule 6 – Captain and Alternate Captains.....	18
Rule 7 – Starting Line-up.....	19
Rule 8 – Injured Players.....	20

Section 3 – Equipment

Rule 9 – Uniforms.....	24
Rule 10 – Sticks.....	26
Rule 11 – Goalkeeper’s Equipment.....	29
Rule 12 – Illegal Equipment.....	32
Rule 13 – Puck.....	32
Rule 14 – Adjustment to Clothing or Equipment.....	33

Section 4 – Types of Penalties

Rule 15 – Calling of Penalties.....	37
Rule 16 – Minor Penalties.....	39
Rule 17 – Bench Minor Penalties.....	40
Rule 18 – Double-minor Penalties.....	40
Rule 19 – Coincidental Penalties.....	40
Rule 20 – Major Penalties.....	42
Rule 21 – Match Penalties.....	43
Rule 22 – Misconduct Penalties.....	44
Rule 23 – Game Ejection Penalties.....	45
Rule 24 – Game Misconduct Penalties.....	45
Rule 25 – Penalty Shot.....	46
Rule 26 – Awarded Goals.....	50
Rule 27 – Delayed Penalties.....	51
Rule 28 – Goalkeeper’s Penalties.....	52
Rule 29 – Supplementary Discipline.....	54
Rule 30 – Signals.....	54

Section 5 – Officials

Rule 31 – Appointment of Officials.....	61
Rule 32 – Referees.....	61
Rule 33 – Chief Referee.....	64
Rule 34 – Official Scorer.....	64

Section 5 – Officials (cont.)

Rule 35 – Game Timekeeper65
Rule 36 – Penalty Timekeeper67
Rule 37 – Goal Judge 68
Rule 38 – Abuse of Officials 69
Rule 39 – Physical Abuse of Officials 73

Section 6 – Physical Fouls

Rule 40 – Boarding77
Rule 41 – Charging.....77
Rule 42 – Checking from Behind78
Rule 43 – Elbowing79
Rule 44 – Fighting79
Rule 45 – Head-butting.....82
Rule 46 – Kicking.....82
Rule 47 – Kneeing83
Rule 48 – Roughing and Body Checking.....83
Rule 49 – Slew-footing 84
Rule 50 – Throwing Equipment 84

Section 7 – Restraining Fouls

Rule 51 – Holding..... 89
Rule 52 – Hooking..... 89
Rule 53 – Interference 90
Rule 54 – Tripping.....93

Section 8 – Stick Fouls

Rule 55 – Butt-ending97
Rule 56 – Cross-checking97
Rule 57 – High-sticking 98
Rule 52 – Hooking (89) 99
Rule 58 – Slashing 99
Rule 59 – Spearing..... 100

Section 9 – Other Fouls

Rule 60 – Delaying the Game103
Rule 61 – Diving / Embellishment106
Rule 62 – Equipment.....106
Rule 63 – Forfeit of Game.....106
Rule 64 – Handling Puck107
Rule 65 – Illegal Substitution..... 109
Rule 66 – Interference with the Goalkeeper.....110
Rule 67 – Leaving the Bench 113
Rule 68 – Premature Substitution 116
Rule 69 – Refusing to Play the Puck 116
Rule 70 – Refusing to Start Play 117

Section 9 – Other Fouls (cont.)

Rule 71 – Too Many Men on the Rink	118
Rule 72 – Unsportsmanlike Conduct	119

Section 10 – Game Flow

Rule 73 – Face-offs	125
Rule 74 – Game and Intermission Timing	130
Rule 75 – Goals and Assists	130
Rule 76 – Hand Pass	132
Rule 77 – High-sticking the Puck	133
Rule 78 – Line Changes	134
Rule 79 – Overtime	136
Rule 80 – Puck Out of Bounds	137
Rule 81 – Start of Game and Periods	138
Rule 82 – Time-outs	139

Reference Tables

Table 1 – Summary of Penalties to Coaches and Non-playing Club Personnel	143
Table 2 – Summary of Minor Penalties	144
Table 3 – Summary of Bench Minor Penalties	145
Table 4 – Summary of Double-minor Penalties	145
Table 5 – Summary of Major Penalties	146
Table 6 – Summary of Major Penalties That Result in an Automatic Game Misconduct	146
Table 7 – Summary of Major Penalties That Result in an Automatic Game Misconduct When There is an Injury	147
Table 8 – Summary of Match Penalties	147
Table 9 – Summary of Misconduct Penalties	148
Table 10 – Summary of Game Misconduct Fouls Included in the “General Category”	149
Table 11 – Summary of Game Misconduct Fouls Included in the “Stick-Related Category”	150
Table 12 – Summary of Game Misconduct Penalties	150
Table 13 – Summary of Penalty Shots	151
Table 14 – Summary of Awarded Goals (When Goalkeeper Has Been Removed for an Extra Attacker)	152
Table 15 – Summary of Goalkeeper Penalties	152
Table 16 – Goals Scored Against a Short-handed Team	153
Table 17 – Coincidental Penalties	164
Table 18 – Interference on the Goalkeeper Situations	170



Section 1: **Playing Area**

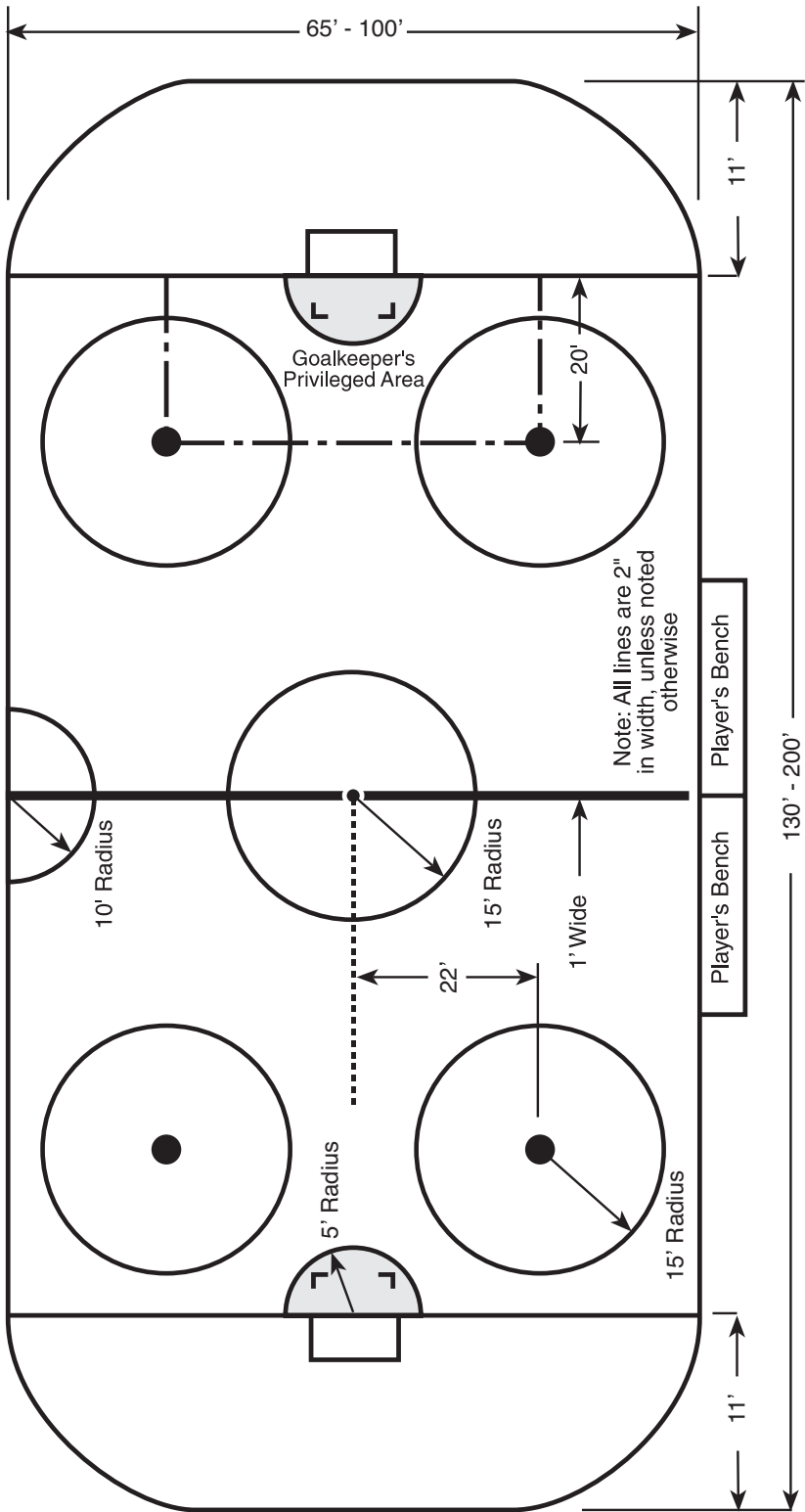

Rule 1 Rink

- 1.1 **Rink** - USARS sanctioned games shall be played on a sport-tiled, asphalt, cement, wood, or other appropriate surface in good repair known as the “Rink” and must adhere to the dimensions and specifications prescribed by USARS and these rules. On-rink logos must not interfere with any official rink markings provided for the proper playing of the game.
- 1.2 **Dimensions** - The official size of the rink shall be two hundred feet (200’) long and eighty-five feet (85’) wide, but may vary in width from 65 feet (65’) to one hundred feet (100’) and may vary in length from one hundred thirty feet (130’) to two hundred feet (200’). The corners shall be rounded in the arc of a circle with a radius of approximately twenty feet (20’). See diagram on page eight.
- ★ **NOTE** - *It is recognized that rinks of the size used at USARS Championships and World Championships may not be available for all games within the jurisdiction of USARS. Therefore, in such instances, variations in the marking of goal lines and face-off circles which are proportional to the overall size of the playing surface are authorized. If such a rink will be used as a venue for a national or international qualifying competition, the rink dimensions must be included with the information sent out to invited clubs and federations, in fairness to the participants.*
- 1.3 **Boards and Glass** - The rink shall be surrounded by a wall known as the “boards” which shall extend not less than forty inches (40”) and not more than forty-eight inches (48”) above the level of the rink surface. The ideal height of the boards above the rink surface shall be forty-two inches (42”). Except for the official markings provided for in these rules, the entire playing surface and the boards shall be white in color except the kick plate at the bottom of the boards, which shall be of a color contrasting to the color of the puck, preferably light yellow.

Any variations from any of the foregoing dimensions shall require official authorization by USARS.

The boards shall be constructed in such a manner that the surface facing the rink shall be smooth and free of any obstruction or any object that could cause injury to players.

Affixed to the boards and extending vertically shall be approved safety glass extending eight feet (8’) above the boards at each end of the rink and not less than five feet (5’) along both sides of the rink.

The glass and gear to hold them in position shall be properly padded or protect-

SECTION 1

ed. Protective glass shall be required in front of the penalty benches to provide for the safety of the players on and off the rink. All equipment used to hold the glass or screens in position shall be mounted on the boards on the side away from the playing surface.

- 1.4 **Lines** - Eleven feet (11') from each end of the rink and in the center of a red line two inches (2") wide drawn completely across the width of the rink and continued vertically up the side of the boards, regulation goal posts and nets shall be set in such a manner as to remain stationary during the progress of a game.

The red line, two inches (2") wide, between the goal posts on the rink and extended completely across the rink, shall be known as the "GOAL LINE."

In front of each goal, a "GOAL CREASE" area shall be marked by a red line two inches (2") in width.

There shall also be a line, twelve inches (12") in width and red in color, drawn completely across the rink in the exact center, parallel with the goal lines and continued vertically up the side of the boards, known as the "CENTER LINE."

- 1.6 **Division of Rink Surface** - That portion of the rink surface in which the goal is situated shall be called the "DEFENDING ZONE" of the Team defending that goal; and the portion farthest from the defended goal shall be called the "ATTACKING ZONE."
- 1.7 **Goal Crease / Referee Crease** - The goal crease shall be laid out as follows: A semi-circle with a radius of five feet (5'), having its center on the goal line at the exact middle of the goal and extending forward in front of the goal, shall be painted in red with a line two-inches (2") in width.

The goal crease area shall include all the space outlined by the crease lines and extending vertically to the ceiling. The area outlined by the crease line and the goal line shall be painted a light blue color.

On the rink immediately in front of the Penalty Timekeeper's seat there shall be marked in red on the rink a semi-circle of ten foot (10') radius and two inches (2") in width which shall be known as the "REFEREE'S CREASE."

- 1.8 **Goalkeeper's Privileged Area** - A restricted area shall be bounded in rear by the goal line, in front by an imaginary line connecting the end-zone face-off spots, and on the sides by an imaginary line running at a right angle from a point on the goal line to the end-zone face-off spots shall be known as the "GOALKEEPER'S PRIVILEGED AREA."

- 1.9 **Face-off Spots and Circles** - A circular blue spot, twelve inches (12") in diameter, shall be marked exactly in the center of the rink; and with this spot as a center, a circle of fifteen feet (15') radius shall be marked with a blue line two inches (2") in width.

In both end zones and on both sides of each goal, red face-off spots and circles shall be marked on the rink. The face-off spots shall be one foot (1') in diameter.

The circles shall be two inches (2") wide with a radius of fifteen feet (15') from the center of the face-off spots. At the outer edge of both sides of each face-off circle and parallel to the goal line shall be marked two red lines, two inches (2") wide and two feet (2') in length and three feet (3') apart.

The location of the face-off spots shall be fixed in the following manner:

Along a line twenty feet (20') from each goal line and parallel to it, mark two points twenty-two feet (22') on both sides of the straight line joining the center of the two goals. Each such point shall be the center of a face-off spot and circle.

Rule 2

Goal Posts & Nets

- 2.1 **Goal Posts** - The goal posts shall be of approved design and material, extending vertically four feet (4') above the surface of the rink and set six feet (6') apart measured from the inside of the posts. A crossbar of the same material as the goal posts shall extend from the top of one post to the top of the other.

The goal posts and crossbar shall be painted in red and all other exterior surfaces shall be painted in white.

- 2.2 **Nets** - There shall be attached to each goal frame a net of approved design made of white nylon cord which shall be draped in such a manner as to prevent the puck coming to rest on the outside of it, yet strung in a manner that will keep the puck in the net.

SECTION 1

A skirt of heavy white nylon fabric or heavyweight white canvas shall be laced around the base plate of the goal frame in such a way as to protect the net from being cut or broken. This protective padding must be attached in a manner that will not restrict the puck from completely crossing the goal line. This padding must be set back six inches (6") from the inside of the goal post. This skirt shall not project more than one inch (1") above the base plate.

The frame of the goal shall be draped with a nylon mesh net so as to completely enclose the back of the frame. The net shall be made of three-ply twisted twine (0.197 inch (5 mm) diameter) or equivalent braided twine of multifilament white nylon with an appropriate tensile strength of 700 pounds. The size of the mesh shall be two and one-half inches (2½") (inside measurement) from each knot to each diagonal knot when fully stretched. Knotting shall be made as to ensure no sliding of the twine. The net shall be laced to the frame with medium white nylon cord no smaller in size than No. 21.

Rule 3

Benches

3.1 **Players' Benches** - Each rink shall be provided with seats or benches for the use of players of both teams. The accommodations provided, including benches and doors, must be uniform for both teams. Such seats or benches shall have accommodation for at least fourteen (14) persons of each team. The benches shall be placed immediately alongside the rink as near to the center of the rink as possible. Two doors for each bench must be uniform in location and size and as convenient to the dressing rooms as possible.

Each players' bench should be twenty-four feet (24') in length and when situated in the spectator area, shall be separated from the spectators by a protective glass of sufficient height so as to afford the necessary protection for the players. Preferably, the players' benches shall be on the same side of the playing surface opposite the penalty bench and should be separated by a substantial distance, if possible.

All doors opening to the playing surface shall be constructed so that they swing inward.

Only players on the game roster in complete uniform and a maximum of three (3) team officials shall be permitted to occupy the players' benches. All team officials (including coaches, managers, and trainers) must be properly certified and registered with USARS for the current season.

- 3.2 **Penalty Bench** - Each rink must be provided with benches or seats to be known as the "PENALTY BENCH." These benches or seats must be capable of accommodating a total of ten (10) persons including the Penalty Timekeepers. Separate penalty benches shall be provided for each Team and they shall be situated on opposite sides of the Timekeeper's area, preferably directly across the rink from the players' benches. The penalty bench(es) must be situated in the neutral zone.

Each Penalty Bench shall be protected from the spectator area by means of a glass partition which shall not be less than five feet (5') above the height of the boards.

Rule 4 Signal & Timing Devices

- 4.1 **Signal Devices** - Each rink must be provided with a siren, or other suitable sound device that will sound automatically at the conclusion of each period of play. Should the sound device fail to sound automatically when time expires, the determining factor as to whether or not the period has ended shall be the timing device.

Behind each goal, electrical lights shall be set up for the use of the Goal Judges. A red light will signify the scoring of a goal and a green light will signify the end of a period or a game.

A goal cannot be scored when a green light is showing.

- 4.2 **Timing Devices** - Each rink shall be provided with some form of electronic clock for the purpose of keeping the spectators, players, and game officials accurately informed as to all time elements at all stages of the game including the time remaining to be played in any period and the time remaining to be served by at least five penalized players on each Team.

Time recording for both game time and penalty time shall show time remaining to be played or served.

The game time clock shall measure the time remaining in tenths of a second during the last minutes of each period.



Section 2:

Teams

Rule 5**Team**

- 5.1 **Eligible Players** - A team roster shall be composed of a maximum of sixteen (16) players. For the purposes of these playing rules, any reference to “player” shall refer to both skaters and goalkeepers. Any reference to “goalkeeper” shall mean that the section of the rule is specific to goalkeepers.

At the beginning of each game, the Manager or Coach of each team shall list the players who shall be eligible to play in the game. Not more than fourteen (14) skaters and two (2) goalkeepers, shall be permitted.

A list of names and numbers of all eligible players must be handed to the Official Scorer before the game, and no change shall be permitted in the list or addition thereto shall be permitted after the commencement of the game.

Prior to the game, if an official (on-rink or off-rink) notices that a player is in uniform but has not been included on the Official Game Report, the Referee shall bring this to the attention of the offending team so that the necessary correction can be made to the Official Game Report (and no penalty is assessed).

- 5.2 **Ineligible Player** - Only players on the list submitted to the Official Scorer before the game may participate in the game. The determining factor when considering whether or not a player is eligible is that the player’s name, and not necessarily the player’s number, must be correctly listed by the Manager or Coach of that team.

If a goal is scored when an ineligible player is on the rink (whether he was involved in the scoring or not), the goal will be disallowed. This only applies to the goal scored at the stoppage of play whereby the player was deemed to be ineligible. All other goals scored previously by the ineligible player’s team (with him on the rink or not) shall be allowed. The ineligible player will be removed from the game and the Club shall not be able to substitute another player from its roster. No additional penalties are to be assessed but a report of the incident must be submitted to the USARS league or tournament director. For an ineligible goalkeeper, see Rule 5.3.

- 5.3 **Goalkeeper** - Each team shall be allowed one goalkeeper on the rink at one time. The goalkeeper may be removed and another skater substituted. Such substitute shall not be permitted the privileges of the goalkeeper.

Each team shall have on its bench, or on a chair immediately beside the bench, a substitute goalkeeper who shall, at all times, be fully dressed and equipped ready to play.

SECTION 2

Except when both goalkeepers are incapacitated, no skater in the playing roster in that game shall be permitted to wear the equipment of the goalkeeper.

If both listed goalkeepers are incapacitated, that team shall be entitled to dress and play any available goalkeeper who is eligible. This goalkeeper is eligible to sit on the player's bench, in uniform. In the event that the two regular goalkeepers are injured or incapacitated in quick succession, the third goalkeeper shall be provided with a reasonable amount of time to get dressed, in addition to a two-minute warm-up (except when he enters the game to defend against a penalty shot). If, however, the third goalkeeper is dressed and on the bench when the second goalkeeper becomes incapacitated, the third goalkeeper shall enter the game immediately and no warm-up is permitted.

- 5.4 **Coaches and Team Personnel** - No one but players on the game roster and in complete uniform and a maximum of three (3) non-playing team personnel duly registered and certified with USARS for the current season, such as Managers, Coaches, Trainers, Equipment Managers, etc. shall be permitted to occupy the players' benches so provided.

Injured players wearing at minimum the team jersey and a helmet with full face mask shall be permitted on the players' bench, provided they are indicated on the Roster Sheet submitted by the Coach to the Official Scorer prior to the start of the game.

Rule 6

Captain & Alternate Captain

- 6.1 **Captain** - One Captain shall be appointed by each team, and he alone shall have the privilege of discussing with the Referee any questions relating to interpretation of rules which may arise during the progress of a game. He shall wear the letter "C," approximately three inches (3") in height and in contrasting color, in a conspicuous position on the front of his sweater. No co-Captains are permitted. Either one Captain and no more than two Alternate Captains, or no Captain and no more than three Alternate Captains are permitted (see Rule 6.2).

Only the Captain, when invited to do so by the Referee, shall have the privilege of discussing any point relating to the interpretation of rules. Any Captain, Alternate Captain, or any player who comes off the bench and makes any protest or intervention with the officials for any purpose shall be assessed a minor penalty for unsportsmanlike conduct under Rule 38 – Abuse of Officials. Should this protest continue, he may be assessed a misconduct penalty, and if it further continues, a game misconduct penalty shall be warranted.

A complaint about a penalty is NOT a matter “relating to the interpretation of the rules” and a minor penalty shall be imposed against any Captain, Alternate Captain, or any other player making such a complaint.

The Referee and Official Scorer shall be advised, prior to the start of each game, the name of the Captain and the Alternate Captains of both teams.

No goalkeeper shall be permitted to perform the duties of the Captain or Alternate Captain, but may be symbolically recognized as such by the team.

- 6.2 **Alternate Captains** - If the permanent Captain is not on the rink, Alternate Captains (not more than two) shall be accorded the privileges of the Captain. Alternate Captains shall wear the letter “A” approximately three inches (3”) in height and in contrasting color, in a conspicuous position on the front of their sweaters.

Only when the Captain is not in uniform, the Coach shall have the right to designate three Alternate Captains. This must be done prior to the start of the game.

Rule 7 **Starting Lineup**

- 7.1 **Starting Line-up** - Prior to the start of the game, at the request of the Referee, the Manager or Coach of the visiting team is required to name the starting line-up to the Referee or Official Scorer.

Prior to the start of the game, the Manager or Coach of the home team, having been advised by the Official Scorer the names of the starting line-up of the visiting team, shall name the starting line-up of the home team. This information shall be conveyed by the Official Scorer to the Coach of the visiting team.

No change in the starting line-up of either team as given to the Official Scorer, or in the playing line-up on the rink, unless reviewed and approved by the Referee prior to the start of the game.

Teams must have a goalie and four skaters on the rink in order to start the game. If this requirement cannot be met, a forfeit shall be declared by the Referee against the offending team.

SECTION 2

Rule 8

Injured Players

- 8.1 **Injured Player** - When a player is injured or compelled to leave the rink during a game, he may retire from the game and be replaced by a substitute, but play must continue without the teams leaving the rink.

During the play, if an injured player wishes to retire from the rink and be replaced by a substitute, he must do so at the players' bench and not through any other exit leading from the rink. This is not a legal player change and therefore when a violation occurs, a bench minor penalty shall be imposed.

If a penalized player has been injured, he may proceed to the dressing room without the necessity of taking a seat on the penalty bench. If the injured player receives a minor penalty, the penalized team shall immediately put a substitute player on the penalty bench, who shall serve the penalty until such time as the injured player is able to return to the game. He would replace his teammate on the penalty bench at the next stoppage of play. If the injured player receives a major penalty, the penalized team shall place a substitute player on the penalty bench before the penalty expires and no other replacement for the penalized player shall be permitted to enter the game except from the penalty bench. For violation of this rule, a bench minor penalty shall be imposed.

Should the injured penalized player who has been replaced on the penalty bench return to his players' bench prior to the expiration of his penalty, he shall not be eligible to play until his penalty has expired. This includes coincidental penalties when his substitute is still in the penalty box awaiting a stoppage in play. The injured player must wait until his substitute has been released from the penalty box before he is eligible to play. If, however, there is a stoppage of play prior to the expiration of his penalty, he must then replace his teammate on the penalty bench and return to play once his penalty has expired.

When a player is injured so that he cannot continue play or go to his bench, the play shall not be stopped until the injured player's team has secured possession of the puck. If the player's team is in possession of the puck at the time of injury, play shall be stopped immediately unless his team is in a scoring position.

In the case where it is obvious that a player has sustained a serious injury, the Referee may stop the play immediately.

When play has been stopped by the Referee due to an injured player, or whenever an injured player is attended to on the rink by the Trainer or medical personnel, such player must be substituted for immediately. This injured player cannot return to the rink until play has resumed.

When play is stopped for an injured player, the ensuing face-off shall be conducted at the last-play face-off location. When the injured player's team has possession of the puck in the attacking zone, the face-off shall be conducted at the center face-off spot. When the injured player is in his defending zone and the attacking team is in possession of the puck in the attacking zone, the face-off shall be conducted at one of the defending team's end-zone face-off spots.

- 8.2 **Injured Goalkeeper** - If a goalkeeper sustains an injury or becomes ill, he must be ready to resume play immediately or be replaced by a substitute goalkeeper and no additional time shall be allowed by the Referee for the purpose of enabling the injured or ill goalkeeper to resume his position. No warm-up shall be permitted for a substitute goalkeeper.

The substitute goalkeeper shall be subject to the regular rules governing goalkeepers and shall be entitled to the same privileges.

When a substitution for the regular goalkeeper has been made, such regular goalkeeper shall not resume his position until the next stoppage of play.

When play has been stopped by the Referee due to an injured goalkeeper, such goalkeeper must be substituted for only if he has to proceed to the players' bench to receive medical attention. If the Trainer has come onto the rink to attend to the goalkeeper and there is no undue delay, the goalkeeper may remain in the game without substitute. However, no additional time shall be permitted by the Referee for the purpose of enabling the injured goalkeeper to resume his position (i.e. no warm-up).

- 8.3 **Blood** - A player who is bleeding or who has visible blood on his equipment or body shall be ruled off the rink at the next stoppage of play. Such player shall not be permitted to return to play until the bleeding has been stopped and the cut or abrasion covered (if necessary). It is required that any affected equipment and/or uniform be properly decontaminated or exchanged.



Section 3: Equipment

SECTION 3

Rule 9

Uniforms

- 9.1 **Team Uniform** - All players of each team shall be dressed uniformly with identical long-sleeve jerseys and full-length pants designed for roller hockey.

Each team shall have distinctive and contrasting uniforms for their home and away games. The home team is to wear white or predominately light-colored jerseys, while the away team is to wear predominately dark-colored jerseys. It shall be the responsibility of the away team to change its jerseys if the colors of the competing teams conflict.

- 9.2 **Numbers** - Each player listed in the line-up of each team shall wear an individual identifying number at least ten inches (10") high on the back of his sweater. Only one member of the same team will be permitted to wear each individual number. Sweater numbers such as 00, $\frac{1}{2}$ (fractions), .05 (decimals), 101 (three digit) are not permitted. It is recommended that each player shall wear his surname in full, in block letters three inches (3") high, across the back of his sweater at shoulder height.

- 9.3 **Player's Jersey** - (see Rule 9.4 for goalkeeper) No inserts or additions are to be added to the standard players' jersey as produced by the manufacturer.

No alteration of the neck opening is permitted.

Sleeves must extend to the cuff of the glove.

- 9.4 **Goalkeeper's Jersey** - No inserts or additions are to be added to the standard goalkeeper-cut jersey as produced by the manufacturer.

No "tying down" of the sweater is allowed at the wrists if it creates a tension across the jersey such that a "webbing effect" is created in the armpit area.

No other tie downs are allowed that create a "webbing effect."

The length of a jersey is illegal if it covers any area between the goalkeeper's legs.

- 9.5 **Protective Equipment** - All protective equipment, except gloves, headgear and goalkeepers' leg pads must be worn under the uniform. Should it be brought to the attention of the Referee that a player is wearing, for example, an elbow pad that is not covered by his jersey, he shall instruct the player to return to the players' bench to cover up the pad and shall not be allowed to return until the equipment has been fixed and play has resumed. A second violation by the same player would result in a minor penalty being assessed.

Mandatory protective equipment for players under the age of 18 (and 18 year-olds playing in the 18-and-under age division) includes: HECC approved helmet with helmet- and chin-straps properly fastened, HECC approved full facemask with a chin cup, colored (non-clear) internal mouth guard, gloves designed for hockey, elbow pads, protective cup or pelvic protector, and knee/shin pads designed for hockey.

Mandatory protective equipment for players 18 and older (playing in an 18-and-over division) includes helmet designed for hockey with chin strap fully fastened, gloves designed for hockey, elbow pads, protective cup or pelvic protector, and knee/shin pads designed for hockey. A full facemask is strongly recommended, but not required.

Players 18 and older playing in the 21-and-under Junior Division must wear at minimum a half-shield visor, although a full facemask is strongly recommended.

No player may continue to participate in the play without his helmet. Should a player lose his helmet, play shall be stopped immediately. For such an infraction in the attacking zone, the ensuing face-off will take place at the center face-off spot. If the play is stopped for such an infraction in the defending zone, the ensuing face-off will take place at the nearest last-play face-off location.

When a player deliberately removes his helmet and/or facemask in order to secure a stoppage of play, the Referee shall stop play as outlined above and in this case assess the player a minor penalty for delaying the game. If the player deliberately removes his helmet and/or facemask when the opposing team is on a breakaway, the Referee shall award a penalty shot to the non-offending team, which shot shall be taken by the player last in possession of the puck. If the goalkeeper deliberately removes his helmet and/or facemask during the course of a penalty shot or shootout attempt, the Referee shall award a goal to the non-offending team.

Whenever it is deemed by the Referee that a player is wearing protective equipment (including an altered or torn jersey) that does not meet the guidelines set forth within these rules, he shall instruct the player to return to the players' bench and change or remove the piece of equipment. If he refuses to make the necessary change he shall be assessed a minor penalty for delay of game and should he return to the rink without making the necessary change he shall be assessed a misconduct penalty. Should this happen a third time, he shall be assessed a game misconduct penalty.

SECTION 3

- 9.6 **Dangerous Equipment** - The use of pads or protectors made of metal or of any other material likely to cause injury to a player is prohibited. Referees have the authority to prohibit any equipment they feel may cause injury to any participants in the game. Failure to comply with the Referees' instructions shall result in the assessment of a minor penalty for delay of game.

The wearing of casts or splints made of hard or unyielding materials is prohibited, except when directed in writing by a licensed medical physician. In such cases, the cast or splint must be covered on all exterior surfaces with no less than 1/2 inch (1/2") thick, high density, closed cell polyurethane or alternate material of the same minimum thickness and with similar physical properties.

In cases where a stick may have been modified and it is evident that the edges have not been beveled, the Referee shall deem the stick to be dangerous equipment and removed from the game until the edges can be beveled sufficiently. No penalty is to be assessed initially unless the player returns to the rink with the unmodified stick, for which the player will be assessed a minor penalty for delay of game.

Rule 10 Sticks

- 10.1 **Player's Stick** - (see Rule 10.2 for goalkeeper) The stick shall be made of wood, aluminum, composite or other material approved USARS, and must not have any projections. Adhesive tape of any color may be wrapped around the stick at any place for the purpose of reinforcement or to improve control of the puck.

No stick shall exceed sixty-three inches (63") in length from the heel to the end of the shaft nor more than twelve and one-half inches (12 1/2") from the heel to the end of the blade.

The blade of the stick shall not be more than three inches (3") in width at any point between the heel and 1/2" in from the mid-point of the tip of the blade, nor less than two inches (2"). All edges of the blade shall be beveled (see Rule 9.6). The curvature of the blade shall not be restricted.

The upper portion of the shaft of the stick shall be wrapped with tape or other protective material so as not to result in a pointed, sharp, or hollow (in the case of an aluminum or composite shaft) butt-end.

PLAYER'S STICK MEASUREMENTS

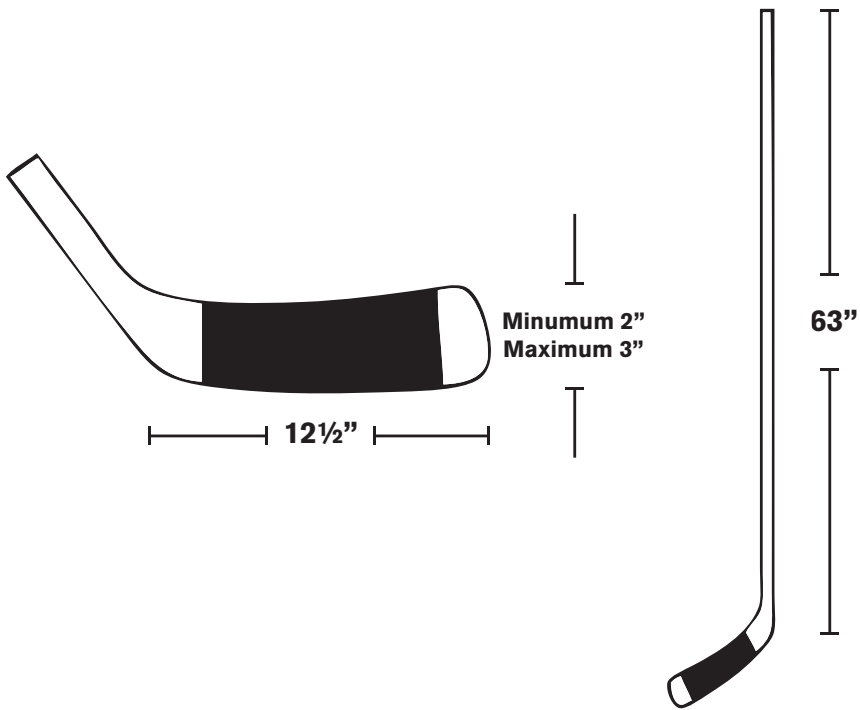

- 10.2 **Goalkeeper's Stick** - In the case of a goalkeeper's stick, there shall be a knob of tape or some other protective material at the upper portion of the shaft. This knob must not be less than one-half inch ($1/2$ ") thick at the top of the shaft.

Failure to comply with this provision of the rule will result in the goalkeeper's stick being deemed unfit for play. The goalkeeper's stick must be changed without the application of a minor penalty.

The blade of the goalkeeper's stick shall not exceed three and one-half inches ($3\frac{1}{2}$ ") in width at any point except at the heel, where it must not exceed four and one-half inches ($4\frac{1}{2}$ ") in width; nor shall the goalkeeper's stick exceed fifteen and one-half inches ($15\frac{1}{2}$ ") in length from the heel to the end of the blade.

SECTION 3

The widened portion of the goalkeeper's stick extending up the shaft from the blade shall not extend more than twenty-six inches (26") from the heel and shall not exceed three and one-half inches (3½") in width.

GOALKEEPER'S STICK MEASUREMENTS

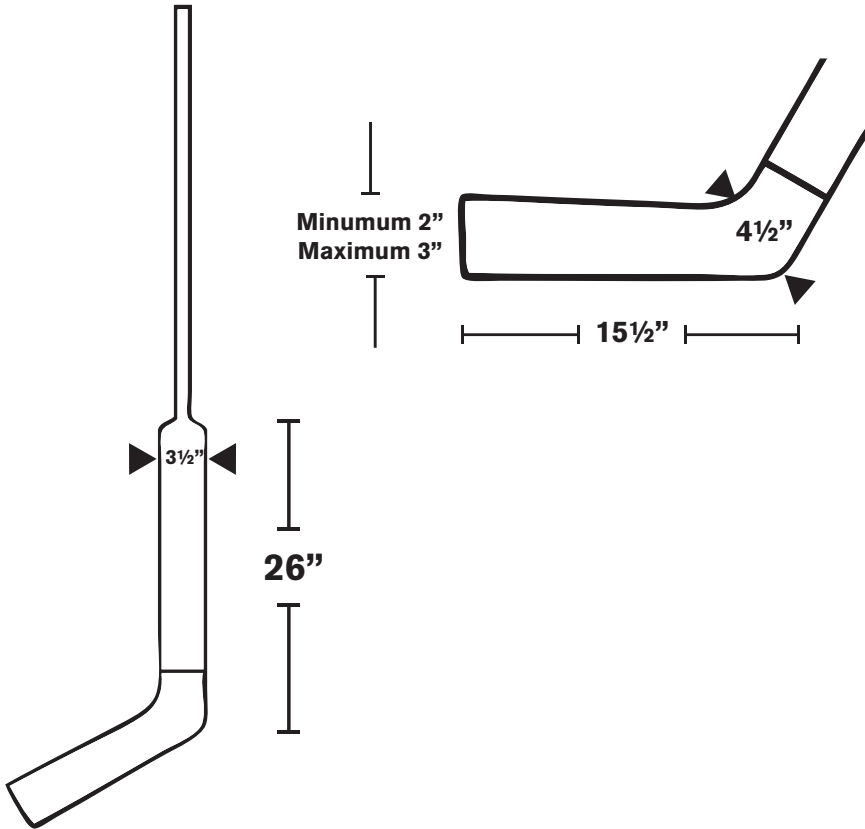

- 10.3 **Broken Stick** – Player - A broken stick is one which, in the opinion of the Referee, is unfit for normal play.

A player without a stick may participate in the game. A player whose stick is broken may participate in the game provided he drops the broken stick immediately. A minor penalty shall be imposed for an infraction of this rule.

A player who has lost or broken his stick may only receive a stick at his own players' bench or be handed one from a teammate on the rink. A player will be penalized if he throws, tosses, slides, or shoots a stick to a teammate on the rink. A player may not participate in the play using a goalkeeper's stick. A minor penalty shall be imposed for an infraction of this rule. A player who participates in play, intentionally prevents the movement of an opponent, or who intentionally plays the puck while carrying two sticks (including while carrying a replacement stick to his teammate) shall incur a minor penalty under this rule.

A player tendered a stick thrown on the rink from the players' or penalty bench will not receive a penalty. However, the team shall be assessed a bench minor penalty.

- 10.4 **Broken Stick – Goalkeeper** - A goalkeeper may continue to play with the paddle portion of a broken stick until a stoppage of play or until he has one legally handed to him by a teammate. The teammate must hand the stick to him. He cannot throw it or slide it to the goalkeeper (this includes situations where the goalkeeper has lost his stick and a teammate is trying to return it to him). For a violation of this rule, a minor penalty for throwing the stick shall be assessed to the offending player (no penalty to the goalkeeper for receiving the stick).

A goalkeeper whose stick is broken or illegal may not go to the players' bench for a replacement but must receive his stick from a teammate. A goalkeeper may participate in the play using a skater's stick until such time as he is legally provided with a replacement goalkeeper's stick.

For an infraction of this rule, a minor penalty shall be imposed on the goalkeeper.

- 10.5 **Stick Measurement** - All stick measurements shall be conducted at the discretion of the Referee. No such request shall be allowed by either team. A player whose stick has been measured and is found to not conform to the provisions of this rule shall be assessed a minor penalty and the player shall not be permitted to use the illegal stick for the remainder of the game.

Rule 11 **Goalkeeper's Equipment**

- 11.1 **Goalkeeper's Equipment** - With the exception of skates and stick, all the equipment worn by the goalkeeper must be constructed solely for the purpose of protecting the head or body, and he must not wear any garment or use any contrivance which would give him undue assistance in keeping goal.

SECTION 3

- II.2 **Leg Pads** - The leg pads worn by goalkeepers shall not exceed twelve inches (12") in extreme width when on the leg of the player. The maximum length from bottom mid-point to top mid-point of the pad is not to exceed thirty-eight inches (38").
- II.3 **Chest and Arm Pads** - No raised ridges are allowed on the front edges or sides of the chest pad, the inside or outside of the arms, or across the shoulders.

Layering at the elbow is permitted to add protection but not to add stopping area. This layering, both across the front and down the sides, to protect the point of the elbow shall not exceed seven inches (7").

Shoulder cap protectors must follow the contour of the shoulder cap without becoming a projection/extension beyond or above the shoulder or shoulder cap. This contoured padding must not be more than one inch (1") in thickness beyond the top ridge of the shoulder and shoulder cap.

On each side the shoulder clavicle protectors are not to exceed seven inches (7") in width. Their maximum thickness is to be one inch (1"). This protection is not to extend or project above or beyond the shoulder or shoulder cap nor extend beyond the armpit. No insert is allowed between the shoulder clavicle protector and the chest pad that would elevate the shoulder clavicle protector.

If, when the goalkeeper assumes his normal crouch position, the shoulder and/or shoulder cap protection is pushed above the contour of the shoulder, the chest pad will be considered illegal.

- II.4 **Pants** - No internal or external or cheater padding is permitted on the pant leg or waist beyond that which is required to provide protection (no outside or inside ridges).

The maximum width (straight line) of the thigh pad across the front of the leg is ten inches (10"). If the groin and/or hip pads extend beyond the edge of the front thigh pad they are to be included in this ten-inch (10") measurement. This measurement is to be taken while the goalkeeper is in an upright standing position. This measurement is to be made five inches (5") up from the bottom of the pant.

All thigh pads must follow the contour of the leg. Square thigh pads are considered illegal.

All knee protection must be strapped and fit under the thigh pad of the pant leg and not exceed a contoured ten inches (10"), with no flat surfaces and must not be permanently attached or fixed to the pants.

- 11.5 **Catching Glove** - A maximum perimeter of forty-five inches (45") is permitted. The perimeter of the glove is the distance around the glove.

The wrist cuff shall be a maximum of four inches (4") in width. The cuff of the glove is considered to be the portion of the glove protecting the wrist from the point where the thumb joint meets the wrist. Any protection joining/enhancing the cuff to the glove will be considered part of the glove rather than the cuff.

The wrist cuff is to be a maximum of eight inches (8") in length (this includes the bindings). All measurements follow the contour of the cuff.

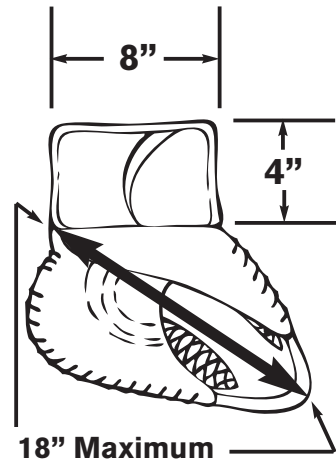

The distance from the heel of the glove along the pocket and following the contour of the inside of the trap of the glove to the top of the "T" trap must not exceed eighteen inches (18"). The heel is considered to be the point at which the straight vertical line from the cuff meets the glove (see diagram at right).

- 11.6 **Blocking Glove** - Protective padding attached to the back or forming part of the goalkeeper's blocking glove shall not exceed eight inches (8") in width nor more than fifteen inches (15") in length at any point (this includes the bindings). All measurements follow the contour of the back of the glove.

The blocking glove must be rectangular in shape.

The flap protecting the thumb and wrist must be fastened to the blocker and must follow the contour of the thumb and wrist. This thumb protection must not exceed seven inches (7") in extreme length when measured from the top of the blocking surface.

Raised ridges are not to be added to any portion of the blocking glove.

All goalkeepers must use one of each a blocking glove and catching glove, meeting USARS-approved sizing specifications.

- 11.6 **Masks** - HECC approved helmets and facemasks shall be worn by all goalkeepers under the age of 18 (or by 18 year olds playing in the 18-and-Under age division). Under such rule, "cat's eye" cages may not be worn. Goalkeepers over the age of 18 (playing in an 18-and-over division) must wear a helmet designed for hockey.

SECTION 3

It is strongly recommended that goalkeepers in the 18-and-over age divisions wear HECC approved helmets and facemasks. Protective masks deemed to be worn only to increase stopping area will be considered illegal.

Rule 12 **Illegal Equipment**

- 12.1 **Illegal Equipment** - All protective equipment, except gloves, headgear, and goalkeepers' leg guards must be worn under the uniform. For violation of this rule, after warning by the Referee, a minor penalty shall be imposed.

Players violating this rule shall not be permitted to participate in the game until such equipment has been corrected or removed.

- 12.2 **Gloves** - A glove from which all or part of the palm has been removed or cut to permit the use of the bare hand shall be considered illegal equipment and if any player wears such a glove in play, a minor penalty shall be imposed on him.

When a complaint is made under this rule, and such complaint is not sustained, a bench minor penalty shall be imposed against the complaining Club for delaying the game.

- 12.3 **Elbow Pads** - All elbow pads which do not have a soft protective outer covering of sponge rubber or similar material at least one-half inch (1/2") thick shall be considered dangerous equipment.
- 12.4 **Fair Play** - These equipment regulations (Section 3) are written in the spirit of "fair play." If at any time, USARS or the local league in jurisdiction feels that this spirit is being abused, the offending equipment will be deemed ineligible for play until a hearing has ruled on its eligibility.

Rule 13 **Puck**

- 13.1 **Dimensions** - The puck shall be made of plastic, or other approved material, one inch (1") thick and three inches (3") in diameter. All pucks used in competition must be approved by USARS or the local league.
- 13.2 **Supply** - The home team shall be responsible for providing an adequate supply of official pucks. This supply of pucks shall be kept at the penalty bench under the control of one of the regular off-rink Officials or a special attendant.
- 13.3 **Official Puck** - The official puck approved for USARS Regional and National

Championships as well as AAU Junior Olympic Games is the IDS brand puck.

- 13.4 **Illegal Puck** - If at any time while play is in progress, a puck other than the one legally in play shall appear on the playing surface, the play shall not be stopped but shall continue with the legal puck until the play then in progress is completed by change of possession.

If the illegal puck interferes with the normal course of play, play may be stopped at any point at the discretion of the Referee.

Rule 14 **Adjustment to Clothing or Equipment**

- 14.1 **Adjustment to Clothing or Equipment** - Play shall not be stopped nor the game delayed by reasons of adjustments to clothing, equipment, skates, or sticks.

The onus of maintaining clothing and equipment in proper condition shall be upon the player. If adjustments are required, the player shall leave the rink and play shall continue with a substitute.

No delay shall be permitted for the repair or adjustment of goalkeeper's equipment. If adjustments are required, the goalkeeper shall leave the rink and his place shall be taken by the substitute goalkeeper immediately.



Section 4: Types of Penalties

Rule 15 **Calling of Penalties**

- 15.1 **Calling a Penalty** - Should an infraction of the rules which would call for a minor, major, misconduct, game misconduct, or match penalty be committed by a player of the side in possession of the puck, the Referee shall immediately blow his whistle and penalize the offending player.

Should an infraction of the rules which would call for a minor, major, misconduct, game misconduct or match penalty be committed by a player of the team not in possession of the puck, the Referee shall raise his arm to signal the delayed calling of a penalty. When the team to be penalized gains control of the puck, the Referee will blow his whistle to stop play and impose the penalty on the offending player.

When a player, Trainer, Manager, coach or non-playing Club personnel is ejected from the game for a violation of the playing rules, that individual must vacate the players' bench area and may not, in any manner, further participate in the game. This includes directing the team from the spectator area or by radio communications. Any violations shall be reported to the proper league or USARS directors.

Refer to **Reference Tables – Table 1 – Summary of Penalties to Coaches and Non-playing Club Personnel** for a list of infractions specific to those individuals.

- 15.2 **Calling a Minor Penalty** – Goal Scored - If the penalty to be imposed is a minor penalty and a goal is scored on the play by the non-offending side, the minor penalty shall not be imposed, but shall still be reported for inclusion on the Official Game Report. All major and match penalties shall be imposed in the normal manner regardless of whether or not a goal is scored.

If two or more minor penalties were to be imposed and a goal is scored on the play by the non-offending side, the Captain of the offending team shall designate to the Referee which minor penalty(ies) will be assessed and which minor penalty will be washed out as a result of the scoring of the goal. All minor penalties shall be recorded on the official score sheet, regardless if any time is served.

- 15.3 **Calling a Double-minor Penalty** – Goal Scored - When the penalty to be imposed is applicable under **Rule 55 – Butt-ending** or **Rule 59 – Spearing**, and a goal is scored, only two minutes of the appropriate penalty will be served by the offending player. (This will be announced and reported on the Official Game Report as a double-minor for the appropriate foul but the player will serve two (2) minutes only.)

SECTION 4

15.4 **Calling a Penalty – Short-handed Team – Goal Scored** - If when a team is “short-handed” by reason of one or more minor or bench minor penalties, the Referee signals a further minor penalty or penalties against the “short-handed” team and a goal is scored by the non-offending side before the whistle is blown, then the goal shall be allowed. The penalty or penalties signaled shall be assessed and the first of the minor penalties already being served shall automatically terminate under **Rule 16 – Minor Penalties**. Major and match penalties shall be imposed in the normal manner regardless of whether or not a goal is scored.

Should a minor or bench minor penalty be signaled against a team already short-handed by reason of a major (or match) penalty, but before the play can be stopped to assess the minor or bench minor penalty, a goal is scored by the non-offending side, the signaled minor or bench minor penalty shall not be imposed due to the scoring of the goal, but shall still be reported for inclusion on the Official Game Report.

Should a penalty be signaled against a team already short-handed by reason of one or more minor or bench minor penalties, and the signaled penalty would result in the awarding of a penalty shot, but before the Referee can stop play to award the penalty shot, the non-offending team scores a goal, then the signaled penalty (that would have resulted in a penalty shot) shall be assessed as a minor (double-minor, major or match) penalty and the first of the minor penalties already being served shall automatically terminate under Rule 16 – Minor Penalties.

15.5 **Face-off Locations** - When players are penalized at a stoppage of play so as to result in one or more penalties being placed on the penalty time clock to one team, the ensuing face-off shall be conducted at one of the two face-off spots in the offending team’s end zone. There are only three (3) exceptions to this application:

- (i) *when a penalty is assessed after the scoring of a goal – face-off at center face-off spot;*
- (ii) *when a penalty is assessed at the end (or start) of a period – face-off at center face-off spot;*
- (iii) *when the play is stopped due to a non-penalized infraction against the non-penalized team, such as a high stick or hand pass – face-off at center face-off spot.*

Rule 16 **Minor Penalties**

- 16.1 **Minor Penalty** - For a minor penalty, any player, other than a goalkeeper, shall be ruled off the rink for two (2) minutes during which time no substitute shall be permitted.
- 16.2 **Short-handed** - “Short-handed” means that the team must be below the numerical strength of its opponent on the rink at the time the goal is scored. The minor or bench minor penalty which terminates automatically is the one with the least amount of time on the clock. Thus, coincident minor penalties to both Teams do not cause either side to be “short-handed” (see **Rule 19 – Coincidental Penalties**).

If while a team is “short-handed” by one or more minor or bench minor penalties, the opposing team scores a goal, the first of such penalties shall automatically terminate.

This rule shall also apply when a goal is awarded.

This rule does not apply when a goal is scored on a penalty shot (i.e. offending team’s penalized player(s) do not get released on the scoring of a goal on a penalty shot).

Minor penalty expiration criteria:

- (i) *Is the team scored against short-handed?*
- (ii) *Is the team scored against serving a minor penalty on the clock?*

If both criteria are satisfied, the minor penalty with the least amount of time on the clock shall terminate except when coincidental penalties are being served. Refer to Reference Tables – Table 16 – Goals Scored Against a Short-handed Team.

No penalty shall expire when a goal is scored against a team on a penalty shot.

When the minor penalties of two players of the same team terminate at the same time, the Captain of that team shall designate to the Referee which of such players will return to the rink first and the Referee will instruct the Penalty Timekeeper accordingly.

- 16.3 **Infractions** - Refer to Reference Tables – Table 2 – Summary of Minor Penalties, for a list of infractions that can result in a minor penalty being assessed (see specific rule numbers for complete descriptions).

SECTION 4

Rule 17 **Bench Minor Penalties**

- 17.1 **Bench Minor Penalty** - A bench minor penalty involves the removal from the rink of one player of the team against which the penalty is assessed for a period of two (2) minutes. Any player except a goalkeeper of the team may be designated to serve the penalty by the Manager or Coach through the playing Captain and such player shall take his place on the penalty bench promptly and serve the penalty as if it was a minor penalty imposed upon him.
- 17.2 **Short-handed** - see **Rule 16.2**.
- 17.3 **Infractions** - Refer to Reference Tables – Table 3 – Summary of Bench Minor Penalties for a list of infractions that can result in a bench minor penalty being assessed (see specific rule numbers for complete descriptions).

Rule 18 **Double-minor Penalties**

- 18.1 **Double-minor Penalty** - For a double-minor penalty, any player, other than a goalkeeper, shall be ruled off the rink for four (4) minutes during which time no substitute shall be permitted.
- 18.2 **Short-handed** - see **Rule 16.2**.

When a double-minor penalty has been signaled by the Referee and the non-offending team scores during the delay, one of the minor penalties shall be washed out and the penalized player will serve the remaining two minutes of the double-minor penalty. The penalty will be announced and reported on the Official Game Report as a double-minor penalty but only two minutes would be shown on the penalty time clock.

- 18.3 **Infractions** - Refer to Reference Tables – Table 4 – Summary of Double-minor Penalties for a list of infractions that can result in a double-minor penalty being assessed (see specific rule numbers for complete descriptions).

Rule 19 **Coincidental Penalties**

- 19.1 **Coincidental Minor Penalties** - When coincident minor penalties or coincident minor penalties of equal duration are imposed against players of both teams, the penalized players shall all take their places on the penalty benches and such penalized players shall not leave the penalty bench until the first stoppage of

play following the expiry of their respective penalties. Where goalkeepers are involved, refer to **Rule 28.1**. Immediate substitution shall be made for an equal number of minor penalties or coincident minor penalties of equal duration to each team so penalized and the penalties of the players for which substitutions have been made shall not be taken into account for the purpose of the delayed penalty rule (**Rule 27 – Delayed Penalties**).

When multiple penalties are assessed to both teams, equal numbers of minor and major penalties shall be eliminated using the coincident penalty rule and any differential in time penalties shall be served in the normal manner and displayed on the penalty time clock accordingly (see **Rule 19.4**). If there is no differential in time penalties, all players will serve their allotted penalty time, but will not be released until the first stoppage of play following the expiration of their respective penalties.

- 19.2 **Coincidental Major Penalties** - When coincident major penalties or coincident penalties of equal duration, including a major and/or a match penalty, are imposed against players of both teams, the penalized players shall all take their places on the penalty benches and such penalized players shall not leave the penalty benches until the first stoppage of play following the expiry of their respective penalties. Immediate substitutions shall be made for an equal number of major penalties, or coincident penalties of equal duration including a major penalty to each team so penalized, and the penalties of the players for which substitutions have been made shall not be taken into account for the purpose of **Rule 27 – Delayed Penalties**. In such situations, if one or both players have received a game misconduct in addition to their major penalties, no substitutes are required to take their places on the penalty benches.
- 19.3 **Coincidental Match Penalties** - When coincident match penalties or coincident penalties of equal duration, including a major and/or a match penalty, are imposed against players of both teams, the players with the match penalties shall be immediately removed from the game and their substitutes shall take their places on the penalty benches. These penalized players shall not leave the penalty benches until the first stoppage of play following the expiry of their respective penalties. Immediate substitutions shall be made for an equal number of major and/or match penalties, or coincident penalties of equal duration including a major or match penalty to each team so penalized, and the penalties of the players for which substitutions have been made shall not be taken into account for the purpose of **Rule 27 – Delayed Penalties**.

SECTION 4

19.4 **Applying the Coincidental Penalty Rule** - When multiple penalties are assessed to both teams at the same stoppage of play, the following rules are to be utilized by the Referees to determine the on-rink strength for both teams:

- (i) *Cancel as many major and/or match penalties as possible*
- (ii) *Cancel as many minor, bench minor, and or double-minor penalties as possible*

Refer to **Reference Tables – Table 17 – Coincidental Penalties**.

Rule 20 Major Penalties

20.1 **Major Penalty** - For the first major penalty in any one game, the offender, except the goalkeeper, shall be ruled off the rink for five (5) minutes during which time no substitute shall be permitted.

When one player receives a major penalty and a minor penalty at the same time, the major penalty shall be served first by the penalized player (or substitute for the goalkeeper), except under **Rule 19.2** where coincidental major penalties are in effect, in which case the minor penalty will be recorded and served first.

20.2 **Short-handed** - Although a major penalty does cause a team to be short-handed, the penalized player serving the major penalty does not leave the penalty bench when the opposing team scores. The player must wait for the entire major penalty to expire before he is permitted to exit the penalty bench.

20.3 **Substitution** - When a player has been assessed a major penalty and has been removed from the game or is injured, the offending team does not have to place a substitute player on the penalty bench immediately, but must do so at a stoppage of play prior to the expiration of the major penalty. He may then legally exit the penalty bench when the major penalty has expired.

Failure to place a player on the penalty bench prior to the expiration of the major penalty will result in that team having to continue playing one player short (but not officially considered short-handed) until the next stoppage of play. Any replacement player who enters the game other than from the penalty bench shall constitute an illegal substitution under **Rule 68 – Illegal Substitution** calling for a bench minor penalty.

20.4 **Automatic Game Misconduct** - An automatic game misconduct shall be applied to any player who has been assessed a second major penalty in the same game.

An automatic game misconduct shall also be applicable whenever a player is assessed a major penalty for any of the infractions listed in the **Reference Tables – Table 6 – Summary of Major Penalties that Result in an Automatic Game Misconduct**. See specific rule numbers for complete descriptions.

When a player has been assessed a major penalty for any of the infractions listed in the **Reference Tables – Table 7 – Summary of Major Penalties that Result in an Automatic Game Misconduct When There is an Injury** and his opponent has suffered an injury, a game misconduct must also be assessed. See specific rule numbers for complete descriptions.

When a major and automatic game misconduct are assessed, the player shall be ruled off the rink for the balance of the game, but a substitute shall be permitted to replace the player so suspended after five (5) minutes have elapsed.

20.5 **Infractions** - Refer to the **Reference Tables – Table 5 – Summary of Major Penalties** for a list of the infractions that can result in a major penalty being assessed (see specific rule numbers for complete descriptions).

Rule 21 Match Penalties

21.1 **Match Penalty** - A match penalty involves the suspension of a player for the balance of the game and the offender shall be ordered to the dressing room immediately.

A match penalty shall be imposed on any player who deliberately attempts to injure or who deliberately injures an opponent, an opposing Club official, or any on- or off-rink official in any manner.

21.2 **Short-handed** - A substitute player is permitted to replace the penalized player after five (5) minutes playing time has elapsed.

The match penalty, plus any additional penalties, shall be served by a player to be designated by the Manager or Coach of the offending team through the playing Captain, such player to take his place in the penalty box immediately.

SECTION 4

For all match penalties, regardless of when imposed, or prescribed additional penalties, a total of ten (10) minutes shall be charged in the records on the Official Game Report against the offending player.

In addition to the match penalty, the player shall be automatically suspended from further competition until the USARS Disciplinary Committee has ruled on the issue. See also **Rule 29 – Supplementary Discipline**.

- 21.3 **Reports** - Both Referees are required to report all match penalties and the surrounding circumstances in writing to the USARS District Referee-in-Chief and USARS Disciplinary Committee within forty-eight (48) hours of the game in which they occur.
- 21.4 **Infractions** - Refer to the **Reference Tables – Table 8 – Summary of Match Penalties** for a list of the infractions that can result in a match penalty being assessed (see specific rule numbers for complete descriptions).

Rule 22 Misconduct Penalties

- 22.1 **Misconduct Penalty** - In the event of misconduct penalties to any player except the goalkeeper, the player shall be ruled off the rink for a period of ten (10) minutes. A substitute player is permitted to immediately replace a player serving a misconduct penalty. A player whose misconduct penalty has expired shall remain in the penalty box until the next stoppage of play.
- 22.2 **Misconduct Penalty - Goalkeeper** - Should a goalkeeper on the rink incur a misconduct penalty, this penalty shall be served by another member of his team who was on the rink when the offense was committed. This player is to be designated by the Manager or Coach of the offending team through the Captain.
- 22.3 **Short-handed** - A player receiving a misconduct penalty does not cause his team to play short-handed unless he also receives a minor, major, or match penalty in addition to the misconduct penalty.

When a player receives a minor penalty and a misconduct penalty at the same time, the penalized team shall immediately put a substitute player on the penalty bench and he shall serve the minor penalty without change. Should the opposing team score during the time the minor penalty is being served, the minor penalty shall terminate (unless **Rule 15.4** is applicable) and the misconduct to the originally penalized player shall commence immediately.

When a player receives a major penalty and a misconduct penalty at the same time, the penalized team shall place a substitute player on the penalty bench before the major penalty expires and no replacement for the penalized player shall be permitted to enter the game except from the penalty bench.

- 22.4 **Reporting** - All misconduct penalties assessed for abuse of officials must be reported in writing to the proper USARS or league directors.
- 22.5 **Infractions** - Refer to the **Reference Tables – Table 9 – Summary of Misdemeanor Penalties** for a list of the infractions that can result in a misconduct penalty being assessed (see specific rule numbers for complete descriptions).

Rule 23 **Game Ejection Penalties**

- 23.1 **Game Ejection Penalties** - A game ejection penalty involves the removal of a player for the balance of the game but a substitute is permitted to replace immediately the player so removed. A total of ten (10) minutes shall be charged in the records on the Official Game Report against the offending player.
- 23.2 **Automatic Game Ejection** - Any player that receives three (3) penalties of any kind (except for misconduct penalties) in a single game shall automatically be assessed a game ejection penalty.
- 23.3 **Suspension** - No additional suspension shall be assessed to a player receiving a game ejection penalty.

Rule 24 **Game Misdemeanor Penalties**

- 24.1 **Game Misdemeanor Penalty** - A game misconduct penalty involves the suspension of a player for the balance of the game but a substitute is permitted to replace immediately the player so removed. A total of ten (10) minutes shall be charged in the records on the Official Game Report against the offending player.
- 24.2 **Suspension** - Any player assessed a game misconduct shall also be assessed an automatic one game suspension, to be served in the immediate next game already listed on the team schedule.
- 24.3 **Automatic Game Misdemeanor** - See **Rule 20.4**.

SECTION 4

24.4 **Infractions** - For a list of infractions involving game misconducts that are included in the “General Category”, please refer to the Reference Tables – **Table 10 – Summary of Game Misconduct Fouls Included in the “General Category.”** See specific rule numbers for complete descriptions.

For a list of stick-related infractions that result in a game misconduct, refer to the Reference Tables – **Table 11 – Summary of Game Misconduct Fouls Included in the “Stick-Related Category.”** See specific rule numbers for complete descriptions.

Refer to the Reference Tables – **Table 12 – Summary of Game Misconduct Penalties** for a list of the infractions that can result in a game misconduct penalty being assessed (see specific rule numbers for complete descriptions).

In addition, the following list of infractions can also result in a game misconduct penalty being assessed:

- (i) *interfering with or striking a spectator*
- (ii) *racial taunts or slurs*
- (iii) *spitting on or at an opponent or spectator*

24.5 **Reporting** - All game misconduct penalties must be reported in writing to the proper USARS or league directors, who shall have full power to impose further suspensions as they deem appropriate.

Rule 25 **Penalty Shot**

25.1 **Penalty Shot** - A penalty shot is designed to restore a scoring opportunity which was lost as a result of a foul being committed by the offending team, based on the parameters set out in these rules.

25.2 **Procedure** - The Referee shall ask to have announced over the public address system the name of the player designated by him or selected by the team entitled to take the shot (as appropriate). He shall then place the puck on the center face-off spot and the player taking the shot will, on the instruction of the Referee (by blowing his whistle), play the puck from there and shall attempt to score on the goalkeeper. The puck must be kept in motion towards the opponent’s goal line and once it is shot, the play shall be considered complete. No goal can be scored on a rebound of any kind (an exception being the puck off the goal post or crossbar, then the goalkeeper and then directly into the goal), and any time the puck

crosses the goal line or comes to a complete stop, the shot shall be considered complete.

The lacrosse-like move whereby the puck is picked up on the blade of the stick and “whipped” into the net shall be permitted provided the puck is not raised above the height of the shoulders at any time and when released, is not carried higher than the crossbar. See also **Rule 77.1**.

The “spin-o-rama” type move where the player completes a 360° turn as he approaches the goal shall be permitted as this involves continuous motion.

Only a player designated as a goalkeeper or alternate goalkeeper may defend against the penalty shot.

The goalkeeper must remain in his crease until the player taking the penalty shot has touched the puck.

If at the time a penalty shot is awarded, the goalkeeper of the penalized team has been removed from the rink to substitute another player, the goalkeeper shall be permitted to return to the rink before the penalty shot is taken.

The team against whom the penalty shot has been assessed may replace their goalkeeper to defend against the penalty shot, however, the substitute goalkeeper is required to remain in the game until the next stoppage of play.

While the penalty shot is being taken, players of both sides shall withdraw to the sides of the rink and in front of their own player’s bench.

25.3 **Designated Player** - In cases where a penalty shot has been awarded to a player specifically fouled, that player shall be designated by the Referee to take the penalty shot.

In all other cases where a penalty shot has been awarded, the penalty shot shall be taken by a player selected by the Captain of the non-offending team from the players on the rink at the time when the foul was committed. Such selection shall be reported to the Referee and cannot be changed.

If by reason of injury, the player designated by the Referee to take the penalty shot is unable to do so within a reasonable time, the shot may be taken by a player selected by the Captain of the non-offending team from the players on the rink when the foul was committed. Such selection shall be reported to the Referee and cannot be changed.

SECTION 4

Should the player in respect to whom a penalty shot has been awarded himself commit a foul in connection with the same play or circumstances, either before or after the penalty shot has been awarded, be designated to take the shot, he shall first be permitted to do so before being sent to the penalty bench to serve the penalty, except when such penalty is for a game misconduct or match penalty, in which case the penalty shot shall be taken by a player selected by the Captain of the non-offending team from the players on the rink at the time when the foul was committed.

- 25.4 **Violations During the Shot** - Should the goalkeeper leave his crease prior to the player taking the penalty shot has touched the puck, and in the event of violation of this rule or any foul committed by a goalkeeper, the Referee shall allow the shot to be taken and if the shot fails, he shall permit the penalty shot to be taken over again. When an infraction worthy of a minor penalty is committed by the goalkeeper during the penalty shot that causes the shot to fail, no penalty is to be assessed but the Referee shall permit the shot to be taken over again. Should a goalkeeper commit a second violation during the penalty shot and the shot fails, he shall be assessed a misconduct penalty and the Referee shall award an automatic goal.

When a major or match penalty is committed by the goalkeeper that causes the shot to fail, the Referee shall permit the shot to be taken over again and the appropriate penalties shall be assessed to the goalkeeper.

The goalkeeper may attempt to stop the shot in any manner except by throwing his stick or any object, or by deliberately dislodging the goal, in which case a goal shall be awarded.

If, while the penalty shot is being taken, any player, Coach or non-playing Club personnel of the opposing team shall have by some action interfered with or distracted the player taking the shot and, because of such action, the shot should have failed, a second attempt shall be permitted and the Referee shall impose a bench minor penalty to the offending team, and if a player on the bench is responsible, a misconduct penalty on the player so interfering or distracting shall be assessed. For a second violation, the Referee shall award an automatic goal.

If, while the penalty shot is being taken, any player, goalkeeper, Coach or non-playing Club personnel of the team taking the shot shall have by some action interfered with or distracted the goalkeeper defending the shot and, because of such action, the shot was successful, the Referee shall rule no goal and shall impose a bench minor penalty to the offending team, and if a player or goalkeeper on the bench is responsible, a misconduct penalty on the player or goalkeeper

so interfering or distracting shall be assessed.

If, while the penalty shot is being taken, a spectator throws any object onto the rink or, in the judgment of the Referee, interferes with the player taking the shot or the goalkeeper defending the shot, he shall permit the shot be taken again.

- 25.5 **Face-Off Location** - If a goal is scored from a penalty shot, the puck shall be faced-off at the center face-off spot. If a goal is not scored, the puck shall be faced-off at either of the end face-off spots in the zone in which the penalty shot was tried.
- 25.6 **Results** - Should a goal be scored from a penalty shot, a further penalty to the offending player or goalkeeper shall not be applied unless the offense for which the penalty shot was awarded was such as to incur a major, match, or misconduct penalty, in which case the penalty prescribed for the particular offense shall be imposed.

If the offense for which the penalty shot was awarded was such as to normally incur a minor penalty, then regardless of whether the penalty shot results in a goal or not, no further minor penalty shall be served.

If the offense for which the penalty shot was awarded was such as to incur a double-minor penalty, or where the offending team is assessed an additional minor penalty on the same play in which a penalty shot was awarded, the first minor penalty is not assessed since the penalty shot was awarded to restore the lost scoring opportunity. The second minor penalty would be assessed and served regardless of whether the penalty shot results in a goal. This will be announced and reported on the Official Game Report as a double-minor penalty for the appropriate foul and the player will serve two (2) minutes only.

No penalty shall expire when a goal is scored against a team on a penalty shot.

Should two penalty shots be awarded to the same team at the same stoppage of play (two separate fouls), only one goal can be scored or awarded at a single stoppage of play. Should the first penalty shot result in a goal, the second shot would not be taken but the appropriate penalty would be assessed and served for the infraction committed.

SECTION 4

25.7 **Timing** - If the foul upon which the penalty shot is based occurs during actual playing time, the penalty shot shall be awarded and taken immediately in the usual manner notwithstanding any delay occasioned by a slow whistle by the Referee to allow play to continue until the attacking side has lost possession of the puck to the defending side, which delay results in the expiry of the regular playing time in any period.

The time required for the taking of a penalty shot shall not be included in the regular playing time or overtime.

25.8 **Infractions** - Refer to the **Reference Tables – Table 13 – Summary of Penalty Shots** for a list of the infractions that shall result in a penalty shot being awarded (see specific rule numbers for complete descriptions).

There are four (4) specific conditions that must be met in order for the Referee to award a penalty shot for a player being fouled from behind. They are:

- (i) *The infraction must have taken place in the puck carrier's attacking zone;*
- (ii) *The infraction must have been committed from behind;*
- (iii) *The player was in possession and control of the puck without a defending player between himself and the opposing goal;*
- (iv) *The player in possession and control of the puck must have been denied a reasonable chance to score (the fact that he got a shot off does not automatically eliminate this play from the penalty shot consideration criteria. If the foul was from behind and he was denied a "more" reasonable scoring opportunity due to the foul, then the penalty shot should be awarded).*

Rule 26 **Awarded Goals**

26.1 **Awarded Goal** - A goal will be awarded to the attacking team when the opposing team has taken their goalkeeper off the rink and an attacking player has possession and control of the puck in the attacking zone, without a defending player between himself and the opposing goal, and he is prevented from scoring as a result of an infraction committed by the defending team (see **Rule 26.3 Infractions - When Goalkeeper is Off the Rink**, below).

- 26.2 **Infractions - When Goalkeeper is On the Rink** - A goal will be awarded when an attacking player, in the act of shooting the puck into the goal (between the normal position of the posts and completely across the goal line), is prevented from scoring as a result of a defending player or goalkeeper displacing the goal post, either deliberately or accidentally.
- 26.3 **Infractions - When Goalkeeper is Off the Rink** - Refer to the **Reference Tables - Table 14 - Summary of Awarded Goals (When Goalkeeper has been Removed for an Extra Attacker)** for a list of the infractions that shall result in an awarded goal being awarded when the goalkeeper has been removed for an extra attacker (see specific rule numbers for complete descriptions).
- 26.4 **Infractions - During the Course of a Penalty Shot** - A goal will be awarded when a goalkeeper attempts to stop a penalty shot by throwing his stick or any other object at the player taking the shot, by deliberately dislodging the goal, or by removing his helmet or face mask.

Rule 27 **Delayed Penalties**

- 27.1 **Delayed Penalty** - If a third player of any team shall be penalized while two players of the same team are serving penalties, the penalty time of the third player shall not commence until the penalty time of one of the two players already penalized has elapsed. Nevertheless, the third penalized player must at once proceed to the penalty bench. He may be substituted for on the rink so as to keep the on-rink strength at no less than two skaters for his team.
- 27.2 **Penalty Expiration** - When any team shall have three players serving penalties at the same time and because of the delayed penalty rule, a substitute for the third offender is on the rink, none of the three penalized players on the penalty bench may return to the rink until play has stopped. When play has been stopped, the player whose full penalty has expired may return to the rink.

During the play, the Penalty Timekeeper shall permit the return to the rink of the penalized players, in the order of expiry of their penalties, but only when the penalized team is entitled to have more than two players on the rink. Otherwise, these players must wait until the first stoppage of play after the expiration of their penalties in order to be released from the penalty bench.

SECTION 4

When the penalties of two players of the same team will expire at the same time, the Captain of that team will designate to the Referee which of such players will return to the rink first and the Referee will instruct the Penalty Timekeeper accordingly (this is done to expedite the release of a player from the penalty bench when the opposing team scores on the power-play).

- 27.3 **Major and Minor Penalty** - When a major and a minor penalty are imposed at the same time on different players of the same team, the Penalty Timekeeper shall record the minor as being the first of such penalties.

Rule 28 **Goalkeeper's Penalties**

- 28.1 **Minor Penalty to Goalkeeper** - A goalkeeper shall not be sent to the penalty bench for an offense which incurs a minor penalty, but instead, the minor penalty shall be served by another member of his team who was on the rink when the offense was committed. This player is to be designated by the Manager or Coach of the offending team through the playing Captain and such substitute shall not be changed.

A penalized player may not serve a goalkeeper's penalty.

- 28.2 **Major Penalty to Goalkeeper** - A goalkeeper shall not be sent to the penalty bench for an offense which incurs a major penalty, but instead, the major penalty shall be served by another member of his team who was on the rink when the offense was committed. This player is to be designated by the Manager or Coach of the offending team through the playing Captain and such substitute shall not be changed.

Should a goalkeeper incur two major penalties in one game, he shall be ruled off the rink for the balance of the playing time under **Rule 20.4** and his place shall be taken by a member of his own team, or by a regular substitute goalkeeper who is available. Such player will be allowed the goalkeeper's equipment.

- 28.3 **Misconduct Penalty to Goalkeeper** - Should a goalkeeper on the rink incur a misconduct penalty, this penalty shall be served by another member of his team who was on the rink when the offense was committed. This player is to be designated by the Manager or Coach of the offending team through the Captain.
- 28.4 **Game Misconduct Penalty to Goalkeeper** - Should a goalkeeper incur a game misconduct penalty, his place will then be taken by a member of his own team, or by a regular substitute goalkeeper who is available, and such player will be allowed the goalkeeper's full equipment.

- 28.5 **Match Penalty to Goalkeeper** - Should a goalkeeper incur a match penalty, his place will then be taken by a member of his own team, or by a substitute goalkeeper who is available, and such player will be allowed the goalkeeper's full equipment.

The match penalty, and any additional penalties assessed to the goalkeeper, shall be served immediately by a member of the team on the rink when the offenses were committed. This player shall be designated by the Manager or Coach of the offending team through the Captain. However, when the match penalty is coincidental with a match or major penalty to the opposing team, no player is required to proceed to the penalty bench to serve the goalkeeper's match penalty.

- 28.6 **Leaving Goal Crease** - A minor penalty shall be imposed on a goalkeeper who leaves the immediate vicinity of his crease during an altercation. However, should the altercation occur in or near the goalkeeper's crease, the Referee should direct the goalkeeper to a neutral location and not assess a penalty for leaving the immediate vicinity of the goal crease. Equally, if the goalkeeper is legitimately outside the immediate vicinity of the goal crease for the purpose of proceeding to the players' bench to be substituted for an extra attacker, and he subsequently becomes involved in an altercation, the minor penalty for leaving the crease would not be assessed.

In addition, during stoppages of play in the game, he must not proceed to his players' bench for the purpose of receiving a replacement stick or equipment or repairs thereto, or due to an injury, or to receive instructions, without first obtaining permission to do so from the Referee. Otherwise, he must be replaced by the substitute goalkeeper immediately (without any delay) or be assessed a bench minor penalty for delay of game.





- 28.7 **Participating in the Play Over the Center Red Line** - If a goalkeeper participates in the play in any manner (intentionally plays the puck or interferes with an opponent) when he is beyond the center red line, a minor penalty shall be imposed upon him. The position of the puck is the determining factor for the application of this rule.
- 28.8 **Infractions – Unique to Goalkeepers** – Refer to the **Reference Tables – Table 15 – Summary of Goalkeeper Penalties** for a list of the infractions that shall result in a penalty to the goalkeeper (see specific rule numbers for complete descriptions).

SECTION 4







Rule 29 **Supplementary Discipline**

29.I **Supplementary Discipline** - In addition to the automatic suspensions imposed under these rules, the USARS or local league directors may, at their discretion, investigate any incident that occurs in connection with any game and may assess additional suspensions for any offense committed during the course of a game or any aftermath thereof by a player, goalkeeper, Trainer, Manager, Coach or non-playing Club official, whether or not such offense has been penalized by the Referee.





Rule 30 **Signals**

30.1	Boarding	Striking the clenched fist of one hand into the open palm of the opposite hand in front of the chest.	
30.2	Butt-ending	Moving the forearm, fist closed, under the forearm of the other hand held palm down.	
30.3	Charging	Rotating clenched fists around one another in front of the chest.	
30.4	Checking from behind	A forward motion of both arms, with the palms of the hands open and facing away from the body, fully extended from the chest at shoulder level.	







TYPES OF PENALTIES

30.5	Clipping	Striking leg with either hand behind the knee, keeping both skates on the rink.	
30.6	Cross-checking	A forward and backward motion of the arms with both fists clenched, extending from the chest for a distance of about one foot.	
30.7	Delayed penalty	Extending the non-whistle arm fully above the head.	
30.8	Delaying the game	The non-whistle hand, palm open, is placed across the chest and then fully extended directly in front of the body	
30.9	Elbowing	Tapping either elbow with the opposite hand.	
30.10	Goal scored	A single point directed at the goal in which the puck legally entered.	





SECTION 4

30.11	Hand pass	With the palm open and facing forward, a pushing motion towards the front of the body once or twice to indicate the puck was moved ahead with the hand.	
30.12	Head-butting	No signal in USARS playing rules.	NO SIGNAL
30.13	High-sticking	Holding both fists clenched, one slightly above the other (as if holding a stick) at the height of the forehead.	
30.14	Holding	Clasping either wrist with the other hand in front of the chest.	
30.15	Holding the stick	Two stage signal involving the holding signal (30.14) followed by a signal indicating you are holding onto a stick with two hands in a normal manner.	
30.16	Hooking	A tugging motion with both arms as if pulling something from in front toward the stomach.	

TYPES OF PENALTIES

30.17	Interference	Crossing arms stationary in front of the chest in an "X" formation.	
30.18	Kicking	No signal in the USARS playing rules.	NO SIGNAL
30.19	Kneeing	Slapping either knee with the palm of the hand, while keeping both skates on the rink.	
30.20	Match penalty	Palm of the hand on the top of the helmet.	
30.21	Misconduct	Both hands on hips.	
30.23	Roughing	Fist clenched and arm extended out to the side of the body.	
30.24	Slashing	A chopping motion with the edge of one hand across the opposite forearm.	

SECTION 4

30.25	Spearing	Jabbing motion with both hands thrust out immediately in front of the body and then hands dropped to the side of the body.	
30.26	Throwing equipment	No signal in the USARS playing rules.	NO SIGNAL
30.27	Time-out	Using both hands to form a "T" in front of the chest.	
30.28	Too many men on the rink	No signal in the USARS playing rules.	NO SIGNAL
30.29	Tripping	Striking leg with either hand below the knee, keeping both skates on the rink.	
30.30	Unsports-manlike conduct	Using both hands to form a "T" in front of the chest (same as time-out).	
30.31	Wash out	A sweeping sideways motion of both arms across the front of the body at shoulder level with palms down. This signal is used by Referees to signal no goal and to wash out a hand pass or a high-sticking the puck violation.	



Section 5: Officials

Rule 31 Appointment of Officials

- 31.1 **Appointment of Officials** - All Referees and Officials operating within USARS sanctioned events must be properly certified and registered for the current season by means of attending an official USARS certification seminar and/or through successful completion of any applicable exams and tests.

Two Referees shall be used in all games, one which will be named as the Chief Referee, one which will be named as the Assistant Referee.

All Referees and Officials must be treated with proper respect and courtesy at all times during the season by all players and officials of Clubs.

Rule 32 Referees

- 32.1 **Attire and Equipment** - All Referees shall be dressed in black trousers, black skates with white laces, official sweaters with the current USARS crest in a conspicuous location on the upper left portion of the chest, orange arm bands, and a black helmet designed for hockey. It is recommended that a Referee number be affixed to the back of the official's sweater.

They shall be equipped with approved metal finger whistles and a tape measure.

- 32.2 **Disputes** - The Referees shall have general supervision of the game and shall have full control of all game officials and players during the game, including stoppages; and in case of any dispute, their decision shall be final.

As there is a human factor involved in blowing the whistle to stop play, the Referee may deem the play to be stopped slightly prior to the whistle actually being blown. The fact that the puck may come loose or cross the goal line prior to the sound of the whistle has no bearing if the Referee has ruled that the play had been stopped prior to this happening.

In the event of any dispute regarding time or the expiration of penalties, the matter shall be referred to the Referee for adjustment and his decision shall be final.

- 32.3 **Face-offs** - One of the Referees shall face-off the puck to start each period and following each stoppage of play.

SECTION 5

- 32.4 **General Duties** - It shall be the duty of the Referees to impose such penalties as are prescribed by the rules for infractions thereof and they shall give the final decision in matters of disputed goals.
- 32.5 **Goals** - The Referees shall have announced over the public address system the reason for not allowing a goal every time the goal signal light is turned on in the course of play or when a goal is disallowed by means of an illegal play (i.e. kicked puck, high-stick on the puck, etc.). This shall be done at the first stoppage of play regardless of any standard signal given by the Referees when the goal signal light was put on in error.

The Referees shall report to the Official Scorer the name or number of the goal scorer and the name or number of the player credited with an assist. Only one assist may be credited per goal.

The name of the scorer and any player entitled to an assist will be announced over the public address system. In the event that the Referee disallows a goal for any violation of the rules, he shall report the reason for the disallowance to the Official Scorer who shall have announced the Referee's decision correctly over the public address system.

- 32.6 **Off-rink Officials** - The Referees shall, before starting the game, see that the appointed off-rink officials, including the Official Scorer, Game Timekeeper, Penalty Timekeeper, and the Goal Judges are in their respective places and ensure that the timing and signaling equipment are in order.
- 32.7 **Penalties** - The infraction of the rules for which each penalty has been imposed will be announced correctly, as reported by the Referee, over the public address system. Where players of both teams are penalized on the same play, the penalty to the visiting player will be announced first.

When a penalty is imposed by the Referee which calls for a suspension, only the time portion of the penalty will be reported by the Referee to the Official Scorer and announced over the public address system, and the appropriate suspension will be handled accordingly by the USARS or league directors.

- 32.8 **Players' Uniforms** - It shall be the duty of the Referees to see to it that all players are properly dressed, and that the approved regulation equipment is in use at all times during the game.

32.9 **Reports** - The Referee shall report to the USARS and/or league directors promptly and in detail the circumstances surrounding the following:

- (i) *The assessment of misconduct penalties for abuse of officials;*
- (ii) *The assessment of game misconduct penalties;*
- (iii) *The assessment of match penalties;*
- (iv) *The assessment of an instigator penalty;*
- (v) *Any time a goalkeeper leaves his crease during an altercation;*
- (vi) *Any time a stick or other object is thrown outside the playing area;*
- (vii) *Any time a player, goalkeeper, or non-playing Club personnel is involved in an altercation with a spectator;*
- (viii) *Any unusual occurrence that takes place on or off the rink, before, during or after the game.*

32.10 **Start and End of Game and Periods** - The Referees shall order the teams on the rink at the appointed time for the beginning of a game and at the commencement of each period.

The Referees shall remain on the rink at the conclusion of each period and after the game until all players have proceeded to their dressing rooms.

The Referees shall check club rosters and all players in uniform before signing the Official Game Report.

32.11 **Unable to Continue** - Should a Referee accidentally leave the rink or receive an injury which incapacitates him from discharging his duties while play is in progress, the game shall be automatically stopped.

If, owing to illness or accident, one of the Referees is unable to continue to officiate, the remaining Referee shall perform the duties of the ill or injured Referee during the balance of the game. In the event that another properly registered and certified Referee is in attendance, the USARS or local league directors shall have the authority to substitute the injured Referee with the spare official.

If, through misadventure or sickness, the Referees appointed are prevented from appearing, the USARS or local league directors will make every attempt to find suitable replacement officials, otherwise, the Managers or Coaches of

SECTION 5

the two Clubs shall agree on Referee(s). If they are unable to agree, they shall appoint a player from each side who shall act as Referees; the player of the home Club acting as Chief Referee and the player of the visiting Club as Assistant Referee.

If the regularly appointed officials appear during the progress of the game, they shall at once replace the temporary officials.

Rule 33 **Chief Referee**

- 33.1 **General Duties** - The Chief Referee and Assistant Referee shall have similar duties, but the Chief Referee shall have full authority and final decision in all matters of dispute. The Chief Referee's decision shall be final on all questions of fact and not subject to appeal.

Rule 34 **Official Scorer**

- 34.1 **General Duties** - Before the start of the game, the Official Scorer shall obtain from the Manager or Coach of both teams a list of all eligible players and the starting line-up of each team, which information shall be made known to the opposing Manager or Coach before the start of play.

The Official Scorer shall secure the names of the Captain and Alternate Captains from the Manager or Coach at the time the line-ups are collected and will indicate those nominated by placing the letter "C" or "A" opposite their names on the Official Game Report.

The Official Scorer shall keep a record of the goals scored, the scorers, and players to whom assists have been credited and shall indicate those players on the lists who have actually taken part in the game.

On the Official Game Report, the Official Scorer must explain if the start of the game is delayed for any reason, any goalkeeper substitutions, time-outs, empty net goals, any delays in the playing of the game

At the conclusion of the game, the Official Scorer shall complete and sign the Official Game Report, secure the signatures of both Referees and the Coaches or Captains of both teams, and forward it to the appropriate USARS or local league directors.

- 34.2 **Goals and Assists** - The Official Scorer shall record points for goals and assists on the Official Game Report. The awards of points for goals and assists shall be announced over the public address system and all changes in such awards shall also be announced in the same manner.

No requests for changes in any award of points shall be considered unless they are made at or before the conclusion of actual play in the game by the Team Captain, or immediately following the game by a Team representative.

A goal is awarded to the last player on the scoring team to touch the puck prior to the puck entering the net. (A puck entering the net is considered to be between the posts, from in front of, and below the crossbar, and entirely across the goal line.)

An assist is awarded to the last player who touches the puck prior to the goal scorer, provided no defender plays or possesses the puck in between.

- 34.3 **Line-ups** - It is the policy of USARS that the Coach of the visiting club provide to the Official Scorer a list of eligible players, his starting line-up, and designated Captain and Alternates prior to the start of the game. The Coach of the home club will then provide the same information.
- 34.4 **Location** - The Official Scorer should view the game from a position well away from the players' benches with full view of the rink.
- 34.5 **Penalties** - The Official Scorer must help the Referees and Penalty Timekeeper with the numbers of the players on the rink, in the event a goalkeeper is assessed a penalty or a player is ejected from a game. He must also keep an eye on the players' benches during an altercation and record the numbers of any players who leave their respective players' or penalty benches and in the order that they so leave.

Rule 35 **Timekeeper**

- 35.1 **General Duties** - The Game Timekeeper shall record the time of starting and finishing of each period in the game. During the game the Game Timekeeper will start the clock with the drop of the puck and stop the clock upon hearing the officials' whistle or the scoring of a goal.

The Game Timekeeper shall cause to be announced over the public address system that there is one minute remaining to be played in the period.

SECTION 5

* **NOTE** - *In games where a running clock is used, the clock shall only be stopped for injuries, time-outs, in the last minute of the last period when the game is tied or there is a one goal differential, or when directed by the Referee.*

35.2 **Intermissions** - The Game Timekeeper shall record a one (1) minute rest period on the clock between periods, at which time both teams must remain at their respective benches. The time shall commence immediately following the end of the period.

* **NOTE** - *Individual leagues and tournaments have the authority to apply their own procedures regarding game and intermission timing.*

35.3 **Overtime** - At the end of regulation during a tied match, for games where a tie is not desirable, the Game Timekeeper shall record a one (1) minute rest period on the clock. At the conclusion, the teams will play a ten (10) minute sudden-death playoff. If no team has scored after ten (10) minutes, another one (1) minute rest shall commence, the teams shall change ends, and begin another ten (10) minute sudden-death playoff. This shall continue until a winner is determined. (See Rule 79 – Overtime)

* **NOTE** - *Individual leagues and tournaments shall have the authority to apply their own overtime procedures, including the inclusion of a shoot-out.*

35.4 **Signal Devices** - If the arena is not equipped with an automatic signaling device or, if such device fails to function, the Game Timekeeper shall signal the end of each period by blowing a whistle.

35.5 **Start of Periods** - The Game Timekeeper shall signal the Referees and the competing teams for the start of the game and each succeeding period and the Referees shall start the play promptly in accordance with **Rule 74 – Game and Intermission Timing**.

35.6 **Verification of Time** - Any loss of time on the game or penalty clocks due to a false face-off must be replaced as appropriate.

In the event of any dispute regarding time, the matter shall be referred to the Referees for adjudication and their decision shall be final. The Game Timekeeper shall assist to verify game time using an additional timing device.

In the event that clock fails to operate when play resumes, the on-rink officials may elect to stop play provided there is no imminent scoring opportunity or wait until the next legitimate stoppage of play. In cooperation with the Game Timekeeper, the clock is to be re-set to the appropriate time.

Rule 36 **Penalty Timekeeper**

- 36.1 **General Duties** – The Penalty Timekeeper shall keep, on the Official Game Report, a correct record of all penalties imposed by the Referees including the names of the players penalized, the penalties assessed, the duration of each penalty, and the time at which each penalty was imposed.

The Penalty Timekeeper shall inform penalized players and the Penalty Box Attendants as to the correct expiration time of all penalties. In the event of a dispute regarding the time a player is permitted to return to the rink, the game clock is the determining time clock. For example, a player is assessed a minor penalty at the 12:00 mark. A stoppage of play occurs at the 10:00 mark, however, the penalty time clock shows one second remaining in the penalty. Since the game clock is the determining time clock, the penalized player shall be permitted to return to the rink.

The infraction of the rules for which each penalty has been imposed will be announced over the public address system as reported by the Referee. Where players of both teams are penalized at the same time, the penalty to the visiting player will be announced first. In situations where multiple game misconducts have been assessed to any one player at the same stoppage of play, only one game misconduct should be announced.

Misconduct penalties and coincident penalties should not be recorded on the timing device (penalty time clock) but such penalized players should be alerted and released at the first stoppage of play following the expiration of their penalties.

When a player is assessed a misconduct in addition to other penalties, the misconduct shall only commence after all other penalties have been served (or washed out by the scoring of a goal).

If a player inadvertently leaves the penalty bench before the time has expired, the Penalty Timekeeper must note the time and notify the Referees at his first opportunity.

It is the responsibility of the Penalty Timekeeper to ensure that penalized players return to the penalty box before the puck is dropped for the start of a new period. In the event that a penalized player is not in the penalty box, the Penalty Timekeeper should notify the Referees and prevent the game from resuming until the player is there.

SECTION 5

- 36.2 **Equipment** - The Penalty Timekeeper shall have a tape measure available for the Referees use during the game.
- 36.3 **Goalkeeper's Penalties** - In the event that a goalkeeper is penalized, the penalty shall be served by another member of his team who was on the rink when the offense was committed. Communication with the Official Scorer and/or Game Timekeeper is important at this time as they can inform the Penalty Timekeeper who was actually on the rink to ensure only the proper players can serve the time. In all matters of dispute, the Chief Referee shall have the final decision.
- 36.4 **Penalty Shot** - He shall report on the Official Game Report each penalty shot awarded, the name of the player taking the shot and the result of the shot.
- 36.5 **Penalty Time Clock** - He shall be responsible for the correct posting of penalties on the scoreboard at all times and shall promptly call to the attention of the Referees any discrepancy between the time recorded on the clock and the official correct time and he shall be responsible for making any adjustments ordered by the Referees.
- In the event that two players from one team and one player from the opposing team are penalized at the same time, the Penalty Timekeeper shall request through the Referee or the offending team's Captain, which penalty they prefer to have on the timing device.
- 36.7 **Reports** - Prior to each game, the Penalty Timekeeper shall obtain copies of the Suspension Report provided by USARS or the local league (as applicable), retain one copy and provide one to the Referees, and shall ensure no suspended players are listed on the Playing Roster or participate in the game.

Rule 37 Goal Judge

- 37.1 **General Duties** - He shall signal, normally by means of red light, his decision as to whether the puck passed between the goal posts and entirely over the goal line. His only decision is whether the puck actually entered the net, not how or when it went in. The light must be illuminated for a period of five (5) seconds each time the puck enters the net regardless of circumstances. It is up to the Referees to decide if it is a goal.
- 37.2 **Communication** - The Goal Judge must be available to speak to the Referees in the event that the Referees find it necessary to consult with him.

37.3 **Location** - There shall be one Goal Judge situated behind each goal, in properly protected areas, if possible, so that there can be no interference with their activities. They shall not change goals during the game.

Rule 38 Abuse of Officials

38.1 **General Description** - A player, goalkeeper, Coach or non-playing Club official shall not challenge or dispute the rulings of an official before, during, or after a game. A player, goalkeeper, Coach or non-playing Club official shall not display unsportsmanlike conduct including, but not limited to, obscene, profane, or abusive language or gestures, comments of a personal nature intended to degrade an official, or persist in disputing a ruling after being told to stop or after being penalized for such behavior.

* **NOTE** - *When such conduct is directed at anyone other than an official, **Rule 72 – Unsportsmanlike Conduct** shall be applied.*

38.2 **Minor Penalty** - A minor penalty for unsportsmanlike conduct shall be assessed under this rule for the following infractions:

- (i) *Any player who challenges or disputes the ruling of an official.*
- (ii) *Any identifiable player who uses obscene, profane, or abusive language or gestures directed at any on- or off-rink official.*
- (iii) *Any player who bangs the boards with his stick or other object at any time, or who, in any manner shows disrespect for an official's decision. If this is done in order to get the attention of the on-rink officials for a legitimate reason (i.e. serious injury, illness, etc.), then discretion must be exercised by the Referees.*
- (iv) *When a Captain, Alternate Captain, or any other player comes off the players' bench to question or protest a ruling by an official on the rink.*
- (v) *If a penalized player is assessed an additional unsportsmanlike conduct penalty either before or after he begins serving his original penalty(ies), the additional minor penalty is added to his unexpired time and served consecutively.*

SECTION 5

38.3 **Bench Minor Penalty** - A bench minor penalty for unsportsmanlike conduct shall be assessed under this rule for the following infractions:

- (i) *Any Coach or non-playing Club official who bangs the boards with a stick or other object at any time, showing disrespect for an official's decision. If this is done in order to get the attention of the on-rink officials for a legitimate reason (i.e. serious injury, illness, etc.), then discretion must be exercised by the Referees.*
- (ii) *Any unidentifiable player or any Coach or non-playing Club official who uses obscene, profane, or abusive language or gesture directed at an on- or off-rink official or uses the name of any official coupled with any vociferous remarks.*
- (iii) *Any player, Coach, or non-playing Club official interferes in any manner with any game official including the Referees, Game or Penalty Timekeepers, or Goal Judges in the performance of their duties.*

38.4 **Misconduct Penalty** - Misconduct penalties shall be assessed under this rule for the following infractions:

- (i) *Any player who persists in the use of obscene, profane, or abusive language towards any on- or off-rink official for which he has already been assessed a minor or bench minor penalty for unsportsmanlike conduct.*
- (ii) *Any player who intentionally knocks or shoots the puck out of the reach of an official who is retrieving it.*
- (iii) *Any player who, after being assessed an unsportsmanlike conduct minor penalty, persists in challenging or disputing the ruling of an official.*
- (iv) *Any player or players who bang the boards with their sticks or other objects at any time, showing disrespect for an official's decision, for which they have already been assessed a minor or bench minor penalty for unsportsmanlike conduct.*
- (v) *Any player or players who, except for the purpose of taking their positions on the penalty bench, enter or remain in the Referee's crease while he is reporting to or consulting with any game official including the other Referee, Game Timekeeper, Penalty Timekeeper, Official Scorer, or Public Address Announcer.*
- (vi) *A misconduct penalty (or game misconduct penalty at the discretion of the Referee) shall be imposed on any player who deliberately throws any equip-*

ment out of the playing area. When this is done in protest of an official's ruling, a minor penalty plus a game misconduct shall be assessed.

- (vii) In general, participants displaying this type of behavior are assessed a minor penalty, then a misconduct penalty, and then a game ejection and/or game misconduct penalty (in that order) if they persist.*

38.5 Game Ejection Penalty - Game ejection penalties shall be assessed under this rule for the following infractions:

- (i) Any player who, after being assessed a misconduct penalty, persists in challenging or disputing the ruling of an official.*
- (ii) When a Coach or non-playing Club official uses obscene, profane, or abusive language or gesture directed at any on- or off-rink official or uses the name of any official coupled with any vociferous remarks, after already being assessed a bench minor penalty (Rule 38.3 (ii)), this Coach or non-playing Club official is to be assessed a game ejection penalty.*
- (iii) When a player receives three (3) penalties of any kind (except a misconduct penalty) in a single game, a game ejection penalty shall be assessed.*
- (iv) At the Referee's discretion, a game misconduct penalty may be assessed in lieu of a game ejection to any player, Coach, or non-playing Club official for any of the above situations (with the exception of the 3 penalty rule – Rule 38.5 (iii)). Wide latitude is intentionally given to the Referees in these circumstances.*

38.6 Game Misconduct Penalty - Game misconduct penalties shall be assessed under this rule for the following infractions:

- (i) Any player who, after being assessed a misconduct penalty and/or game ejection penalty, persists in challenging or disputing the ruling of an official.*
- (ii) When a Coach or non-playing person uses obscene, profane, or abusive language or gesture directed at any on- or off-rink official or uses the name of any official coupled with any vociferous remarks, after already being assessed a bench minor penalty and/or game ejection penalty (Rule 38.5 (ii) or Rule 38.3 (ii)), this Coach or non-playing person is to be assessed a game misconduct penalty and the situation reported to the USARS Disciplinary Committee or proper league directors for further action. When this type of conduct occurs after the expiration of the game, on or off the rink, the game misconduct shall be applied without the necessity of having been assessed a bench minor penalty or game ejection penalty previously.*

SECTION 5

- (iii) *Any player who, having entered the penalty bench, leaves the penalty bench prior to the expiration of his penalty for the purpose of challenging an official's ruling, shall be assessed a game misconduct penalty. He shall also be automatically suspended for the next three (3) scheduled games of his Club. This rule does not replace any other more severe penalty that may be imposed for leaving the penalty bench for the purpose of starting or participating in an altercation. See Rule 67 – Leaving the Bench.*
- (iv) *Any player who deliberately applies physical force to an official solely for the purpose of getting free of such an official during or immediately following an altercation shall receive a game misconduct penalty and the guidelines set out in Rule 39 – Physical Abuse of Officials are to be applied.*
- (v) *A minor penalty for unsportsmanlike conduct plus a game misconduct shall be imposed on a player who throws his stick or any part thereof, or any other piece of equipment or object outside the playing area in protest of an official's decision.*
- (vi) *A minor penalty for unsportsmanlike conduct plus a game misconduct shall be imposed on any player or a bench minor penalty for unsportsmanlike conduct plus a game misconduct shall be imposed to any Coach or non-playing Club official who throws or shoots any equipment or other object from the bench onto the rink.*
- (vii) *In general, participants displaying this type of behavior are assessed a minor penalty, then a misconduct penalty, and then a game ejection penalty and/ or game misconduct penalty (in that order) if they persist.*

*** NOTE** - *Any player, Coach, or non-playing Club personnel penalized under this section may be subject to supplemental discipline under **Rule 29**.*

38.7 Match Penalty - Match penalties shall be assessed under this rule for the following infractions:

- (i) *Any player, Coach, or non-playing Club official who deliberately applies physical force in any manner against an official, deliberately injures or attempts to injure an official, or physically demeans an official shall be assessed a match penalty and shall be subject to supplemental discipline under **Rule 39 – Physical Abuse of Officials**.*
- (ii) *Any player, coach, or non-playing Club official who deliberately injures or attempts to injure an opponent or opposing team's Coach or non-playing Club official shall be assessed a match penalty.*

- (iii) *For all match penalties, both Referees must file a written report to the USARS District Referee-in-Chief and a written report to the USARS Disciplinary Committee within 48 hours following the game.*

38.8 Reports - It is the responsibility of all game officials to make a verbal report to the USARS District Referee-in-Chief and file a written report to the USARS Disciplinary Committee setting out the full details concerning the use of obscene gestures or language by any player, Coach or non-playing Club personnel. The USARS Disciplinary Committee or proper league authorities shall take such further disciplinary action as they shall deem appropriate.

Rule 39 **Physical Abuse of Officials**

- 39.1 Match Penalty** - Any player, coach, or non-playing Club official who deliberately applies physical force in any manner against an official, attempts to injure an official, physically demeans, or deliberately applies physical force to an official solely for the purpose of getting free of such an official during or immediately following an altercation shall receive a match penalty. In addition, the following (**Rules 39.2, 39.3, 39.4**) disciplinary penalties shall apply.
- 39.2 Automatic Suspension – Category I** - Any player, coach, or non-playing Club official who deliberately strikes an official and causes injury or who deliberately applies physical force in any manner against an official with intent to injure, or who in any manner attempts to injure an official shall be assessed a match penalty and automatically suspended from all USARS sanctioned events for not less than one (1) year. (For the purpose of the rule, “intent to injure” shall mean any physical force which a player, coach, or non-playing Club official knew or should have known could reasonably be expected to cause injury.)
- 39.3 Automatic Suspension – Category II** - Any player, coach, or non-playing Club official who deliberately applies physical force to an official in any manner (excluding actions as set out in Category I), which physical force is applied without intent to injure, or who spits on an official, shall be assessed a match penalty and automatically suspended for not less than six (6) months.
- 39.4 Automatic Suspension – Category III** - Any player, coach, or non-playing Club official who, by his actions, physically demeans an official or physically threatens an official by (but not limited to) throwing a stick or any other piece of equipment or object at or in the general direction of an official, shooting the puck at or in the general direction of an official, spitting at or in the general direction of an official, or who deliberately applies physical force to an official solely for

SECTION 5

the purpose of getting free of such an official during or immediately following an altercation shall be assessed a match penalty and suspended for not less than thirty (30) days.

- 39.5 **Automatic Suspension – Process** - Immediately after the game in which such match penalty is imposed, the Referees shall decide the category of the offense. They shall make a verbal report to the USARS District Referee-in-Chief and advise of the category and of the offense. In addition, they shall file a written report within 48 hours to the USARS Disciplinary Committee in which they may request a review as to the adequacy of the suspension. The USARS Disciplinary Committee will then hold a hearing (via conference-call or in person) with the Referees, any present league or tournament directors, and the player, Coach, or non-playing Club official so charged with the match penalty.

If a review of the incident does not result in a decision being rendered by the USARS Disciplinary Committee within thirty (30) days of the incident, the player, Coach, or non-playing Club official shall be immediately reinstated, after serving any automatic suspension, detailed in **Rules 39.2, 39.3, 39.4**.

After any review as called for hereby, the USARS Disciplinary Committee shall issue an order:

- (i) *sustaining the minimum suspension, or*
 - (ii) *increasing length of the suspension within the category, or*
 - (iii) *changing to a lower category, or*
 - (iv) *changing to a lower category and increasing the length of time within this category, or*
 - (v) *in the case of a Category III suspension only, reducing the length of time of the suspension.*
- 39.6 **Supplementary Discipline** - In the event that the player, coach, or non-playing Club official has committed more than one offense under this rule, in addition to the penalties imposed under this offense, his case shall be referred to the USARS Disciplinary Committee for consideration of supplementary disciplinary action.



Section 6: **Physical Fouls**

Rule 40 Boarding

40.1 **Boarding** - A boarding penalty shall be imposed on any player who checks an opponent in such a manner that causes the opponent to be thrown violently in the boards. The severity of the penalty, based upon the degree of violence of the impact with the boards, shall be at the discretion of the Referee.

There is an enormous amount of judgment involved in the application of this rule by the Referees. The onus is on the player to ensure his opponent is not in a vulnerable position and if so, he must avoid the contact.

40.2 **Minor Penalty** - The Referee, at his discretion, may assess a minor penalty, based on the degree of violence of the impact with the boards, to a player guilty of boarding an opponent.

40.3 **Major Penalty** - The Referee, at his discretion, may assess a major penalty, based on the degree of violence of the impact with the boards, to a player guilty of boarding an opponent (see **Rule 40.5**).

40.4 **Match Penalty** - The Referee, at his discretion, may assess a match penalty if, in his judgment, the player attempted to or deliberately injured his opponent by boarding.

40.5 **Game Misconduct Penalty** - When a major penalty is imposed under this rule for a foul resulting in an injury to the opponent, a game misconduct shall also be imposed.

40.6 **Suspensions** - If deemed appropriate, supplementary discipline can be applied by the proper USARS or local league directors at their discretion (refer to **Rule 29**).

Rule 41 Charging

41.1 **Charging** - A charging penalty shall be imposed on a player who skates or jumps into, or charges an opponent in any manner.

Charging shall mean the actions of a player who, as a result of distance traveled, shall violently check an opponent in any manner. A “charge” may be the result of a check into the boards, into the goal frame or in open rink.

A charging penalty shall be imposed on a player who charges a goalkeeper while the goalkeeper is within his goal crease.

SECTION 6

A goalkeeper is not “fair game” just because he is outside the goal crease area. The appropriate penalty should be assessed in every case where an opposing player makes unnecessary contact with a goalkeeper. However, incidental contact, at the discretion of the Referee, will be permitted when the goalkeeper is in the act of playing the puck outside his goal crease provided the attacking player has made a reasonable effort to avoid such contact.

- 4I.2 **Minor Penalty** - The Referee, at his discretion, may assess a minor penalty, based on the degree of violence of the check, to a player guilty of charging an opponent.
- 4I.3 **Major Penalty** - The Referee, at his discretion, may assess a major penalty, based on the degree of violence of the check, to a player guilty of charging an opponent (see **Rule 4I.5**).
- 4I.4 **Match Penalty** - The Referee, at his discretion, may assess a match penalty if, in his judgment, the player attempted to or deliberately injured his opponent by charging.
- 4I.5 **Game Misconduct Penalty** - When a major penalty is imposed under this rule for a foul resulting in an injury to an opponent, a game misconduct shall also be imposed.
- 4I.6 **Suspensions** - If deemed appropriate, supplementary discipline can be applied by the proper USARS or local league directors at their discretion (refer to **Rule 29**).

Rule 42 **Checking from Behind**

- 42.1 **Checking from Behind** - A check from behind is a check delivered on a player who is not aware of the impending hit, therefore unable to protect or defend himself, and contact is made on the back part of the body. When a player intentionally turns his body to create contact with his back, no penalty shall be assessed for checking from behind; however, another penalty may be assessed as appropriate.
- 42.2 **Minor Penalty Plus a Misconduct** - A minimum of a minor penalty plus a misconduct shall be assessed to any player who intentionally pushes, checks, cross-checks, or charges an opposing player from behind.
- 42.3 **Major Penalty** - The Referee, at his discretion, may assess a major penalty, based on the degree of violence of the check, to any player guilty of checking an opposing player from behind.

- 42.4 **Match Penalty** - The Referee, at his discretion, may assess a match penalty if, in his judgment, the player attempted to or deliberately injured his opponent by checking from behind.
- 42.5 **Major Penalty Plus a Game Misconduct** - A major penalty plus a game misconduct penalty must be assessed to any player guilty of checking an opposing player from behind head first into the boards or the goal frame.
- When a player is injured as a result of a check from behind (whether into the boards, goal frame, or in the open rink), a major penalty plus a game misconduct must be assessed.
- 42.6 **Suspensions** - If deemed appropriate, supplementary discipline can be applied by the proper USARS or local league directors at their discretion (refer to Rule 29).

Rule 43 Elbowing

- 43.1 **Elbowing** - Elbowing shall mean the use of an extended elbow in a manner that may or may not cause injury.
- 43.2 **Minor Penalty** - The Referee, at his discretion, may assess a minor penalty, based on the degree of violence, to a player guilty of elbowing an opponent.
- 43.3 **Major Penalty** - The Referee, at his discretion, may assess a major penalty, based on the degree of violence of the foul, to a player guilty of elbowing an opponent (see Rule 43.5).
- 43.4 **Match Penalty** - The Referee, at his discretion, may assess a match penalty if, in his judgment, the player attempted to or deliberately injured his opponent by elbowing.
- 43.5 **Game Misconduct Penalty** - When a major penalty is imposed under this rule for a foul resulting in an injury to an opponent, a game misconduct shall also be imposed.
- 43.6 **Suspensions** - If deemed appropriate, supplementary discipline can be applied by the proper USARS or local league directors at their discretion (refer to Rule 29).

Rule 44 Fighting

- 44.1 **Fighting** - A fight shall be deemed to have occurred when at least one player punches or attempts to punch an opponent repeatedly or when two players

SECTION 6

wrestle in such a manner as to make it difficult for the Referees to intervene and separate the combatants.

The Referees are provided very wide latitude in the penalties with which they may impose under this rule. This is done intentionally to enable them to differentiate between the obvious degrees of responsibility of the participants either for starting the fight or persisting in continuing the fight. The discretion provided should be exercised realistically.

- 44.2 **Altercation** - An altercation is a situation involving two players with at least one to be penalized.
- 44.3 **Clearing the Area of a Fight** - When a fight occurs, all players not engaged shall go immediately to the area of their players' bench and in the event the altercation takes place at a players' bench, the players on the rink from that team shall go to their defending zone. Goalkeepers shall remain in their goal crease, except in the event the altercation takes place in the vicinity of the goal crease, and therefore shall obey the directions of the Referee. Failure to comply can result in penalties incurred for their involvement in and around the area.
- 44.4 **Continuing or Attempting to Continue a Fight** - Any player who persists in continuing or attempting to continue a fight or altercation after he has been ordered by the Referee to stop, or who resists a Referee in the discharge of his duties shall, at the discretion of the Referee, incur a misconduct or game misconduct penalty in addition to any penalties imposed.
- 44.5 **Fighting After the Original Altercation** - A game misconduct penalty shall be imposed on any player who is assessed a major penalty for fighting after the original altercation has started.

Notwithstanding this rule, at the discretion of the Referee, the automatic game misconduct penalty may be waived for a player in the altercation if the opposing player was clearly the instigator of the altercation.

- 44.6 **Fighting Off the Playing Surface** - A misconduct penalty shall be imposed on any player involved in fighting off the playing surface or with another player who is off the playing surface. These penalties are in addition to any other time penalties assessed, including the major penalty and game misconduct for fighting.

Whenever a Coach or other non-playing Club personnel becomes involved in an altercation with an opposing player, Coach, or other non-playing Club

personnel on or off the rink, the Coach or other non-playing Club personnel shall be automatically suspended from the game, ordered to the dressing room, and the matter will be reported to the USARS Disciplinary Committee for further disciplinary action.

- 44.7 **Instigator** - An instigator of an altercation shall be a player who by his actions or demeanor demonstrates any/some of the following criteria: distance traveled; gloves off first; first punch thrown; menacing attitude or posture; verbal instigation or threats; conduct in retaliation to a prior incident; obvious retribution for a previous incident.

A player who is deemed to be the instigator of an altercation shall be assessed an instigating minor penalty, a major penalty for fighting, a misconduct, and a game misconduct.

- 44.8 **Major Penalty Plus a Game Misconduct** - A major penalty plus a game misconduct shall be imposed on any player who fights.

- 44.9 **Minor or Double-minor Penalty** - A minor or double-minor penalty for roughing shall be imposed on any player who, after having been struck, shall retaliate with a punch or attempted punch. However, at the discretion of the referee, a major penalty plus a game misconduct for fighting may be imposed should the player continue the altercation.

- 44.10 **Match Penalty** - Any player wearing tape or any other material on his hands (below the wrist) who cuts or injures an opponent during an altercation will receive a match penalty in addition to any other penalties imposed including for fighting under this rule.

A match penalty shall be assessed to a player who punches an unsuspecting opponent and causes an injury.

- 44.11 **Third Man In** - A game misconduct penalty, at the discretion of the Referee, shall be imposed on any player who is the first to intervene (third man in) in an altercation already in progress. This penalty is in addition to any other penalties incurred in the same incident.

This rule also applies to subsequent players who elect to intervene in the same or other altercations during the same stoppage of play.

- 44.12 **Leaving the Players' Bench** - A game misconduct penalty shall be imposed to the first player who leaves the players' bench during an altercation.

SECTION 6

Rule 45 **Head-butting**

- 45.1 **Head-butting** - The act of head-butting involves a player making intentional contact, or attempting to make contact, with an opponent by leading with his head and/or helmet.
- 45.2 **Major Penalty Plus a Game Misconduct** - A major penalty plus a game misconduct shall be imposed on a player who head-butts an opponent.
- 45.3 **Match Penalty** - A match penalty shall be imposed on a player who injures or attempts to injure an opponent as a result of a head-butt.
- 45.4 **Suspensions** - If deemed appropriate, supplementary discipline can be applied by the proper USARS or local league directors at their discretion (refer to **Rule 29**).

Rule 46 **Kicking**

- 46.1 **Kicking** - The action of a player deliberately using his skate(s) with a kicking motion to propel the puck or to contact an opponent.
- 46.2 **Goals** - Kicking the puck shall be permitted in all zones. A goal cannot be scored by an attacking player who uses a distinct kicking motion to propel the puck into the net. A goal cannot be scored by an attacking player who kicks a puck that deflects into the net off any player, goalkeeper, or official.

A puck that deflects into the net off an attacking player's skate who does not use a distinct kicking motion is a legitimate goal. A puck that is directed into the net by an attacking player's skate shall be a legitimate goal as long as no distinct kicking motion is evident. The following should clarify deflections following a kicked puck that enters the goal:

- (i) *A kicked puck that deflects off the body of any player of either team (including the goalkeeper) shall be ruled no goal.*
- (ii) *A kicked puck that deflects off the stick of any player (excluding the goalkeeper's stick) shall be ruled a good goal.*
- (iii) *A goal will be allowed when an attacking player kicks the puck and the puck deflects off his own stick and then into the net.*

A goal cannot be scored by an attacking player who kicks any equipment (stick, glove, helmet, etc.) at the puck, including kicking the blade of his own stick,

causing the puck to cross the goal line.

- 46.3 **Major Penalty Plus a Game Misconduct** - A major penalty plus a game misconduct shall be imposed on any player who kicks or attempts to kick an opposing player.
- 46.4 **Match Penalty** - A match penalty shall be imposed on a player who injures or attempts to injure an opponent as a result of kicking.
- 46.5 **Suspensions** - If deemed appropriate, supplementary discipline can be applied by the proper USARS or local league directors at their discretion (refer to **Rule 29**).

Rule 47 Kneeing

- 47.1 **Kneeing** - Kneeing is the act of a player leading with his knee and in some cases extending his leg outwards to make contact with his opponent.
- 47.2 **Minor Penalty** - The Referee, at his discretion, may assess a minor penalty, based on the degree of violence, to a player guilty of kneeing an opponent.
- 47.3 **Major Penalty** - The Referee, at his discretion, may assess a major penalty, based on the degree of violence of the kneeing foul, to a player guilty of kneeing an opponent (see **Rule 47.5**).
- 47.4 **Match Penalty** - The Referee, at his discretion, may assess a match penalty if, in his judgment, the player attempted to or deliberately injured his opponent by kneeing.
- 47.5 **Game Misconduct Penalty** - When a major penalty is imposed under this rule for a foul resulting in an injury to an opponent, a game misconduct shall also be imposed.
- 47.6 **Suspensions** - If deemed appropriate, supplementary discipline can be applied by the proper USARS or local league directors at their discretion (refer to **Rule 29**).

Rule 48 Roughing & Body Checking

- 48.1 **Roughing** - Roughing is any use of illegal body checking or excessive use of unnecessary roughness.
- 48.2 **Minor Penalty** - At the discretion of the Referee, a minor penalty for roughing may be imposed on any player deemed guilty of body checking or unnecessary

SECTION 6

roughness.

- 48.3 **Double-minor Penalty** - A double-minor penalty for roughing may only be imposed in such instances where any player who, after having been struck, shall retaliate with a punch or attempted punch (refer to **Rule 44.9**).
- 48.4 **Major Penalty** - At the discretion of the referee, a major penalty for roughing may be imposed on any player deemed guilty of body checking or unnecessary roughness.
- 48.5 **Major Penalty Plus a Game Misconduct** - A major penalty plus a game misconduct shall be assessed to any player guilty of injuring an opponent through body checking or unnecessary roughness.
- 48.6 **Match Penalty** - The Referee, at his discretion, may assess a match penalty if, in his judgment, the player attempted to or deliberately injured his opponent by body checking or unnecessary roughness.
- 48.7 **Suspensions** - If deemed appropriate, supplementary discipline can be applied by the proper USARS or local league directors at their discretion (refer to **Rule 29**).

Rule 49 **Slew-footing**

- 49.1 **Slew-footing** - Slew-footing is the act of a player using his leg or foot to knock or kick an opponent's feet from under him, or pushes an opponent's upper body backward with an arm or elbow, and at the same time with a forward motion of his leg, knocks or kicks the opponent's feet from under him, causing him to fall violently to the rink.
- 49.2 **Major Penalty Plus a Game Misconduct** - Any player who is guilty of slew-footing shall be assessed a major penalty plus a game misconduct.
- 49.3 **Suspensions** - If deemed appropriate, supplementary discipline can be applied by the proper USARS or local league directors at their discretion (refer to **Rule 29**).

Rule 50 **Throwing Equipment**

- 50.1 **Throwing Equipment** - A player shall not throw a stick or any other object in any zone. A player who has lost or broken his stick may only receive a stick at his own players' bench or be handed one from a teammate on the rink (refer to Rule 10.3).

50.2 **Minor Penalty** - A minor penalty shall be imposed on any player on the rink who throws his stick or any part thereof or any other object in any zone, except when such act has been penalized by the assessment of a penalty shot or the awarding of a goal (refer to **Rules 50.6** and **50.7**).

When the player discards the broken portion of a stick or some other object by tossing it or shooting it to the side of the rink (and not over the boards) in such a way as to not interfere with play or opposing player, no penalty will be imposed for so doing. When moving a stick that is not broken, no penalty shall be assessed as long as it does not interfere with the play and the player who lost said stick is not attempting to retrieve it, otherwise an interference penalty must be assessed.

A minor penalty for unsportsmanlike conduct plus a game misconduct penalty shall be imposed on a player who throws his stick or any part thereof or any other object or piece of equipment outside the playing area in protest of an official's decision.

50.3 **Bench Minor Penalty** - Should any player, Coach, or non-playing Club official on the players' bench or penalty bench throw anything on the rink during the progress of the game or during a stoppage of play, a bench minor penalty for unsportsmanlike conduct shall be assessed (refer to **Rule 72.3**).

50.4 **Misconduct Penalty** - A misconduct penalty shall be imposed on a player who throws his stick or any part thereof or any other object or piece of equipment outside the playing area. If the offense is committed in protest of an official's decision, a minor penalty for unsportsmanlike conduct plus a game misconduct penalty shall be assessed to the offending player.

50.5 **Match Penalty** - If a player attempts to or deliberately injures an opponent by throwing a stick or any other object or piece of equipment at an opposing player, Coach or non-playing Club official, he shall be assessed a match penalty.

50.6 **Penalty Shot** - When any member of the defending team, including a Coach or any non-playing Club official, throws or shoots any part of a stick or any other object or piece of equipment at the puck or puck carrier in his defending zone, the Referee shall allow the play to be completed and if a goal is not scored, a penalty shot shall be awarded to the non-offending team. This shot shall be taken by the player designated by the Referee as the player fouled.

If the officials are unable to determine the person against whom the offense was made, the non-offending team, through the Captain, shall designate a player on the rink at the time the offense was committed to take the shot.

SECTION 6

If a player on a breakaway in the attacking zone is interfered with by a stick or any other object or piece of equipment that is thrown by any member of the defending team, including the Coach or any non-playing Club official, a penalty shot shall be awarded to the non-offending team. See also **Rule 54.3 - Tripping for fouls from behind to a player on a breakaway.**

If a player on a breakaway in the attacking zone is interfered with by an object thrown on the rink by a spectator, the Referee shall award a penalty shot to the player who was fouled.

- 50.7 **Awarded Goal** - If, when the opposing goalkeeper has been removed, a member of the defending team, including a Coach or any non-playing Club official, throws or shoots any part of a stick or any other object or piece of equipment at the puck or puck carrier in his own defending zone, thereby preventing the puck carrier from having a clear shot on an “open net,” a goal shall be awarded to the attacking side.

For the purpose of this rule, an “open net” is defined as one from which a goalkeeper has been removed for an additional attacking player. The goalkeeper is considered off the rink once the replacement player has entered the playing surface.



Section 7: Restraining Fouls

Rule 51 Holding

- 51.1 **Holding** - Any action by a player that restrains or impedes the progress of an opposing player whether or not he is in possession of the puck.
- 51.2 **Minor Penalty** - A minor penalty shall be imposed on a player who holds an opponent by using his hands, arms, or legs.

A player is permitted to use his arm in a strength move, by blocking his opponent, provided he has body position and is not using his hands in a holding manner when doing so.

A player is not permitted to hold an opponent's stick. A minor penalty shall be assessed to a player who holds an opponent's stick (assessed and announced as "holding the stick").

A player is permitted to protect himself by defending against an opponent's stick. He must immediately release the stick and allow the player to resume normal play.

- 51.3 **Major Penalty** - A major penalty shall be imposed on any player who holds the facemask of an opponent.
- 51.4 **Penalty Shot** – refer to **Rule 54.3 – Tripping**.
- 51.5 **Awarded Goal** – refer to **Rule 54.4 – Tripping**.

Rule 52 Hooking

- 52.1 **Hooking** - Hooking is the act of using either end of the stick in a manner that enables a player to restrain an opponent.

When a player is checking another in such a way that there is only stick-to-stick contact, such action is not to be penalized as hooking.

- 52.2 **Minor Penalty** - A minor penalty shall be imposed on a player who impedes the progress of an opponent by "hooking" with his stick. A minor penalty for hooking shall be assessed to any player who uses the shaft of the stick above the upper hand to hold or hook an opponent.

SECTION 7

- 52.3 **Major Penalty Plus a Game Misconduct** - A major penalty plus a game misconduct shall be imposed on any player who injures an opponent by “hooking.”
- 52.4 **Penalty Shot** – refer to **Rule 54.3 – Tripping**.
- 52.5 **Awarded Goal** – refer to **Rule 54.4 – Tripping**.

Rule 53 Interference

- 53.1 **Interference** - A strict standard on acts of interference must be adhered to in all areas of the rink.

Body Position: Body position shall be determined as the player skating in front of or beside his opponent, traveling in the same direction. A player who is behind an opponent, who does not have the puck, may not use his stick, body, or free hand in order to restrain his opponent, but must skate in order to gain or reestablish his proper position in order to make a legal play.

A player is allowed the space in which he is standing (body position) and is not required to move in order to let an opponent proceed. A player may “block” the path of an opponent provided he is in front of his opponent and moving in the same direction. Moving laterally and without establishing body position, then making contact with the non-puck carrier is not permitted and will be penalized as interference. A player is always entitled to use his body position to lengthen an opponent’s path to the puck, provided his stick is not utilized (to make himself “bigger” and therefore considerably lengthening the distance his opponent must travel to get where he is going); his free hand is not used and he does not take advantage of his body position to deliver an otherwise illegal check.

Possession: The last player to touch the puck, other than the goalkeeper, shall be considered the player in possession of the puck.

Restrain: The actions of a player who does not have body position, but instead uses illegal means (e.g. hook with stick; hold with hands, trip with the stick or in any manner) to impede an opponent who is not in possession of the puck. Illegal means are acts which allow a player or goalkeeper to establish, maintain, or restore body position other than by skating.

- Pick:** A “pick” is the action of a player who checks or otherwise illegally prohibits the movement of an opponent who is not in possession of the puck. A player delivering a “pick” is one who moves into an opponent’s path without initially having body position, thereby taking him out of the play. When this is done, an interference penalty shall be assessed.
- Free Hand:** When a free hand is used to hold, pull, tug, grab, or physically restrain an opponent from moving freely, this must be penalized as holding. The free hand may be used by a player to “fend off” an opponent or his stick, but may not be used to hold an opponent’s stick or body.
- Stick:** A player who does not have body position on his opponent, who uses his stick (either the blade or the shaft, including the butt-end of the shaft) to impede or prevent his opponent from moving freely on the rink shall be assessed a hooking penalty.

53.2 Minor Penalty - A minor penalty shall be imposed on a player who interferes with or impedes the progress of an opponent who is not in possession of the puck.

A minor penalty shall be imposed on a player who restrains an opponent who is attempting to “fore-check.”

A minor penalty shall be imposed on an attacking player who deliberately body checks a defensive player, including the goalkeeper, who is not in possession of the puck.

A minor penalty shall be imposed on a player who deliberately knocks a stick out of an opponent’s hand, or who prevents a player who has dropped his stick or any other piece of equipment from regaining possession of it.

A minor penalty shall be imposed on a player who knocks or shoots any abandoned or broken stick or illegal puck or other debris towards an opposing puck carrier in a manner that could cause him to be distracted, when not already penalized by a penalty shot or awarded goal. (See also **Rule 50 – Throwing Equipment.**)

SECTION 7

A minor penalty shall be imposed on any identifiable player on the players' bench or penalty bench who, by means of his stick or his body, interferes with the movements of the puck or any opponent on the rink during the progress of the play. In addition, should a player about to come onto the rink, play the puck while one or both skates are still on the players' or penalty bench, a minor penalty for interference shall be assessed.

The appropriate penalty according to the playing rules shall be assessed when a player on the players' or penalty bench gets involved with an opponent on the rink during a stoppage in play. The player(s) involved may be subject to additional sanctions as appropriate pursuant to Rule 29 – Supplementary Discipline.

- 53.3 **Bench Minor Penalty** - A bench minor penalty shall be imposed when an unidentifiable player on the players' bench or penalty bench or any Coach or non-playing Club official who, by means of his stick or his body, interferes with the movements of the puck or any opponent on the rink during the progress of the play.
- 53.4 **Major Penalty** - The Referee, at his discretion, may assess a major penalty, based on the degree of violence, to a player guilty of interfering with an opponent (see Rule 53.5).
- 53.5 **Game Misconduct Penalty** - When a major penalty is imposed under this rule for a foul resulting in an injury of an opponent, a game misconduct shall also be imposed.
- 53.6 **Penalty Shot** - When a player in control of the puck in the neutral or attacking zone and having no other opponent to pass than the goalkeeper is interfered with by a stick or any part thereof or any other object or piece of equipment thrown or shot by any member of the defending team including a Coach or non-playing Club official, a penalty shot shall be awarded to the non-offending team.
- 53.7 **Awarded Goal** - If, when the goalkeeper has been removed from the rink, any member of his team not legally on the rink, including a Coach or non-playing Club official, interferes by means of his body, stick, or any other object or piece of equipment with the movements of the puck or an opposing player in the attacking zone, the Referee shall immediately award a goal to the non-offending team.

Rule 54 Tripping

54.1 **Tripping** - A player shall not place the stick, knee, foot, arm, hand, or elbow in such a manner that causes his opponent to trip or fall.

Accidental trips which occur simultaneously with a completed play will not be penalized. Accidental trips occurring simultaneously with or after a stoppage of play will not be penalized.

If, in the opinion of the Referee, a player is unquestionably hook-checking the puck and obtains possession of it, subsequently tripping the opponent in so doing, no penalty shall be assessed.

54.2 **Minor Penalty** - A minor penalty shall be imposed on any player who shall place his stick or any portion of his body in such a manner that it shall cause his opponent to trip and fall.

54.3 **Penalty Shot** - When a player, in the attacking zone, in possession and control of the puck and having no other opponent to pass than the goalkeeper, is tripped or otherwise fouled from behind, thus preventing a reasonable scoring opportunity, a penalty shot shall be awarded to the non-offending team. Nevertheless, the Referee shall not stop play until the attacking team has lost possession of the puck to the defending team.

The intention of this rule is to restore a reasonable scoring opportunity which has been lost. If, however, the player fouled is able to recover and obtain a reasonable scoring opportunity (or a teammate is able to gain a reasonable scoring opportunity), no penalty shot should be awarded but the appropriate penalty should be signaled and assessed if a goal is not scored on the play.

“Control of the puck” means the act of propelling the puck with the stick, hand, or feet. If while it is being propelled, the puck is touched by another player or his equipment, or hits the goal or goes free, the player shall no longer be considered to be “in possession and control of the puck.”

In order for a penalty shot to be awarded for a player being fouled from behind, the following four (4) criteria must have been met:

- (i) *The infraction must have taken place in the attacking zone.*
- (ii) *The infraction must have been committed from behind.*

SECTION 7

- (iii) *The player in possession and control of the puck must have been denied a reasonable chance to score. The fact that the player got a shot off does not automatically eliminate this play from the penalty shot consideration criteria. If the foul was from behind and the player was denied a “more” reasonable scoring opportunity due to the foul, then the penalty shot should still be awarded.*
- (iv) *The player in possession and control of the puck must have had no opposing player between himself and the goalkeeper.*

It should be noted that if the attacking player manages to get around the goalkeeper and has no defending player between him and the open goal, and he is fouled from behind by the goalkeeper or another defending player, no goal can be awarded since the goalkeeper is still on the rink. A penalty shot would be awarded.

- 54.4 **Awarded Goal** - If, when the opposing goalkeeper has been removed from the rink, a player in possession and control of the puck in the attacking zone is tripped or otherwise fouled with no opposition between him and the opposing goal, thus preventing a reasonable scoring opportunity, the Referee shall immediately stop play and award a goal to the attacking team.



Section 8: Stick Fouls

Rule 55 **Butt-ending**

- 55.1 **Butt-ending** - The action whereby a player uses the shaft of the stick, above the upper hand, to check an opposing player in any manner or jabs or attempts to jab an opposing player with this part of the stick.
- 55.2 **Double-minor Penalty** - A double-minor penalty will be imposed on a player who attempts to butt-end an opponent.
- 55.3 **Major Penalty Plus a Game Misconduct** - A major penalty plus a game misconduct shall be imposed on a player who butt-ends an opponent.
- 55.4 **Match Penalty** - A match penalty shall be imposed on a player who injures an opponent as a result of a butt-end.
- 55.5 **Suspensions** - If deemed appropriate, supplementary discipline can be applied by the proper USARS or local league directors at their discretion (refer to **Rule 29**).

Rule 56 **Cross-checking**

- 56.1 **Cross-checking** - The action of using the shaft of the stick between the two hands to forcefully check an opponent.
- 56.2 **Minor Penalty** - A minor penalty, at the discretion of the Referee based on the severity of the contact, shall be imposed on a player who cross-checks an opponent.
- 56.3 **Major Penalty** - A major penalty, at the discretion of the Referee based on the severity of the contact, shall be imposed on a player who “cross checks” an opponent (see **Rule 56.5**).
- 56.4 **Match Penalty** - The Referee, at his discretion, may assess a match penalty if, in his judgment, the player attempted to or deliberately injured his opponent by cross-checking.
- 56.5 **Game Misconduct Penalty** - When a major penalty is assessed for cross-checking resulting in an injury to the opponent, an automatic game misconduct penalty shall also be imposed on the offending player.
- 56.6 **Suspensions** - If deemed appropriate, supplementary discipline can be applied by the proper USARS or local league directors at their discretion (refer to **Rule 29**).

SECTION 8

Rule 57 High-sticking

- 57.1 **High-sticking** - A “high stick” is one which is carried above the height of the opponent’s shoulders. Players must be in control and responsible for their stick at all times. However, a player is permitted accidental contact on an opponent if the act is committed as a normal windup or follow through of a shooting motion, or accidental contact on the opposing center who is bent over during the course of a face-off. A wild swing at a bouncing puck would not be considered a normal windup or follow through and any contact to an opponent above the height of the shoulders shall be penalized accordingly.
- 57.2 **Minor Penalty** - A minor penalty shall be imposed for any contact made by a stick on an opponent above the shoulders or against any player who intimidates an opponent while carrying the stick blade above the shoulders of an opponent.
- 57.3 **Major Penalty Plus a Game Misconduct** - When a player carries or holds any part of his stick above the shoulders of the opponent so that injury results, the Referee shall assess a major penalty plus a game misconduct for all contact that causes an injury, whether accidental or careless, in the opinion of the Referee.
- 57.4 **Match Penalty** - When, in the opinion of the Referee, a player attempts to or deliberately injures an opponent while carrying or holding any part of his stick above the shoulders of the opponent, the Referee shall assess a match penalty to the offending player.
- 57.5 **Goals** - An apparent goal scored by an attacking player who strikes the puck with his stick carried above the height of the crossbar of the goal frame shall not be allowed. The determining factor is where the puck makes contact with the stick. If the puck makes contact with the stick below the level of the crossbar and enters the goal, this goal shall be allowed.
- A goal scored by a defending player who strikes the puck with his stick carried above the height of the crossbar of the goal frame shall be allowed.
- 57.6 **High-sticking the Puck** - See **Rule 77**.
- 57.7 **Suspensions** - If deemed appropriate, supplementary discipline can be applied by the proper USARS or local league directors at their discretion (refer to **Rule 29**).

Hooking

Although hooking can be classified as a stick-related foul, it has been placed in Section 7 – Restraining Fouls as Rule 52 as this tends to be the more prominent application of this rule.

Rule 58 Slashing

- 58.1 **Slashing** - Slashing is the act of a player swinging his stick at an opponent, whether contact is made or not. Non-aggressive stick contact to the pant or front of the shin pads, should not be penalized as slashing. Any forceful or powerful chop with the stick on an opponent's body, the opponent's stick, or on or near the opponent's hands that, in the judgment of the Referee, is not an attempt to play the puck, shall be penalized as slashing.
- 58.2 **Minor Penalty** - A minor penalty, at the discretion of the Referee based on the severity of the contact, shall be imposed on a player who slashes an opponent.
- 58.3 **Major Penalty** - A major penalty, at the discretion of the Referee based on the severity of the contact, shall be imposed on a player who slashes an opponent.
- 58.4 **Match Penalty** - The Referee, at his discretion, may assess a match penalty if, in his judgment, the player attempted to or deliberately injured his opponent by slashing.
- 58.5 **Game Misconduct Penalty** - Whenever a major penalty is assessed for a slash resulting in an injury to an opponent, a game misconduct penalty must also be imposed.
- 58.6 **Penalty Shot** - refer to **Rule 54.3 – Tripping**.
- 58.7 **Awarded Goal** - refer to **Rule 54.4 – Tripping**.
- 58.8 **Suspensions** - If deemed appropriate, supplementary discipline can be applied by the proper USARS or local league directors at their discretion (refer to **Rule 29**).

SECTION 8

Rule 59 **Spearing**

- 59.1 **Spearing** - Spearing shall mean stabbing at an opponent with the point of the stick blade, whether contact is made or not.
- 59.2 **Double-minor Penalty** - A double-minor penalty will be imposed on a player who attempts to spear an opponent and does not make contact.
- 59.3 **Major Penalty Plus a Game Misconduct** - A major penalty plus a game misconduct shall be imposed on a player who spears an opponent.
- 59.4 **Match Penalty** - A match penalty shall be imposed on a player who injures an opponent as a result of a spear.
- 59.5 **Suspensions** - If deemed appropriate, supplementary discipline can be applied by the proper USARS or local league directors at their discretion (refer to **Rule 29**).



Section 9: Other Fouls

Rule 60 Delaying the Game

60.1 **Delaying the Game** – A player or a team may be penalized when, in the opinion of the Referee, is delaying the game in any manner.

60.2 **Minor Penalty** - A minor penalty shall be imposed on any player, including the goalkeeper, who holds, freezes, or plays the puck with his stick, skates, or body in such a manner as to deliberately cause a stoppage of play. With regard to a goalkeeper, this rule applies outside of his goal crease area.

A minor penalty for delay of game shall be imposed on any player who deliberately shoots or bats (using his hand or his stick) the puck outside the playing area (from anywhere on the rink) during the play or after a stoppage of play.

When a goalkeeper, while in his defending zone, shoots or bats (using his hand or his stick) the puck directly (non-deflected) out of the playing surface, except where there is no glass, a penalty shall be assessed for delaying the game. When the puck is shot into the players' bench, the penalty will not apply. When the puck is shot over the glass 'behind' the players' bench, the penalty will be assessed.

A minor penalty shall be imposed on any player who delays the game by deliberately displacing a goal post from its normal position, unless already penalized by means of a penalty shot or awarded goal (see **Rules 60.5** and **60.6**). The Referee shall stop play immediately when the offending team gains possession of the puck.

When the net is accidentally displaced by an attacking player, and the defending side is in possession of the puck and moving out of their zone, play shall be permitted to continue until such time as the non-offending team loses possession of the puck. The resulting face-off will take place at the last-play face-off spot, unless it is in the non-offending team's defending zone, and as such the ensuing face-off would take place at the center face-off spot. It is possible for a goal to be scored at one end of the rink while the net at the other end has been dislodged, provided that the team being scored upon is the team responsible for dislodging the net at the other end of the rink.

A minor penalty shall be imposed on a player other than the goalkeeper who deliberately falls on or gathers the puck into his body. Any player who drops to his knees to block a shot should not be penalized if the puck is shot under him or becomes lodged in his clothing or equipment but any use of the hands to make the puck unplayable should be penalized promptly.

SECTION 9

If a goalkeeper comes out of his crease to “cut down the angle” on a shot and after making the save covers the puck, this shall be legal. If the goalkeeper races out of his crease in an attempt to beat the attacking player to the puck and instead of playing the puck jumps on the puck causing a stoppage of play, this shall be a minor penalty for delay of game.

A minor penalty shall be imposed on a goalkeeper who holds or places the puck against any part of the goal in such a manner as to cause a stoppage of play.

Play shall not be stopped nor the game delayed by reasons of adjustments to clothing, equipment, skates, or sticks. For an infringement of this rule, a minor penalty shall be given.

No delay shall be permitted for the repair or adjustment of goalkeeper’s equipment. If adjustments are required, the goalkeeper shall leave the rink and his place shall be taken by the substitute goalkeeper immediately. For an infraction of this rule by a goalkeeper, a minor penalty shall be imposed.

A minor penalty for delay of game shall be assessed to any player for the second face-off violation against his team during the same face-off (See **Rule 73**).

60.3 **Bench Minor Penalty** - A bench minor penalty shall be imposed upon any Team which, after warning by the Referee to its Captain or Alternate Captain to place the correct number of players on the rink and commence play, fails to comply with the Referee’s direction and thereby causes any delay by making additional substitutions.

60.4 **Objects Thrown on the Rink** - In the event that objects are thrown on the rink that interfere with the progress of the game, the Referee shall blow the whistle and stop the play and the puck shall be faced-off at the last-play face-off spot. Refer also to **Rule 53.6** when spectator interference occurs during a breakaway.

60.5 **Penalty Shot** - If the goal post is deliberately displaced by a goalkeeper or player during the course of a “breakaway,” or when the minor penalty for delay of game cannot be served in its entirety in regulation time or at any point in overtime, a penalty shot will be awarded to the non-offending team, which shot shall be taken by the player last in possession of the puck.

No defending player, except the goalkeeper, will be permitted to fall on the puck, hold the puck, pick up the puck, or gather the puck into the body or hands when the puck is within the goal crease. For infringement of this rule, play shall immediately be stopped and a penalty shot shall be ordered against the offending team, but no other penalty shall be given. The rule shall be interpreted so that a

penalty shot will be awarded only when the puck is in the crease at the instant the offense occurs. However, in cases where the puck is outside the crease, **Rule 60.2** may still apply and a minor penalty may be imposed, even though no penalty shot is awarded. See also **Rule 64 – Handling Puck**.

60.6 Awarded Goal - In the event that the goal post is displaced, either deliberately or accidentally, by a defending player, prior to the puck crossing the goal line between the normal position of the goalposts, the Referee may award a goal.

In order to award a goal in this situation, the goal post must have been displaced by the actions a defending player, the puck must have been shot (or the player must be in the act of shooting) at the goal prior to the goal post being displaced, and it must be determined that the puck would have entered the net between the normal position of the goal posts.

When the goal post has been displaced deliberately by the defending team when their goalkeeper has been removed for an extra attacker thereby preventing an impending goal by the attacking team, the Referee shall award a goal to the attacking team.

The goal frame is considered to be displaced if either or both goal posts are no longer in their correct location on the goal line prior to or as the puck enters the goal.

60.7 Infractions - The following list of infractions shall result in a penalty (minor, bench minor, penalty shot, or awarded goal) being imposed by the Referee for delaying the game:

- (i) *Deliberately shooting the puck out of play.*
- (ii) *Deliberately throwing or batting the puck out of play.*
- (iii) *Goaltender shooting or batting the puck (non-deflected, with the hand or with the stick) over the glass from the defending zone.*
- (iv) *Deliberately displacing the goal from it's normal position (or accidentally by a defending player or goalkeeper in relation to the awarding of a goal).*
- (v) *Refusing to place the correct number of players on the rink.*
- (vi) *Deliberately falling on the puck.*
- (vii) *Adjustment of clothing or equipment.*

SECTION 9

Rule 61 Diving / Embellishment

61.1 **Diving / Embellishment** - Any player who blatantly dives, embellishes a fall or a reaction, or who feigns an injury shall be penalized with a minor penalty under this rule.

A goalkeeper who deliberately initiates contact with an attacking player other than to establish position in the crease, or who otherwise acts to create the appearance of other than incidental contact with an attacking player, is subject to the assessment of a minor penalty for diving / embellishment.

61.2 **Minor Penalty** - A minor penalty shall be imposed on a player who attempts to draw a penalty by his actions (“diving / embellishment”), regardless of whether or not a penalty is assessed to his opponent.

Rule 62 Equipment

62.1 **Equipment** - The onus is on the player to maintain his equipment and uniform in playing condition as set forth in these rules.

62.2 **Minor Penalty** - All protective equipment, except gloves, headgear and goalkeepers’ leg guards must be worn under the uniform. For violation of this rule, after warning by the Referee, a minor penalty shall be imposed. Players violating this rule shall not be permitted to participate in the game until such equipment has been corrected or removed.

Play shall not be stopped nor the game delayed by reasons of adjustments to clothing, equipment, skates, or sticks. For an infringement of this rule, a minor penalty shall be given.

No delay shall be permitted for the repair or adjustment of goalkeeper’s equipment. If adjustments are required, the goalkeeper shall leave the rink and his place shall be taken by the substitute goalkeeper immediately. For an infraction of this rule by a goalkeeper, a minor penalty shall be imposed.

Rule 63 Forfeit of Game

63.1 **Forfeit of Game** - In the event a Club is unable to commence the game or at any point play with a minimum of four (4) skaters and one (1) goalkeeper, or should a Club fail to comply with a provision of the USARS or local league’s constitu-

tion, by-laws, resolutions, rules, or regulations affecting the playing of a game, the Referee shall, if so directed by the USARS or local league directors, declare the game forfeited and the non-offending Club the winner. Should the Referee declare the game forfeited because both Clubs are unable to commence with sufficient players or have refused to comply with such a provision, no Club shall be declared the winner.

If the game is declared forfeited prior to its having commenced, the score shall be recorded as 1-0 and no player shall be credited with any personal statistics.

If the game was in progress at the time it is declared forfeited, the score shall be recorded as zero (0) for the loser and one (1), or such greater number of goals that had been scored by it, for the winner; however, the players on both Clubs shall be credited with all personal statistics earned up to the time the forfeit was declared.

Rule 64 **Handling Puck**

64.1 **Handling Puck** - A player shall be permitted to stop or “bat” a puck in the air with his open hand, or push it along the rink with his hand, and the play shall not be stopped unless, in the opinion of the on-rink officials, he has deliberately directed the puck to a teammate, or has allowed his team to gain an advantage, in which case the play shall be stopped and a face-off conducted (see **Rule 76 – Hand Pass**). Play will not be stopped for any hand pass commenced and completed in the defending zone.

64.2 **Minor Penalty – Player** - A player shall be permitted to catch the puck out of the air but must immediately place it or knock it down to the rink. If he catches it and skates with or does not immediately place the puck on the rink, a minor penalty shall be assessed for “closing the hand on the puck”.

A minor penalty shall be imposed on a player who, while play is in progress, picks up the puck off the rink with his hand.

64.3 **Minor Penalty – Goalkeeper** - A goalkeeper who holds the puck with his hands for longer than three seconds shall be given a minor penalty unless there is an opposing player in the immediate vicinity. The object of this entire rule is to keep the puck in play continuously and any action taken by the goalkeeper which causes an unnecessary stoppage must be penalized without warning.

SECTION 9

A goalkeeper shall be assessed a minor penalty when he deliberately holds the puck in any manner which, in the opinion of the Referee, causes an unnecessary stoppage of play.

Play shall be stopped when a goalkeeper throws the puck forward towards the opponent's net and the ensuing face-off shall take place at the nearest end-zone face-off spot of the offending team. In the case where the puck thrown forward by the goalkeeper is taken by an opponent, the Referee shall allow the resulting play to be completed without stoppage.

A goalkeeper shall be assessed a minor penalty when he deliberately drops the puck into his pads or onto the goal net.

A goalkeeper shall be assessed a minor penalty when he deliberately covers the puck behind the goal line when his body is entirely outside the boundaries of the goal crease.

A goalkeeper shall be assessed a minor penalty when he deliberately piles obstacles at or near his net that, in the opinion of the Referee, would tend to prevent the scoring of a goal.

- 64.4 **Penalty Shot** - If a defending player, except a goalkeeper, while play is in progress, falls on the puck, holds the puck, picks up the puck, or gathers the puck into his body or hands while the puck is in the goal crease, the play shall be stopped immediately and a penalty shot shall be awarded to the non-offending team. See also **Rule 60 – Delaying the Game**.
- 64.5 **Awarded Goal** - When a goalkeeper, prior to proceeding to his players' bench to be replaced by an extra attacker, intentionally leaves his stick or other piece of equipment or piles other obstacles at or near his net that, in the opinion of the Referee, would tend to prevent the puck from entering the net, a goal shall be awarded. In order to award a goal in this situation, the goalkeeper must have been replaced for an extra attacker, otherwise a minor penalty shall be assessed.
- If a player, when the goalkeeper has been replaced for an extra attacker, falls on the puck, holds the puck, picks up the puck, or gathers the puck into his body or hands while the puck is in the goal crease, the play shall be stopped immediately and goal awarded to the non-offending team.
- 64.6 **Disallowed Goal** - A goal cannot be scored by an attacking player who bats or directs the puck with his hand into the net. A goal cannot be scored by an attacking player who bats or directs the puck and it is deflected into the net off any player, goalkeeper, or official. When the puck enters the net on a clear deflection off a glove, the goal shall be allowed.

Rule 65 **Illegal Substitution**

65.1 **Illegal Substitution** - An illegal substitution shall be deemed to have occurred when a player enters the game illegally from either the players' bench (teammate not within the five (5) foot limit, refer to **Rule 71 – Too Many Men on the Rink**), from the penalty bench (penalty has not yet expired), when a major penalty is being served and the replacement player does not return to the rink from the penalty bench (see **Rule 65.2**), or when a player illegally enters the game for the sole purpose of preventing an opposing player from scoring on a breakaway (see **Rules 65.3** and **65.4**).

When an injured player is penalized and leaves the game, if he returns before the expiration of his penalty, he is not eligible to play. This includes coincidental penalties when his substitute is still in the penalty box awaiting a stoppage in play. The injured player must wait until his substitute has been released from the penalty box before he is eligible to play. See **Rule 8.1**.

65.2 **Bench Minor Penalty** - When a player receives a major penalty and a misconduct or game misconduct penalty at the same time, or when an injured player receives a major penalty and is unable to serve the penalty himself, the penalized team shall place a substitute player on the penalty bench before the major penalty expires and no replacement for the penalized player shall be permitted to enter the game except from the penalty bench. Any violation of this provision shall be treated as an illegal substitution under this rule calling for a bench minor penalty.

65.3 **Penalty Shot** - If a player in possession and control of the puck on the attacking side of center shall be in such a position as to have no opposition between him and the opposing goalkeeper, and while in such position he shall be interfered with by a player of the opposing side who shall have illegally entered the game, the Referee shall award a penalty shot.

65.4 **Awarded Goal** - If, when the opposing goalkeeper has been removed from the rink, a player in possession and control of the puck on the attacking side of center is interfered with by a player who shall have entered the game illegally, the Referee shall immediately award a goal to the non-offending team.

65.5 **Disallowed Goal** - If a penalized player returns to the rink from the penalty bench before his penalty has expired by his own error or the error of the Penalty Timekeeper, any goal scored by his own team while he (or his substitute) is illegally on the rink shall be disallowed but all penalties imposed on either team shall be served as regular penalties. The penalized player must return to serve

SECTION 9

his unexpired time (and an additional minor penalty if he left the penalty bench on his own).

If a player shall illegally enter the game from his own players' bench or from any other location in the rink, any goal scored by his own team while he is illegally on the rink shall be disallowed but all penalties imposed on either team shall be served as regular penalties.

65.6 Deliberate Illegal Substitution - see Rule 71 – Too Many Men on the Rink.

Rule 66 Interference with the Goalkeeper

66.1 **Interference with the Goalkeeper** - This rule is based on the premise that an attacking player's position, whether inside or outside the crease, should not, by itself, determine whether a goal should be allowed or disallowed. In other words, goals scored while attacking players are standing in the crease may, in appropriate circumstances, be allowed. Goals should be disallowed only if: (1) an attacking player, either by his positioning or by contact, impairs the goalkeeper's ability to move freely within his crease or defend his goal; or (2) an attacking player initiates intentional or deliberate contact with a goalkeeper, inside or outside of his goal crease. Incidental contact with a goalkeeper will be permitted, and resulting goals allowed, when such contact is initiated outside of the goal crease, provided the attacking player has made a reasonable effort to avoid such contact. The rule will be enforced exclusively in accordance with judgment of the Referee(s).

For purposes of this rule, "contact," whether incidental or otherwise, shall mean any contact that is made between or among a goalkeeper and attacking player(s), whether by means of a stick or any part of the body.

The overriding rationale of this rule is that a goalkeeper should have the ability to move freely within his goal crease without being hindered by the actions of an attacking player. If an attacking player enters the goal crease and, by his actions, impairs the goalkeeper's ability to defend his goal, and a goal is scored, the goal will be disallowed.

If an attacking player has been pushed, shoved, or fouled by a defending player so as to cause him to come into contact with the goalkeeper, such contact will not be deemed contact initiated by the attacking player for purposes of this rule, provided the attacking player has made a reasonable effort to avoid such contact.

66.2 **Penalty** - In all cases in which an attacking player initiates intentional or deliberate contact with a goalkeeper, whether or not the goalkeeper is inside or outside the goal crease, and whether or not a goal is scored, the attacking player will receive a penalty (minor or major, as the Referee deems appropriate). In all cases where the infraction being imposed is to the attacking player for hindering the goalkeeper's ability to move freely in his goal crease, the penalty to be assessed is for goalkeeper interference.

In exercising his judgment, the Referee should give more significant consideration to the degree and nature of the contact with the goalkeeper than to the exact location of the goalkeeper at the time of the contact.

66.3 **Contact Inside the Goal Crease** - If an attacking player initiates contact with a goalkeeper, incidental or otherwise, while the goalkeeper is in his goal crease, and a goal is scored, the goal will be disallowed.

If a goalkeeper, in the act of establishing his position within his goal crease, initiates contact with an attacking player who is in the goal crease, and this results in an impairment of the goalkeeper's ability to defend his goal, and a goal is scored, the goal will be disallowed.

If, after any contact by a goalkeeper who is attempting to establish position in his goal crease, the attacking player does not immediately vacate his current position in the goal crease (i.e. give ground to the goalkeeper), and a goal is scored, the goal will be disallowed. In all such cases, whether or not a goal is scored, the attacking player will receive a minor penalty for goalkeeper interference.

If an attacking player establishes a significant position within the goal crease, so as to obstruct the goalkeeper's vision and impair his ability to defend his goal, and a goal is scored, the goal will be disallowed.

For this purpose, a player "establishes a significant position within the crease" when, in the Referee's judgment, his body, or a substantial portion thereof, is within the goal crease for more than an instantaneous period of time.

Refer also to **Reference Tables – Table 18 – Interference with the Goalkeeper Situations**.

66.4 **Contact Outside the Goal Crease** - If an attacking player initiates any contact with a goalkeeper, other than incidental contact, while the goalkeeper is outside his goal crease, and a goal is scored, the goal will be disallowed.

SECTION 9

A goalkeeper is not “fair game” just because he is outside the goal crease. The appropriate penalty should be assessed in every case where an attacking player makes unnecessary contact with the goalkeeper. However, incidental contact will be permitted when the goalkeeper is in the act of playing the puck outside his goal crease provided the attacking player has made a reasonable effort to avoid such unnecessary contact.

When a goalkeeper has played the puck outside of his crease and is then prevented from returning to his crease area due to the deliberate actions of an attacking player, such player may be penalized for goalkeeper interference. Similarly, the goalkeeper may be penalized, if by his actions outside of his crease he deliberately interferes with an attacking player who is attempting to play the puck or an opponent.

Refer also to **Reference Tables – Table 18 – Interference with the Goalkeeper Situations**.

66.5 **Face-off Location** - Whenever the Referee stops play to disallow a goal as a result of contact with the goalkeeper (incidental or otherwise), the resulting face-off shall take place at the center face-off spot.

66.6 **Rebounds and Loose Pucks** - In a rebound situation, or where a goalkeeper and attacking player(s) are simultaneously attempting to play a loose puck, whether inside or outside the crease, incidental contact with the goalkeeper will be permitted, and any goal that is scored as a result thereof will be allowed.

In the event that a goalkeeper has been pushed into the net together with the puck by an attacking player after making a stop, the goal will be disallowed. If applicable, appropriate penalties will be assessed. If, however, in the opinion of the Referee, the attacking player was pushed or otherwise fouled by a defending player causing the goalkeeper to be pushed into the net together with the puck, the goal can be permitted.

In the event that the puck is under a player in or around the crease area (deliberately or otherwise), a goal cannot be scored by pushing this player together with the puck into the goal. If applicable, the appropriate penalties will be assessed, including a penalty shot if deemed to be covered in the crease deliberately (refer to **Rule 60 – Delaying the Game**).

Rule 67 Leaving the Bench

- 67.1 **Leaving the Bench** - No player may leave the players' or penalty bench at any time during an altercation or for the purpose of starting an altercation.
- 67.2 **Legal Line Change** - A player who has entered the game while play is in progress from his own players' bench or legally from the penalty bench (penalty time has expired) who starts an altercation may be subject to discipline in accordance with **Rule 29 – Supplementary Discipline**.

A player or players who have entered the game on a legal line change during a stoppage of play, who line up in preparation for the ensuing face-off, and who participate in an altercation shall be penalized under the appropriate rule and will be subject to discipline in accordance with Rule 29 – Supplementary Discipline.

- 67.3 **Leaving the Players' Bench** - Players shall not be permitted to come on the rink during a stoppage of play or during intermission for the purpose of warming-up.

Except at the end of each period or for entering the game legally, no player may, at any time, leave the players' bench. If it is necessary to proceed to the dressing room during the course of the game (and when it is required to proceed by way of the rink to access the dressing room), the player must wait for a stoppage of play and ensure there are no altercations in progress before proceeding.

The player who was the first player to leave the players' (or penalty bench) during an altercation or for the purpose of starting an altercation, from either team, shall be assessed a game misconduct penalty.

- 67.4 **Leaving the Penalty Bench** - Except at the end of each period or on expiration of his penalty, no player may, at any time, leave the penalty bench.

A player serving a penalty on the penalty bench, who is to be changed after the penalty has been served, must proceed at once by way of the rink and be at his own players' bench before any change can be made. For any violation of this rule, a bench minor penalty shall be imposed for too many men on the rink (see **Rule 71 – Too Many Men on the Rink**).

A penalized player who leaves the penalty bench before his penalty has expired, whether play is in progress or not, shall incur an additional minor penalty after serving his unexpired penalty.

SECTION 9

Any player who, having entered the penalty bench, leaves the penalty bench prior to the expiration of his penalty for the purpose of challenging an official's ruling, shall be assessed a game misconduct penalty.

Any penalized player leaving the penalty bench during a stoppage of play and during an altercation shall incur a minor penalty plus a game misconduct penalty. The minor penalty plus the unexpired time remaining in his original penalty must be served by a replacement player placed on the penalty bench by the Coach of the offending team.

If a player leaves the penalty bench before his penalty is fully served, the Penalty Timekeeper shall note the time and signal the officials who will stop play when the offending player's team obtains possession of the puck. An additional minor penalty must be served by this player in addition to the time remaining in his original penalty (this unexpired time is calculated from the time he left the penalty bench illegally).

In the case of a player returning to the rink before his time has expired through an error of the Penalty Timekeeper, he is not to serve an additional penalty, but must serve his unexpired time, calculated from the time he left the penalty bench through the error of the Penalty Timekeeper).

- 67.5 **Bench Minor Penalty** - A bench minor penalty shall be imposed on a team whose player(s) leave the players' bench for any purpose other than a change of players and when no altercation is in progress.

If a Coach or non-playing Club official gets on the rink (unless directed to do so by an on-rink official, i.e. to attend to an injured player) after the start of a period and before that period is ended, the Referee shall impose a bench minor penalty against the team.

- 67.6 **Game Misconduct Penalty** - A game misconduct penalty shall be imposed on the player who was the first player to leave the players' or penalty bench during an altercation or for the purpose of starting an altercation, from either team.

Any penalized player leaving the penalty bench during a stoppage of play and during an altercation shall incur a minor penalty plus a game misconduct penalty. The minor penalty plus the unexpired time remaining in his original penalty must be served by a replacement player placed on the penalty bench by the Coach of the offending team.

Any player who has been ordered to the dressing room by the officials and returns to his bench or to the rink surface for any reason before the appropriate time shall be assessed a game misconduct.

Once a player enters the penalty bench, he must not leave until his penalty expires and his team is entitled to an additional player on the rink, or, at the end of a period to proceed to his dressing room or players' bench, or, when he has received permission from an on-rink official. At any other time, he shall be assessed a game misconduct penalty under this rule.

67.7 Penalty Shot - If a player in possession and control of the puck in the attacking zone shall be in such a position as to have no opposition between him and the opposing goalkeeper, and while in such position he shall be interfered with by a player of the opposing side who shall have illegally entered the game, the Referee shall impose a penalty shot.

67.8 Awarded Goal - If, when the opposing goalkeeper has been removed from the rink, a player in possession and control of the puck in the attacking zone is interfered with by a player who shall have entered the game illegally, the Referee shall immediately award a goal to the non-offending team.

67.9 Disallowed Goal - If a penalized player returns to the rink from the penalty bench before his penalty has expired by his own error or the error of the Penalty Timekeeper, any goal scored by his own team while he is illegally on the rink shall be disallowed but all penalties imposed on either team shall be served as regular penalties.

If a player shall illegally enter the game from his own players' bench or from the penalty bench, any goal scored by his own team while he is illegally on the rink shall be disallowed but all penalties imposed on either team shall be served as regular penalties.

67.10 Suspensions - The first player to leave the players' or penalty bench during an altercation or for the purpose of starting an altercation from either team shall be suspended automatically for the next ten (10) games of his team.

The determination as to which player shall be deemed the first to have left their respective players' or penalty bench shall be made by the Referees in consultation off-rink officials. In the event that they are unable to identify the offending player, no penalty shall be assessed for leaving the players' or penalty bench.

Any player who has been ordered to the dressing room by the officials and returns to his bench or to the rink for any reason before the appropriate time shall be assessed a game misconduct.

SECTION 9

Rule 68 **Premature Substitution**

68.1 **Premature Substitution** - When a goalkeeper leaves his goal area and proceeds to his players' bench for the purpose of substituting another player, the skater cannot enter the playing surface before the goalkeeper is within five feet (5') of the bench. If the substitution is made prematurely, the official shall stop play immediately unless the non-offending team has possession of the puck, in which event the stoppage will be delayed until the puck changes possession.

There shall be no time penalty to the team making the premature substitution, but the resulting face-off will take place at the center face-off spot when play is stopped beyond the center red line. When play is stopped prior to the center red line, the resulting face-off shall be conducted at the last-play face-off spot.

In all other situations not covered in the above, a minor penalty may result for "too many men on the rink" (see **Rule 71**).

Rule 69 **Refusing to Play the Puck**

69.1 **Refusing or Abstaining from Playing the Puck** - The purpose of this section is to enforce continuous action and both Referees should interpret and apply the rule to produce this result.

69.2 **Hand Pass** - When a hand pass has been initiated by one player to a teammate and the teammate elects not to play the puck to avoid the stoppage of play, and the opposing team also abstains from playing the puck (perhaps to allow time to expire on a penalty), the Referee shall stop the play and order the resulting face-off at the last-play face-off location nearest to where the play was stopped for this violation.

69.3 **High Stick** - When a player contacts the puck with his stick above the normal height of the shoulders and a teammate elects not to play the puck to avoid the stoppage of play, and the opposing team also abstains from playing the puck (perhaps to allow time to expire on a penalty), the Referee shall stop the play and order the resulting face-off at the last-play face-off location nearest to where the play was stopped for this violation.

69.4 **Penalty** - When the Referee signals the delayed calling of a penalty to one team and a player of that team intentionally abstains from playing the puck in order to allow additional time to expire on the game or penalty time clocks, the Referee shall stop the play to assess the proper penalty and order the resulting face-off at one of the end-zone face-off spots in the offending team's defending zone.

Rule 70 Refusing to Start Play

- 70.1 **Refusing to Start Play** - This rule applies to teams who refuse to play while both teams are on the rink, or who withdraws from the rink and refuses to play, or who refuses to come onto the rink at the start of the game or at the beginning of any period of the game, or who shall fail to place the minimum of four (4) skaters and one (1) goalkeeper on the rink when ordered to do so by the Referee.
- 70.2 **Procedure – Team On Rink** - If, when both teams are on the rink, one team for any reason shall refuse to play when ordered to do so by the Referee, he shall warn the Captain and allow the team so refusing fifteen (15) seconds within which to begin the play or resume play. If at the end of that time, the team shall still refuse to play, the Referee shall impose a bench minor penalty for delay of game on a player of the offending team to be designated by the Coach of that team through the playing Captain. Should there be a repetition of the same incident, offending Coach shall be removed from the players’ bench and assessed a game misconduct penalty.

Should the offending team still refuse to play, the Referee shall have no alternative but to declare that the game be forfeited to the non-offending Club and the case shall be reported to the proper USARS or local league directors for further action (see **Rule 63 – Forfeit of Game**).

First Violation	Second Violation
<p>(i) Warn the Captain of the offending team and allow 15 seconds within which to resume play.</p> <p>(ii) If at the end of the 15 seconds the team still refuses to resume play, assess a bench minor penalty to the offending team for delay of game.</p>	<p>(i) Warn the Captain of the offending team and allow 15 seconds within which to resume play.</p> <p>(ii) If at the end of the 15 seconds the team still refuses to resume play, assess a bench minor penalty to the offending team for delay of game.</p> <p>(iii) Offending team’s Coach is to be assessed a game misconduct penalty.</p> <p>(iv) If the team still refuses to play, the Referee shall declare the game be forfeited to the non-offending club (see Rule 63 – Forfeit of Game).</p>

SECTION 9

- 70.3 **Procedure – Team Off Rink** - If a team, when ordered to do so by the Referee through its Manager or Coach, fails to go on the rink and start play within five (5) minutes, the game shall be forfeited and the case shall be reported to the proper USARS or local league directors for further action (see **Rule 63 – Forfeit of Game**).
- (i) *Once it is apparent to the Referee that the team is refusing to come onto the rink and begin play, a bench minor penalty is to be assessed to the offending team for delay of game.*
 - (ii) *Five (5) minutes will be provided for the offending team to return to the rink and begin play.*
 - (iii) *After the five (5) minutes has elapsed and the offending team still has not returned to the rink to resume play, the game shall be forfeited.*
 - (iv) *Once the Manager or Coach has been notified of the five (5) minute warning, and the team returns to the rink to resume play within that time frame, a bench minor penalty for delay of game must be assessed to the offending team.*

Rule 71 **Too Many Men on the Rink**

- 71.1 **Too Many Men on the Rink** - Players may be changed at any time during the play from the players' bench provided that the player or players leaving the rink shall be within five feet (5') of his players' bench and out of the play before the change is made. Refer also to **Rule 68 – Premature Substitution**. At the discretion of the Referees, should a substituting player come onto the rink before his teammate is within the five foot (5') limit of the players' bench (and therefore clearly causing his team to have too many players on the rink), then a bench minor penalty may be assessed.

When a player is retiring from the rink and is within the five foot (5') limit of his players' bench, and his substitute is on the rink, then the retiring player shall be considered off the rink for the purpose of **Rule 67 – Leaving the Bench**.

If in the course of making a substitution, either the player entering the game or the player retiring from the rink plays the puck with his stick, skates, or hands or who interferes with or makes any physical contact with an opposing player while either the player entering the game or the retiring player is actually on the rink, then the infraction of "too many men on the rink" will be called.

If in the course of a substitution either the player(s) entering the play or the player(s) retiring is struck by the puck accidentally, the play will not be stopped and no penalty will be called.

During the play, the player retiring from the rink must do so at the players' bench and not through any other exit leading from the rink. This is not a legal player change and therefore when a violation occurs, a bench minor penalty shall be imposed.

A player coming onto the rink as a substitute player is considered on the rink once both of his skates are on the rink. If he plays the puck or interferes with an opponent while still on the players' bench, he shall be penalized under **Rule 53 – Interference**.

- 71.2 **Bench Minor Penalty** - A bench minor penalty for too many men on the rink shall be assessed for a violation of this rule. Should a goal be scored by the offending team prior to the Referee blowing his whistle to assess the bench minor penalty, the goal shall be disallowed and the penalty assessed for too many men on the rink.
- 71.3 **Penalty Bench** - A player serving a penalty on the penalty bench, who is to be changed after the penalty has been served, must proceed at once by way of the rink and be within five feet (5') of his own players' bench before any change can be made. For any violation of this rule, a bench minor penalty shall be imposed for too many men on the rink.
- 71.4 **Deliberate Illegal Substitution** - If at any point in the last two (2) minutes of regulation or at any point in overtime, a bench minor penalty is imposed for deliberate illegal substitution (too many men on the rink), a penalty shot shall be awarded against the offending team.

Rule 72 **Unsportsmanlike Conduct**

- 72.1 **Unsportsmanlike Conduct** – Players, coaches, and non-playing Club personnel are responsible for their conduct at all times and must endeavor to prevent disorderly conduct before, during or after the game, on or off the rink and any place in the facility. The Referees may assess penalties to any of the above team personnel for failure to do so.

* **NOTE** - *When such conduct is directed at an official, **Rule 38 – Abuse of Officials** shall be applied.*

SECTION 9

72.2 **Minor Penalty** - A minor penalty for unsportsmanlike conduct shall be assessed under this rule for the following infractions:

- (i) *Any identifiable player who uses obscene, profane, or abusive language or gestures directed at any person.*
- (ii) *Any player who throws any object onto the rink from the players' or penalty bench (or from any other off-rink location). A game misconduct penalty shall also be assessed.*
- (iii) *When a player, including a goalkeeper, is penalized for being the instigator of an altercation.*

If a penalized player is assessed an additional unsportsmanlike conduct penalty either before or after he begins serving his original penalty(ies), the additional minor penalty is added to his unexpired time and served consecutively.

72.3 **Bench Minor Penalty** - A bench minor penalty for unsportsmanlike conduct shall be assessed under this rule for the following infractions:

- (i) *When a Coach or non-playing Club official throws any object onto the rink from the players' or penalty bench (or from any other off-rink location) during the progress of the game or during a stoppage of play. A game misconduct shall also be assessed.*
- (ii) *Any unidentifiable player or any Coach or non-playing Club official uses obscene, profane, or abusive language or gesture directed towards any person.*
- (iii) *Whenever any Coach and/or non-playing Club official uses obscene or profane language or gestures anywhere in the rink.*

72.4 **Misconduct Penalty** - Misconduct penalties shall be assessed under this rule for the following infractions:

- (i) *Any player who persists in using obscene, profane or abusive language directed towards any person after being assessed a minor or bench minor penalty under this Rule.*
- (ii) *Any player who deliberately throws any equipment out of the playing area. At the discretion of the Referee, a game misconduct may be imposed.*
- (a.i.iii) *Any player who persists in any course of conduct (including threatening or abusive language or gestures or similar actions) designed to incite an opponent into incurring a penalty.*

(a.i.iv) *When a penalized player challenges or disputes the ruling of an official after he has already entered the penalty bench and play has resumed.*

(a.i.v) *In general, participants displaying this type of behavior are assessed a minor penalty, then a misconduct penalty and then a game ejection penalty and/or game misconduct penalty (in that order) if they persist.*

72.5 **Game Ejection Penalty** - Game ejection penalties shall be assessed under this rule for the following infractions:

- (i) *Any player who persists in any course of conduct for which he was previously assessed a misconduct penalty under this Rule.*
- (ii) *Any coach or non-playing Club official who persists in any course of conduct for which he was previously assessed a bench minor penalty.*
- (iii) *Any player who receives three (3) penalties of any kind (except misconduct penalty) in the same game.*

72.6 **Game Misconduct Penalty** - Game misconduct penalties shall be assessed under this rule for the following infractions:

- (i) *If a player persists in any course of conduct for which he was previously assessed a misconduct penalty or game ejection penalty.*
- (ii) *Any player who uses obscene or profane gestures on the rink or anywhere in the rink before, during or after the game.*
- (iii) *Coaches and non-playing Club officials who have previously been assessed a bench minor penalty or game ejection penalty for the use obscene or profane language or gestures anywhere in the rink.*
- (iv) *Any player or non-playing Club personnel who directs obscene, profane or abusive language or gestures to any person after the expiration of the game. This action may occur on or off the rink.*
- (v) *In general, participants displaying this type of behavior are assessed a minor penalty, then a misconduct penalty, and then a game ejection and/or game misconduct penalty (in that order) if they persist.*

Any player or non-playing Club personnel penalized under this section may be subject to supplemental discipline under **Rule 29**.



Section 10: **Game Flow**

Rule 73 **Face-offs**

73.1 **Face-off** - The action of the Referee in dropping the puck between the sticks of two opposing players to start or resume play. A face-off begins when the official indicates the location of the face-off and the officials and players take their appropriate positions. The face-off ends when the puck has been legally dropped.

A goalkeeper may not participate in a face-off.

73.2 **Face-off Locations** - All face-offs must be conducted on one of the five (5) recognized face-off spots located on the rink or along one of two imaginary lines connecting the end-zone face-off spots (known as the “last-play face-off spot”), drawn perpendicular to the goal lines.

When a stoppage of play has been caused by any player of the attacking side in the attacking zone, the ensuing face-off shall be made at the center face-off spot.

When the play is stopped for any reason not specifically attributable to either team, the ensuing face-off shall be conducted at the nearest last-play face-off spot.

When players are penalized at a stoppage of play so as to result in penalties being placed on the penalty time clock to one team, the ensuing face-off shall be conducted at one of the two face-off spots in the offending team’s end zone. There are only two (2) exceptions to this application:

- (i) *when a penalty is assessed after the scoring of a goal - face-off at center face-off spot;*
- (ii) *when a penalty is assessed at the end (or start) of a period - face-off at center face-off spot;*

When an infringement of a rule has been committed by players of both sides in the play resulting in the stoppage, the ensuing face-off will be made at the nearest last-play face-off spot.

When stoppage occurs between the end face-off spots and near end of the rink, the puck shall be faced-off at the end face-off spot on the side where the stoppage occurs unless otherwise expressly provided by these rules.

No face-off shall be made within fifteen feet (15’) of the goal or side boards.

SECTION 10

When a goal is illegally scored as a result of a puck being deflected directly off an official anywhere in the defending zone, the resulting face-off shall be made at the end face-off spot in the defending zone.

When the game is stopped for any reason not specifically covered in the official rules, the puck must be faced-off at the nearest last-play face-off spot.

For a violation of **Rule 68 – Premature Substitution**, the resulting face-off will take place at the center face-off spot when play is stopped beyond the center red line. When play is stopped prior to the center red line, the resulting face-off shall be conducted at the nearest last-play face-off spot.

When play is stopped for an injured player, the ensuing face-off shall be conducted at the nearest last-play face-off spot. When the injured player's team has possession of the puck in the attacking zone, the face-off shall be conducted at the center face-off spot.

73.3 **Procedure** - As soon as the line change procedure has been completed by the Referee and he lowers his hand to indicate no further changes, the Referee conducting the face-off shall blow his whistle. This will signal to both teams that they have no more than five (5) seconds to line up for the ensuing face-off. At the end of the five (5) seconds (or sooner if both centers are ready), the Referee will conduct a proper face-off. If, however:

- (i) *One or both centers are not positioned for the face-off,*
- (ii) *One or both centers refrain from placing their stick on the rink,*
- (iii) *Any player has encroached into the face-off circle,*
- (iv) *Any player makes physical contact with an opponent, or*
- (v) *Any player who lines up for the face-off is in an off-side position,*

the Referee shall have the offending center(s) replaced immediately prior to dropping the puck.

73.4 **Procedure – Centers** - The puck shall be faced-off by the Referee dropping the puck on the rink between the sticks of the players facing-off. Players facing-off will stand squarely facing their opponent's end of the rink approximately one stick length apart with the blade of their sticks on the rink.

The sticks of both players facing-off shall have the blade on the rink, outside the face-off circle. The attacking player shall place his stick on the rink first, followed

immediately by the defending player. For face-offs at the center face-off spot, the visiting player shall place his blade on the rink first, followed immediately by the home player.

If a player facing-off fails to take his proper position immediately when directed by the official, the official may order him replaced for that face-off by any teammate then on the rink.

If a center is not at the designated face-off area once the five (5) second time limit has elapsed, the Referee will drop the puck immediately. If the center is back from the face-off spot, is “quarterbacking,” or refuses to come into the face-off area when instructed to do so by the Referee, or the center is simply slow getting to the face-off spot when the five (5) seconds has elapsed, the puck shall be dropped. If the center attempts to arrive at the face-off spot just as the five seconds elapses in an attempt to gain an advantage to win the face-off, he is to be removed from the face-off and replaced, resulting in a face-off violation.

If a player is ejected from the face-off, his replacement must come into position quickly or risk having the puck dropped by the Referee without the player being set, or ejected from the face-off by the Referee resulting in a minor penalty for delay of game for a second face-off violation during the same face-off.

73.5 Procedure – Other Players - No other player shall be allowed to enter the face-off circle or come within fifteen feet (15') of the players facing-off. All players must stand on-side on all face-offs.

During end-zone face-offs, all other players on the rink must position their bodies on their own side of the restraining lines marked on the outer edge of the face-off circles.

If a player other than the player taking the face-off moves into the face-off circle prior to the dropping of the puck, then the offending team's player taking the face-off shall be ejected from the face-off circle. This shall be considered a face-off violation.

Players on the attacking team (exclusive of the center) must establish their position first and then the defending team may counter and hold its position until the puck is dropped. A violation of this procedure shall be treated as face-off encroachment and the Referee shall order the center of the offending team replaced. Should an attacking player attempt to establish a new position prior to the face-off, and the defending center steps back from the face-off spot in order to reposition his teammates, the face-off violation shall be charged to the attacking team as they must establish their position first.

SECTION 10

73.6 **Violations** - If a center should move prematurely prior to the face-off, or if the Referee shall have dropped the puck unfairly, the face-off shall be considered a face-off violation and it must be conducted again.

When at least two face-off violations have been committed by the same team during the same face-off, this team shall be penalized with a minor penalty to the offending player. This penalty shall be announced as a “**Minor Penalty for Delay of Game – Face-off Violation.**”

Face-off violations shall be summarized as follows (either of the Referees may identify a face-off violation):

- (i) *Encroachment by any player other than the center into the face-off area prior to the puck being dropped. Players on the perimeter of the face-off circle must keep both skates outside the face-off circle (skate contact with the line is permitted). If a player’s skate crosses the line into the face-off circle prior to the drop of the puck, this shall be deemed as a face-off violation. A player’s stick may be inside the face-off circle provided there is no physical contact with his opponent or his opponent’s stick.*
- (ii) *Encroachment by any player into the area between the hash marks on the outer edges of the face-off circle prior to the puck being dropped. Players must also ensure that both of their skates do not cross their respective hash marks. Contact with the line with their skate is permitted. If a player’s skate crosses the line into the area between the hash marks prior to the drop of the puck, this shall be deemed as a face-off violation. A player’s stick may be inside the area between the hash marks provided there is no physical contact with his opponent or his opponent’s stick.*
- (iii) *Any physical contact with an opponent prior to the puck being dropped.*
- (iv) *Failure by either center taking the face-off to properly position himself “Properly position himself” shall mean that the center must place his skates squarely such that they are parallel to the side boards and well behind the face-off spot.*

The blade of the stick must then be placed on the rink (at least the toe of the blade of the stick) in the designated area of the face-off spot and must remain there until the puck is dropped.

Failure to comply with this positioning and face-off procedure will result in a face-off violation.

Whenever a team has committed two face-off violations during the same face-off, the Referee shall immediately assess the offending team a minor penalty for delay of game against the player committing the second face-off violation. This penalty shall be announced as a “Minor Penalty for Delay of Game – Face-off Violation.”

Players who are late to the face-off location and therefore in an off-side position for the ensuing face-off will be warned once in the game by the Referee. This warning will also be given to the offending team’s Coach. In this situation, the offending team’s center is not ejected from the face-off. Any subsequent violation shall result in a bench minor penalty for delay of game being assessed to the offending team. This penalty shall be announced as a “**Bench Minor Penalty for Delay of Game – Slow Proceeding to Face-off Location.**”

In the conduct of any face-off, no player facing-off shall make any physical contact with his opponent’s body by means of his own body or by his stick except in the course of playing the puck after the face-off has been completed.

For violation of this rule, the Referee may, at his discretion impose a minor penalty or penalties on the player(s) whose action(s) caused the physical contact. Nonetheless, this physical contact prior to the dropping of the puck shall be deemed as a face-off violation and the Referee shall order the center of the offending team replaced.

Face-off encroachment may be applied during face-offs at any of the face-off spots on the playing surface. However, since no such lines and circles are painted on the rink except at the five (5) recognized face-off spots, Referees shall use their judgment as to whether or not a violation has occurred. All players, other than the centers, shall be uniformly back from the face-off location similar to being outside the face-off circle for face-offs in the end zones or at center.

- 73.7 **Line Changes** - No substitution of players shall be permitted until the face-off has been completed and play has resumed except when a penalty is imposed which affects the on-rink strength of either team.

Should a Referee notice that the defending team has not placed enough players on the rink, the Referee shall instruct the offending team to place another player(s) on the rink. If, in the opinion of the Referee, this is being done as a stalling tactic, he will issue a warning to the offending team’s Coach and any subsequent violations shall result in the assessment of a bench minor penalty for delay of game.

SECTION 10

Should a Referee notice that the attacking team has not placed enough players on the rink for the ensuing face-off, the Referee will proceed with conducting the face-off in the normal manner. The attacking team must ensure they put the appropriate number of players on the rink at all times.

- 73.8 **Verification of Time** - Any loss of time on the game or penalty clocks due to a false face-off or face-off violation must be replaced.

The whistle will not be blown by the official to start play. Playing time will commence from the instant the puck is faced-off and will stop when the whistle is blown or a goal is scored.

Rule 74 **Game and Intermission Timing**

- 74.1 **Game Timing** - The time allowed for an officially sanctioned USARS game shall be two (2) sixteen-minute periods of play with a one-minute rest intermission between periods.

* **NOTE** - *Individual leagues and tournaments have jurisdiction to authorize their own game and intermission timing.*

- 74.2 **Intermission Timing** - Play shall be resumed promptly following each intermission upon the expiration of a one-minute intermission. Timing of the intermission commences immediately upon the conclusion of the period.

For the purpose of keeping the players and spectators informed as to the time remaining during intermissions, the Game Timekeeper will use the electronic clock to record length of intermissions.

Rule 75 **Goals and Assists**

- 75.1 **Goals and Assists** - It is the responsibility of the Referee to award goals and assists, and his decision in this respect is final. Such awards shall be made or withheld strictly in accordance with the provisions of this rule.

In case of an obvious error in awarding a goal or an assist that has been reported by the Referee, it should be corrected promptly, but changes should not be made in the official scoring summary after the Referee has signed the game report.

The team scoring the greatest number of goals during the game shall be the winner and shall be credited with two points.

- 75.2 **Crediting Goals** - A “goal” shall be credited in the scoring records to a player who shall have propelled the puck into the opponent’s goal, or the last player on the attacking team to have touched the puck should a defender propel the puck into his own goal. Each “goal” shall count one point in the player’s record. Only one point can be credited to any one player on a goal.
- 75.3 **Crediting Assists** - When a player scores a goal, an “assist” shall be credited to the player taking part in the play immediately preceding the goal, provided that a defender has not touched the puck in the interim, but no more than one assist can be given on any goal. Each “assist” shall count one point in the player’s record. Only one point can be credited to any one player on a goal.
- 75.4 **Scoring a Goal** - A goal shall be scored when the puck shall have been put between the goal posts legally by a player of the attacking side, from in front and below the crossbar, and entirely across a red line the width of the diameter of the goal posts drawn on the rink from one goal post to the other with the goal frame in its proper position. The goal frame shall be considered in its proper position when both goal posts are in their proper position on the goal line.

A goal shall be scored if the puck is put into the goal in any way by a player of the defending side. The player of the attacking side who last touched the puck shall be credited with the goal but no assist shall be awarded.

If an attacking player has the puck deflect into the net, off his skate or body, in any manner, the goal shall be allowed. The player who deflected the puck shall be credited with the goal.

Should a player legally propel a puck into the goal crease of the opposing Club and the puck should become loose and available to another player of the attacking side, a goal scored on the play shall be legal.

- 75.5 **Disallowed Goals** - Apparent goals shall be disallowed by the Referee and the appropriate announcement made by the Public Address Announcer for the following reasons:
- (i) *When the puck has been directed, batted, or thrown into the net by an attacking player other than with a stick.*
 - (ii) *When the puck has been kicked using a distinct kicking motion.*
 - (iii) *When the puck has deflected directly into the net off an official.*
 - (iv) *When a goal has been scored and an ineligible player is on the rink.*

SECTION 10

- (v) *When an attacking player has interfered with a goalkeeper.*
- (vi) *When the puck has entered the net after making contact with an attacking player's stick that is above the height of the crossbar. Where the puck makes contact with the stick is the determining factor.*
- (vii) *When a goalkeeper has been pushed into the net together with the puck after making a save. See also **Rule 66.6**.*
- (viii) *When the net becomes displaced accidentally. The goal frame is considered to be displaced if either or both goal posts are no longer in their proper location on the goal line prior to or as the puck enters the goal.*
- (ix) *During the delayed calling of a penalty, the offending team cannot score unless the non-offending team shoots the puck into their own net. This shall mean that a deflection off an offending player or any physical action by an offending player that may cause the puck to enter the non-offending team's goal, shall not be considered a legal goal. Play shall be stopped before the puck enters the net (whenever possible) and the signaled penalty assessed to the offending team.*
- (x) *When the Referee deems the play has been stopped, even if he had not physically had the opportunity to stop play by blowing his whistle.*
- (xi) *Any goal scored, other than as covered by the official rules, shall not be allowed.*

Rule 76 **Hand Pass**

76.1 **Hand Pass** - A player shall be permitted to stop or "bat" a puck in the air with his open hand, or push it along the rink with his hand, and the play shall not be stopped unless, in the opinion of the Referees, he has directed the puck to a teammate, or has allowed his team to gain an advantage, and subsequently possession and control of the puck is obtained by a player of the offending team, either directly or deflected off any player or official.

A player shall be permitted to catch the puck out of the air but must immediately place it or knock it down to the rink. If he catches it and skates with it, either to avoid contact or to gain a territorial advantage over his opponent, a minor penalty shall be assessed for "closing his hand on the puck" under **Rule 64 - Handling Puck**.

- 76.2 **Defending Zone** - Play will not be stopped for any hand pass by players in their own defending zone. A hand pass in the defending zone is considered to have occurred when the puck remains in the defending zone during the commencement and completion of the pass and both the player making the pass and the player receiving the pass have both of their skates inside their defending zone.
- 76.3 **Face-Off Location** - When a hand pass violation has occurred, the ensuing face-off shall take place at the center face-off spot, unless the offending team gains a territorial advantage, then the face-off shall be at the nearest last-play face-off spot where the pass was commenced or completed.

Rule 77 **High-sticking the Puck**

- 77.1 **High-sticking the Puck** - Batting the puck above the normal height of the shoulders with a stick is prohibited. When a puck is struck with a high stick and subsequently comes into the possession and control of a player from the offending team (including the player who made contact with the puck), either directly or deflected off any player or official, there shall be a whistle.

When a puck has been contacted by a high stick, the play shall be permitted to continue, provided that:

- (i) *the puck has been batted to an opponent (when a player bats the puck to an opponent, the Referee shall give the “washout” signal immediately. Otherwise, he will stop the play).*
- (ii) *a player of the defending side shall bat the puck into his own goal in which case the goal shall be allowed.*

Cradling the puck on the blade of the stick (like lacrosse) above the normal height of the shoulders shall be prohibited and a stoppage of play shall result. If this is done by a player on a penalty shot or shootout attempt, the shot shall be stopped immediately and considered complete.

- 77.2 **Face-Off Location** - When the play is stopped for the high-sticking the puck violation, the ensuing face-off must take place at one of the end-zone face-off spots of the offending team.
- 77.3 **Disallowed Goal** - When an attacking player causes the puck to enter the opponent's goal by contacting the puck above the height of the crossbar, either directly or deflected off any player or official, the goal shall not be allowed. The determining factor is where the puck makes contact with the stick. If the puck

SECTION 10

makes contact with the stick below the level of the crossbar and enters the goal, this goal shall be allowed.

A goal scored as a result of a defending player striking the puck with his stick carried above the height of the crossbar of the goal frame into his own goal shall be allowed.

Rule 78 Line Changes

78.1 Line Change - Following the stoppage of play, the visiting team shall promptly place a line-up on the rink ready for play and no substitution shall be made from that time until play has been resumed. The home team may then make any desired substitution which does not result in the delay of the game.

“Placing a line-up on the rink” shall mean that both teams shall place the full complement of players (and not exceed) to which they are entitled within the line change time frame.

If there is any undue delay by either team in changing players, the Referee shall order the offending team or teams to take their positions immediately and not permit any further player changes.

When a substitution has been made under the above rule, no additional substitution may be made until play commences.

Once the line change procedure has been completed (Rule 78.2), no additional player substitutions shall be permitted until the face-off has been completed legally and play has resumed, except when a penalty or penalties are imposed that affect the on-rink strength of either or both teams. This may include penalties imposed following the completion of the line change and prior to the face-off, or due to a penalty assessed for a face-off violation.

Goalkeepers' substitution during a game will be conducted within the same time frame as a regular line change. No extra time will be allotted to the goalkeeper coming off the bench, except in the case where an injury to a goalkeeper occurs.

78.2 Procedure - Following a stoppage of play, the Referee not conducting the face-off will enforce the following line change procedure once he has determined that this procedure may begin:

- (i) *The Referee shall give the visiting team up to five (5) seconds to make its line change.*

- (ii) *The Referee shall raise his hand to indicate no further changes by the visiting team and to commence the home team's line change.*
- (iii) *The Referee shall give the home team up to seven (7) seconds to make its line change.*
- (iv) *The Referee shall lower his hand to indicate no further changes by the home team.*
- (v) *Any attempt by the either team to make a change after the Referee's signal, attempt to place too many men on the rink for the subsequent line change, or attempt to make additional personnel changes, shall not be permitted and the Referee will send the players who have attempted to change back to their players' bench. The Referee conducting the face-off will then waive the offending team's center from the face-off. Any subsequent violation shall result in a bench minor penalty for delaying the game. This penalty shall be announced as a "Bench Minor Penalty for Delay of Game – Improper Line Change."*
- (vi) *The Referee conducting the face-off will blow his whistle (once the Referee not conducting the face-off has lowered his hand for the line changes) to indicate that all players must be in position and on-side for the face-off within five (5) seconds. The face-off will then be conducted in accordance with **Rule 73 – Face-offs**.*
- (vii) *The offending team's center shall be waived from the face-off circle for any players who are slow (after the five-second warning whistle given by the Referee) getting to the face-off location or who are in an off-side position for the ensuing face-off will. Any subsequent violation shall result in a minor penalty for delay of game.*

78.3 Bench Minor Penalty - Any attempt by the visiting team to make a change after the Referee's signal shall result in the assessment of a bench minor penalty for delay of game.

Players must proceed directly to the location of the face-off to participate in the ensuing face-off. Any attempts to delay the game by stalling or otherwise unnecessary actions by either team shall result in the assessment of a bench minor penalty for delaying the game. This penalty shall be announced as a "Bench Minor Penalty for Delay of Game – Slow Proceeding to Face-off Location (or, Slow Proceeding to Players' Bench)."

During the play, if a player wishes to retire from the rink and be replaced by a

SECTION 10

substitute, he must do so at the players' bench and not through any other exit leading from the rink. This is not a legal player change and therefore when a violation occurs, a bench minor penalty shall be imposed.

Rule 79 Overtime

- 79.1 **Overtime** - At the end of regulation during a tied match, for games where a tie is not desirable, the overtime period will be commenced immediately following a one (1) minute rest period during which the players will remain on the rink. The teams will not change ends for the first overtime period. At the conclusion of the rest period, the teams will play a ten (10) minute sudden-death playoff. If no team has scored after ten (10) minutes, another one (1) minute rest shall commence, the teams shall change ends, and begin another ten (10) minute sudden-death playoff. This shall continue until a winner is determined.
- 79.2 **Shootout** - During games where a shootout is desired following the end of regulation or any overtime period(s), the teams will proceed to a shootout. The rules governing the shootout shall be the same as those listed under **Rule 25 – Penalty Shot**.

The teams will not change ends for the shootout. The home team shall have the choice of shooting first or second. The teams shall alternate shots.

Three (3) players from each team shall participate in the shootout and they shall proceed in such order as the Coach selects. All players are eligible to participate in the shootout unless they are serving a ten-minute misconduct or have been assessed a game ejection, game misconduct, or match penalty. When a goalkeeper has been assessed a misconduct, the player designated to serve the misconduct penalty becomes ineligible for the shootout. If a misconduct is assessed to the goalkeeper during the course of the shootout, the player designated to serve the misconduct must be a player who has yet to shoot and thus becomes ineligible to shoot.

Once the shootout begins, the goalkeeper cannot be replaced unless he is injured. No warm up shall be permitted for a substitute goalkeeper.

Each team will be given three shots, unless the outcome is determined earlier in the shootout. After each team has taken three shots, if the score remains tied, the shootout will proceed to a "sudden-death" format, with both teams given one shot in each round until a winner is decided. No player may shoot twice until everyone on the game roster who is eligible has shot. If, however, one team has fewer players eligible for the shootout than its opponent, both teams may

select from among the players who have already shot. This procedure would continue until the team with fewer players has again used all eligible shooters.

Regardless of the number of goals scored during the shootout portion of overtime, the final score recorded for the game will give the winning team one more goal than its opponent, based on the score at the end of overtime.

Rule 80 **Puck Out of Bounds**

80.1 Puck Out of Bounds - When a puck goes outside the playing area at either end or either side of the rink, strikes any obstacles above the playing surface other than the boards or glass (such as any flags, banners, or spectator netting), or causes the glass, lighting, timing device, or the supports to break, it shall be faced-off at the nearest last-play face-off spot, except when the attacking team in the attacking zone is responsible for causing the puck to go out of play, the ensuing face-off shall take place at the center face-off spot.

If the puck comes to rest on top of the boards surrounding the playing area, it shall be considered to be in play and may be played legally by hand or stick.

When the puck goes outside the playing area directly off the face-off, regardless as to which player may have last contacted the puck, the face-off shall remain in the same spot and no penalty will be assessed to either team for delaying the game.

When the puck is shot and it makes contact with the gloves or the body of a player hanging over the players' bench, or if the puck enters the players' bench through an open bench door, the face-off shall take place at the nearest last-play face-off spot.

80.2 Puck Unplayable - When the puck becomes lodged in the netting on the outside of either goal so as to make it unplayable, or if it is "frozen" between opposing players intentionally or otherwise, the Referee shall stop the play.

The puck may be played off the goal netting by either team. However, should the puck remain on the goal netting for more than three (3) seconds, play shall be stopped. Should the goalkeeper use his stick or glove to freeze the puck on the back of the net or should a defending player shield an attacking player from playing the puck off the back of the net, the face-off shall take place at one of the end-zone face-off spots in the defending zone.

SECTION 10

Should the puck go under the goal either from behind or the side, or through the mesh from behind or the side, if this is witnessed by a Referee, no goal shall be allowed and play should be stopped immediately and the ensuing face-off should take place at the nearest last-play face-off spot.

80.3 **Puck Out of Sight** - Should a scramble take place or a player accidentally fall on the puck and the puck be out of sight of the Referee, he shall immediately blow his whistle and stop the play. The puck shall then be faced-off at the nearest last-play face-off spot unless otherwise provided for in the rules.

80.4 **Puck Striking Official** - Play shall not be stopped if the puck touches an official anywhere on the rink.

When a puck deflects off an official and goes out of play, the ensuing face-off will take place at the last-play face-off spot nearest to where the puck deflected off the official.

If a goal is scored as a result of being deflected directly into the net off an official, the goal shall not be allowed.

80.5 **Face-Off Location** - Notwithstanding this rule, should an attacking player cause the puck to go out of play or become unplayable in the attacking zone, the face-off shall take place at the center face-off spot or at the nearest last-play face-off spot in the offending player's defending zone, whichever is less advantageous to the attacking team.

For a puck that is unplayable due to being lodged in the netting or as a result of it being frozen between opposing players, the resulting face-off shall be at either of the adjacent face-off spots unless in the opinion of the Referee, the stoppage was caused by the attacking team, in which case the resulting face-off shall be conducted at the center face-off spot.

80.6 **Minor Penalty** - A minor penalty for delay of game shall be imposed on a goal-keeper who deliberately drops the puck on the goal netting to cause a stoppage of play.

Rule 81

Start of Game and Periods

81.1 **Start of Game and Periods** - The game shall be commenced at the time scheduled by a "face-off" in the center of the rink and shall be renewed promptly at the commencement of each period in the same manner.

- 81.2 **Choice of Ends** - Home clubs shall have the choice of goals to defend at the start of the game except where both players' benches are on the same side of the rink, in which case the home club shall start the game defending the goal farthest from its own bench for games played with two halves (or nearest its own bench for games played with three periods). The teams shall change ends for each period of regulation time and for each period of overtime beyond the first overtime. (See **Rule 79 – Overtime**)
- 81.3 **Delays** - No delay shall be permitted by reason of any ceremony, exhibition, demonstration or presentation unless consented to reasonably in advance by the visiting team and the appropriate USARS or local league directors.
- 81.4 **End of Periods** - At the end of each period, in games where full intermissions are being observed, the home team players must proceed directly to their dressing room while the visiting team players must wait for a signal from the Referee to proceed only if they have to go by way of the rink to reach their dressing room. In games where no full intermission is being observed, both teams must proceed directly to their players' benches for the rest period. Failure to comply with this regulation will result in a bench minor penalty for delay of game.
- Players shall not be permitted to come on the rink during a stoppage of play or at the end of any period for the purpose of warming-up.
- 81.5 **Pre-Game Warm-Up** - During the pre-game warm-up (which shall not exceed fifteen (15) minutes in duration) and before the commencement of play in any period, each team shall confine its activity to its own end of the rink.
- The Game Timekeeper shall be responsible for signaling the commencement and termination of the pre-game warm-up and any violation of this rule shall result in imposing a bench minor penalty for delay of game.
- 81.6 **Start of Game and Periods** - See **Rule 70 – Refusing to Start Play**.

Rule 82 Time-outs

- 82.1 **Time-out** - Each team shall be permitted to take one thirty-second time-out at any point during the course of any game. All players including goalkeepers on the rink at the time of the time-out will be allowed to go to their respective benches.
- This time-out must be taken during a normal stoppage of play. Only one time-out shall be permitted at any one stoppage of play.

SECTION 10

Any player designated by the Coach will indicate to the Referee (prior to the drop of the puck) that his team is exercising its option and the Referee will report the time-out to the Game Timekeeper who shall be responsible for signaling the termination of the time-out.

No time-out shall be granted following a face-off violation.

When a penalty shot has been awarded to either team by the Referee, no time-out will be granted once instructions have been given to the player taking the shot and the goalkeeper defending the shot. No time-out will be granted during the shootout.

No warm-up involving pucks on the rink shall be permitted for a goalkeeper or replacement goalkeeper during a time-out. If, after one warning, this continues, the Referee shall assess a delay of game penalty to the offending team.



Reference Tables

TABLE 1
 [Rule 15 – Calling of Penalties]
 SUMMARY OF PENALTIES TO COACHES AND
 NON-PLAYING CLUB PERSONNEL

Description	Rule
(i) Hitting the boards with a stick	Rule 38.3
(ii) Interference with an opponent on a breakaway	Rule 53.6
(iii) Interference with an opponent or the puck while play is in progress	Rule 53.3
(iv) Interference with an opponent or the puck while the goalkeeper has been removed	Rule 53.7
(v) Interfering with an official	Rule 38.3
(vi) Leaving the bench by stepping onto the rink before the end of the period	Rule 67.5
(vii) Obscene language or gestures	Rule 38.3 Rule 72.3
(viii) Physically abusing an official	Rule 38.5 Rule 72.5 Rule 72.6 Rule 39.1
(ix) Refusing to start play (teams in their dressing room)	Rule 70.3
(x) Refusing to start play (teams on the rink)	Rule 70.2
(xi) Throwing a stick on the rink to a player who has lost or broken a stick	Rule 38.3
(xii) Throwing any object onto the rink	Rule 72.3
(xiii) Throwing stick (breakaway on an open net)	Rule 50.7
(xiv) Throwing stick (defending zone)	Rule 50.6

REFERENCE TABLES

TABLE 2
[Rule 16 – Minor Penalties]
SUMMARY OF MINOR PENALTIES

Description	Rule
(i) Boarding	Rule 40
(ii) Broken stick	Rule 10
(iii) Charging	Rule 41
(iv) Closing hand on puck	Rule 64
(v) Cross-checking	Rule 56
(vi) Delay of game	Rule 60
(vii) Elbowing	Rule 43
(viii) Goalkeeper interference	Rule 66
(ix) High-sticking	Rule 57
(x) Holding	Rule 51
(xi) Holding the stick	Rule 51
(xii) Hooking	Rule 52
(xiii) Illegal equipment	Rule 12
(xiv) Illegal stick	Rule 10
(xv) Instigator	Rule 44
(xvi) Interference	Rule 53
(xvii) Kneeing	Rule 47
(xviii) Leaving penalty bench too early	Rule 67
(xix) Leaving the crease (goalkeeper)	Rule 28
(xx) Participating in the play beyond the center red line (goalkeeper)	Rule 28
(xxi) Roughing and Body Checking	Rule 48
(xxii) Slashing	Rule 58
(xxiii) Throwing puck towards opponent's goal (goalkeeper)	Rule 64
(xxiv) Throwing stick	Rule 50
(xxv) Tripping	Rule 54
(xxvi) Unsportsmanlike conduct	Rule 72

TABLE 3
 [Rule 17 – Bench Minor Penalties]
 SUMMARY OF BENCH MINOR PENALTIES

Description	Rule
(i) Abuse of officials	Rule 38
(ii) Delay of game	Rule 60
(iii) Deliberate illegal substitution	Rule 71
(iv) Face-off violation	Rule 73
(v) Illegal substitution	Rule 65
(vi) Improper starting line-up	Rule 7
(vii) Interference from players' or penalty bench	Rule 53
(viii) Interference with an official	Rule 38
(ix) Leaving bench at end of period	Rule 81
(x) Refusing to start play	Rule 70
(xi) Stepping onto rink during period (Coach)	Rule 67
(xii) Throwing objects onto rink	Rule 60
(xiii) Too many men on the rink	Rule 71
(xiv) Unsportsmanlike conduct	Rule 72

TABLE 4
 [Rule 18 – Double-minor Penalties]
 SUMMARY OF DOUBLE-MINOR PENALTIES

Description	Rule
(i) Butt-ending	Rule 55
(ii) Fighting	Rule 44
(iii) Spearing	Rule 59

REFERENCE TABLES

TABLE 5
[Rule 20 – Major Penalties]
SUMMARY OF MAJOR PENALTIES

Description	Rule
(i) Boarding	Rule 40
(ii) Charging	Rule 41
(iii) Checking from behind	Rule 42
(iv) Cross-checking	Rule 56
(v) Elbowing	Rule 43
(vi) Holding	Rule 51
(vii) Interference	Rule 53
(viii) Kneeing	Rule 47
(ix) Roughing and Body Checking	Rule 48
(x) Slashing	Rule 58

TABLE 6
[Rule 20 – Major Penalties]
SUMMARY OF MAJOR PENALTIES THAT RESULT
IN AN AUTOMATIC GAME MISCONDUCT

Description	Rule
(i) Butt-ending	Rule 55
(ii) Checking from Behind (head-first into boards or goal frame)	Rule 42
(iii) Fighting	Rule 44
(iv) Head-butting	Rule 45
(v) Kicking	Rule 46
(vi) Slew-footing	Rule 49
(vii) Spearing	Rule 59

TABLE 7
 [Rule 20 – Major Penalties]
**SUMMARY OF MAJOR PENALTIES THAT RESULT
 IN AN AUTOMATIC GAME MISCONDUCT WHEN THERE IS AN INJURY**

Description	Rule
(i) Boarding	Rule 40
(ii) Charging	Rule 41
(iii) Checking from Behind	Rule 42
(iv) Cross-checking	Rule 56
(v) Elbowing	Rule 43
(vi) High-sticking	Rule 57
(vii) Hooking	Rule 52
(viii) Interference	Rule 53
(ix) Kneeing	Rule 47
(x) Roughing and Body Checking	Rule 48
(xi) Slashing	Rule 58

TABLE 8
 [Rule 21 – Match Penalties]
SUMMARY OF MATCH PENALTIES

Description	Rule
(i) Attempt to injure (in any manner)	Rule 21
(ii) Biting	Rule 21
(iii) Boarding	Rule 40
(iv) Butt-ending *	Rule 55
(v) Charging	Rule 41
(vi) Checking from behind	Rule 42
(vii) Cross-checking	Rule 56
(viii) Deliberate injury (in any manner)	Rule 21
(ix) Elbowing	Rule 43
(x) Grabbing of the face mask	Rule 21

REFERENCE TABLES

(xi) Hair pulling	Rule 21
(xii) Head-butting *	Rule 45
(xiii) High-sticking	Rule 57
(xiv) Kicking a player (or goalkeeper)	Rule 46
(xv) Kneeing	Rule 47
(xvi) Punching and injuring an unsuspecting opponent *	Rule 44
(xvii) Roughing and body checking	Rule 48
(xviii) Slashing	Rule 58
(xix) Slew-footing	Rule 49
(xx) Spearing *	Rule 59
(xxi) Throwing stick or any object	Rule 50
(xxii) Wearing tape on hands in altercation *	Rule 44

TABLE 9

[Rule 22 – Misconduct Penalties]
SUMMARY OF MISCONDUCT PENALTIES

Description	Rule
(i) Banging boards with stick in protest of an official's ruling	Rule 38
(ii) Continuing or attempting to continue a fight	Rule 44
(iii) Deliberately throwing any equipment (including stick) out of playing area	Rule 38 Rule 50
(iv) Entering or remaining in the referee's crease	Rule 38
(v) Fighting off the playing surface (or with another player who is off the playing surface)	Rule 44
(vi) Inciting an opponent	Rule 72
(vii) Instigating a fight	Rule 44
(viii) Interfering or distracting opponent taking a penalty shot	Rule 25
(ix) Knocking or shooting puck out of reach of an official	Rule 38
(x) Leaving bench to speak to official	Rule 6

(xi)	Refusing to change non-regulation piece of protective equipment (second violation)	Rule 9
(xii)	Use of profane or abusive language	Rule 72
(xiii)	Verbal abuse of an official	Rule 38

TABLE 10

[Rule 24 – Game Misconduct Penalties]
SUMMARY OF GAME MISCONDUCT FOULS INCLUDED
IN THE “GENERAL CATEGORY”

	Description	Rule
(i)	Boarding	Rule 40
(ii)	Charging	Rule 41
(iii)	Checking from behind	Rule 42
(iv)	Elbowing	Rule 43
(v)	Fighting	Rule 44
(vi)	Head-butting	Rule 45
(vii)	Hooking	Rule 52
(viii)	Kicking	Rule 46
(ix)	Kneeing	Rule 47
(x)	Interference	Rule 53
(xi)	Intervening in an altercation	Rule 44
(xii)	Kneeing	Rule 47
(xiii)	Obscene language or gestures	Rule 38 Rule 72
(xiv)	Persists in continuing an altercation	Rule 44
(xv)	Removing jersey prior to an altercation	Rule 44
(xvi)	Resisting a Referee in the discharge of his duties	Rule 38
(xvii)	Roughing and body checking	Rule 48
(xviii)	Secondary altercation	Rule 44
(xix)	Second major penalty in a game	Rule 20
(xx)	Slew-footing	Rule 49

REFERENCE TABLES

(xxi)	Throwing equipment onto the rink	Rule 38	Rule 72
(xxii)	Throwing stick outside the playing area (in protest of an official's decision)	Rule 38	Rule 72

TABLE 11

[Rule 24 – Game Misconduct Penalties]
SUMMARY OF GAME MISCONDUCT FOULS INCLUDED IN
THE “STICK-RELATED CATEGORY”

Description	Rule
(i) Butt-ending	Rule 55
(ii) Cross-checking	Rule 56
(iii) High-sticking	Rule 57
(iv) Hooking	Rule 52
(v) Slashing	Rule 58
(vi) Spearing	Rule 59

TABLE 12

[Rule 24 – Game Misconduct Penalties]
SUMMARY OF GAME MISCONDUCT PENALTIES

Description	Rule
(i) Continues or attempts to continue a fight	Rule 44
(ii) Fighting	Rule 44
(iii) First player to leave the players' bench during or to start an altercation	Rule 67
(iv) First to intervene in an altercation (third man in)	Rule 44
(v) Interferes with a game official in the performance of their duties	Rule 38
(vi) Leaving the penalty bench during an altercation	Rule 67
(vii) Obscene gestures	Rule 38 Rule 72

(viii)	Persists to challenge or dispute an official's ruling	Rule 38
(ix)	Physically abuses an official	Rule 39
(x)	Player who has been ordered to the dressing room but returns to the bench or the rink	Rule 67
(xi)	Player who deliberately attempts to injure a Manager, Coach or other non-playing Club personnel in any manner.	Rule 72

TABLE 13
 [Rule 25 – Penalty Shot]
 SUMMARY OF PENALTY SHOTS

	Description	Rule	
(i)	Deliberate illegal substitution	Rule 65	
(ii)	Intentionally dislodging the net during the course of a breakaway	Rule 60	
(iii)	Intentionally dislodging the net when the penalty cannot be served in its entirety within regulation time or any time in overtime	Rule 60	
(iv)	Falling on the puck in the goal crease	Rule 60	
(v)	Picking up the puck with the hand in the goal crease	Rule 60	
(vi)	Player on a breakaway who is interfered with by an object thrown or shot by a defending team player	Rule 50	Rule 53
(vii)	Player on a breakaway who is interfered with by a player who has illegally entered the game	Rule 67	
(viii)	Player throws or shoots an object at the puck in his defending zone	Rule 50	
(ix)	Player on a breakaway who is fouled from behind.	Rule 25 Rule 51 Rule 52	Rule 53 Rule 54 Rule 58

REFERENCE TABLES

TABLE 14

[Rule 26 - Awarded Goals]
SUMMARY OF AWARDED GOALS [WHEN GOALKEEPER HAS
BEEN REMOVED FOR AN EXTRA ATTACKER]

Description	Rule
(i) Delaying the game	Rule 60
(ii) Handling the puck	Rule 64
(iii) Illegal substitution	Rule 64
(iv) Interference	Rule 53
(v) Leaving the players' or penalty bench	Rule 67
(vi) Throwing stick	Rule 50
(vii) Tripping (fouling from behind - including hooking, holding, slashing, etc.)	Rule 54

TABLE 15

[Rule 28 - Goalkeeper's Penalties]
SUMMARY OF GOALKEEPER PENALTIES

Description	Rule
(i) Illegal stick	Rule 10
(ii) Illegal equipment	Rule 9 Rule 12
(iii) Leaving crease during an altercation	Rule 28
(iv) Proceeding to players' bench	Rule 28
(v) Participates in the play beyond the center red line	Rule 28
(vi) Proceeds to players' bench to replace stick	Rule 10
(vii) Shoots or bats puck out of play	Rule 60
(viii) Deliberately falls on the puck inside or outside the goal crease	Rule 60
(ix) Deliberately drops the puck in his pads or on the goal net	Rule 64
(x) Piling obstacles at or near the net	Rule 64
(xi) Throwing the puck towards opponent's goal	Rule 64

TABLE 16
 [Rule 16 – Minor Penalties]
GOALS SCORED AGAINST A SHORT-HANDED TEAM

Ex	Time	Team A	Team B	Answer	Remarks
Minor penalty expiration criteria:					
a. Is the team scored against, short-handed?					
b. Are they serving a minor penalty on the clock?					
c. If the answer is yes to a) and b), delete the minor penalty with the least amount of time on the clock, except when coincidental penalties are being served.					
One player with a double minor penalty:					
A1	3:00	A15 – 2+2	Goal	No player returns	First penalty ends, the second begins at 4:30.
	4:30				
A2	3:00	A15 – 2+2	Goal	A15 returns.	The first penalty has expired, the second ends with the scoring of the goal.
	5:30				
One player with a minor and a major penalty:					
B1	3:00	A15 – 5+2	Goal	No penalty terminates.	The major penalty must be served first.
	4:30				
B2	3:00	A15 – 5+2	Goal	A15 returns.	The major penalty has expired, the minor penalty ends with the scoring of the goal.
	8:30				
Two players of the same team – combination of minor and major penalties:					
C1	3:00	A15 – 2	Goal	A15 returns.	
	4:00	A23 – 2			
	4:30				
C2	3:00	A15 – 2	Goal	A15 returns.	
	4:00	A23 – 5			
	4:30				

REFERENCE TABLES

C3	3:00 4:00 4:30	A15 – 5 A23 – 2	Goal	A23 returns.	
C4	3:00 4:00 4:30 5:30	A15 – 2+2 A23 – 2	Goal	No player returns. A23 returns.	The first minor to A15 ends. A23 returns because he has the least amount of time to serve in his minor penalty.
C5	3:00 (S*) 4:30	A15 – 2 A23 – 2+2	Goal	A15 returns.	The signaled double-minor penalty to A23 is assessed at 4:30. * S = signaled
C6	3:00 4:00 4:30	A15 – 5+2 A23 – 2	Goal	A23 returns.	A15 must first serve his major penalty. A23 returns as he is serving a minor penalty.
C7	3:00 7:30 8:30	A15 – 5+2 A23 – 2	Goal	A23 returns.	Least amount of time to serve.
C8	3:00 6:00 8:00	A15 – 5+2 A23 – 2	Goal	Both A15 and A23 return.	The major penalty to A15 has expired. His minor penalty ends with the goal. A23's minor penalty has expired.
C9	3:00 8:00 9:00	A15 – 5+2 A23 – 2	Goal	Captain's choice.	The major penalty to A15 has expired. Both minors terminate at the same time.

Reference Tables

Three players of the same team –

Delayed (D) or Signaled (S) penalty (no stoppage of play):

D1	3:00	A15 – 2			
	3:30	A23 – 2			
	4:00	A6 – 2(D)			
	4:30		Goal	A15 returns.	Delayed penalty to A6 begins at 4:30 The minor penalty to A15 is completed. The minor penalty to A6 begins.
	5:00		Goal	A23 returns.	Penalties to A15 and A23 are completed. The minor to A6 ends with the scoring of the goal.
	5:30		Goal	A6 returns.	
D2	3:00	A15 – 2			
	3:30	A23 – 2			
	(S) 4:30	A6 – 2	Goal	A15 returns and the penalty to A6 starts. A23 returns and A6 remains in the box.	
	5:00		Goal		
D3	3:00	A15 – 5			
	3:30	A23 – 2			
	(S) 4:30	A6 – 2	Goal	A23 returns and the penalty to A6 starts.	
D4	3:00	A15 – 5			
	7:30	A23 – 2			
	(S) 8:00	A6 – 2	Goal	A15 and A23 return and the penalty to A6 starts.	The major penalty to A15 is completed. The minor penalty to A23 ends on the scoring of the goal.

REFERENCE TABLES

One player from each team – combination of minors and majors:					
E1	3:00	A15 - 2	B12 - 2	No player returns. A15 returns.	Teams are at equal strength. His minor penalty has been completed.
	3:30				
	4:30				
	5:00				
E2	3:00	A15 - 5+2	B12 - 2	No player returns.	Teams are at equal strength.
	3:30				
	4:30				
E3	3:00	A15 - 5+2	B12 - 2	No player returns.	The major penalty to A15 is complete but the teams remain at equal strength.
	7:30				
	8:00				
E4	3:00	A15 - 2+2	B12 - 2	No player returns. No player returns. A15 returns.	Teams are at equal strength. The first minor to A15 is completed but teams remain at equal strength. The first minor penalty to A15 and that of B12 are complete. The second minor penalty to A15 ends with the scoring of the goal.
	3:30				
	4:30				
	5:00				
	5:30				
	5:30				

Reference Tables

E5	3:00	A15 – 5+2	B12 – 2	A15 returns.	The major penalty to A15 and the minor penalty to B12 have expired. The minor penalty to A15 ends on the scoring of the goal.	
	6:00					
	8:00					Goal
E6	3:00	A15 – 2	B12 – 2	No player returns.	The goal nullifies the signaled penalty to A23 (Reason: Team A was not short-handed).	
	3:30	A23 – 2				
	(S)					
	4:10					Goal
Unequal number of players – combination of minors and majors:						
F1	3:00	A15 – 2	B12 – 2	A15 returns.	He had the least amount of time to serve in his minor penalty.	
	3:30	A23 – 2				
	4:00					
	4:30					Goal
F2	3:00	A15 – 2	B12 – 2	A15 returns.	His minor penalty is completed. Teams are at equal strength at the time of the goal.	
	3:30	A23 – 2				
	4:00					
	5:00					Goal
F3	3:00	A15 – 2	B12 – 2	A15 returns.		
	3:30	A23 – 2				
	4:00					
	4:30	Goal				
F4	3:00	A15 – 2	B12 – 2	A15 returns.	Least amount of time to serve in his minor penalty.	
	3:30					
	4:00					A23 – 5
	4:30					Goal

REFERENCE TABLES

F5	3:00		B12 – 2		Least amount of time to serve in his minor penalty.
	3:30	A15 – 2			
	4:00	A23 – 2			
	4:30		Goal	A15 returns.	
	5:00		Goal	A23 returns	
F6	3:00	A15 – 5			Least amount of time (and Team A is short-handed by reason of a minor penalty).
	3:30		B12 – 5	A23 returns.	
	4:00	A23 – 2			
	4:30		Goal		
F7	3:00	A15 – 2			Least amount of time (and Team A is short-handed by reason of a minor penalty).
	3:30		B12 – 5	A15 returns.	
	4:00	A23 – 5			
	4:30		Goal		
F8	3:00	A15 – 5			Short-handed by reason of a minor penalty.
	3:30	A23 – 2			
	4:00		B12 – 2	A23 returns.	
	4:30		Goal		
F9	3:00	A15 – 5			Short-handed by reason of a minor penalty.
	3:30		B12 – 2	A23 returns.	
	4:00	A23 – 2			
	4:30		Goal		
F10	3:00	A15 – 2			Short-handed by reason of a minor penalty.
	3:30	A23 – 5			
	4:00		B12 – 2	A15 returns.	
	4:30		Goal		
F11	3:00		B12 – 5		Least amount of time.
	3:30	A15 – 2		A15 returns.	
	4:00	A23 – 2			
	4:30		Goal		

Reference Tables

F12	3:00	A15 – 2+2			
	3:30		B12 – 2	No player returns.	First minor penalty to A15 ends.
	4:00	A23 – 2			
	4:30		Goal		
F13	3:00	A15 – 2			
	3:15	A23 – 2			
	3:30		B12 – 2		
	3:45	A6 – 2(D)			
	4:00		Goal	A15 returns.	
	4:30		Goal	A23 returns.	
F14	3:00	A15 – 2	B12 – 2		Penalties to A15, B12, A6, and B3 are not on the clock.
	3:15	A23 – 2			
	3:30	A6 – 2	B3 – 2	A23 returns.	
	5:10		Goal		
F15	3:00	A15 – 2			The penalty to B12 does not make Team B short-handed.
	3:30		B12 – 2	Signaled penalty to B3 is not assessed.	
	4:00	A23 – 2			
	4:30	Goal	B3 – 2		
F16	3:00	A15 – 2			
	3:30		B12 – 2		
	4:00	A23 – 2		A15 returns.	
	4:30	A6 – 2			
	4:30		Goal		

REFERENCE TABLES

Coincidental penalties – equal number of players on each team:					
G1	3:00 4:30	A15 – 5+2	B12 – 2+2 Goal	No player returns.	Teams are at equal strength.
G2	3:00 4:30	A15 – 2+5	B12 – 5 Goal	The substitute for A15 returns.	Coincidental major penalties.
G3	3:00 3:30 4:30	A15 – 2 A23 – 2	B12 – 2 Goal	A15 returns.	Coincidental penalties are not put on the clock.
G4	3:00 3:30 4:30	A15 – 2 A23 – 2	B12 – 2 Goal	A23 returns.	Coincidental penalties are not put on the clock.
G5	3:00 3:30 4:30	A15 – 2 A23 – 5	B12 – 2 Goal	No player returns.	Team A is short-handed, however, it is with a major penalty.
G6	3:00 3:30 4:30	A15 – 2 A23 – 5	B12 – 5 Goal	A15 returns.	Team A is below the numerical strength of it's opponent. Minor penalty to A15 expires on the scoring of the goal.
G7	3:00 3:30 4:30	A15 – 2 A23 – 2	 Goal	A15 returns.	
G8	3:00 3:30 4:30	A15 – 2 A23 – 5	B12 – 5 Goal	A15 returns.	Penalties to A23 and B12 are not on the clock.
G9	3:00 3:30 4:30	A15 – 5 A23 – 2	B12 – 2 Goal	No player returns.	A15 is serving a major penalty. Penalties to A23 and B12 are not on the clock.

Reference Tables

G10	3:00 3:30 4:30	A15 – 5 A23 – 2	B12 – 5 Goal	A23 returns.	Short-handed by reason of a minor penalty.
G11	3:00 3:30 4:30	A15 – 2+2 A23 – 2	B12 – 5 Goal	No player returns.	First minor penalty to A15 is eliminated.
G12	3:00 3:30 (S) 4:30	A15 – 2 A23 – 5 A6 – 2	B12 – 2 Goal	The penalty to A6 is not assessed (unless it is a major or match penalty).	
G13	3:00 3:30 4:00 4:30 4:45	A15 – 2 A23 – 2 A6 – 2	B12 – 2 Goal Goal	A15 returns. A6 returns.	Penalties to A23 and B12 are not on the clock.
G14	3:00 3:30 (S) 4:30	A15 – 2 A23 – 2 A6 – 2	B12 – 2 Goal	A15 returns.	The minor penalty to A6 begins at 4:30. The penalties to A23 and B12 are not on the clock.
G15	3:00 3:30	A15 – 2+2	B12 – 2 Goal	Minor penalty to A15 is eliminated.	Team A would have placed an additional player in the penalty box to serve the extra minor penalty to A15. A15's additional penalty begins at 3:30 due to the goal by Team B, but does not affect the on-rink strength.

REFERENCE TABLES

Coincident penalties – unequal number of players on each team:					
H1	3:00 4:30	A15 – 2 A23 – 2	B12 – 2 Goal	Captain's choice.	This choice must be made at the time of assessment of the penalties.
H2	3:00 4:30	A15 – 2 A23 – 5	B12 – 2 Goal	No player returns.	The major penalty makes the team short-handed. The penalties to A15 and B12 do not go on the clock.
H4	3:00 4:30	A15 – 2 A23 – 5	B12 – 5 Goal	A15 returns.	Major penalties are coincidental and do not go on the clock.
H5	3:00 4:30	A15 – 5 A23 – 2	B12 – 2 Goal	No player returns.	Coincidental minor penalties. Team A is short-handed by reason of the major penalty. Penalties to A23 and B12 do not go on the clock.
H6	3:00 4:30	A15 – 2+2 A23 – 2	B12 – 2 Goal	Captain's choice. The minor penalty to B12 can cancel off with any one of the minor penalties assessed to the two players on Team A.	Depending on the choice made by Team A when the penalties were assessed, A23 may return or the first minor penalty to A15 will end with the scoring of the goal.

Reference Tables

H7	3:00 4:30	A15 – 2 A23 – 2+2	B12 – 2 Goal	Captain's choice. The minor penalty to B12 can cancel off with any one of the minor penalties assessed to the two players on Team A.	Depending on the choice made by Team A when the penalties were assessed, A15 may return or the first minor penalty to A23 will end with the scoring of the goal.
H8	3:00 4:00 4:30	A15 – 2 A23 – 2 A6 – 2	B12 – 2 Goal Goal	 Captain's choice. Remaining player returns.	B12 and one of the minor penalties to Team A (depending on choice) will not go on the clock. According to the choice made by Team A when the penalties were assessed.
H9	3:00 4:30	A15 – 5 A23 – 2 A6 – 2	B12 – 2 Goal	Captain's choice between A23 and A6.	Coincidental penalty rule applies to B12 and either A23 or A6 (and these penalties would not go on the clock).
H10	4:00 4:30 5:00	A15 – 2 A23 – 2+2	B12 – 2 Goal	No player returns.	A23's first penalty terminates. A23's second penalty starts.

NOTE: Coincident penalties must always be served in their entirety.

REFERENCE TABLES

TABLE 17
 [Rule 19 – Coincidental Penalties]
COINCIDENTAL PENALTIES
 [all penalties assessed at the same stoppage]

	Team A	Penalties	Team B	Penalties	On-rink Strength
Example 1	A3	2	B10	2+2	Team B will play one player short-handed for two minutes. Team B must place an additional player to serve the extra minor penalty to B10.
Example 2	A3	2	B10	2+2	Teams play at full strength.
	A5	2+2	B12	2	
Example 3	A3	2+2	B10	2+2	Teams play at full strength.
	A5	5	B12	5	
Example 4	A3	2+5	B10	2	Teams play at full strength
			B12	5	

Reference Tables

Example 5	A3	2+5	B10	2	Team A will play one player short-handed for two minutes. Team A Captain's choice to determine which penalty would go on the penalty time clock. Should A3 be chosen, then an additional team A player must be placed on the penalty bench to serve the minor penalty for A3.
	A5	2	B12	5	
Example 6	A3	2+2	B10	2+2	Team A one player short-handed for five minutes.
	A5	5			
Example 7	A3	2+2	B10	2	Team A Captain's choice to play one player short-handed for four minutes or two players short-handed for two minutes. Should he choose the latter, an additional team A player must be placed on the penalty bench to serve the minor penalty for A3.
	A5	2			

REFERENCE TABLES

Example 8	A9	2	B2	2+2	Team B will be one player short-handed for two minutes. Team B Captain's choice of which player's time will go on the penalty time clock. If he chooses B2, then team B must place an additional player on the penalty bench to serve B2's minor penalty.
	A24	2	B18	2	
Example 9	A3	5	B5	5	Teams play at full strength.
Example 10	A3	5	B5	5	Team B short-handed for five minutes (Captain's choice).
			B7	5	
Example 11	A3	5	B5	5	Teams play at full strength.
	A4	5	B7	5	
Example 12	A3	5+5	B5	5	Team A short-handed for five minutes. Team A must place an additional player on the penalty bench to serve the extra major penalty.
Example 13	A3	5+5	B5	5	Teams play at full strength.
			B7	5	

Reference Tables

Example 14	A3 A4	5+5 5	B7	5	Team A has the choice to cancel one of the two major penalties assessed to A3 and play short-handed by two players for five minutes or to simply cancel the one to A4 and play short-handed for ten minutes. Should they choose A3, they will require an additional player in the penalty box.
Example 15	A3 A4	5+5 5	B5 B7	5 5	Team A will be short-handed for five minutes. Team choice to cancel majors assessed. Should they choose A3, they will require an additional player in the penalty box.
Example 16	A3	2+5	B7	5	Team A must place another player in the penalty box to serve the additional minor penalty to A3 immediately.
Example 17	A3	2+5	B7	2+5	Teams play at full strength.

REFERENCE TABLES

Example 18	A3	2+5	B5 B7	5 5	Team A short-handed for two minutes. Team B short-handed for five minutes (Captain's choice). Team A must place another player in the penalty box to serve the minor penalty.
Example 19	A3	2+5	B5	2+2+5	Team B will play short-handed for two minutes. Team B will require an additional player in the penalty box to serve the minor penalty.
Example 20	A3 A4	2+5 5	B5 B7	5 5	Team A will play short-handed for two minutes. Team A will require an additional player in the penalty box to serve the minor penalty.
Example 21	A3 A4	2+5 2+2+5	B5 B7	2+5 5+5	Team A will be short-handed either one player for four minutes, or two players for two minutes (Captain's choice). Team B will be short-handed for five minutes (Captain's choice).

Reference Tables

Example 22	A3	2+5	B5	2+2+5	Team B will be short-handed either one player for seven minutes or two players, one for two minutes and one for five minutes (Captain's choice).
	A4	5	B7	5+5	
Example 25	A3	2+5	B5	5	Team A will be short-handed, either one player for seven minutes, or two players, one for two minutes and one for five minutes (Captain's choice).
	A4	5			
Example 26	A3	2+5+5	B5	2+5	Teams play at full strength.
			B7	5	
Example 27	A5	2	B12	5+5	Teams play at full strength.
	A6	5+5	B13	2	
	A7	5	B14	5	

REFERENCE TABLES

TABLE 18
 [Rule 66 – Interference with the Goalkeeper]
 INTERFERENCE WITH THE GOALKEEPER SITUATIONS

Situation	Result
1. THE GOALKEEPER IS IN THE GOAL CREASE.	
A. An attacking player is standing in the goal crease when the puck enters the crease then crosses the goal line. In no way does he affect the goalkeeper's ability to defend his goal.	Goal is allowed. This is a good goal.
B. An attacking player makes incidental contact with the goalkeeper, however, no goal is scored on the play.	Play continues, no whistle.
C. An attacking player makes incidental contact with the goalkeeper at the same time a goal is scored.	Goal is disallowed. The official in his judgment may call a Minor penalty on the attacking player. The announcement should be, "No goal due to interference with the goalkeeper."
D. An attacking player makes other than incidental contact with the goalkeeper, however, no goal is scored on the play.	A Minor penalty, plus assessment of whatever other penalties may be appropriate up to and including Supplementary Discipline.
E. An attacking player makes other than incidental contact with the goalkeeper at the time a goal is scored.	Goal is disallowed, and a Minor and/or Major penalty, plus assessment of whatever penalties may be appropriate up to and including Supplementary Discipline.
2. THE GOALKEEPER IS OUT OF THE GOAL CREASE.	
A. An attacking player makes incidental contact with the goalkeeper, however, no goal is scored on the play.	Play continues, no whistle.

Reference Tables

<p>B. An attacking player makes incidental contact with the goalkeeper at the time a goal is scored.</p>	<p>Goal is allowed.</p>
<p>C. An attacking player makes other than incidental contact with the goalkeeper, however, no goal is scored on the play.</p>	<p>A Minor and/or Major penalty, plus assessment of whatever other penalties may be appropriate up to and including Supplementary Discipline.</p>
<p>D. An attacking player makes other than incidental contact with the goalkeeper at the time a goal is scored.</p>	<p>A Minor and/or Major penalty, plus assessment of whatever other penalties may be appropriate up to and including Supplementary Discipline, and the goal is disallowed.</p>
<p>3. A DEFENDING PLAYER PUSHES, SHOVES, OR FOULS AN ATTACKING PLAYER INTO THE GOALKEEPER, WHO IS IN OR OUT OF THE CREESE.</p>	
<p>A. The attacking player, after having made a reasonable effort to avoid contact, makes contact with the goalkeeper at the time a goal is scored.</p>	<p>Goal is allowed.</p>
<p>B. The contact by the attacking player with the goalkeeper is other than incidental and the attacking player, in the judgment of the Referee, did not make a reasonable effort to avoid such contact. However, no goal is scored on the play.</p>	<p>A Minor and/or Major penalty, plus assessment of whatever other penalties may be appropriate up to and including Supplementary Discipline.</p>
<p>C. The contact by the attacking player with the goalkeeper is other than incidental and the attacking player, in the judgment of the Referee, did not make a reasonable effort to avoid such contact at the time a goal is scored.</p>	<p>A Minor and/or Major penalty, plus assessment of whatever other penalties may be appropriate up to and including Supplementary Discipline, and the goal is disallowed.</p>

REFERENCE TABLES

4. BATTLE FOR LOOSE PUCK WITH THE GOALKEEPER WHILE THE GOALKEEPER IS IN OR OUT OF THE GOAL CREASE.	
a. An attacking player makes incidental contact with the goalkeeper while both are attempting to play a loose puck at the time a goal is scored.	Goal is allowed.
b. An attacking player makes other than incidental contact with the goalkeeper while both are attempting to play a loose puck at the time a goal is scored.	A Minor and/or Major penalty, plus assessment of whatever other penalties may be appropriate up to and including Supplementary Discipline, and the goal is disallowed.
5. SCREENING SITUATIONS.	
a. An attacking player skates in front of the goalkeeper at the top of the goal crease, at the same time a goal is being scored. The attacking player remains in motion and does not maintain a significant position in the crease in front of the goalkeeper.	Goal is allowed. This is a good goal.
b. An attacking player skates in front of the goalkeeper, outside the crease, at the same time a goal is being scored. The attacking player remains in motion and impairs the goalkeeper's ability to defend his goal.	Goal is allowed.
c. An attacking player plants himself within the goal crease, as to obstruct the goalkeeper's vision and impair his ability to defend his goal, and a goal is scored.	Goal is disallowed. The announcement should be, "No goal due to interference with the goalkeeper."

<p>d. An attacking player plants himself on the crease line or outside the goal crease, as to obstruct the goalkeeper's vision and impair his ability to defend his goal, and a goal is scored.</p>	<p>Goal is allowed.</p>
<p>6. CROWDING THE GOALKEEPER.</p>	
<p>a. A goalkeeper initiates contact with an attacking player to establish position in the crease and the attacking player vacates the position immediately. No goal is scored on the play.</p>	<p>Play continues, no whistle.</p>
<p>b. A goalkeeper initiates contact with an attacking player to establish position in the crease and the attacking player does not vacate the position, however, no goal is scored on the play. A possible penalty depends on the Referee's judgment as to the degree of contact and degree of resistance with the attacking player and whether the goalkeeper was truly trying to establish a position.</p>	<p>Minor penalty. This player runs the risk of "bad things" happening by being in the crease. In this example it is a minor penalty.</p>
<p>c. A goalkeeper initiates contact with an attacking player in the crease to establish position and the attacking player vacates the position immediately at the time a goal is scored. Even though the attacking player vacates his position immediately, the contact impairs the goalkeeper's ability to defend his goal.</p>	<p>Goal is disallowed. The announcement should be, "No goal due to interference with the goalkeeper."</p>
<p>D. A goalkeeper initiates contact with an attacking player to establish position in the crease and the attacking player refuses to give ground at the time a goal is scored.</p>	<p>Goal is disallowed. A Minor penalty is not assessed (loss of goal only). The announcement should be, "No goal due to interference with the goalkeeper."</p>

REFERENCE TABLES

<p>E. A goalkeeper deliberately initiates contact with an attacking player other than to establish position in the crease, or otherwise acts to make unnecessary contact with the attacking player.</p>	<p>Minor penalty to the goalkeeper (slashing, tripping, roughing, etc.).</p>
<p>F. A goalkeeper initiates contact with an attacking player to establish position in the crease by using excessive force or acting in a manner which would otherwise warrant a penalty, and the attacking player refuses to give ground at the time a goal is scored.</p>	<p>Coincidental Minors (goalkeeper/attacking player) [In this situation, the Referee would emphatically display to players and the fans that he was calling penalties before the puck entered the net, and thus the play was dead at the time the infractions occurred and thus stated there is no goal.]</p>
<p>G. A goalkeeper initiates contact with an attacking player to establish position in the crease by using excessive force or acting in a manner which would otherwise warrant a penalty, and the attacking player vacates the crease at the time a goal is scored.</p>	<p>A Minor penalty to the goalkeeper and the goal is disallowed. This is an example where the attacking player has prevented the goalkeeper from doing his job by being in the crease. The announcement should be, “No goal due to interference with the goalkeeper (plus the announcement of the goalkeeper’s penalty).”</p>
<p>H. A goalkeeper initiates contact with an attacking player to establish position in the crease by using excessive force or acting in a manner which would otherwise warrant a penalty and the attacking player vacates the crease, but no goal is scored.</p>	<p>Minor penalty to goalkeeper.</p>
<p>7. CONTACT WITH THE GOALKEEPER.</p>	
<p>A. An attacking player initiates contact with the goalkeeper, inside or outside the goal crease, in a fashion that would otherwise warrant a penalty (e.g. “runs” the goalkeeper).</p>	<p>Appropriate penalty (Minor and/or Major and a Game Misconduct) and subject to additional sanctions as appropriate, pursuant to Rule 29 – Supplementary Discipline.</p>

Reference Tables

<p>B. An attacking player is in the crease and makes every effort to vacate the crease and the goalkeeper initiates contact to embellish and draw a penalty. No goal is scored on the play.</p>	<p>This is a dive and a Minor penalty to the goalkeeper (diving).</p>
<p>C. A defensive player directs the puck into his own net while an attacking player initiates contact with the goalkeeper.</p>	<p>Goal is disallowed and a Minor and/or Major penalty, plus assessment of whatever other penalties may be appropriate up to and including Supplementary Discipline to the attacking player.</p>
<p>D. A defensive player directs the puck into his own net while an attacking player is standing in the goal crease. The attacking player does not affect the goalkeeper's ability to make the save.</p>	<p>Goal is allowed.</p>



AAU Modified Tournament Rules

Length of Game: 2 halves, 16 to 20 minutes in duration each (running time). Stop clock in the last minute when the score is within 1 goal or tied.

Time-outs: Each team is permitted one time-out per game, one minute in length. The game clock shall stop during a time-out. If time-out is not used in regulation, it may be used in overtime.

3-Penalty Rule: Any player that receives 3 penalties of any kind in a single game, with the exception of a 10 minute misconduct, he/she is to be ruled off the floor for the remainder of the game.

Penalties: Minor Penalties-2 minutes Major Penalties-5 minutes Misconduct Penalty-10 minutes

Major Penalties: Major 5 minutes or 5 minutes and a game misconduct at the discretion of the referee. Any player that receives 2 majors in a single game will be assessed a game misconduct

Match Penalty: 5 minutes to be served plus player shall be ruled off the floor for the remainder of the game.

Game Ejection: Player shall be ruled off the floor for the remainder of the game.

Game Misconduct: Carries an automatic 1 game suspension. If any coach or player participates in more than one age division and receives a game misconduct in one age division, that coach or player will not be allowed to participate in any other age divisions until that suspension has been served in the age division the suspension was issued in.

Starting lineup: A team must have a goalie and four players to start a game.

Start of Game: Players will start the game defending the zone opposite their player bench.

Face Offs: Once a team is in face-off position, the puck can be put into play within three seconds.

Face off spots: Only recognize four end zone face off spots and center dot. All face-offs take place on one of these dots, or location of last played along an imaginary line connecting end-zone face-off to the opposite end-zone face-offs spot. Attacking team causing an infraction in the attacking zone the face-off will be conducted at the center face-off spot.

Tied games: Games shall end in a tie if no winner must be determined (Round Robin

MODIFIED AAU TOURNAMENT RULES

Games). If a winner must be determined (Playoff Games), the length of a sudden death overtime period will be determined by the length of the previous regulation time period and continuous periods thereafter until a winner has been determined. Teams will switch ends for each and every overtime period. Independent AAU sanctioned tournaments and leagues may choose their own format.

Crease Rule: The crease is intended to implicate “no harm no foul” standard . The rule is based on the premise that an attacking player’s position whether inside or outside the crease, should not by itself determine whether a goal should be allowed or disallowed. If the attacking player’s position or body contact impairs the goalkeepers ability to move freely in his/her crease or defend his/her goal, goals should be disallowed. Incidental contact with a goalkeeper inside or outside his/her crease will be permitted providing the attacking player made a reasonable effort to avoid such contact.

(Referee’s discretion)

Change of Players: permitted during a stoppage of play at all times, or change on the fly within five feet of the players bench.

Roughing: A minor or double minor penalty may be imposed on any player for unnecessary roughness.

Butt-Ending: Attempt: double minor penalty. **Making Contact:** major penalty plus game misconduct. **Injury:** match penalty.

Checking from Behind: A minor/major or a major penalty and a game misconduct may be assessed.

Fighting: Major penalty plus game misconduct; additional minor penalty for instigator.

High Sticking: A high sticking violation (non-penalty) results in a face-off at the offending team’s defensive zone or spot last played if in the defensive zone. NO center face-off as a result of a high stick violation (non-penalty).

Displacing Goal Post: Intentional in the last 2 minutes or in OT results in a penalty shot for non-offending team.

Skates: All axel openings must contain an axle and a wheel, Example: A four wheel frame must contain four axles and four wheels. If a player loses a wheel during play, they must proceed directly to the players bench or Play shall be stopped when the offending team gains possession. No penalty shall be assessed.

Goals: A goal shall not be allowed if the puck has been kicked, thrown or otherwise deliberately directed into the goal by any means other than a stick.

Delayed Penalties: If when a team is “short-handed” by reason of one or more minor or bench minor penalties the Referee signals a further minor penalty against the “short-handed” team a goal is scored by the non-offending side before the whistle is blown then the delayed penalty shall be served and the first of the minor penalties already being served shall automatically terminate.

Coincidental Minor/Major Penalties: They are penalties that do not cause either team to be shorthanded, and occurs when players(s) from both teams simultaneously receive equal length penalties. When coincident penalties are assessed, the penalized players take their places on their respective penalty benches, and both teams are able to make immediate substitutions for these penalized players. The penalized players are required to serve the full amount of assessed time and remain in the penalty box until the first stoppage of play after the expiration of time. If one team is already short a player because of an earlier penalty, coincidental penalties will not change the number of players on the floor.