

Tactical Worksheet Cheat Sheet

14	Stage

D/G Supervisor when a single resource

BC1

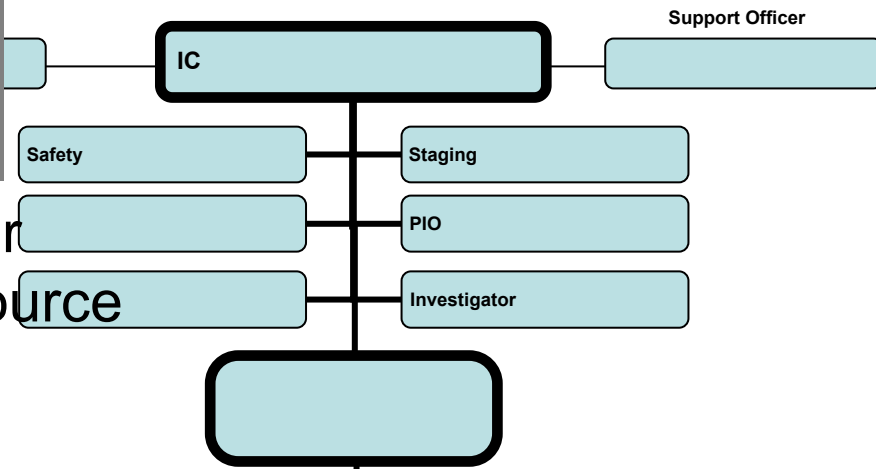

Benchmarks

360 Complete
All Clear
Under Control
Loss Stopped
Customer OKAY

Checklist

Positive water Supply
Flow path identified
Door Control
RIT / On Deck
Med Transport
Secondary Supply / FDC
Weather
Secondary Complete
% Survivable space
Elapsed Incident Times

Strategy

Risk/Reward	Savable Lives		Savable Property		Nothing to Save
	Small	Small	Medium	Large	Mega
Building Size	Small	Small	Medium	Large	Mega
Arrangement/ Access/ Condition / Construction	1	2	3	4	5
Occupancy Type	SFD	MD	MD	Commercial	Commercial
Fire Load	Low	Low	Ordinary	High	Extreme
Fire Location / Extent / Duration	1	2	3	4	5
Built in Protection	Automatic (i.e. sprinklers)		Manual (i.e. Standpipes)		None
Special Hazards	1	2	3	4	5
Offensive				Defensive	

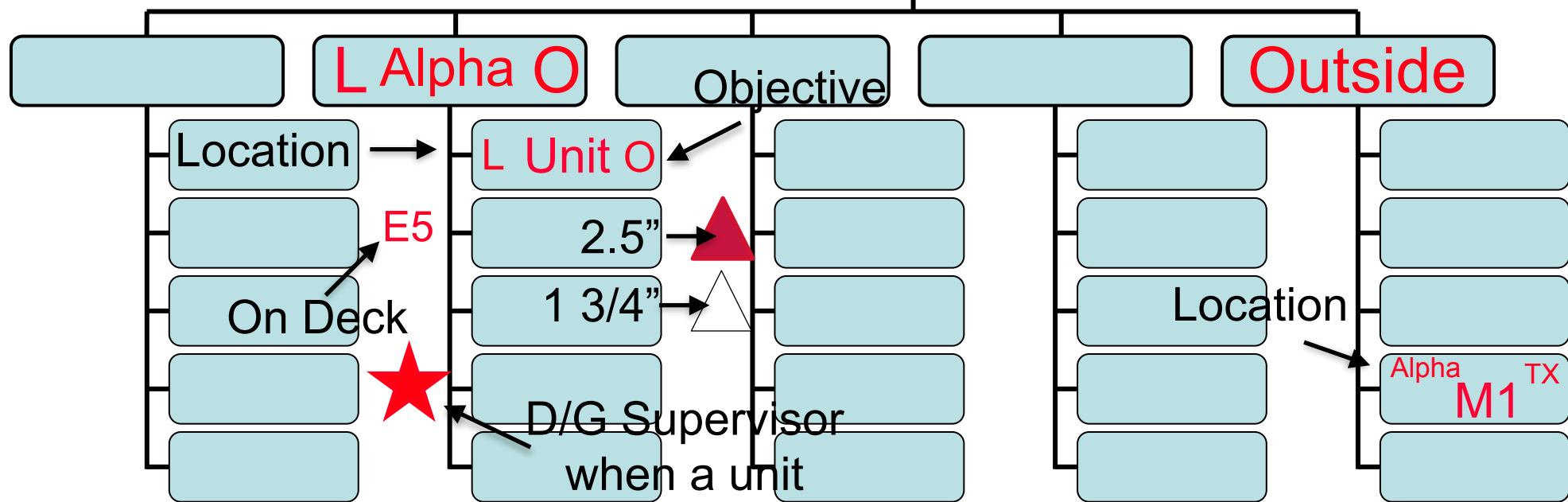

Charlie
Side / Exposures

Level 1 Recycle

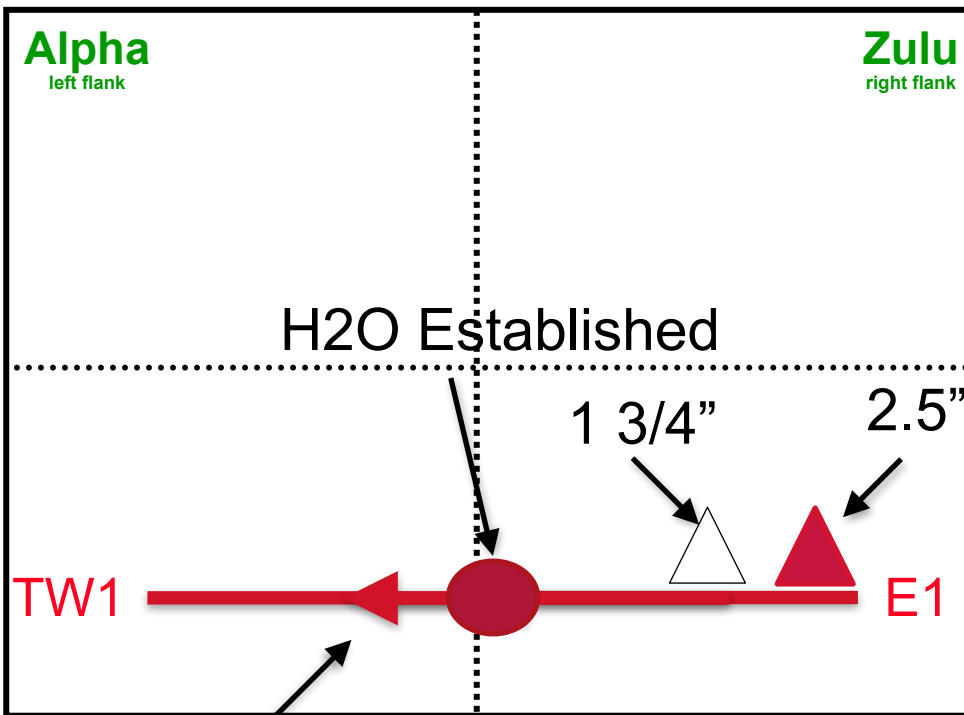

Pumping to... **Alpha**
Side / Exposures

Available	Rehab
E5	R Unit

Basement Status W/O = Walk Out

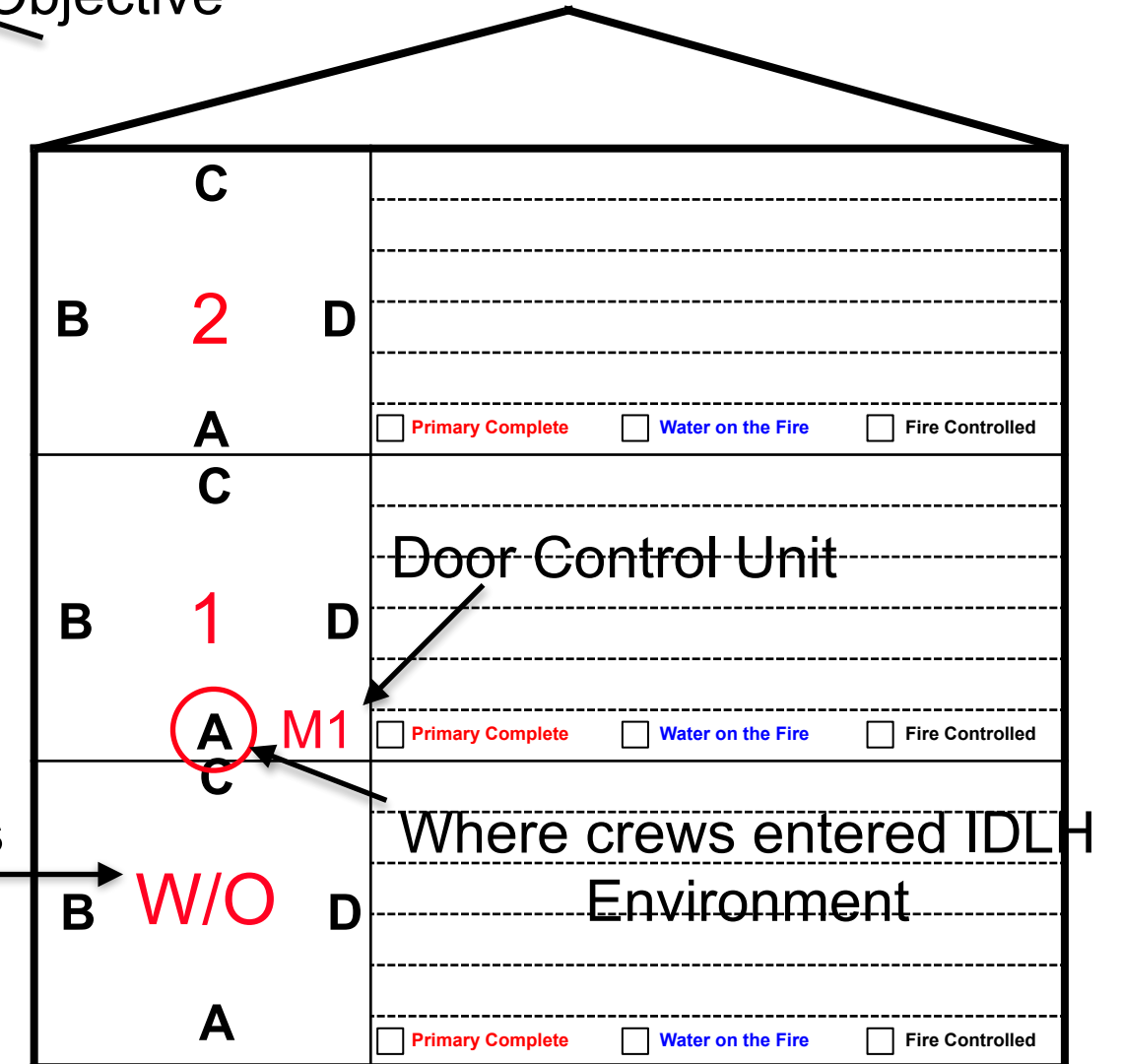

Channel/Freq.	
Command	
Logistics	14

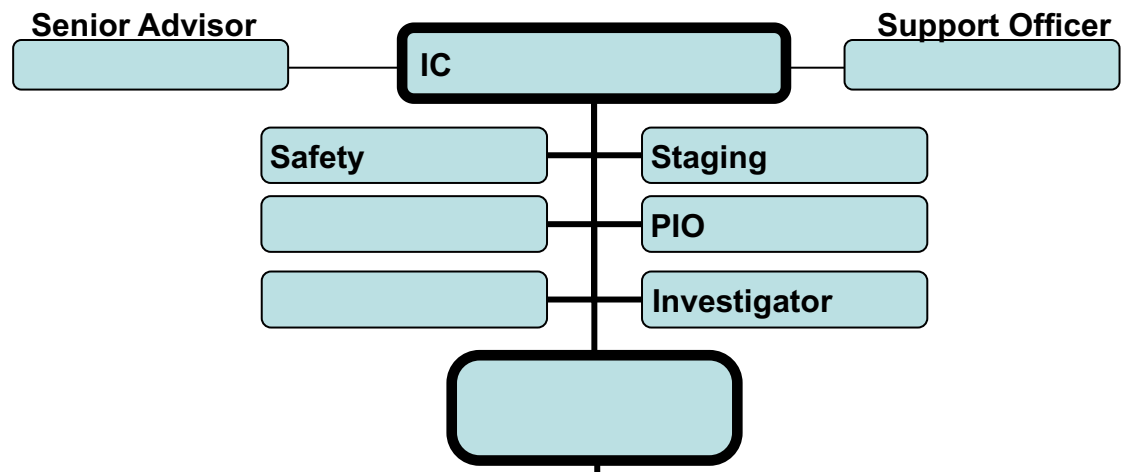

Benchmarks	
	360 Complete
	Water on The Fire
	All Clear
	Under Control
	Loss Stopped
	Customer OKAY

- UC = Under Control
- PC = Primary Complete
- RR = Roof Report
- OTF = Outside Truck Company Functions
- RIT = Rapid Intervention Team
- R = Recycle
- WO = Walk- Out
- TX = Transport Unit
- Med = Medical
- FA = Fire Attack
- FC = Fire Control
- PS = Primary Search
- DC = Door Control
- V = Ventilation
- HV = Horizontal Ventilation
- VV = Vertical Ventilation

- = 1 3/4" Hoseline
- = 2.5" Hoseline
- = Division/ Group Sup
- = Horizontal Standpipe

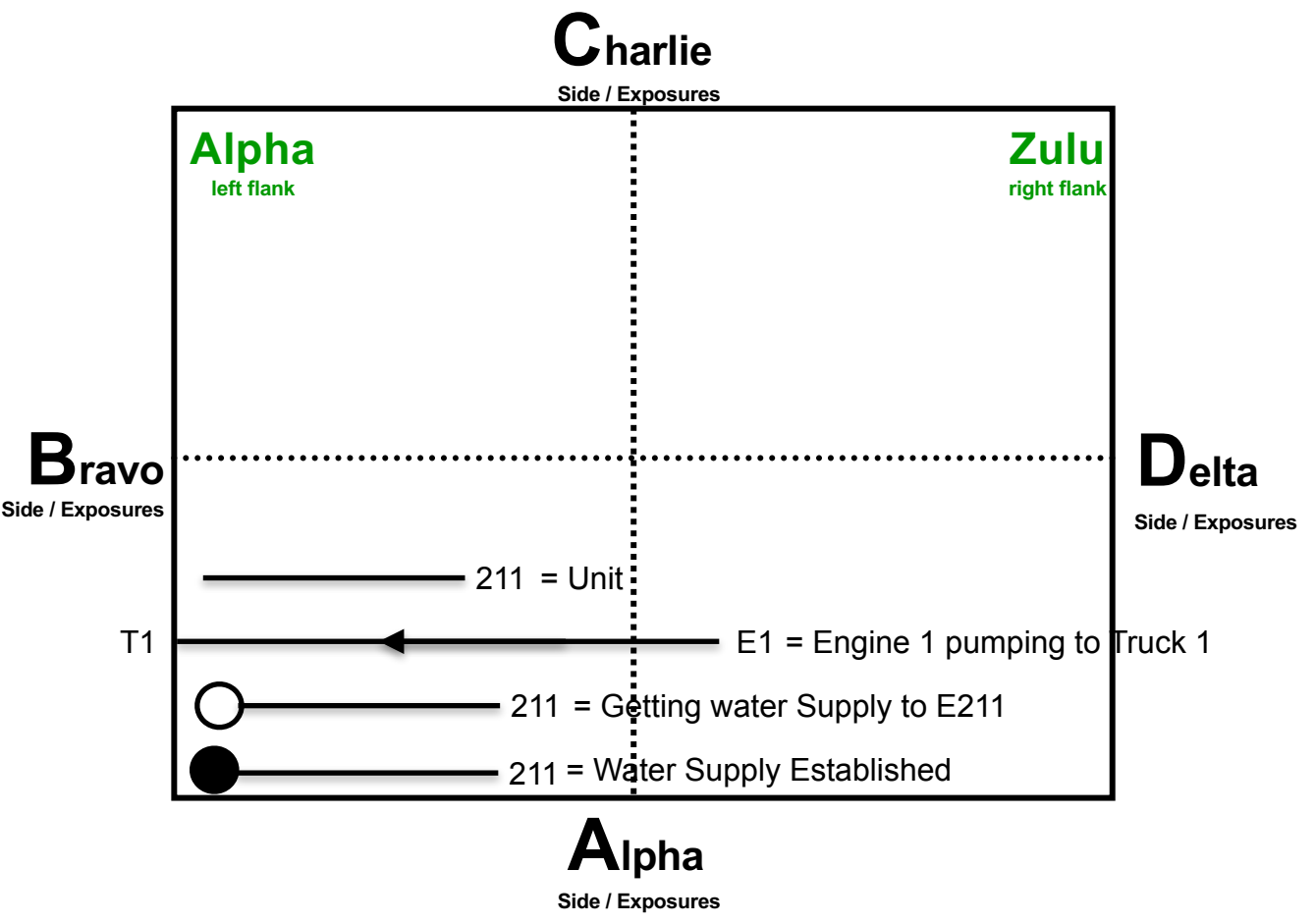
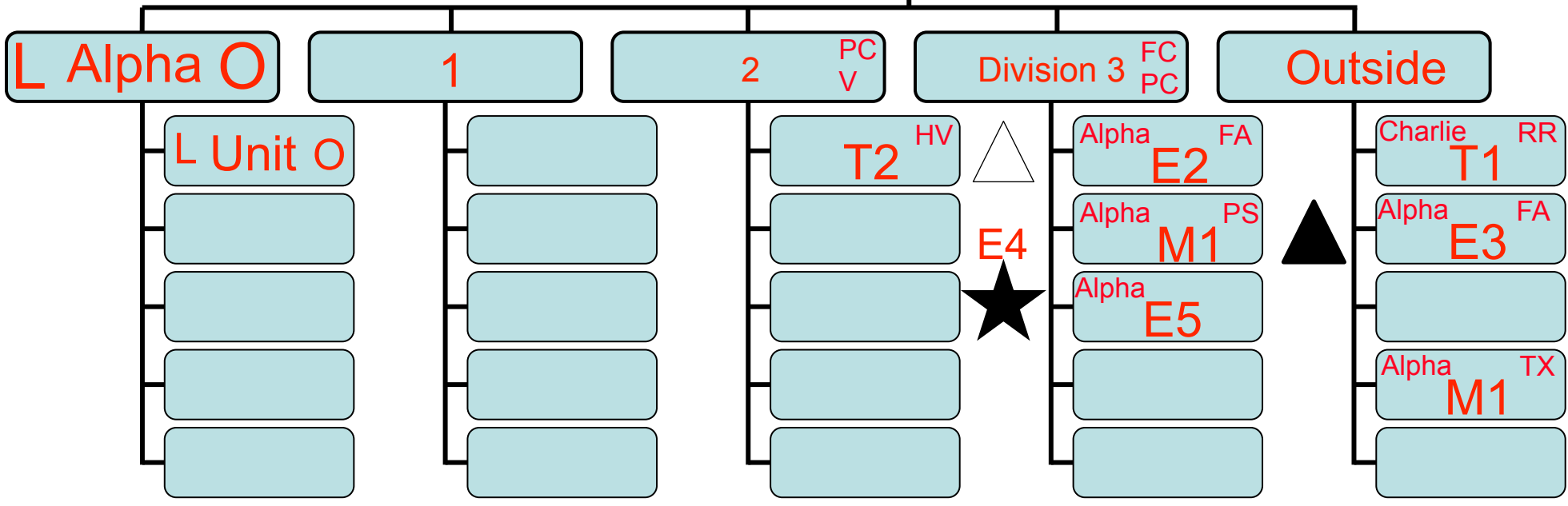

Level 1/Available		Recycle/Rehab	
	E6	R	E1

