



new products



& Bestsellers
Spring / Summer 2020



globalcatalogue.com



new products & bestsellers

*We want to make it
easy for you!*

The items in this catalogue are the perfect answer to the two questions we are most regularly asked:

What's hot and What's new?!

A comprehensive and proven best-of collection, combined with some new well-chosen additions that are sure to capture the attention of your customers. All items are in stock now, and remember that we provide a competitive and comprehensive print/engrave service that takes all stress out of the process.

Eco Pens Eco Pens are on point this year and carry a message that the world wants to hear!

The development and introduction of bamboo and wheat composite materials has the potential to reduce the amount of plastics required in the production of many products, including pens.

The building profile of these, and similar items in the market, is a win for the environment. Make sure your company is on the "write" side of history!



and more ...

globalcatalogue.com

M277 Bottle Tritan 500ml

Modern design meets practical application in this Tritan water bottle.

Made of food-grade, BPA free Tritan plastic, this bottle features a very large print area, decorated by pad print.

- Food grade BPA free tritan plastic
- Huge print area



Print Area

35 x 75mm

Packaging info

Product Dimension: ø64 x 215mm

Shipping Carton Qty: 36

Shipping Carton Size:

44 x 44 x 23cm (LxWxH)

Shipping Carton Weight (kg): 4.5

Colours

A Clear

B Grey



M276 Bottle Tritan 800ml

Modern design meets practical application in this Tritan water bottle.

Made of food-grade, BPA free Tritan plastic, this bottle features a very large print area, decorated by pad print.

- Food grade BPA free tritan plastic
- Huge print area

Print Area

35 x 75mm

Packaging info

Product Dimension: $\varnothing 69 \times 249$ mm

Shipping Carton Qty: 36

Shipping Carton Size:

44 x 44 x 26cm (LxWxH)

Shipping Carton Weight (kg): 6



Colours

A Clear

B Grey



M288 Bottle Tritan Flat-side :: 660ml

Sporting an eye-catching and intelligent design that keeps your bottle where you want it, this product sends a message equal parts style and health-conscious.

Constructed from BPA-free, food grade Tritan plastic, it is also very lightweight without sacrificing durability. With the flat portion of the bottle perfect for pad and screen printing.

- Food grade BPA free tritan plastic
- Light-weight and durable
- Huge print area!



Print Area

Pad: 40 x 60mm

Screen: 40 x 170mm (1 col only)

Packaging info

Shipping Carton Qty: 36

Shipping Carton Size:

45 x 44 x 24cm (LxWxH)

Shipping Carton Weight (kg): 3.5

Colours

A Clear

B Grey



M259 Bottle Glass 600ml



We love this product!

Glass is a natural choice for a clean, pure taste - it's easy to clean and more environmentally sound for our oceans and landfills. This fantastic, lightweight, glass bottle, with a stainless steel threaded lid, is great for the home, office, or recreational purposes. It features a protective silicone sleeved grip that will beautifully frame your client's logo. Logo is printed on the glass bottle area between the silicone grip. Sold in a retail quality gift box.

Not suitable for hot liquids.

- **Borosilicate Glass**
- Food grade glass bottle with colourful silicone sleeve
- Stainless steel threaded lid
- 600ml capacity



Print Area

Pad: 75 x 35mm

Engrave Area

Ø35mm (lid)

Packaging info

Product Dimension: Ø67 x 229mm
 Shipping Carton Qty: 36
 Shipping Carton Size:
 42 x 42 x 24.8cm (LxWxH)
 Shipping Carton Weight (kg): 14.8

Colours

- A Black
- B Blue
- D Green
- G Red
- H Blue
- J Navy



Optional Lid Colours



M282 Bottle Glass 600ml

We love this product!

Glass is a natural choice for clean, pure taste - it's easy to clean and more environmentally sound for our oceans and landfills. This fantastic, light-weight glass bottle, with a stainless steel threaded lid, is great for the home, office, or recreational purposes. Logo is printed on the glass bottle or, alternatively, the lid can be engraved.

Sold in a retail quality gift box.

Not suitable for hot liquids.

- **Borosilicate Glass**
- Food grade glass bottle with colourful stainless lid
- 600ml capacity
- Sold in a retail quality gift box



Packaging info

Product Dimension: Ø67 x 229mm
 Shipping Carton Qty: 25
 Shipping Carton Size:
 41 x 41 x 27cm (LxWxH)
 Shipping Carton Weight (kg): 10

Print Area

Pad: 75 x 35mm
 Digital: 25 x 150mm

Engrave Area

Ø35mm (lid)

Colours

- LA Blue
- LB Yellow
- LC Black
- LD Red
- LE Green
- LF Orange
- LG White
- LH Light Blue
- LI Light Green
- LJ Pink
- LK Purple
- LL Grey
- LM Navy Blue
- LX Stainless Steel



M271 Bottle Stainless 700ml

Stay hydrated with these stylish and practical stainless steel sports bottles; laser engraving beautifully (particularly the black) and looking fantastic with a full colour digital print (particularly the white).

The bottle's usability and high visibility make it a brilliant printed promotional product. Students and fitness/outdoor enthusiasts will love them but, then again, so will anyone who likes to carry a little hydration with them... which as we ALL know these days is an important key to good health.

Not microwave or dishwasher safe.

Sold in a retail quality gift box.



- Food grade #304 stainless
- Flat top lid ideal for engraving
- Not microwave or dishwasher safe



Print Area

Pad: 75 x 35mm
Screen: 100 x 190mm
Digital: 100 x 25mm

Engrave Area

100 x 25mm (bottle)
Ø30mm (lid)

Packaging info

Product Dimension: ø70 x 274mm
Shipping Carton Qty: 25
Shipping Carton Size:
40 x 40 x 28.5cm (LxWxH)
Shipping Carton Weight (kg): 7

Colours

- A Black
- B White



M272 Bottle Stainless Double Wall 500ml

These double walled, vacuum insulated, stainless steel bottles are a must for storing either hot or cold beverages; effectively keeping beverages hot for 12 hours or cold for 24 hours.

Manufactured from the highest quality #304 stainless steel with copper plated interior, they laser engrave beautifully (particularly the black) and look fantastic with a full colour digital print (particularly the white).

Please note of course that, like any metal item, they cannot be put in the microwave.

- Double wall vacuum insulated with copper plating
- Keeps liquids hot for 12 hours or cold for 24 hours
- Food grade #304 (18/8) stainless on inside / #201 stainless on outside
- Flat top lid ideal for engraving
- Not microwave or dishwasher safe

Print Area

Pad: 75 x 35mm
Digital: 100 x 25mm

Engrave Area

100 x 25mm (bottle)
Ø30mm (lid)

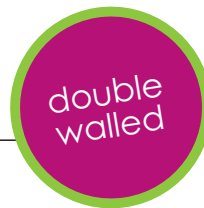

Packaging info

Product Dimension: ø70 x 274mm
Shipping Carton Qty: 25
Shipping Carton Size:
41 x 41 x 27cm (LxWxH)
Shipping Carton Weight (kg): 10

Colours

- A Black
- B White



M292 Bottle Stainless Double Wall Handle Lid 540ml



Stay hydrated with these stylish and practical stainless steel sports bottles with handy handle on the lid. They laser engrave beautifully and looking fantastic with a full colour digital print.

The bottle's usability and high visibility make it a brilliant printed promotional product. Students and fitness/outdoor enthusiasts will love them but, then again, so will anyone who likes to carry a little hydration with them... which as we ALL know these days is an important key to good health.

Not microwave or dishwasher safe.

- Food grade #304 stainless
- Flat top lid ideal for engraving
- Handle Lid

Print Area

Pad: 75 x 35mm

Engrave Area

100 x 25mm

Packaging info

Product Dimension: $\varnothing 72 \times 244$ mm
 Shipping Carton Qty: 30
 Shipping Carton Size:
 50 x 24 x 40cm (LxWxH)
 Shipping Carton Weight (kg): 9



Colours

- A White
- B Black



M286 Bottle Aluminium 700ml

Enjoy your favourite drinks on the sports field with these promo sports bottles.

Featuring a light-weight and durable aluminium construction, including a BPA free liner with colourful lid, they are an excellent place to sport your client's logo.

- Lightweight and durable
- Food grade aluminium construction
- Colourful stainless lid



Packaging info

Product Dimension: Ø66 x 217mm
 Shipping Carton Qty: 36
 Shipping Carton Size:
 41 x 41 x 24cm (LxWxH)
 Shipping Carton Weight (kg): 4.7

Print Area

Pad: 70 x 35mm
 Digital: 150 x 25mm

Engrave Area

Ø35mm (lid)
 Engrave Colour: Silver

Colours

- | | |
|------|-------------------------|
| A LA | White / Blue |
| A LB | White / Yellow |
| A LC | White / Black |
| A LD | White / Red |
| A LE | White / Green |
| A LF | White / Orange |
| A LG | White / White |
| A LH | White / Light Blue |
| A LI | White / Line Green |
| A LJ | White / Pink |
| A LK | White / Purple |
| A LL | White / Grey |
| A LM | White / Navy Blue |
| A LX | White / Stainless Steel |
| | |
| C LA | Black / Blue |
| C LB | Black / Yellow |
| C LC | Black / Black |
| C LD | Black / Red |
| C LE | Black / Green |
| C LF | Black / Orange |
| C LG | Black / White |
| C LH | Black / Light Blue |
| C LI | Black / Line Green |
| C LJ | Black / Pink |
| C LK | Black / Purple |
| C LL | Black / Grey |
| C LM | Black / Navy Blue |
| C LX | Black / Stainless Steel |



M310CA

Eco Coffee Cup Wheat
Cup2Go :: 365ml



With the disposal of environmentally harmful plastic cups in today's society, nothing reflects awareness and sustainability in a business more than promotional BPA free coffee cups.

Our new Cup2Go with Wheat Straw PP sports a stylish design with screw-top lid (with flip-top to prevent annoying splashes) and silicone band!

This promotional coffee cup is the perfect gift for the ecologically aware and practical minded customer.

- Mix 'n' match band colours
- Capacity: 356ml/12oz
- Screw-on hard plastic lid with flip-top
- Silicone band
- Material: Food grade PP with wheat straw - BPA free

Print Area

Wrap Print: 200 x 20mm / Digital Print: 25 x 20mm

Packaging info

Product Dimension: Ø90 x 115mm
Shipping Carton Qty: 84
Shipping Carton Size: 60 x 40 x 40cm (LxWxH)
Shipping Carton Weight (kg): 10

Prices include up to 5 band colours per order. For orders with more than 5 colours, please contact sales staff for details.



Band Colours



A B C D E F G H I J K L M



M254 Eco Coffee Cup Plastic Cup2Go 356ml



Sporting a stylish design with screw-top lid and silicone band, this promotional coffee cup is the perfect gift for the ecologically aware and practical minded customer.

- 356ml/12oz capacity
- "Screw-on" threaded lid
- Hard plastic lid, silicone band
- Material: Food grade PP - BPA free



Prices include up to 5 mix 'n' match colour combinations per order. For orders with more than 5 colour combinations please contact sales staff for details.

Print Area

Band (pad): 60 x 18mm
 Band (screen):
 200 x 20mm (1 col wrap only)
 Cup (pad): 25 x 20mm
 Cup (digital): 25 x 20mm

Packaging info

Product Dimension: Ø90 x 115mm
 Shipping Carton Qty: 100
 Shipping Carton Size:
 60 x 40 x 40cm (LxWxH)
 Shipping Carton Weight (kg): 10



Optional gift box available for an additional charge

Cup Colours



Band Colours



Lid Colours



M279

Eco Coffee Cup Plastic Double Wall Cup2Go Frosted 356ml



Print Area

Screen print: 200 x 80mm
Digital print: 26 x 80mm

- White cup with many lid colours to choose from
- 356ml/12oz capacity
- Screw-on threaded lid
- Material: Food grade ~~EP~~ - BPA free

Packaging info

Product Dimension: $\varnothing 90 \times 135$ mm
Shipping Carton Qty: 70
Shipping Carton Size:
59 x 42 x 32cm (LxWxH)
Shipping Carton Weight (kg): 6



Optional gift box available for an additional charge

Colours

Cup Colour: White Frosted

Lid Colours:



M280

Eco Coffee Cup Plastic Double Wall Cup2Go 356ml



wrap around printing available



mix 'n' match your business colours

Print Area

Screenprint: 200 x 80mm
Digital print: 26 x 80mm

- Many cup colours with many lid colours to choose from
- 356ml/12oz capacity
- Screw-on threaded lid
- Material: Food grade PP - BPA free

Packaging info

Product Dimension: Ø90 x 135mm
Shipping Carton Qty: 70
Shipping Carton Size: 59 x 42 x 32cm (LxWxH)
Shipping Carton Weight (kg): 6

Prices include up to 5 mix 'n' match colour combinations per order. For orders with more than 5 colour combinations please contact sales staff for details.



Optional gift box available for an additional charge

Colours

Cup Colour



Lid Colours



M264 Eco Coffee Cup Glass Cup2Go 375ml



Print Area

Band: 55 x 35mm

375ml, reusable, Glass Cup 2 Go with silicone lid and sleeve. The ergonomic silicone grip will protect your hand from the heat of the glass when it is full of coffee.

A great and eco-friendly way to enjoy your favourite cuppa.

Packaging info

Product Dimension: Ø90 x 126mm
Shipping Carton Qty: 60
Shipping Carton Size (LxWxH):
56 x 46.5 x 25cm
Shipping Carton Weight (kg): 22

- 375ml food grade glass cup
- Silicone lid and sleeve
- Not microwave safe
- Dishwasher safe (remove the silicone first)



Optional gift box available for an additional charge

Colours

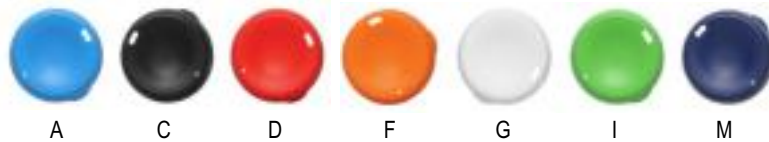

M266

Eco Coffee Cup Glass Double Wall Cup2Go 300ml



The 300ml, double-walled, Glass Cup 2 Go provides an excellent return on investment. An everyday item that has the potential to be used ALL day; in the home or office without the lid or in the car with the lid installed. And, of course, the more it is used the more visible the logo and the more effective the promotion.

Glass is becoming an increasingly popular choice because, in addition to being environmentally responsible, it also provides a clean taste and is an exceptionally hygienic material.

Logos can be printed on the silicone band.

Sold in a retail quality gift box.

Print Area

Band: 65 x 25mm

Packaging info

Product Dimension: Ø80 x 163mm (incl. lid)
Shipping Carton Qty: 12
Shipping Carton Size: 38 x 28 x 20cm (LxWxH)
Shipping Carton Weight (kg): 5



- **Borosilicate Glass**
- Double-walled design keeps hot drinks hot without burning your fingers
- Colourful lid and sleeve
- 300ml capacity
- Can be used with or without the lid in the car or in the office
- Food grade glass

Colours



M309 Eco Coffee Cup Glass Lid Double Wall Cup2Go 300ml



The 300ml, double-walled, glass Cup 2 Go provides an excellent return on investment. An everyday item that has the potential to be used ALL day; in the home or office without the glass lid or in the car with the glass lid installed. And, of course, the more it is used the more visible the logo and the more effective the promotion.

Glass is becoming an increasingly popular choice because, in addition to being environmentally responsible, it also provides a clean taste and is an exceptionally hygienic material.

Logos can be printed on the silicone band.

Sold in a retail quality gift box.

Print Area

Band: 65 x 25mm

Packaging info

Product Dimension: Ø80 x 163mm (incl. lid)
Shipping Carton Qty: 12
Shipping Carton Size: 38 x 29 x 21cm (LxWxH)
Shipping Carton Weight (kg): 4.7

- **Borosilicate Glass**
- Double walled design keeps hot drinks hot without burning your fingers
- Glass lid and colourful sleeve
- Food grade glass

Colours



M281 Eco Coffee Cup

Stainless Double Wall Cup2Go 375ml

- Mix 'n' match cups and band colours
- Screw-on hard plastic lid with flip-top
- Silicone band
- Food grade Stainless Steel
- Double wall construction
- Lid Material: PP - BPA free
- Not dishwasher or microwave safe
- Sold in a retail quality gift box

Print Area

Cup (pad): 25 x 30mm
 Band (screen): 200 x 18mm
 (1 col wrap only)

Engrave Area

Cup: 25 x 30mm

Packaging info

Product Dimension: Ø88 x 138mm
 Shipping Carton Qty: 30
 Shipping Carton Size:
 60.5 x 51 x 16.5cm (LxWxH)
 Shipping Carton Weight (kg): 8.54



Colours

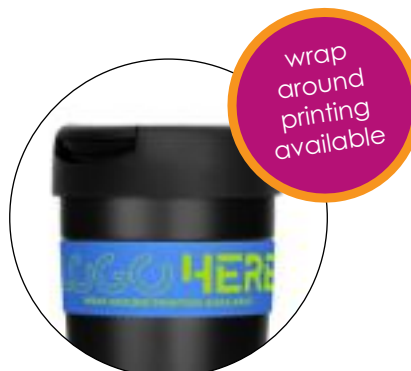

M284 Eco Coffee Cup

Stainless Double Wall Cup2Go 356ml

With the disposal of environmentally harmful plastic cups in today's society, nothing reflects awareness and sustainability in a business more than promotional stainless steel coffee cups.

Presenting, our new double walled, stainless steel Cup 2 Go which sports a stylish design with screw-top lid (with flip-top to prevent annoying splashes).

This promotional stainless coffee cup is the perfect gift for the ecologically aware and practical minded customer.

Sold in a retail quality gift box.

- Capacity: 356ml/12oz
- Screw-on hard plastic lid with lip-top
- Material: Food grade #304 stainless steel inner, #201 outer
- Not dishwasher safe
- Not microwave safe
- Sold in a retail quality gift box

Print Area

Cup (pad): 40 x 40mm

Cup (screen):

240 x 50mm (1 col wrap only)



Packaging info

Product Dimension: Ø80 x 135mm

Shipping Carton Qty: 50

Shipping Carton Size:

46 x 46 x 30cm (LxWxH)

Shipping Carton Weight (kg): 13.5

Colours

A White

C Black



L430 Sunscreen SPF 50+ Australian 35ml



Australian made protection from the Australian sun; and a great way to get your client's logo out in the light and action all year round.

- Broad spectrum - SPF 50+
- Very high protection from UVA and UVB rays
- Up to 4 hours water resistant
- Only lightly fragranced
- Moisture rich formulation contains vitamin E
- Soothes nourishes and protects
- Made in Australia

Packaging info

Product Dimension: Ø33 x 75mm
 Shipping Carton Qty: 130
 Shipping Carton Size:
 15.6 x 25.0 x 49.5cm (LxWxH)
 Shipping Carton Weight (kg): 6.60

Print Area

Pad: 30 x 40mm
 Full Colour Digital:
 25 x 40mm

Colour

White



L431 Sunscreen SPF 50+ Australian 65ml



Big opportunities of exposure for your client's logo whilst avoiding exposure to the harmful effects of the sun make this sunscreen a perfect way to promote.

- Broad spectrum - SPF 50+
- Very high protection from UVA and UVB rays
- Up to 4 hours water resistant
- Only lightly fragranced
- Moisture rich formulation contains vitamin E
- Soothes nourishes and protects
- Made in Australia

Packaging info

Product Dimension: Ø33 x 106mm
 Shipping Carton Qty: 104
 Shipping Carton Size:
 15.6 x 25.0 x 49.5cm (LxWxH)
 Shipping Carton Weight (kg): 8.60

Print Area

Pad: 30 x 50mm
 Full Colour Digital:
 25 x 50mm

Colour

White



L432 Sunscreen SPF 50+ Australian Carabiner 60ml



A convenient and practical way to have sun protection with you on all occasions - and a portable space for your client's latest promotion.

- Broad spectrum - SPF 50+
- Very high protection from UVA and UVB rays
- Up to 4 hours water resistant
- Only lightly fragranced
- Moisture rich formulation contains vitamin E
- Soothes nourishes and protects
- Made in Australia

Packaging info

Product Dimension: Ø36 x 100mm
 Shipping Carton Qty: 72
 Shipping Carton Size:
 15.6 x 25.0 x 49.5cm (LxWxH)
 Shipping Carton Weight (kg): 6.5

Print Area

Pad: 30 x 40mm
 Full Colour Digital:
 30 x 40mm

Colour

White



L433 Sunscreen SPF 50+ Australian 10ml



full colour printing available



Pocket-sized sun protection and logo promotion perfect for Australian conditions.

- Broad spectrum - SPF 50+
- Very high protection from UVA and UVB rays
- Up to 4 hours water resistant
- Only lightly fragranced
- Moisture rich formulation contains vitamin E
- Soothes nourishes and protects
- Made in Australia

Packaging info

Product Dimension: Ø16.5 x 61mm
 Shipping Carton Qty: 720
 Shipping Carton Size:
 15.6 x 25.0 x 49.5cm (LxWxH)
 Shipping Carton Weight (kg): 10.5

Print Area

Pad: 30 x 14mm
 Full Colour Digital:
 30 x 11mm

Colour

White



L464 Sunscreen SPF 50+ Australian Carabiner 50ml



All the protection of our Australian SPF50+ Sunscreen, with the convenience of a carabiner for attaching to keyring etc., and printed with your client's logo... this makes a great promotional or corporate gift.

- Broad spectrum - SPF 50+
- Very high protection from UVA and UVB rays
- Up to 4 hours water resistant
- Only lightly fragranced
- Moisture rich formulation contains vitamin E
- Soothes nourishes and protects
- Made in Australia

Packaging info

Product Dimension: 117 x 43 x 35mm
 Shipping Carton Qty: 72
 Shipping Carton Size:
 50 x 25 x 16cm (LxWxH)
 Shipping Carton Weight (kg): 5.2

Print Area

Pad: 24 x 50mm
 Full Colour Digital:
 22 x 50mm

Colour

White



L473 Sunscreen SPF 50+ Australian Carabiner 25ml



full colour printing available



All the protection of our Australian SPF50+ Sunscreen, with the convenience of a carabiner for attaching to keyring etc., and printed with your client's logo... this makes a great promotional or corporate gift.

- Broad spectrum - SPF 50+
- Very high protection from UVA and UVB rays
- Up to 4 hours water resistant
- Only lightly fragranced
- Moisture rich formulation contains vitamin E
- Soothes nourishes and protects
- Made in Australia

Packaging info

Product Dimension: 37x 100 x 28mm
 Shipping Carton Qty: 150
 Shipping Carton Size:
 50 x 25 x 16cm (LxWxH)
 Shipping Carton Weight (kg): 6.3

Print Area

Pad: 25 x 30mm
 Full Colour Digital:
 20 x 30mm

Colour

White



C478 Compendium A4 Milano Executive Tech Zipper



with zipper

Italian fabric

Elegantly finished in Italian PU and with a subtle herringbone pattern, this beautifully designed compendium includes many of the essential features required by today's business man/woman and student.

It includes a large pocket to fit most 15" laptops, Velcro adjustable tablet/phone stand, mobile phone sleeve (fits most phones) with a touch sensitive contact window, multiple card and accessory holders, pen loop, and A4 notepad.

- Italian PU
- Large pocket to fit most 15" laptops
- Velcro adjustable tablet/phone stand
- Mobile phone sleeve (fits most phones) with a personal contact window
- Multiple card and accessory holders
- Pen loop, A4 notepad

Packaging info

Product Dimension:
245 x 310 x 30mm
Shipping Carton Qty: 10
Shipping Carton Size:
41.5 x 28.5 x 36cm (LxWxH)
Carton Weight (kg): 8.4

Print Area

Full Colour Digital:
70 x 40mm

Colour

Grey



C487 Compendium A4 Roma Executive Zipper



Elegantly designed with an ultra-soft, leather-look PU finish and minimalist aesthetic, this zippered compendium features a notepad, sleeve, pen loop, and business card holders.

- Ultra soft leather-look PU
- Pen loop
- A4 Notepad
- Document sleeve
- 2x Business card holders
- Pen not included

Packaging info

Product Dimension:
255 x 328 x 25mm
Shipping Carton Qty: 20
Shipping Carton Size:
52.5 x 27 x 34.5cm (LxWxH)
Carton Weight (kg): 12

Print Area

Screen: 150 x 240mm

Full Colour Digital:
70 x 40mm

Colour

Grey



C506 Notebook Journal A5 Leather Look



- High quality PU cover
- Elastic closure
- Ribbon bookmark
- Quality, lined notebook paper - 160 pages / 80 leaves
- FSC approved

Just like your favourite coffee cup, a great journal is a joy to use over and over again.

With handy features like a pen loop, ribbon bookmark, and elastic strap closure, your client's logo will be positioned perfectly on the PU cover of this prized and practical item, to be seen and remembered daily.

The FSC certified, lined pages are abundant so to maximise your client's return on investment.

Convenient A5 size.

Packaging info

Product Dimension:
210 x 139 x 14mm
Shipping Carton Qty: 50
Shipping Carton Size (LxWxH):
44 x 39.5 x 15.5cm
Shipping Carton Weight (kg): 13.5

Print Area

Pad: 60 x 30mm

Screen:
80 x 150mm

Full Colour Digital:
60 x 40mm

Full Colour Digital:
80 x 30mm

Color

- | | |
|-------------|--------------|
| A Black | D Red |
| B White | E Green |
| C Navy Blue | F Orange |
| | G Light Blue |



C460 Notebook Journal A5 Executive



This is a luxury notebook with quality paper and a fine, soft finish to the cover - ideal for your client's corporate or other promotional gift.

Printed with your client's logo or personalisation, this is an organisational tool that is bound to impress.

PU cover can be heat-stamped, creating a darker coloured imprint.

Pen not included.

- Sophisticated hard PU cover
- Unique darker colour appears when heat stamped
- Quality, lined paper - 180 pages / 90 leaves
- Elastic closure
- Elastic pen holder
- Professional folder inside back cover
- Professional folder

Packaging info

Product Dimension:

214 x 145 x 18mm

Shipping Carton Qty: 40

Shipping Carton Size (LxWxH):

45 x 31 x 20cm

Shipping Carton Weight (kg): 13

Print Area

Pad: 60 x 30mm

Screen:

80 x 150mm

Full Colour

Digital:

60 x 40mm or

80 x 30mm

Colours

B Navy Blue

C Black



L411 Sanitiser Hand Gel Carabiner 50ml



Get your client's logo out there and keep bacteria at bay with this clear, refreshing, lemon scented 50ml gel sanitiser.

Wash your hands without water with a vitamin E and aloe vera rich formula.

Presented in a small bottle on a carabiner clip making it the perfect gift for travel promotions.

- Clear, refreshing, lightly fragranced gel sanitises skin without water
- With moisturising vitamin E and Aloe Vera
- Kills 99.9% of germs
- Perfect size for travellers

Packaging info

Product Dimension: 112 x 42mm
 Carabiner: 50mm
 Shipping Carton Qty: 100
 Shipping Carton Size:
 32.5 x 23.5 x 27.5cm (LxWxH)
 Shipping Carton Weight (kg): 8

Print Area

Pad Print: 25 x 45mm
 Full Colour Digital:
 20 x 50mm

Colour

Clear



FA110 First Aid CPR Mask Keyring



Ideal for paramedics, or indeed anyone working in a scenario where the most extreme of emergencies might occur, this CPR mask and First Aid information booklet, within a compact package that fits on a key ring, presents unique exposure for your client's promo logo.

- CPR Mask on Keyring
- Durable polyester pouch with keyring
- 1x CPR mask
- 1x First Aid information booklet



Packaging info

Product Dimension: 65 x 50 x 5mm
Shipping Carton Qty: 500
Shipping Carton Size:
50x 40 x 30cm (LxWxH)
Carton Weight (kg): 11.5

Print Area

35 x 10mm

Colour

Red

FA115B First Aid Kit 45pc



Always be prepared with this large 45 piece promotional First Aid Kit.

Multiple compartments hold a range of First Aid items and the carry case presents your client's logo with excellence.

- 45pc First Aid Kit
- Durable polyester carry bag with multiple compartments
- 10x large plasters
- 4x knuckle plasters
- 1x long adhesive strip
- 4x alcohol wipes
- 4x moist towelettes
- 20x non-woven pads (4 packs of 5)
- 2x PBT bandages
- 1x triangular bandage
- 1x CPR mask
- 2x pair latex gloves
- 6x safety pins
- 1x bandage scissors
- 1x tweezers
- 1x paper tape
- 1x emergency blanket
- 1x First Aid note pad
- 1x First Aid information booklet

large print area



Packaging info

Product Dimension: 190 x 240 x 80mm
 Shipping Carton Qty: 40
 Shipping Carton Size:
 48 x 49 x 29.5cm (LxWxH)
 Carton Weight (kg): 15.5

Print Area

120 x 50mm

Colour

Red

L478 Cheese Set 5pc



This clever cheese set gift comes with cheese knives and slicers and can be laser engraved on the wooden board with your client's logo.

Ideal for picnics or events, food lovers will appreciate this promotional gift.

- Circular cheese board
- Clever, stylish swivel lid
- 4 handy utensils



Packaging info

Product Dimension: Ø200 x 32mm

Shipping Carton Qty: 12

Shipping Carton Size:

14.5 x 11 x 21cm (LxWxH)

Shipping Carton Weight (kg): 9

Engrave Area

80 x 30mm

L469 Picnic Blanket Round ø170cm



Why a round picnic blanket..? Because round works... who sits in a square, right?

Seriously, this blanket is 170cm in diameter so there is plenty of room for the whole family.

The sturdy, faux-leather strap handle gives the blanket a luxe feel and provides for a great branding opportunity.



Packaging info

Product Dimension:
Ø170cm (blanket)
315 x 180 x 80mm (folded)
Shipping Carton Qty: 6
Shipping Carton Size:
36 x 38 x 42cm (LxWxH)
Shipping Carton Weight (kg): 6

Print Area

Handle: 60 x 30mm

Colours

Black/White



L447 Candle Soy Wax Glass



Presented in an elegant, glass pot and with a burn time of 35 hours, this soy wax candle has eco credentials (being free from palm oil).

With classic vanilla fragrance, these candles can be printed with your client's logo to create a classy promotional gift for their next corporate event.

- Classic Vanilla fragrance
- Free from palm oil
- Made from soy wax
- 220g, max burn time 35hrs

Packaging info

Product Dimension: Ø80 x 105 mm
Gift Box: 112 x 87 x 87mm
Shipping Carton Qty: 24
Shipping Carton Size:
36 x 27 x 25cm (LxWxH)
Shipping Carton Weight (kg): 16.6

Print Area

35 x 35mm

Colour

- A Black
- B White



SH100 Marker Permanent Sharpie Fine



Your customers can now make their mark permanently with this co-branding opportunity on the world's #1-selling marker - the Sharpie Fine Point.

The fine point has permanent, fast-drying, acid-free, non-toxic ink that is ACMI certified. Instantly recognisable, these iconic markers are well loved around the world and always praised for their quality.

The perfect co-branding opportunity - collaborate and elevate!

- Permanent on most hard-to-mark surfaces
- Quick-drying, AP Certified, non-toxic ink formula
- Line width - 1mm



Packaging info

Shipping Carton Qty: 144
Shipping Carton Size:
30.48 x 18.72 x 9.98cm (LxWxH)
Carton Weight (kg): 1.74

Print Area

Pad Print (cap): 35 x 7mm

Colours



A Black

B Blue

C Red

SH300 Marker Permanent Sharpie Super



Your customers can now make their mark permanently with this co-branding opportunity on the world's #1-selling marker - the Sharpie Super Permanent Marker.

The fine point has permanent, fast-drying, acid-free, non-toxic ink that is ACMI certified; and with a super-large ink supply, you can express yourself to your heart's content. Instantly recognizable, these iconic markers are well loved around the world and always praised for their quality.

The perfect co-branding opportunity - collaborate and elevate!

- Permanent on most hard-to-mark surfaces
- Quick-drying, AP Certified, non-toxic ink formula
- Line width - 1.5mm



Packaging info

Shipping Carton Qty: 144
Shipping Carton Size:
30.48 x 18.72 x 9.98cm (LxWxH)
Carton Weight (kg): 1.74

Print Area

Pad Print (cap): 35 x 7mm

Colours



A104 Plastic Pen Ballpoint Colours Minimalist



The Minimalist Ballpoint Pen offers stylish simplicity to enhance your client's promotion.

The twist action, retractable ballpoint with black ink provides comfort and reliability to go with your client's printed logo.

Parker type refill - German ink - 4,000m

- Twist Action
- Retractable ballpoint
- Black ink



Packaging info

Shipping Carton Qty: 1,000
Shipping Carton Size: 48 x 20 x 31cm
(LxWxH)
Carton Weight (kg): 11

Print Area

Screen Print (barrel): 50 x 30mm
Pad Print (barrel): 40 x 7mm
Pad Print (clip): 43 x 6mm

Colours



Z245 Plastic Pen Ballpoint Karl



Complement your client's event or promotion with the simple, yet elegant, Karl Ballpoint Pen.

With twist action, retractable ballpoint and black ink, this pen can be pad printed to clip, cap, and barrel for a variety of branding options for your client's logo.

Slim type refill - German ink - 1,200m.

- Twist action
- Retractable ballpoint
- Black ink



Packaging info

Shipping Carton Qty: 1,000
Shipping Carton Size:
53 x 31 x 22cm (LxWxH)
Carton Weight (kg): 15

Colours



Print Area

Pad Print (clip): 30 x 7mm
Pad Print (cap): 35 x 7mm
Pad Print (barrel): 50 x 6mm

Z412 Plastic Pen Ballpoint Solid Colours Michaela



Enhance your client's next promotion with the Michaela Plastic Solid Colours Ballpoint Pen.

Sleek lines and silver detail makes this an ideal pen for the tech savvy promotion.

Minimalist contemporary design - 14g barrel. Parker type refill - German ink - 4,000m.

- Push Button
- Retractable ballpoint
- Black ink



Packaging info

Shipping Carton Qty: 1,000
Shipping Carton Size: 40 x 31 x 17cm
(LxWxH)
Carton Weight (kg): 8.5

Colours



Print Area

Pad Print (barrel): 55 x 7mm

Z427

Eco Pen Ballpoint Recycled Paper Sage



Synonymise your client's brand with eco-awareness using the Sage Paper Ballpoint Pen. Clip and tip available in a range of colorways.

Suitable for pad print, full colour digital print, and rotary screen print.

- Click action
- Retractable ballpoint
- Black ink



Packaging info

Shipping Carton Qty: 1,000
Shipping Carton Size:
45 x 31.5 x 17cm (LxWxH)
Carton Weight (kg): 9

Print Area

Pad Print: 50 x 7mm
Wrap Print: 45 x 20mm

Colours

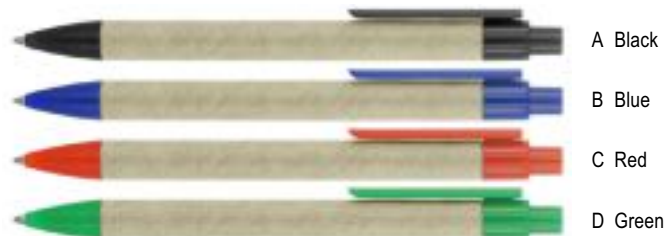

Z428 Eco Pen Ballpoint Paper Wheat Jade



Answer the call for eco-friendly design with the Jade Paper/Wheat Ballpoint Pen.

Made from paper and wheat, this pen leaves a strong impression of eco-awareness, and a tiny footprint.

Available with pad print, full colour digital print, and rotary screen print.

- Click action
- Retractable ballpoint
- Black ink



Packaging info

Shipping Carton Qty: 1,000
Shipping Carton Size:
45 x 31.5 x 17cm (LxWxH)
Carton Weight (kg): 9

Colours



Recycled Paper

Print Area

Pad Print: 50 x 7mm
Wrap Print: 45 x 20mm

Z439 Plastic Pen Ballpoint Transparent EU Cara



With push button, retractable ballpoint, the EU Cara Transparent Ballpoint Pen is a classic and stylish quality option for your client's next promotion. The plastic barrel can be pad printed with logo branding to create a classy corporate gift.

Plastic Parker type refill - German ink - 1,000m

- Push button
- Retractable ballpoint
- Black ink

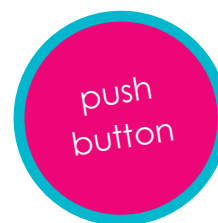

Packaging info

Shipping Carton Qty: 1,000
Shipping Carton Size:
50 x 31 x 20cm (LxWxH)
Carton Weight (kg): 13

Colours



Print Area

50 x 7mm

Z445 Plastic Pen Ballpoint Coloured Accent Uno



Emanating an image of resilience, the Uno High Gloss Ballpoint Pen evokes notions of quiet confidence; with an accented tip that also blends sophistication. Available in gloss white with coloured accent and suitable for pad print, full colour digital print, and rotary screen print.

Click action, retractable ballpoint - black ink
Refill: X-20 type TC Ball German Black Ink 1200m



Packaging info

Shipping Carton Qty: 1000
Shipping Carton Length (cm): 45.00
Shipping Carton Width (cm): 31.00
Shipping Carton Height (cm): 20.00
Shipping Carton Weight (kg): 8.50

Print Areas

Pad Print: Barrel 55 x 7mm - Clip 40 x 6mm

Full Colour Digital Print:
Barrel 55 x 7mm - Clip 40 x 6mm

Screen Print: Lower Barrel 50 x 20mm

Colours



Z450 Eco Pen Ballpoint Recycled PET



A great choice for promotions when wanting to emphasise eco credentials, the Eco Pen Ballpoint is made from Recycled PET.

With a simple, sharp, modern profile and push button, retractable ballpoint, this ideal gift pen can be pad or full colour digital printed with your client's logo in up to two positions on the barrel, giving them a variety of branding options.

- Made from recycled PET bottles
- Click action
- Retractable ballpoint
- Black ink



Packaging info

Shipping Carton Qty: 1000
Shipping Carton Size:
42.5 x 32 x 20cm (LxWxH)
Carton Weight (kg): 12

Colours



Print Area

Pad Print: 50mm x 7mm
Full Colour Digital Print: 50mm x 6mm

Z774 Eco Pen Ballpoint Wheat Cara

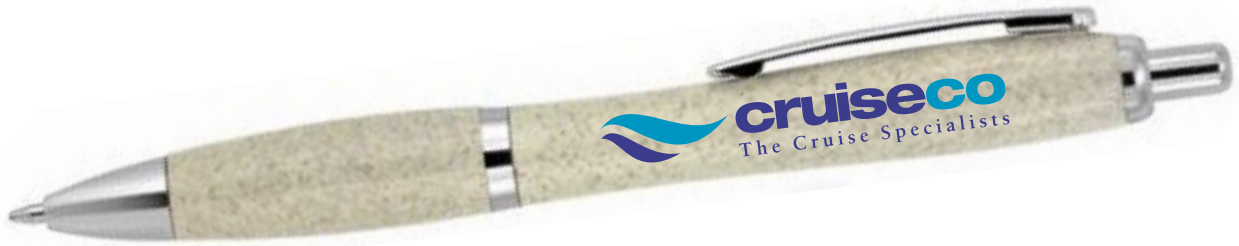

Demonstrate a pragmatic approach to the needs of the future with the Cara Wheat Ballpoint Pen. Constructed with eco-friendly wheat.

Available with pad print, full colour digital print, and rotary screen print.

- Click action
- Retractable ballpoint
- Black ink



Packaging info

Shipping Carton Qty: 1,000
Shipping Carton Size:
50 x 31 x 20cm (LxWxH)
Carton Weight (kg): 11

Colours



Wheat Straw CT

Print Area

Print: 50 x 7mm

Z634 Plastic Pen Ballpoint Alida



The Alida Ballpoint Pen features a push button, revealing a black ink Slim type refill - German ink - 1,200m.

Printed with a company logo, this stylish promotional pen is an excellent branded gift idea for a corporate campaign.

- Push button
- Retractable ballpoint
- Black ink

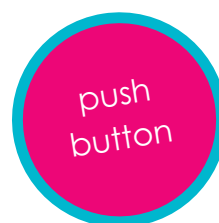

Packaging info

Shipping Carton Qty: 1,000
Shipping Carton Size:
53 x 31 x 22cm (LxWxH)
Carton Weight (kg): 15

Print Area

50 x 7mm

Colours



Z848 Plastic Pen Ballpoint Lenny



The Lenny Ballpoint pen has a surprise maze game inside the barrel and a craze game going on on the outside with the styling.

Black ballpoint with cap from a quality Slim type refill - German ink - 1,200m.

Pad or screen printed with your client's promotional logo on the barrel, this pen will amuse and impress as a branded gift.

- Ballpoint with cap,
- Maze game inside barrel
- Black ink



Packaging info

Shipping Carton Qty: 1,000
Shipping Carton Size:
53 x 31 x 22cm (LxWxH)
Carton Weight (kg): 15

Print Area

Pad Print (barrel): 50 x 8mm
Screen Print (barrel): 50 x 25mm

Colours



A Blue

B Pink

C Green

D Yellow

F Light Blue

Z855 Plastic Pen Ballpoint Odette



The Odette Ballpoint Pen is a retro classic, featuring 4 push button, retractable ballpoints in one 80's nostalgia trip of a barrel.

Ink colours are black, blue, red and green from quality Slim type refills - German ink - 1,000m.

Promotional pens rarely come at better value when printed with your client's logo or brand as a corporate gift.

- Push button
- Retractable, 4 colour ballpoint
- Black, blue, red and green ink



Packaging info

Shipping Carton Qty: 1,000
Shipping Carton Size:
53 x 31 x 22cm (LxWxH)
Carton Weight (kg): 15

Colours



A White / Black

B White / Blue

Print Area

Pad Print (barrel): 50 x 8mm

Z895 Plastic Pen Ballpoint Gloss Colours Tia



Tia Ballpoint Pen is a retro styled classic with a push button, retractable black ballpoint.

The barrel can be screen or pad printed with your client's promotional logo or personalisation for a professional gift idea.

Slim type refill - German ink - 1,000m.

- Push button
- Retractable ballpoint
- Black ink

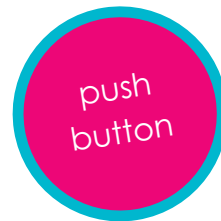

Packaging info

Shipping Carton Qty: 1,000
Shipping Carton Size:
53 x 31 x 22cm (LxWxH)
Carton Weight (kg): 15

Print Area

Pad Print: 50 x 5mm
Screen Print (barrel): 50 x 25mm

Colours



Z550 Metal Pen Ballpoint Executive Julia



The Julia Metallic colour and Solid colour Ballpoint Pens present a sharp, corporate style with smooth, straight lines.

A click action, retractable ballpoint delivers black ink from a smooth, quality Parker type refill - German ink - 4,000m.

This metal promotional pen can be printed with your client's logo or brand to create a fine gift or, alternatively, laser engraved with a white finish for an even classier result. See Z551 for matching mechanical pencil and Z251 for matching plastic pen.

18g metal barrel.

- Click action
- Retractable ballpoint
- Black ink



Packaging info

Shipping Carton Qty: 500
Shipping Carton Size:
33.5 x 17.5 x 33.5cm (LxWxH)
Carton Weight (kg): 18.7

Colours

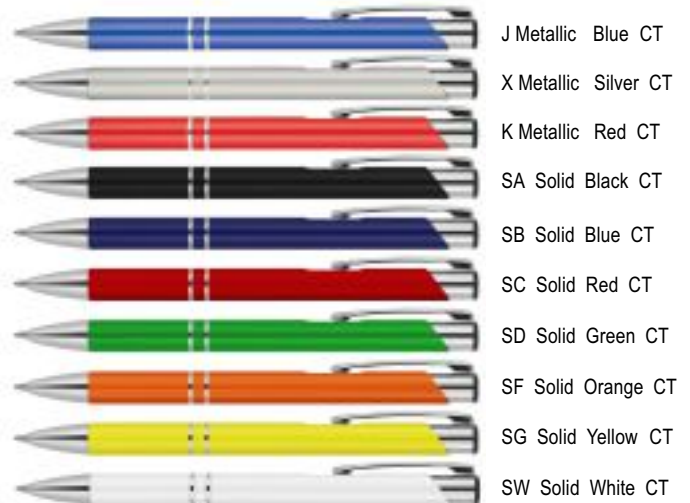

Print Area

Pad Print (barrel): 50 x 7mm

Engrave Area

Engrave (barrel): 50 x 7mm
Engrave Color: White

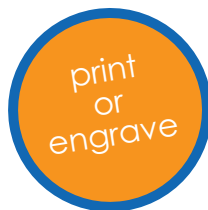

Z554 Metal Pen Ballpoint Executive Matte Julia



The Julia Matte Metal Ballpoint Pen presents a sharp, corporate style with smooth, straight lines.

A push action, retractable ballpoint delivers black ink from a smooth, quality Parker type refill - German ink - 4,000m.

This metal promotional pen can be printed with your client's logo or brand to create a fine gift or, alternatively, laser engraved with a white finish for an even classier result.

18g metal barrel.

- Push button
- Retractable ballpoint
- Black ink

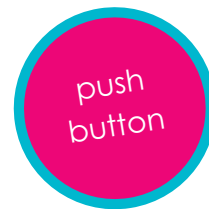

Packaging info

Shipping Carton Qty: 500
Shipping Carton Size: 33.5 x 17.5 x 33.5cm
(LxWxH)
Carton Weight (kg): 18.7

Colours



A Black

V Grey

Print Area

Pad Print (barrel): 50 x 7mm

Engrave Area

Engrave (barrel): 50 x 7mm
Engrave Color: White

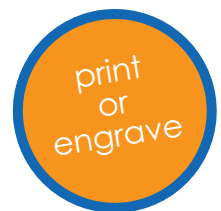

Z726 Metal Pen Ballpoint Executive Matte Alexander



The Alexander Matte Metal Ballpoint Pen, with chrome trim, adds a touch of style and elegance to boost your client's promotional campaign.

Equipped with push button, retractable function and a Parker type refill - German ink - 4,000m.

- Push button
- Retractable ballpoint
- Black ink

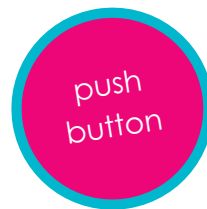
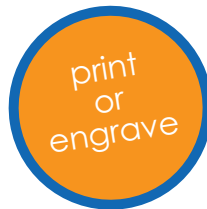

Packaging info

Shipping Carton Qty: 500
Shipping Carton Size: 90 x 23 x 23.5cm
(LxWxH)
Carton Weight (kg): 10.4

Print Area

Pad Print (barrel): 55 x 7mm

Engrave Area

Engrave (barrel): 55 x 7mm
Engrave Color: White

Colours



Z773 Eco Pen Ballpoint Wheat Julia



Sporting a wheat and chrome construction, the Julia Wheat Ballpoint Pen sports an eco-conscious look without sacrificing on style.

- Click action
- Retractable ballpoint
- Black ink



Packaging info

Shipping Carton Qty: 1,000
Shipping Carton Size:
47.5 x 31 x 20cm (LxWxH)
Carton Weight (kg): 10.5

Colours



Wheat Straw CT

Print Area

Print: 50 x 7mm

Z776 Metal Pen Ballpoint Executive EU Julia



Don't sacrifice good design for affordability. Enjoy both with the Julia EU Metal Ballpoint Pen, whose sleek metal construction allows for sharp looks at little expense.

Available in a range of colourways. Can be pad printed, full colour digital printed, and engraved.

- Click action
- Retractable ballpoint
- Black ink



Packaging info

Shipping Carton Qty: 500
Shipping Carton Size:
30 x 35 x 53cm (LxWxH)
Carton Weight (kg): 7

Print Area

Pad (barrel): 50 x 7mm

Endrave Area

(barrel): 50 x 7mm
Engrave colour: White

Colours

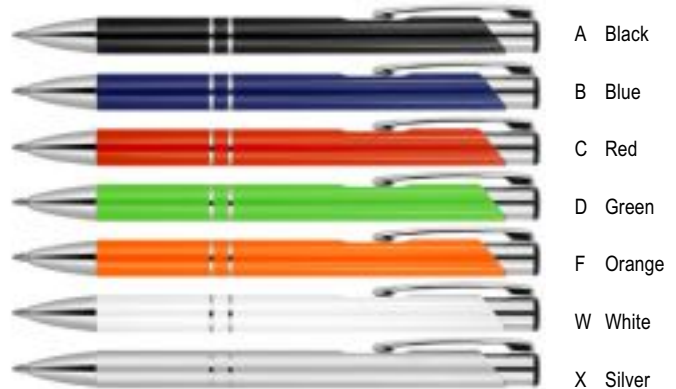

Z777

Metal Pen Ballpoint Executive EU Black Trim Julia



Don't sacrifice good design for affordability. Enjoy both with the Julia EU Black Trim Metal Ballpoint Pen, whose sleek metal construction allows for sharp looks at little expense. Available in a range of colourways. Can be pad printed, full colour digital printed, and engraved.

- Click action
- Retractable ballpoint
- Black ink



Packaging info

Shipping Carton Qty: 500
Shipping Carton Size:
53 x 29 x 23.5cm (LxWxH)
Carton Weight (kg): 17

Print Area

Pad Print: 50 x 6mm

Engrave Area

(barrel): 50 x 6mm
Engrave Colour: White

Colours



Z760 Metal Pen Ballpoint Prestige Chrome Trim Hubert



Parker type refill - German ink - 3,000m.
Mirror chrome engrave.

- Twist Action
- Retractable ballpoint
- Black ink

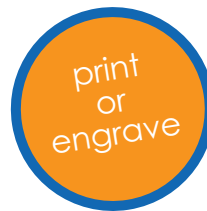

Packaging info

Shipping Carton Qty: 500
Shipping Carton Size: 45 x 44 x 20cm
(LxWxH)
Carton Weight (kg): 14

Colours



Print Area

Pad Print (barrel): 45 x 7mm

Engrave Area

Engrave (barrel): 45 x 7mm

Z763 Metal Pen Ballpoint Prestige Gold Trim Julia



The Julia Gold Trim Metal Ballpoint Pen presents a sharp, corporate style with smooth, straight lines.

A push action, retractable ballpoint delivers black ink from a smooth, quality Parker type refill - 4,000m.

This metal promotional pen can be printed with your client's logo or brand to create a fine gift or, alternatively, laser engraved with a mirror gold finish for an even classier result.

18g metal barrel.

- Push Button
- Retractable ballpoint
- Black ink

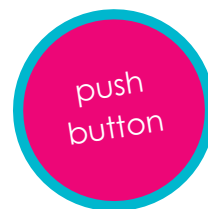
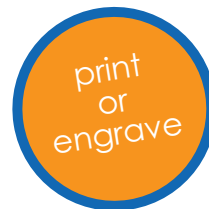

Packaging info

Shipping Carton Qty: 500

Shipping Carton Size: 53 x 39.5 x 23.5cm
(LxWxH)

Carton Weight (kg): 11

Colours



A Black GT

Print Area

Pad Print (barrel): 50 x 7mm

Engrave Area

Engrave (barrel): 50 x 7mm
Engrave Colour: Mirror Gold

AM018 Metal Pen Ballpoint

PenlineSwiss Commander Carbon Fibre



Impress your market with the PenlineSwiss genuine carbon fibre Commander Metal Ballpoint Pen.

PenlineSwiss refill made in Switzerland - 5,900m.

Chrome trim and a twist action, retractable ballpoint complement your client's printed or engraved promotional logo.

- Genuine Carbon Fibre/Metal barrel
- Twist Action Retractable ballpoint
- Black ink

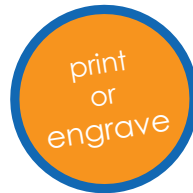

Packaging info

Shipping Carton Qty: 500
Shipping Carton Size:
33.5 x 17.5 x 33.5cm (LxWxH)
Carton Weight (kg): 18.7

Colours



Black CT

Print Area

Pad Print (cap): 40 x 7mm

Engrave Area

Engrave (cap): 40 x 7mm
Engrave finish: Chrome

AM023 Metal Pen Ballpoint PenlineSwiss Wistler



Sleek and stylish stainless steel finish with a twist action, retractable ballpoint with black ink characterise the Wistler Metal Ballpoint Pen.

Printed or engraved (silver finish) with your client's logo on the cap, this PenlineSwiss promotional metal barrelled pen boasts a soft ink PenlineSwiss refill made in Switzerland - 5,900m.

- Twist Action
- Retractable ballpoint
- Black ink

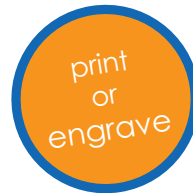

Packaging info

Shipping Carton Qty: 500
Shipping Carton Size:
33.5 x 17.5 x 33.5cm (LxWxH)
Carton Weight (kg): 18.7

Colours



Stainless CT

Print Area

Pad Print (cap): 35 x 8mm

Engrave Area

Engrave (cap): 35 x 8mm
Engrave Colour: Silver

DER101 Metal Pen Ballpoint Derofe Stripe Black

DEROFE



Derofe Fine Writing Instruments presents the Stripe Black Ballpoint Pen in an elegant black gift box.

Laser engraved (mirror chrome finish) or pad printed with your client's promotional logo on the upper barrel, this exceptional pen is the epitome of integrity and quality.

Professionally equipped with Derofe Swiss metal refill (1.0mm nib and 9,300m capacity) and with spare refill included, this durable, black metal pen with chrome trim boasts a twist action, retractable ballpoint delivering black ink.

*Pricing includes a 1 position laser engraved logo on the upper barrel. Setup and freight charges apply.

- Twist Action
- Retractable ballpoint
- Black ink



Packaging info

Shipping Carton Qty: 500
Shipping Carton Size: 33.5 x 17.5 x 33.5cm
(LxWxH)
Carton Weight (kg): 18.5

Colours



Engrave Area

Engrave (upper barrel): 40 x 7mm
Engrave Colour: Mirror finish



DER103 Metal Pen Ballpoint Derofe Banker

DEROFE



Derofe Fine Writing Instruments have been delivering the best in pens since 1947, and the Banker Ballpoint Pen continues the tradition in fine style.

With twist action, retractable ballpoint and black ink, this precision pen is immaculately presented in an elegant black giftbox. Refills have 1.0mm nibs and 9,300m capacity.

This black, quality pen has a chrome trim and can be printed or laser engraved (mirror chrome finish) with your client's promotional logo on the upper barrel and will satisfy those with a passion for writing.

*Pricing includes a 1 position laser engraved logo on the upper barrel. Setup and freight charges apply.

- Twist Action
- Retractable ballpoint
- Black ink



Packaging info

Shipping Carton Qty: 500
Shipping Carton Size: 33.5 x 17.5 x 33.5cm
(LxWxH)
Carton Weight (kg): 18.5

Colours



Engrave Area

Engrave (upper barrel): 40 x 8mm
Engrave Colour: Mirror finish





IM

Metal Pen Ballpoint Parker IM - Brushed Stainless GT
MADE IN FRANCE
1975642



Packaging info

Shipping Carton Qty: 100
Shipping Carton Size:
61.6 x 38.2 x 23.2cm (LxWxH)
Carton Weight (kg): 17

Print Area

Pad Print: 40 x 7mm

Engrave Area

Engrave: 40 x 7mm
Engrave Color: Champagne



Jotter

Metal Pen Ballpoint Parker Jotter - Brushed Stainless CT

MADE IN FRANCE

1953344

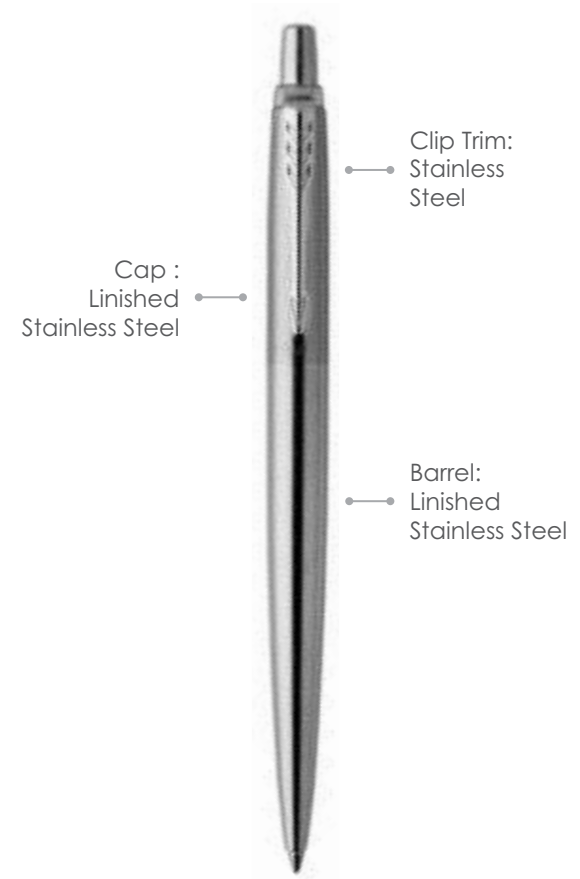

Packaging info

Shipping Carton Qty: 300
Shipping Carton Size:
60.1 x 37.2 x 27.6cm (LxWxH)
Carton Weight (kg): 18.1

Print Area

Pad Print: 40 x 7mm

Engrave Area

Engrave: 40 x 7mm
Engrave Color: Silver



Jotter

Metal Pen Ballpoint Parker Jotter - Brushed Stainless GT

MADE IN FRANCE

S30000073



Packaging info

Shipping Carton Qty: 300
Shipping Carton Size:
60.1 x 37.2 x 27.6cm (LxWxH)
Carton Weight (kg): 18.1

Print Area

Pad Print: 40 x 7mm

Engrave Area

Engrave: 40 x 7mm
Engrave Color: Silver



Jotter XL

Metal Pen Ballpoint Parker Jotter XL - Matte Black CT

MADE IN FRANCE

2068512



Clip Trim:
Stainless Steel

Barrel:
Linished
Stainless Steel

Barrel:
Linished and
Varnished
Stainless Steel

Packaging info

Shipping Carton Qty: 100
Shipping Carton Size:
60.1 x 38.2 x 23.2cm (LxWxH)
Carton Weight (kg): 18.1

Print Area

Pad Print: 40 x 7mm

Engrave Area

Engrave: 40 x 7mm
Engrave Color: Silver



Jotter XL

Metal Pen Ballpoint Parker Jotter XL - Matte Blue CT

MADE IN FRANCE

2068513



Packaging info

Shipping Carton Qty: 100
Shipping Carton Size:
60.1 x 38.2 x 23.2cm (LxWxH)
Carton Weight (kg): 18.1

Print Area

Pad Print: 40 x 7mm

Engrave Area

Engrave: 40 x 7mm
Engrave Color: Silver



Jotter XL

Metal Pen Ballpoint Parker Jotter XL - Matte Grey CT

MADE IN FRANCE

2068514



Clip Trim:
Stainless Steel

Barrel:
Linished
Stainless Steel

Barrel:
Linished and
Varnished
Stainless Steel

Packaging info

Shipping Carton Qty: 100
Shipping Carton Size:
60.1 x 38.2 x 23.2cm (LxWxH)
Carton Weight (kg): 18.1

Print Area

Pad Print: 40 x 7mm

Engrave Area

Engrave: 40 x 7mm
Engrave Color: Silver



Jotter XL

Metal Pen Ballpoint Parker Jotter XL - Matte Green CT

MADE IN FRANCE

2068515



Packaging info

Shipping Carton Qty: 100
Shipping Carton Size:
60.1 x 38.2 x 23.2cm (LxWxH)
Carton Weight (kg): 18.1

Print Area

Pad Print: 40 x 7mm

Engrave Area

Engrave: 40 x 7mm
Engrave Color: Silver



Sonnet

Metal Pen Ballpoint Parker Sonnet - Lacquer Black GT

MADE IN FRANCE

1950784



Packaging info

Shipping Carton Qty: 80
Shipping Carton Size:
41.5 x 37.8 x 29.5cm (LxWxH)
Carton Weight (kg): 17

Print Area

Pad Print: 40 x 7mm

Engrave Area

Engrave: 40 x 7mm
Engrave Color: Gold

WATERMAN
PARIS

Hemisphere

Metal Pen Ballpoint Waterman Hemisphere - Brushed Stainless CT

MADE IN FRANCE

S20102007



Packaging info

Shipping Carton Qty: 100
Shipping Carton Size:
41 x 38 x 38cm (LxWxH)
Carton Weight (kg): 18.5

Print Area

Pad Print: 40 x 7mm

Engrave Area

Engrave: 40 x 7mm
Engrave Color: Silver

WATERMAN
PARIS

Hemisphere

Metal Pen Ballpoint Waterman Hemisphere - Brushed Stainless GT

MADE IN FRANCE

S20102003



Packaging info

Shipping Carton Qty: 100
Shipping Carton Size:
41 x 38 x 38cm (LxWxH)
Carton Weight (kg): 18.5

Print Area

Pad Print: 40 x 7mm

Engrave Area

Engrave: 40 x 7mm
Engrave Color: Silver

WATERMAN
PARIS

Expert

Metal Pen Ballpoint Waterman Expert - Brushed Stainless GT
MADE IN FRANCE
AP013561



Packaging info

Shipping Carton Qty: 100
Shipping Carton Size:
41 x 38 x 38cm (LxWxH)
Carton Weight (kg): 18.5

Print Area

Pad Print: 40 x 7mm

Engrave Area

Engrave: 40 x 7mm
Engrave Color: Silver



