

DURAT®

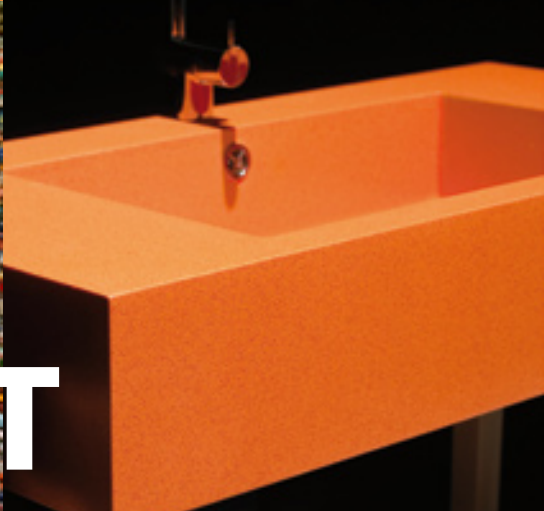





CYCLED TO LAST

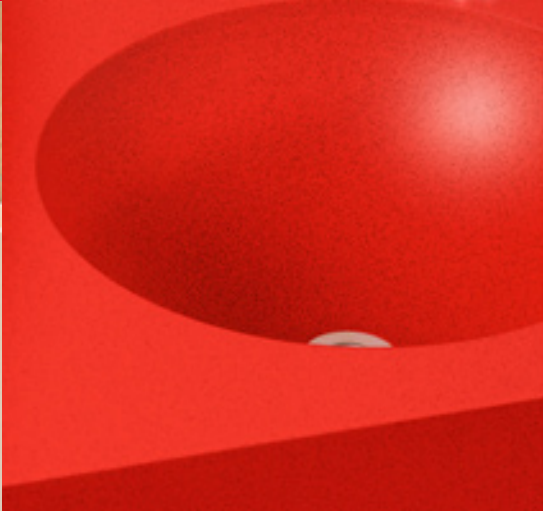



DURAT – RECYCLED TO LAST

Durat is a unique, ecological solid surface material which contains recycled post-industrial plastics and is 100% recyclable.

Durat is available in around 70 vibrant colors. Custom colors can be tinted to order. Durat can be used to create seamless surfaces of any custom project.

Easy maintenance and hard-wearing properties make it an ideal material for various kinds of interiors, such as bathrooms, kitchens and public spaces.

Durat offers also a wide range of exclusive design products ranging from bath tubs, sinks and shower trays to stools and tables.



ENVIRONMENT

Durat collects post-industrial plastic waste that would normally end up in wastelands. This is very concrete and substantial way Durat decreases the stress on nature. The handling and transportation of the recycled material is fully the responsibility of Durat.

The fact that Durat is 100% recyclable is another concrete ecological point – this means that we do not need to waste Durat pieces generated in production – we can re-use them and are able to offer our clients the possibility to reclaim the material. In a world of increasing waste handling costs and eco-awareness this is a highly important possibility.

The long-lasting quality and reparability also make Durat a more sustainable product.



THE MATERIAL

DURAT is an excellent material for surfaces of different kinds. It is a natural choice in places like restaurants, cafes, shops, hospitals, boats and ships, bathrooms and kitchens.

Durat is a polyester based solid surface material which contains about 30% of recycled material and is 100% recyclable. The recycled post-industrial waste is granulated into small speckles giving Durat its distinctive texture.

Durat is cast into sheets and different sizes of sinks and bath tubs. The silky way of the material is achieved by using the highest level raw materials.

Durat is extremely durable and can be renewed by slight sanding. The material is very resistant to wear, humidity and various kinds of chemicals. Durat is fabricated using woodworking tools into seamless surfaces by cutting, glueing and sanding.

The sheet size of Durat is 2900 x 800 x 12 mm.





DURAT COLORS

Durat's colour chart is extensive. The three-dimensional surface gives colors a special sense of depth. The colors are available in many fresh tones and the selection also includes various cheerfully speckled alternatives.

Durat offers a unique possibility to create custom colors, making the Durat colour palette practically unlimited. RAL and NCS colour charts are the preferred reference when tinting a new colour. All base colors are also available with black, white, single colour or multicolor speckles.

DURAT COLOUR CHART



910 ●



100 ●



730 ●

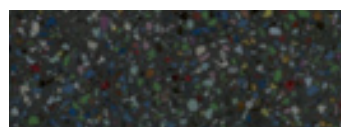

058

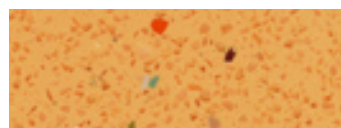

142



228



790



182



610



021 ●



030

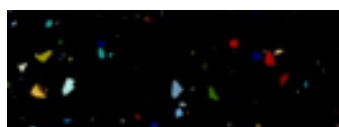

062



470



430



704



391

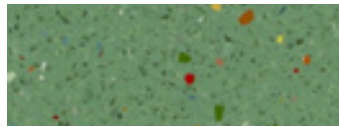

202

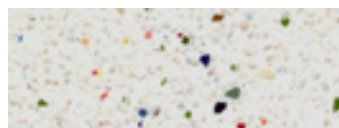

012



031



090



471



424



708



398



810



760 ●



041



310



480



450 ●



080



280



800

● Stock colors (021, 054, 100, 254, 450, 540, 730, 760, 910)

Due to technical reasons the printed samples may differ from the actual colors.



260



291



620



660

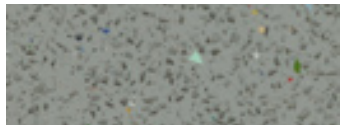

042

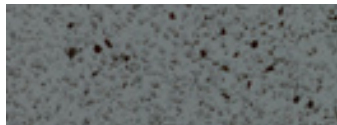

441

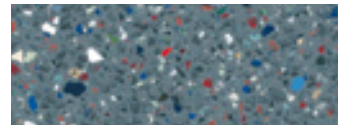

448

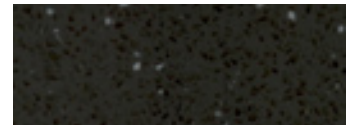

054 ●



098



110



160



168



540 ●



254 ●

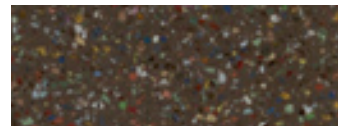

258



221



070

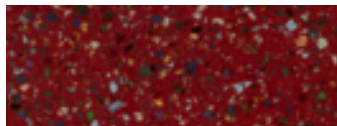

078



750



150



082



671



678



370



230



231



190

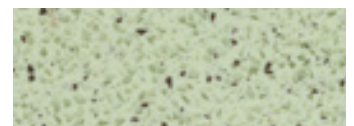

211



808

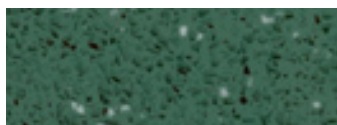

364



274

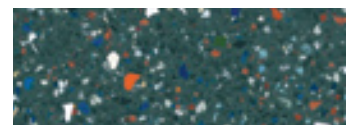

278







DURABLE AND





LUXORIOUS



IN PUBLIC PLACES





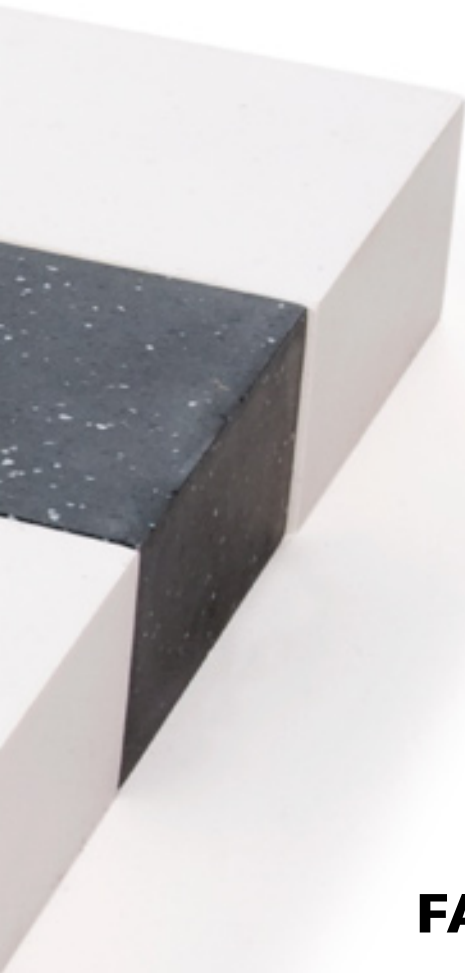

FABRICATION

The Durat material is processed with woodworking tools and the Durat adhesive is used for glueing the seams.

Durat top is backed up with 12-18 mm plywood or mdf support. The support plate is attached to Durat with silicone and a gap of 2 mm is left between the two materials.

The standard satin finish for a Durat surface is achieved by sanding it with 400-grit sanding paper. For a more polished surface a sand paper up to 1000-grit can be used. Durat can be thermoformed to create curved surfaces up to radius 700 mm.

Durat has an extensive network of authorized local solid fabricators. Durat can provide training for fabricators who would join the constantly expanding Durat network.

CUSTOM PROJECTS

The Durat material offers designers almost infinite opportunities to create various surfaces. The sheets can be used to create, for example, coherent, seamless surfaces tens of meters in length with various forms of edge design and intarsia patterns. The seams can be sanded invisible.

Durat has an extensive collection of standard round, oval and rectangular sinks. The standard sinks can be attached to a top of more or less any length and width and the top can incorporate several sinks. The sinks are mounted seamlessly to the top.

Uniquely, Durat can provide custom baths and basins to fit the special needs of a client with the use of a flexible mould technology. Shower trays can be made into any dimension with similar properties as the standard ones.





PRACTICAL IN

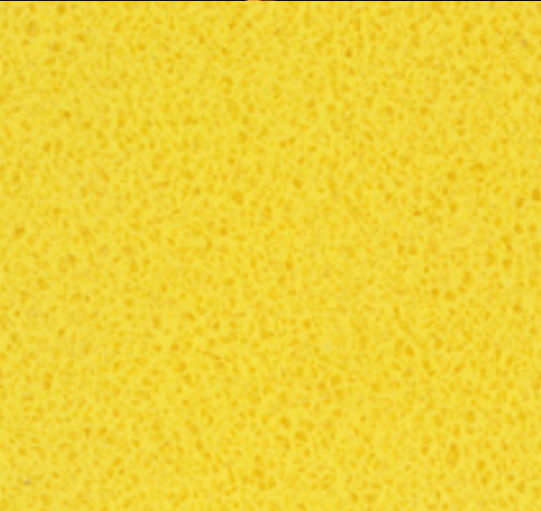
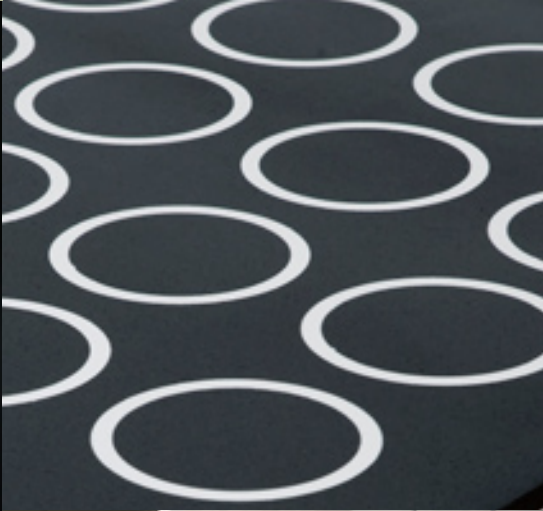

KITCHENS

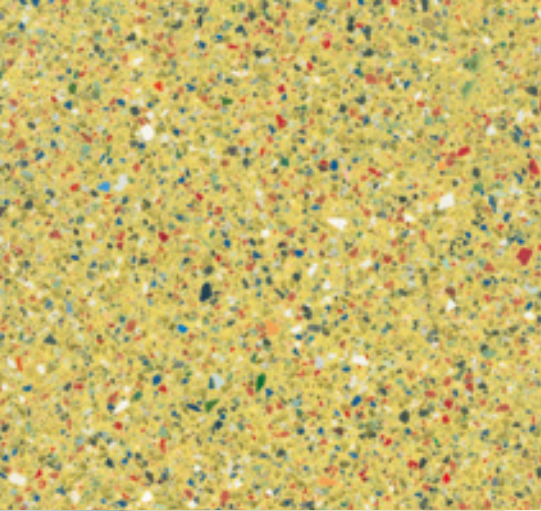

PRODUCTS

Durat solid surface can be made into seamless surfaces and custom vanity units can be made according to the designer's wishes. It is an excellent material for custom surfaces in bathrooms, kitchens, reception desks and table tops.

Durat has an extensive range of standard sink models to be used in custom made vanity units for bathrooms and public sanitary facilities. Uniquely, Durat can provide custom baths and basins to fit the special needs of a client with the use of our flexible mould technology.

Durat Design Collection includes exclusive design furniture including a wide range of baths, sinks, tables and stools.



MINI BATH



OVAL BATH

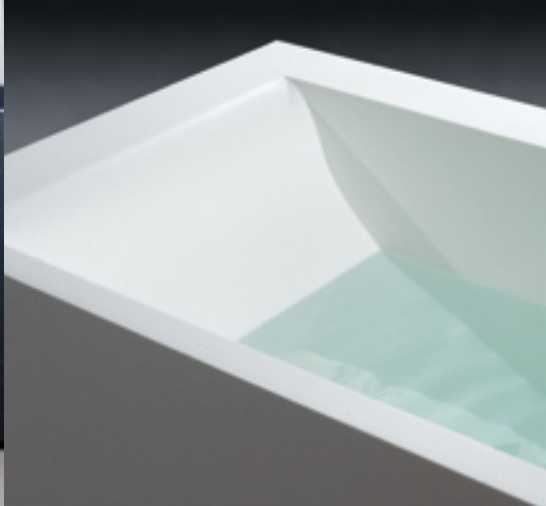

DC74



WARM AND SILKY





IN BATHROOMS

DC61



Sauce be with you

TECHNICAL DETAILS

Durat sheet can be worked with ordinary woodworking tools. Together with the ability to bind the surface seamlessly this makes Durat a very versatile material that can be used in many ways, as kitchen tops, bathroom vanity units, tabletops, shelves etc. The dimension, the length, the width of the top and its edges can be determined almost without constraints.

The 12 mm thick sheet is mounted on a 12-18 mm plywood sheet for extra rigidity, making the minimum thickness to 24-30 mm. The backplate is attached using silicon sealant. In addition, conventional Durat tops need to be supported between 600 mm intervals.

Durat tops may need to be seamed on-site when they can't be delivered in one piece. To ensure a quality finishing of on-site installing it is highly recommended to use an authorized Durat fabricator.

Technical properties

Standard size	2900 x 800 mm
Thickness	12 mm
Weight (std)	approx. 18,3 kg/m ²
Density	1,41 ±0,01 g/cm ³
Barcol hardness	46 ±2
Tensile strength	16,1 ±3,1 MPa
Tensile modulus	4780 ±260 MPa
Strain at brake	0,75 % ±0,05
Heat expansion	0,0072 %/°C

DURAT SINKS

There are about 20 differently shaped and sized Durat sinks which are cast as one piece. There are several different types of rectangular, oval and round sinks to choose from.

The sinks are seamlessly attached to a Durat top from underneath. 12 mm (the thickness of the Durat sheet) is added to the depth of the sink to get the final depth.

Standard overflow and waste are provided with every sink. Clients may choose wastes provided by Durat or supply their own to the factory.



Block I
350 x 230 x 118 (+12)

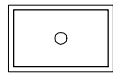

Block V
500 x 300 x 118 (+12)

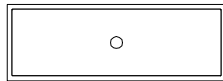

Block X
1100 x 350 x 118 (+12)

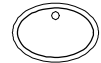

Oval I
400 x 260 x 138 (+12)

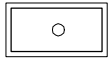

Block II
480 x 230 x 118 (+12)

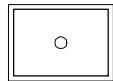

Block VI
500 x 350 x 118 (+12)

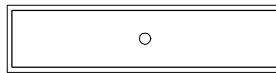

Block XI
1400 x 300 x 118 (+12)

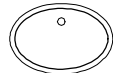

Oval II
490 x 320 x 143 (+12)



Block III
400 x 350 x 118 (+12)



Block VII
800 x 300 x 118 (+12)



Block XI
1400 x 300 x 118 (+12)

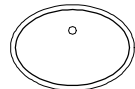

Oval III
600 x 400 x 173 (+12)

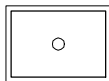

Block IV (kitchen)
500 x 350 x 158 (+12)

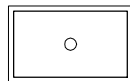

Block VIII
600 x 350 x 118 (+12)

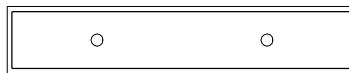

Block XII
1790 x 300 x 118 (+12)



Round I
300 x 118 (+12)



Section

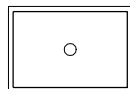

Block IX
600 x 400 x 118 (+12)

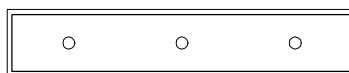

Block XII
1790 x 300 x 118 (+12)



Round II
380 x 138 (+12)

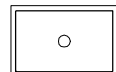
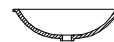

Kehto
510 x 320 x 138 (+12)



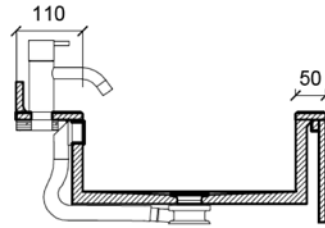
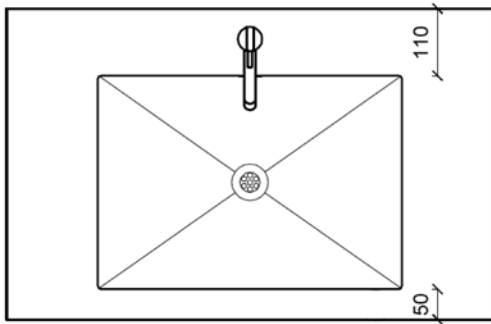

Worktop with a standard overflow and tap.

EDGES AND HOLES

The edges and backsplashes can be made to any dimension. The standard radius for rounding the edges is 2 mm.

Curved edges can be made either by thermoforming or constructing from the sheet material using ordinary cutting and glueing methods.

It's easy to drill and cut holes to a Durat top. The visible edges of the cut-out must be finished. In the case the cut-out will be covered, for example with an overmounted sink or a cooktop, the edges can be left unfinished.

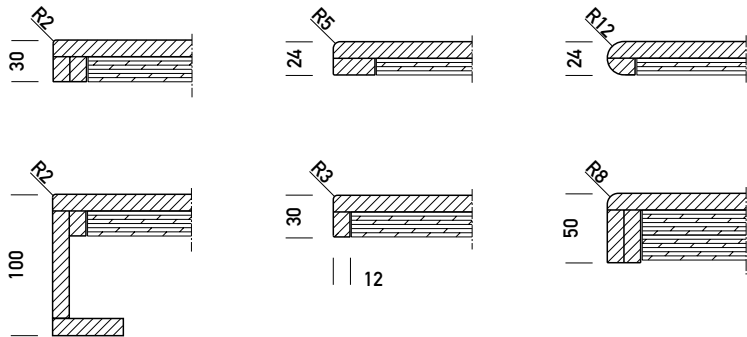

Examples of edge profiles



Cut-out with finished edge



Cut-out with concealed edge

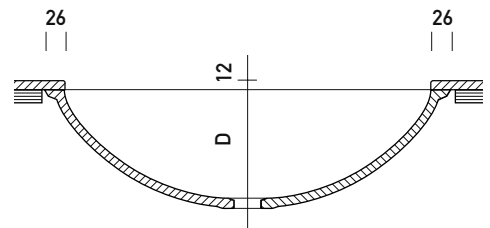
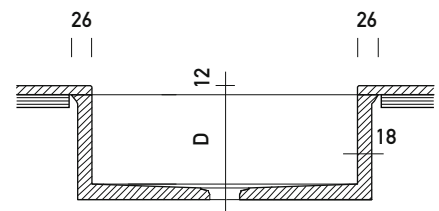

Sink mounted under the worktop







DESIGN COLLECTION

The Design Collection is a selection of exclusive, minimalist design furniture. The collection includes bath tubs, shower trays, wash basins, tables and benches by designers Ulla Koskinen, Eeva Lithovius, Ulla Tuominen, Esa Vesmanen and Aarup Product Design. The names of the design collection items are simple plain descriptions in Finnish – in line with the minimalistic aesthetics of the pieces.

WASH BASINS PLACED ON A TOP

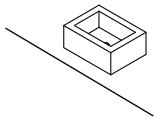

DC70 440x330x180
sink Block I

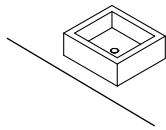

DC71 500x450x180
sink Block III

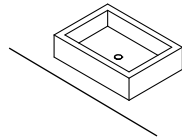

DC80 700x500x180
sink Block IX

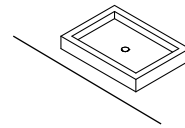

DC73 700x500x100
sink Block IX (depth 70)

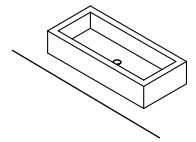

DC77 900x400x180
sink Block VII

WASH BASINS ON A BASE

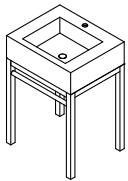

DC61 600x500x180
sink Block VI

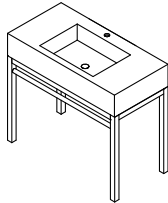

DC64 1000x500x180
sink Block VI

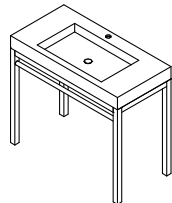

DC68 1000x500x100
sink Block VI (depth 70)

WASH BASINS – SPECIAL UNITS

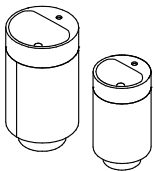

TORNI
DC100 ø460x850
DC101 ø365x680



VATI
DC105 755x425x170
DC106 455x255x100

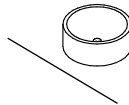

KIPPO
DC103 ø430x170
sink Round II

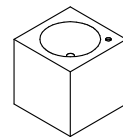

KUUTIO
DC102 500x500x500
sink Round II

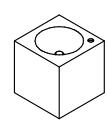

KUUTIO
DC107 400x400x400
sink Round I

BATH TUBS

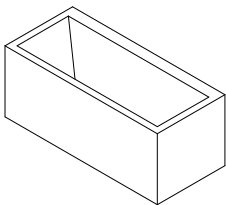

BLOCK
DC01 1780x790x720

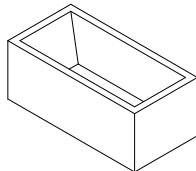

MINI
DC02 1480x735x590

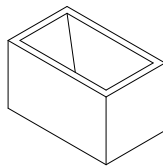

XS
DC03 1145x690x685

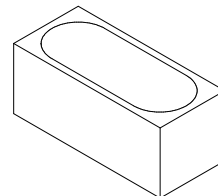

OVAL
DC04 1710x755x710

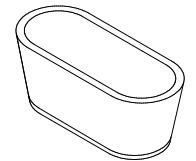

SOIKKO
DC05 1675x705x650

FURNITURE

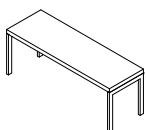

RAITA bench
DC202, DC203 1600x400x450
DC204, DC205 1200x400x450
available in black & white and
multicolour versions

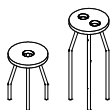

JAKKARA stool
DC206 ø330x460
DC209 ø330x800

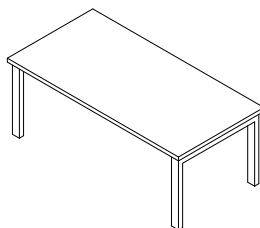

TAMMI table
DC200 2000x1000x740

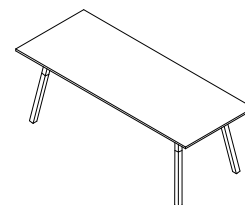

DINE table
DC212 2000x1000x740

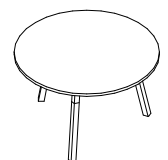

DINE table
DC213 ø1200x740

WALL MOUNTED WASH BASINS



DC74 440x330x180
sink Block I
for wall mounted taps



DC78 440x380x180
sink Block I
tap fits behind the sink

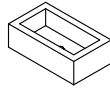

DC75 580x330x180
sink Block II
for wall mounted taps

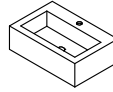

DC79 580x380x180
sink Block II
tap fits behind the sink

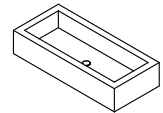

DC77 900x400x180
sink Block VII
for wall mounted taps

SHOWER TRAYS

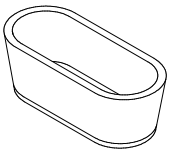

MINI SOIKKO
DC06 1610x695x550

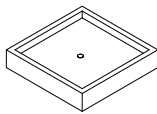

DC30 800x800x180
DC31 900x900x180
basin depth 70

Dimensions: **w**x**d**x**h**, **r**x**h**
Sinks: see page 30

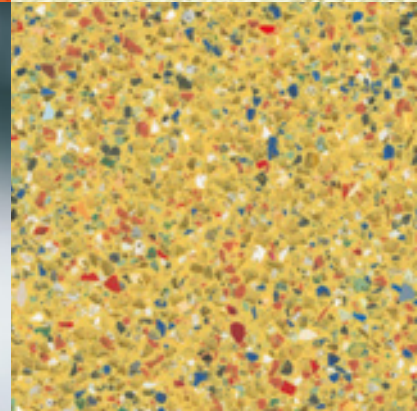
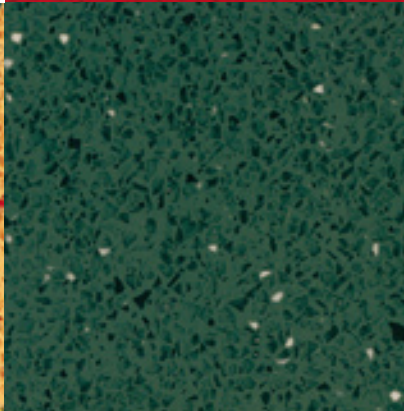
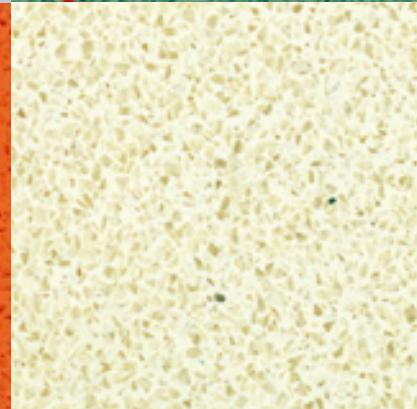
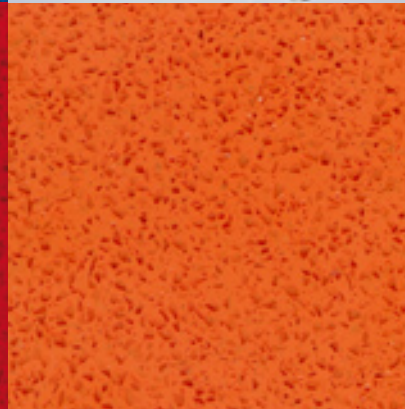
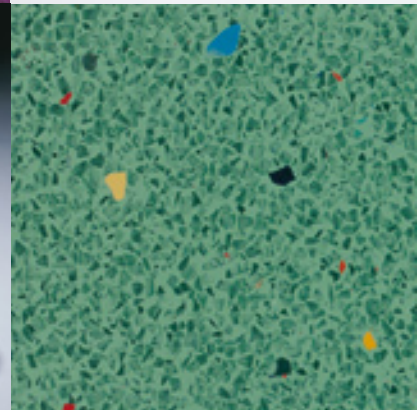
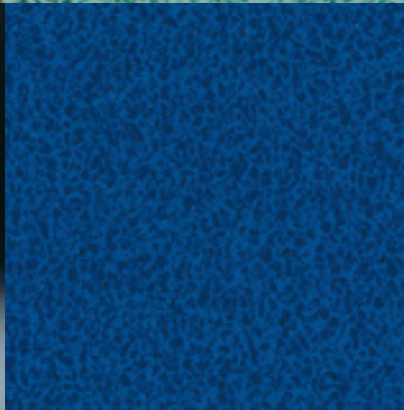
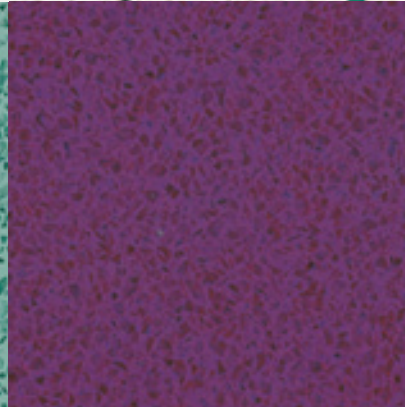
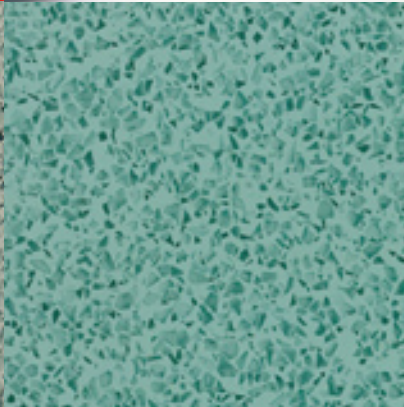
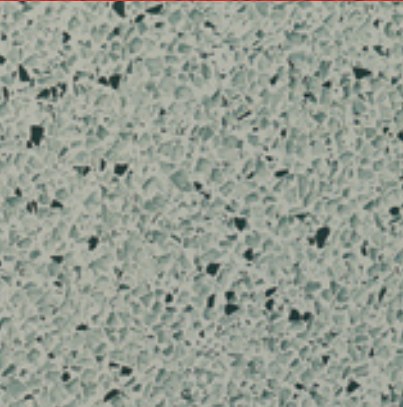
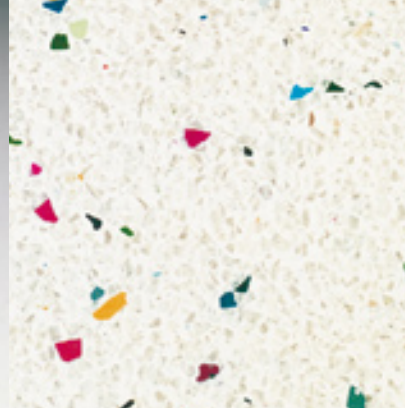
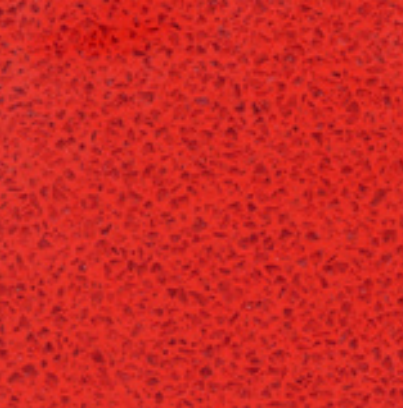

DINE

KEHTO

TORNI

XS BATH

VATI

CREDITS

Interiors

Arup Associates
Piet Boon
Ulla Koskinen
Karim Rashid
... and many others

TAMMI

DC64

Photos

Anu Akkanen
Anders Gramer
Jonny Holmén /Turun Sanomat
Åke E-son Lindman
Marco Melander
Sameli Rantanen
Sami Repo
Seilo Ristimäki/Iloinen Liftari
Matthys van Roon & Mandy Pieper,
styling Rianne Landstra
Studio Rex
Studio Zoo

DC77

SOIKKO

DURAT showroom

Lemuntie 3-5, 00510 Helsinki, Finland.
Tel +358 20 7871880. Fax +358 20 7871899.

DURAT

Huhdantie 4, 21140 Rimito, Finland.
Tel +358 20 7871880. Fax +358 20 7871899.
E-mail info@durat.com www.durat.com