

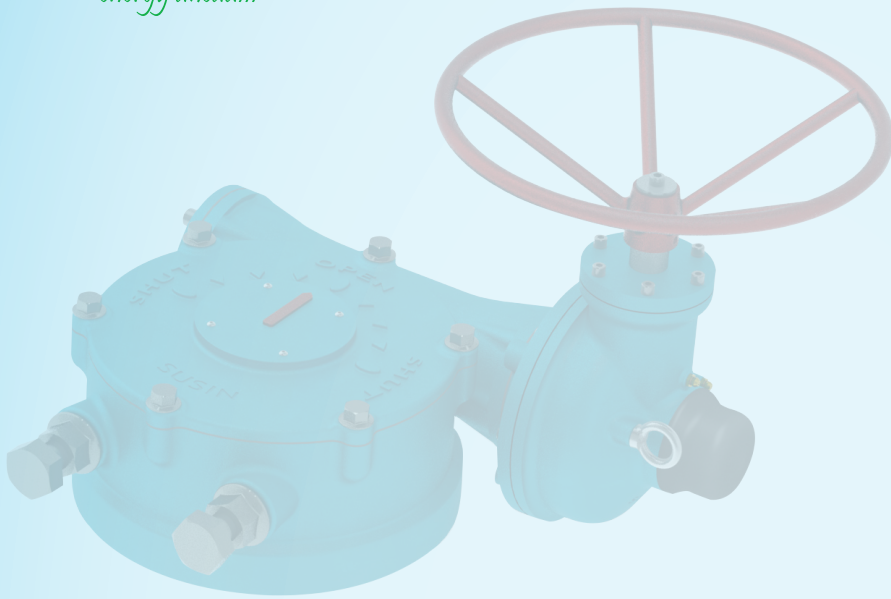

SUSIN I-TORK INDIA PRIVATE LIMITED
An ISO 9001 -2015 Certified Company



MAW Series

MECHANICAL ACTUATORS

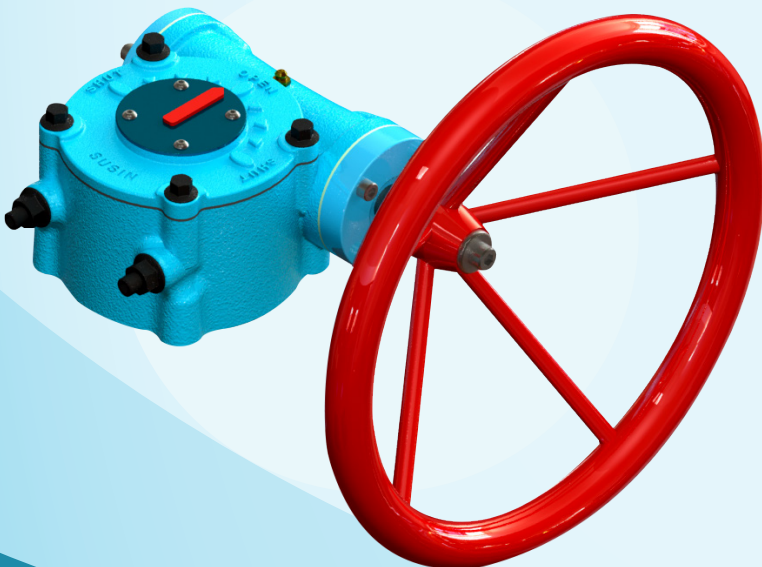

WORM GEAR SERIES

Quarter turn Manual
Worm Gear Actuator

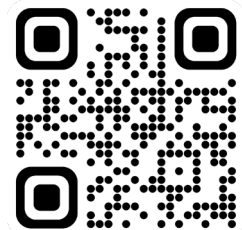

Scan QR Code to
download E-Catalogue

About

SUSIN I-TORK INDIA PRIVATE LIMITED

Susin Group was founded by Mr. Muthukumar in 1992, as a company specialized in the design, manufacture and installation of Valve automation products to different industries. In 2006 the company stepped into marketing to manufacturing, and to focus more on valve automation industrial requirements.

We are providing complete automation solution to all kind of Valve Industries where we equipped to support in pneumatic, hydraulic, electrical & mechanical actuators. susin produces various range of critical products in different applications

OUR GLOBAL PARTNERS



WORM GEAR ACTUATORS - MAW SERIES

MAW Series gear box is rocky with robust design, industrial grade products, manufactured with cast Iron housing and components. These series of gear box will provide an easy operation and reliable surface finish coatings.

APPLICATION

MAW Series Gear Boxes are suitable for all rotary types of valves like Ball Valve, Butterfly Valves and Plug Valves and Dampers. Also, it is highly suitable for all general-purpose Industries as well as chemical, power, HVAC, and waterworks industries. hand wheels are available in a variety of sizes for smooth and easy operation.

Several options such as limit switch, electrical motor can be easily mounted on site without any machining due to integration of all necessary incorporated with housing.



FEATURE

- 9 Models Up to 18,000 Nm Torque Range
- $\pm 5^\circ$ Stroke Adjustment
- IP-67 Rating
- -20°C to $+85^\circ\text{C}$ Temperature Range
- Ductile Iron Housing
- Steel Input Shaft (Stainless Steel Optional)
- Ball Bearing Construction
- PU Coating for Housing and Powder Coated Hand Wheel

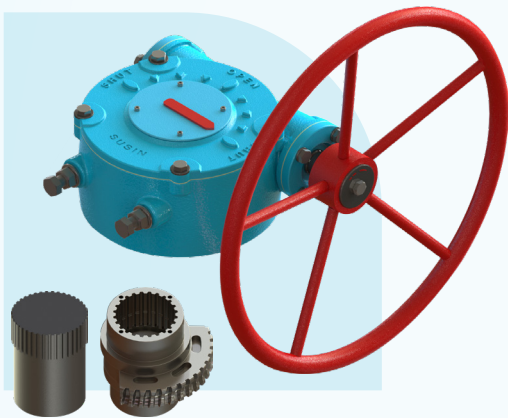
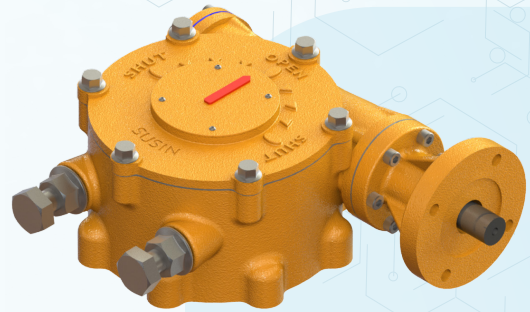

Bushing Type

- Splines are permitted accurate alignment of valve stem key.

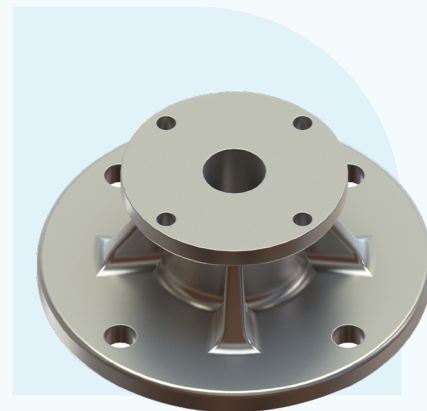

ITM Flange

(For Electrical Actuator)

- Worm gear actuator can provide with electrically operated actuators with ISO mounting dimensions.

TECHNICAL SPECIFICATIONS

MODEL NO	Input Torque (Nm)	Output Torque (Nm)	M.A $\pm 10\%$	Gear Ratio	Valve Mounting Specification		Hand Wheel Dia (mm)
					Standard	Option	
MAW-025	18.26	250	13.69	30:1	F07	F05	200
MAW-045	25.96	450	17.34	38:1	F10	F07	250
MAW-080	44.96	800	17.78	40:1	F12	F10	300
MAW-100	56.20	1000	17.79	40:1	F12	F10	350
MAW-200	99.63	2000	20.07	44:1	F14	F12	400
MAW-400	182.65	4000	21.89	48:1	F20	F16	560
MAW-650	287.17	6500	22.63	52:1	F20	F16	560
MAW-900	369.22	9000	24.37	56:1	F25	F20	630
MAW-1800	851.48	18000	21.13	62:1	F30	F25	710

Mentioned specifications & dimensions are subject to change without prior notice for quality improvement

SUSIN WORM GEAR ACTUATORS - MAW SERIES

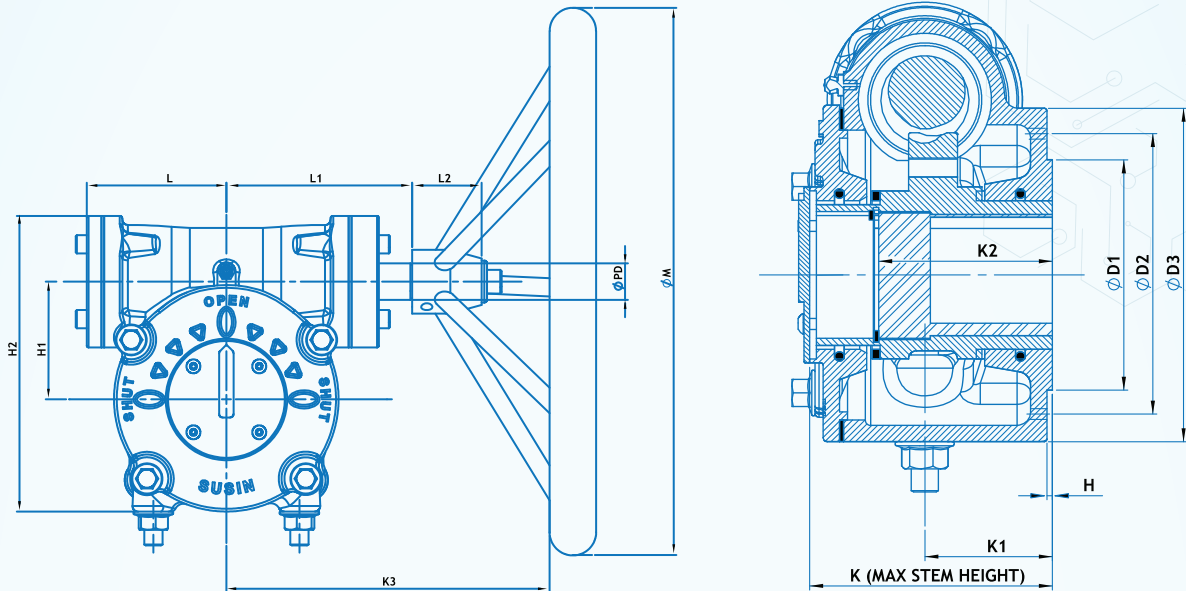

ISO 5211 FLANGE MOUNTING DETAILS

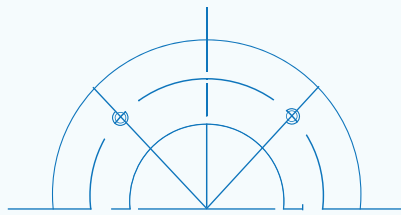

Type - A

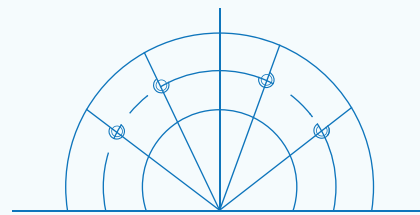

Type - B

DIMENSIONS

MODEL NO	BASE PART						EXTERNAL PART								INPUT SHAFT PART				
	TYPE FLANGE	ØD1	P.C.D			H	H1	H2	K	K1	K2	K3	L	L1	L2	ØPD	KEY	HAND WHEEL	
			ØD2	N-H-DP	ØD3														
MAW-025	F07	55	70	4-M8-12	101	2	41	121	73	35	55	95	43	65	22	15	6x6	200	
MAW-045	F10	70	102	4-M10-15	125	2	55	135	75	32.5	55	105	55	75	22	15	6x6	250	
MAW-080	F12	85	125	4-M12-18	148	2	63.5	165	86	47	64	150	77	102	24	20	8x7	300	
MAW-100	A	F12	85	125	4-M12-18	148	2	63.5	165	86	47	65	150	77	102	24	20	8x7	350
MAW-200	F14	100	140	4-M16-24	163	2	82.5	222	99	50	66	230	85	135	38	20	8x7	400	
MAW-400	F16	130	165	4-M20-30	210	2	118	315	128	70	85	260	124	161	38	25	8x6	500	
MAW-650	F20	160	205	8-M16-24	250	3	128	315	136	75	105	285	145	178	42	30	10x8	560	
MAW-900	B	F25	200	254	8-M16-30	300	3	150	410	147	80	115	320	183	202	45	30	10x8	630
MAW-1800	F30	230	298	8-M20-30	350	3	160	480	158	89	155	355	238	256	45	30	10x8	710	

Mentioned specifications & dimensions are subject to change without prior notice for quality improvement

EXPLODED VIEW

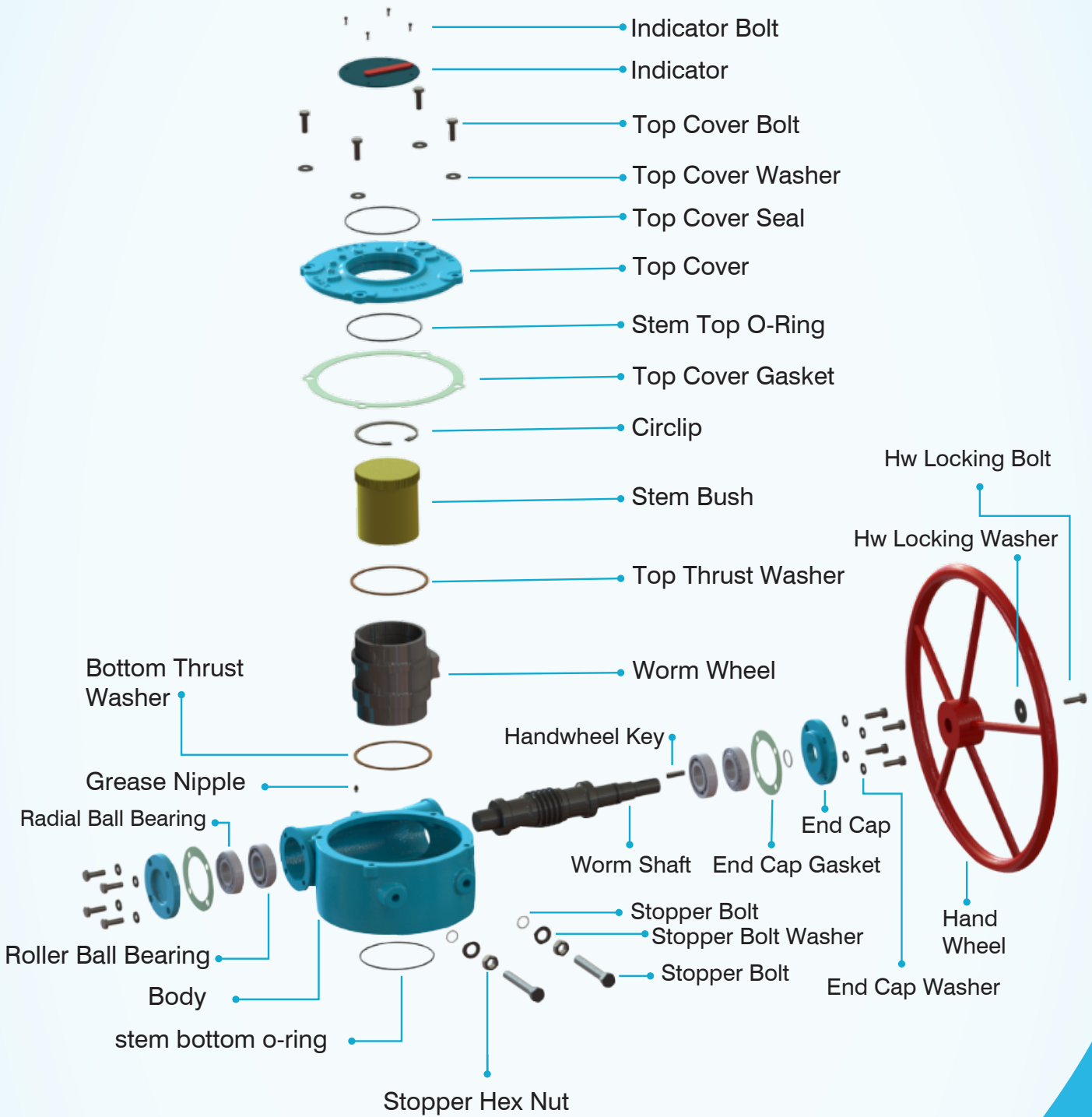

HANDWHEEL

- ✔ Varies type of casting, fabricated handwheels & chain wheels can be offered by Susin.
- ✔ High quality material has been used for best construction.
- ✔ Hand wheels provide a simple and direct way to manually control valves.
- ✔ **Quick Response** : With hand wheels, you can quickly open or close valves in response to changing conditions, maintenance needs.
- ✔ **Visual Positioning** : Hand wheels have markings or indicators that show the position of the valve. This visual reference allows operators to determine the valve's status at a glance.



Casting Wheel
Ranges from 8" to 16"



Chain Wheel
Ranges from 4" to 20"



Fabricated Wheel
Ranges from 8" to 40"

PAINTING

- Applicable as per the standard ISO 12944-2
- We are providing our products in the following standard colors

S NO	COLOR NAME	COLOR CODE	RANGE (micron)
1	Sky Blue	RAL 5015	UPTO 300
2	Brown Red	RAL 3011	UPTO 300
3	Jet Black	RAL 9005	UPTO 300



We provide special Painting for marine application and we can able to custom build color as per the customer requirement if it is possible

MATERIAL OF CONSTRUCTION

S.NO	PARTS NAME	MATERIAL	
		NAME	ASTM
1	MAW Housing	Ductile iron	ASTM A536-65-45-12
2	MAW Cover	Ductile iron	ASTM A536-65-45-12
3	Worm Wheel	Ductile iron	ASTM A536-80-55-06
4	Drive Shaft	Carbon Steel	A576-1045
5	Worm Shaft	Carbon Steel	A576-1045
6	RH Cover	Ductile iron	ASTM A536-65-45-12
7	LH Cover	Ductile iron	ASTM A536-65-45-12
8	Top Thrust Washer	Steel	A576-1045
9	Bottom Thrust Washer	Steel	A576-1045
10	Side Cover Gasket	Non-Asbestos	
11	Top Cover Gasket	Non-Asbestos	
12	Top O-ring	NBR	
13	Bottom O-Ring	NBR	
14	Worm Shaft Wear Ring	Delrin	
15	Stopper Bolt	Carbon Steel	
16	Stopper Washer	Stainless Steel	
17	Stopper Hex. Nut	Carbon Steel	
18	Stopper Bolt O-Ring	NBR	
19	End Cap Hex. Bolt	Alloy Steel	
20	End Cap Spring Washer	Alloy Steel	
21	Top Cover Bolt	Stainless Steel	
22	Top Cover Plain Washer	Stainless Steel	
23	Grease Nipple	BRASS	
24	Radial Ball Bearing	Special Steel	A295-52100
25	Worm Screw Shaft O-ring	NBR	
26	Circlip	Special Steel	
27	Hand Wheel	Steel	
28	Hand wheel Locking Washer	Stainless Steel	
29	Hand wheel Locking Bolt	Stainless Steel	
30	Radial Ball Bearing	Special Steel	A295-52100
31	Indication Plate	Stainless Steel	
32	Indication Plate Bolt	Stainless Steel	
33	Indication Plate Washer	Stainless Steel	
34	Name Plate	Stainless Steel	
35	Name Plate Rivet	Steel	

OTHER PRODUCTS



Hydraulic Actuators
(Rotary & Linear types)



Electrical Actuators



Pneumatic Actuators
(Rotary & Linear types)

SUSIN GROUP GLOBAL PRESENCE



Scan QR Code to
download E-Catalogue

MANUFACTURING FACILITIES



INDIA

SUSIN I-TORK INDIA PRIVATE LIMITED
43A9 , Vadakku Thottam, Idigarai,
Coimbatore, Tamilnadu, India - 641022
E-mail : venkat@susinma.com
Website : www.susinma.com
Tel : +91 95009 96064



KOREA

I-TORK CONTROLS LTD
74-6 , Chunui-Dong, Wonmi-Gu, Bucheon Si,
Gyeonggi-Do, South Korea, Zip : 420-120
Tel : +82-2-855-1365
Fax : +82-2-855-1367
E-mail : we123@itork.com
Website : www.i-tork.com



Germany

KTC SYSTEMTECHNIK GMBH
Krähenweg 11, D 22459 Hamburg,
Germany
Tel : +49 (0)40 5714752-0
Fax : +49 (0)40 5714752-22
E-mail : teichler@ktc-systemtechnik.de

SALES & SUPPORT



SINGAPORE

AHF INDUSTRIES - HEAD OFFICE
2 , Kallang Pudding #07-12, #06-05/06,
Mac Tech Building Singapore, 349307
Tel : +65 6748 8108
Fax 1 : +65 6842 5567
Fax 2 : +65 6748 8917



MALAYSIA

AHF ENGINEERING Sdn. Bhd.
No 5 , Jalan USJ 1/31, Taman Subang Permai,
47600 Subang Jaya Selangor, Malaysia
Tel : +603-8024-0940
E-mail : cky@ahfengineering.com
sales@ahfengineering.com



UNITED ARAB EMIRATES

SUSIN I-TORK ME FZC
Y61 , Executive Suite
Post Box No - 122643, Saif Zone Sharjah
United Arab Emirates
Tel : 971 529407969
Fax : +65 6748 8917