



|       |       |
|-------|-------|
| Scene | Panel |
| 1     | 1     |



Dialog  
 130 AIR FORCE  
 COMMANDING OFFICER  
 Men, only a single Allied pilot  
 has survived an encounter  
 with the Red Baron. Meet  
 America's World War One  
 Flying Ace...

Action Notes  
 EXT. AIRFIELD - DAY  
 Four WWI AIR FORCE PILOTS  
 stand outside of a HANGAR.  
 Their COMMANDING OFFICE

R paces in front of them.

|       |       |
|-------|-------|
| Scene | Panel |
| 1     | 2     |



Dialog  
 130 AIR FORCE  
 COMMANDING OFFICER  
 Men, only a single Allied pilot  
 has survived an encounter  
 with the Red Baron. Meet  
 America's World War One  
 Flying Ace...

Action Notes  
 EXT. AIRFIELD - DAY  
 Four WWI AIR FORCE PILOTS  
 stand outside of a HANGAR.  
 Their COMMANDING OFFICE

R paces in front of them.

|       |       |
|-------|-------|
| Scene | Panel |
| 2     | 1     |



Dialog  
131 WWI PILOT JONES Did you say "one"?

|       |       |
|-------|-------|
| Scene | Panel |
| 2     | 2     |



Dialog  
132 AIR FORCE COMMANDING OFFICER ...Captain Snoopy!

|       |       |
|-------|-------|
| Scene | Panel |
| 3     | 1     |



Action Notes  
 SNOOPY, in his WWI FLYING ACE GEAR, steps from around a corner. He walks back and forth in front of the recruits.

|       |       |
|-------|-------|
| Scene | Panel |
| 3     | 2     |



Dialog  
 133 SNOOPY  
 Bleeaaaaahhh bleah grrrrr blahh.

Action Notes  
 SNOOPY, in his WWI FLYING ACE GEAR, steps from around a corner. He walks back and forth in front of the recruits.

|       |       |
|-------|-------|
| Scene | Panel |
| 3     | 3     |



Dialog  
 133 SNOOPY  
 Bleeaaaaahhh bleah grrrrr blahh.

Action Notes  
 SNOOPY, in his WWI FLYING ACE GEAR, steps from around a corner. He walks back and forth in front of the recruits.

Scene 3 Panel 4



Dialog  
133 SNOOPY  
Bleeeaaaahhh bleah grrrrr  
blahh.

Action Notes  
SNOOPY, in his WWI FLYING  
ACE GEAR, steps from  
around a corner. He walks  
back and forth in front of the  
recruits.

Scene 4 Panel 1



Dialog  
134 WWI PILOT SMITH  
Sir, that's, uhh, that's a dog.

Scene 4 Panel 2



|       |       |   |
|-------|-------|---|
| Scene | Panel |   |
|       | 5     | 1 |



Dialog  
135 AIR FORCE  
COMMANDING OFFICER  
THAT IS THE WORLD WAR  
ONE FLYING  
ACE, PILOT! AND YOU WILL  
HEED EVERY SINGLE WORD  
OUT OF HIS MOUTH!

|       |       |   |
|-------|-------|---|
| Scene | Panel |   |
|       | 6     | 1 |

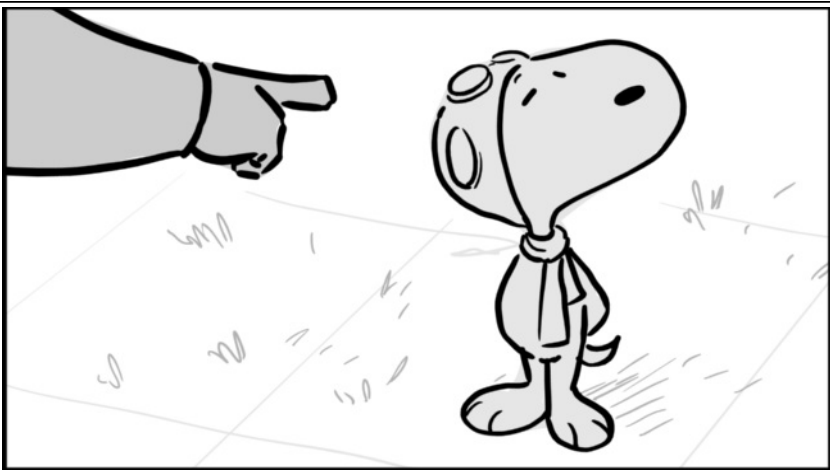

Dialog  
135 AIR FORCE  
COMMANDING OFFICER  
THAT IS THE WORLD WAR  
ONE FLYING  
ACE, PILOT! AND YOU WILL  
HEED EVERY SINGLE WORD  
OUT OF HIS MOUTH!

|       |       |   |
|-------|-------|---|
| Scene | Panel |   |
|       | 6     | 2 |



|       |       |   |
|-------|-------|---|
| Scene | Panel |   |
|       | 7     | 1 |

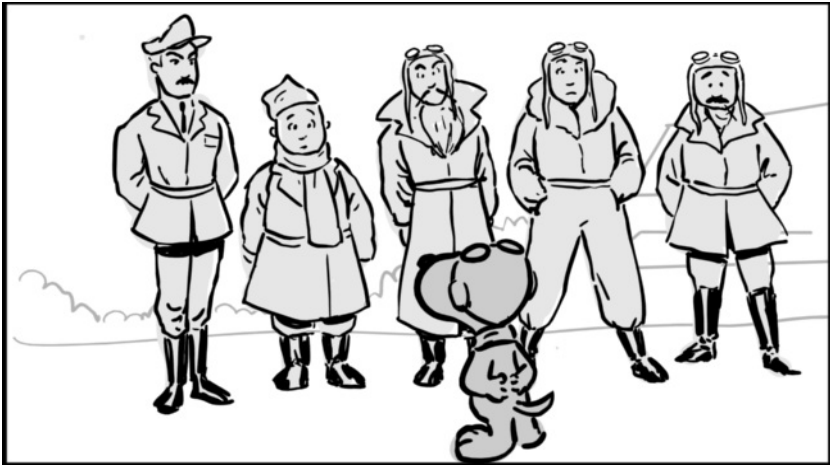

Action Notes

Snoopy shakes his head at the recruits then walks toward the runway. Five DOGHOUSES are lined up.

|       |       |   |
|-------|-------|---|
| Scene | Panel |   |
|       | 7     | 2 |

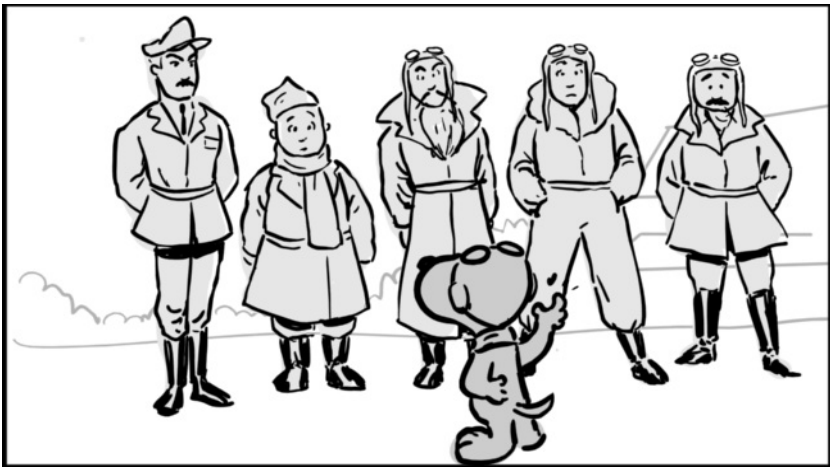

Action Notes

Snoopy shakes his head at the recruits then walks toward the runway. Five DOGHOUSES are lined up.

|       |       |   |
|-------|-------|---|
| Scene | Panel |   |
|       | 7     | 3 |



Action Notes

Snoopy shakes his head at the recruits then walks toward the runway. Five DOGHOUSES are lined up.

|       |       |
|-------|-------|
| Scene | Panel |
| 8     | 1     |

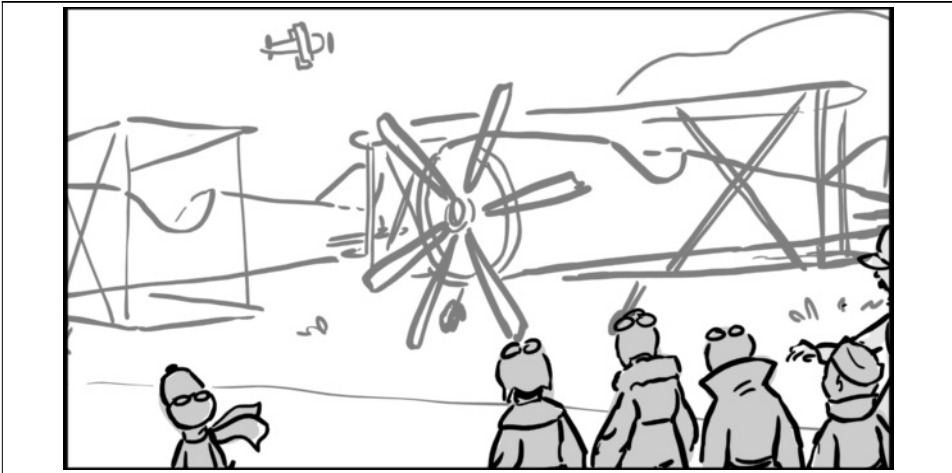

Dialog  
 136 AIR FORCE  
 COMMANDING OFFICER  
 (CONT'D) These are your  
 new aircraft. No  
 idea how they work but we've  
 seen  
 the Ace fly one and they only  
 cost  
 about three dollars in scrap  
 wood.

Action Notes  
 Snoopy shakes his head at th

e recruits then walks toward  
 the runway. Five  
 DOGHOUSES are lined up.

|       |       |
|-------|-------|
| Scene | Panel |
| 8     | 2     |

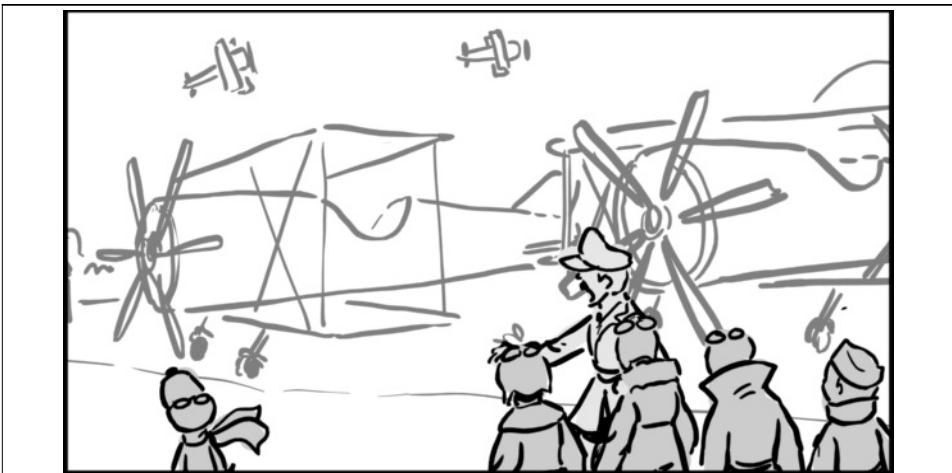

Dialog  
 136 AIR FORCE  
 COMMANDING OFFICER  
 (CONT'D) These are your  
 new aircraft. No  
 idea how they work but we've  
 seen  
 the Ace fly one and they only  
 cost  
 about three dollars in scrap  
 wood.

Action Notes  
 Snoopy shakes his head at th

e recruits then walks toward the runway. Five DOGHOUSES are lined up.

|       |       |
|-------|-------|
| Scene | Panel |
|       | 8 3   |



Dialog  
136 AIR FORCE  
COMMANDING OFFICER  
(CONT'D) These are your new aircraft. No idea how they work but we've seen the Ace fly one and they only cost about three dollars in scrap wood.

Action Notes  
Snoopy shakes his head at th

e recruits then walks toward the runway. Five DOGHOUSES are lined up.



Scene 9 Panel 1



Dialog  
137 WWI PILOT JONES These are doghouses, sir.

Scene 10 Panel 1



Dialog  
138 AIR FORCE COMMANDING OFFICER THEY'RE AIRCRAFT, SOLDIER! NOW MOUNT UP!

Scene 10 Panel 2



|       |       |
|-------|-------|
| Scene | Panel |
| 11    | 1     |

Action Notes  
Snoopy climbs on top of his doghouse.

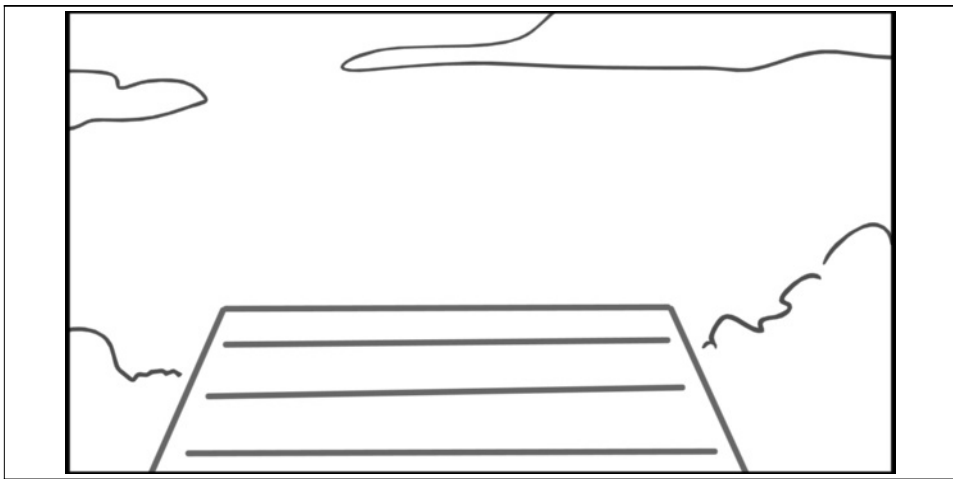

|       |       |
|-------|-------|
| Scene | Panel |
| 11    | 2     |

Action Notes  
Snoopy climbs on top of his doghouse.

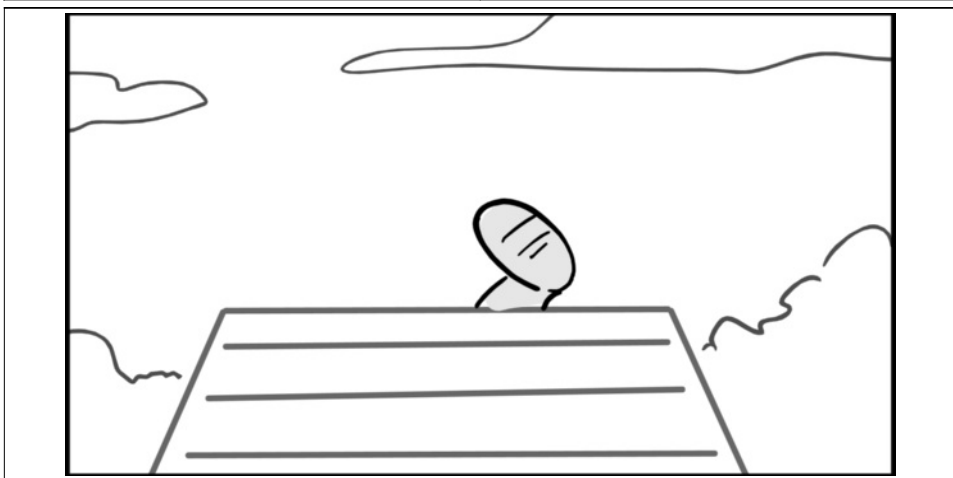

|       |       |
|-------|-------|
| Scene | Panel |
| 11    | 3     |

Action Notes  
Snoopy climbs on top of his doghouse.

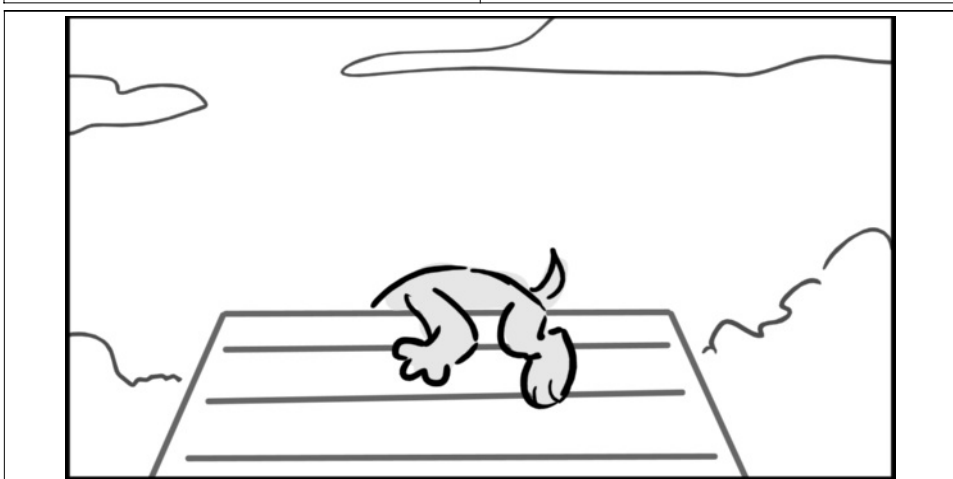

|       |       |
|-------|-------|
| Scene | Panel |
| 11    | 4     |

Action Notes  
Snoopy climbs on top of his doghouse.

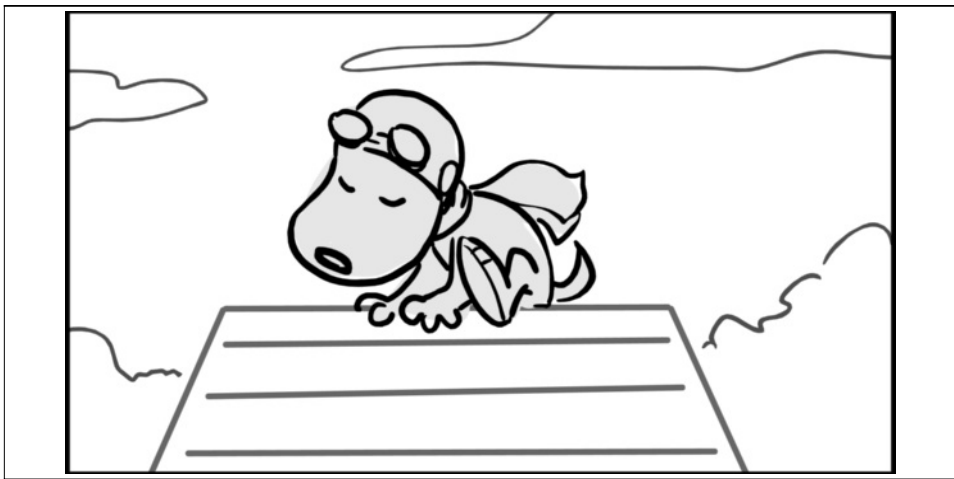

|       |       |
|-------|-------|
| Scene | Panel |
| 11    | 5     |

Action Notes  
Snoopy climbs on top of his doghouse.

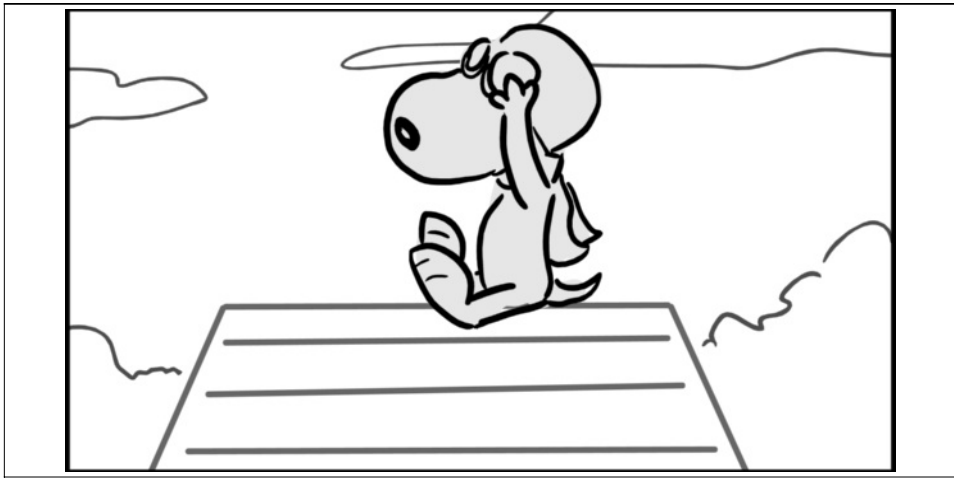

|       |       |
|-------|-------|
| Scene | Panel |
| 11    | 6     |

Action Notes  
Snoopy climbs on top of his doghouse.

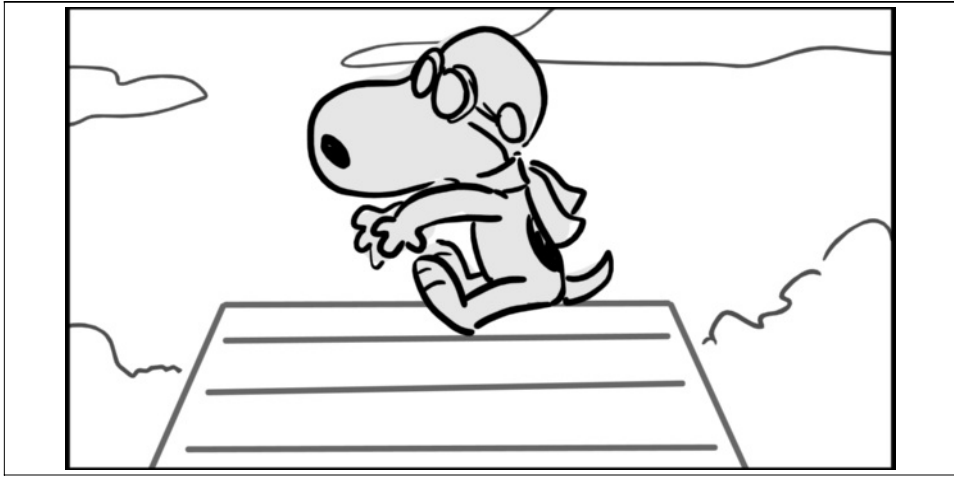

|       |       |
|-------|-------|
| Scene | Panel |
| 12    | 1     |

Action Notes  
The Pilots struggle to get on top of theirs.



|       |       |
|-------|-------|
| Scene | Panel |
| 12    | 2     |

Action Notes  
The Pilots struggle to get on top of theirs.



|       |       |
|-------|-------|
| Scene | Panel |
| 13    | 1     |

Dialog  
139 WWI PILOT SMITH  
Um, sir, where are the controls?

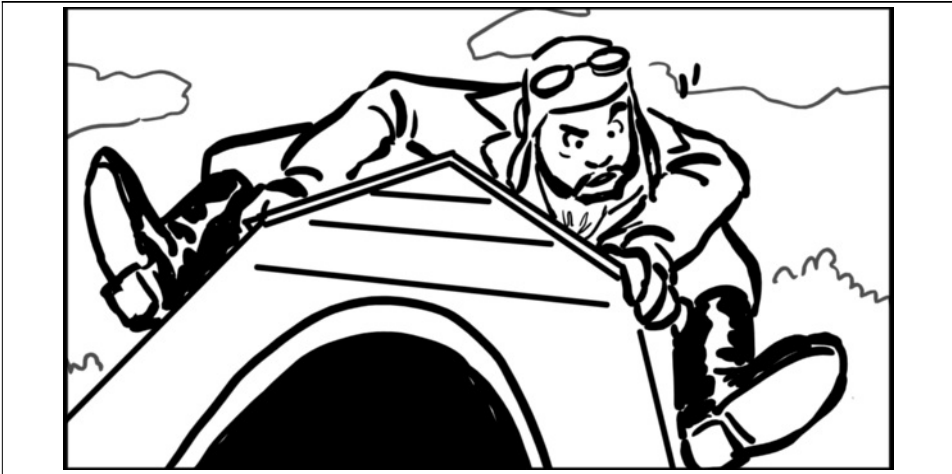

|       |       |
|-------|-------|
| Scene | Panel |
| 14    | 1     |



Dialog  
140 AIR FORCE  
COMMANDING OFFICER DID  
YOU HAVE TO ASK YOUR  
MAMA WHERE YOUR DICK  
WAS WHEN YOU WANTED  
TO  
PISS, SAILOR?!

|       |       |
|-------|-------|
| Scene | Panel |
| 15    | 1     |

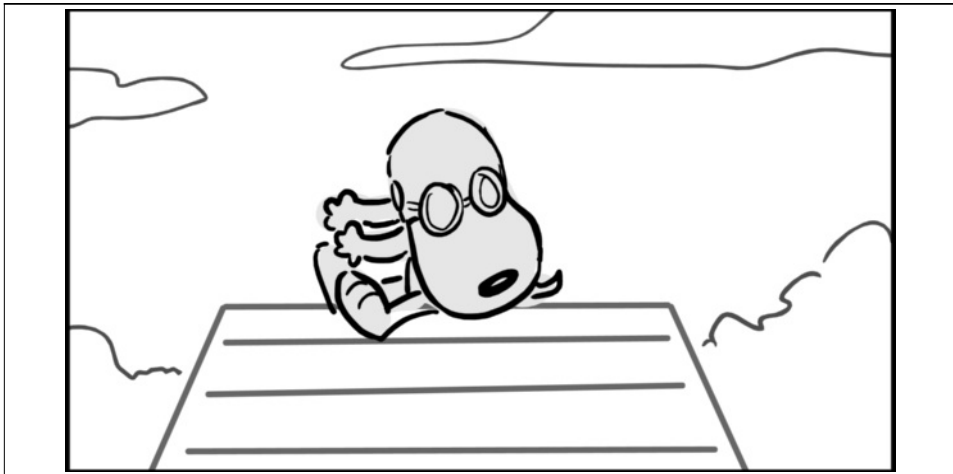

Action Notes  
Snoopy makes a few motions  
like he's starting a plane.

|       |       |
|-------|-------|
| Scene | Panel |
| 15    | 2     |

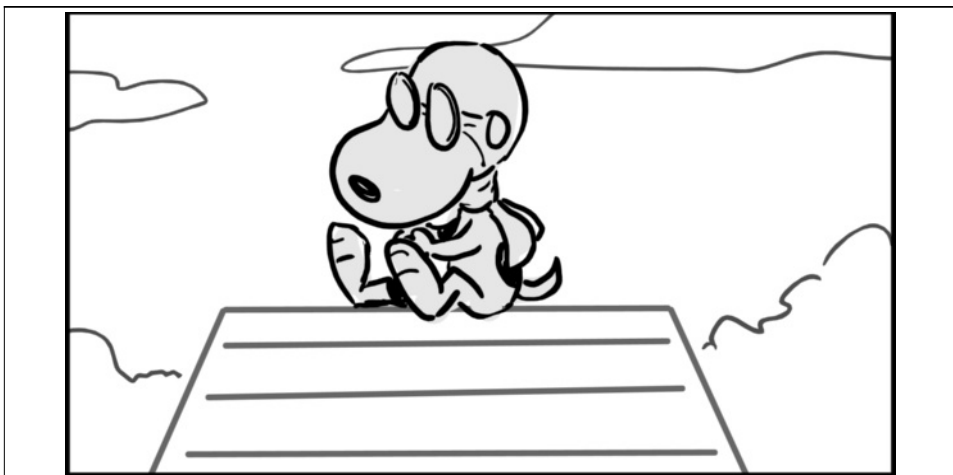

Action Notes  
Snoopy makes a few motions  
like he's starting a plane.

|       |       |
|-------|-------|
| Scene | Panel |
| 15    | 3     |

Action Notes

Snoopy makes a few motions like he's starting a plane.

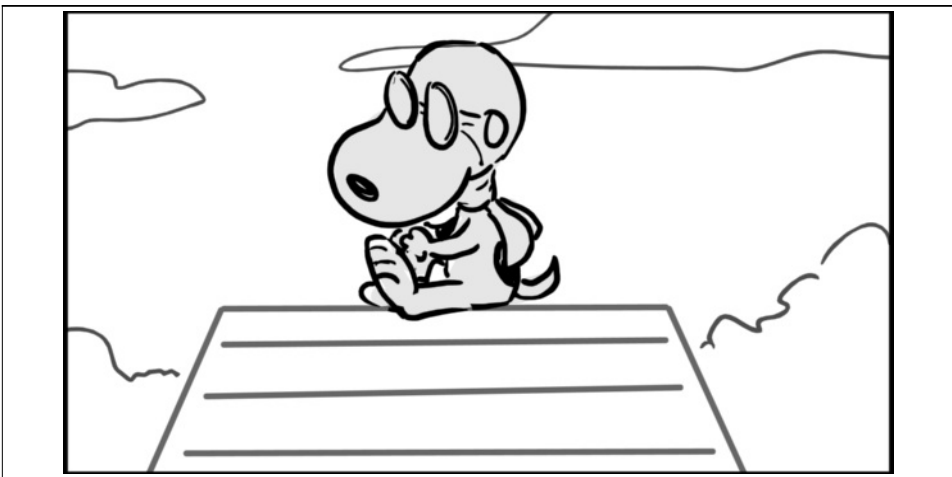

|       |       |
|-------|-------|
| Scene | Panel |
| 15    | 4     |

Action Notes

Snoopy makes a few motions like he's starting a plane.

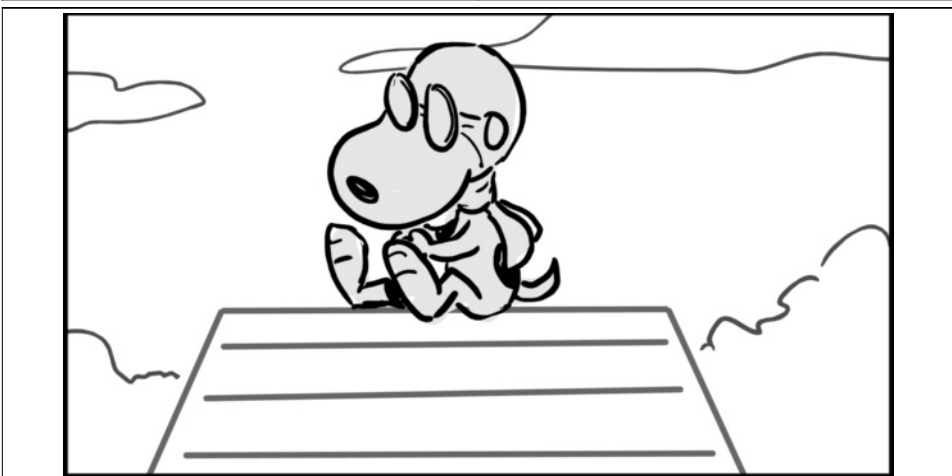

|       |       |
|-------|-------|
| Scene | Panel |
| 15    | 5     |

Action Notes

Snoopy makes a few motions like he's starting a plane.

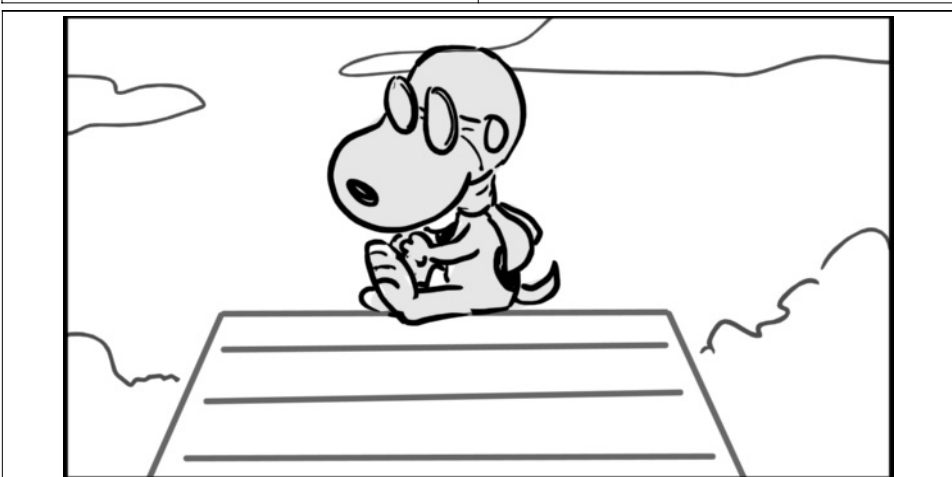

|       |       |
|-------|-------|
| Scene | Panel |
| 15    | 6     |

Action Notes  
Snoopy makes a few motions like he's starting a plane.

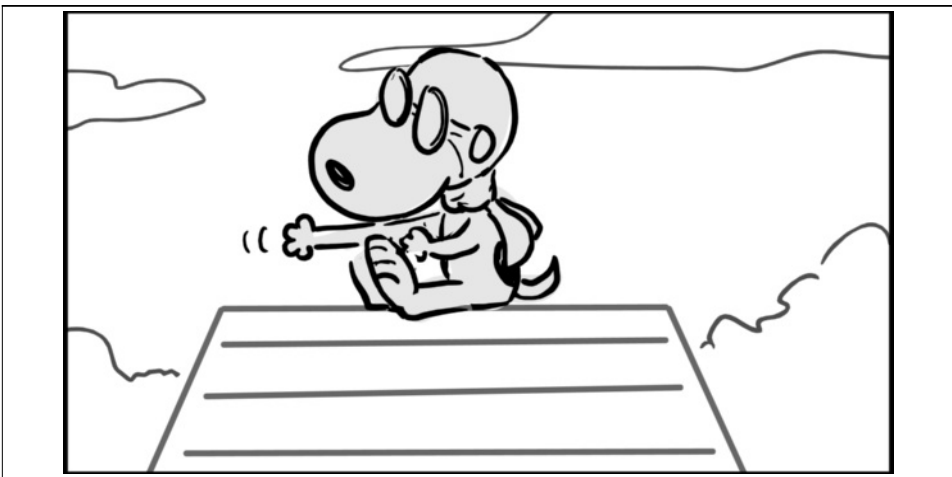

|       |       |
|-------|-------|
| Scene | Panel |
| 15    | 7     |

Action Notes  
Snoopy makes a few motions like he's starting a plane.

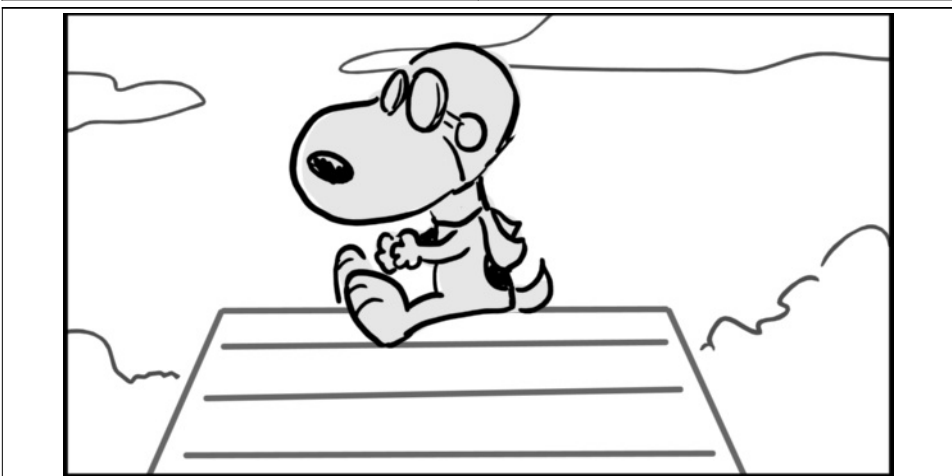

|       |       |
|-------|-------|
| Scene | Panel |
| 15    | 8     |

Action Notes  
Snoopy makes a few motions like he's starting a plane.

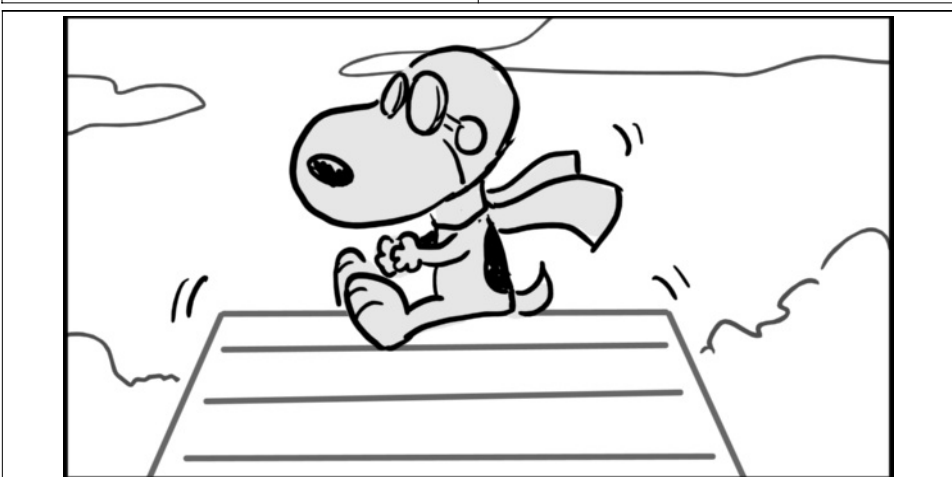

|       |       |
|-------|-------|
| Scene | Panel |
|       | 15    |

Action Notes  
 Snoopy makes a few motions like he's starting a plane.

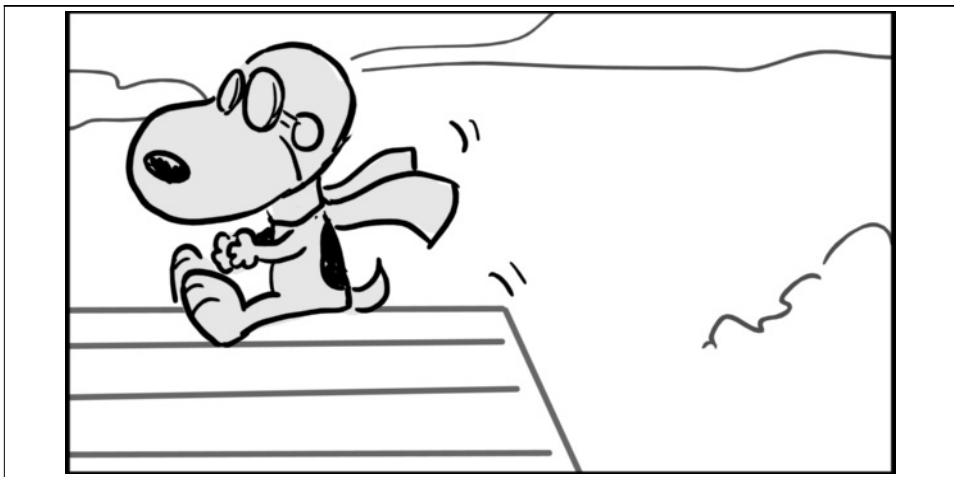

|       |       |
|-------|-------|
| Scene | Panel |
|       | 16    |

Action Notes  
 They all hear it REV UP. The pilots copy what Snoopy did and they hear their engines REV UP.



|       |       |
|-------|-------|
| Scene | Panel |
|       | 16    |

Action Notes  
 They all hear it REV UP. The pilots copy what Snoopy did and they hear their engines REV UP.

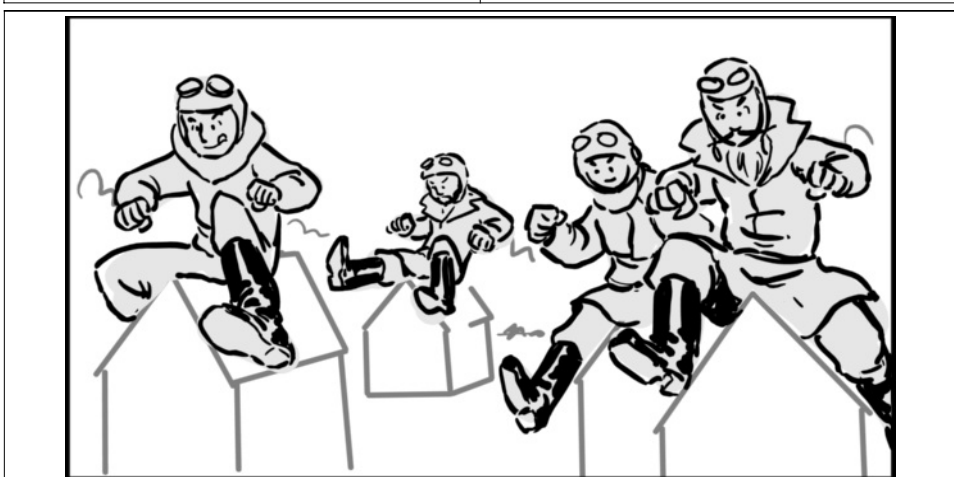



|       |       |
|-------|-------|
| Scene | Panel |
| 16    | 3     |

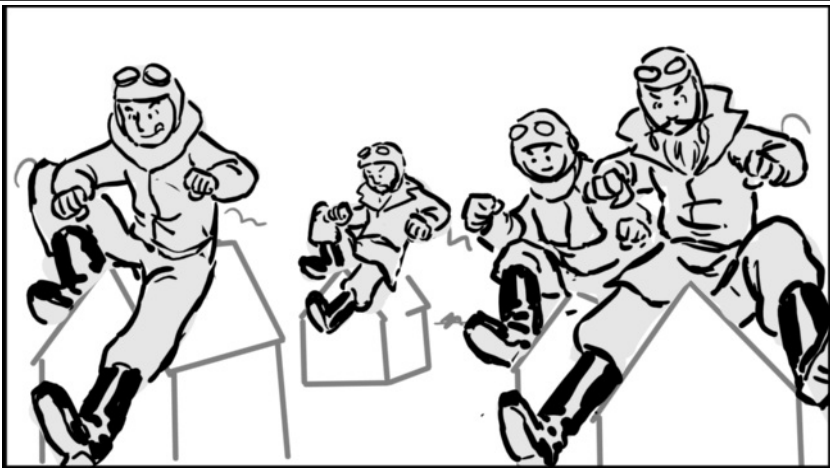

Action Notes  
 They all hear it REV UP. The pilots copy what Snoopy did and they hear their engines REV UP.

|       |       |
|-------|-------|
| Scene | Panel |
| 16    | 4     |

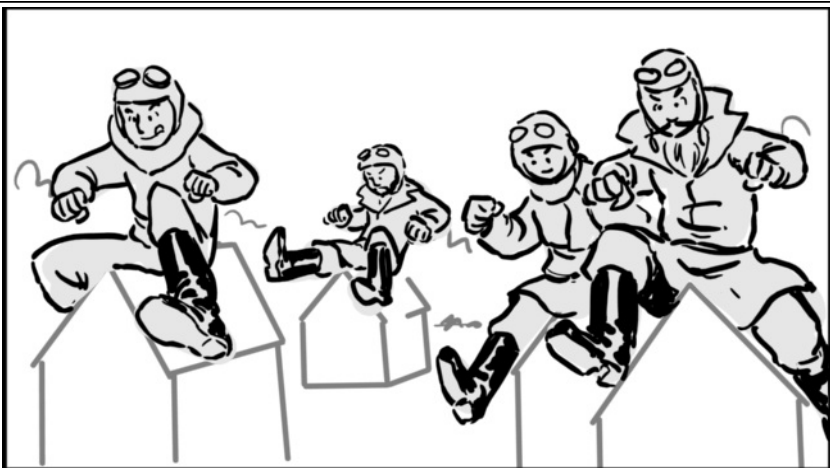

Action Notes  
 They all hear it REV UP. The pilots copy what Snoopy did and they hear their engines REV UP.

|       |       |
|-------|-------|
| Scene | Panel |
| 16    | 5     |

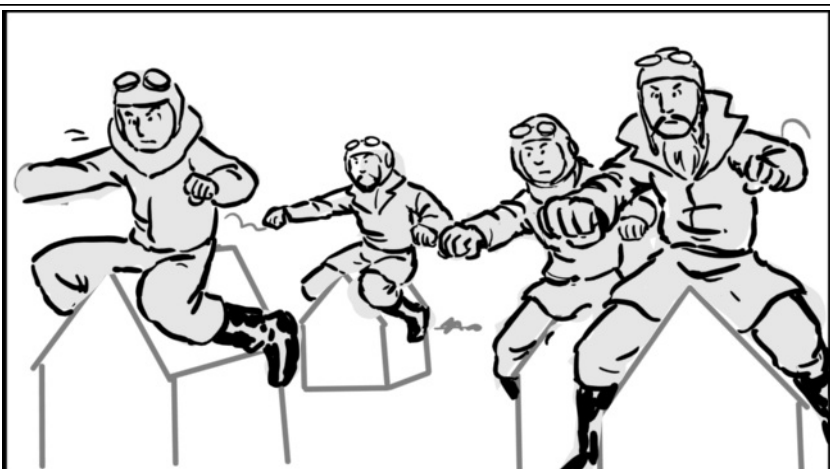

Action Notes  
 They all hear it REV UP. The pilots copy what Snoopy did and they hear their engines REV UP.

|       |       |
|-------|-------|
| Scene | Panel |
|       | 16    |

Action Notes

They all hear it REV UP. The pilots copy what Snoopy did and they hear their engines REV UP.



|       |       |
|-------|-------|
| Scene | Panel |
|       | 17    |

Action Notes

Snoopy heads off down the runway and takes off into the air. The other pilots do the same.

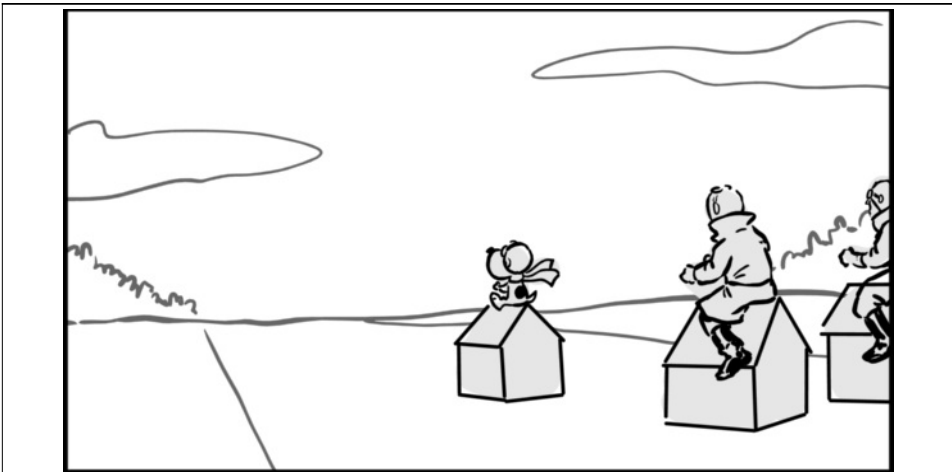

|       |       |
|-------|-------|
| Scene | Panel |
|       | 17    |

Action Notes

Snoopy heads off down the runway and takes off into the air. The other pilots do the same.

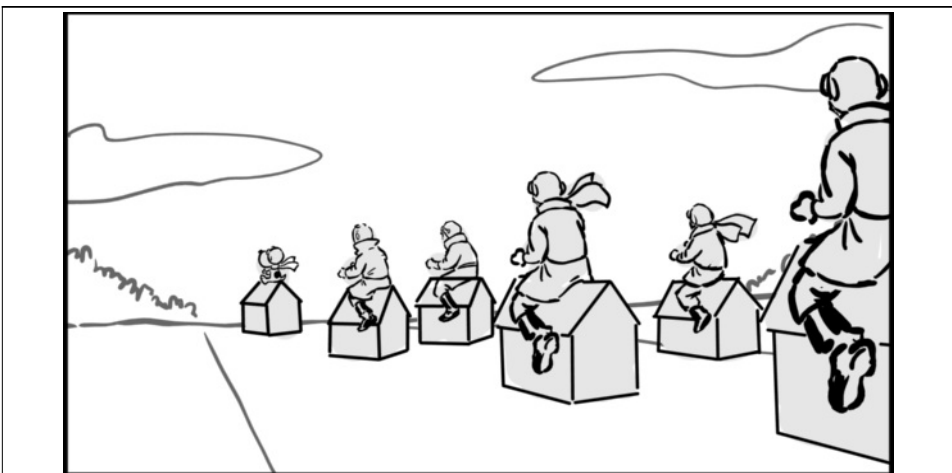

|       |       |
|-------|-------|
| Scene | Panel |
| 17    | 3     |

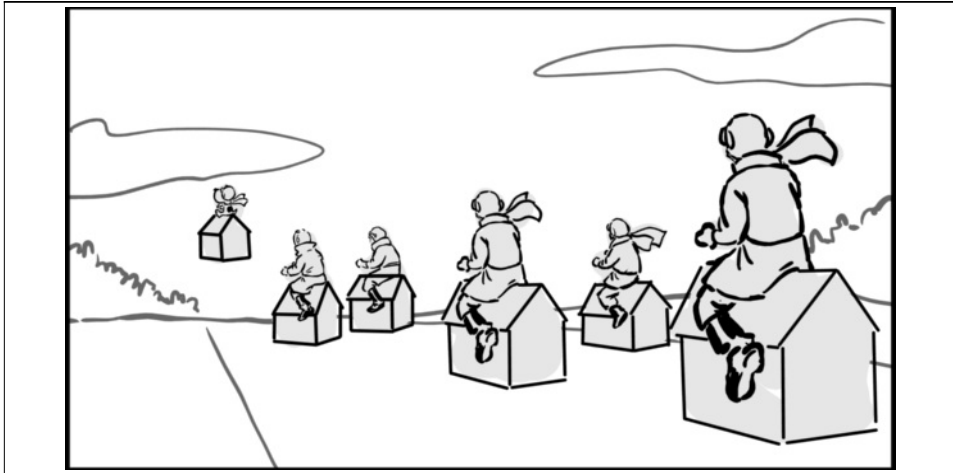

Action Notes  
 Snoopy heads off down the runway and takes off into the air. The other pilots do the same.

|       |       |
|-------|-------|
| Scene | Panel |
| 17    | 4     |

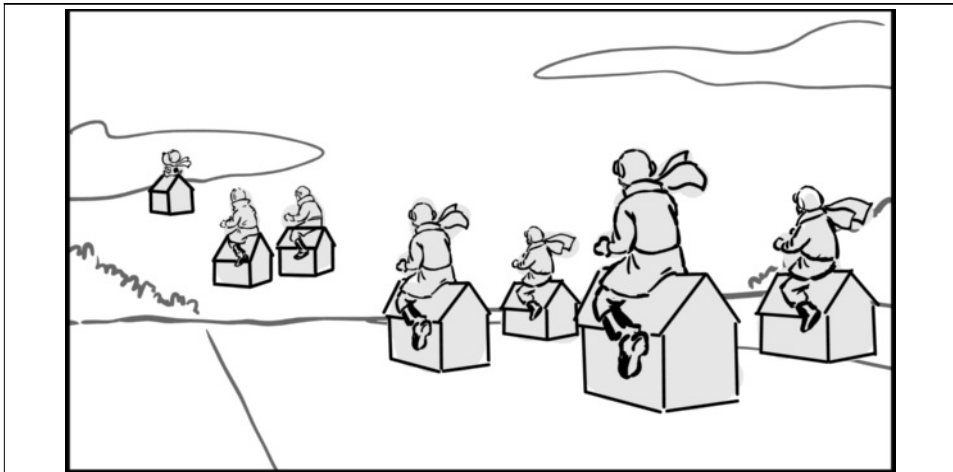

Action Notes  
 Snoopy heads off down the runway and takes off into the air. The other pilots do the same.

|       |       |
|-------|-------|
| Scene | Panel |
| 17    | 5     |

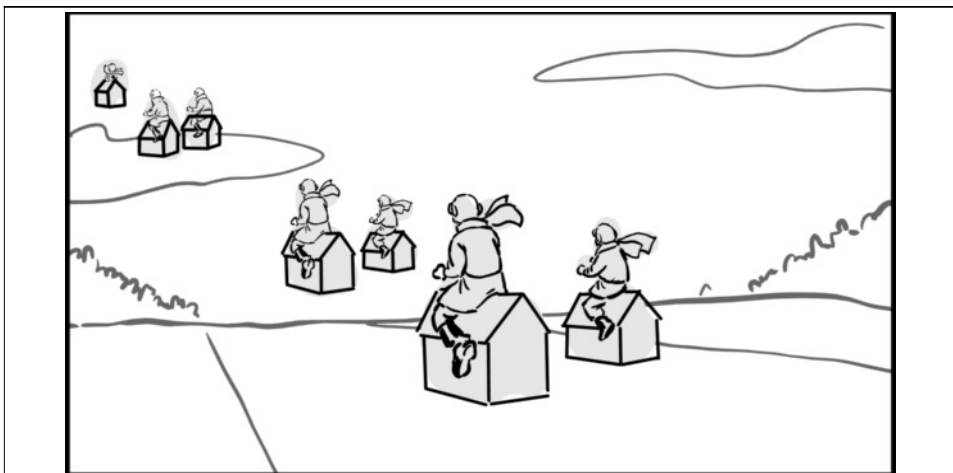

Action Notes  
 Snoopy heads off down the runway and takes off into the air. The other pilots do the same.

|       |       |
|-------|-------|
| Scene | Panel |
| 17    | 6     |

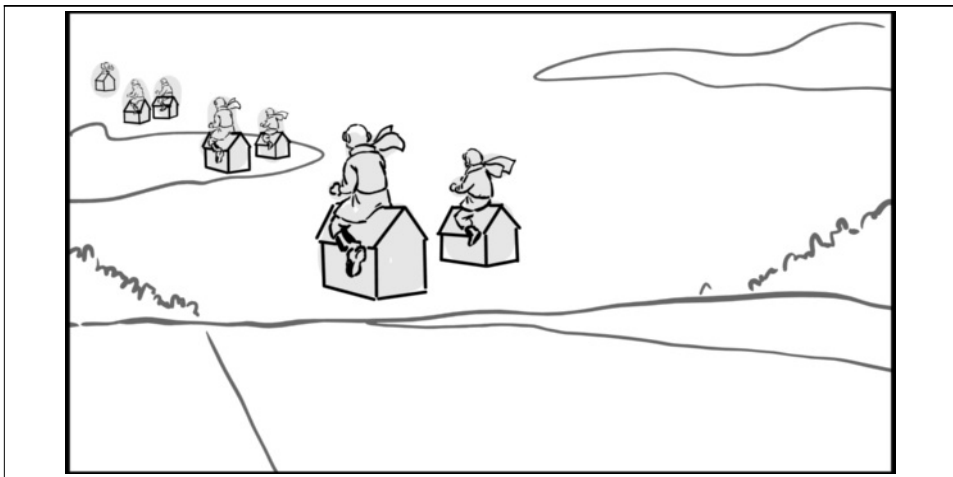

Action Notes

Snoopy heads off down the runway and takes off into the air. The other pilots do the same.

|       |       |
|-------|-------|
| Scene | Panel |
| 18    | 1     |

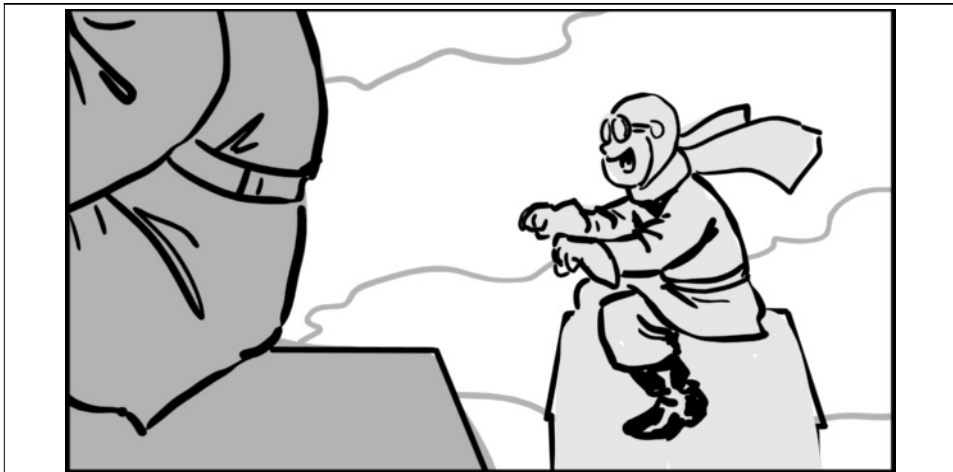

Dialog

141 WWI PILOT SMITH  
Ohmygod! They work! We're flying! But the peak is really riding up into my crack.

|       |       |
|-------|-------|
| Scene | Panel |
| 18    | 2     |

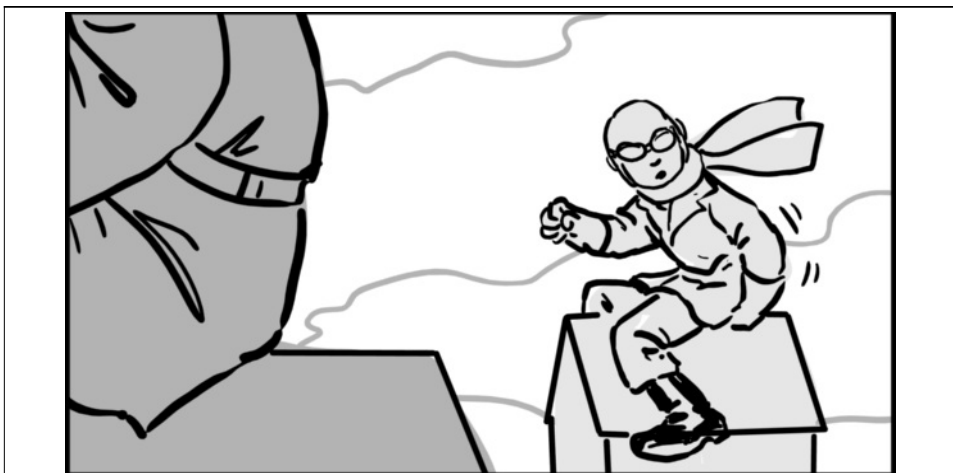

Dialog

141 WWI PILOT SMITH  
Ohmygod! They work! We're flying! But the peak is really riding up into my crack.

|       |       |
|-------|-------|
| Scene | Panel |
| 18    | 3     |

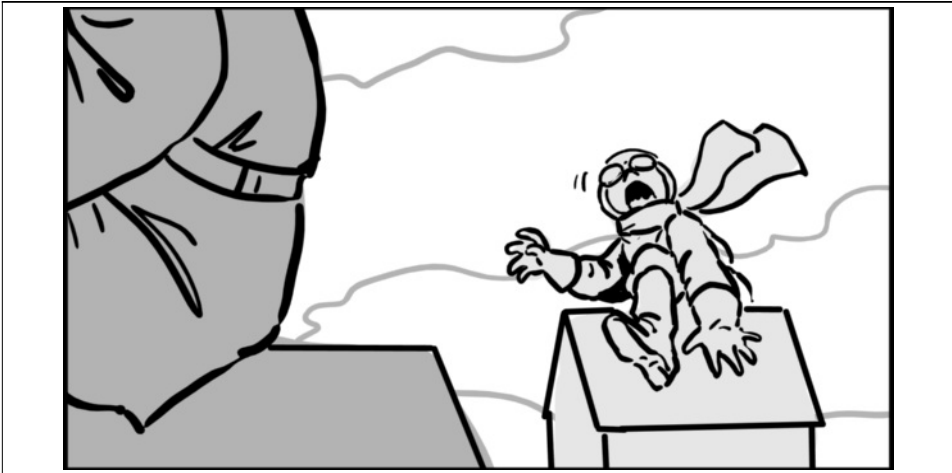

Action Notes  
The pilot shifts and slides off, FALLING to his death.

|       |       |
|-------|-------|
| Scene | Panel |
| 18    | 4     |

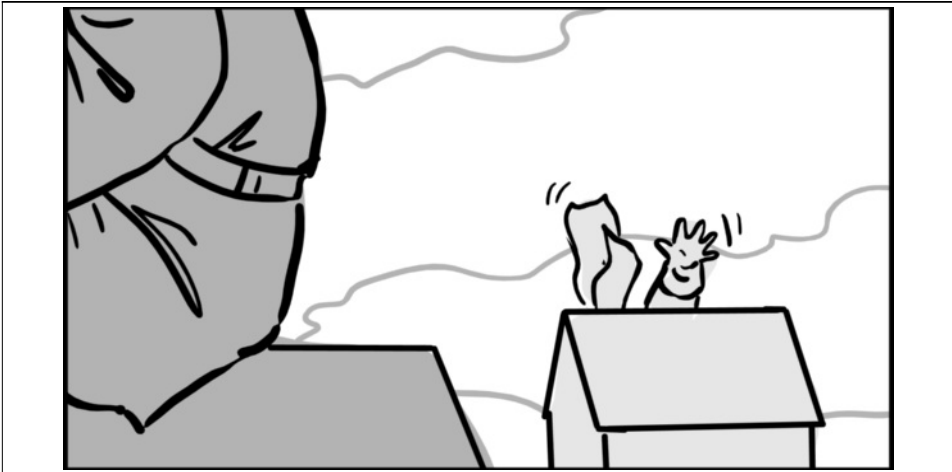

Action Notes  
The pilot shifts and slides off, FALLING to his death.

|       |       |
|-------|-------|
| Scene | Panel |
| 19    | 1     |



Dialog  
142 WWI PILOT SMITH (CONT'D) They also should have included seat beeeelllltsssss -- AAAAAHHHHH!

Action Notes  
The pilot shifts and slides off, FALLING to his death.

|       |       |
|-------|-------|
| Scene | Panel |
| 19    | 2     |

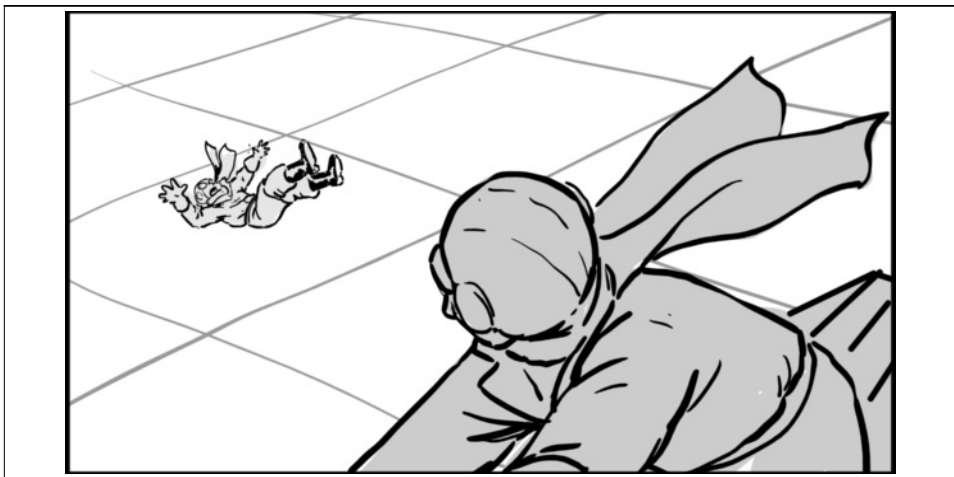

Dialog  
 142 WWI PILOT SMITH  
 (CONT'D) They also should  
 have included seat  
 beeeeIIllltsssss --  
 AAAAAAHHHHH!

Action Notes  
 The pilot shifts and slides off,  
 FALLING to his death.

|       |       |
|-------|-------|
| Scene | Panel |
| 19    | 3     |



Dialog  
 142 WWI PILOT SMITH  
 (CONT'D) They also should  
 have included seat  
 beeeeIIllltsssss --  
 AAAAAAHHHHH!

Action Notes  
 The pilot shifts and slides off,  
 FALLING to his death.

|       |       |
|-------|-------|
| Scene | Panel |
| 19    | 4     |

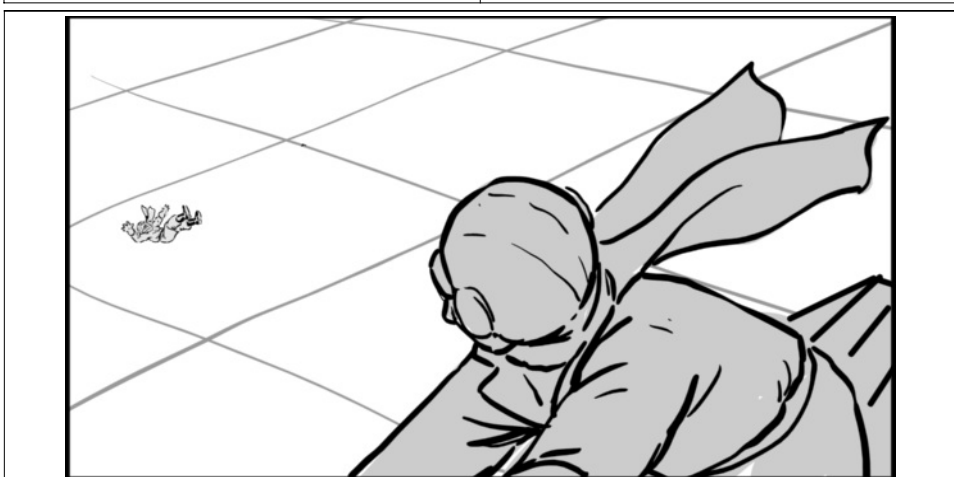

Dialog  
 142 WWI PILOT SMITH  
 (CONT'D) They also should  
 have included seat  
 beeeeIIllltsssss --  
 AAAAAAHHHHH!

Action Notes  
 The pilot shifts and slides off,  
 FALLING to his death.

|       |       |
|-------|-------|
| Scene | Panel |
| 20    | 1     |

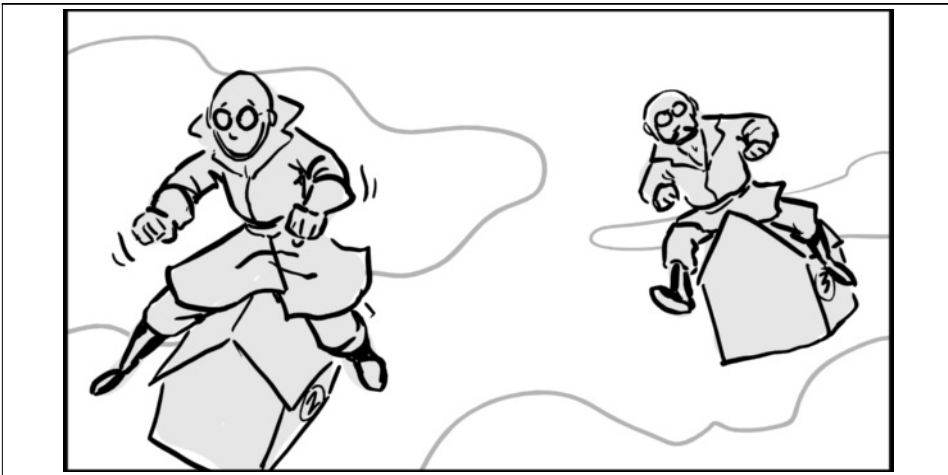

## Action Notes

EXT. SKY - CONTINUOUS  
Pilots #2 and #3 have trouble with their controls. They tilt up and down, back and forth. They spiral around toward each other then CRASH and EXPLODE.

|       |       |
|-------|-------|
| Scene | Panel |
| 20    | 2     |



## Action Notes

EXT. SKY - CONTINUOUS  
Pilots #2 and #3 have trouble with their controls. They tilt up and down, back and forth. They spiral around toward each other then CRASH and EXPLODE.

|       |       |
|-------|-------|
| Scene | Panel |
| 20    | 3     |

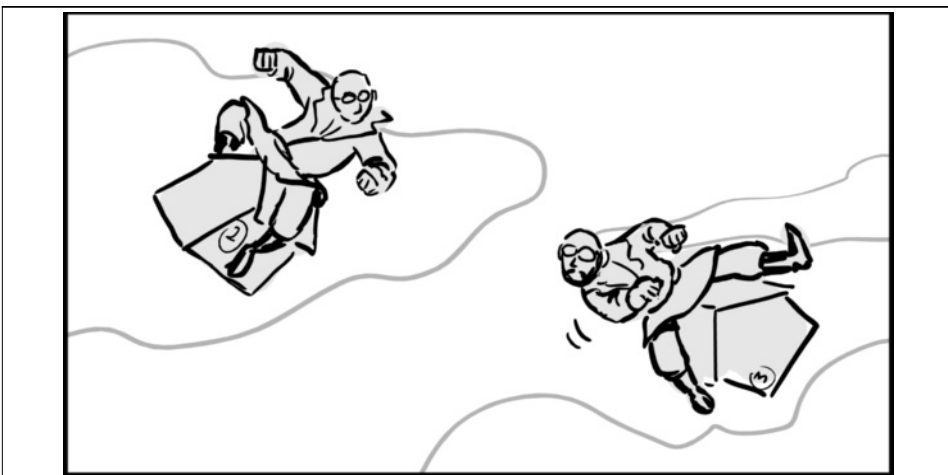

## Action Notes

EXT. SKY - CONTINUOUS  
Pilots #2 and #3 have trouble with their controls. They tilt up and down, back and forth. They spiral around toward each other then CRASH and EXPLODE.

|       |       |
|-------|-------|
| Scene | Panel |
| 20    | 4     |

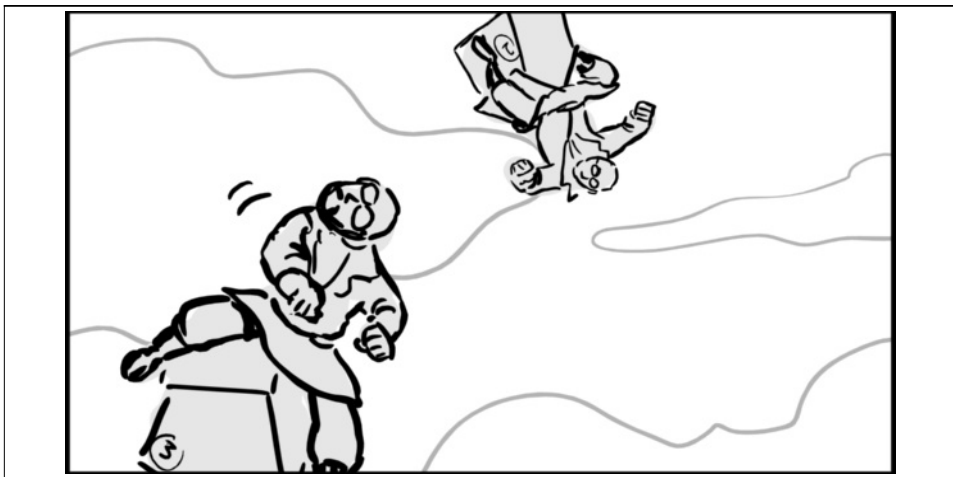

Action Notes

EXT. SKY - CONTINUOUS  
 Pilots #2 and #3 have trouble with their controls. They tilt up and down, back and forth. They spiral around toward each other then CRASH and EXPLODE.

|       |       |
|-------|-------|
| Scene | Panel |
| 20    | 5     |

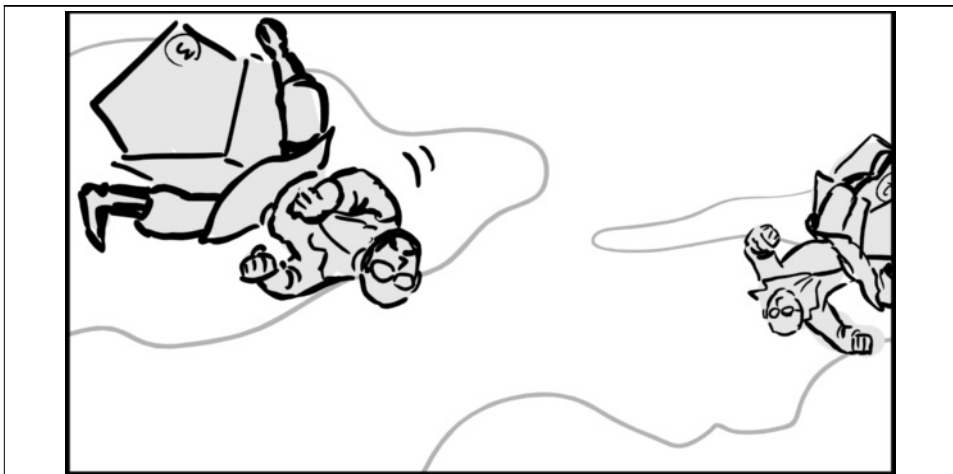

Action Notes

EXT. SKY - CONTINUOUS  
 Pilots #2 and #3 have trouble with their controls. They tilt up and down, back and forth. They spiral around toward each other then CRASH and EXPLODE.

|       |       |
|-------|-------|
| Scene | Panel |
| 20    | 6     |



Action Notes

EXT. SKY - CONTINUOUS  
 Pilots #2 and #3 have trouble with their controls. They tilt up and down, back and forth. They spiral around toward each other then CRASH and EXPLODE.



|       |       |
|-------|-------|
| Scene | Panel |
| 20    | 7     |

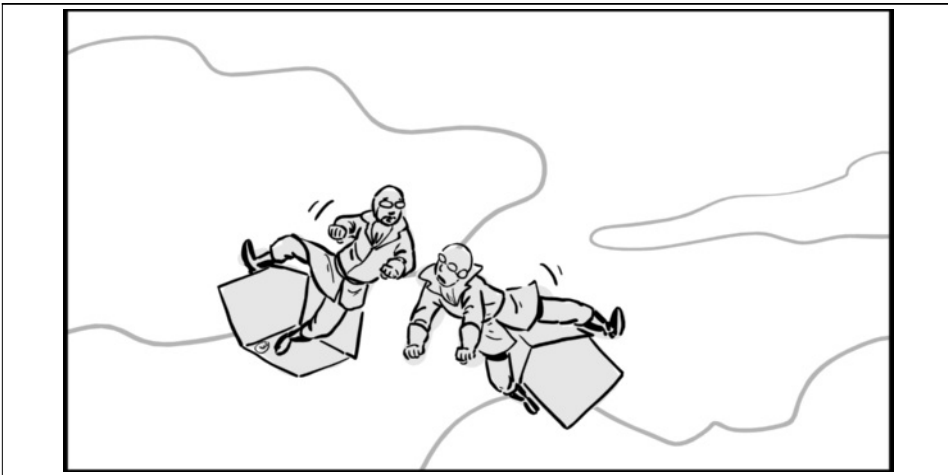

## Action Notes

EXT. SKY - CONTINUOUS  
Pilots #2 and #3 have trouble with their controls. They tilt up and down, back and forth. They spiral around toward each other then CRASH and EXPLODE.

|       |       |
|-------|-------|
| Scene | Panel |
| 20    | 8     |

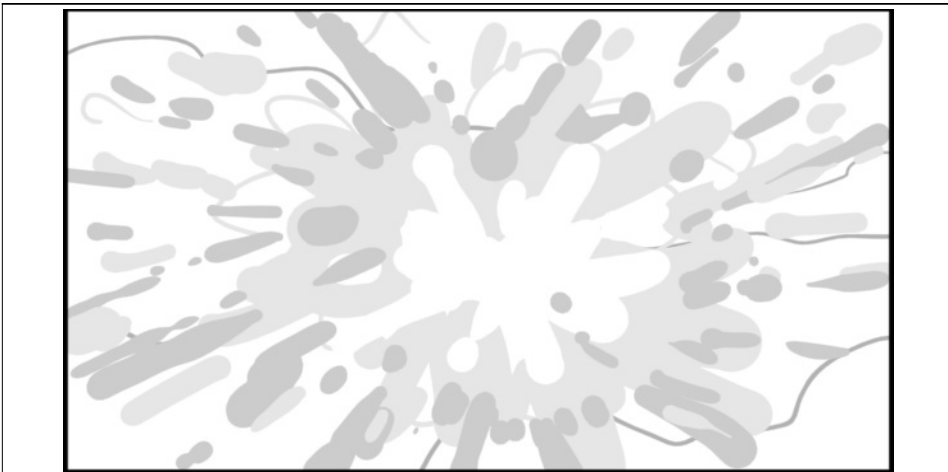

## Action Notes

EXT. SKY - CONTINUOUS  
Pilots #2 and #3 have trouble with their controls. They tilt up and down, back and forth. They spiral around toward each other then CRASH and EXPLODE.

|       |       |
|-------|-------|
| Scene | Panel |
| 21    | 1     |



## Action Notes

Pilot #4 gets the hang of it and seems comfortable.

|       |       |
|-------|-------|
| Scene | Panel |
| 21    | 2     |

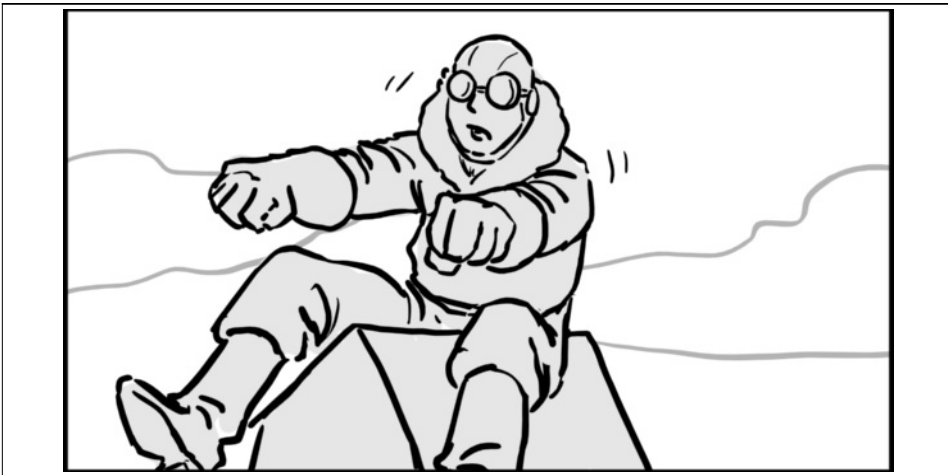

## Dialog

143 PILOT #4

I'm cool with these things not having wings but I'd feel better if we had windshields!

## Action Notes

Pilot #4 gets the hang of it and seems comfortable.

|       |       |
|-------|-------|
| Scene | Panel |
| 21    | 3     |



## Dialog

143 PILOT #4

I'm cool with these things not having wings but I'd feel better if we had windshields!

|       |       |
|-------|-------|
| Scene | Panel |
| 21    | 4     |

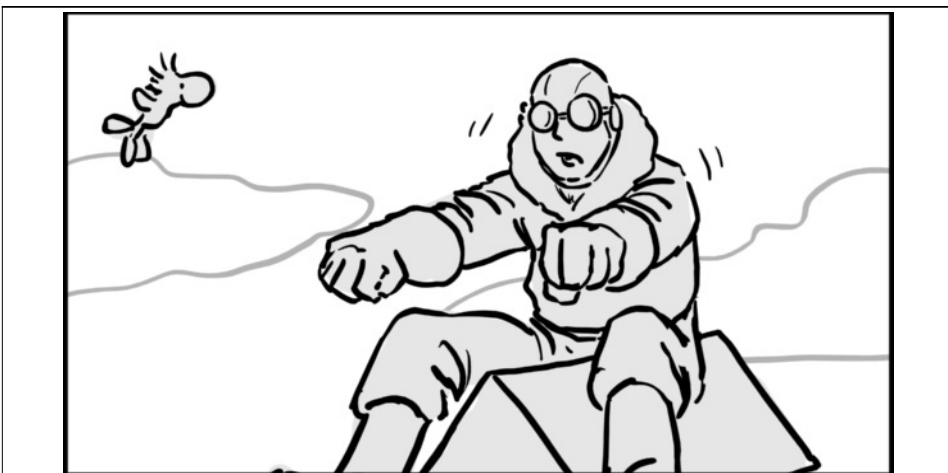

## Dialog

143 PILOT #4

I'm cool with these things not having wings but I'd feel better if we had windshields!

## Action Notes

He's STRUCK in the face by WOODSTOCK the bird. He loses control and the doghouse SPIRALS down and explodes.

|       |       |
|-------|-------|
| Scene | Panel |
| 21    | 5     |

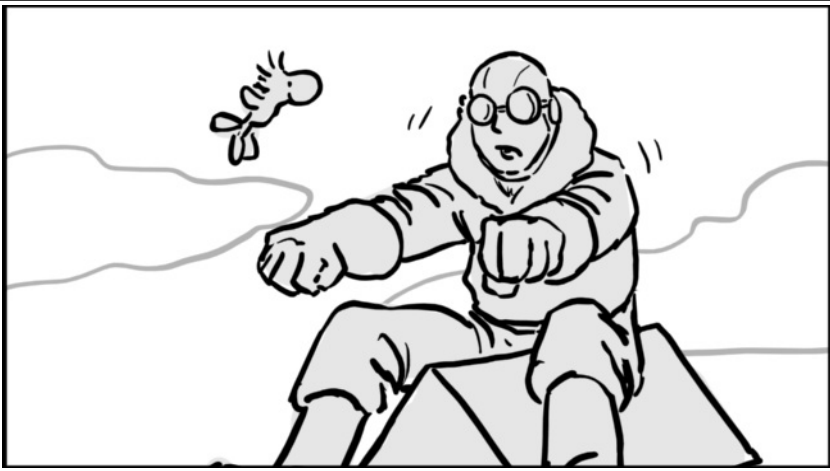

Action Notes

He's STRUCK in the face by WOODSTOCK the bird. He loses control and the doghouse SPIRALS down and explodes.

|       |       |
|-------|-------|
| Scene | Panel |
| 21    | 6     |



Action Notes

He's STRUCK in the face by WOODSTOCK the bird. He loses control and the doghouse SPIRALS down and explodes.

|       |       |
|-------|-------|
| Scene | Panel |
| 21    | 7     |



Action Notes

He's STRUCK in the face by WOODSTOCK the bird. He loses control and the doghouse SPIRALS down and explodes.

|       |       |
|-------|-------|
| Scene | Panel |
| 22    | 1     |

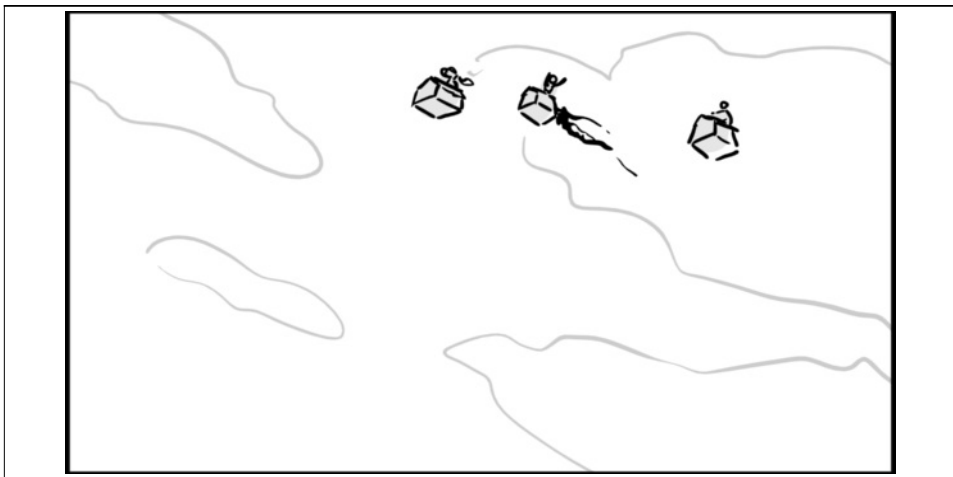

Action Notes  
 He's STRUCK in the face by WOODSTOCK the bird. He loses control and the doghouse SPIRALS down and explodes.

|       |       |
|-------|-------|
| Scene | Panel |
| 22    | 2     |

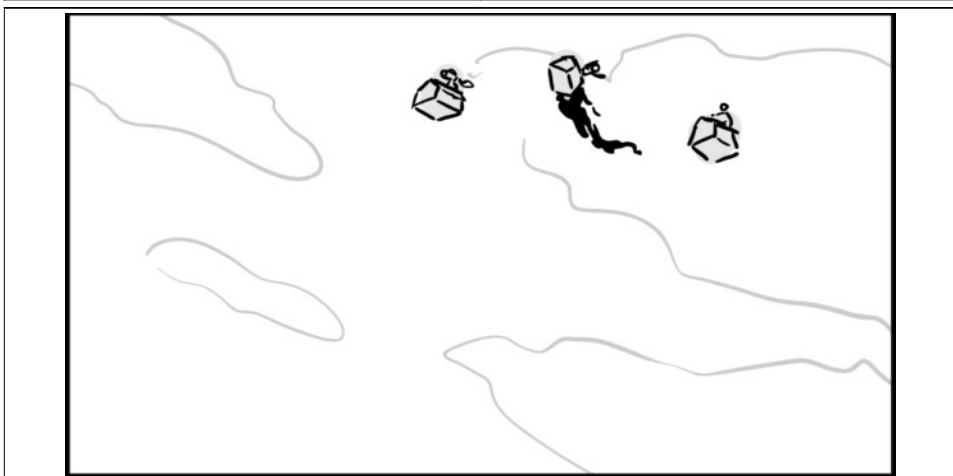

Action Notes  
 He's STRUCK in the face by WOODSTOCK the bird. He loses control and the doghouse SPIRALS down and explodes.

|       |       |
|-------|-------|
| Scene | Panel |
| 22    | 3     |

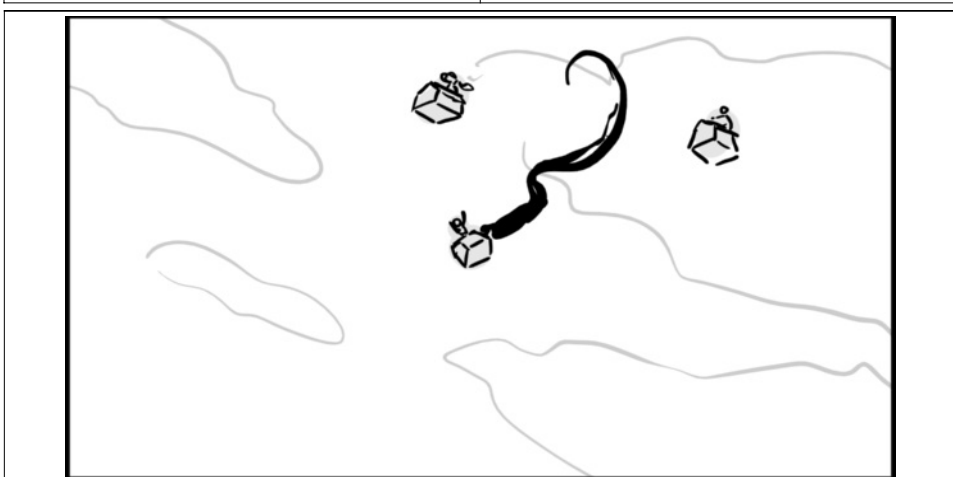

Action Notes  
 He's STRUCK in the face by WOODSTOCK the bird. He loses control and the doghouse SPIRALS down and explodes.

|       |       |
|-------|-------|
| Scene | Panel |
| 22    | 4     |



Action Notes

He's STRUCK in the face by WOODSTOCK the bird. He loses control and the doghouse SPIRALS down and explodes.

|       |       |
|-------|-------|
| Scene | Panel |
| 23    | 1     |



Action Notes

Pilot #5 is too terrified to move, eyes bugging out and jaw clenched. He holds perfectly still, going in a straight line until he vanishes in the distance.

|       |       |
|-------|-------|
| Scene | Panel |
| 23    | 2     |



Action Notes

Pilot #5 is too terrified to move, eyes bugging out and jaw clenched. He holds perfectly still, going in a straight line until he vanishes in the distance.

|       |       |
|-------|-------|
| Scene | Panel |
| 23    | 3     |



## Action Notes

Pilot #5 is too terrified to move, eyes bugging out and jaw clenched. He holds perfectly still, going in a straight line until he vanishes in the distance.

|       |       |
|-------|-------|
| Scene | Panel |
| 23    | 4     |



## Action Notes

Pilot #5 is too terrified to move, eyes bugging out and jaw clenched. He holds perfectly still, going in a straight line until he vanishes in the distance.

|       |       |
|-------|-------|
| Scene | Panel |
| 23    | 5     |



## Action Notes

Pilot #5 is too terrified to move, eyes bugging out and jaw clenched. He holds perfectly still, going in a straight line until he vanishes in the distance.

|       |       |
|-------|-------|
| Scene | Panel |
| 23    | 6     |



## Action Notes

Pilot #5 is too terrified to move, eyes bugging out and jaw clenched. He holds perfectly still, going in a straight line until he vanishes in the distance.

|       |       |
|-------|-------|
| Scene | Panel |
| 23    | 7     |



## Action Notes

Pilot #5 is too terrified to move, eyes bugging out and jaw clenched. He holds perfectly still, going in a straight line until he vanishes in the distance.

|       |       |
|-------|-------|
| Scene | Panel |
| 23    | 8     |



## Action Notes

Pilot #5 is too terrified to move, eyes bugging out and jaw clenched. He holds perfectly still, going in a straight line until he vanishes in the distance.

|       |       |
|-------|-------|
| Scene | Panel |
| 23    | 9     |

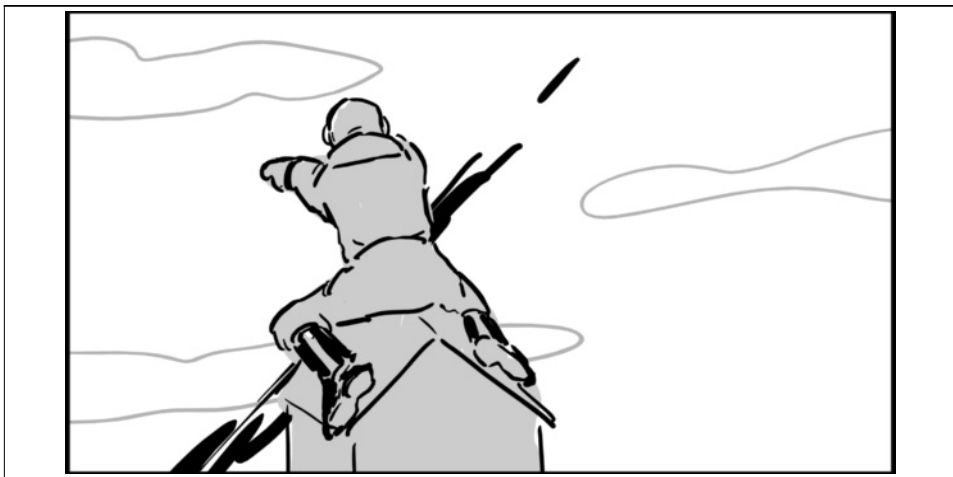

Action Notes

Pilot #5 is too terrified to move, eyes bugging out and jaw clenched. He holds perfectly still, going in a straight line until he vanishes in the distance.

|       |       |
|-------|-------|
| Scene | Panel |
| 23    | 10    |

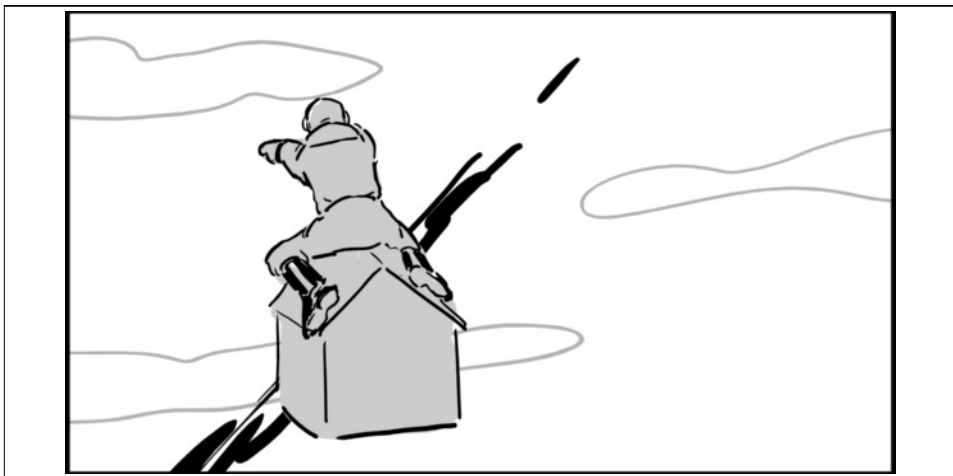

Action Notes

Pilot #5 is too terrified to move, eyes bugging out and jaw clenched. He holds perfectly still, going in a straight line until he vanishes in the distance.

|       |       |
|-------|-------|
| Scene | Panel |
| 23    | 11    |

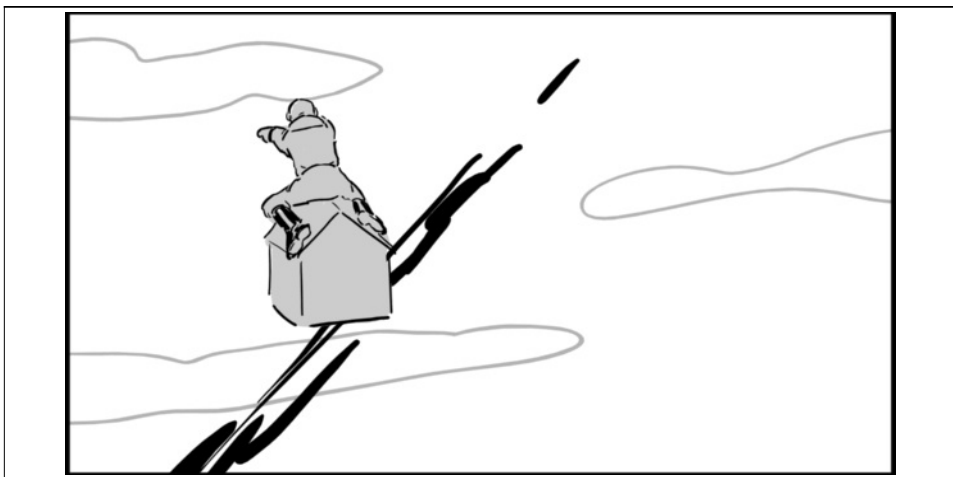

Action Notes

Pilot #5 is too terrified to move, eyes bugging out and jaw clenched. He holds perfectly still, going in a straight line until he vanishes in the distance.



|       |       |
|-------|-------|
| Scene | Panel |
| 23    | 12    |

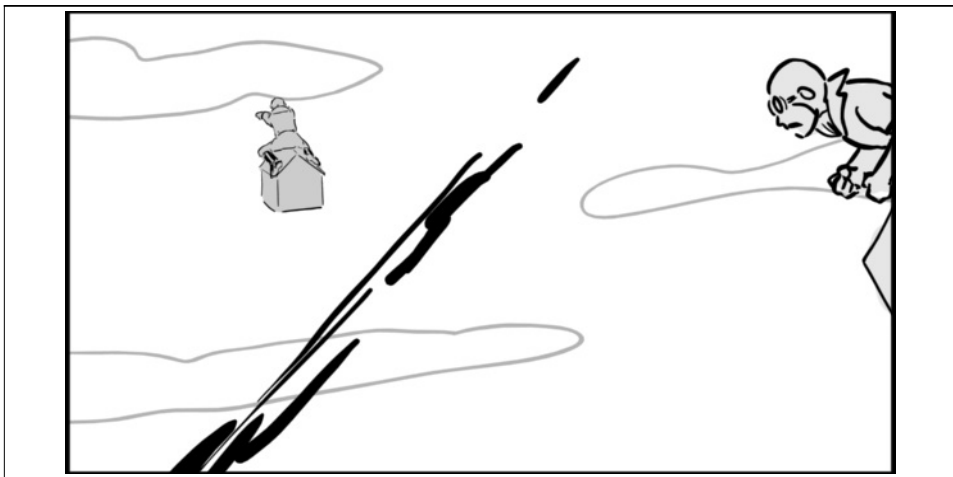

Action Notes

Pilot #5 is too terrified to move, eyes bugging out and jaw clenched. He holds perfectly still, going in a straight line until he vanishes in the distance. Pilot Jones masters his controls and is doing pretty good. He zips around in the air like a pro.

|       |       |
|-------|-------|
| Scene | Panel |
| 23    | 13    |

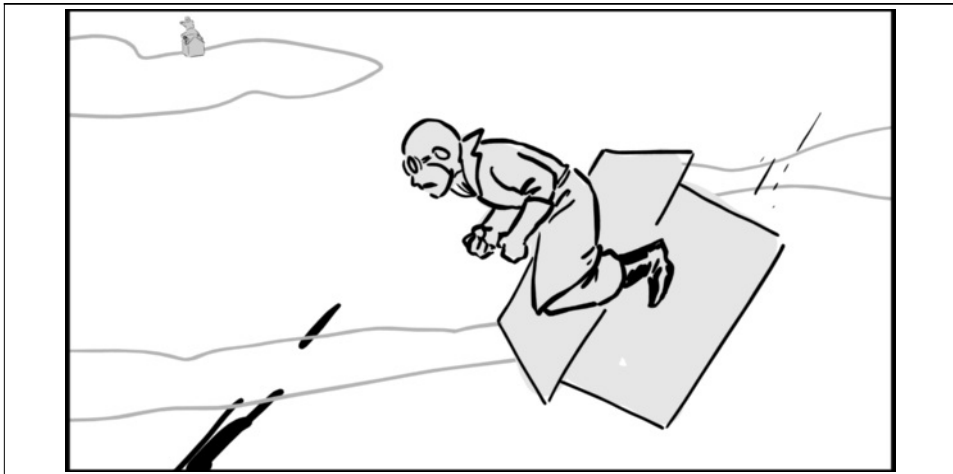

Action Notes

Pilot Jones masters his controls and is doing pretty good. He zips around in the air like a pro.

|       |       |
|-------|-------|
| Scene | Panel |
| 23    | 14    |



Action Notes

Pilot Jones masters his controls and is doing pretty good. He zips around in the air like a pro.

|       |       |
|-------|-------|
| Scene | Panel |
| 23    | 15    |

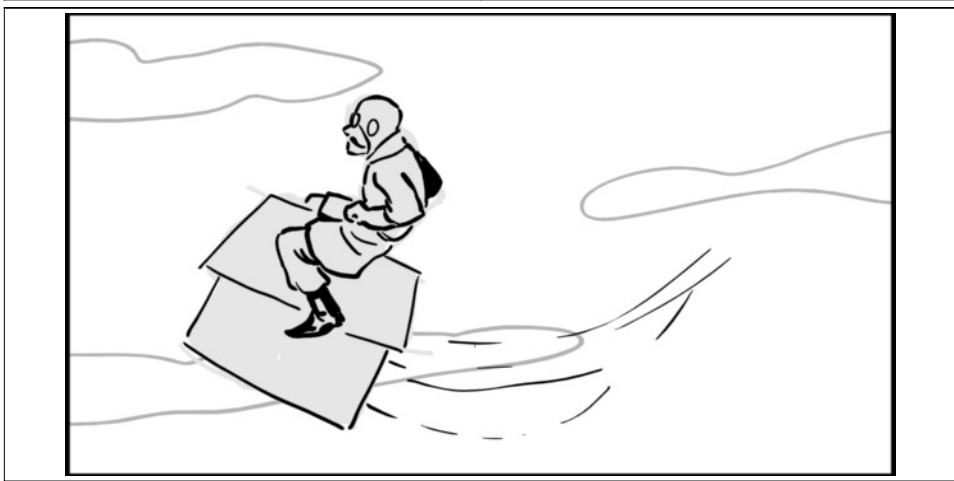

**Action Notes**  
 Pilot Jones masters his controls and is doing pretty good. He zips around in the air like a pro.

|       |       |
|-------|-------|
| Scene | Panel |
| 23    | 16    |

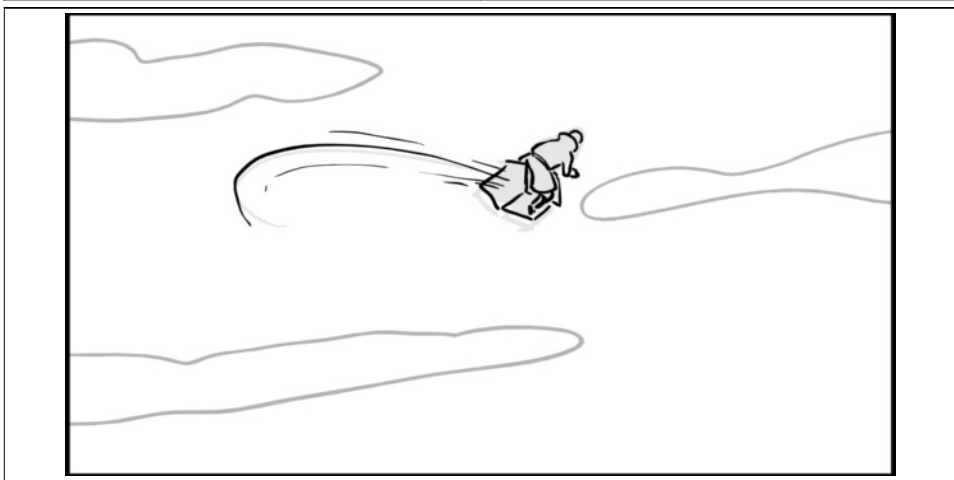

**Action Notes**  
 Pilot Jones masters his controls and is doing pretty good. He zips around in the air like a pro.

|       |       |
|-------|-------|
| Scene | Panel |
| 23    | 17    |

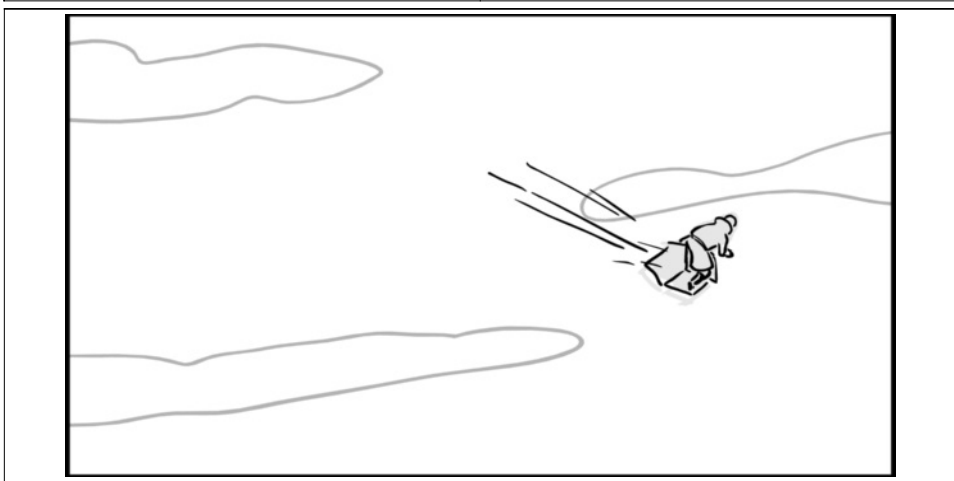

**Action Notes**  
 Pilot Jones masters his controls and is doing pretty good. He zips around in the air like a pro.

|       |       |
|-------|-------|
| Scene | Panel |
| 24    | 1     |



Action Notes  
EXT. AIRFIELD - DAY  
The CO watches this from the ground.

|       |       |
|-------|-------|
| Scene | Panel |
| 24    | 2     |



Action Notes  
EXT. AIRFIELD - DAY  
The CO watches this from the ground.

|       |       |
|-------|-------|
| Scene | Panel |
| 24    | 3     |

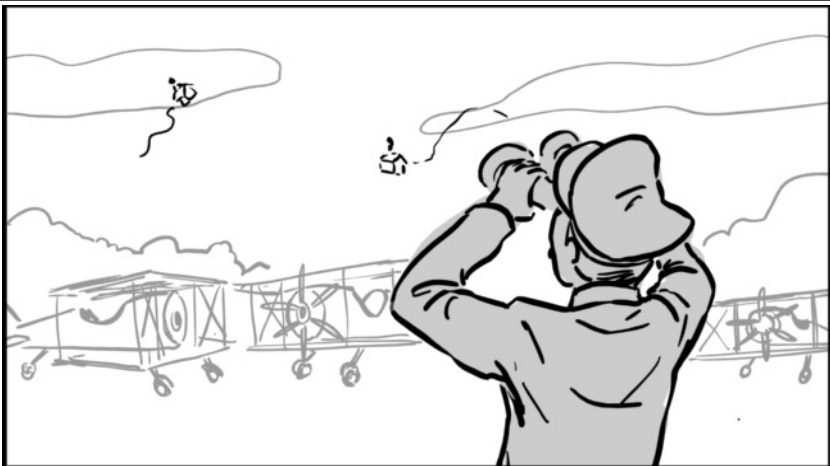

Action Notes  
EXT. AIRFIELD - DAY  
The CO watches this from the ground.

|       |       |
|-------|-------|
| Scene | Panel |
| 24    | 4     |



Dialog  
 144 AIR FORCE  
 COMMANDING OFFICER That sonofabitch is actually doing it! But we're gonna need more Marines. And maybe some seatbelts.

Action Notes  
 EXT. AIRFIELD - DAY  
 The CO watches this from the ground.

|       |       |
|-------|-------|
| Scene | Panel |
| 25    | 1     |



Dialog  
 145 AIR FORCE  
 COMMANDING OFFICER The Red Baron is leading a squadron toward Allied territory. Now get up there and show 'em what we got!

Action Notes  
 EXT. AIRFIELD - DAY - LATER  
 Snoopy, the CO, and new pilots are in front of the hangar.

|       |       |
|-------|-------|
| Scene | Panel |
| 25    | 2     |



Dialog  
 145 AIR FORCE  
 COMMANDING OFFICER The Red Baron is leading a squadron toward Allied territory. Now get up there and show 'em what we got!

|       |       |   |
|-------|-------|---|
| Scene | Panel |   |
|       | 25    | 3 |

Dialog  
 145 AIR FORCE  
 COMMANDING OFFICER The Red Baron is leading a squadron toward Allied territory. Now get up there and show 'em what we got!

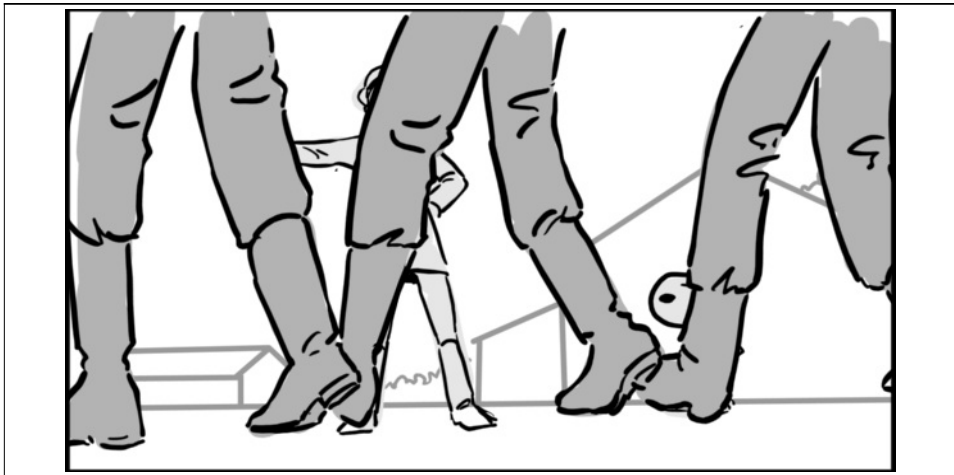

Action Notes  
 The men and Snoopy all run to their doghouses, start them up and take off into the sky.

|       |       |   |
|-------|-------|---|
| Scene | Panel |   |
|       | 25    | 4 |

Action Notes  
 The men and Snoopy all run to their doghouses, start them up and take off into the sky.

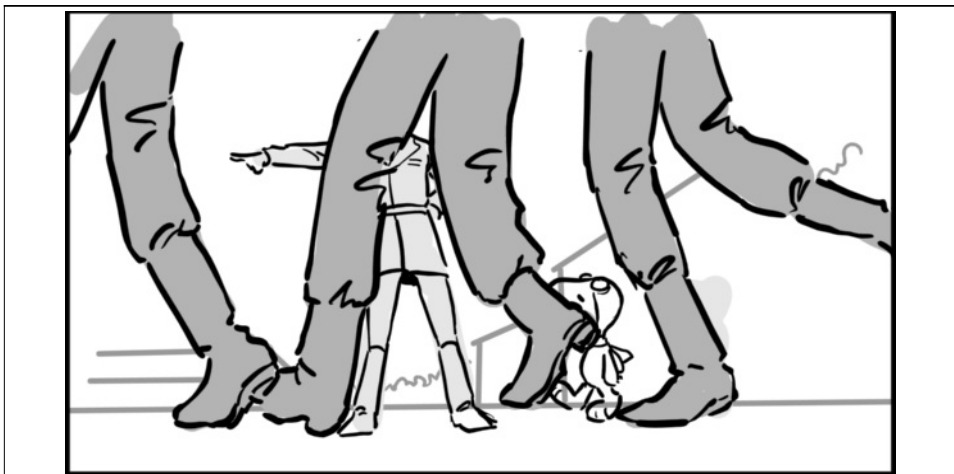

|       |       |   |
|-------|-------|---|
| Scene | Panel |   |
|       | 25    | 5 |

Action Notes  
 The men and Snoopy all run to their doghouses, start them up and take off into the sky.

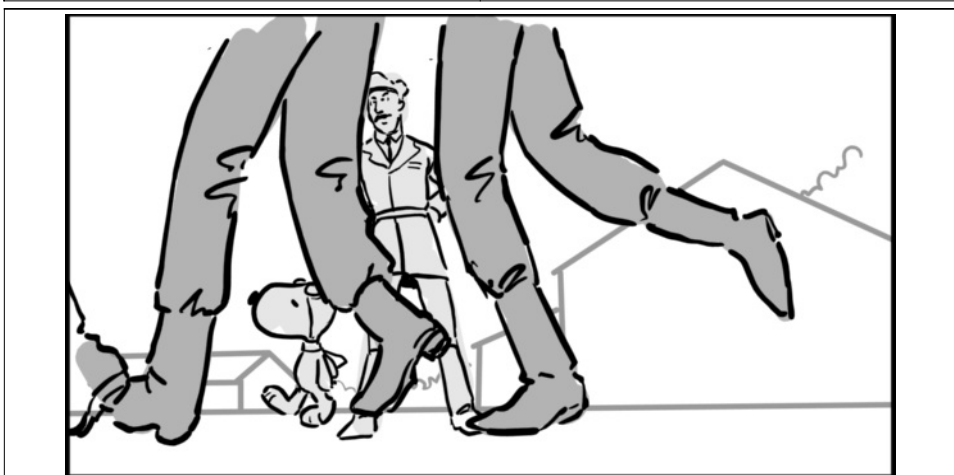

|       |       |
|-------|-------|
| Scene | Panel |
| 25    | 6     |

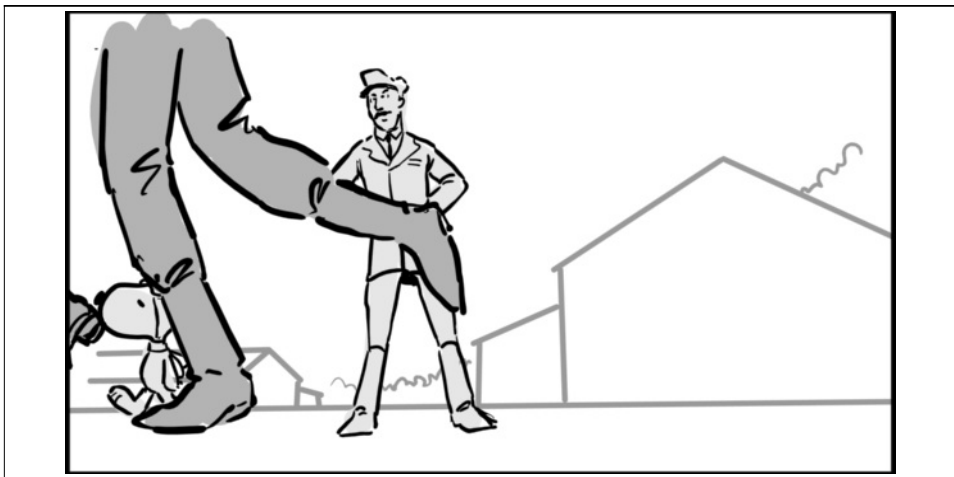

Action Notes

The men and Snoopy all run to their doghouses, start them up and take off into the sky.

|       |       |
|-------|-------|
| Scene | Panel |
| 26    | 1     |

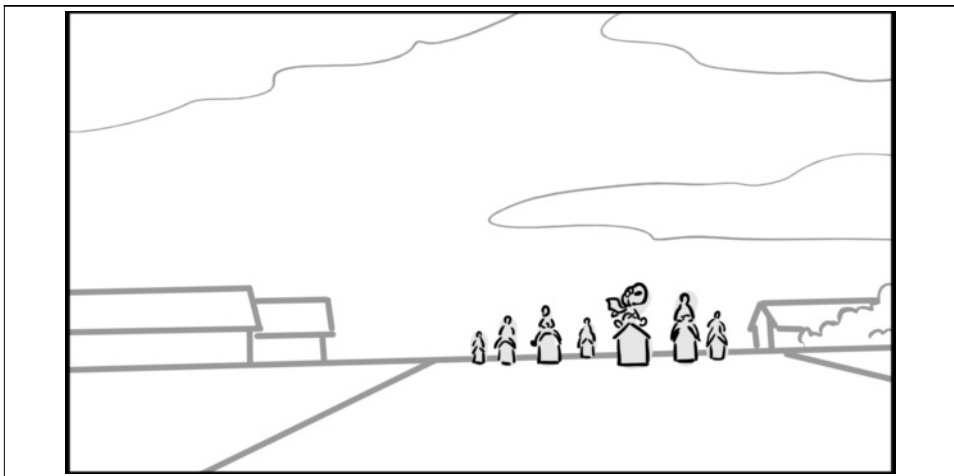

Action Notes

The men and Snoopy all run to their doghouses, start them up and take off into the sky.

|       |       |
|-------|-------|
| Scene | Panel |
| 26    | 2     |

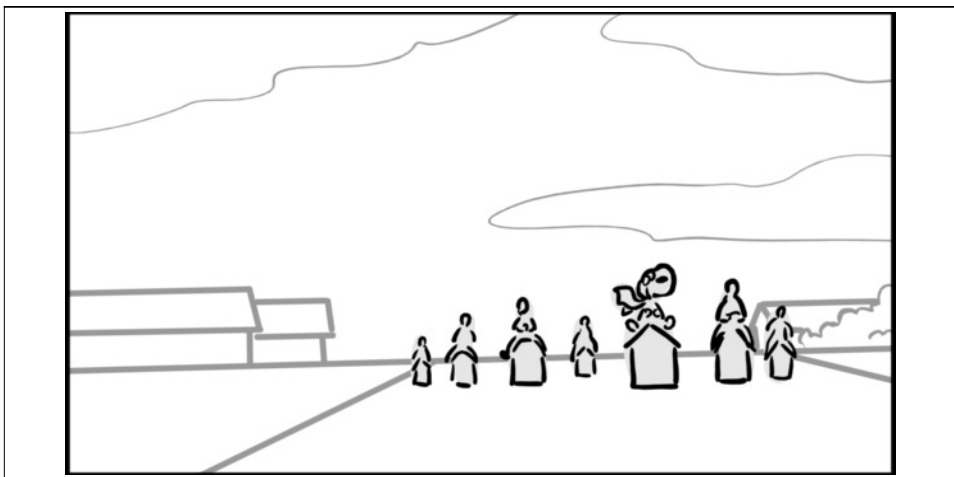

Action Notes

The men and Snoopy all run to their doghouses, start them up and take off into the sky.

|       |    |       |   |
|-------|----|-------|---|
| Scene |    | Panel |   |
|       | 26 |       | 3 |

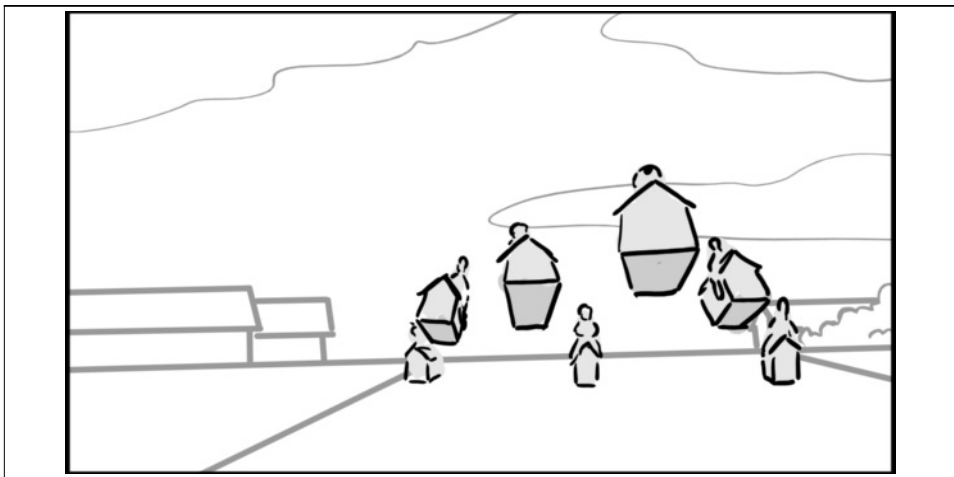

**Action Notes**  
 The men and Snoopy all run to their doghouses, start them up and take off into the sky.

|       |    |       |   |
|-------|----|-------|---|
| Scene |    | Panel |   |
|       | 26 |       | 4 |

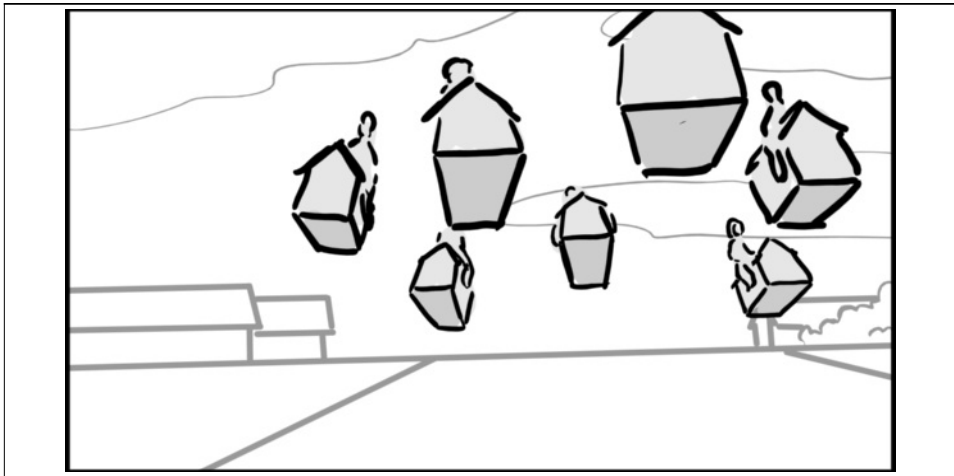

**Action Notes**  
 The men and Snoopy all run to their doghouses, start them up and take off into the sky.

|       |    |       |   |
|-------|----|-------|---|
| Scene |    | Panel |   |
|       | 26 |       | 5 |

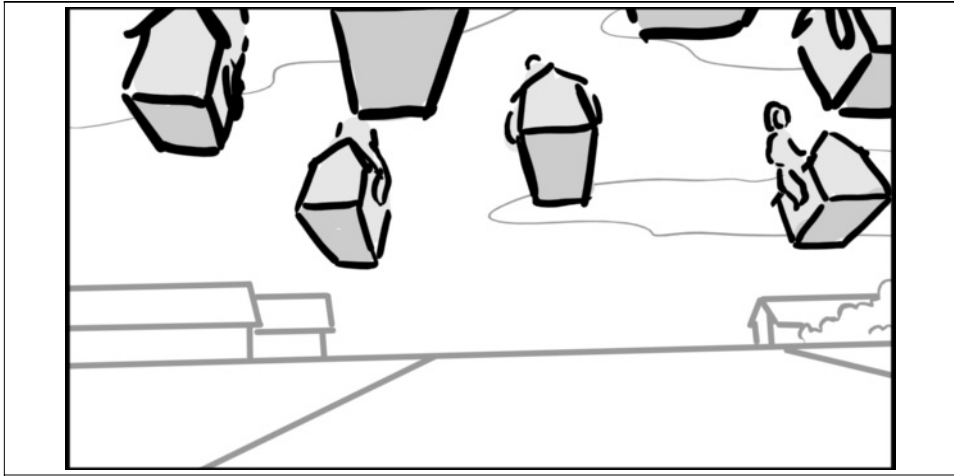

**Action Notes**  
 The men and Snoopy all run to their doghouses, start them up and take off into the sky.

|       |       |
|-------|-------|
| Scene | Panel |
| 26    | 6     |

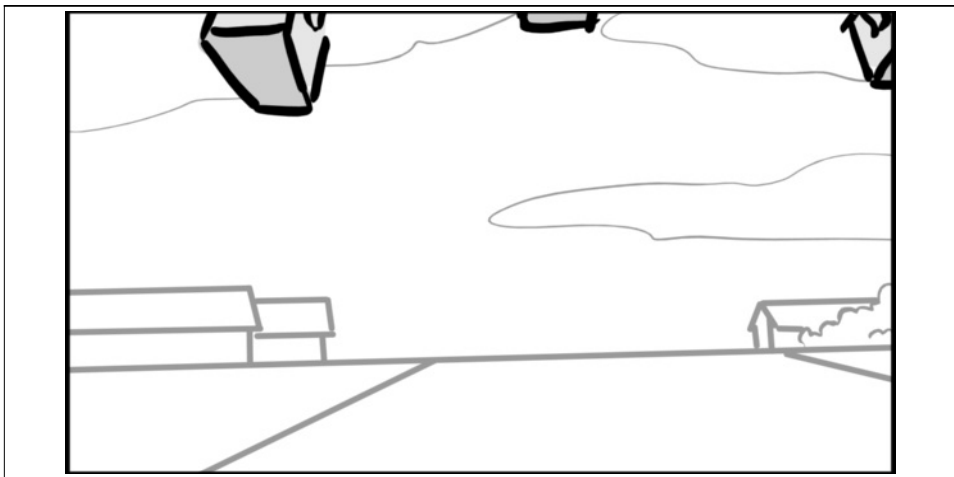

Action Notes

The men and Snoopy all run to their doghouses, start them up and take off into the sky.

|       |       |
|-------|-------|
| Scene | Panel |
| 27    | 1     |



Action Notes

EXT. SKY - DAY  
Snoopy leads the squadron in a V formation. He motions to the other pilots.

|       |       |
|-------|-------|
| Scene | Panel |
| 28    | 1     |

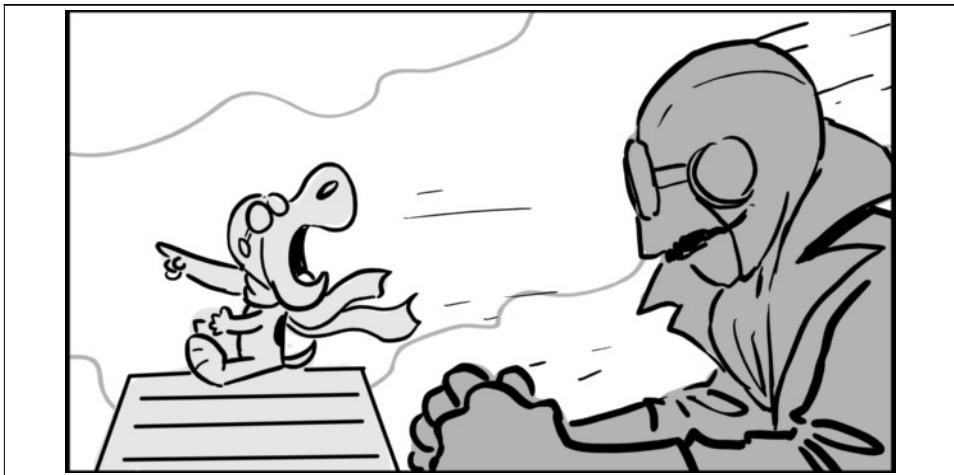

Dialog

146 SNOOPY  
Grrrrrrr! Bleeaaaaahhh bleah blah.



|       |       |
|-------|-------|
| Scene | Panel |
| 28    | 2     |

Dialog  
147 WWI PILOT JONES Sir!  
Yes sir!

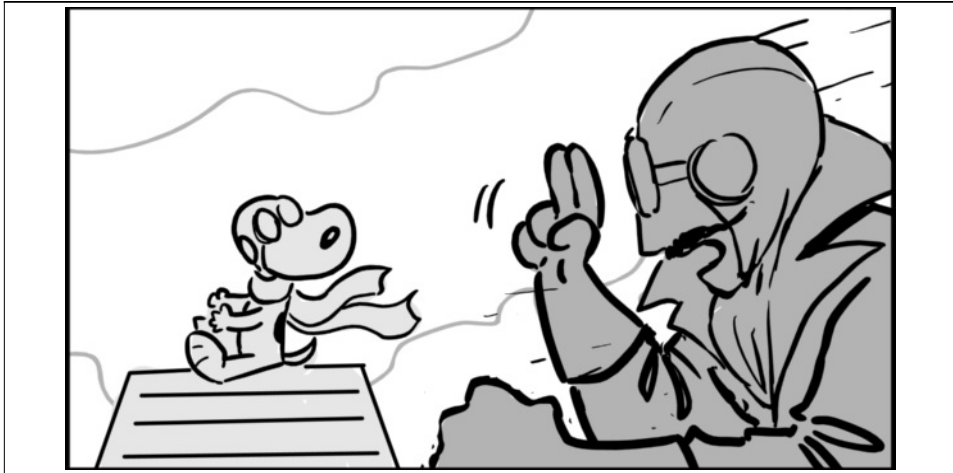

|       |       |
|-------|-------|
| Scene | Panel |
| 28    | 3     |

Dialog  
(under his breath)  
Whatever the fuck you just  
said.

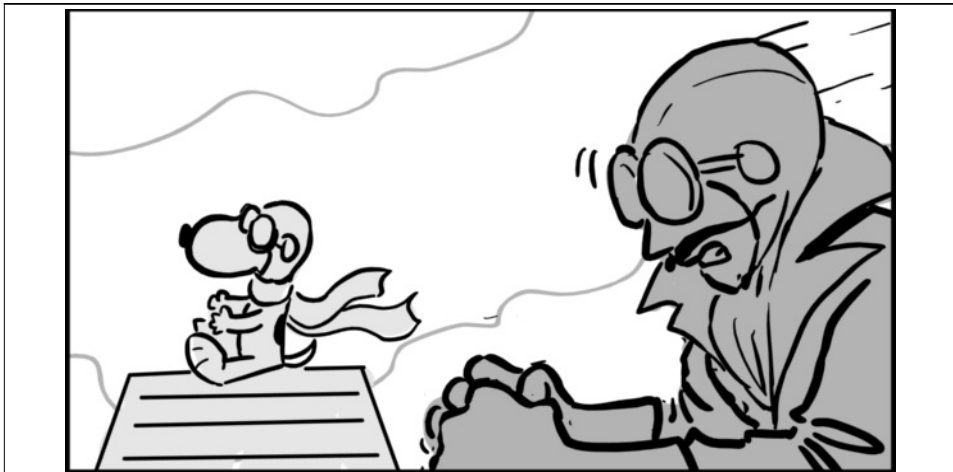

|       |       |
|-------|-------|
| Scene | Panel |
| 28    | 4     |

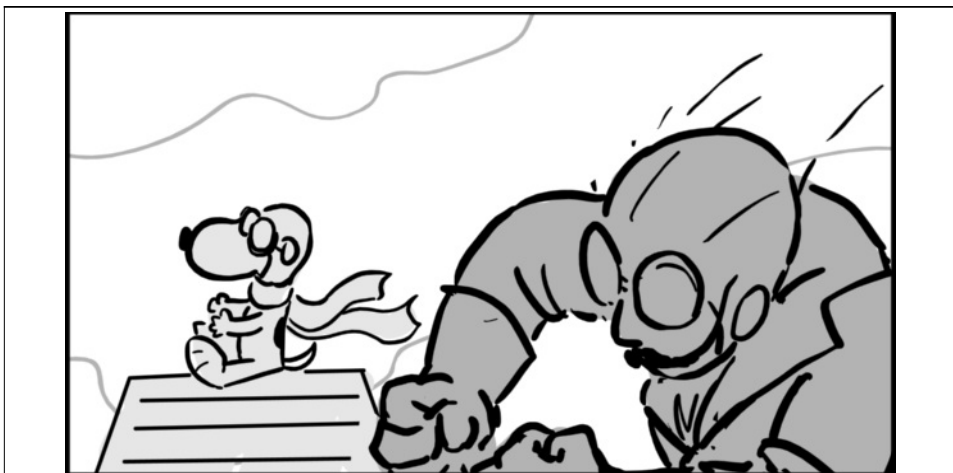

|       |       |
|-------|-------|
| Scene | Panel |
| 28    | 5     |

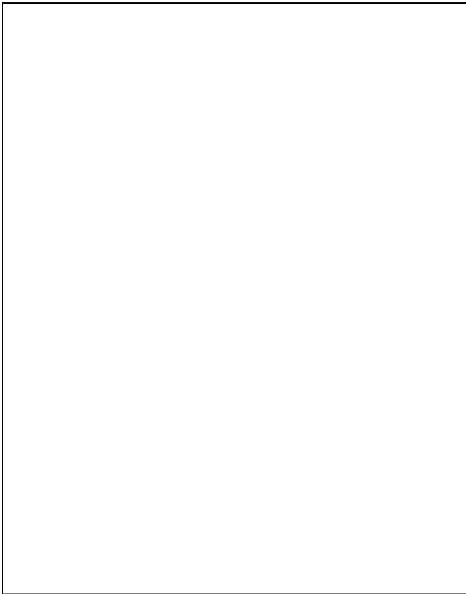

|       |       |
|-------|-------|
| Scene | Panel |
| 28    | 6     |

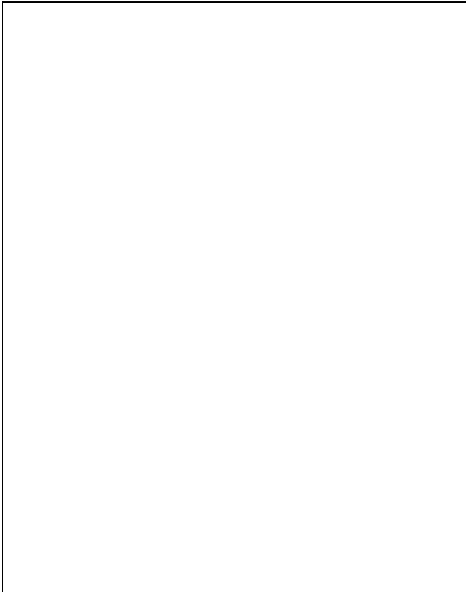

|       |       |
|-------|-------|
| Scene | Panel |
| 29    | 1     |



Action Notes  
Snoopy P.O.V. - In the distance a handful of planes come into view, led by the Red Baron in his FOKKER DR1 DREIDECKER. The other planes are PHÖNIX D.l's, piloted by CATS!

|       |       |
|-------|-------|
| Scene | Panel |
| 30    | 1     |

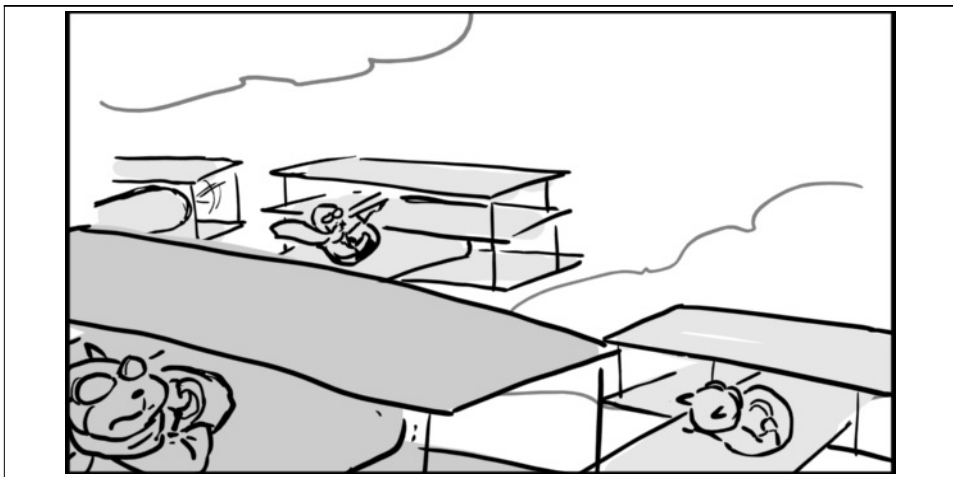

Action Notes  
 led by the Red Baron in his FOKKER DR1 DREIDECKER. The other planes are PHÖNIX D.I's, piloted by CATS!

|       |       |
|-------|-------|
| Scene | Panel |
| 30    | 2     |

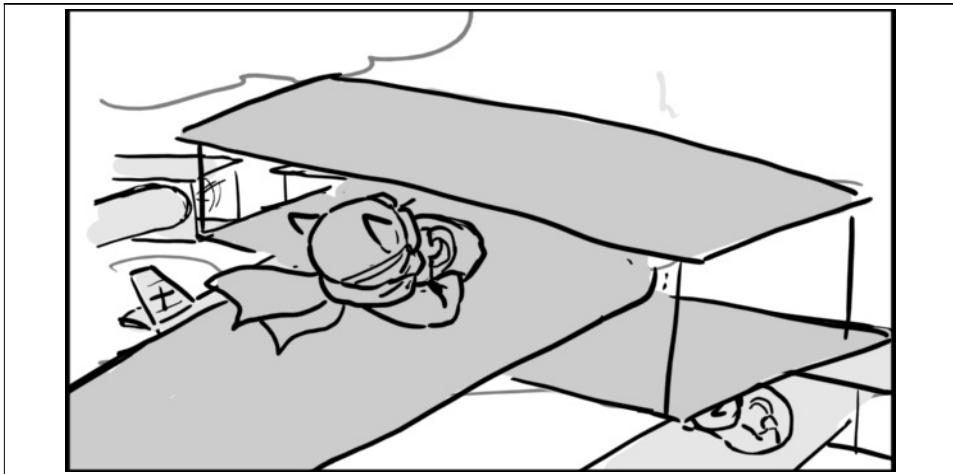

Action Notes  
 led by the Red Baron in his FOKKER DR1 DREIDECKER. The other planes are PHÖNIX D.I's, piloted by CATS!

|       |       |
|-------|-------|
| Scene | Panel |
| 30    | 3     |



Action Notes  
 led by the Red Baron in his FOKKER DR1 DREIDECKER. The other planes are PHÖNIX D.I's, piloted by CATS!

|       |       |
|-------|-------|
| Scene | Panel |
| 30    | 4     |

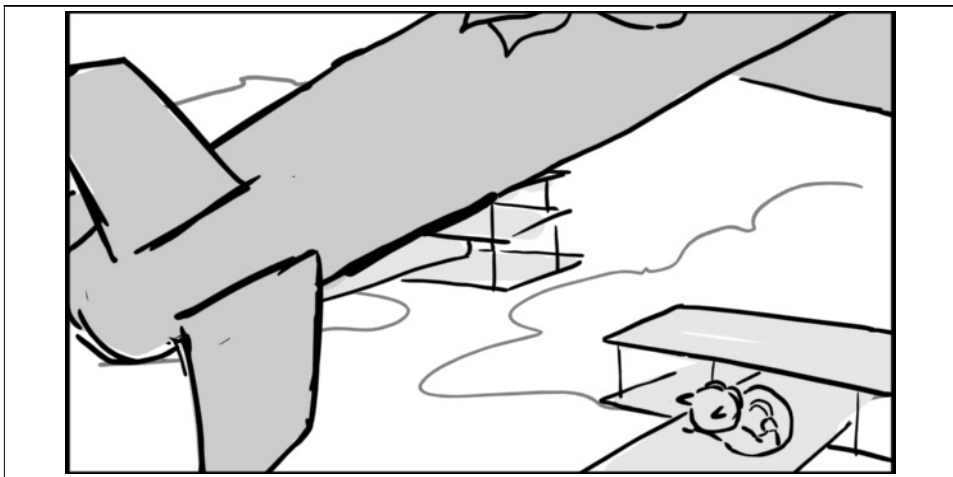

Action Notes

led by the Red Baron in his FOKKER DR1 DREIDECKER. The other planes are PHÖNIX D.I's, piloted by CATS!

|       |       |
|-------|-------|
| Scene | Panel |
| 31    | 1     |



Dialog

148 WWI PILOT JONES  
Are those cats? How did they train cats to fly airplanes?

Action Notes

EXT. SKY - DAY Pilot Jones squints.

|       |       |
|-------|-------|
| Scene | Panel |
| 31    | 2     |



Dialog

149 WWI PILOT ANDERSON  
WAR IS HELL!

|       |       |
|-------|-------|
| Scene | Panel |
| 31    | 3     |

Dialog  
149 WWI PILOT ANDERSON  
WAR IS HELL!

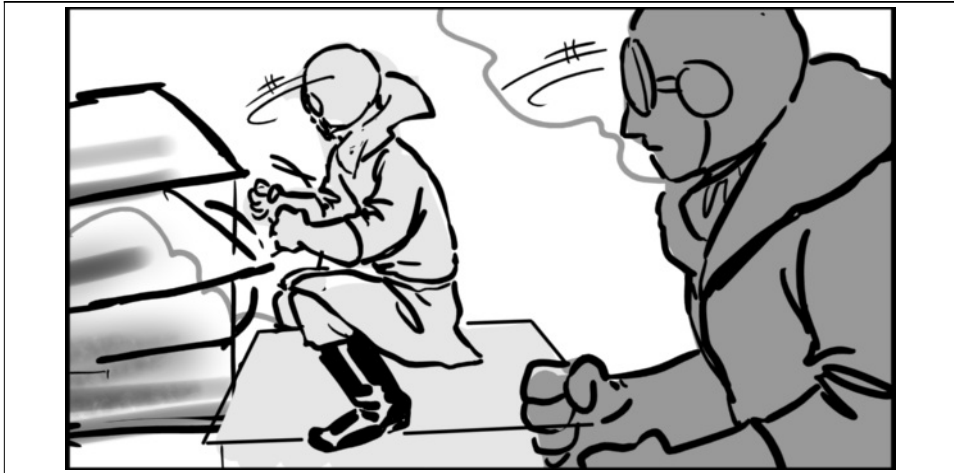

Action Notes  
THE RED BARON zips by  
Snoopy then does a loop and  
comes around to fly next to  
him.

|       |       |
|-------|-------|
| Scene | Panel |
| 31    | 4     |

Dialog  
149 WWI PILOT ANDERSON  
WAR IS HELL!

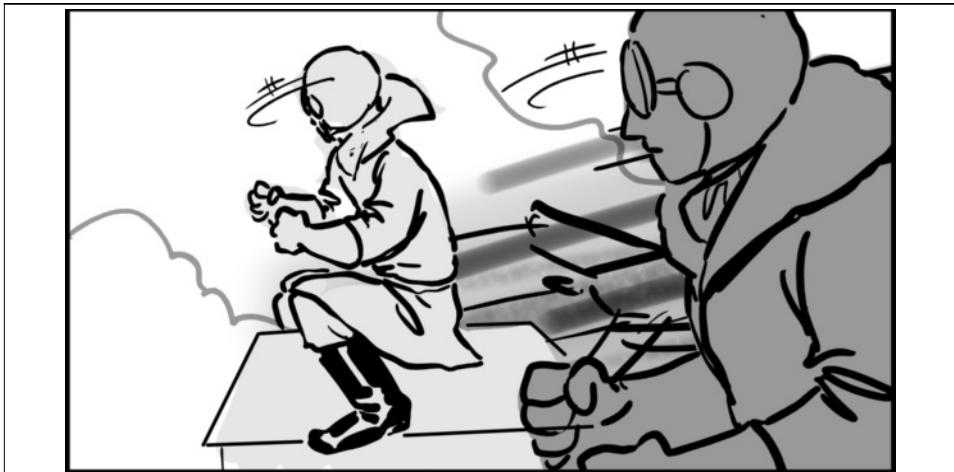

Action Notes  
THE RED BARON zips by  
Snoopy then does a loop and  
comes around to fly next to  
him.

|       |       |
|-------|-------|
| Scene | Panel |
| 31    | 5     |

Dialog  
149 WWI PILOT ANDERSON  
WAR IS HELL!

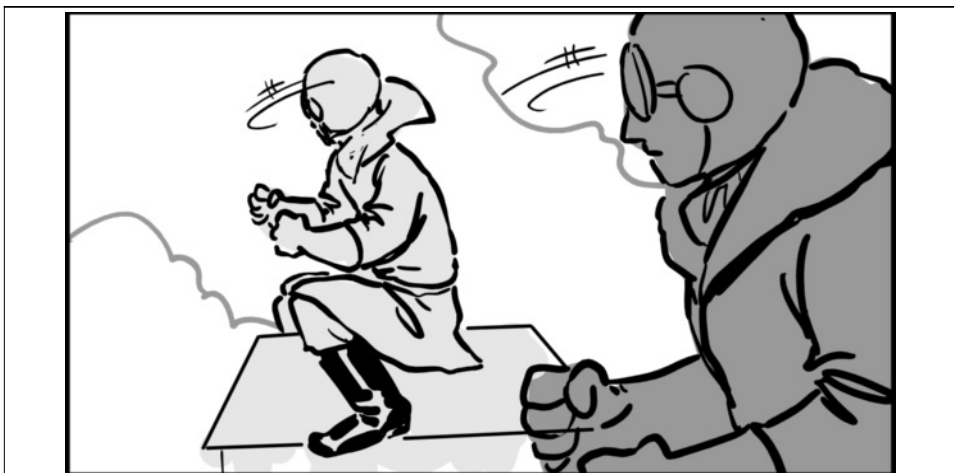

Action Notes  
THE RED BARON zips by  
Snoopy then does a loop and  
comes around to fly next to  
him.

|       |       |
|-------|-------|
| Scene | Panel |
| 32    | 1     |



Action Notes  
 THE RED BARON zips by  
 Snoopy then does a loop and  
 comes around to fly next to  
 him.

|       |       |
|-------|-------|
| Scene | Panel |
| 32    | 2     |



Action Notes  
 THE RED BARON zips by  
 Snoopy then does a loop and  
 comes around to fly next to  
 him.

|       |       |
|-------|-------|
| Scene | Panel |
| 33    | 1     |



Action Notes  
 THE RED BARON zips by  
 Snoopy then does a loop and  
 comes around to fly next to  
 him.

|       |       |
|-------|-------|
| Scene | Panel |
| 33    | 2     |

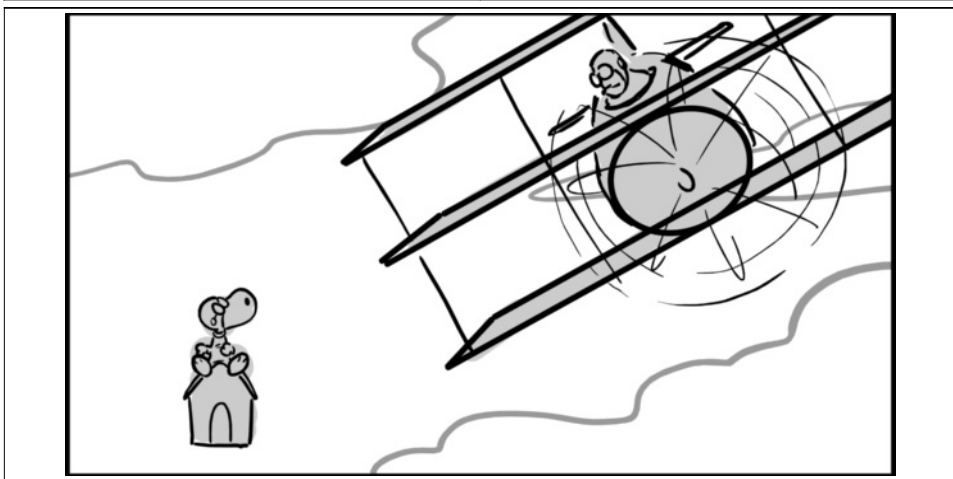

Action Notes

THE RED BARON zips by Snoopy then does a loop and comes around to fly next to him.

|       |       |
|-------|-------|
| Scene | Panel |
| 33    | 3     |

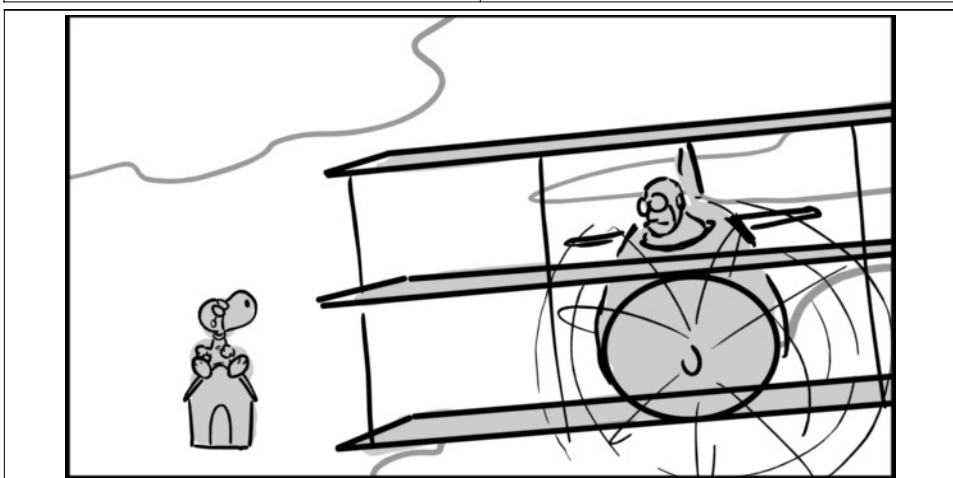

Action Notes

THE RED BARON zips by Snoopy then does a loop and comes around to fly next to him.

|       |       |
|-------|-------|
| Scene | Panel |
| 34    | 1     |



Dialog

150 RED BARON  
Guten Morgen, Herr Snoopy!  
Dogfights are overrated so I thought why not switch to a catfight?

|       |       |
|-------|-------|
| Scene | Panel |
| 34    | 2     |



Dialog  
 150 RED BARON  
 Guten Morgen, Herr Snoopy!  
 Dogfights are overrated so I  
 thought why not switch to a  
 catfight?

Action Notes  
 He pulls a cat from his  
 cockpit and throws it at  
 Snoopy. The cat latches onto  
 his face and starts clawing.

|       |       |
|-------|-------|
| Scene | Panel |
| 34    | 3     |



Action Notes  
 He pulls a cat from his  
 cockpit and throws it at  
 Snoopy. The cat latches onto  
 his face and starts clawing.

|       |       |
|-------|-------|
| Scene | Panel |
| 35    | 1     |



Dialog  
 151 SNOOPY WAAAUGH!

Action Notes  
 He pulls a cat from his  
 cockpit and throws it at  
 Snoopy. The cat latches onto  
 his face and starts clawing.



|       |       |
|-------|-------|
| Scene | Panel |
|       | 35    |
|       | 2     |

Dialog  
151 SNOOPY WAAAUGH!



Action Notes  
He pulls a cat from his cockpit and throws it at Snoopy. The cat latches onto his face and starts clawing.

|       |       |
|-------|-------|
| Scene | Panel |
|       | 36    |
|       | 1     |

Action Notes  
His doghouse goes into a dive.

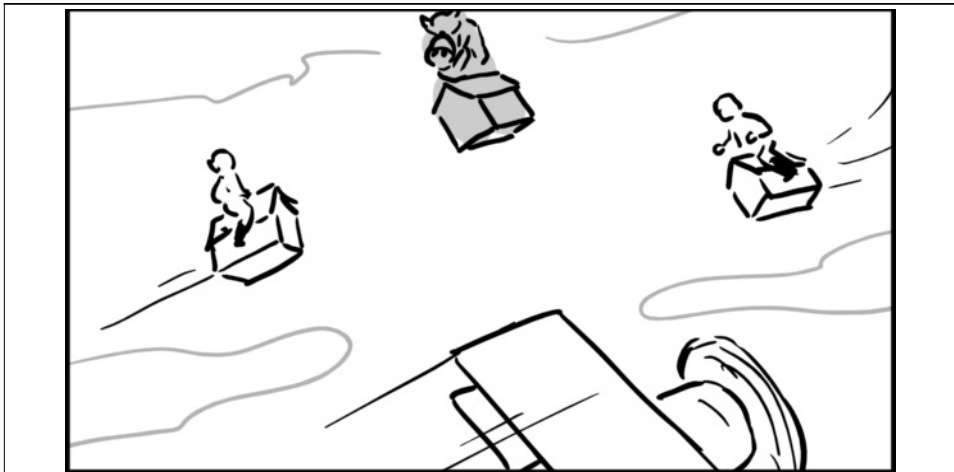

|       |       |
|-------|-------|
| Scene | Panel |
|       | 36    |
|       | 2     |

Action Notes  
His doghouse goes into a dive.

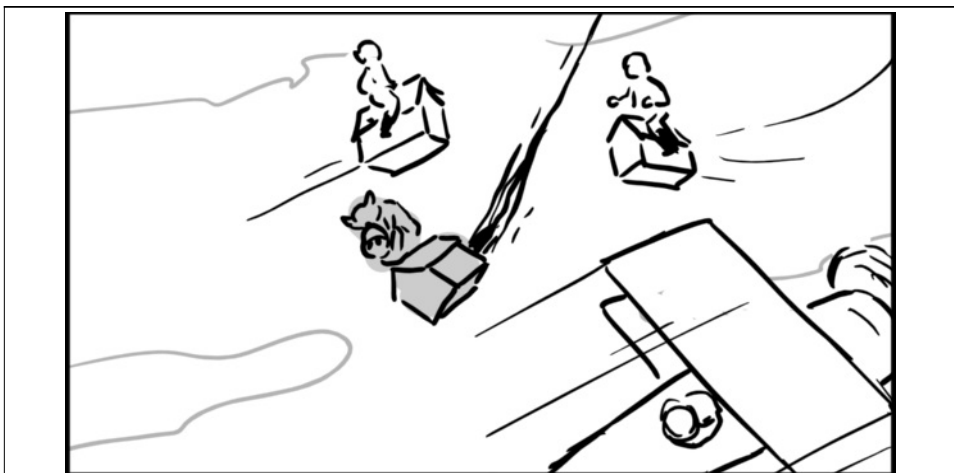

|       |       |
|-------|-------|
| Scene | Panel |
| 36    | 3     |



Action Notes  
His doghouse goes into a dive.

|       |       |
|-------|-------|
| Scene | Panel |
| 37    | 1     |



Action Notes  
- Pilot Anderson flies in behind one of the cat planes. The cat sweeps back and forth trying to lose him, but Anderson locks on. The cat stands in its cockpit and lifts its tail.

|       |       |
|-------|-------|
| Scene | Panel |
| 37    | 2     |



Action Notes  
- Pilot Anderson flies in behind one of the cat planes. The cat sweeps back and forth trying to lose him, but Anderson locks on. The cat stands in its cockpit and lifts its tail.

|       |       |
|-------|-------|
| Scene | Panel |
| 38    | 1     |

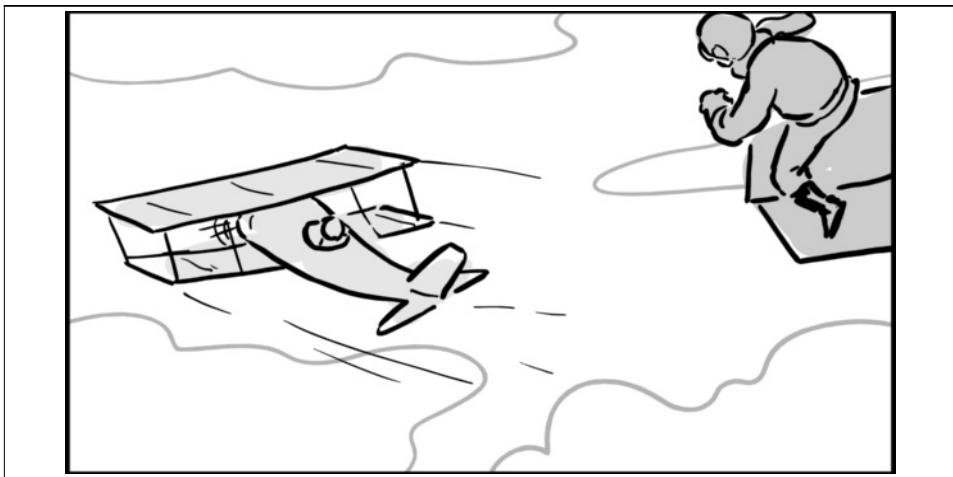

Action Notes

- Pilot Anderson flies in behind one of the cat planes. The cat sweeps back and forth trying to lose him, but Anderson locks on. The cat stands in its cockpit and lifts its tail.

|       |       |
|-------|-------|
| Scene | Panel |
| 38    | 2     |

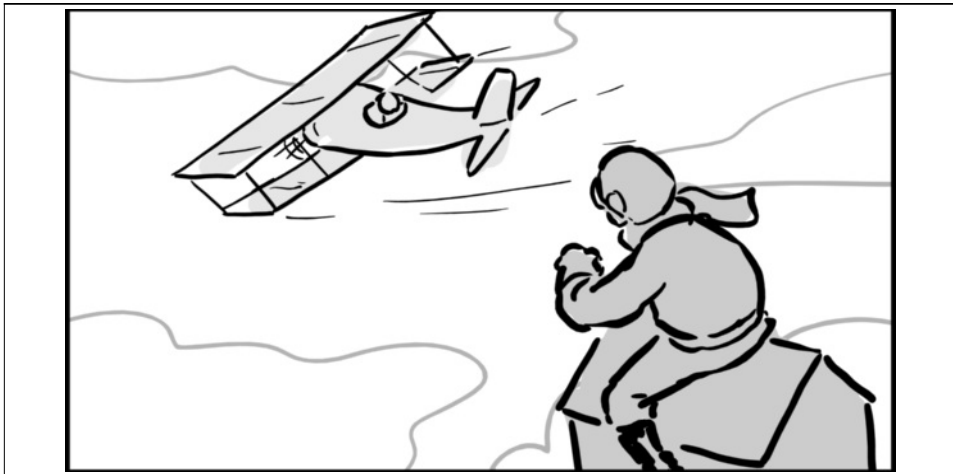

Action Notes

- Pilot Anderson flies in behind one of the cat planes. The cat sweeps back and forth trying to lose him, but Anderson locks on. The cat stands in its cockpit and lifts its tail.

|       |       |
|-------|-------|
| Scene | Panel |
| 39    | 1     |



Action Notes

- Pilot Anderson flies in behind one of the cat planes. The cat sweeps back and forth trying to lose him, but Anderson locks on. The cat stands in its cockpit and lifts its tail.

|       |       |
|-------|-------|
| Scene | Panel |
| 39    | 2     |



## Action Notes

- Pilot Anderson flies in behind one of the cat planes. The cat sweeps back and forth trying to lose him, but Anderson locks on. The cat stands in its cockpit and lifts its tail.

|       |       |
|-------|-------|
| Scene | Panel |
| 39    | 3     |



## Action Notes

- Pilot Anderson flies in behind one of the cat planes. The cat sweeps back and forth trying to lose him, but Anderson locks on. The cat stands in its cockpit and lifts its tail.

|       |       |
|-------|-------|
| Scene | Panel |
| 39    | 4     |

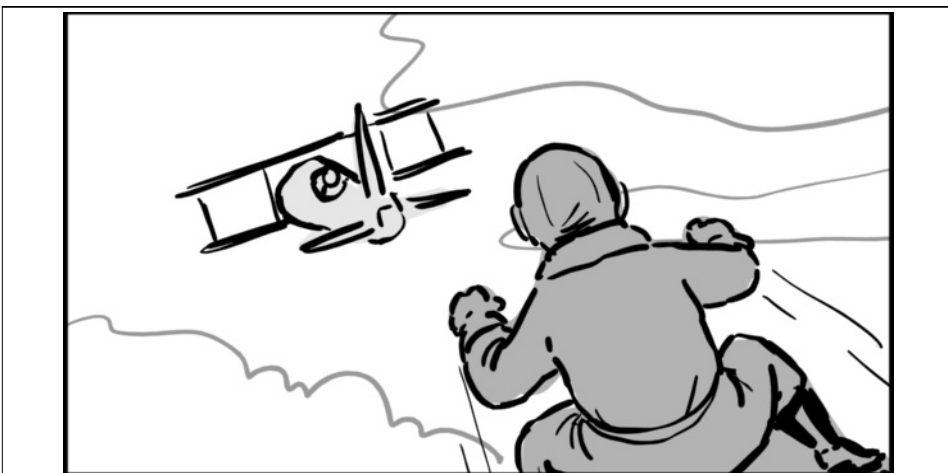

## Action Notes

- Pilot Anderson flies in behind one of the cat planes. The cat sweeps back and forth trying to lose him, but Anderson locks on. The cat stands in its cockpit and lifts its tail.

|       |       |
|-------|-------|
| Scene | Panel |
| 39    | 5     |

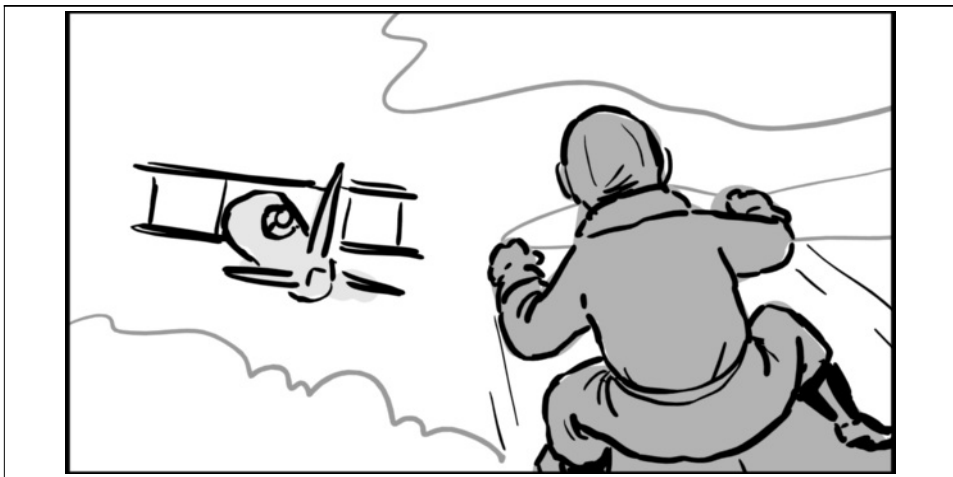

Action Notes

- Pilot Anderson flies in behind one of the cat planes. The cat sweeps back and forth trying to lose him, but Anderson locks on. The cat stands in its cockpit and lifts its tail.

|       |       |
|-------|-------|
| Scene | Panel |
| 40    | 1     |

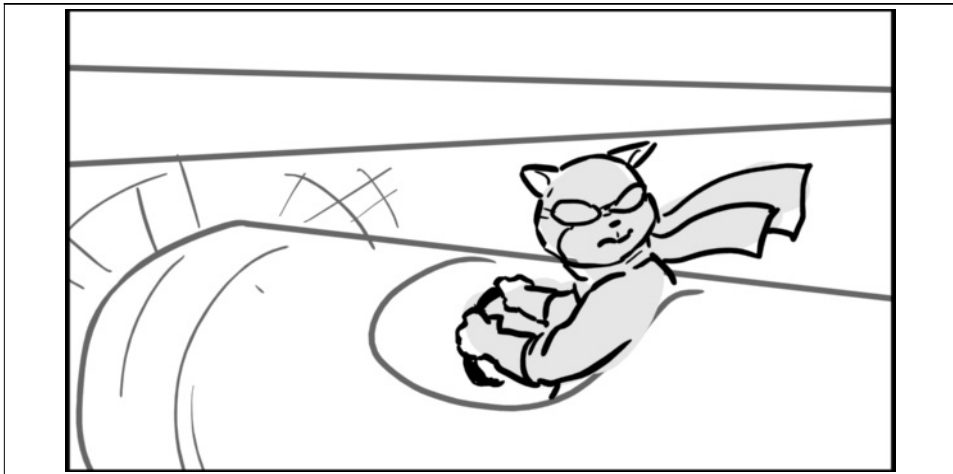

Action Notes

- Pilot Anderson flies in behind one of the cat planes. The cat sweeps back and forth trying to lose him, but Anderson locks on. The cat stands in its cockpit and lifts its tail.

|       |       |
|-------|-------|
| Scene | Panel |
| 40    | 2     |

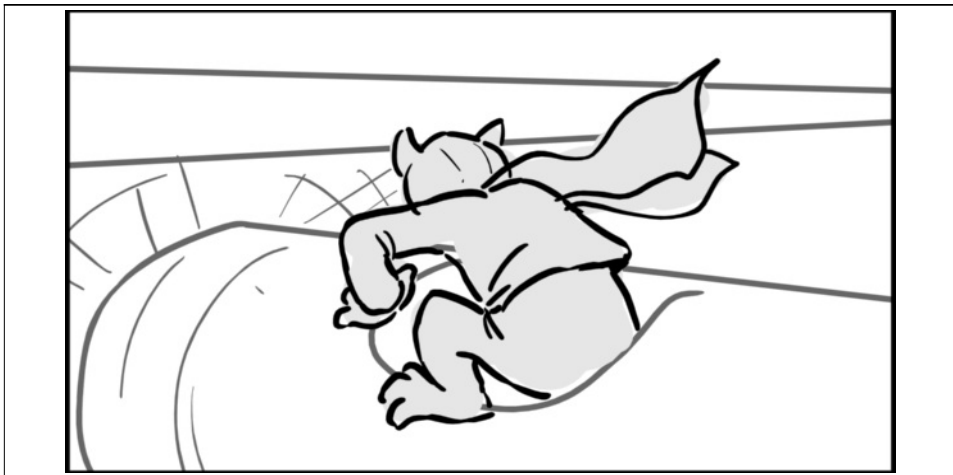

Action Notes

- Pilot Anderson flies in behind one of the cat planes. The cat sweeps back and forth trying to lose him, but Anderson locks on. The cat stands in its cockpit and lifts its tail.

|       |       |
|-------|-------|
| Scene | Panel |
| 40    | 3     |

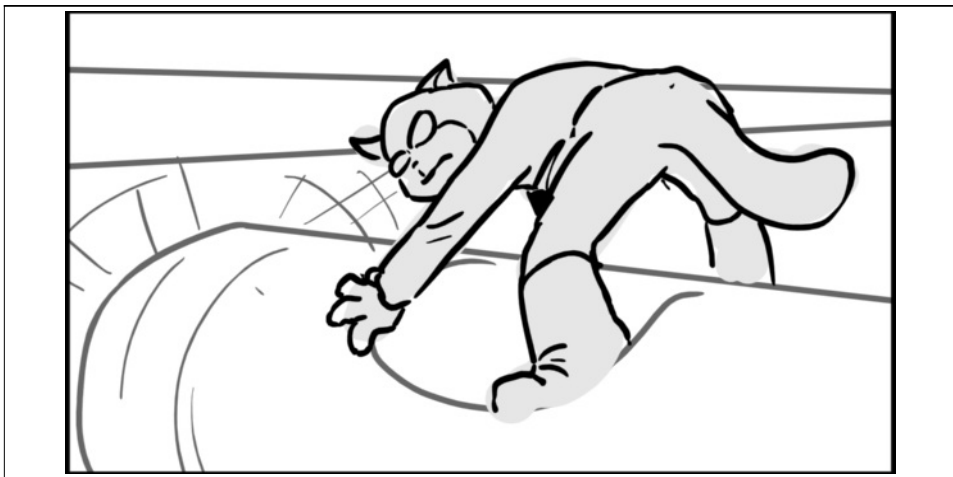

Action Notes

- Pilot Anderson flies in behind one of the cat planes. The cat sweeps back and forth trying to lose him, but Anderson locks on. The cat stands in its cockpit and lifts its tail.

|       |       |
|-------|-------|
| Scene | Panel |
| 41    | 1     |



Action Notes

- Pilot Anderson flies in behind one of the cat planes. The cat sweeps back and forth trying to lose him, but Anderson locks on. The cat stands in its cockpit and lifts its tail.

|       |       |
|-------|-------|
| Scene | Panel |
| 41    | 2     |



Action Notes

- Pilot Anderson flies in behind one of the cat planes. The cat sweeps back and forth trying to lose him, but Anderson locks on. The cat stands in its cockpit and lifts its tail.

|       |       |
|-------|-------|
| Scene | Panel |
| 41    | 3     |



Dialog  
152 WWI PILOT ANDERSON  
OH GOD! It's marking its  
territory!

Action Notes  
CUT TO Anderson, getting a  
faceful of SPRAY.

|       |       |
|-------|-------|
| Scene | Panel |
| 41    | 4     |



Dialog  
152 WWI PILOT ANDERSON  
OH GOD! It's marking its  
territory!

Action Notes  
CUT TO Anderson, getting a  
faceful of SPRAY.

|       |       |
|-------|-------|
| Scene | Panel |
| 42    | 1     |

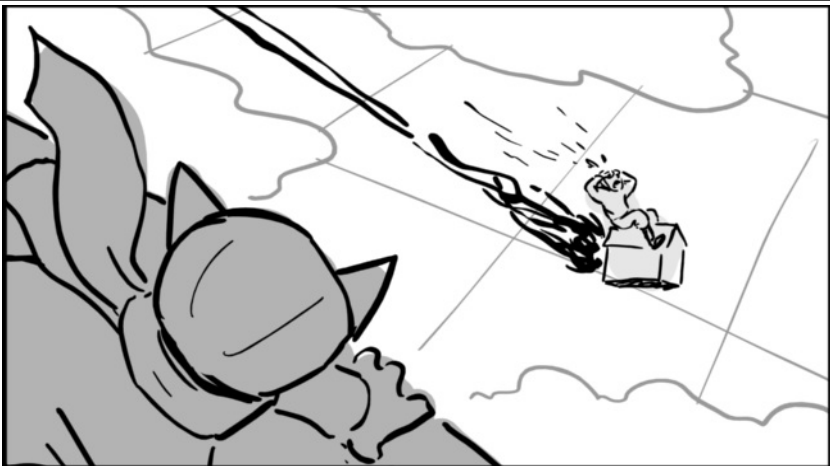

Action Notes  
His doghouse goes spinning  
out of control and crashes

|       |       |
|-------|-------|
| Scene | Panel |
| 42    | 2     |



## Action Notes

His doghouse goes spinning out of control and crashes

|       |       |
|-------|-------|
| Scene | Panel |
| 43    | 1     |

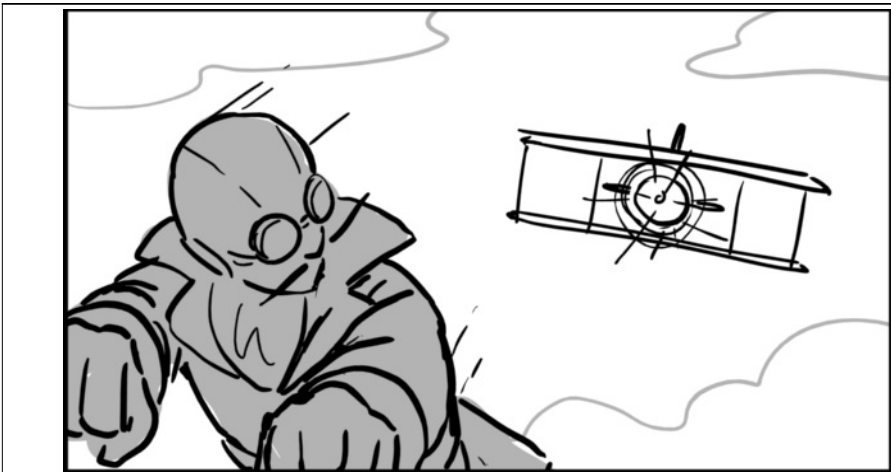

## Action Notes

- Pilot Jones has a cat behind him. He twists and turns then climbs so his plane is above the cat's plane.

|       |       |
|-------|-------|
| Scene | Panel |
| 43    | 2     |



## Action Notes

- Pilot Jones has a cat behind him. He twists and turns then climbs so his plane is above the cat's plane.



|       |       |
|-------|-------|
| Scene | Panel |
| 43    | 3     |

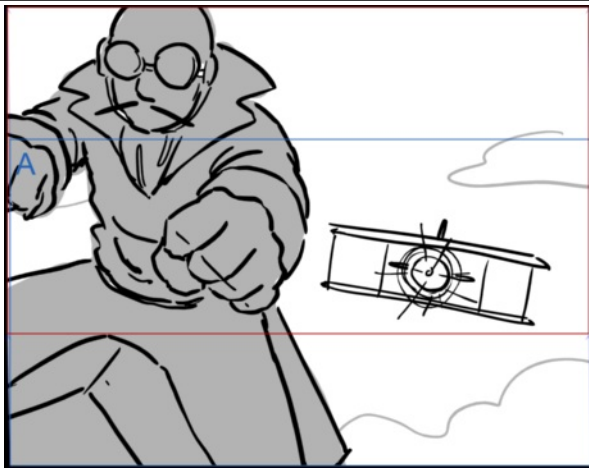

Action Notes

- Pilot Jones has a cat behind him. He twists and turns then climbs so his plane is above the cat's plane.

|       |       |
|-------|-------|
| Scene | Panel |
| 43    | 4     |

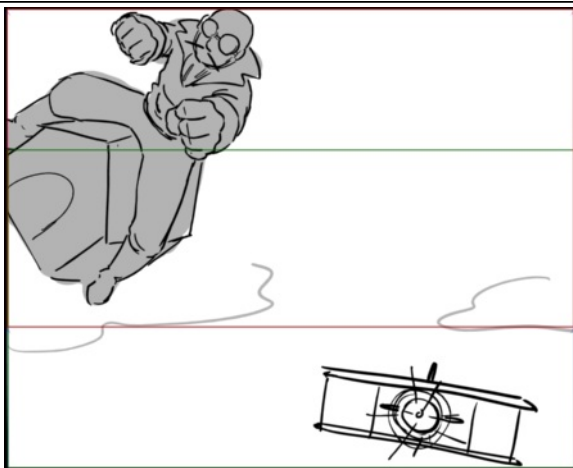

Action Notes

- Pilot Jones has a cat behind him. He twists and turns then climbs so his plane is above the cat's plane.

|       |       |
|-------|-------|
| Scene | Panel |
| 43    | 5     |

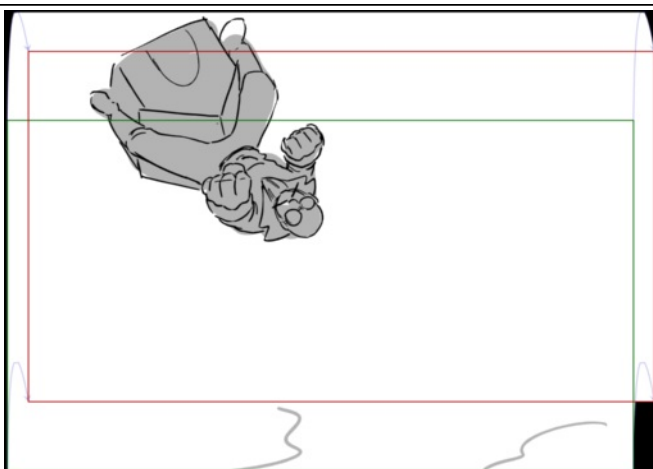

Action Notes

- Pilot Jones has a cat behind him. He twists and turns then climbs so his plane is above the cat's plane.

|       |       |
|-------|-------|
| Scene | Panel |
| 43    | 6     |

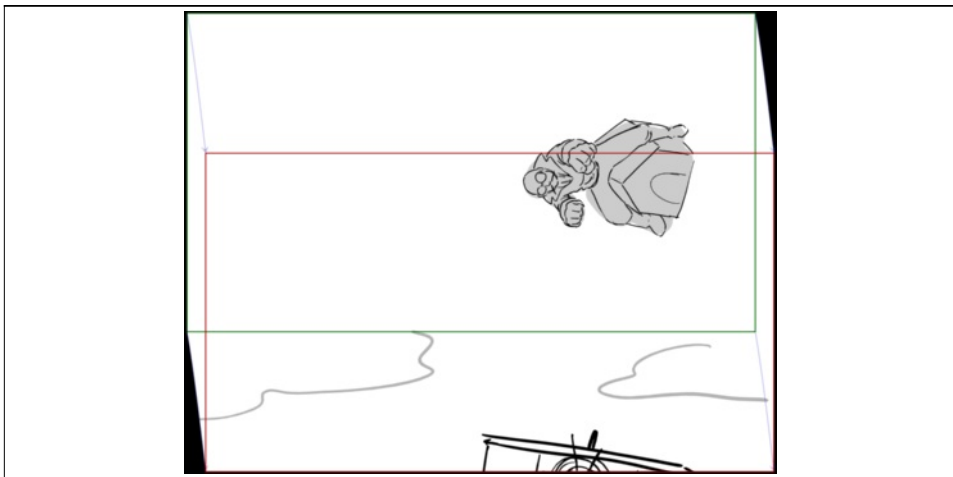

Action Notes

- Pilot Jones has a cat behind him. He twists and turns then climbs so his plane is above the cat's plane.

|       |       |
|-------|-------|
| Scene | Panel |
| 43    | 7     |

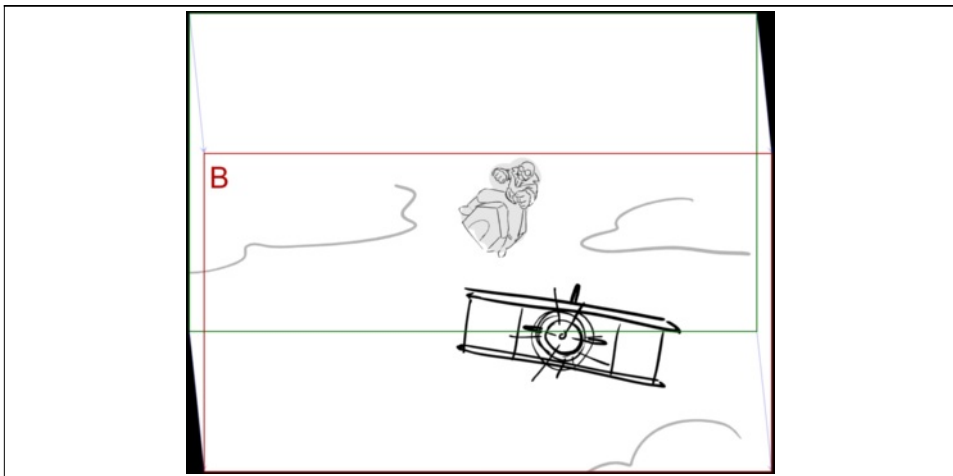

Action Notes

- Pilot Jones has a cat behind him. He twists and turns then climbs so his plane is above the cat's plane.

|       |       |
|-------|-------|
| Scene | Panel |
| 44    | 1     |



Dialog

153 WWI PILOT JONES  
Can I interest you in a  
cucumber?

Action Notes

He drops a CUCUMBER in the  
cat's cockpit.

|       |       |
|-------|-------|
| Scene | Panel |
| 44    | 2     |



Dialog  
153 WWI PILOT JONES  
Can I interest you in a  
cucumber?

Action Notes  
He drops a CUCUMBER in the  
cat's cockpit.

|       |       |
|-------|-------|
| Scene | Panel |
| 45    | 1     |

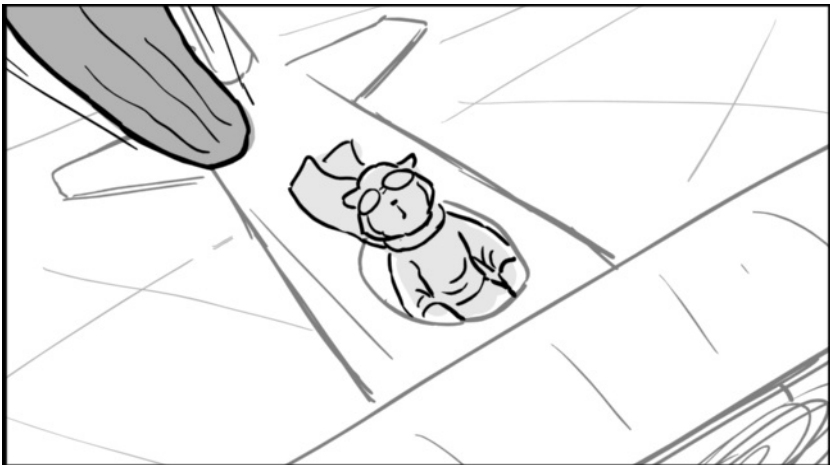

Action Notes  
He drops a CUCUMBER in the  
cat's cockpit.

|       |       |
|-------|-------|
| Scene | Panel |
| 45    | 2     |

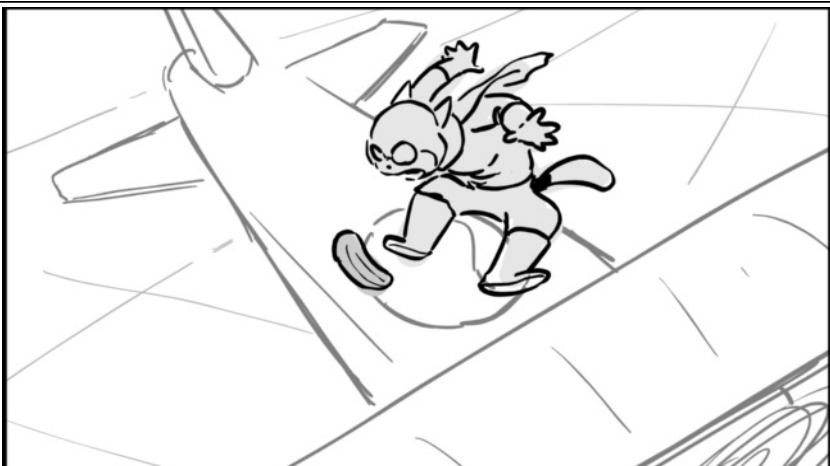

Action Notes  
The cat goes ballistic and  
jumps out. The plane falls out  
of the sky.

|       |       |
|-------|-------|
| Scene | Panel |
| 45    | 3     |

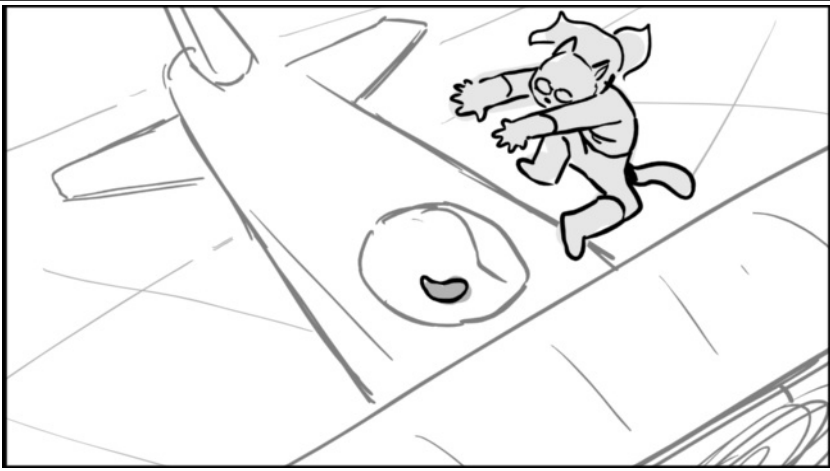

Action Notes

The cat goes ballistic and jumps out. The plane falls out of the sky.

|       |       |
|-------|-------|
| Scene | Panel |
| 45    | 4     |

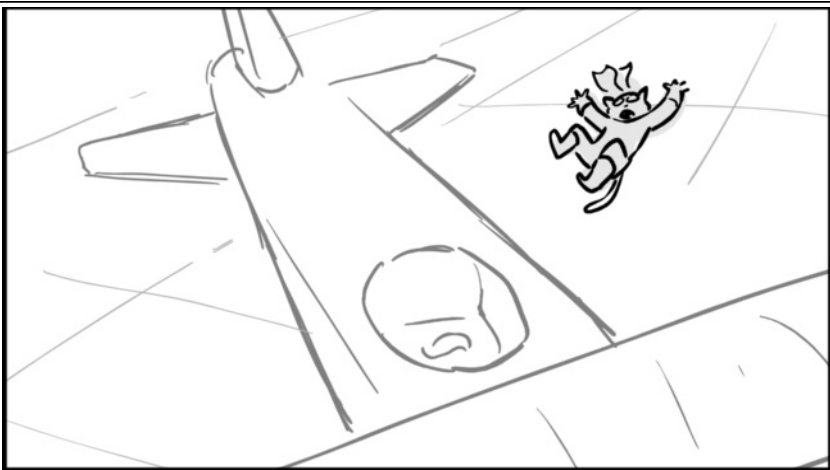

Action Notes

The cat goes ballistic and jumps out. The plane falls out of the sky.

|       |       |
|-------|-------|
| Scene | Panel |
| 45    | 5     |

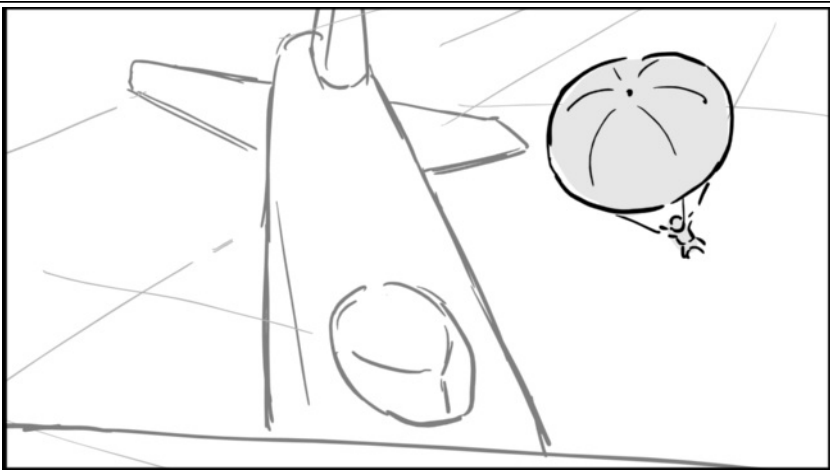

Action Notes

The cat goes ballistic and jumps out. The plane falls out of the sky.

|       |       |
|-------|-------|
| Scene | Panel |
| 45    | 6     |

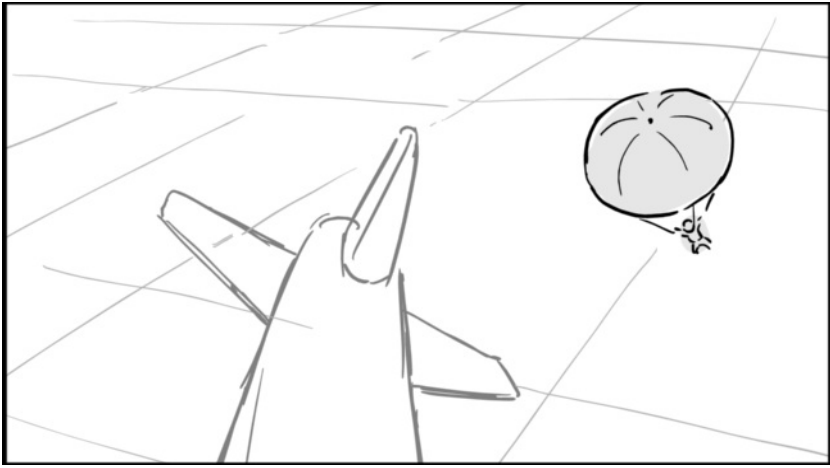

Action Notes  
The cat goes ballistic and jumps out. The plane falls out of the sky.

|       |       |
|-------|-------|
| Scene | Panel |
| 46    | 1     |

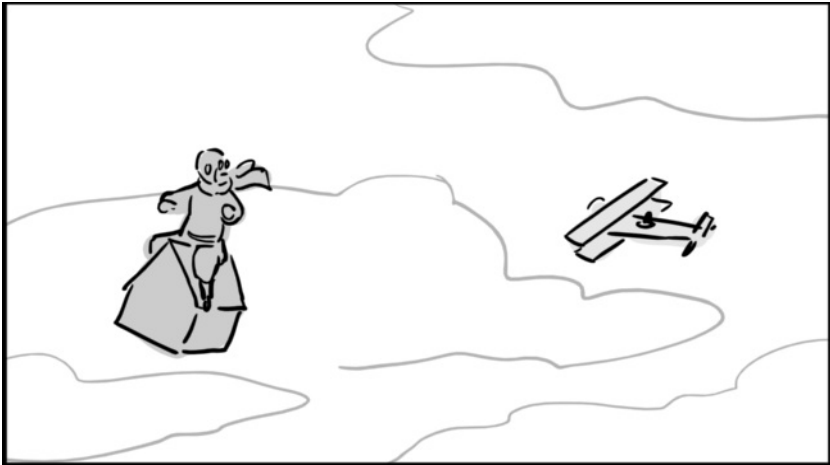

Action Notes  
- Pilot Washington zips and spins in the air with another cat. He gets him in his sights.

|       |       |
|-------|-------|
| Scene | Panel |
| 46    | 2     |



Action Notes  
- Pilot Washington zips and spins in the air with another cat. He gets him in his sights.

|       |       |
|-------|-------|
| Scene | Panel |
| 46    | 3     |

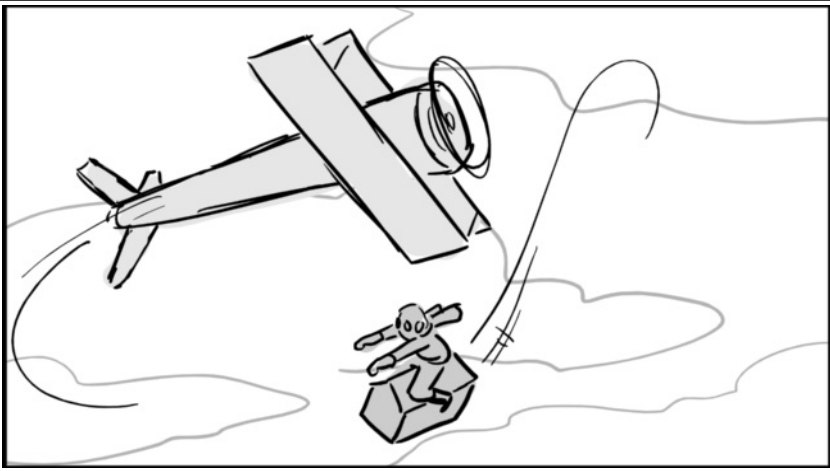

Action Notes

- Pilot Washington zips and spins in the air with another cat. He gets him in his sights.

|       |       |
|-------|-------|
| Scene | Panel |
| 46    | 4     |



Action Notes

- Pilot Washington zips and spins in the air with another cat. He gets him in his sights.

|       |       |
|-------|-------|
| Scene | Panel |
| 46    | 5     |

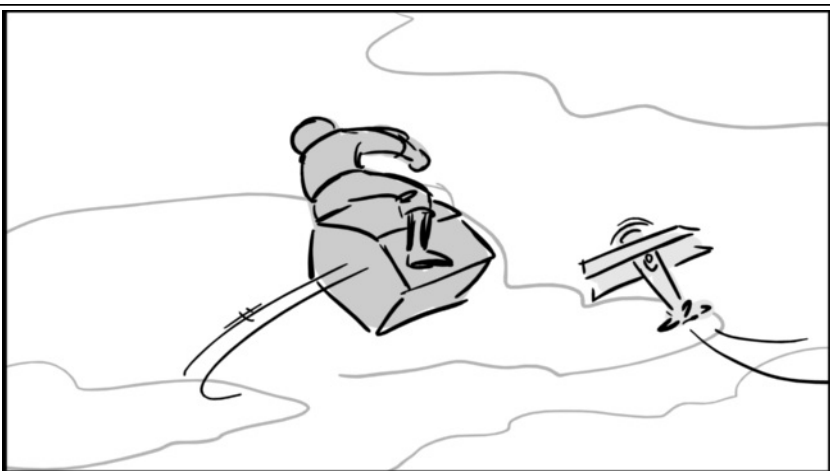

Action Notes

- Pilot Washington zips and spins in the air with another cat. He gets him in his sights.

|       |       |
|-------|-------|
| Scene | Panel |
| 46    | 6     |



Action Notes

- Pilot Washington zips and spins in the air with another cat. He gets him in his sights.

|       |       |
|-------|-------|
| Scene | Panel |
| 46    | 7     |



Action Notes

- Pilot Washington zips and spins in the air with another cat. He gets him in his sights.

|       |       |
|-------|-------|
| Scene | Panel |
| 47    | 1     |

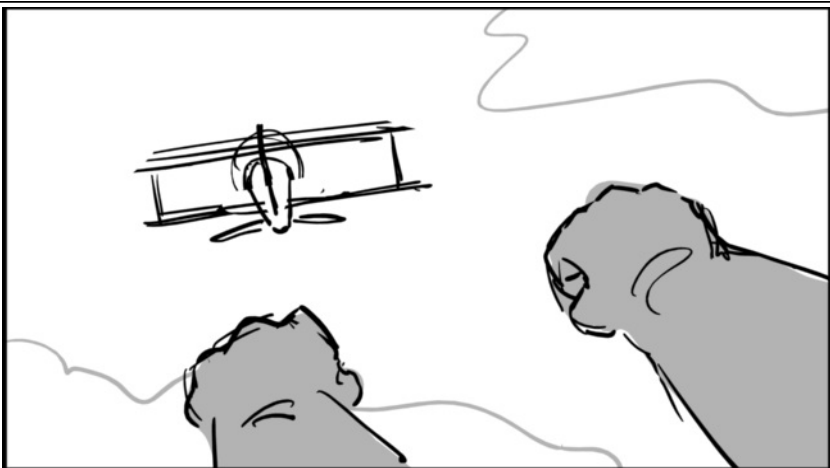

Action Notes

- Pilot Washington zips and spins in the air with another cat. He gets him in his sights.

|       |       |
|-------|-------|
| Scene | Panel |
| 47    | 2     |

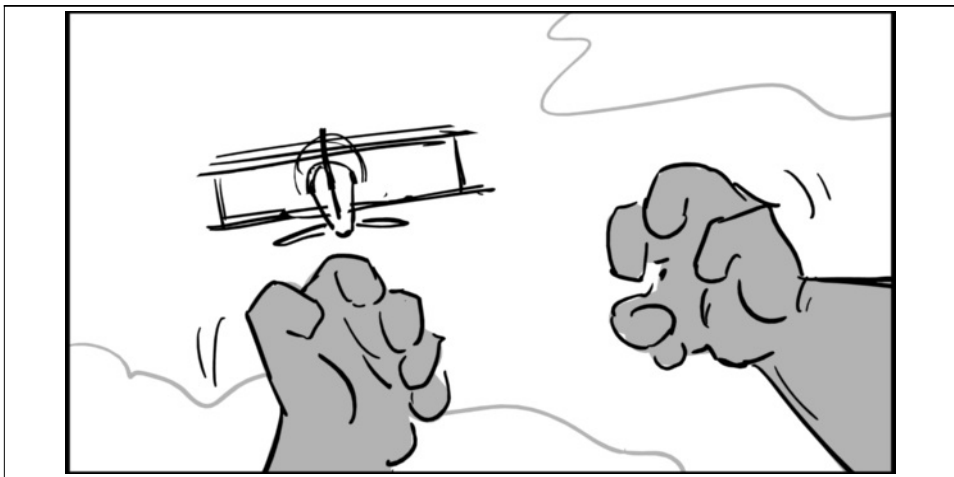

Dialog  
154 WWI PILOT  
WASHINGTON Uh, no one  
told us how to shoot!

|       |       |
|-------|-------|
| Scene | Panel |
| 48    | 1     |

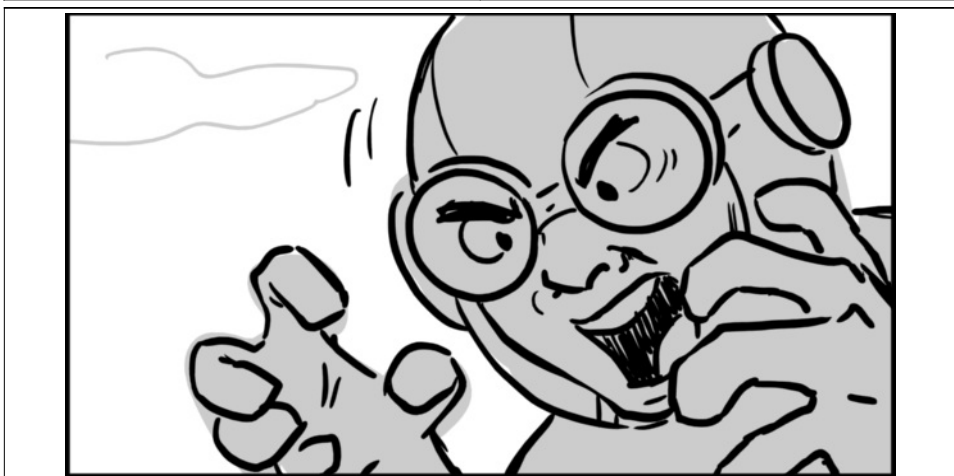

Dialog  
154 WWI PILOT  
WASHINGTON Uh, no one  
told us how to shoot!

|       |       |
|-------|-------|
| Scene | Panel |
| 49    | 1     |

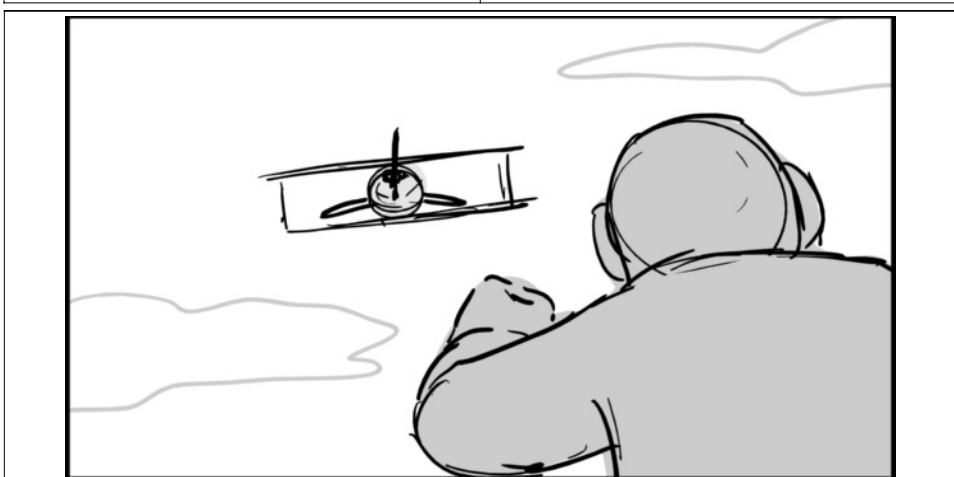

Action Notes  
The cat does a loop-de-loop  
in the air and gets in behind  
him.



|       |       |
|-------|-------|
| Scene | Panel |
| 49    | 2     |

Action Notes

The cat does a loop-de-loop in the air and gets in behind him.

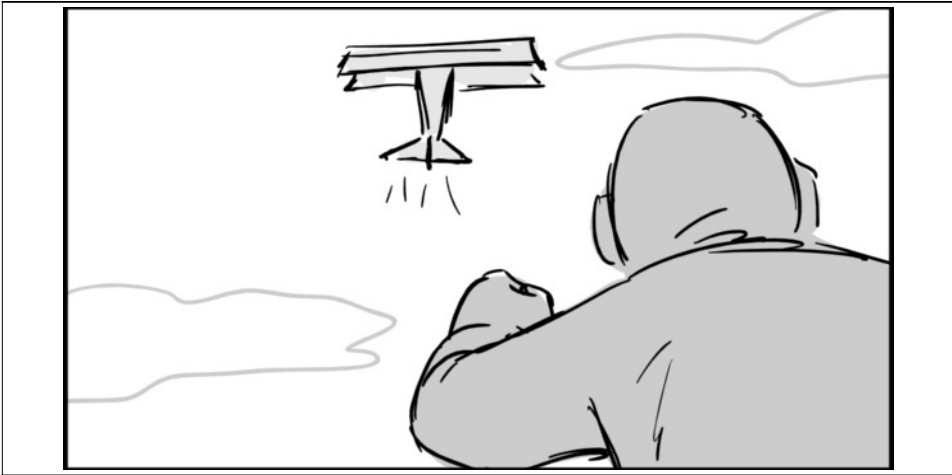

|       |       |
|-------|-------|
| Scene | Panel |
| 49    | 3     |

Action Notes

The cat does a loop-de-loop in the air and gets in behind him.



|       |       |
|-------|-------|
| Scene | Panel |
| 49    | 4     |

Action Notes

The cat does a loop-de-loop in the air and gets in behind him.



|       |       |
|-------|-------|
| Scene | Panel |
| 49    | 5     |



Action Notes

The cat does a loop-de-loop in the air and gets in behind him.

|       |       |
|-------|-------|
| Scene | Panel |
| 49    | 6     |



Action Notes

The cat does a loop-de-loop in the air and gets in behind him.

|       |       |
|-------|-------|
| Scene | Panel |
| 50    | 1     |

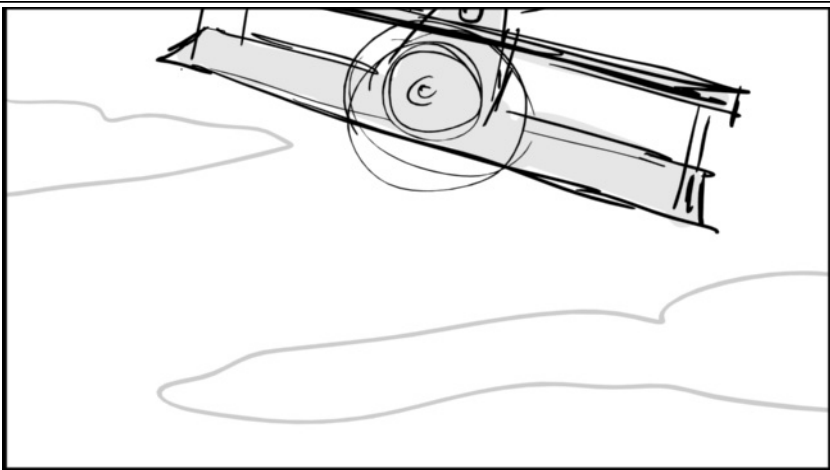

Action Notes

The cat does a loop-de-loop in the air and gets in behind him.

|       |       |
|-------|-------|
| Scene | Panel |
| 50    | 2     |

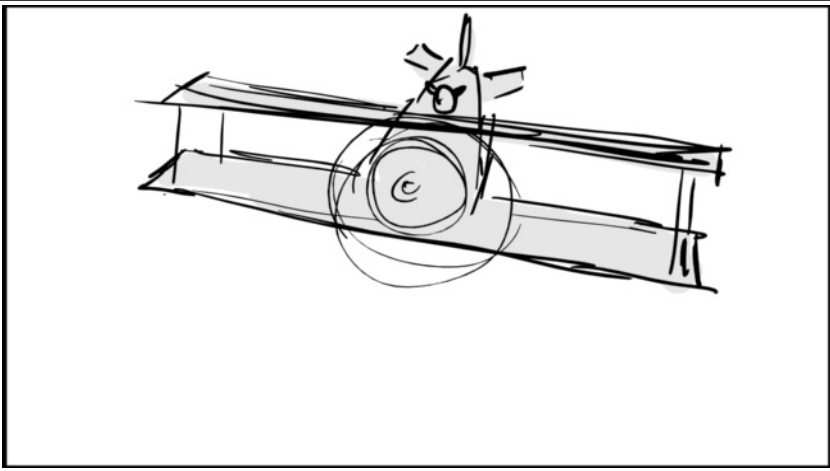

Action Notes

The cat does a loop-de-loop in the air and gets in behind him.

|       |       |
|-------|-------|
| Scene | Panel |
| 50    | 3     |

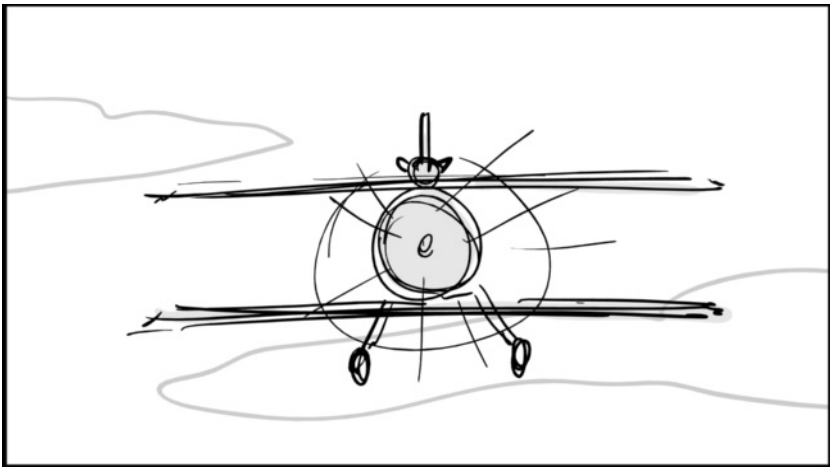

Action Notes

The cat does a loop-de-loop in the air and gets in behind him.

|       |       |
|-------|-------|
| Scene | Panel |
| 50    | 4     |

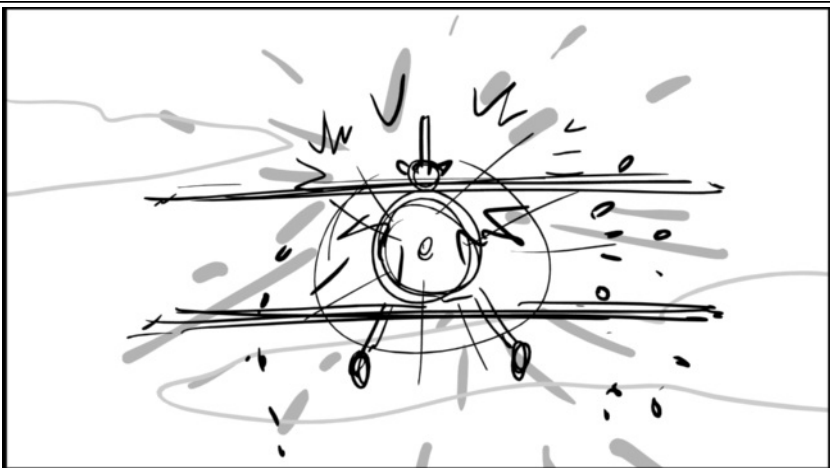

Action Notes

The cat fires. Bullet holes rip into his doghouse and it plummets toward the ground.

|       |       |
|-------|-------|
| Scene | Panel |
| 51    | 1     |

Action Notes  
The cat fires. Bullet holes rip into his doghouse and it plummets toward the ground.

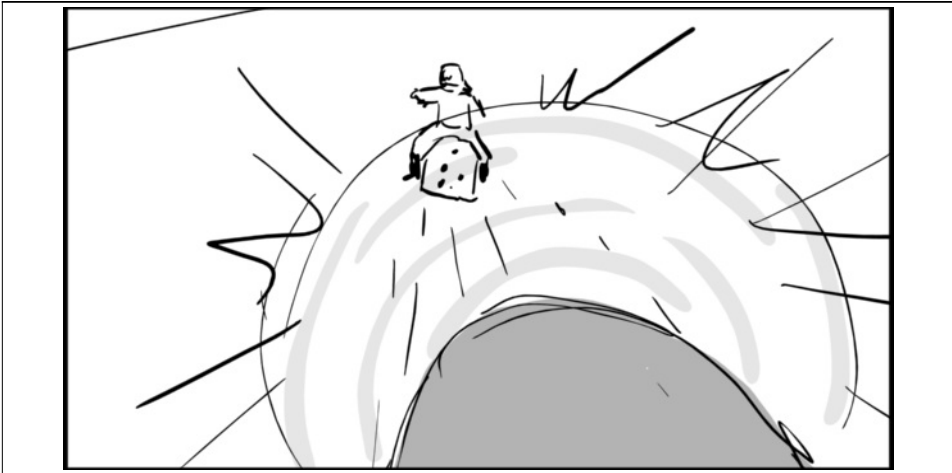

|       |       |
|-------|-------|
| Scene | Panel |
| 51    | 2     |

Action Notes  
The cat fires. Bullet holes rip into his doghouse and it plummets toward the ground.



|       |       |
|-------|-------|
| Scene | Panel |
| 51    | 3     |

Action Notes  
The cat fires. Bullet holes rip into his doghouse and it plummets toward the ground.



|       |       |
|-------|-------|
| Scene | Panel |
| 51    | 4     |

Action Notes

The cat fires. Bullet holes rip into his doghouse and it plummets toward the ground.

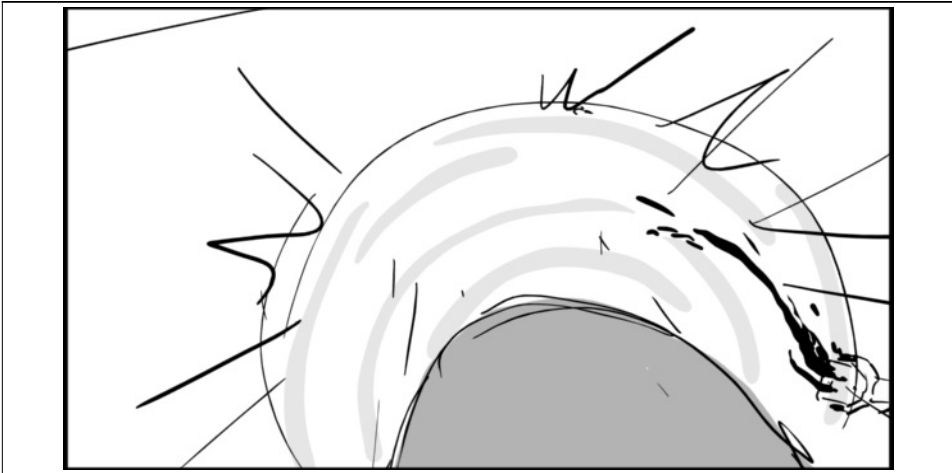

|       |       |
|-------|-------|
| Scene | Panel |
| 52    | 1     |

Action Notes

- Pilot Jones gets in behind another cat's plane.



|       |       |
|-------|-------|
| Scene | Panel |
| 52    | 2     |

Action Notes

- Pilot Jones gets in behind another cat's plane.

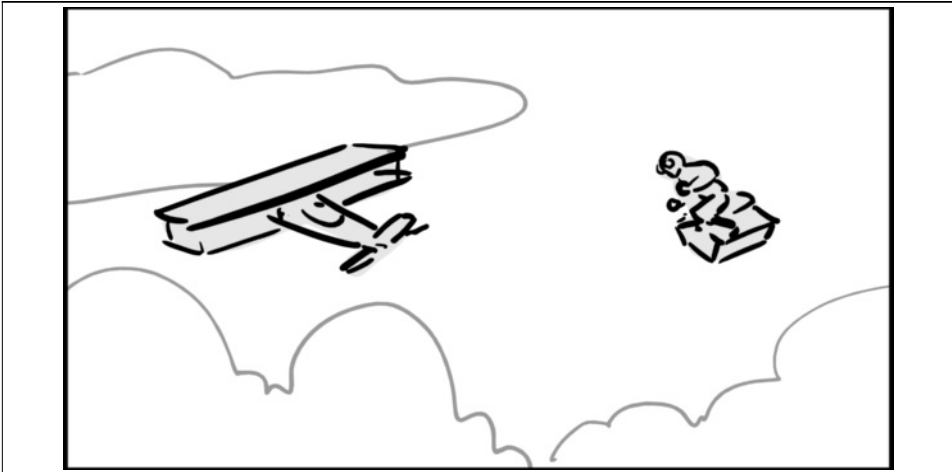

|       |       |
|-------|-------|
| Scene | Panel |
| 52    | 3     |

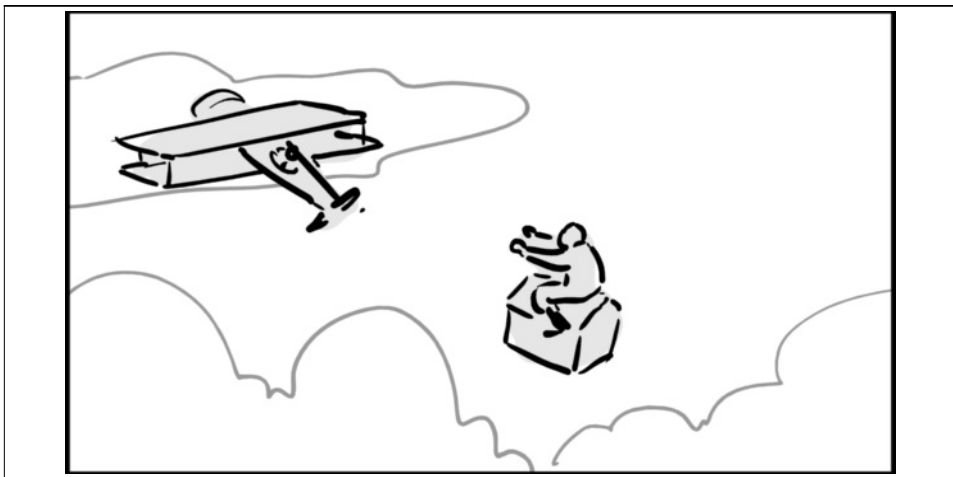

Action Notes

- Pilot Jones gets in behind another cat's plane.

|       |       |
|-------|-------|
| Scene | Panel |
| 53    | 1     |



Dialog

155 WWI PILOT JONES  
The laser pointer won't be invented for another 60 years so this will have to do.

Action Notes

Pilot Jones gets in behind another cat's plane. He pulls out a small MIRROR and moves it around until a little dot appears on the plane's wi

ngs.

|       |       |
|-------|-------|
| Scene | Panel |
| 53    | 2     |



Dialog

155 WWI PILOT JONES  
The laser pointer won't be  
invented for another 60 years  
so this will have to do.

Action Notes

Pilot Jones gets in behind  
another cat's plane. He pulls  
out a small MIRROR and  
moves it around until a little  
dot appears on the plane's wi

ngs.

|       |       |
|-------|-------|
| Scene | Panel |
| 54    | 1     |

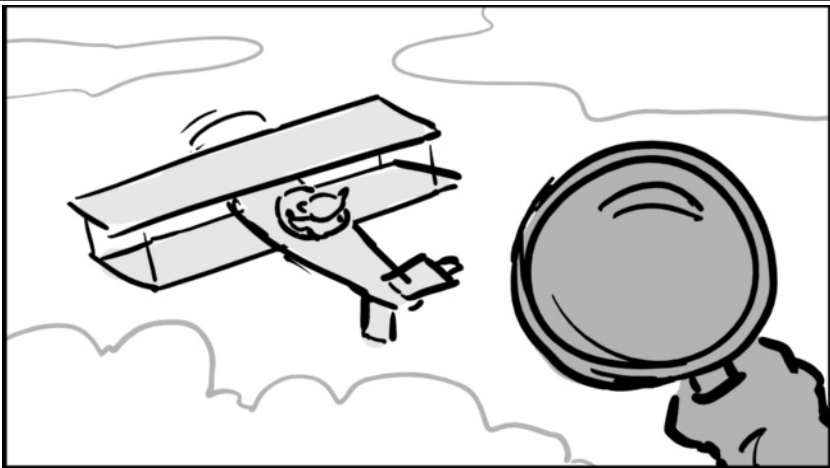

Dialog

155 WWI PILOT JONES  
The laser pointer won't be  
invented for another 60 years  
so this will have to do.

|       |       |
|-------|-------|
| Scene | Panel |
| 54    | 2     |

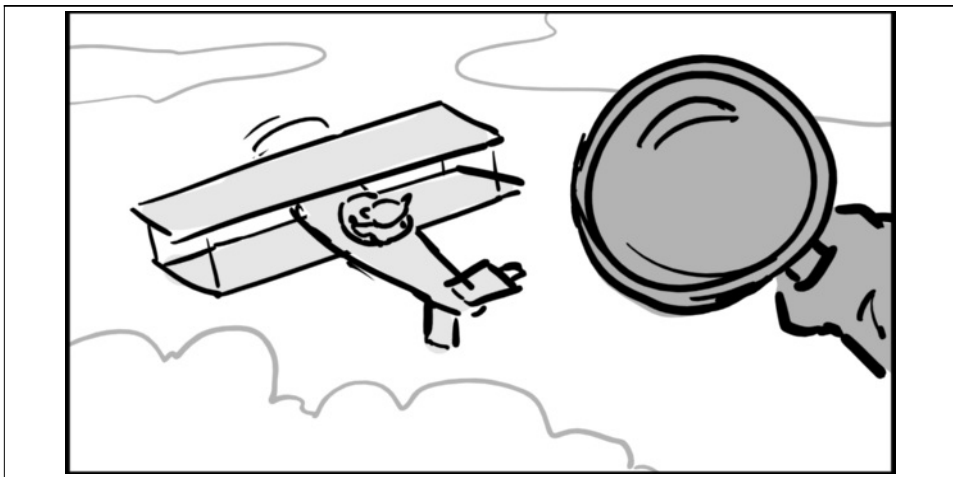

Dialog  
 155 WWI PILOT JONES  
 The laser pointer won't be invented for another 60 years so this will have to do.

|       |       |
|-------|-------|
| Scene | Panel |
| 55    | 1     |

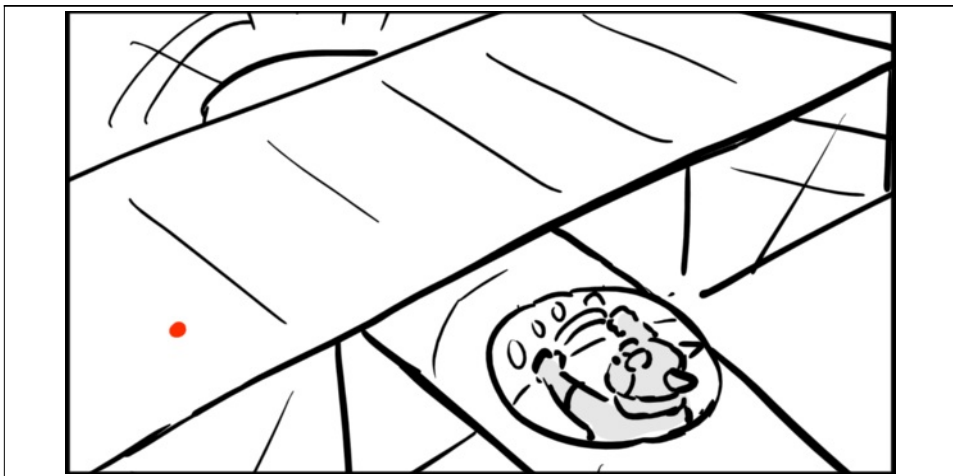

Action Notes  
 The cat sees the dot zipping back and forth on the wings. It climbs out and chases it.

|       |       |
|-------|-------|
| Scene | Panel |
| 55    | 2     |

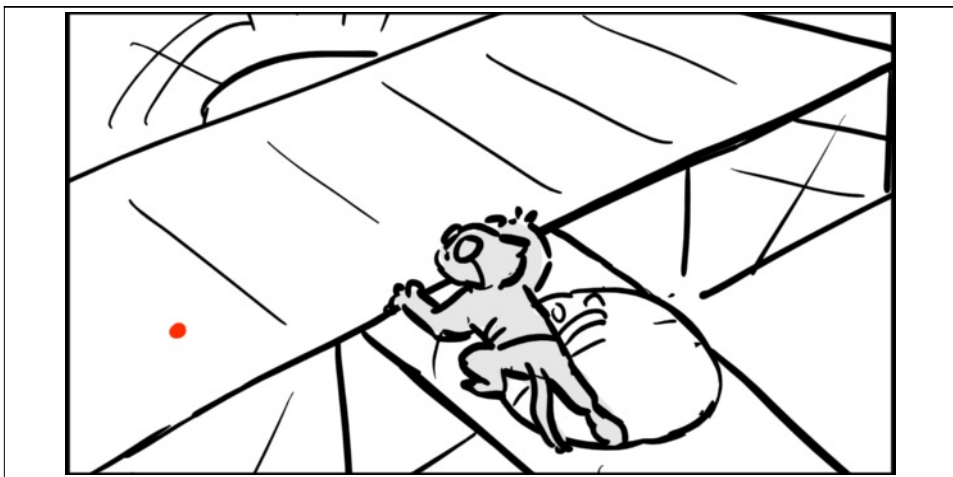

Action Notes  
 The cat sees the dot zipping back and forth on the wings. It climbs out and chases it.



|       |       |
|-------|-------|
| Scene | Panel |
| 55    | 3     |

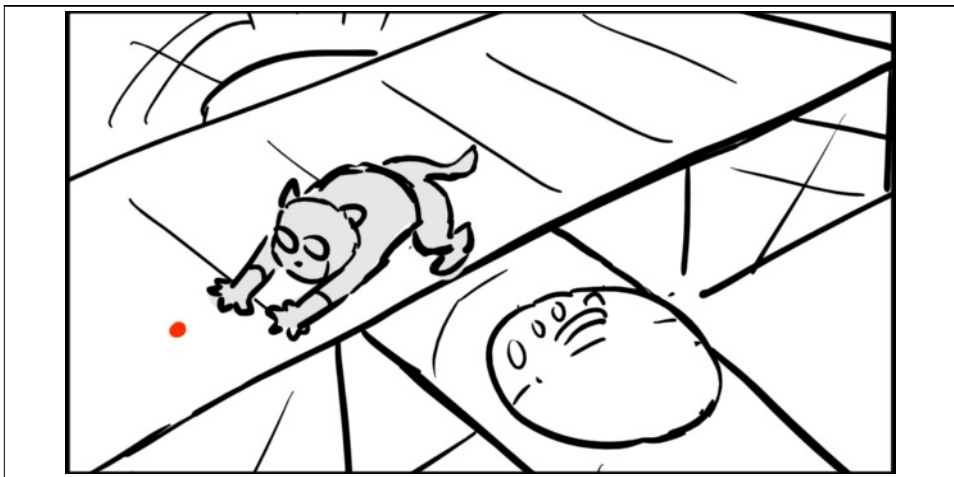

Action Notes

The cat sees the dot zipping back and forth on the wings. It climbs out and chases it.

|       |       |
|-------|-------|
| Scene | Panel |
| 55    | 4     |

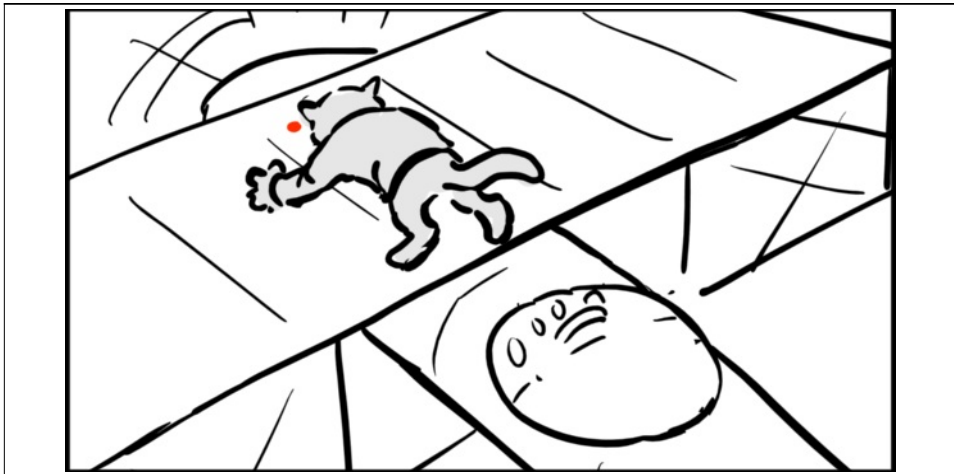

Action Notes

The cat sees the dot zipping back and forth on the wings. It climbs out and chases it.

|       |       |
|-------|-------|
| Scene | Panel |
| 55    | 5     |

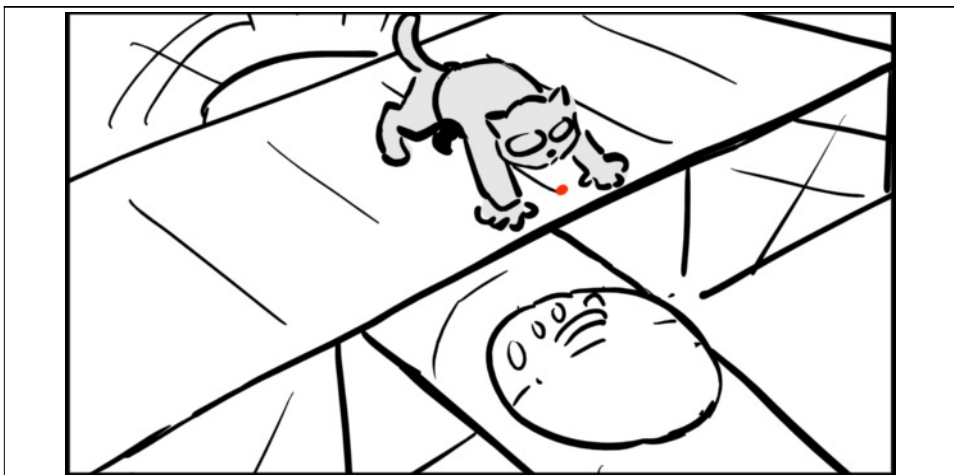

Action Notes

The cat sees the dot zipping back and forth on the wings. It climbs out and chases it.

|       |       |
|-------|-------|
| Scene | Panel |
| 55    | 6     |

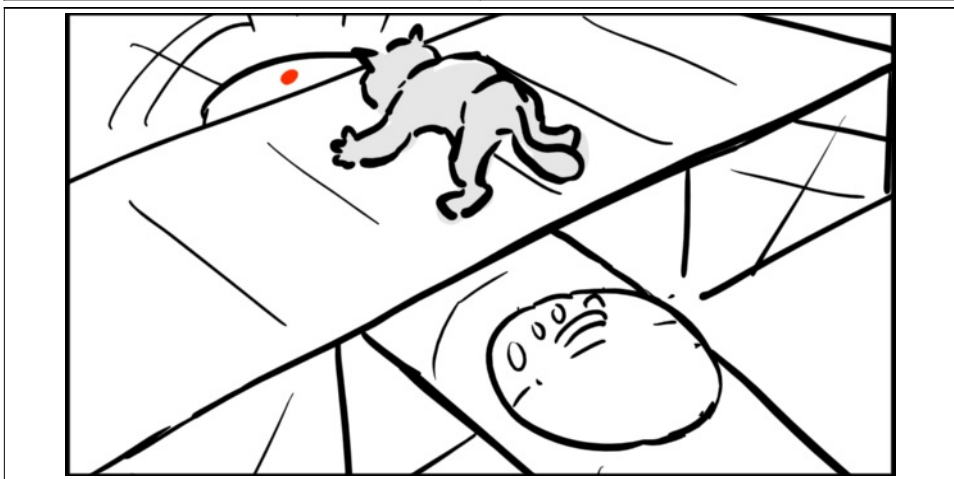

Action Notes

The cat sees the dot zipping back and forth on the wings. It climbs out and chases it.

|       |       |
|-------|-------|
| Scene | Panel |
| 56    | 1     |

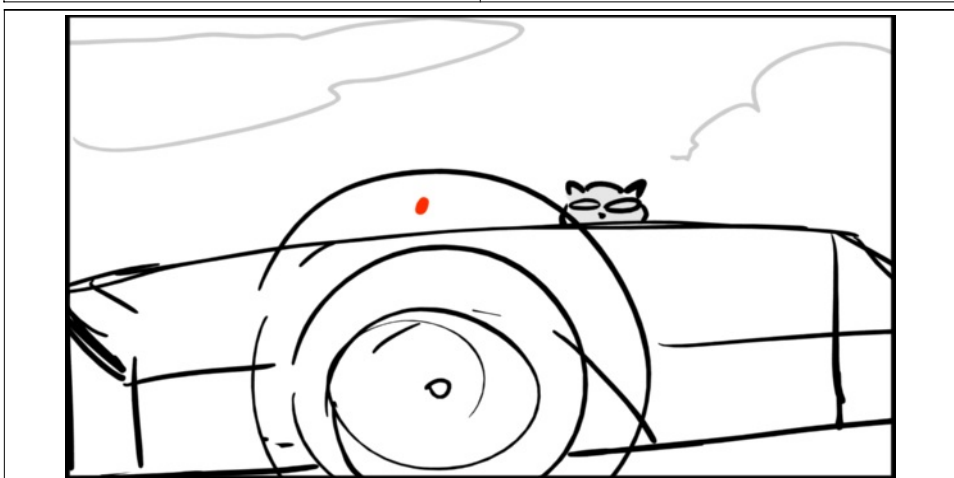

Action Notes

Jones directs the dot to the propeller. The cat leaps and gets turned into paste.

|       |       |
|-------|-------|
| Scene | Panel |
| 56    | 2     |



Action Notes

Jones directs the dot to the propeller. The cat leaps and gets turned into paste.

|       |       |
|-------|-------|
| Scene | Panel |
| 56    | 3     |

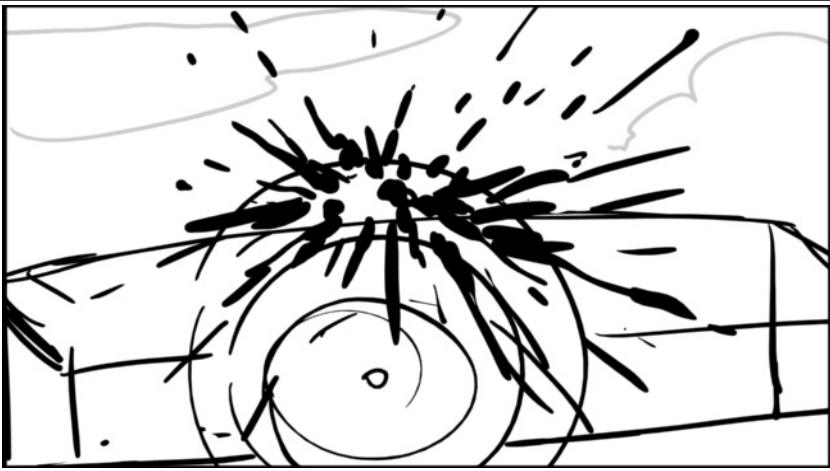

Action Notes

Jones directs the dot to the propeller. The cat leaps and gets turned into paste.

|       |       |
|-------|-------|
| Scene | Panel |
| 56    | 4     |

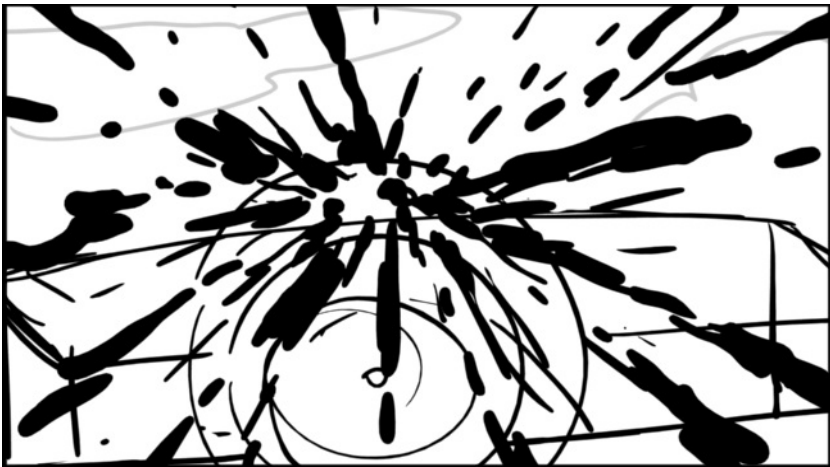

Action Notes

Jones directs the dot to the propeller. The cat leaps and gets turned into paste.

|       |       |
|-------|-------|
| Scene | Panel |
| 57    | 1     |



Dialog

156 WWI PILOT JONES  
(CONT'D) Heh. Heh. Stupid  
cats.

|       |       |
|-------|-------|
| Scene | Panel |
| 57    | 2     |

Dialog  
156 WWI PILOT JONES  
(CONT'D) Heh. Heh. Stupid  
cats.



|       |       |
|-------|-------|
| Scene | Panel |
| 58    | 1     |

Action Notes  
- A Pilot tosses a ball of yarn  
into a cat's cockpit.

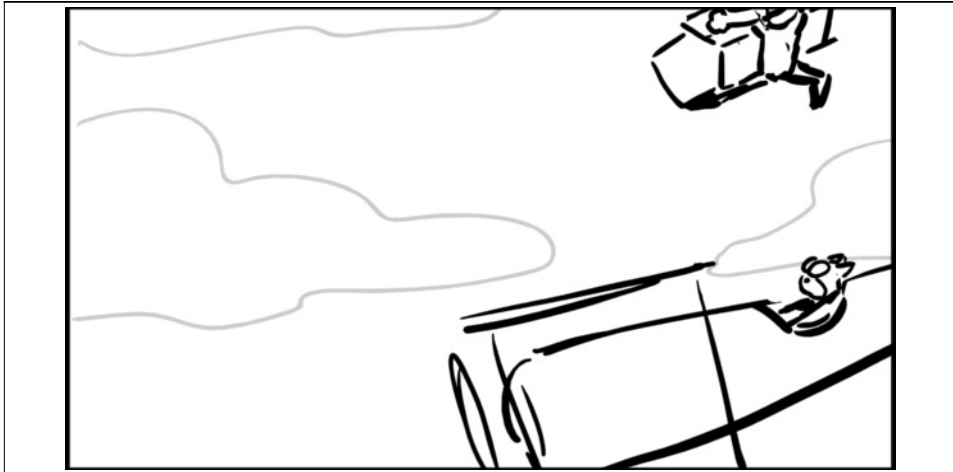

|       |       |
|-------|-------|
| Scene | Panel |
| 58    | 2     |

Action Notes  
- A Pilot tosses a ball of yarn  
into a cat's cockpit.



|       |       |
|-------|-------|
| Scene | Panel |
| 58    | 3     |

Action Notes

- A Pilot tosses a ball of yarn into a cat's cockpit.



|       |       |
|-------|-------|
| Scene | Panel |
| 59    | 1     |

Action Notes

It gets tangled up as it plays with it.



|       |       |
|-------|-------|
| Scene | Panel |
| 59    | 2     |

Action Notes

It gets tangled up as it plays with it.



|       |       |
|-------|-------|
| Scene | Panel |
| 59    | 3     |

Action Notes  
It gets tangled up as it plays with it.



|       |       |
|-------|-------|
| Scene | Panel |
| 60    | 1     |

Action Notes  
Crash!

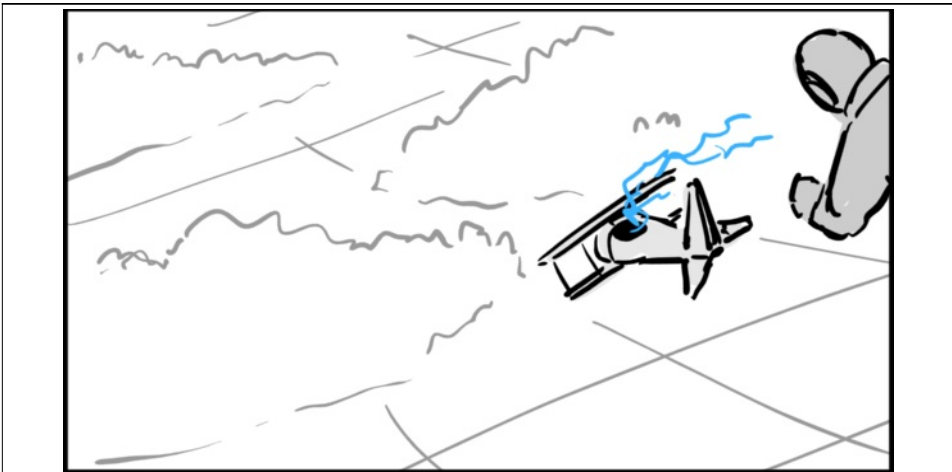

|       |       |
|-------|-------|
| Scene | Panel |
| 60    | 2     |

Action Notes  
Crash!

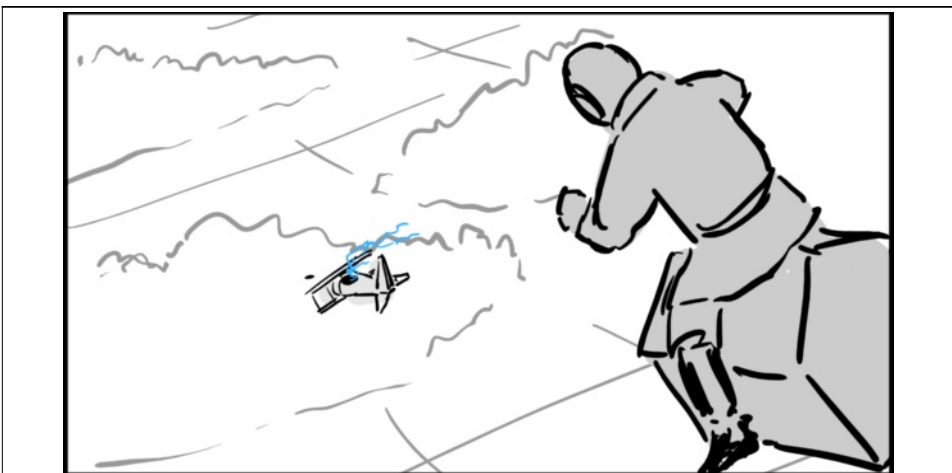

|       |       |
|-------|-------|
| Scene | Panel |
| 60    | 3     |

Action Notes  
Crash!

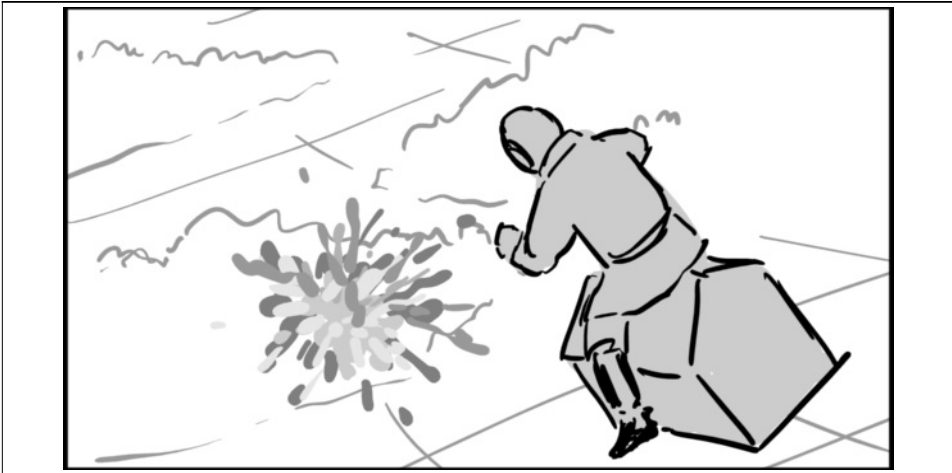

|       |       |
|-------|-------|
| Scene | Panel |
| 60    | 4     |

Action Notes  
Crash!



|       |       |
|-------|-------|
| Scene | Panel |
| 60    | 5     |

Action Notes  
Then the Red Baron swoops in and unloads his guns on the Pilot. He EXPLODES.



|       |       |
|-------|-------|
| Scene | Panel |
| 60    | 6     |



Action Notes

Then the Red Baron swoops in and unloads his guns on the Pilot. He EXPLODES.

|       |       |
|-------|-------|
| Scene | Panel |
| 61    | 1     |



Dialog

157 RED BARON  
Looks like it's time for a cat nap.

|       |       |
|-------|-------|
| Scene | Panel |
| 61    | 2     |



Action Notes

The Red Baron turns his plane around but Snoopy's doghouse rises up behind him.



|       |       |
|-------|-------|
| Scene | Panel |
| 61    | 3     |



Action Notes

The Red Baron turns his plane around but Snoopy's doghouse rises up behind him.

|       |       |
|-------|-------|
| Scene | Panel |
| 61    | 4     |



Action Notes

The Red Baron turns his plane around but Snoopy's doghouse rises up behind him.

|       |       |
|-------|-------|
| Scene | Panel |
| 62    | 1     |



Action Notes

Snoopy's got cuts and scratches all over his nose and head from his cat fight. He shakes his fist at the Red Baron.

|       |       |
|-------|-------|
| Scene | Panel |
| 62    | 2     |

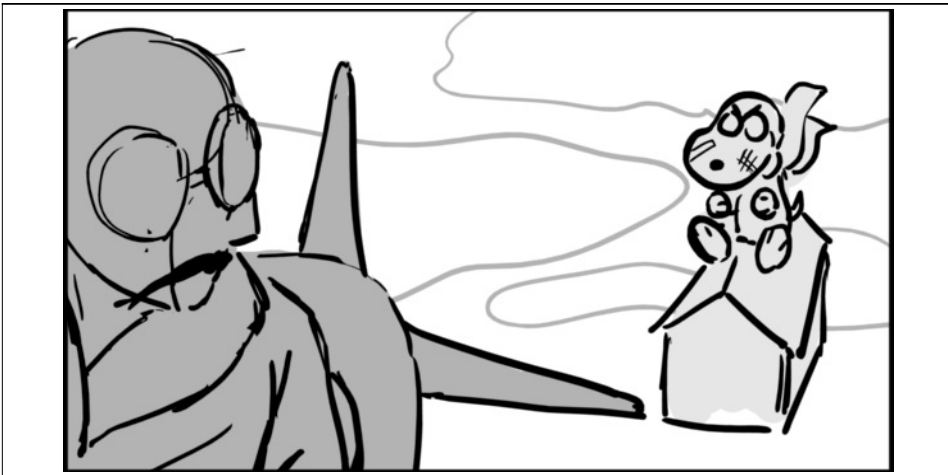

## Action Notes

Snoopy's got cuts and scratches all over his nose and head from his cat fight. He shakes his fist at the Red Baron.

|       |       |
|-------|-------|
| Scene | Panel |
| 62    | 3     |



## Action Notes

Snoopy's got cuts and scratches all over his nose and head from his cat fight. He shakes his fist at the Red Baron.

|       |       |
|-------|-------|
| Scene | Panel |
| 62    | 4     |



## Action Notes

Snoopy's got cuts and scratches all over his nose and head from his cat fight. He shakes his fist at the Red Baron.

|       |       |
|-------|-------|
| Scene | Panel |
| 62    | 5     |

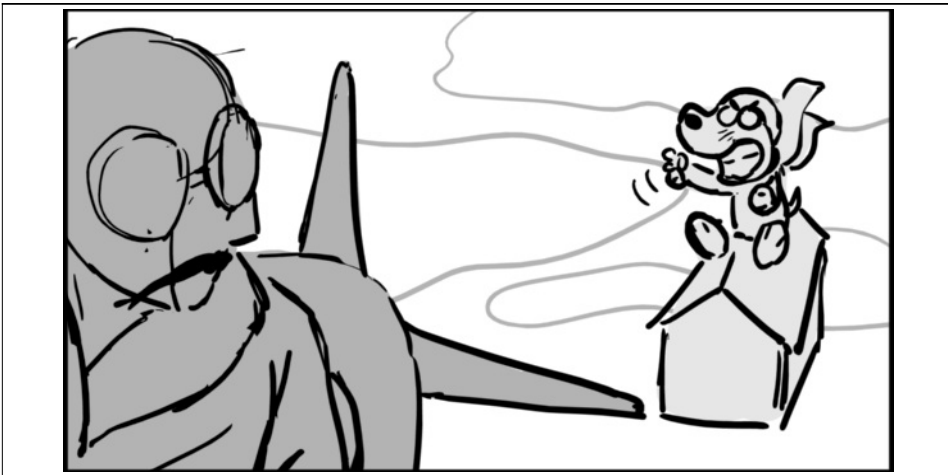

## Action Notes

Snoopy's got cuts and scratches all over his nose and head from his cat fight. He shakes his fist at the Red Baron.

|       |       |
|-------|-------|
| Scene | Panel |
| 62    | 6     |

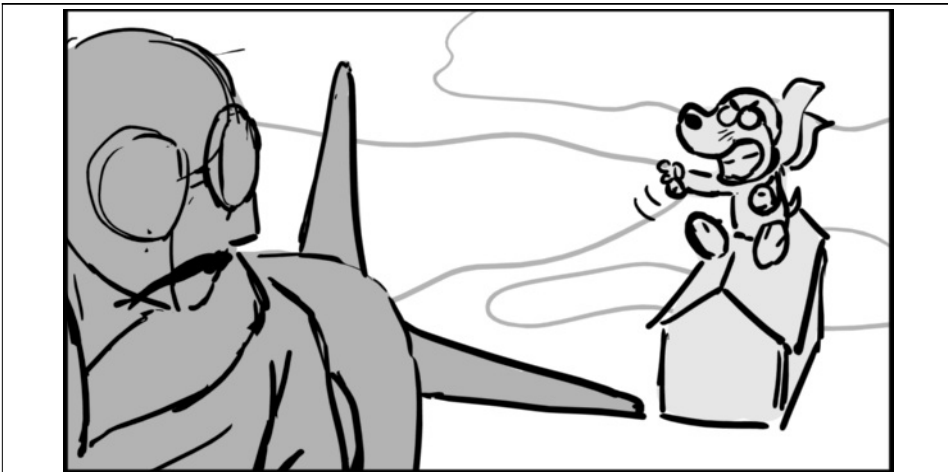

## Action Notes

Snoopy's got cuts and scratches all over his nose and head from his cat fight. He shakes his fist at the Red Baron.

|       |       |
|-------|-------|
| Scene | Panel |
| 62    | 7     |

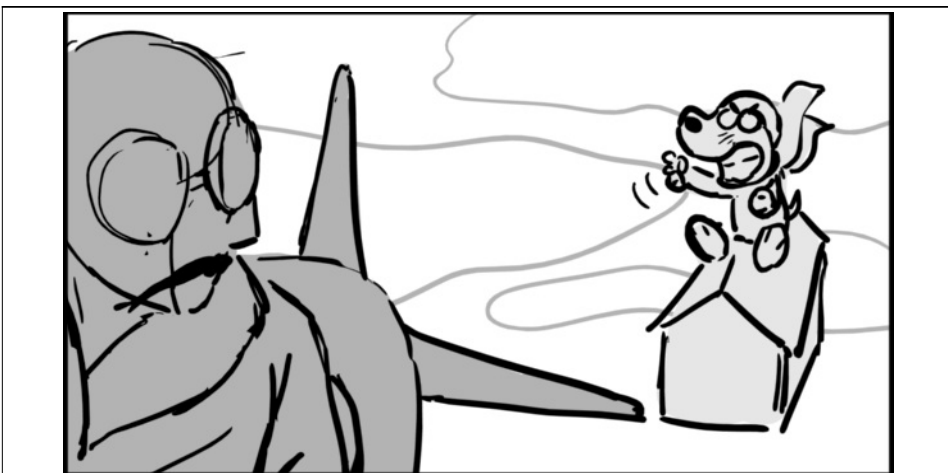

## Action Notes

Snoopy's got cuts and scratches all over his nose and head from his cat fight. He shakes his fist at the Red Baron.

|       |       |
|-------|-------|
| Scene | Panel |
| 62    | 8     |

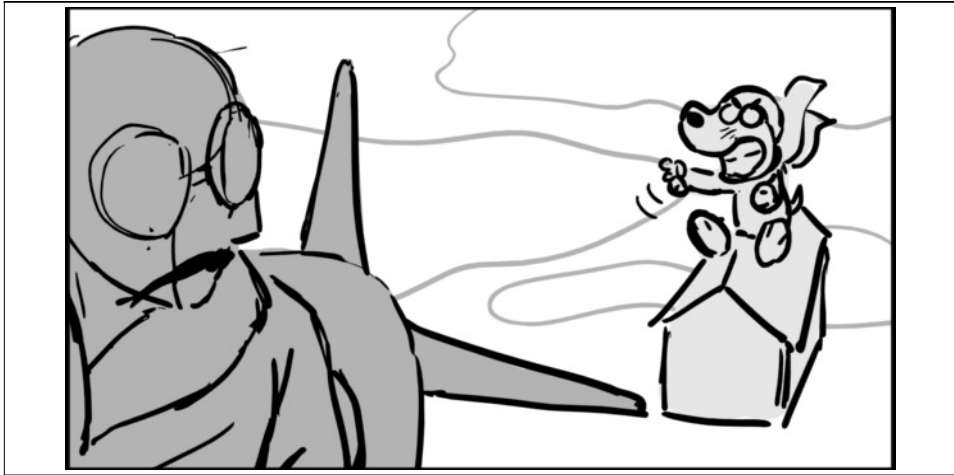

**Action Notes**  
 Snoopy's got cuts and scratches all over his nose and head from his cat fight. He shakes his fist at the Red Baron.

|       |       |
|-------|-------|
| Scene | Panel |
| 63    | 1     |



**Action Notes**  
 They have an incredible dogfight with spins and twists and turns. The Red Baron is quick and tricky, always outmaneuvering Snoopy

|       |       |
|-------|-------|
| Scene | Panel |
| 63    | 2     |

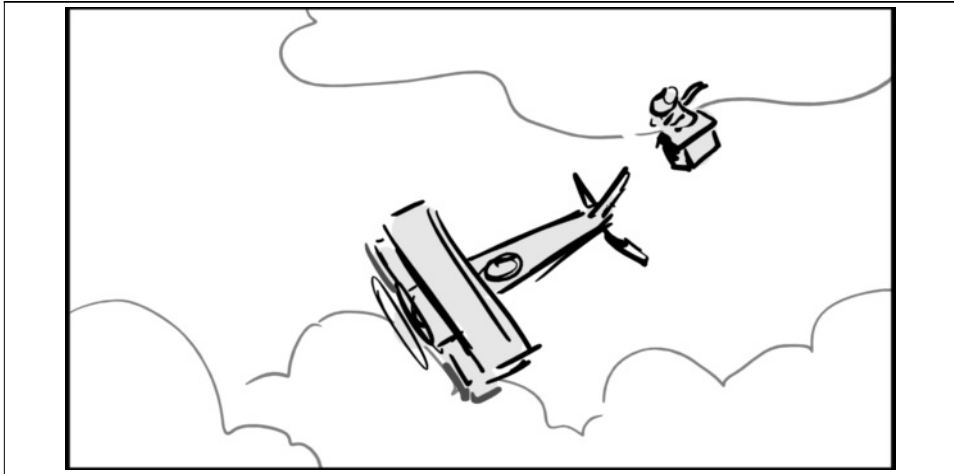

**Action Notes**  
 They have an incredible dogfight with spins and twists and turns. The Red Baron is quick and tricky, always outmaneuvering Snoopy

|       |       |
|-------|-------|
| Scene | Panel |
| 63    | 3     |

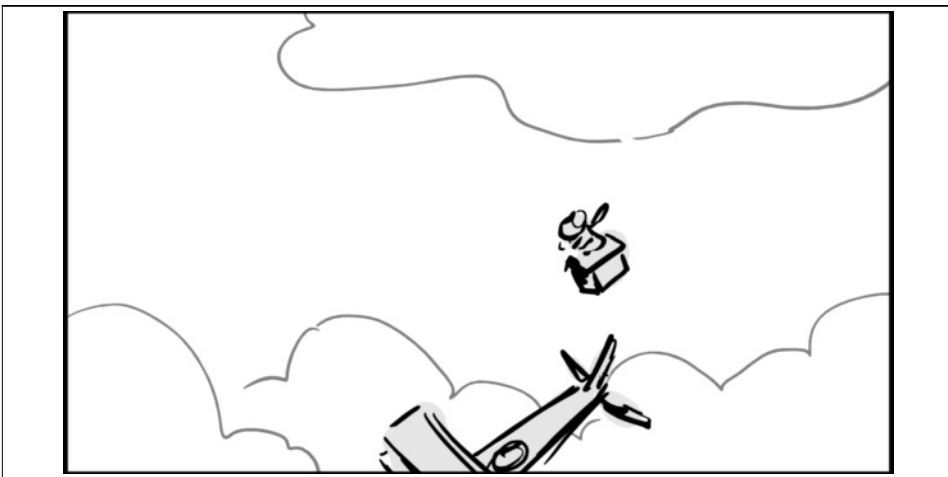

## Action Notes

They have an incredible dogfight with spins and twists and turns. The Red Baron is quick and tricky, always outmaneuvering Snoopy

|       |       |
|-------|-------|
| Scene | Panel |
| 64    | 1     |

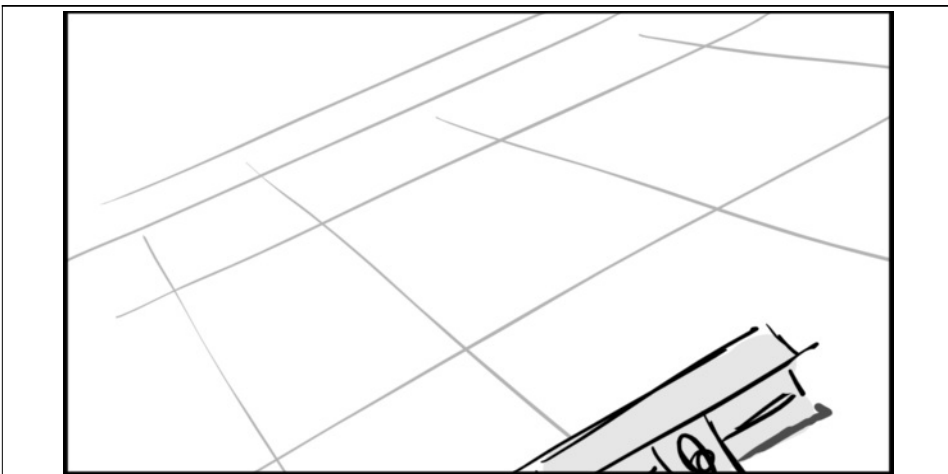

## Action Notes

They have an incredible dogfight with spins and twists and turns. The Red Baron is quick and tricky, always outmaneuvering Snoopy

|       |       |
|-------|-------|
| Scene | Panel |
| 64    | 2     |

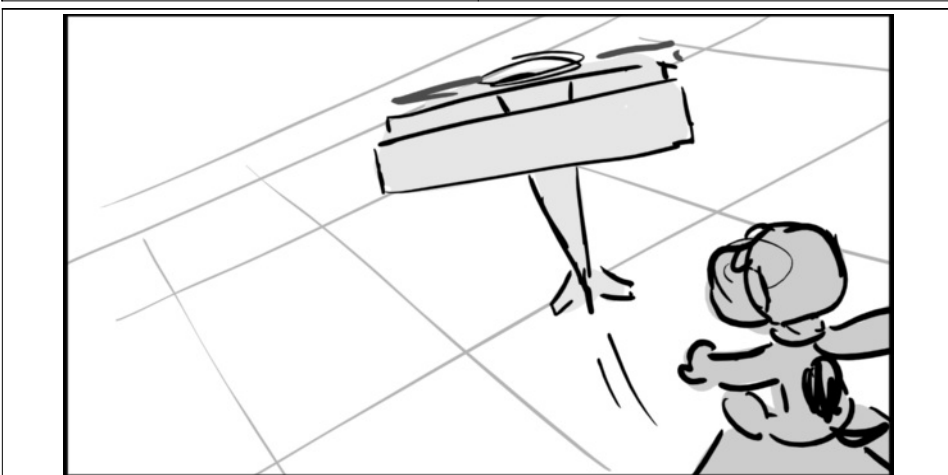

## Action Notes

They have an incredible dogfight with spins and twists and turns. The Red Baron is quick and tricky, always outmaneuvering Snoopy

|       |       |
|-------|-------|
| Scene | Panel |
| 64    | 3     |

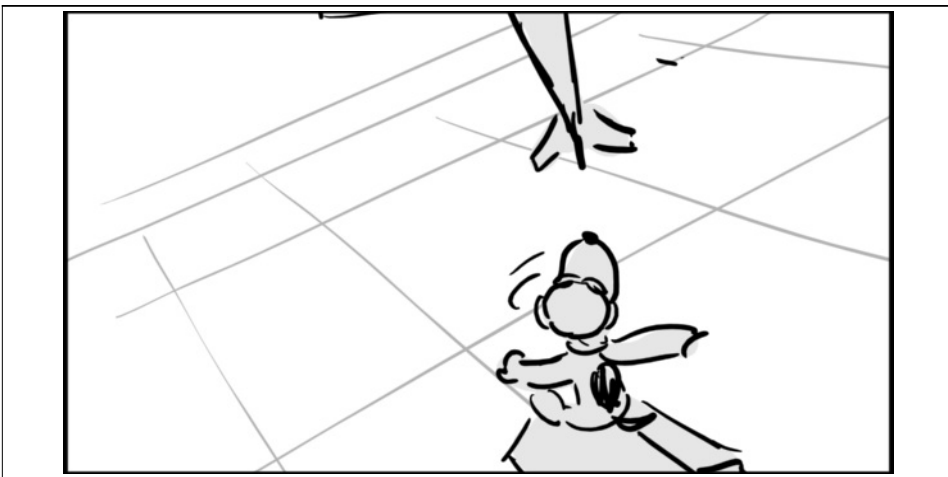

## Action Notes

They have an incredible dogfight with spins and twists and turns. The Red Baron is quick and tricky, always outmaneuvering Snoopy

|       |       |
|-------|-------|
| Scene | Panel |
| 64    | 4     |

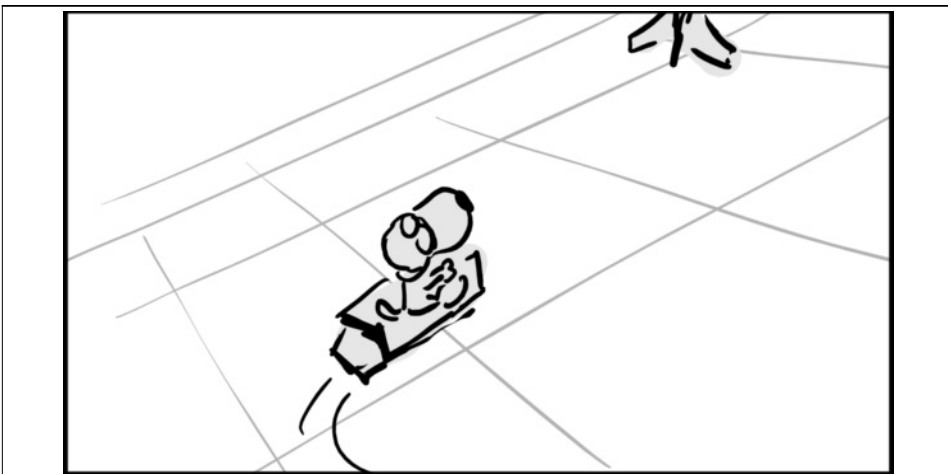

## Action Notes

They have an incredible dogfight with spins and twists and turns. The Red Baron is quick and tricky, always outmaneuvering Snoopy

|       |       |
|-------|-------|
| Scene | Panel |
| 65    | 1     |

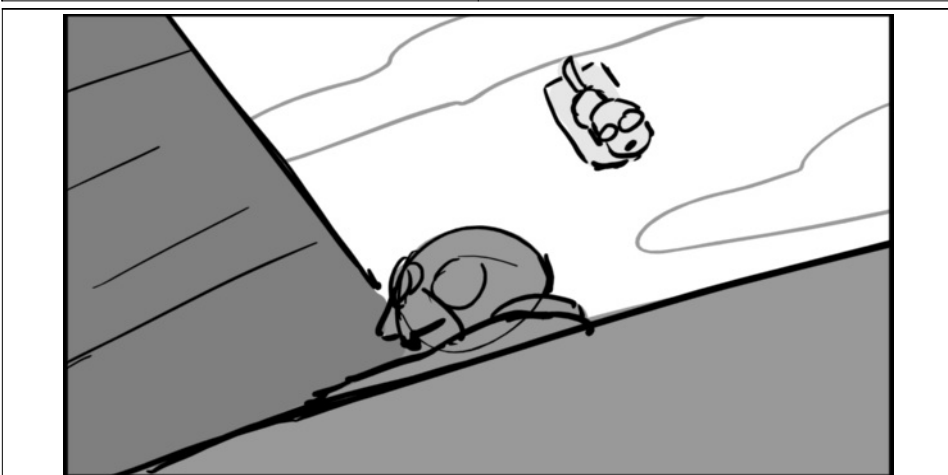

## Action Notes

They have an incredible dogfight with spins and twists and turns. The Red Baron is quick and tricky, always outmaneuvering Snoopy

|       |       |
|-------|-------|
| Scene | Panel |
| 65    | 2     |

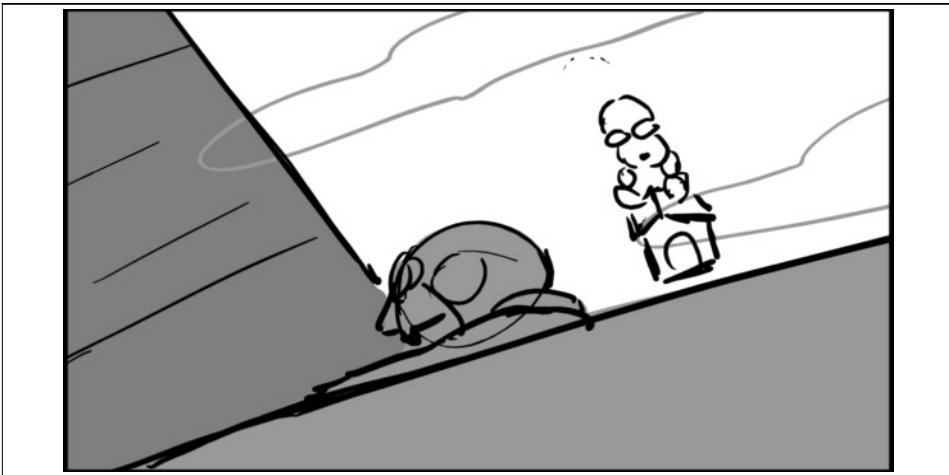

## Action Notes

They have an incredible dogfight with spins and twists and turns. The Red Baron is quick and tricky, always outmaneuvering Snoopy

|       |       |
|-------|-------|
| Scene | Panel |
| 65    | 3     |



## Action Notes

They have an incredible dogfight with spins and twists and turns. The Red Baron is quick and tricky, always outmaneuvering Snoopy

|       |       |
|-------|-------|
| Scene | Panel |
| 65    | 4     |



## Action Notes

They have an incredible dogfight with spins and twists and turns. The Red Baron is quick and tricky, always outmaneuvering Snoopy

|       |       |
|-------|-------|
| Scene | Panel |
| 65    | 5     |



## Action Notes

They have an incredible dogfight with spins and twists and turns. The Red Baron is quick and tricky, always outmaneuvering Snoopy

|       |       |
|-------|-------|
| Scene | Panel |
| 65    | 6     |

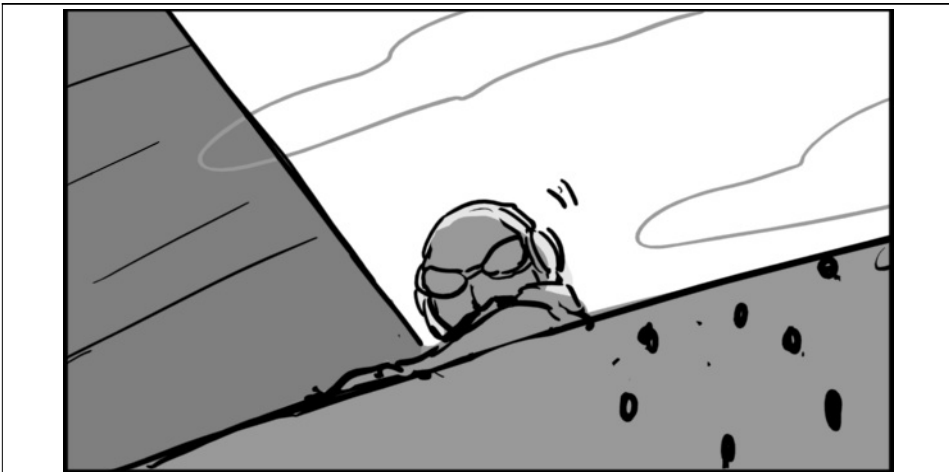

## Action Notes

They have an incredible dogfight with spins and twists and turns. The Red Baron is quick and tricky, always outmaneuvering Snoopy

|       |       |
|-------|-------|
| Scene | Panel |
| 66    | 1     |



## Action Notes

They have an incredible dogfight with spins and twists and turns. The Red Baron is quick and tricky, always outmaneuvering Snoopy



|       |       |
|-------|-------|
| Scene | Panel |
| 66    | 2     |

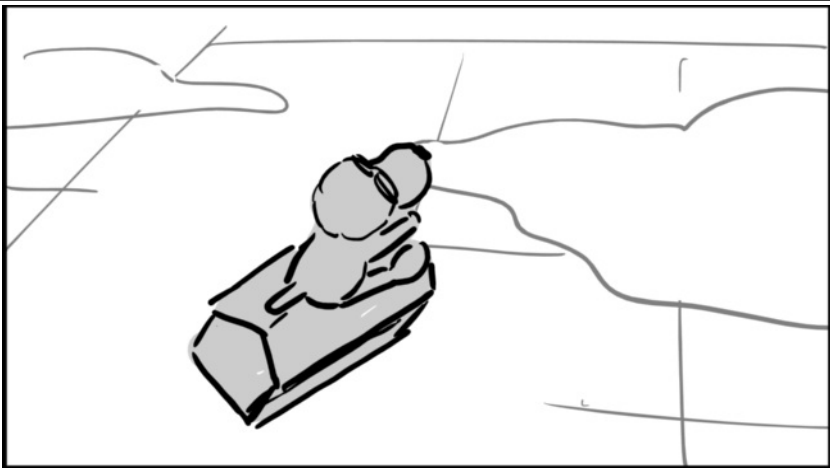

Action Notes

They have an incredible dogfight with spins and twists and turns. The Red Baron is quick and tricky, always outmaneuvering Snoopy

|       |       |
|-------|-------|
| Scene | Panel |
| 66    | 3     |

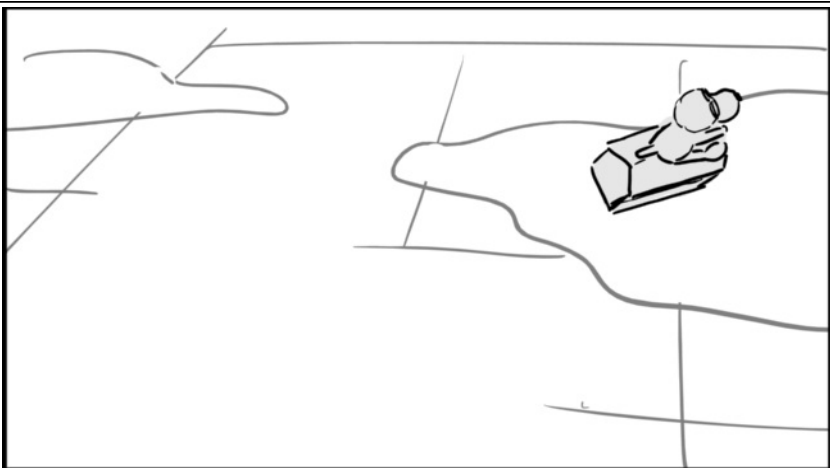

Action Notes

They have an incredible dogfight with spins and twists and turns. The Red Baron is quick and tricky, always outmaneuvering Snoopy

|       |       |
|-------|-------|
| Scene | Panel |
| 67    | 1     |



Action Notes

They have an incredible dogfight with spins and twists and turns. The Red Baron is quick and tricky, always outmaneuvering Snoopy

|       |       |
|-------|-------|
| Scene | Panel |
| 67    | 2     |



**Action Notes**  
 They have an incredible dogfight with spins and twists and turns. The Red Baron is quick and tricky, always outmaneuvering Snoopy

|       |       |
|-------|-------|
| Scene | Panel |
| 68    | 1     |

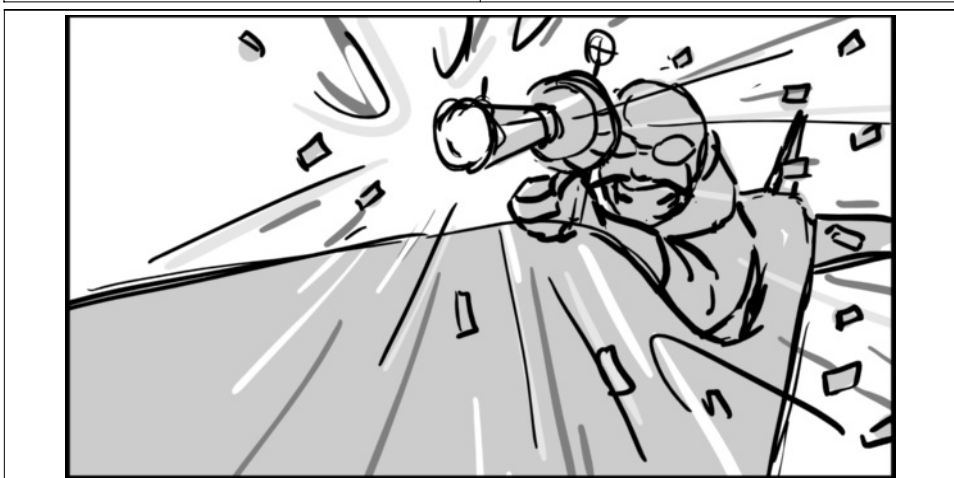

**Action Notes**  
 They have an incredible dogfight with spins and twists and turns. The Red Baron is quick and tricky, always outmaneuvering Snoopy He fires his machine gun, peppering Snoopy's doghouse.

|       |       |
|-------|-------|
| Scene | Panel |
| 69    | 1     |

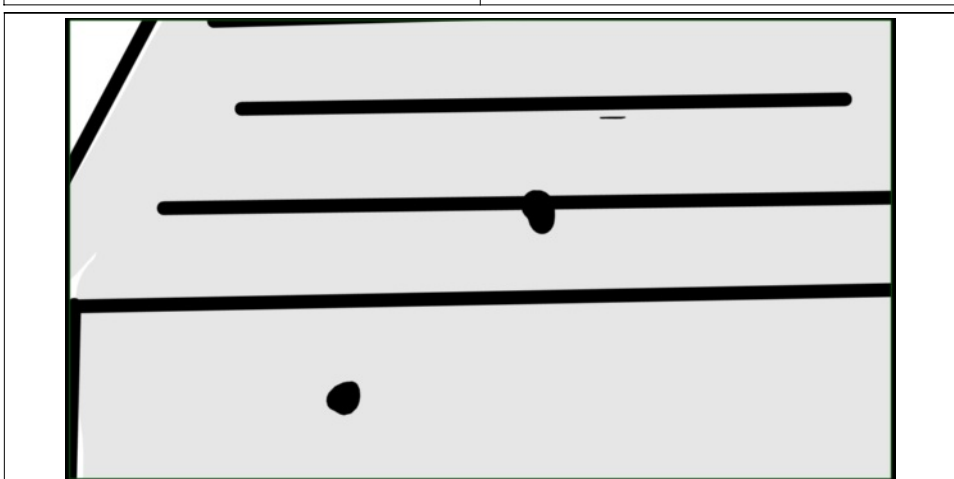

**Action Notes**  
 He fires his machine gun, peppering Snoopy's doghouse.

|       |       |
|-------|-------|
| Scene | Panel |
| 69    | 2     |

Action Notes  
He fires his machine gun, peppering Snoopy's doghouse.

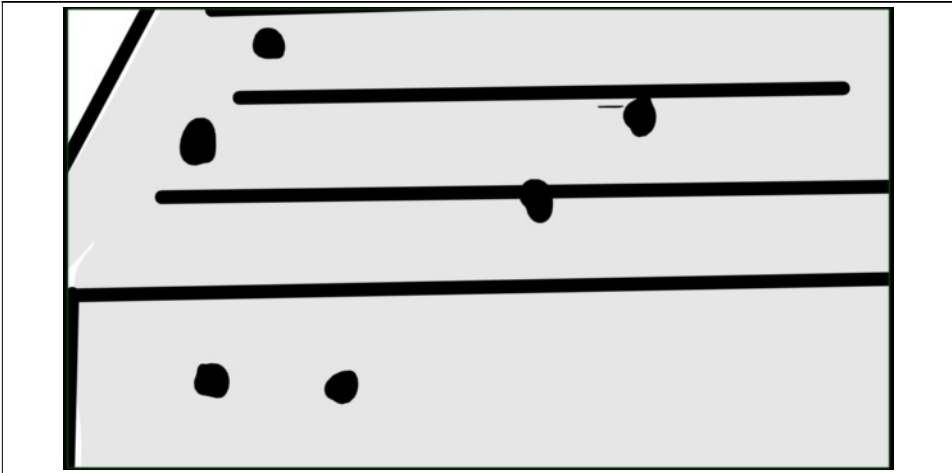

|       |       |
|-------|-------|
| Scene | Panel |
| 69    | 3     |

Action Notes  
He fires his machine gun, peppering Snoopy's doghouse.

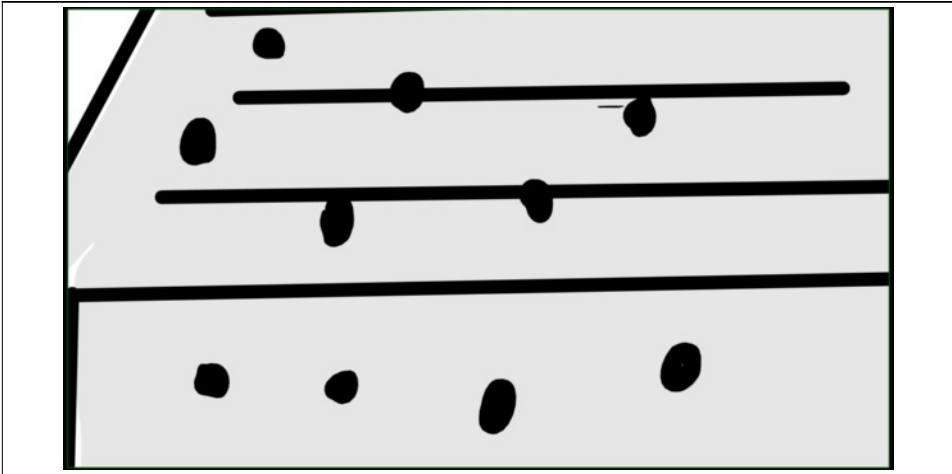

|       |       |
|-------|-------|
| Scene | Panel |
| 69    | 4     |

Action Notes  
Black smoke erupts from inside. Snoopy loses control. The Red Baron circles around for the kill.

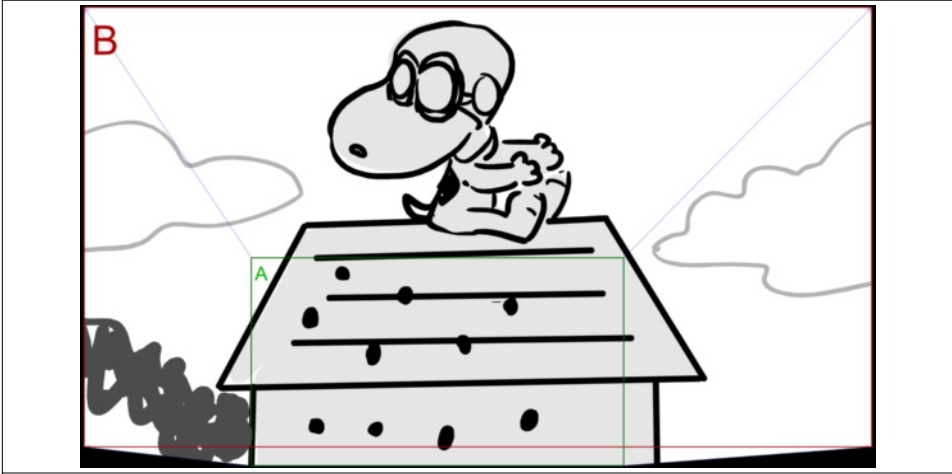

|       |       |
|-------|-------|
| Scene | Panel |
| 69    | 5     |



Action Notes

Black smoke erupts from inside. Snoopy loses control. The Red Baron circles around for the kill.

|       |       |
|-------|-------|
| Scene | Panel |
| 69    | 6     |



Action Notes

Black smoke erupts from inside. Snoopy loses control. The Red Baron circles around for the kill.

|       |       |
|-------|-------|
| Scene | Panel |
| 70    | 1     |

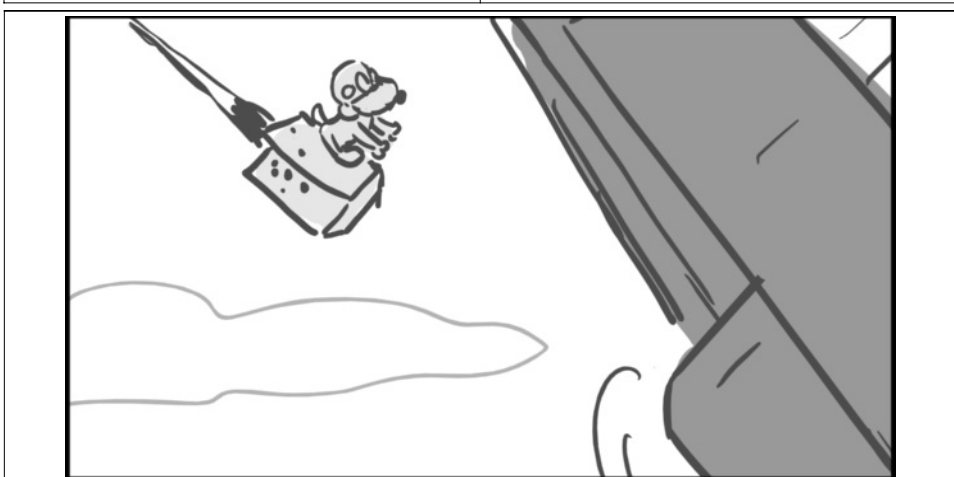

Action Notes

The Red Baron circles around for the kill.

|       |       |
|-------|-------|
| Scene | Panel |
| 70    | 2     |

Action Notes  
The Red Baron circles around for the kill.

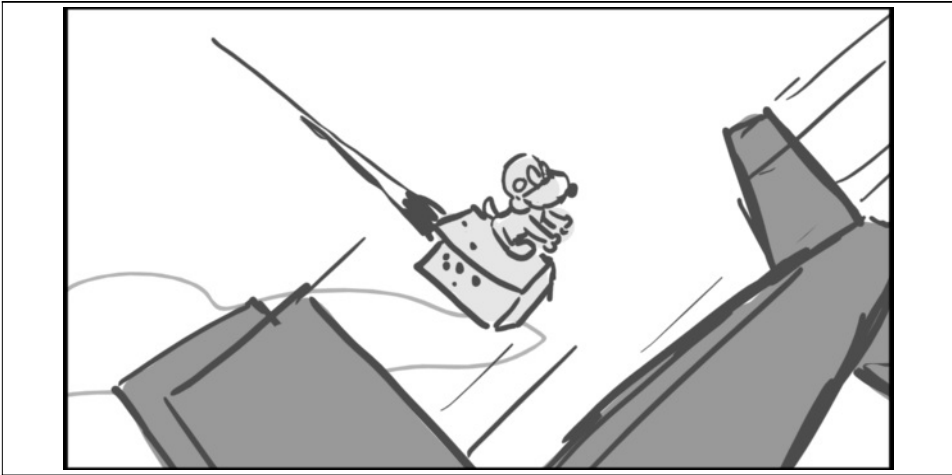

|       |       |
|-------|-------|
| Scene | Panel |
| 70    | 3     |

Action Notes  
The Red Baron circles around for the kill.

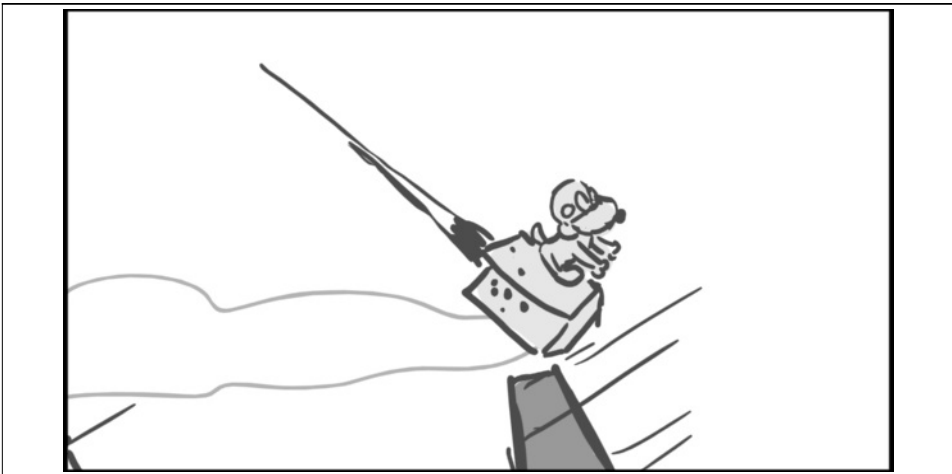

|       |       |
|-------|-------|
| Scene | Panel |
| 70    | 4     |

Action Notes  
The Red Baron circles around for the kill.

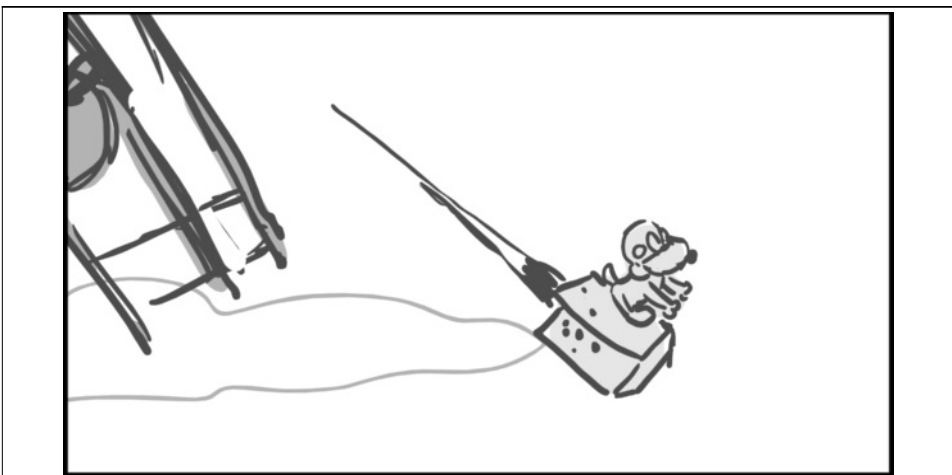

Scene 70 Panel 5

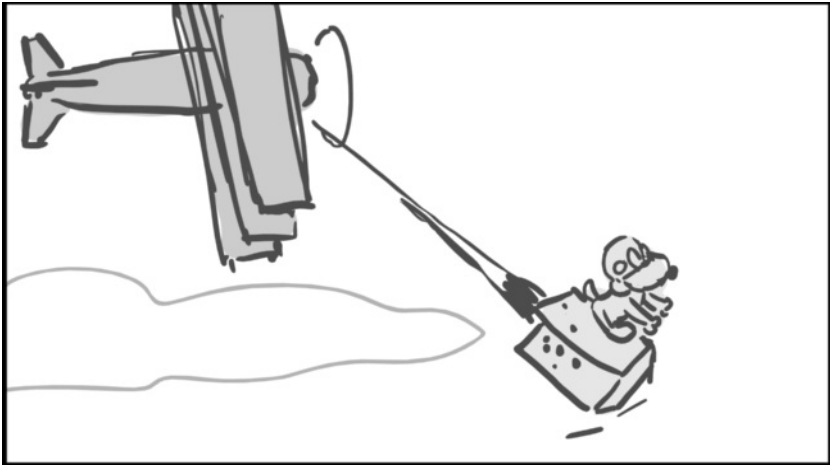

Action Notes  
The Red Baron circles around for the kill.

Scene 70 Panel 6

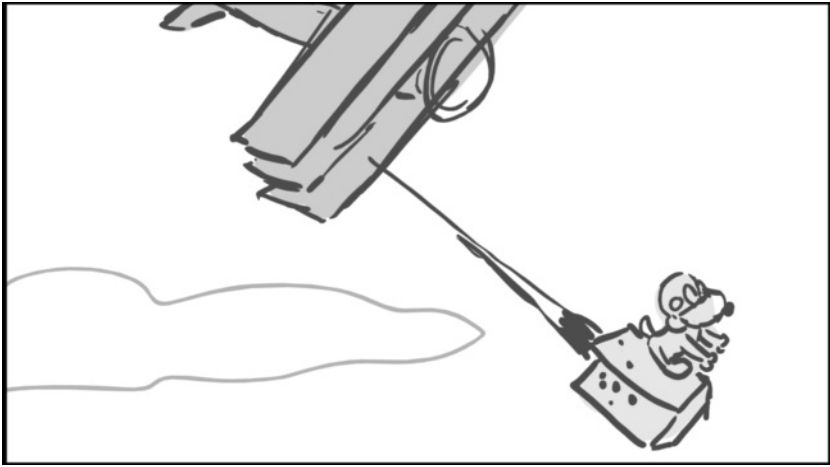

Action Notes  
The Red Baron circles around for the kill.

Scene 71 Panel 1

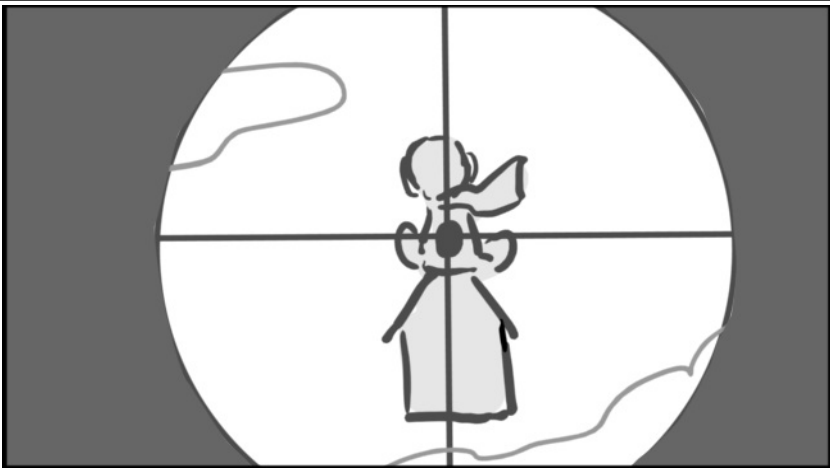

Action Notes  
158 REDBARON(CONT'D) Auf Wiedersehen du dummer Hund.

|       |       |
|-------|-------|
| Scene | Panel |
| 71    | 2     |

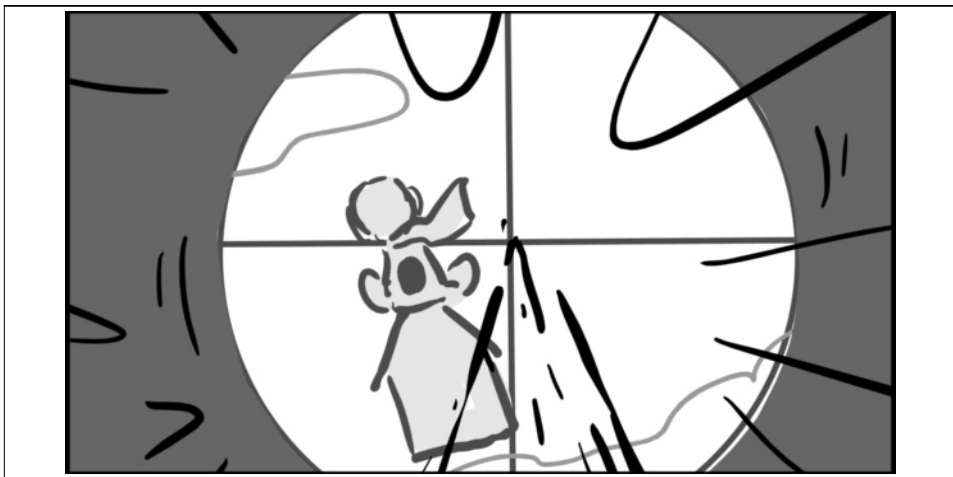

Action Notes

The Red Baron opens fire. Snoopy loops up and around, hanging upside down over the Red Baron's plane.

|       |       |
|-------|-------|
| Scene | Panel |
| 71    | 3     |

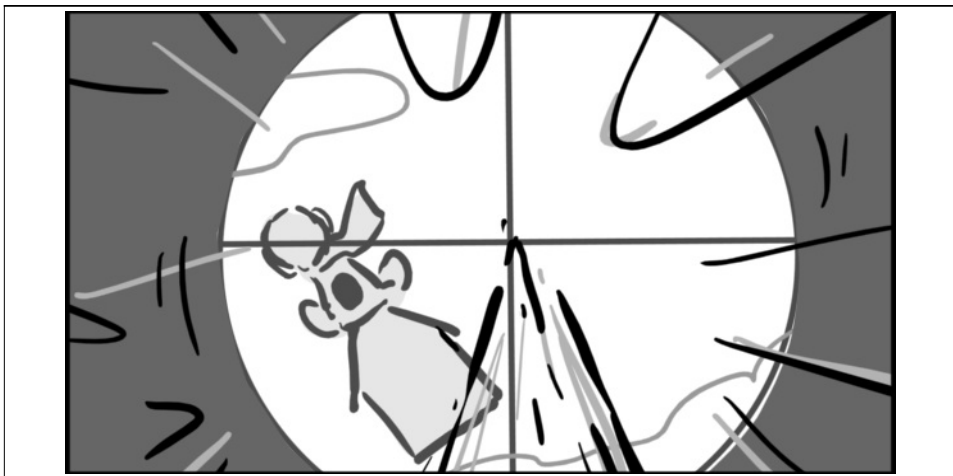

Action Notes

The Red Baron opens fire. Snoopy loops up and around, hanging upside down over the Red Baron's plane.

|       |       |
|-------|-------|
| Scene | Panel |
| 71    | 4     |

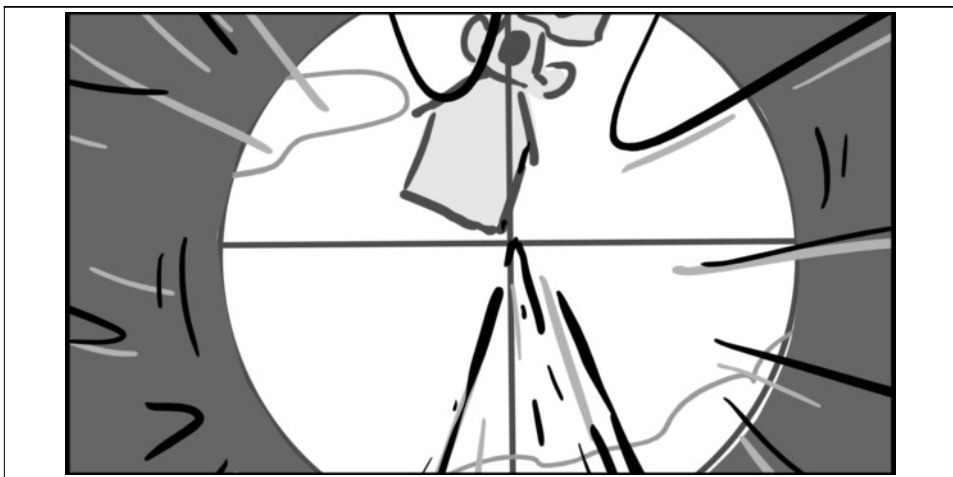

Action Notes

The Red Baron opens fire. Snoopy loops up and around, hanging upside down over the Red Baron's plane.

|       |       |
|-------|-------|
| Scene | Panel |
| 71    | 5     |

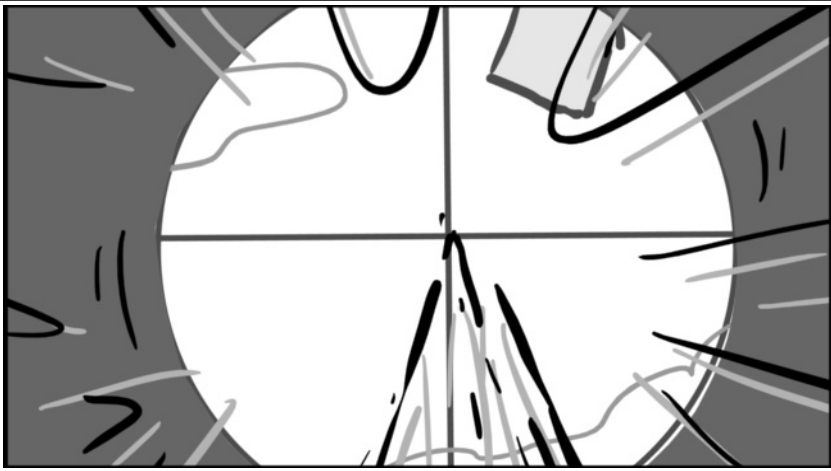

Action Notes

The Red Baron opens fire. Snoopy loops up and around, hanging upside down over the Red Baron's plane.

|       |       |
|-------|-------|
| Scene | Panel |
| 72    | 1     |



Action Notes

The Red Baron opens fire. Snoopy loops up and around, hanging upside down over the Red Baron's plane.

|       |       |
|-------|-------|
| Scene | Panel |
| 72    | 2     |

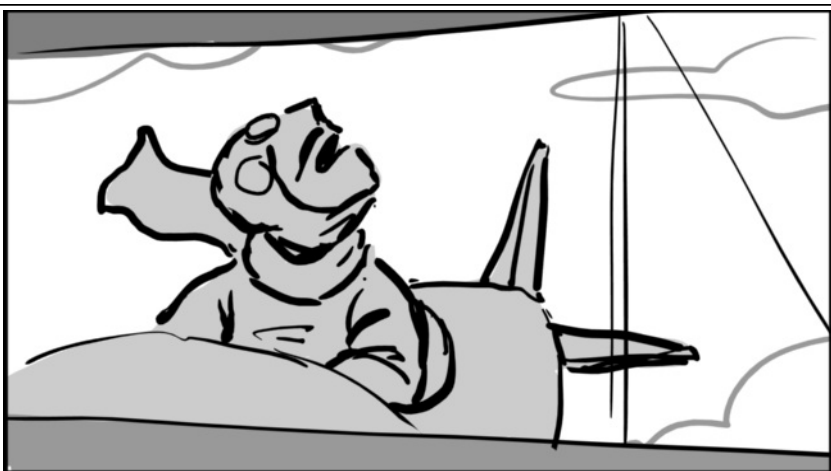

Action Notes

The Red Baron opens fire. Snoopy loops up and around, hanging upside down over the Red Baron's plane.



|       |       |   |
|-------|-------|---|
| Scene | Panel |   |
|       | 72    | 3 |



Action Notes

The Red Baron opens fire. Snoopy loops up and around, hanging upside down over the Red Baron's plane.

|       |       |   |
|-------|-------|---|
| Scene | Panel |   |
|       | 72    | 4 |



Action Notes

The Red Baron opens fire. Snoopy loops up and around, hanging upside down over the Red Baron's plane.

|       |       |   |
|-------|-------|---|
| Scene | Panel |   |
|       | 72    | 5 |



Action Notes

He gives him a lick.

|       |       |
|-------|-------|
| Scene | Panel |
| 72    | 6     |

Action Notes  
He gives him a lick.



|       |       |
|-------|-------|
| Scene | Panel |
| 72    | 7     |

Action Notes  
He gives him a lick.



|       |       |
|-------|-------|
| Scene | Panel |
| 72    | 8     |

Dialog  
159 REDBARON(CONT'D)  
Uch! I haff dog germs! Get der hot water! Get der disinfectant! Get der iodine!



|       |       |
|-------|-------|
| Scene | Panel |
| 72    | 9     |



Dialog  
 159 REDBARON(CONT'D)  
 Uch! I haff dog germs! Get der hot water! Get der disinfectant! Get der iodine!  
 160 SNOOPY <LAUGHS>

|       |       |
|-------|-------|
| Scene | Panel |
| 72    | 10    |



Dialog  
 159 REDBARON(CONT'D)  
 Uch! I haff dog germs! Get der hot water! Get der disinfectant! Get der iodine!  
 160 SNOOPY <LAUGHS>

|       |       |
|-------|-------|
| Scene | Panel |
| 72    | 11    |



Dialog  
 159 REDBARON(CONT'D)  
 Uch! I haff dog germs! Get der hot water! Get der disinfectant! Get der iodine!  
 160 SNOOPY <LAUGHS>

|       |       |
|-------|-------|
| Scene | Panel |
| 72    | 12    |



Dialog  
 159 REDBARON(CONT'D)  
 Uch! I haff dog germs! Get der hot water! Get der disinfectant! Get der iodine!  
 160 SNOOPY <LAUGHS>

|       |       |
|-------|-------|
| Scene | Panel |
| 72    | 13    |



Dialog  
 159 REDBARON(CONT'D)  
 Uch! I haff dog germs! Get der hot water! Get der disinfectant! Get der iodine!  
 160 SNOOPY <LAUGHS>

|       |       |
|-------|-------|
| Scene | Panel |
| 73    | 1     |



Action Notes  
 He quickly drops in behind him

|       |       |
|-------|-------|
| Scene | Panel |
| 73    | 2     |

Action Notes  
He quickly drops in behind him

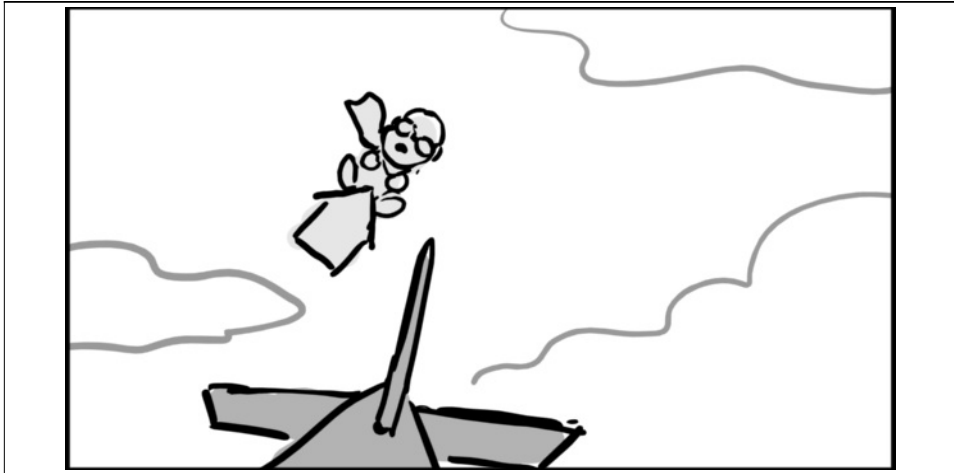

|       |       |
|-------|-------|
| Scene | Panel |
| 73    | 3     |

Action Notes  
He quickly drops in behind him



|       |       |
|-------|-------|
| Scene | Panel |
| 74    | 1     |

Action Notes  
He quickly drops in behind him and OPENS FIRE, fists clutching his imaginary machine guns.



|       |       |
|-------|-------|
| Scene | Panel |
| 74    | 2     |



Action Notes

He quickly drops in behind him and OPENS FIRE, fists clutching his imaginary machine guns.

|       |       |
|-------|-------|
| Scene | Panel |
| 75    | 1     |

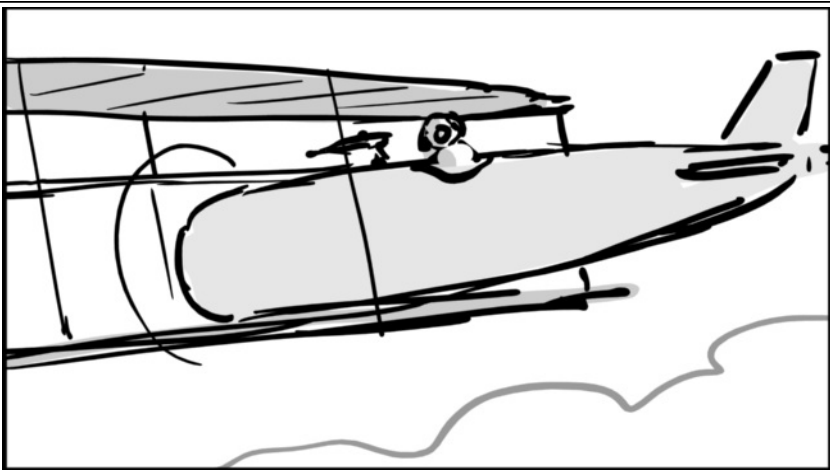

Action Notes

The Red Baron's plane gets hammered by REAL BULLETS.

|       |       |
|-------|-------|
| Scene | Panel |
| 75    | 2     |

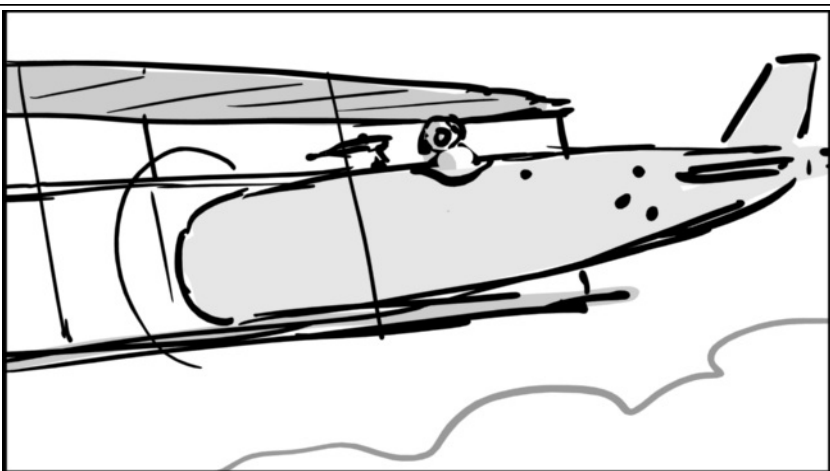

Action Notes

The Red Baron's plane gets hammered by REAL BULLETS.

|       |       |
|-------|-------|
| Scene | Panel |
| 75    | 3     |

Action Notes  
The Red Baron's plane gets hammered by REAL BULLETS.

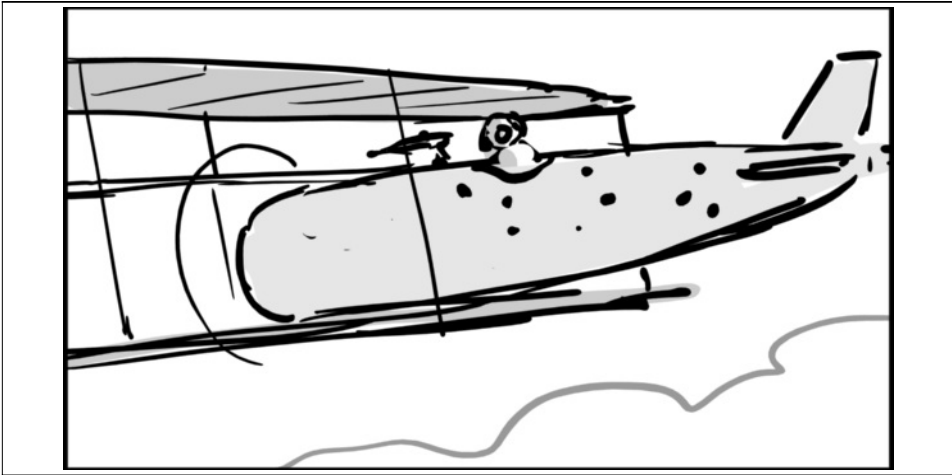

|       |       |
|-------|-------|
| Scene | Panel |
| 75    | 4     |

Action Notes  
The Red Baron's plane gets hammered by REAL BULLETS.

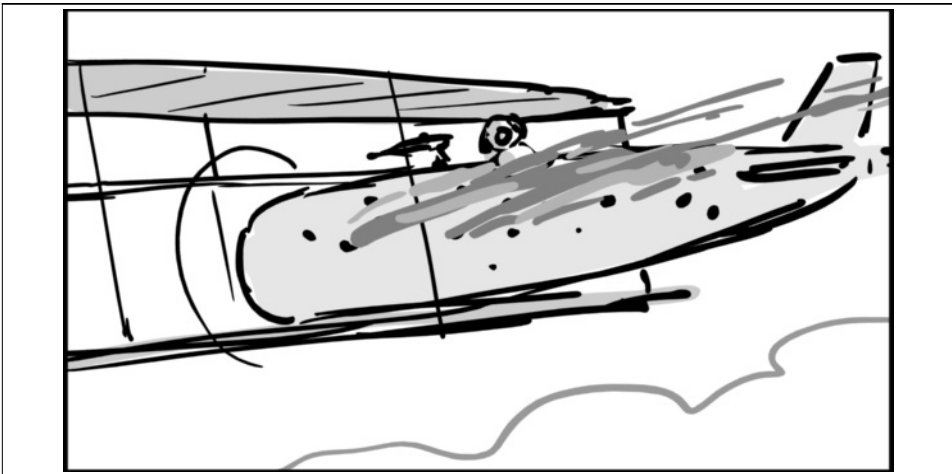

|       |       |
|-------|-------|
| Scene | Panel |
| 75    | 5     |

Action Notes  
The Red Baron's plane gets hammered by REAL BULLETS.

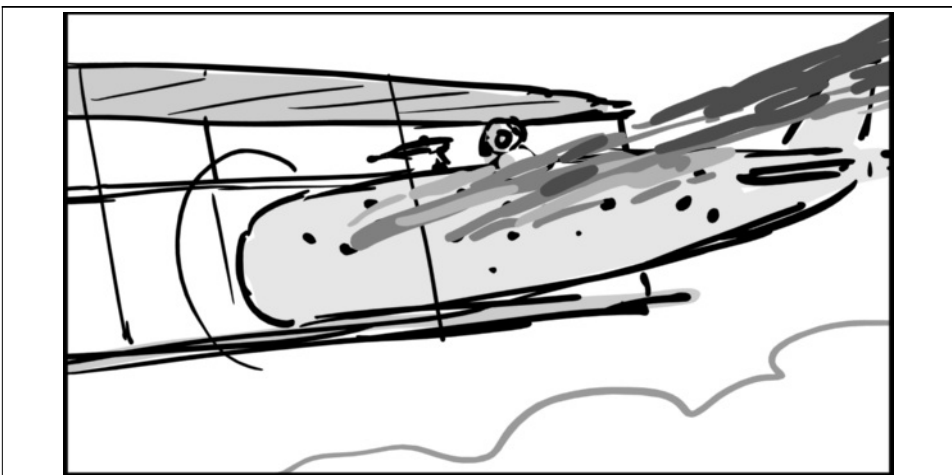

|             |            |  |
|-------------|------------|--|
| Scene<br>76 | Panel<br>1 | <p>Action Notes</p> <p>Black smoke billows from his engine. He fights for control but can't steady it.</p> |
| Scene<br>76 | Panel<br>2 | <p>Action Notes</p> <p>Black smoke billows from his engine. He fights for control but can't steady it.</p> |
| Scene<br>76 | Panel<br>3 | <p>Action Notes</p> <p>Black smoke billows from his engine. He fights for control but can't steady it.</p> |

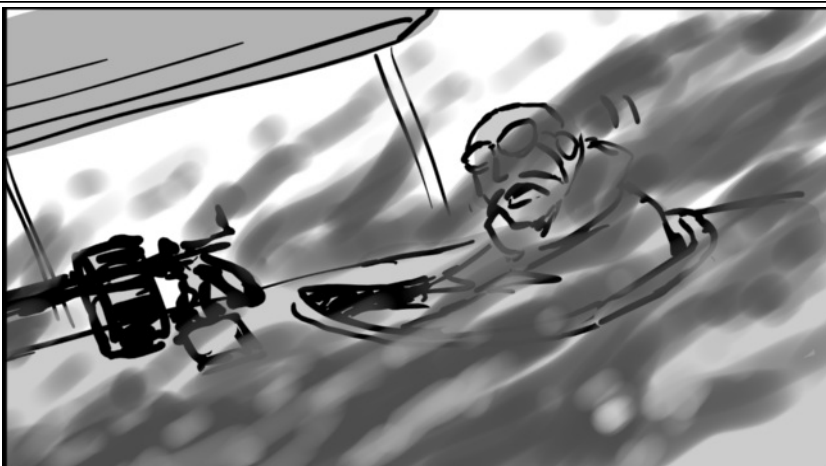
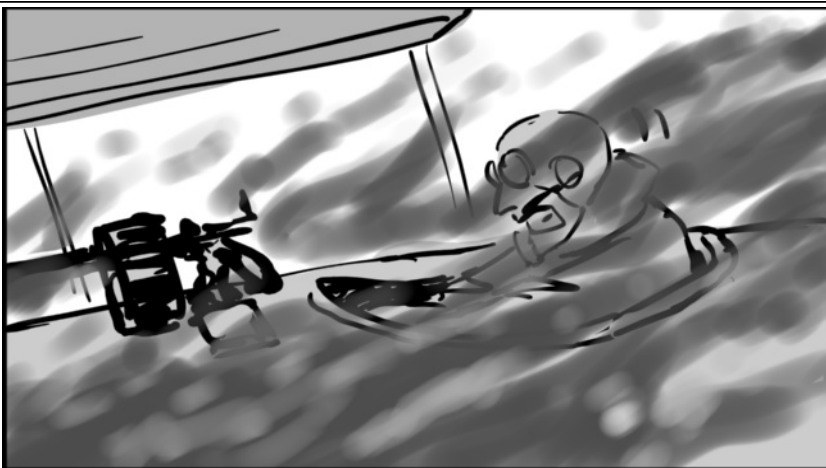
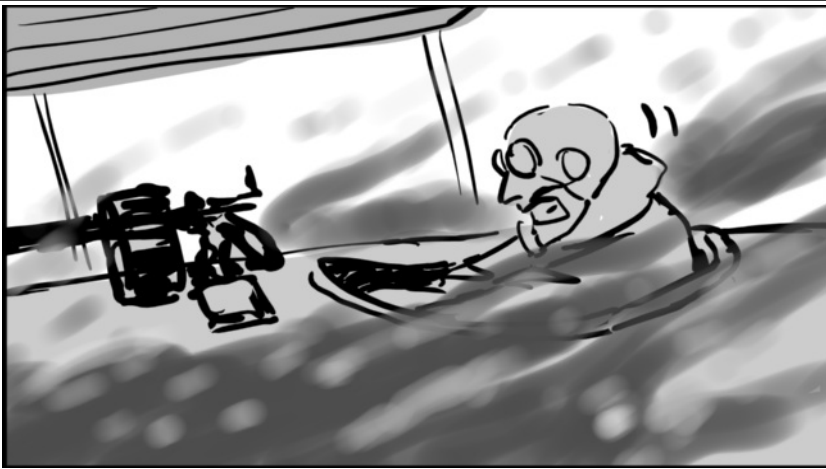



|       |       |
|-------|-------|
| Scene | Panel |
| 76    | 4     |

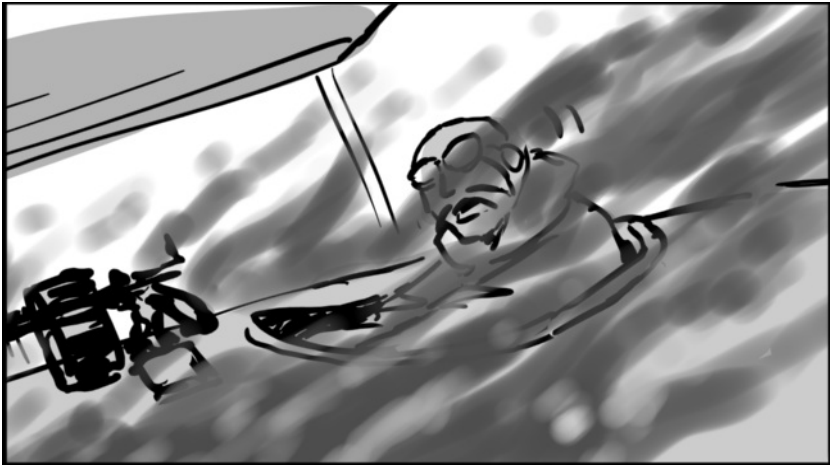

Action Notes  
Black smoke billows from his engine. He fights for control but can't steady it.

|       |       |
|-------|-------|
| Scene | Panel |
| 77    | 1     |

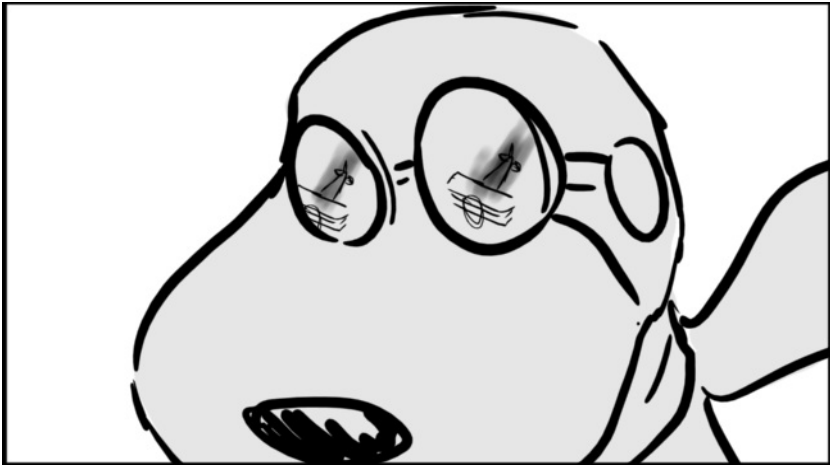

Action Notes  
His plane goes into a dive. It hits the ground and EXPLODES!

|       |       |
|-------|-------|
| Scene | Panel |
| 77    | 2     |



Action Notes  
His plane goes into a dive. It hits the ground and EXPLODES!

|       |       |
|-------|-------|
| Scene | Panel |
| 77    | 3     |

Action Notes

His plane goes into a dive. It hits the ground and EXPLODES!

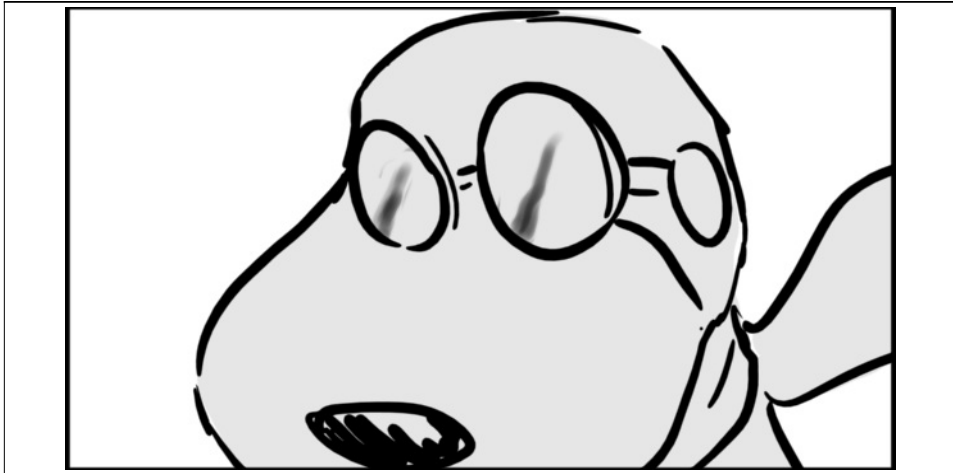

|       |       |
|-------|-------|
| Scene | Panel |
| 77    | 4     |

Action Notes

His plane goes into a dive. It hits the ground and EXPLODES!

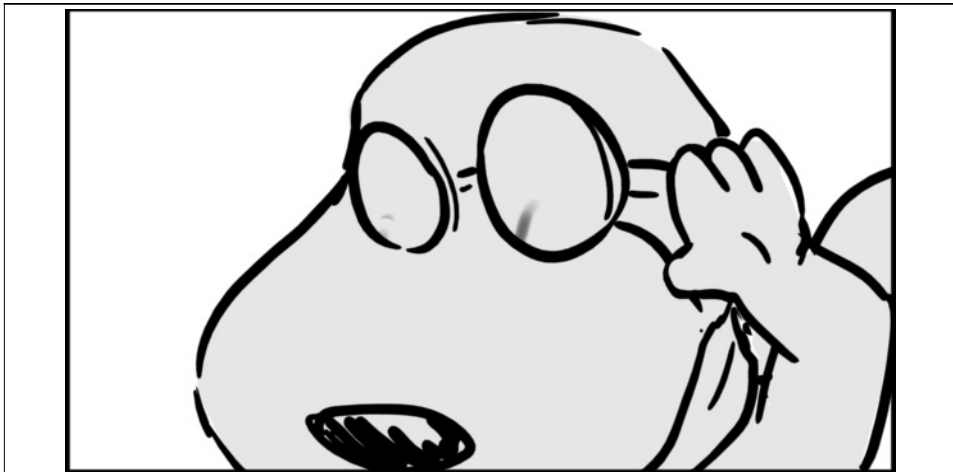

|       |       |
|-------|-------|
| Scene | Panel |
| 77    | 5     |

Action Notes

His plane goes into a dive. It hits the ground and EXPLODES!

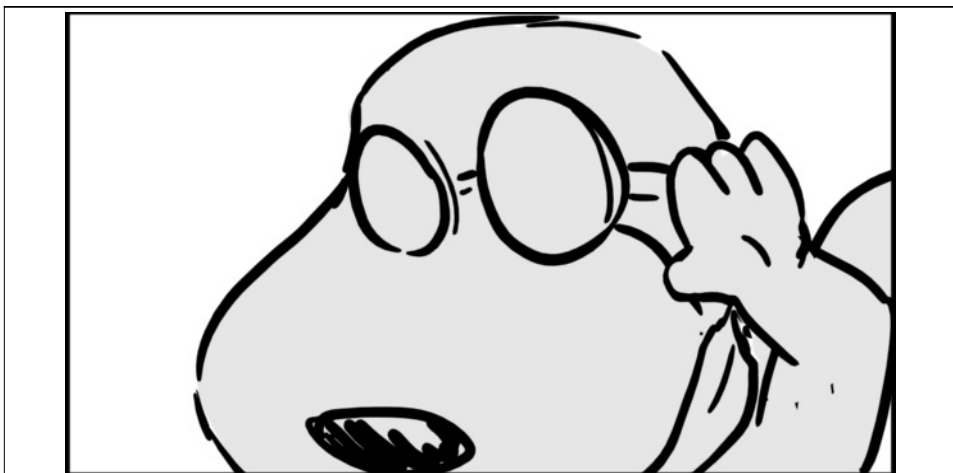

|       |       |
|-------|-------|
| Scene | Panel |
| 78    | 1     |



Action Notes

His plane goes into a dive. It hits the ground and EXPLODES!

|       |       |
|-------|-------|
| Scene | Panel |
| 78    | 2     |

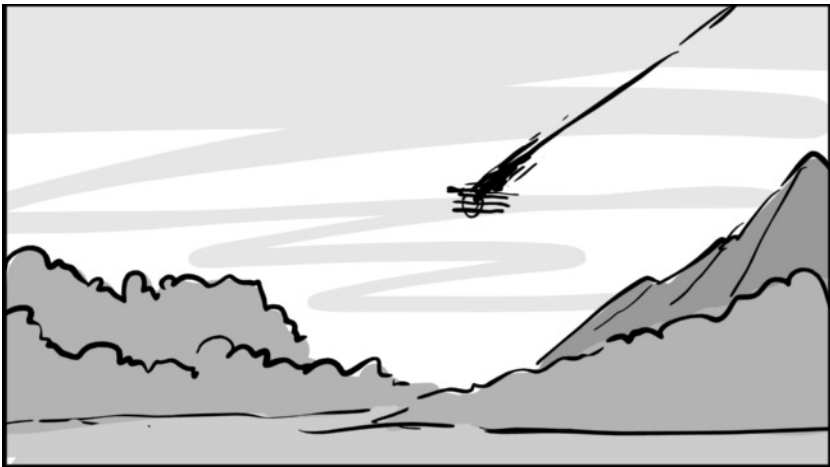

Action Notes

His plane goes into a dive. It hits the ground and EXPLODES!

|       |       |
|-------|-------|
| Scene | Panel |
| 78    | 3     |

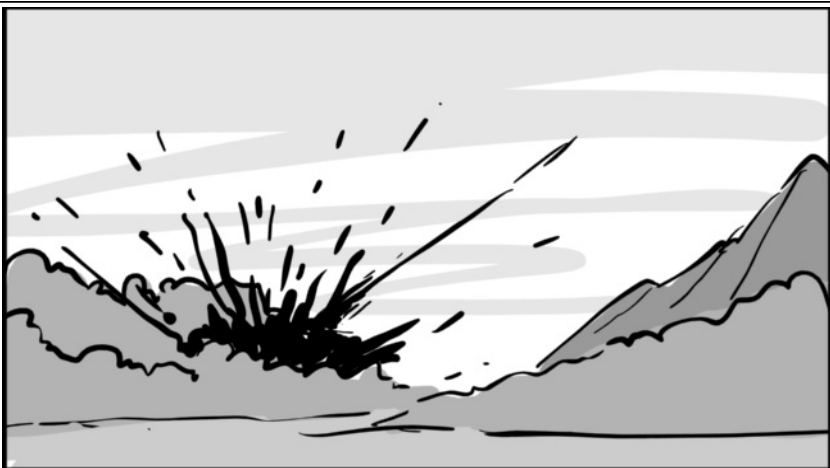

Action Notes

His plane goes into a dive. It hits the ground and EXPLODES!

|       |       |
|-------|-------|
| Scene | Panel |
| 78    | 4     |



Action Notes  
His plane goes into a dive. It hits the ground and EXPLODES!

|       |       |
|-------|-------|
| Scene | Panel |
| 78    | 5     |

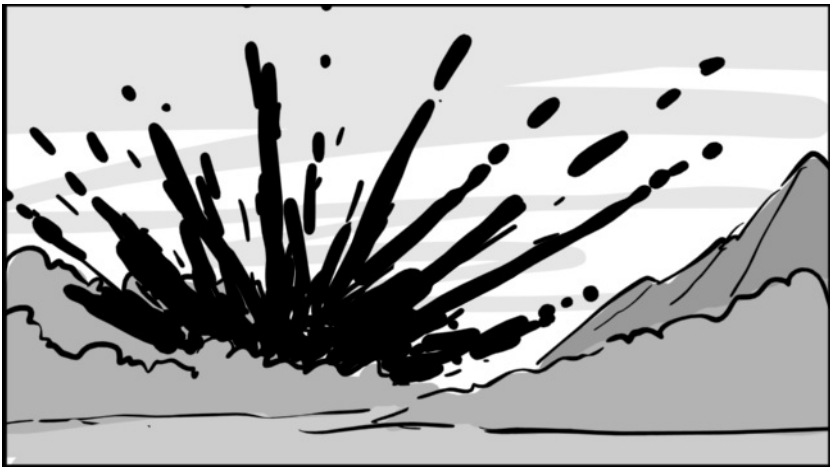

Action Notes  
His plane goes into a dive. It hits the ground and EXPLODES!

|       |       |
|-------|-------|
| Scene | Panel |
| 79    | 1     |



Action Notes  
Snoopy does his HAPPY DANCE atop his doghouse. It turns to SLOW MOTION.

|       |       |
|-------|-------|
| Scene | Panel |
| 79    | 2     |

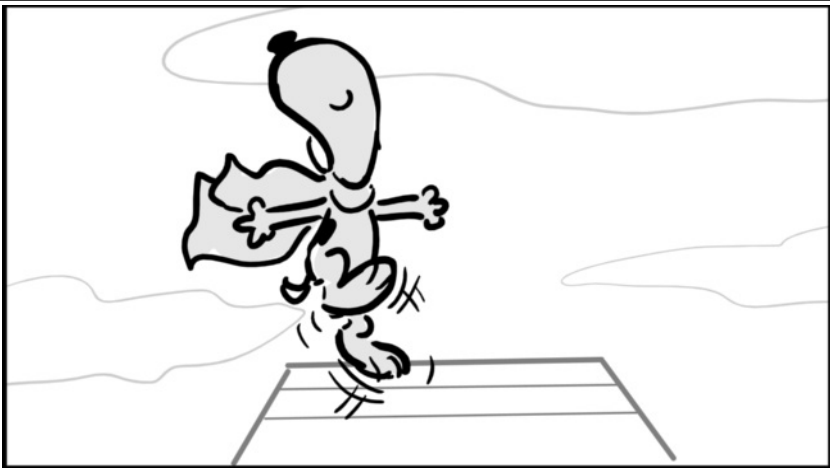

Action Notes  
Snoopy does his HAPPY DANCE atop his doghouse. It turns to SLOW MOTION.

|       |       |
|-------|-------|
| Scene | Panel |
| 79    | 3     |

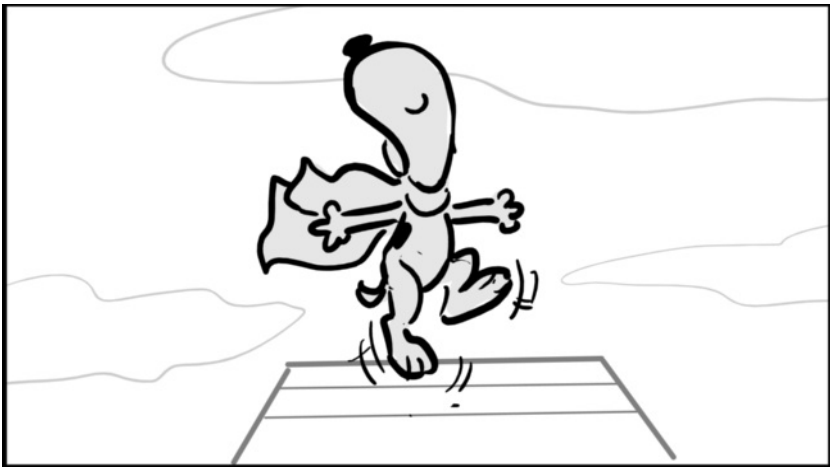

Action Notes  
Snoopy does his HAPPY DANCE atop his doghouse. It turns to SLOW MOTION.

|       |       |
|-------|-------|
| Scene | Panel |
| 79    | 4     |

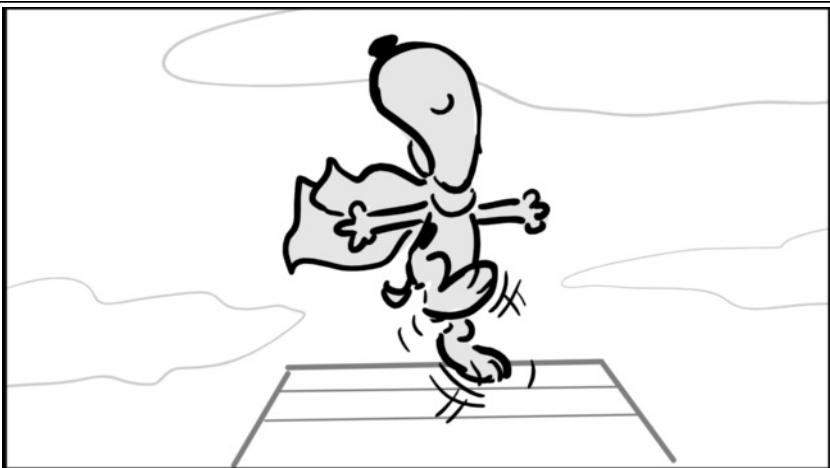

Action Notes  
Snoopy does his HAPPY DANCE atop his doghouse. It turns to SLOW MOTION.

|       |       |
|-------|-------|
| Scene | Panel |
| 79    | 5     |

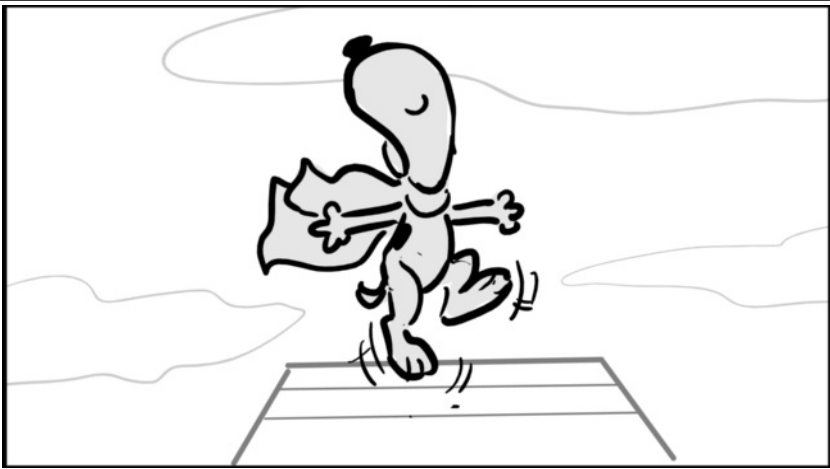

Action Notes  
Snoopy does his HAPPY DANCE atop his doghouse. It turns to SLOW MOTION.

|       |       |
|-------|-------|
| Scene | Panel |
| 79    | 6     |

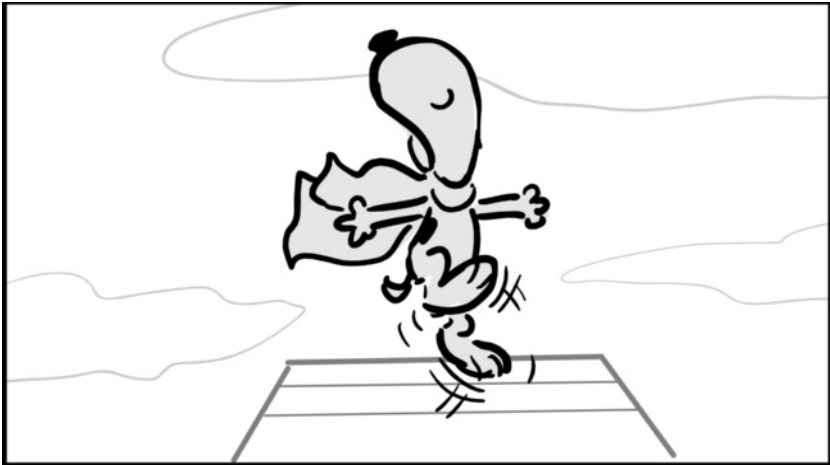

Action Notes  
Snoopy does his HAPPY DANCE atop his doghouse. It turns to SLOW MOTION.

|       |       |
|-------|-------|
| Scene | Panel |
| 79    | 7     |

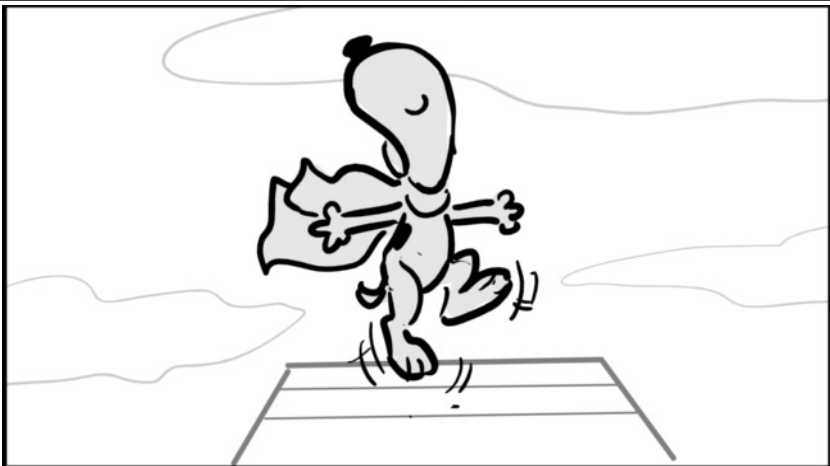

Action Notes  
Snoopy does his HAPPY DANCE atop his doghouse. It turns to SLOW MOTION.

|       |       |
|-------|-------|
| Scene | Panel |
| 79    | 8     |

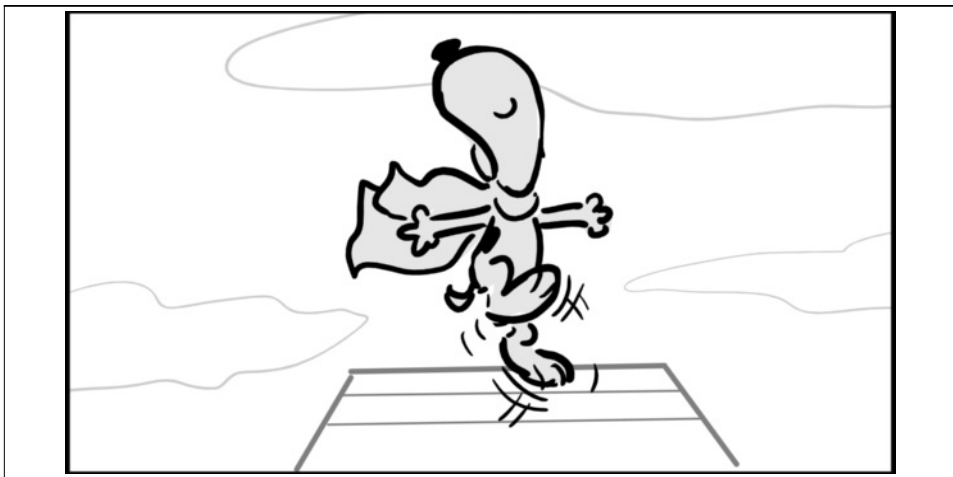

Action Notes  
 Snoopy does his HAPPY DANCE atop his doghouse. It turns to SLOW MOTION.

|       |       |
|-------|-------|
| Scene | Panel |
| 80    | 1     |



Action Notes  
 INSERT - Black and white PHOTO of SNOOPY in his flight helmet and scarf, cozying up to MARCIE in a French bistro. She wears a BERET. (This is an often-used visual in the strip.)

|       |       |
|-------|-------|
| Scene | Panel |
| 80    | 2     |



Action Notes  
 INSERT - Black and white PHOTO of SNOOPY in his flight helmet and scarf, cozying up to MARCIE in a French bistro. She wears a BERET. (This is an often-used visual in the strip.)

|       |       |
|-------|-------|
| Scene | Panel |
| 80    | 3     |

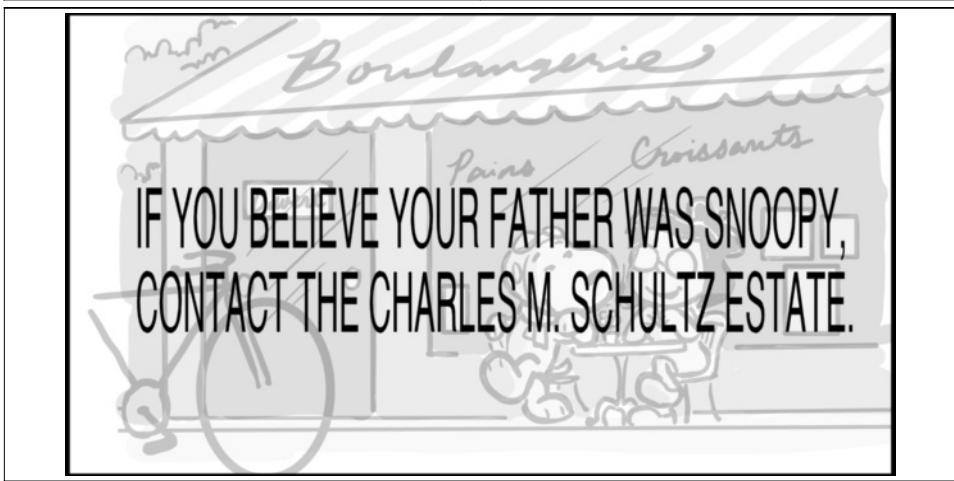

Action Notes

INSERT - Black and white PHOTO of SNOOPY in his flight helmet and scarf, cozying up to MARCIE in a French bistro. She wears a BERET. (This is an often-used visual in the strip.)