



IP Office

9600 Series Phone User Guide

Notices

While reasonable efforts have been made to ensure that the information in this document is complete and accurate at the time of printing, Avaya assumes no liability for any errors. Avaya reserves the right to make changes and corrections to the information in this document without the obligation to notify any person or organization of such changes.

Documentation disclaimer

Avaya shall not be responsible for any modifications, additions, or deletions to the original published version of this documentation unless such modifications, additions, or deletions were performed by Avaya.

End User agree to indemnify and hold harmless Avaya, Avaya's agents, servants and employees against all claims, lawsuits, demands and judgments arising out of, or in connection with, subsequent modifications, additions or deletions to this documentation, to the extent made by End User.

Link disclaimer

Avaya is not responsible for the contents or reliability of any linked Web sites referenced within this site or documentation(s) provided by Avaya. Avaya is not responsible for the accuracy of any information, statement or content provided on these sites and does not necessarily endorse the products, services, or information described or offered within them. Avaya does not guarantee that these links will work all the time and has no control over the availability of the linked pages.

Warranty

Avaya provides a limited warranty on this product. Refer to your sales agreement to establish the terms of the limited warranty. In addition, Avaya's standard warranty language, as well as information regarding support for this product, while under warranty, is available to Avaya customers and other parties through the Avaya Support Web site: <http://www.avaya.com/support>. Please note that if you acquired the product from an authorized Avaya reseller outside of the United States and Canada, the warranty is provided to you by said Avaya reseller and not by Avaya.

Licenses

THE SOFTWARE LICENSE TERMS AVAILABLE ON THE AVAYA WEBSITE, [HTTP://SUPPORT.AVAYA.COM/LICENSEINFO/](http://support.avaya.com/licenseinfo/) ARE APPLICABLE TO ANYONE WHO DOWNLOADS, USES AND/OR INSTALLS AVAYA SOFTWARE, PURCHASED FROM AVAYA INC., ANY AVAYA AFFILIATE, OR AN AUTHORIZED AVAYA RESELLER (AS APPLICABLE) UNDER A COMMERCIAL AGREEMENT WITH AVAYA OR AN AUTHORIZED AVAYA RESELLER. UNLESS OTHERWISE AGREED TO BY AVAYA IN WRITING, AVAYA DOES NOT EXTEND THIS LICENSE IF THE SOFTWARE WAS OBTAINED FROM ANYONE OTHER THAN AVAYA, AN AVAYA AFFILIATE OR AN AVAYA AUTHORIZED RESELLER, AND AVAYA RESERVES THE RIGHT TO TAKE LEGAL ACTION AGAINST YOU AND ANYONE ELSE USING OR SELLING THE SOFTWARE WITHOUT A LICENSE. BY INSTALLING, DOWNLOADING OR USING THE SOFTWARE, OR AUTHORIZING OTHERS TO DO SO, YOU, ON BEHALF OF YOURSELF AND THE ENTITY FOR WHOM YOU ARE INSTALLING, DOWNLOADING OR USING THE SOFTWARE (HEREINAFTER REFERRED TO INTERCHANGEABLY AS "YOU" AND "END USER"), AGREE TO THESE TERMS AND CONDITIONS AND CREATE A BINDING CONTRACT BETWEEN YOU AND AVAYA INC. OR THE APPLICABLE AVAYA AFFILIATE ("AVAYA").

Avaya grants End User a license within the scope of the license types described below. The applicable number of licenses and units of capacity for which the license is granted will be one (1), unless a different number of licenses or units of capacity is specified in the Documentation or other materials available to End User. "Designated Processor" means a single stand-alone computing device. "Server" means a Designated Processor that hosts a software application to be accessed by multiple users. "Software" means the computer programs in object code, originally licensed by Avaya and ultimately utilized by End User, whether as stand-alone products or pre-installed on Hardware. "Hardware" means the standard hardware originally sold by Avaya and ultimately utilized by End User.

License types

Designated System(s) License (DS). End User may install and use each copy of the Software on only one Designated Processor, unless a different number of Designated Processors is indicated in the Documentation or other materials available to End User. Avaya may require the Designated Processor(s) to be identified by type, serial number, feature key, location or other specific designation, or to be provided by End User to Avaya through electronic means established by Avaya specifically for this purpose.

Copyright

Except where expressly stated otherwise, no use should be made of materials on this site, the Documentation(s) and Product(s) provided by Avaya. All content on this site, the documentation(s) and the product(s) provided by Avaya including the selection, arrangement and design of the content is owned either by Avaya or its licensors and is protected by copyright and other intellectual property laws including the sui generis rights relating to the protection of databases. You may not modify, copy, reproduce, republish, upload, post, transmit or distribute in any way any content, in whole or in part, including any code and software. Unauthorized reproduction, transmission, dissemination, storage, and or use without the express written consent of Avaya can be a criminal, as well as a civil, offense under the applicable law.

Third Party Components

Certain software programs or portions thereof included in the Product may contain software distributed under third party agreements ("Third Party Components"), which may contain terms that expand or limit rights to use certain portions of the Product ("Third Party Terms"). Information regarding distributed Linux OS source code (for those Products that have distributed the Linux OS source code), and identifying the copyright holders of the Third Party Components and the Third Party Terms that apply to them is available on the Avaya Support Web site: <http://support.avaya.com/Copyright>.

Preventing toll fraud

"Toll fraud" is the unauthorized use of your telecommunications system by an unauthorized party (for example, a person who is not a corporate employee, agent, subcontractor, or is not working on your company's behalf). Be aware that there can be a risk of toll fraud associated with your system and that, if toll fraud occurs, it can result in substantial additional charges for your telecommunications services.

Avaya fraud intervention

If you suspect that you are being victimized by toll fraud and you need technical assistance or support, call Technical Service Center Toll Fraud Intervention Hotline at +1-800-643-2353 for the United States and Canada. For additional support telephone numbers, see the Avaya Support Web site: <http://support.avaya.com>. Suspected security vulnerabilities with Avaya products should be reported to Avaya by sending mail to: securityalerts@avaya.com.

Trademarks

Avaya and Aura are trademarks of Avaya, Inc. The trademarks, logos and service marks ("Marks") displayed in this site, the documentation(s) and product(s) provided by Avaya are the registered or unregistered Marks of Avaya, its affiliates, or other third parties. Users are not permitted to use such Marks without prior written consent from Avaya or such third party which may own the Mark. Nothing contained in this site, the documentation(s) and product(s) should be construed as granting, by implication, estoppel, or otherwise, any license or right in and to the Marks without the express written permission of Avaya or the applicable third party. Avaya is a registered trademark of Avaya Inc. All non-Avaya trademarks are the property of their respective owners.

Downloading documents

For the most current versions of documentation, see the Avaya Support Web site: <http://www.avaya.com/support>

Contact Avaya Support

Avaya provides a telephone number for you to use to report problems or to ask questions about your product. The support telephone number is 1-800-242-2121 in the United States. For additional support telephone numbers, see the Avaya Web site: <http://www.avaya.com/support>

Contents

1. Introduction

1.1 Important Safety Information.....	9
1.2 9608 Telephone.....	10
1.3 9620 Telephone.....	11
1.4 9621 Telephone.....	12
1.5 9630 Telephone.....	13
1.6 9640 Telephone.....	14
1.7 9641 Telephone.....	15
1.8 9650 Telephone.....	16
1.9 Status Letters.....	17
1.10 Button Modules.....	18
1.11 Phone Keys.....	19
1.12 Touch Screen Operation.....	19
1.13 The Phone Stand.....	20

2. Making Calls

2.1 En-Bloc Dialing.....	22
2.2 Call Soft Key Options.....	23
2.3 Calling from the Contacts List.....	24
2.4 Calling from the Call Log/History.....	24
2.5 Redialling a Previous Number.....	25
2.6 Making a Page Call.....	25
2.7 Withholding Your Number.....	25
2.8 Adjust the Call Volume.....	26
2.9 Muting a Call.....	26
2.10 Ending Calls.....	26

3. Answering Calls

3.1 Divert a Call to Voicemail.....	29
3.2 Ignore an Incoming Call.....	29
3.3 Answering a Page Call.....	29
3.4 Call Pickup.....	30

4. Redialling

4.1 Redial (Last Dialed Mode).....	32
4.2 Redial (Call Log Mode).....	32
4.3 Selecting Your Redial Mode.....	32

5. Holding and Parking Calls

5.1 Holding Calls.....	35
5.1.1 Holding a Call.....	35
5.1.2 Taking a Call Off Hold.....	35
5.1.3 Switching Between Calls.....	35
5.1.4 Transfer a Held Call.....	35
5.2 Parking Calls.....	36
5.2.1 Park Using the Menu.....	36
5.2.2 Unpark (Status Menu).....	36

6. Transferring Calls

6.1 Transfer to Voicemail.....	38
6.2 Transferring a Held Call.....	38

7. Account Codes

7.1 Forced Account Code Entry.....	40
7.2 Manual Account Code Entry.....	40

8. Conference Calls

8.1 Starting a Conference.....	42
8.2 Adding a Call to a Conference.....	42
8.3 Viewing Conference Details.....	42
8.4 Dropping/Muting Parties.....	43
8.5 Holding a Conference Call.....	43
8.6 Transferring Calls Using Conference.....	43

9. Headset/Handsfree Operation

9.1 Headset Operation.....	46
9.1.1 Headset Volume.....	46
9.1.2 Default Handsfree Audio Path.....	46
9.2 Handsfree Speaker Operation.....	47
9.2.1 Speaker Volume.....	47
9.2.2 Default Handsfree Audio Path.....	47

10. Contacts/Directory

10.1 Managing External Contacts.....	50
10.2 Viewing Contacts Details.....	51
10.3 Make a Call from the Directory.....	52
10.4 Using the Directory for Other Functions.....	52
10.5 Adding a New Contact.....	53
10.5.1 Add a Contact from the Call Log/History.....	53
10.6 Editing a Contact.....	54
10.7 Deleting a Contact.....	54

11. Call History

11.1 Accessing the Call Log/History.....	57
11.2 Making a Call.....	57
11.3 Viewing Call Details.....	58
11.4 Deleting a Record.....	59
11.5 Deleting All Records.....	59
11.6 Adding a Record to Your Contacts.....	59

12. Voicemail

12.1 Message Waiting Indication.....	62
12.2 Checking Messages.....	63
12.3 Sending a Message.....	64
12.4 Mailbox Greeting.....	64
12.5 Email Mode.....	65
12.6 Changing Your Voicemail Code.....	65
12.7 Voicemail On/Off.....	66
12.8 Transfer to Voicemail.....	66
12.9 Send a Call to Voicemail.....	66
12.10 Visual Voice.....	66

13. Logging In/Out

13.1 Logging In.....	69
13.1.1 Logging In on a Phone Already in Use.....	69
13.1.2 Logging In on a Not Logged In Phone.....	69
13.1.3 Logging In on an Unregistered Phone.....	69
13.2 Logout.....	70
13.3 Lock.....	70
13.4 Unlock.....	70
13.5 Auto Lock.....	71
13.6 Changing Your Security PIN.....	71

14. Redirecting Calls

14.1 Follow Me.....	75
14.1.1 Follow Me To (Features Menu).....	76

14.1.2 Follow Me (Status Menu).....	76	17.6.2 Visual Alerting.....	104
14.1.3 Follow Me Here (Features Menu).....	76	17.6.3 Coverage Ring.....	104
14.2 Forwarding Calls.....	77	17.6.4 Ring Sound.....	105
14.2.1 Forward Unconditional (Status Menu).....	79	17.6.5 Ringer Volume.....	106
14.2.2 Forward Unconditional (Features Menu).....	79	17.6.6 Internal Auto Answer.....	106
14.2.3 Forward On Busy/No Answer (Features Menu).....	80	17.7 Display Controls.....	107
14.2.4 Forward On No Answer (Status Menu).....	80	17.7.1 Display Brightness.....	108
14.2.5 Forward On Busy (Status Menu).....	81	17.7.2 Display Contrast.....	108
14.3 Do Not Disturb.....	82	17.7.3 Last Call Duration Display.....	108
14.3.1 DND On/Off (Features Menu).....	83	17.7.4 Call Timer Display.....	109
14.3.2 DND Off (Status Menu).....	83	17.7.5 Display Language.....	110
14.3.3 Do Not Disturb Exceptions.....	83	17.7.6 Show Call Waiting.....	110
14.4 Twinning.....	84	17.7.7 Inactivity Timer (Auto Return).....	110
14.4.1 Mobile Twinning Control.....	84	17.7.8 Quick Touch Lines.....	111
15.Groups		17.8 Volume and Sound.....	112
15.1 Group Membership.....	87	17.8.1 Button Clicks.....	112
15.1.1 Group Membership On/Off (Status Menu).....	87	17.8.2 Error Tones.....	112
15.1.2 Group Membership On/Off (Features Menu).....	87	17.8.3 Ringer Volume.....	112
15.2 Group Service Status and Fallback.....	88	17.8.4 Handset Volume.....	113
15.2.1 Changing the Group Service Status (Features Menu).....	89	17.8.5 Headset Volume.....	113
15.2.2 Changing the Group Service Status (Status Menu).....	89	17.8.6 Speaker Volume.....	113
15.2.3 Changing the Group Fallback.....	90	17.8.7 Automatic Gain Control.....	113
		17.8.8 Default Handsfree Audio Path.....	114
16.Button Features		17.9 Backup/Restore.....	115
16.1 Editing Your Programmable Buttons.....	93	17.9.1 Backup.....	115
16.2 Abbreviated Dial.....	94	17.9.2 Restore.....	115
16.3 Absence Text.....	94	18.Status Menu	
16.4 Account Code.....	94	18.1 Do Not Disturb.....	118
16.5 Automatic Callback.....	94	18.2 Follow Me To.....	118
16.6 Breakout.....	94	18.3 Follow Me Here.....	119
16.7 Call Forward All.....	94	18.4 Forward On Busy.....	119
16.8 Call Park.....	95	18.5 Forward On No Answer.....	120
16.9 Call Park to Other.....	95	18.6 Forward Unconditional.....	120
16.10 Call Pickup.....	95	18.7 Forwarded Here.....	120
16.11 Call Pickup Any.....	95	18.8 Group Membership.....	121
16.12 Drop Call.....	95	18.9 Group Service Status.....	121
16.13 Flash Hook.....	95	18.10 Mobile Twinning.....	121
16.14 Group BLF.....	96	18.11 Parked Calls.....	122
16.15 Hunt Group Night Service.....	96	18.12 System Alarms.....	122
16.16 Internal Auto Answer.....	96	19.Short Codes	
16.17 Paging.....	96	20.System Administration	
16.18 Ringer Off.....	96	20.1 Checking the System Information.....	128
16.19 Self Administer.....	96	20.2 Setting the Date.....	128
16.20 Send All Calls.....	96	20.3 Checking the Time Server Status.....	129
16.21 Suppress Digits.....	97	20.4 Setting the Time.....	130
16.22 User BLF.....	97	20.5 Setting the Time Offset.....	130
17.Phone Settings		20.6 System Shutdown.....	131
17.1 Mobile Twinning.....	101	20.7 Memory Card Management.....	132
17.2 Withhold Number.....	101	20.8 System Alarms.....	133
17.3 Redial Mode.....	101	21.Menus	
17.4 En-Bloc Dialing.....	102	21.1 Features Menu.....	136
17.5 Auto Lock.....	102	21.2 Status Menu.....	137
17.6 Ringer Controls.....	103	21.3 A Menu.....	138
17.6.1 Disabling the Ringer.....	104	22.Glossary	

22.1 Abbreviated Ring.....	140
22.2 Appearance Button.....	140
22.3 Attention Ring.....	140
22.4 Auto Hold.....	140
22.5 Bridged Appearance Button.....	140
22.6 Call Appearance Button.....	140
22.7 Call Coverage Button.....	140
22.8 Coverage Ring.....	140
22.9 Do Not Disturb.....	140
22.10 Do Not Disturb Exceptions.....	141
22.11 Follow Me.....	141
22.12 Follow Me Here.....	141
22.13 Follow Me To.....	141
22.14 Forward on Busy.....	141
22.15 Forward on No Answer.....	141
22.16 Forward Unconditional.....	141
22.17 Group.....	142
22.18 Idle Line Preference.....	142
22.19 Internal Twinning.....	142
22.20 Line Appearance Button.....	142
22.21 Logged Out.....	142
22.22 Login Code.....	142
22.23 Missed Call.....	142
22.24 Missed Group Call.....	142
22.25 Mobile Twinning.....	142
22.26 Park Call.....	143
22.27 Park Slot Number.....	143
22.28 Ringing Line Preference.....	143
22.29 Short Codes.....	143
22.30 Small Community Network.....	143
22.31 System Administrator.....	143
22.32 System Phone User.....	143
22.33 Twinning.....	143
Index.....	145

Chapter 1.











Introduction

1. Introduction

This guide is for 9600 Series telephones supported by IP Office Release 8.0 running on an Avaya IP Office telephone system.

- **9600 Series Phones**

These are IP phones supported by IP Office and other Avaya telephone systems. Running H323 firmware, the supported phones are:

Phone	Programmable Buttons	Colour Screen	Touch Screen	Gigabit*	Headset	Speaker Phone	Button Module Support
9608 	24	No	No	No	Yes	Yes	BM12 x 3
9620L 	24	No	No	No	Yes	Yes	SBM24 x 3
9620C 	24	Yes	No	No	Yes	Yes	-
9621G 	24	Yes	Yes	Yes	Yes	Yes	-
9630G 	24	No	No	Yes	Yes	Yes	SBM24 x 3
9640 	24	Yes	No	No	Yes	Yes	SBM24 x 3
9640G 	24	Yes	No	Yes	Yes	Yes	SBM24 x 3
9641G 	24	Yes	Yes	Yes	Yes	Yes	BM12 x 3
9650 	24	No	No	No	Yes	Yes	SBM24 x 3
9650C 	24	Yes	No	No	Yes	Yes	SBM24 x 3

- **Gigabit Support**

This column indicates that the phone natively supports Gigabit Ethernet. Other phones can support Gigabit through the use of a suitable Gigabit adapter.

- **Unsupported Features**

The 9600 Series phones are supported on a number of Avaya telephone systems and support different features depending on the telephone system. This guide covers just features supported on an Avaya IP Office telephone system.

1.1 Important Safety Information

- **! Warning:** This handset may pickup small metal objects such as metal pins or staples.
- During a power surge, EFT or ESD, calls may be dropped. After a power surge, EFT or ESD, it is normal for the phone to restart.
- Using a cell phone, mobile phone, GSM phone or two-way radio in close proximity to an Avaya telephone might cause interference.
- The phone should not be connected directly to the outdoor telecommunication network.

1.2 9608 Telephone

The IP Office supports the 9608 telephone.

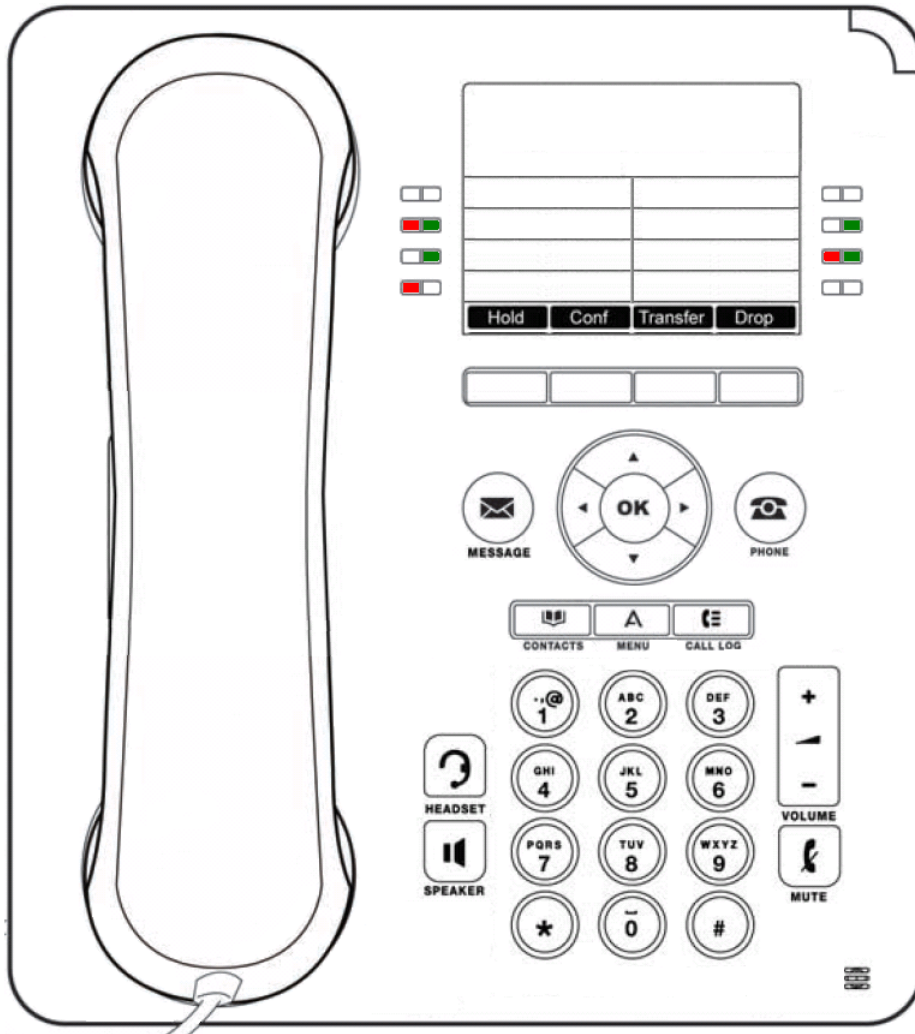

The phone supports 24 programmable call appearance/feature buttons. The labels for these are displayed in the main display and can be controlled by the adjacent buttons.

Functions can be assigned to the phone's call appearance/feature buttons by your system administrator or by yourself using [self-administration](#) ^[92]. Note that you cannot replace call appearances features assigned to buttons by your system maintainer but you can replace other features. However also note there are features that the system maintainer can assign that are not available to you to assign. This guide just includes features that you can assign yourself if required.

1.3 9620 Telephone

The IP Office supports the 9620L and 9620C versions of the 9620 telephone.

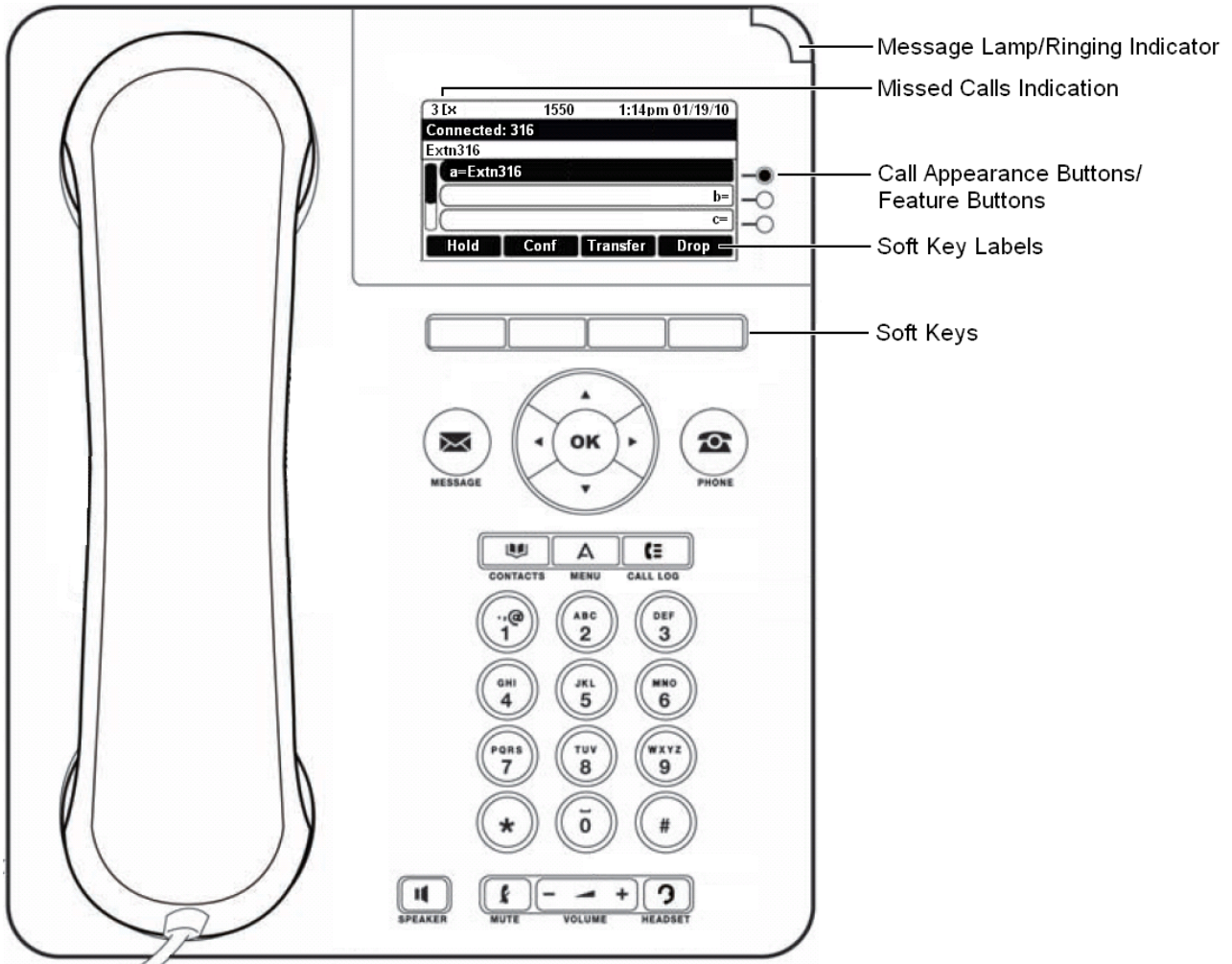

The phone supports 12 programmable call appearance/feature buttons. The labels for 3 of these are displayed in the main display and can be controlled by the adjacent buttons to the right. You can use the ▲ up and down ▼ arrow keys to scroll the display. You can also use the ◀ left and right ▶ arrow keys to move through the button feature in pages of 3.

Functions can be assigned to the phone's call appearance/feature buttons by your system administrator or by yourself using [self-administration](#) ^[92]. Note that you cannot replace call appearances features assigned to buttons by your system maintainer but you can replace other features. However also note there are features that the system maintainer can assign that are not available to you to assign. This guide just includes features that you can assign yourself if required.

1.4 9621 Telephone

The IP Office supports the 9621 telephone.

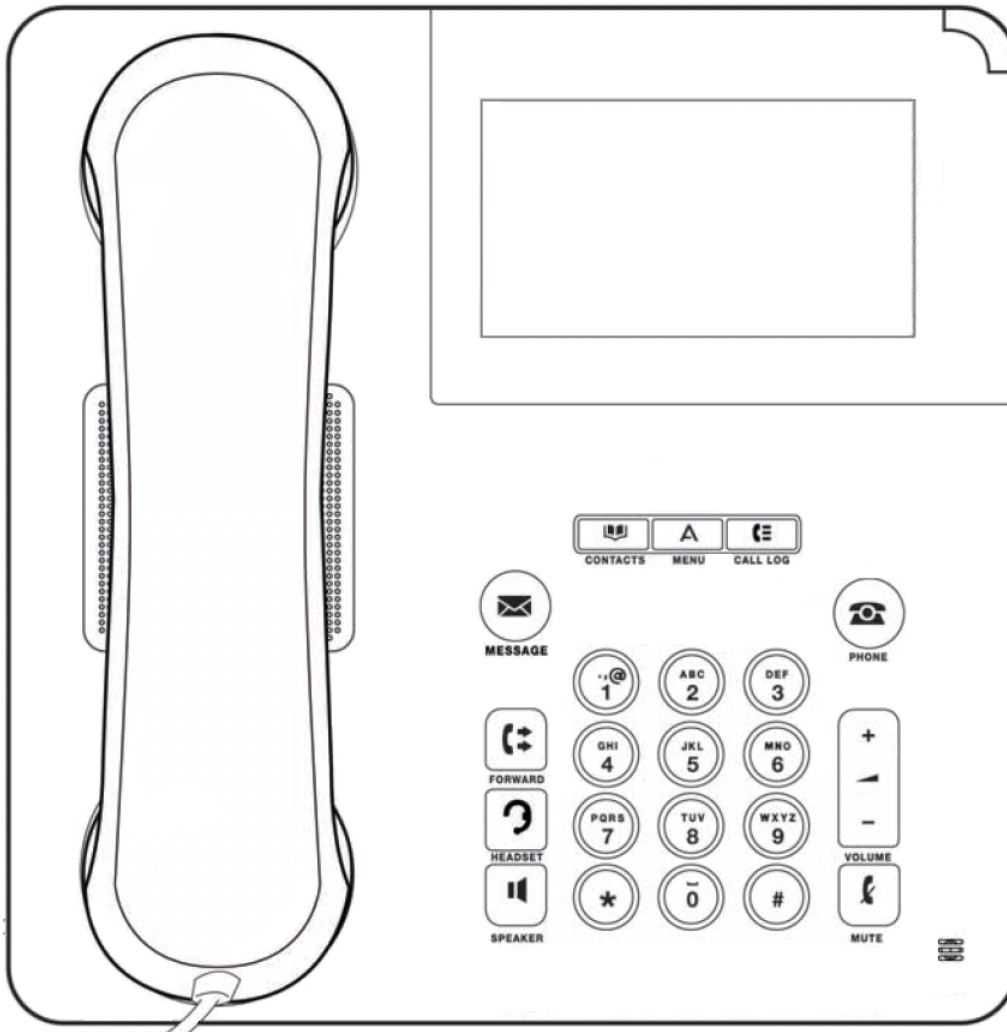

The phone supports 24 programmable call appearance/feature buttons. The labels for 6 of these are displayed in the main display and can be controlled by the adjacent buttons to the right. You can use the ▲ up and down ▼ arrow keys to scroll the display. You can also use the ◀ left and right ▶ arrow keys to move through the button feature in pages of 6.

Functions can be assigned to the phone's call appearance/feature buttons by your system administrator or by yourself using [self-administration](#)^[92]. Note that you cannot replace call appearances features assigned to buttons by your system maintainer but you can replace other features. However also note there are features that the system maintainer can assign that are not available to you to assign. This guide just includes features that you can assign yourself if required.

1.5 9630 Telephone

The IP Office supports the 9630G version of the 9630 telephone.

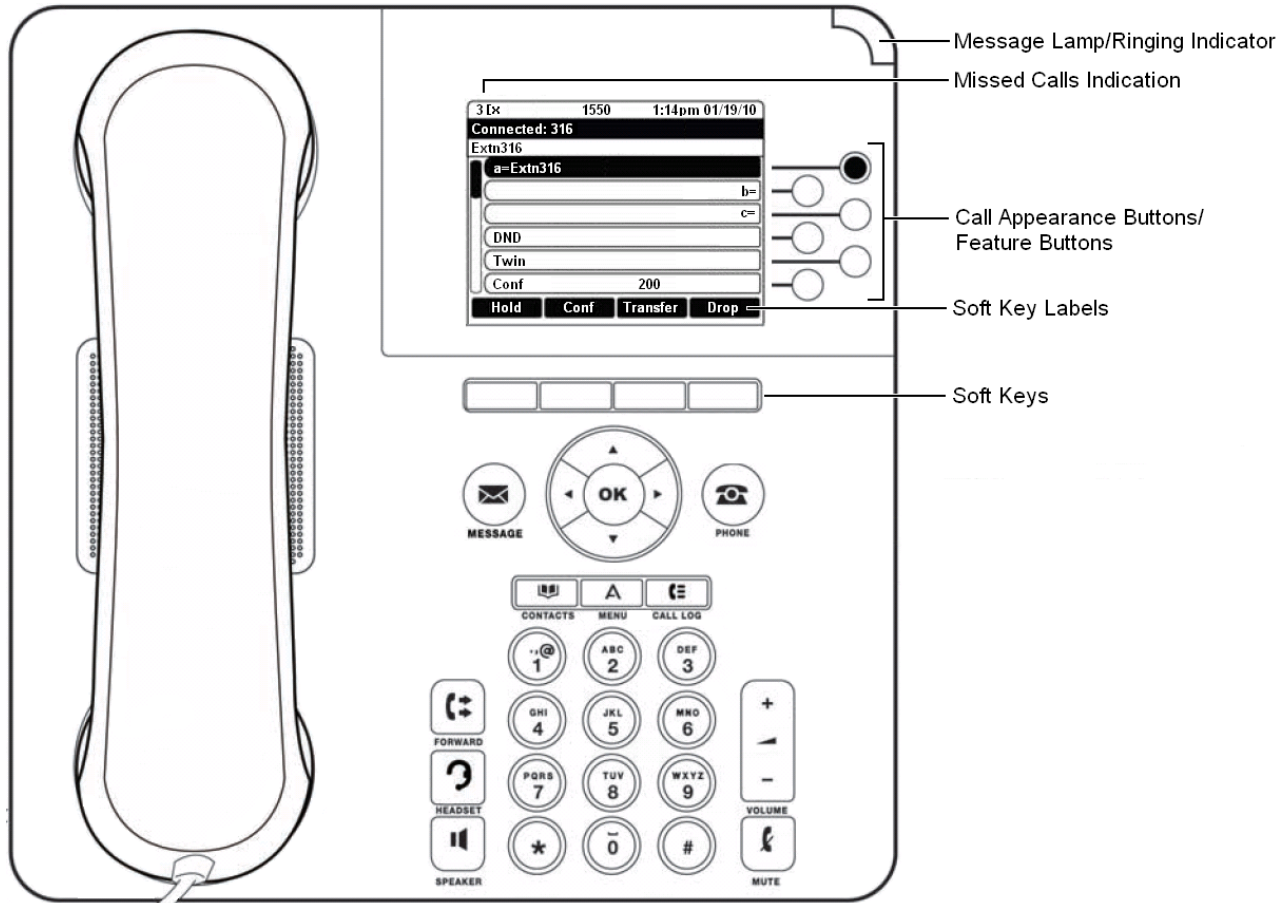

The phone supports 24 programmable call appearance/feature buttons. The labels for 6 of these are displayed in the main display and can be controlled by the adjacent buttons to the right. You can use the ▲ up and down ▼ arrow keys to scroll the display. You can also use the ◀ left and right ▶ arrow keys to move through the button feature in pages of 6.

Functions can be assigned to the phone's call appearance/feature buttons by your system administrator or by yourself using [self-administration](#) ^[92]. Note that you cannot replace call appearances features assigned to buttons by your system maintainer but you can replace other features. However also note there are features that the system maintainer can assign that are not available to you to assign. This guide just includes features that you can assign yourself if required.

1.6 9640 Telephone

The IP Office supports the 9640 and 9640G versions of the 9640 telephone.

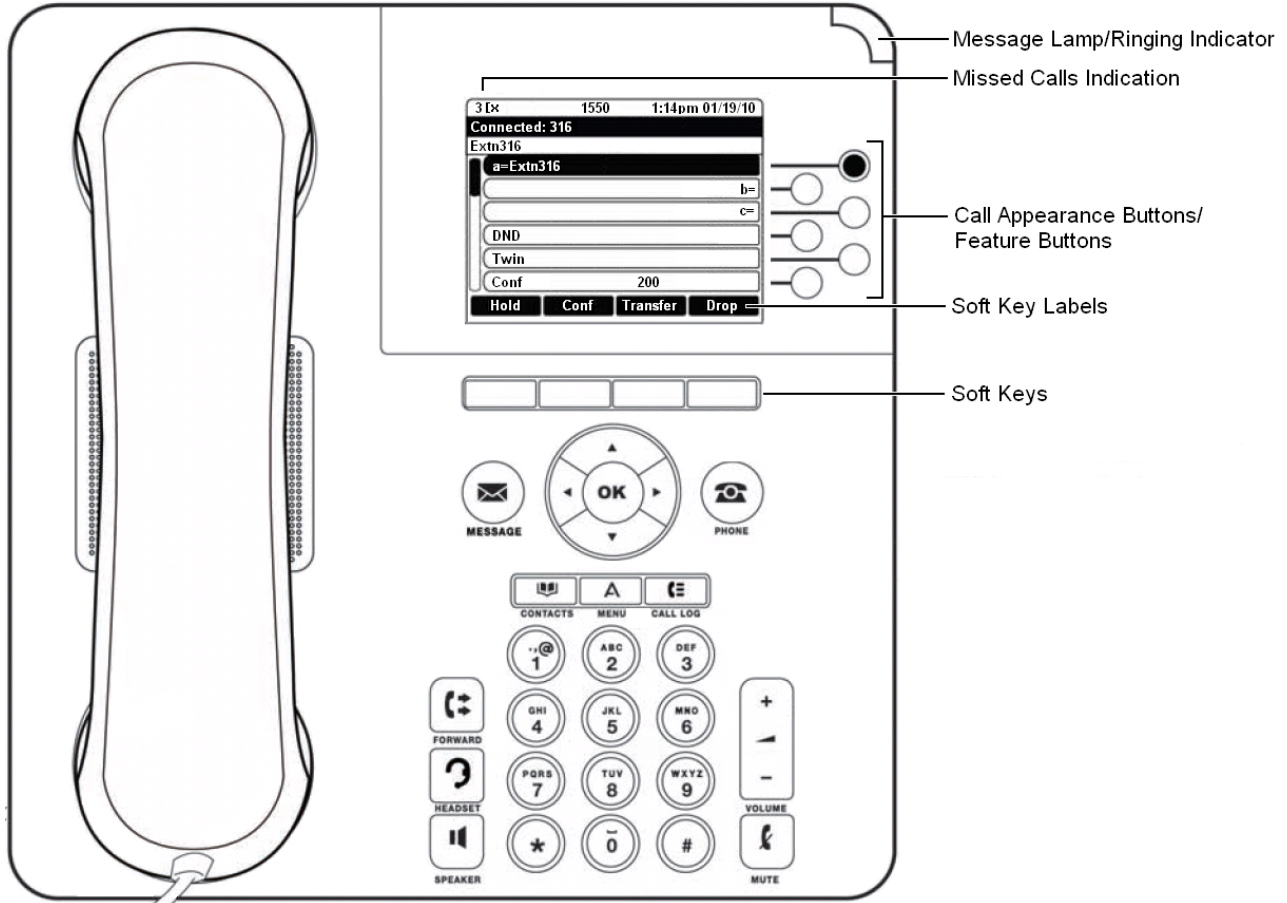

The phone supports 24 programmable call appearance/feature buttons. The labels for 6 of these are displayed in the main display and can be controlled by the adjacent buttons to the right. You can use the ▲ up and down ▼ arrow keys to scroll the display. You can also use the ◀ left and right ▶ arrow keys to move through the button feature in pages of 6.

Functions can be assigned to the phone's call appearance/feature buttons by your system administrator or by yourself using [self-administration](#) ^[92]. Note that you cannot replace call appearances features assigned to buttons by your system maintainer but you can replace other features. However also note there are features that the system maintainer can assign that are not available to you to assign. This guide just includes features that you can assign yourself if required.

1.7 9641 Telephone

The IP Office supports the 9641 telephone.

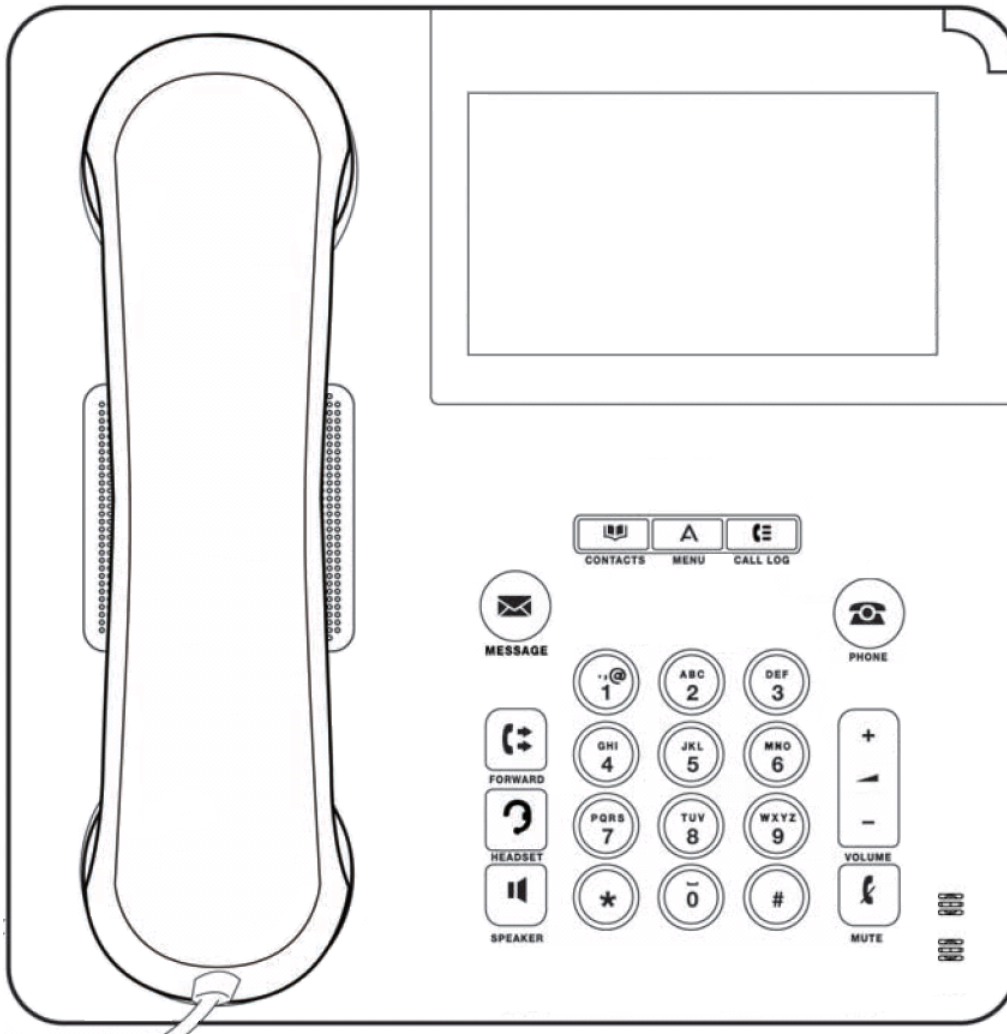

The phone supports 24 programmable call appearance/feature buttons. The labels for these are displayed in the scrollable main display along with icons for the status of the buttons.

In addition, the features of some button can also be accessed using fixed buttons displayed at the bottom of the screen. Through the phone's own menus you can select whether to display 1 row of 4, 2 rows of 2 or no fixed buttons at the bottom of the display.

Functions can be assigned to the phone's call appearance/feature buttons by your system administrator or by yourself using [self-administration](#)^[92]. Note that you cannot replace call appearances features assigned to buttons by your system maintainer but you can replace other features. However also note there are features that the system maintainer can assign that are not available to you to assign. This guide just includes features that you can assign yourself if required.

1.8 9650 Telephone

The IP Office supports the 9650 and 9650C versions of the 9650 telephone.

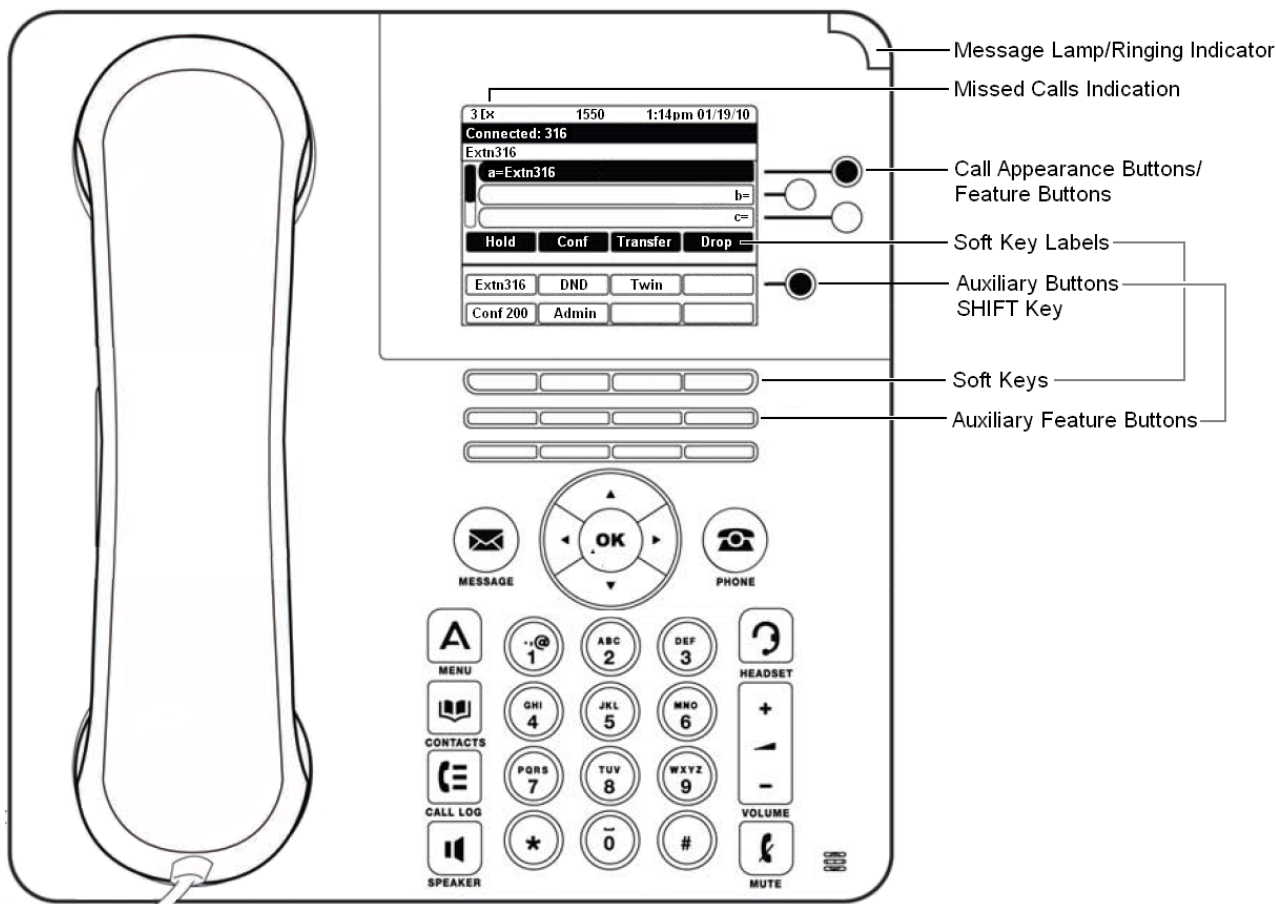

The phone supports 24 programmable call appearance/feature buttons. The labels for 3 of these are displayed in the main display and can be controlled by the adjacent buttons to the right. You can use the ▲ up and down ▼ arrow keys to scroll the display. You can also use the ◀ left and right ▶ arrow keys to move through the button feature in pages of 3.

In addition, the features of 16 of the 24 buttons (buttons 04 to 11 and 12 to 19) can be accessed as using the auxiliary feature buttons below the display. They are shown in two pages of 8 with the **SHIFT** key next to the display used to switch between which page is being displayed at any time.

Functions can be assigned to the phone's call appearance/feature buttons by your system administrator or by yourself using [self-administration](#)^[92]. Note that you cannot replace call appearances features assigned to buttons by your system maintainer but you can replace other features. However also note there are features that the system maintainer can assign that are not available to you to assign. This guide just includes features that you can assign yourself if required.

1.9 Status Letters

When your own extension name is shown on the second line of the display, for example when the phone is idle, the name may be followed by a series of letters. These letters are used to indicate your current status.

- **B = Barred**

A **B** is shown on your phone's display when the system administrator has set you to outgoing call barred status. You will only be able to make internal calls while this is applied.

- **D = Diverting (Forwarding) Calls**

A **D** is shown after your extension name on the phone's idle display when you have forward unconditional enabled.

- **G = Group Member (In Group)**

A **G** is shown after your extension name on the phone's idle display when have been configured as a member of a hunt group and your membership is enabled. While this is the case, you may receive calls targeted to the hunt group.

- **N = No Calls (Do Not Disturb)**

An **N** is shown after your extension name on the phone's idle display when you have do not disturb enabled.

- **O = Out of Service**

An **O** is shown on your phone's display when any of the groups of which you are enabled as a member is set to night service mode. In that mode calls to that group are diverted to its fallback if set or otherwise to voicemail if available.

- **R = Resilience**

An **R** is shown after your extension name on the phone's idle display your phone is working in resilience mode. This is used when there may have been a problem with the telephone system to which your phone was registered and another system is currently providing support for your phone. In this mode, some features may not be available and calls may be routed differently.

- **S = System Alarm**

If you are configured as a [system administrator](#)^[128], an **S** in the phone's display indicates a [system alarm](#)^[133].

- **T = Twinned**

A **T** is shown after your extension name on the phone's idle display if it is internally twinned with your phone. Calls to you will alert on both phones and can be answered by you at either phone.

1.10 Button Modules

The addition of a button module allows the phone to support additional programmable buttons.

- Do not connect or disconnect a button module yourself. Your system administrator will arrange this if necessary. Failure to connect and restart the equipment in the correct order may cause the phone and or the button module to not function correctly.

9608 and 9641 Phones

These phones support BM12 button modules. Each button module provides the phone with an additional 24 buttons (2 pages of 12) which can be used as [appearance buttons](#) ^[140] and or [feature buttons](#) ^[92].

Up to 3 button modules can be attached to a each phone. However the number of button modules supported by the telephone system may be limited by the total number of button modules attached to other phones on the telephone system.

9630, 9640 and 9650 Phones

All variants of these phones supports SBM24 button modules. Each button module provides the phone with an additional 24 buttons which can be used as [appearance buttons](#) ^[140] and or [feature buttons](#) ^[92].













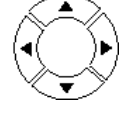

Up to 3 button modules can be attached to a each phone. However the number of button modules supported by the telephone system may be limited by the total number of button modules attached to other phones on the telephone system.

9620 and 9621 Phones

These phones do not support any additional button modules.

1.11 Phone Keys

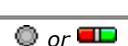
The following keys are found on the phone:

Key	Description
	Soft Keys - The keys below the display have variable functions. When the key is active, its function is indicated by the text label above it. On touch screen phones the labels on the screen can be pressed.
	Message - This key is used to access your voicemail system. By default this uses a series of menus on your phone's display.
	Navigation Keys - Press the ▲ up and down ▼ arrow keys to scroll through lists. In some menus, you can also use the ◀ left and right ▶ arrow keys to enter and exit different levels of the menu. A menu option that accesses a sub-menu is indicated by the ... dots (ellipsis) icon after its name.
	OK - The OK key normally matches the function offered by the left hand soft key below the screen.
	PHONE - This key is used to exit any menu you are in and return to the appearance buttons menu. During a call it can also be used to toggle the options displayed on the appearance menu.
	MENU /HOME - This key is used to access a menu for phone settings and information.
	CONTACTS ^[50] - This key is used to display the various directories (personal and shared) of names and telephone numbers to which you have access.
	CALL LOG ^[58] / HISTORY ^[59] - This key displays a record of you most recent answered, missed and outgoing calls. The button is illuminated when you have new missed calls.
	VOLUME ^[112] - Press + plus or – minus on the Volume key to adjust the volume of the incoming call. Separate volumes can be adjusted for the ringer, handset, headset and speaker.
	HEADSET ^[46] - This key is used to answer and end calls using a headset connected to the phones headset socket. The button is lit when you are connected to a call using the headset.
	MUTE ^[26] - This key can be used to mute your speech to the currently connected call. The button is lit while mute is active.
	SPEAKER ^[47] - This key is used to answer and end calls using the phone's handsfree speaker and microphone. The button is lit when you are connected to a call handsfree.
	FORWARD ^[74] - Provides direct access to the forwarding ^[74] menu options. This button is not present on the 9620 and 9650 models.
	These keys have two roles: <ul style="list-style-type: none"> • Appearance Keys - These button represent calls that you can make or receive. • Feature Buttons ^[92] - Those key not configured as appearance keys can be used for other functions. • On touch screen phones these buttons are replace by their text labels on the screen.

- The **CONFERENCE**, **DROP**, **HOLD**, **REDIAL** and **TRANSFER** keys found on other Avaya phones are presented as [soft key](#) ^[23] functions when appropriate to the current call to which you are protected.

1.12 Touch Screen Operation

The 9621 and 9641 phones use a touch sensitive screens to replace many of the buttons required on other phones. These are pressure sensitive so can be operated with you fingers or a stylus. However you must take care not to use any device that may scratch or cause wear to the screen.

Where on other phones in the range, you need to highlight an option on the screen using the arrow keys and then select that option using either the Select soft key, on a touch screen you can simply directly press the required option.

1.13 The Phone Stand

The phones all include a stand that clips to the base of the phone. The stand allows the phone to be used in either of two different angles.

When changing the position of the stand, be sure to check that the stand has locked into the chosen position. A small plastic peg is located just under the phone's handset. This peg can be reversed to more securely anchor the handset when the stand places the phone in an upright position.

9608

The stand cannot be flipped to another position except by removing it to change the position. The angle of the display on these phones is not adjustable.

Other 9600 Phones

Once attached, the stand can be used in either position to change the angle of the phone. The angle of the phone can also be adjusted as shown below. The angle of the display on these phones can also be adjusted.

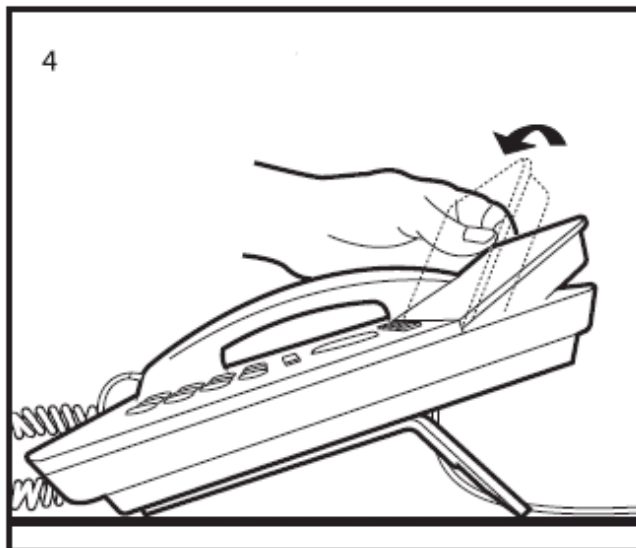
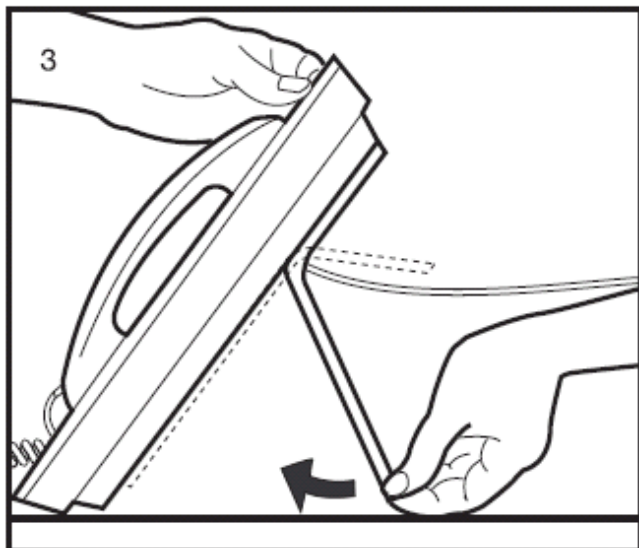
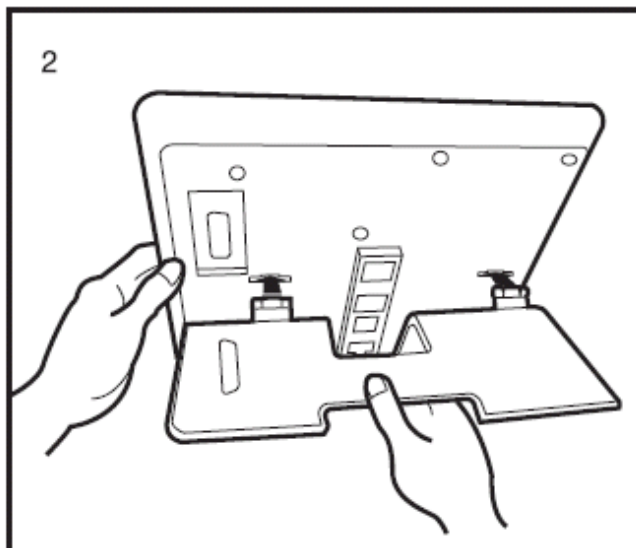
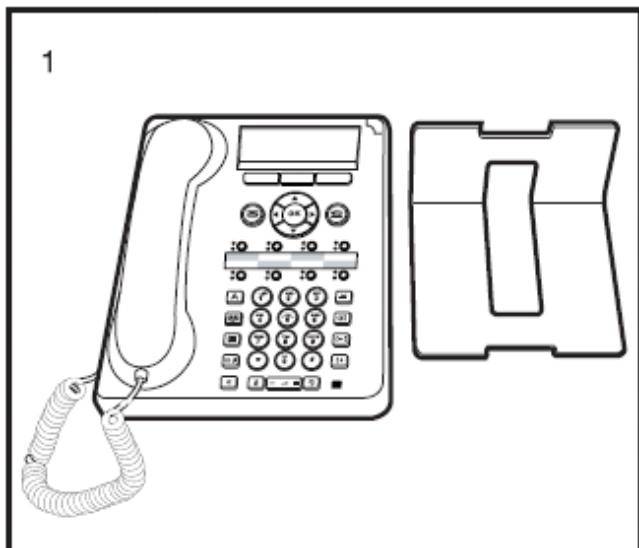

Other Stands

If the phone needs to be used in a situation other than on a desk, for example wall mounted, a number of other stand designs are available from Avaya. Contact your system maintainer.

Chapter 2.

Making Calls

2. Making Calls

If you are not already on a call, then you can just dial the number. The first available appearance button will be used for the call. Alternatively, you can press a specific appearance button in order to make a call using that button.

If the number you dial matches a user or group on the telephone system, the directory name of the user or group is shown and the call starts altering the target.

If the call is to a user, and they do not answer, you can set a callback by pressing **CallBack** and then ending the call by pressing **Drop**. When a callback is set, when the user next uses their phone or ends their current call, the system will call you and when you answer, automatically make another call to the user.

2.1 En-Bloc Dialing

By default, when you start dialing a number on your phone, the phone immediately connects to the telephone system and starts passing the digits you dial to the phone system. You cannot correct the digits you have already dialed except by ending the call and starting again. Also if you pause dialing for too long the phone system may think that you have finished dialing and will attempt to connect the call using only the digits you have completed dialing so far.

En-bloc dialing allows you to compose and edit the number to dial on your phone's display before it is sent to the phone system to be dialed.





Through the phone's menus you can select whether you want to use traditional or en-bloc dialing when making calls. Your chosen setting is then applied whenever you are using a phone that supports en-bloc dialing.

Dialing a Number Using En-Bloc Mode

1. With no connected call on the phone, start dialing. Do not lift the handset or select headset or speaker before dialing.
2. You can use the  right arrow key or the **Bksp** key to delete the previous digit dialed if you need to correct the number or **Clear** to erase the whole number.
3. When you have completed the number as required, you can select how you want to make the call.
 - Lift the handset to start a call using the handset.
 - Pressing the **Call** soft key or **OK** button to start the call using the phone's [default handsfree audio path](#) ⁽¹¹⁴⁾ (speaker or headset). You can also press one of your idle call appearance to make the call using that appearance.
 - Press the **Headset** button to start the call on a headset connected to your phone.
 - Press the **Speaker** button to start the call on your phone's handsfree speaker.

Enabling/Disabling En-Bloc Dialing

You can enable or disable your en-bloc dialing setting through the phone's **Features** menu.

1. Press the **Features** soft key if shown. To do this during a call, press the  **PHONE** key and then press the **Features** soft key.
2. Use the  up and down  arrow keys to highlight **Call Settings**. Press **Select**.
4. Use the  up and down  arrow keys to highlight **En-Bloc Dial**.
5. Use **Change** button to select **On** or **Off**.

2.2 Call Soft Key Options





The options displayed for the buttons at the bottom of the display will change dynamically to reflect actions that you can perform during calls or while the phone is idle.

- **Account**
Enter an account code to associate with the call.
- **Answer**
Answer a page call, turning it into a normal call.
- **CallBack**
Set an automatic callback on the user that you have called but who has not answered. When they next end a call, the telephone system will call you and when answered, will automatically make a call to the user.
- **Complete**
Complete the transfer of a held call. A **Cancel** option is also shown which will end the transfer attempt.
- **Conference**
Put your current call on hold and present dial tone for you to dial the number you want to add to a conference with the held caller.
- **Connect**
Take a call of hold.
- **Dir**
Access the directory in order to select a number by name rather than dialing it. The type of names available in the directory is adjusted to match those suitable for use by the feature.
- **Drop**
End the call.
- **Ignore**
Quiet the ringer for the current alerting call. The call will continue alerting until either answered or it goes to voicemail.
- **Pickup**
Answer the call that is held or alerting another user.
- **Redial**
If there are outgoing numbers in your call log, display the list of those numbers.
- **Transfer**
Put your current call on hold and present dial tone for you to dial the number to which you want to transfer the call.
- **ToVM**
Send an alerting call to your voicemail.

2.3 Calling from the Contacts List

You can use any directory contacts to make a call. You can also use the directory in almost any telephone function where you need to select the number for a destination, for example during transfers.

1. Access the contacts directory:

- a. Press the  **CONTACTS** key. The directory menu is displayed.
- b. Use the  left and right  arrow keys to select which type of directory entries you want displayed.
 - **All**
All directory entries.
 - **External**
Directory entries stored by the telephony system for all users to use.
 - **Groups**
The names and numbers of hunt groups on the telephone system.
 - **Users**
The names and numbers of other users on the telephone system.
 - **Personal**
Your own personal directory entries.
- c. Use the  up and down  arrow keys to scroll through the list or start dialing the name you want to find to display only matching entries. If you dial a name to return to the full list press the **Clear** soft key.
- d. To view more details of the highlighted name, press **Details**. To return to the directory press **List**.









2. When the required entry is highlighted, press **Call** or press the  button next to the name.

3. Continue as for a normally dialed call.

2.4 Calling from the Call Log/History

You can use the call log to make calls to the number included in the currently selected call record.

1. Access the call log.

- a. Press the  **HISTORY** button.
- b. The display will change to show your call log records. The caller's name is shown if known, otherwise the number. If you have any new missed call records, the button is illuminated and the call log will open showing your missed calls.
- c. Use the  left and right  arrow keys to select which call log records you are viewing. The options are **All**,  **Missed**,  **Incoming** and  **Outgoing**. On touch screen phones press the icon for the type of call log records to be displayed.
- d. Use the  up and down  arrow keys to scroll through the records.

2. Press **Call** to call the number displayed in the call record.

2.5 Redialling a Previous Number

When **Redial** is displayed it can be used in one of two ways, set by the phone's [redial mode setting](#) ³².

List Mode

This redial method is used when your phone's [redial mode](#) ³² is set to **List**.

1. Access the redial list.
 - a. Press **Redial**. The list of outgoing calls is displayed.
 - b. Use the ▲ up and down ▼ arrow keys to scroll through the 10 most recent outgoing calls.
2. Press **Call** to call the number displayed in the call record.
3. Continue in the same way as for a normal dialed call.

One Number Mode

This redial method is used when your phone's [redial mode](#) ³² is set to **One**.

1. Press **Redial**.
2. The number for the most recent outgoing call in your personal call log is redialed.
3. Continue in the same way as for a normal dialed call.

2.6 Making a Page Call

In order to make page calls you must have access to a paging short code provided by the system administrator or to a paging feature button.

If the dialing short code or the paging button have been pre-configured with a number, the user or group at that number will be paged if available.

The dialing short code can be configured to accept the number of the user or group to page when dialed. Similarly a paging button can be set to allow number entry when pressed as follows:

1. Press the paging button.
2. Dial the number of the user or group you want to page.
3. When the dialing is completed, the page call is made.
 - If the destination is a user and they already have a call connected, they cannot be paged. If the destination is a group which is not in service or has no available members, it cannot be paged.

Feature Button

The self-administer function can be used to assign a feature button as a page button using the Group Paging action.

2.7 Withholding Your Number

You can select to withhold your number on external calls. Note that this option may not be supported in all situations. It may depend on the configuration of your phone system and options supported by your telephone line provider.

1. Press the **Features** soft key if shown. To do this during a call, press the  **PHONE** key and then press the **Features** soft key.
2. Use the ▲ up and down ▼ arrow keys to highlight **Call Settings**. Press **Select**.
3. Use the ▲ up and down ▼ menu keys to highlight **Withhold Number**.
4. Press **Change** to switch the option **On** or **Off**.
5. Press **Save**.

2.8 Adjust the Call Volume

While talking, you can adjust the volume of the incoming call. The volume is separately adjusted for whichever device you are currently using (handset, headset or speaker).

1. With the call connected, press the  **VOLUME** key.
2. Use the + plus and – minus keys to adjust the volume.
3. The display will return to normal after a few seconds.



2.9 Muting a Call

Muting a call stops the caller from hearing you. However you can still hear them.

- The mute setting remains active even if you switch between calls using hold and or appearance buttons.
- If you change how you are listening to the call, for example switching from the handset to the speaker, the mute setting is canceled.

1. To activate mute, press the  **MUTE** key. The button will be lit while mute is active.
2. To switch mute off, press the key again.

2.10 Ending Calls

- The **Drop** option can be used to end the currently highlighted call on the display.
- If the call is connected on the phone's speaker, the  **SPEAKER** key is lit. Pressing the key again will end the call.
- If the call is connected on the phone's headset, the  **HEADSET** key is lit. Pressing the key again will end the call.
- If the call is connected on the phone's handset, replacing the handset will end the call.

Chapter 3.

Answering Calls

3. Answering Calls

A slow flashing red lamp on an appearance button indicates an alerting call. This may also be accompanied by [ringing](#)^[103] and by the [message lamp flashing](#)^[104].

Selected Button

If you are currently not on a call, you can answer the alerting call in the following ways:

1. Select the method which you want to use to talk to the caller:
 - To quiet the ringing, press the **Ignore** soft key. The call will still continue alerting visually and can be answered or ignored.
 - To redirect the call to voicemail, press the **To VM** soft key.
 - To answer the call using the handset, lift the handset.
 - To answer the call handsfree, press the **SPEAKER** key.
 - To answer the call on a headset, press the **HEADSET** key.
 - Just pressing the call appearance key will answer the call either on the speaker or headset depending on the phone's [audio path](#)^[46] setting.
2. Once you have answered the call, you can switch between different talk modes:
 - To switch to using the handset, lift the handset.
 - To switch to handsfree, press the **SPEAKER** key. If you were using the handset you can now safely replace it.
 - To switch to headset mode, press the **HEADSET** key. If you were using the handset you can now safely replace it.
 - If you have answered the call on the speaker or headset, pressing the **SPEAKER** or **HEADSET** key again before you select another mode will end the call.
 - Just pressing the call appearance key or any other appearance button will put the current call on hold.

Answering Another Call

If you are already on a call, answering a new call will automatically put the existing call on hold.^[1] unless your first press **Drop**.

1. Using the ▲ up and down ▼ arrow keys, scroll the display highlight the waiting call.
 - To quiet the ringing, press the **Ignore** soft key. The call will still continue alerting and can be answered or ignored.
 - To redirect the call to voicemail, press the **To VM** soft key.
2. To answer the call press the call appearance button. Your existing call will be put on hold.

Notes

1. This guide assumes that auto hold is enabled (the default). The system administrator can disable auto hold for the system, in which case calls are automatically disconnected rather than held.

3.1 Divert a Call to Voicemail

You can transfer a call targeted at you directly to your voicemail mailbox.

1. If the call is not the currently highlighted call on the display, use the ▲ up and down ▼ arrow keys to highlight it.
2. Press the **To VM** soft key. The call is redirected to your mailbox.

3.2 Ignore an Incoming Call

You can quiet the ringer of a currently alerting call. The call will continue alerting visually but with no audible ring.

1. If the call is not the currently highlighted call on the display, use the ▲ up and down ▼ arrow keys to highlight it.
2. Press the **Ignore** soft key.
3. The call will continue alerting but with no audible ring.

3.3 Answering a Page Call

Your phone can be paged if you have no other connected call in progress. The page is heard through the phone's speaker.

1. A page call is indicated in the display by the word **Page**.
 - To answer the page call, press the **Answer** soft key. The call is turned into a normal call.
 - To ignore the page call, press the **Drop** soft key.

3.4 Call Pickup

Pickup is used to answer a call ringing elsewhere on the phone system. There are a number of pickup options:

- Answer any ringing call on the telephone system.
- Answer a call ringing a particular user.
- Answer a call ringing a particular group.
- Answer a call, not necessarily a group call, ringing the members of a group.

1. Press the **Features** soft key if shown. To do this during a call, press the  **PHONE** key and then press the **Features** soft key.

2. Use the ▲ up and down ▼ arrow keys to highlight **Pickup**. Press **Select**.

- To answer a ringing call, press the **Any** soft key.
- To answer a call ringing against a particular target, dial the targets number. Alternatively, press the **Dir** soft key to [select the target from the directory](#)^[52].

3. The following menus will depend on the type of number entered:

- **User Number**

- To answer a call ringing against the user, press the **Pickup** soft key.
- To return to entering a number, press the **Clear** key.

- **Hunt Group Number**

- To answer a call ringing against the members of the group, press the **Members** soft key. The call does not have to be a call to the hunt group.
- To answer a call ringing for the hunt group, press the **Group** soft key.
- To return to entering a number, press the **Clear** key.

Default Short Codes

Short codes are numbers that you can dial to enable and disable various features. The following are default short codes that may be available. Your system administrator will confirm any additional short codes that they may have configured for your use.

- **Pickup Any Call: *30**
Answer a call ringing on the telephone system.
- **Pickup a Group Call: *31**
Answer a call ringing a group of which you are a member. You can use this even if your group membership is currently set to disabled.
- **Pickup a Users Call: *32*N#**
Pickup a call ringing a user's extension number (**N**).
- **Pickup a Group Members Call: *53*N#**
Pickup a call ringing the members of a group (**N**). This does not necessarily have to be a group call.

Chapter 4.

Redialling

4. Redialling

The phone's redial operation can work in either of the following modes:

- **Open Call Log**
If this mode is selected, pressing **Redial** will display a menu of the 10 most recent outgoing calls in your call log. You can select the call that you want to redial and perform a number of other functions.
- **Last Dialed**
If this mode is selected, pressing **Redial** will immediately repeat the most recent outgoing call in your call log. None of the other redial functions will be accessible.

You can [select the redial mode](#)^[32] that the phone uses. In either case, the redial function uses the outgoing call records in your [personal call log](#)^[58]. If you delete the records in your call log, redial will not work until new outgoing call records exist in your personal call log.

Note

1. Use of centralized call log can be switched off by the system administrator. In that case the numbers used for the redial function are stored by the phone. This guide only covers redial using outgoing call records in the user's centralized call log.

4.1 Redial (Last Dialed Mode)

This redial method is used when your phone's [redial mode](#)^[32] is set to **One**.

1. Press **Redial**.
2. The number for the most recent outgoing call in your personal call log is redialed.
3. Continue in the same way as for a normal dialed call.

4.2 Redial (Call Log Mode)

This redial method is used when your phone's [redial mode](#)^[32] is set to **List**.

1. Access the redial list.
 - a. Press **Redial**. The list of outgoing calls is displayed.
 - b. Use the ▲ up and down ▼ arrow keys to scroll through the 10 most recent outgoing calls.
2. Press **Call** to call the number displayed in the call record.
3. Continue in the same way as for a normal dialed call.

4.3 Selecting Your Redial Mode

You can select whether your phone uses the redial list or last call redial mode.

1. Press the **Features** soft key if shown. To do this during a call, press the  **PHONE** key and then press the **Features** soft key.
2. Use the ▲ up and down ▼ arrow keys to highlight **Call Settings**. Press **Select**.
4. Use the ▲ up and down ▼ arrow keys to highlight **Redial Action**.
5. The current mode, **Open Call Log** or **Last Dialed** is displayed.
 - **Open Call Log**
If this mode is selected, pressing **Redial** will display a menu of the 10 most recent outgoing calls in your call log. You can select the call that you want to redial and perform a number of other functions.
 - **Last Dialed**
If this mode is selected, pressing **Redial** will immediately repeat the most recent outgoing call in your call log. None of the other redial functions will be accessible.
6. Press **Change** to change the mode.
7. When the required mode is displayed, press **Save**.

Chapter 5.

Holding and Parking Calls

5. Holding and Parking Calls

Holding a call and parking a call are two similar actions. The current caller is placed on hold and hears music on hold if available. The table below summarizes the main differences between parking a call or holding a call.

When used to park or hold a call...	Hold	Park
... the call occupies an appearance button.	Yes	No
... the caller hears music on hold if available.	Yes	Yes
... the calls can be retrieved by other users dialing a short code.	No	Yes
... the calls recalls you automatically if your phone is idle.	Yes Default 15 seconds	Yes Default 5 minutes.
... can be used with conference calls.	Yes	No
... can be used to start or add calls to a conference.	Yes	No
... the call is assigned a unique ID.	No	Yes

5.1 Holding Calls

You can hold a call or several calls.

- The held call will still occupy the appearance button on which it was made or answered.
- While held the caller will hear music on hold. If your system does not have music on hold available, the caller will hear double beep tones every few seconds.
- If you have more than one held call, or one held call and a connected call, pressing the **Conference** soft key will start a conference between yourself and the calls.

Calls that you have held will return to your phone (when idle) if they remain on hold for too long. The default return delay is 15 seconds. Your hold recall can be changed by the system administrator. Returning calls ignore any forwarding or do not disturb settings.

Important - Holding Conference Calls

You can hold a conference call in the same way as holding a normal call. Holding the conference call does not affect the other conference parties who can continue talking. You will also still be listed as a member of the conference call in the conference details.

- **Warning:** This only applies to conference calls hosted by your own telephone system. Holding your call to a conference hosted on another telephone system may cause that conference to hear your system's music on hold.

5.1.1 Holding a Call

1. To put your current call on hold, press the **Hold** soft key or the call's appearance button.
2. The held call will be indicated by its appearance key using a fast flashing lamp.
3. While held the caller will hear music on hold. If your system does not have music on hold available, the caller will hear double beep tones every few seconds.
4. If you can scroll the display using the ▲ up and down ▼ arrow keys, the held call will appear with a 📞 icon.

5.1.2 Taking a Call Off Hold

Either of the following methods can be used to retrieve a call from hold. If you have a currently connected call, that call will be automatically put on hold.

1. Press the appearance button with the fast flashing red lamp call appearance.
2. Scroll the display using the ▲ up and down ▼ arrow keys, the held call will appear with a 📞 icon. Press the **Connect** soft key to take the call off hold.

5.1.3 Switching Between Calls

With a call on hold (fast flashing appearance button) and another call connected (red call appearance button), you can switch between calls by pressing the appearance button of the held call. The current call is automatically put on hold and the previously held call connected.

5.1.4 Transfer a Held Call

When you already have a call on hold and a call connected, you can connect them by starting a conference. Press the **Conf** soft key. Your current call and the held call will be connected. You can now [drop yourself](#) ⁴³ from the conference.

Note

1. If you are the only internal user in the conference, depending on your telephone systems configuration, dropping yourself from the conference may end it. Consult your system administrator for details.

5.2 Parking Calls

Parking a call is similar to holding a call. However parked calls can be unparked by other users on the phone system. Each parked call is given a number. By default the number is your extension number plus a digit.

Calls that you have parked will return to your phone (when idle) if they remain parked for too long. The default return delay is 5 minutes. This is a system delay that is applied to all users and can be changed by the system administrator. Returning calls ignore any forwarding or do not disturb settings.

If you park a call without specifying a park slot number, the system will assign a number based on your extension number plus a single digit. For example for extension 201, the first parked call will use park slot number 2010 if available. If you already have one parked call, the next parked call will use park slot number 2011 if available.

Call park buttons can be configured with a specific park slot numbers. A calls parked using that button will be given that park slot number. Any other users with a call park button set to the same number will see that there is a parked call and can unpark it using their button.



A [feature button](#) ⁽⁹²⁾ set to the **Call Park** action can be used to park and unpark calls. If configured to a specific park number, the button will indicate when another user has parked a call using that park slot number.

Default Short Codes

Short codes are numbers that you can dial to enable and disable various features. The following are default short codes that may be available. Your system administrator will confirm any additional short codes that they may have configured for your use.



- **Park Call: *37*N#**
Parks the held call using the park number dialed in place of **N**.
- **Unpark Call: *38*N#**
Unpark the call parked using the park number **N**.

5.2.1 Park Using the Menu

1. Press the **Features** soft key if shown. To do this during a call, press the  **PHONE** key and then press the **Features** soft key.
2. Use the  up and down  arrow keys to highlight **Call Park** or **Call Park To Other**.
 - **Call Park**
Park the call on the system with parked call indication on your extension.
 - **Call Park To Other**
Park the call on the system with parked call indication on the selected extension.

5.2.2 Unpark (Status Menu)

While parked calls are parked on the telephone system and can be unparked by any other user, the parked call indication is sent to a particular extension. If there are any calls parked against your phone, you can view and unpark them using the **Status** menu.

1. Press the **Status** soft key if shown.
 - To access the status menu during a call, press the  **PHONE** key and then press the **Status** soft key if shown.
2. If you have any parked calls, the **Parks** option is displayed. The option is not present if you do not have calls parked against your extension.
3. Press the **Details** soft key.
4. Use the  up and down  arrow keys to scroll through the parked calls.
5. To unpark a particular call, press the **Connect** soft key.

Chapter 6.

Transferring Calls

6. Transferring Calls

To transfer a call your phone must have an available call appearance button. If all your current call appearance buttons are in use, you must [end](#) [26] or [park](#) [36] one of your existing calls.

1. Press **Transfer**. The current call is automatically put on hold.
2. Dial the number for the transfer. Alternatively, press **Dir** to [select a destination from the directory](#) [52].
 - To complete the transfer, press **Complete**. You can do this while the call is still ringing.
 - Transferring a call while it is still ringing is called an unsupervised transfer.
 - Transferring a call after ringing finishes is called a supervised transfer.
 - If the transfer destination does not answer or, after answering the call, does not want to accept the call, press the **Cancel** soft key.
3. Press **Complete** to complete the transfer. If the transfer destination does not answer or does not want to accept the call, press the **Cancel** soft key.

6.1 Transfer to Voicemail

When set to visual voice mode, the  key can be used to transfer your current call to the voicemail mailbox of another user or group.

1. With the call connected, press the  key. You are still connected to the call and can continue talking.
2. Dial the extension number of the user or group to which you want to transfer the call.
3. When the number matches a user or group, their name is displayed.
 - To transfer the call to the user or group's mailbox, press **Select**. The caller will hear a few seconds of ringing and then the mailbox greeting.
 - To exit the transfer menu, press **Cancel**.

6.2 Transferring a Held Call

When you already have a call on hold and a call connected, you can connect them by starting a conference. Press the **Conf** soft key. Your current call and the held call will be connected. You can now [drop yourself](#) [43] from the conference.

Note

1. If you are the only internal user in the conference, depending on your telephone systems configuration, dropping yourself from the conference may end it. Consult your system administrator for details.

Chapter 7.

Account Codes

7. Account Codes

The telephone system can store a number of account codes. Account codes may be used to keep track of calls in relation to particular activities or clients. They can also be used to keep track of calls by particular users or sets of users.

- When an account code is entered while making a call or during a call, that account code is included in the call records output by the system.
- Accounts entered are checked against those stored by the telephone system. If an invalid code is entered, the account code is requested again.
- The system administrator can configure certain numbers or types of numbers to require entry of an account code before you can continue making a call to such a number.
- The system administrator can also configure you to have to enter an account code before making any external call.

7.1 Forced Account Code Entry

The system administrator can configure certain numbers or types of numbers to require entry of an account code before you can continue making a call to such a number.

1. The follow menu is displayed when you are required to enter an account code.
2. Enter the account code that you want to use.
3. Press the **Done** soft key.
4. If the account code was not a valid account code, the **REENTER ACCOUNT** menu is displayed.

7.2 Manual Account Code Entry

You can enter account codes during a call or before making a call. The account code that you enter must match an account code set on the telephone system.

1. Press the **Features** soft key if shown. To do this during a call, press the  **PHONE** key and then press the **Features** soft key.
2. Use the ▲ up and down ▼ arrow keys to highlight **Call Settings**. Press **Select**.
4. Use the ▲ up and down ▼ arrow keys to highlight **Account Code**.
5. Press the **Set** soft key or the **OK** button or the ► right arrow key.
6. Enter the account code that you want to use.
7. Press the **Done** soft key.
8. If the account code was not a valid account code, the **Failed** menu is displayed.

Feature Button

Access to the enter account code menu can be assigned to a [feature button](#) ⁹² configured with the Account Code Entry action. The button can also be preset with a specific account code.

Chapter 8.

Conference Calls

8. Conference Calls

The telephone system supports multiple conference call, with additional parties addable to any conference call until the system's conference capacity is reached. A maximum of 64 parties in any particular conference call is supported.

Conference resources are also used for call recording and other features, reducing the available conference capacity for ordinary conference calls.

Note that some conference controls, for example dropping other parties, only apply for conferences started on the same phone system as your extension.

Default Short Codes

Short codes are numbers that you can dial to enable and disable various features. The following are default short codes that may be available. Your system administrator will confirm any additional short codes that they may have configured for your use.

- **Conference Held Calls: *47**
Start a conference between yourself and any calls that you have on hold.

8.1 Starting a Conference

If you have a connected call and any held calls, pressing the **Conf** soft key will start a conference between you and those calls.

If you do not already have a held call, you can use the process below to start a conference.

1. Make a call to the first party or answer a call.
2. Press the **Conf** soft key. The current call is automatically put on hold.
3. Dial the party that you want to add to the conference.
4. If they answer and want to join the call, press **Conf** again.
5. If they do not want to join the call or do not answer, press **Drop** and then press the appearance key of the held call.

8.2 Adding a Call to a Conference

You can add additional parties to an existing conference.

1. Press **HOLD** to put the conference on hold. This does not affect the other conference parties who can continue talking to each other.
2. Press an available appearance key on which to make a call.
3. Dial the party that you want to add to the conference.
4. If they answer and want to join the call, press **Conf** again.
5. If they do not want to join the call or do not answer, press **Drop** and then press the appearance key of the held call.

8.3 Viewing Conference Details

You can display a list of the parties involved in a conference call.

1. If not already displayed, press the ▲ up or down ▼ arrow key to display the conference call.
2. Press the **Details** soft key.
 - To scroll through the list of callers in the conference, use the ▲ up and down ▼ arrow keys.
 - To drop a caller from the conference, highlight them and press **Drop**.
 - To mute a caller, highlight them and press **Mute**. Repeat this to unmute them.
 - To return to the call display, press the **Back** soft key.

8.4 Dropping/Muting Parties

You can drop parties from a conference call, including yourself. You can also mute other parties.

1. While connected to a conference call, if you press the **Details** key, the conference details menu is displayed.
2. You can then perform the following actions:
 - To scroll through the list of callers in the conference, use the ▲ up and down ▼ arrow keys.
 - To drop a caller from the conference, highlight them and press **Drop**.
 - To mute a caller, highlight them and press **Mute**. Repeat this to unmute them.
 - To return to the call display, press the **Back** soft key.

Note

1. If you are the only internal user in the conference, depending on your telephone systems configuration, dropping yourself from the conference may end it. Consult your system administrator for details.

8.5 Holding a Conference Call

Using the **Hold** soft key you can put a conference call on hold in the same way as you can for a normal call. The appearance key for the conference call will show a fast flashing red lamp.

To take the conference call off hold, press the appearance key.

Important - Holding Conference Calls

You can hold a conference call in the same way as holding a normal call. Holding the conference call does not affect the other conference parties who can continue talking. You will also still be listed as a member of the conference call in the conference details.

- **Warning:** This only applies to conference calls hosted by your own telephone system. Holding your call to a conference hosted on another telephone system may cause that conference to hear your system's music on hold.

8.6 Transferring Calls Using Conference

When you already have a call on hold and a call connected, you can connect them by starting a conference. Press the **Conf** soft key. Your current call and the held call will be connected. You can now [drop yourself](#) from the conference.

Note

1. If you are the only internal user in the conference, depending on your telephone systems configuration, dropping yourself from the conference may end it. Consult your system administrator for details.

Chapter 9.

Headset/Handsfree Operation

9. Headset/Handsfree Operation

9.1 Headset Operation

Your phone has a headset socket located under the phone. This is suitable for the connection of phone headsets that connect via a HIS headset cable.

- Pressing the  **HEADSET** key can be used to answer a call through the headset. It can also be pressed to end a headset call.
- The key is lit when there is a call connected through the headset.
- The key can also be pressed to turn a call already answered using the handset or handsfree into a headset call.
- If there are no currently connected call to which you are talking, a call answered by pressing its appearance button is connected either handsfree or through the headset according to the phone's [audio path setting](#) ^[46].
- If there is already a connected call to which you are talking through the headset, answering another call by pressing the appearance button will answer that call using the headset.

You can adjust the following handsfree settings:

- [Headset Volume](#) ^[113]
- [Headset Automatic Gain Control On/Off](#) ^[113]
- [Default Audio Path](#) ^[46]

9.1.1 Headset Volume









While talking via the headset, you can adjust the volume of the incoming call.

1. With the call connected on the headset, press the  key.
2. Use the **+** plus and **-** minus keys to adjust the volume.
3. The display will return to normal after a few seconds.

9.1.2 Default Handsfree Audio Path

By default, when you make a call or answer a call without lifting the handset, the audio is played through the phone's speaker while you speak via the phone's microphone.

If you have a headset attached, you can change the phone's behavior so the audio is played through the headset by default rather than the speaker.

1. Press the  **MENU** button. On touch screen phones, press the  **HOME** button and select **Settings**.
2. Use the  up and down  arrow keys to highlight **Options & Settings**. Press **Select**.
3. Use the  up and down  arrow keys to highlight **Call Settings**. Press **Select**.
4. Use the  up and down  arrow keys to highlight **Audio Path**.
5. Press **Change** to change the setting between **Headset** and **Speaker**.
6. When completed, press the **Save** soft key.
7. Press the **Back / Exit** soft keys to exit the menus.

9.2 Handsfree Speaker Operation

Your phone has a speaker and microphone that allows you make and answer calls handsfree. The speaker is located under the handset. The microphone is located near the bottom right of the phone's keypad.

- Pressing the **|| SPEAKER** key can be used to answer a call handsfree. It can also be pressed to end a handsfree call.
- The key is lit when there is a call connected handsfree.
- The key can also be pressed to turn a call already answered using the handset or headset into a handsfree call.
- If there are no currently connected call to which you are talking, a call answered by pressing its appearance button is connected either handsfree or through the headset according to the phone's [audio path setting](#) ^[46].
- If there is already a connected call to which you are talking handsfree, answering another call by pressing the appearance button will answer that call handsfree.

You can adjust the following handsfree settings:

- [Speaker Volume](#) ^[113]
- [Speaker Automatic Gain Control On/Off](#) ^[113]
- [Default Audio Path](#) ^[47]

Conference Phones

Your phone is not designed as a conference room speakerphone. It is designed for use by a speaker located directly in front of the phone with no obstructions between themselves and the microphone. Phones designed to be used as conference speakerphones typically have multiple microphones and are able to handle sounds coming from multiple directions. For details of conference speakerphones supported by your phone system contact your system administrator.

9.2.1 Speaker Volume

While talking handsfree via the phone's speaker, you can adjust the volume of the incoming call.

1. With the call connected on the speaker, press the **◀** key.
2. Use the **+** plus and **-** minus keys to adjust the volume.
3. The display will return to normal after a few seconds.

9.2.2 Default Handsfree Audio Path

By default, when you make a call or answer a call without lifting the handset, the audio is played through the phone's speaker while you speak via the phone's microphone.

If you have a headset attached, you can change the phone's behavior so the audio is played through the headset by default rather than the speaker.

1. Press the **A MENU** button. On touch screen phones, press the **A HOME** button and select **Settings**.
2. Use the **▲** up and down **▼** arrow keys to highlight **Options & Settings**. Press **Select**.
3. Use the **▲** up and down **▼** arrow keys to highlight **Call Settings**. Press **Select**.
4. Use the **▲** up and down **▼** arrow keys to highlight **Audio Path**.
5. Press **Change** to change the setting between **Headset** and **Speaker**.
6. When completed, press the **Save** soft key.
7. Press the **Back / Exit** soft keys to exit the menus.



Chapter 10.

Contacts/Directory

10. Contacts/Directory

This menu is accessed by pressing the  **CONTACTS** key. It is used to display names and numbers that you can then use for making calls.

The directory includes names stored for use by all users, names stored for use by just you and the name and numbers of all the other users and groups on the phone system.

The contacts shown in the directory come from a number of sources.

- **Personal Directory Contacts**

These contacts are stored by the telephone system as part of your user settings.

- They are displayed on the phone while you are using it. If you hot desk to another phone that also stores your contacts on the system, your personal contacts move with you.
- You can have up to 100 personal directory entries^[2] which you can add, edit and delete these through the phone.
- The system administrator can also add, edit and delete your personal directory entries.

- **User Contacts**

These contacts list all^[3] the other systems on the telephone system. If your system is part of a Small Community Network of IP Office telephone systems, it includes users on the other systems.

- **Group Contacts**

These contacts list all the hunt groups on the telephone system. If your system is part of a Small Community Network of IP Office telephone systems, it includes those hunt groups that the system administrator has configured to be advertised across the network.

- **External Contacts**

These contacts are viewable and useable by all phone users. These are two types of external contacts:

- Some external contacts are entered into the telephone system configuration by the system administrator.^[1]
- Other external contacts are those imported by the telephone system from other directory sources.

Note

1. If you have been configured as a system phone user by the system administrator, then you can also add, edit and delete some external directory contacts.
2. While each user is allowed up to 100 personal directory entries, the total capacity of the system may limit the addition of further personal directory entries for all users.
3. The system administrator can set other users as **Ex Directory**. Those users are then not included in the user directory.



10.1 Managing External Contacts

If you have been configured as a system phone user by the system administrator, then you can also add, edit and delete some external directory contacts.



- This only applies to external directory contacts entered locally into configuration of the telephone system at which you are logged in.
- External directory contacts imported by the system from other sources cannot be edited. However, if a local entry is created with the same name or number as an imported entry, the imported entry is discarded in favour of the local one.

10.2 Viewing Contacts Details

1. Access the contacts directory:



- a. Press the  **CONTACTS** key. The directory menu is displayed.
- b. Use the  left and right  arrow keys to select which type of directory entries you want displayed.

- **All**
All directory entries.
- **External**
Directory entries stored by the telephony system for all users to use.
- **Groups**
The names and numbers of hunt groups on the telephone system.
- **Users**
The names and numbers of other users on the telephone system.
- **Personal**
Your own personal directory entries.





c. Use the  up and down  arrow keys to scroll through the list or start dialing the name you want to find to display only matching entries. If you dial a name to return to the full list press the **Clear** soft key.

d. To view more details of the highlighted name, press **Details**. To return to the directory press **List**.

2. When the required entry is highlighted, press **Details** to display the name, number and type of contact.







3. Use the  up and down  arrow key to scroll through the contacts.

4. The range of soft keys available will depend on the type of directory entry:

- **Call** 
Make a call to the stored number.
- **List**
Return to the list of contacts.
- **More**
If the contact is one of your personal directory entries, the **More** soft key will be present to allow you to access the options below. It is also present for external directory entries if you have been setup as a system phone user by the system administrator.
- **Edit** 
Edit the name and number.
- **Delete** 
Delete the name and number.
- **New** 
Add a new personal directory contact.

10.3 Make a Call from the Directory



You can use any directory contacts to make a call. You can also use the directory in almost any telephone function where you need to select the number for a destination, for example during transfers.

1. Access the contacts directory:
 - a. Press the  **CONTACTS** key. The directory menu is displayed.
 - b. Use the  left and right  arrow keys to select which type of directory entries you want displayed.
 - **All**
All directory entries.
 - **External**
Directory entries stored by the telephony system for all users to use.
 - **Groups**
The names and numbers of hunt groups on the telephone system.
 - **Users**
The names and numbers of other users on the telephone system.
 - **Personal**
Your own personal directory entries.
 - c. Use the  up and down  arrow keys to scroll through the list or start dialing the name you want to find to display only matching entries. If you dial a name to return to the full list press the **Clear** soft key.
 - d. To view more details of the highlighted name, press **Details**. To return to the directory press **List**.
2. When the required entry is highlighted, press **Call** or press the  button next to the name.
3. Continue as for a normally dialed call.

10.4 Using the Directory for Other Functions





Within other menus where entry of a number is required, it may be possible to use the directory to select an existing number by name. If this option is available, it will be indicated by the presence of a **Dir** soft key in the menu.

When using the directory in this way, the names made available will depend on the type of function that is being setup. For example, for some functions only group names will be displayed, for others only user names.

1. Press the **Dir** soft key.
2. Either dial the name to see a list of matches or press the **List** soft key to list all names.
 - a. Use the  up and down  arrow keys to scroll through the list or start dialing the name you want to find to display only matching entries. If you dial a name to return to the full list press the **Clear** soft key.
 - b. To view more details of the highlighted name press **Details**. To return to the directory press **List**.
3. When the required entry is highlighted, press **Select**.
4. You will be returned to the menu in which you selected the **Dir** soft key.

10.5 Adding a New Contact

So long as the telephone system capacity has not been reached, you can add up to 100 personal directory entries.











1. Access your personal directory contacts:
 - a. Press the  **CONTACTS** key. The directory menu is displayed.
 - b. Use the  left and right  arrow keys to select your **Personal** directory.
2. Press the **New** soft key.
 - The menu now allows editing of the name and number.
 - Use the  up and down  arrow keys to switch between number and name entry.
 - When the name and number have been entered as required, press the **Save** soft key.
 - To exit without making any changes, press the **Cancel** soft key.

Note

1. If you have been configured as a system phone user by the system administrator, then you can also add, edit and delete some external directory contacts.







10.5.1 Add a Contact from the Call Log/History

You can add a name and number shown in your call log to your personal contacts.

1. Access the call log.
 - a. Press the  **HISTORY** button.
 - b. The display will change to show your call log records. The caller's name is shown if known, otherwise the number. If you have any new missed call records, the button is illuminated and the call log will open showing your missed calls.
 - c. Use the  left and right  arrow keys to select which call log records you are viewing. The options are **All**,  **Missed**,  **Incoming** and  **Outgoing**. On touch screen phones press the icon for the type of call log records to be displayed.
 - d. Use the  up and down  arrow keys to scroll through the records.
2. Press **More** and then press the **+Contact** soft key.
3. Use the  up and down  arrow keys to switch between the name and number details for the new contact.
4. Using the telephone keypad and the **Bksp** soft key you can edit the name and the number. When editing the number, use the **Pause** soft key to enter a comma (,) for a 1 second pause in the number dialing.
5. When the name and number are set as required, press the **Save** soft key. To return without saving the name and number, press the **Cancel** soft key.

10.6 Editing a Contact

You can edit the contacts in your own personal directory.





1. Access your personal directory contacts:
 - a. Press the  **CONTACTS** key. The directory menu is displayed.
 - b. Use the  left and right  arrow keys to select your **Personal** directory.
 - c. Use the  up and down  arrow keys to scroll through the list or start dialing the name you want to find to display only matching entries. If you dial a name to return to the full list press the **Clear** soft key.
 - d. To view more details of the highlighted name, press **Details**. To return to the directory press **List**.
2. Locate the required entry.
3. Press the **Details** soft key.
4. Press the **More** soft key and then the **Edit** soft key.
 - The menu now allows editing of the name and number.
 - Use the  up and down  arrow keys to switch between number and name entry.
 - When the name and number have been entered as required, press the **Save** soft key.
 - To exit without making any changes, press the **Cancel** soft key.

Note

1. If you have been configured as a system phone user by the system administrator, then you can also add, edit and delete some external directory contacts.

10.7 Deleting a Contact

You can delete a contact from your own personal directory.

1. Access your personal directory contacts:
 - a. Press the  **CONTACTS** key. The directory menu is displayed.
 - b. Use the  left and right  arrow keys to select your **Personal** directory.
 - c. Use the  up and down  arrow keys to scroll through the list or start dialing the name you want to find to display only matching entries. If you dial a name to return to the full list press the **Clear** soft key.
 - d. To view more details of the highlighted name, press **Details**. To return to the directory press **List**.
2. Locate the required entry.
3. Press the **Details** soft key.
4. Press the **More** soft key and then the **Delete** soft key.
5. Press the **Delete** soft key again to confirm the action.

Note

1. If you have been configured as a system phone user by the system administrator, then you can also add, edit and delete some external directory contacts.

Chapter 11.

Call History

11. Call History

This menu is accessed by pressing the  **HISTORY** key. The call log you see is a call log stored on the telephone system. If you login at another phone that also does this, your call history moves with you.

Your call history contains your 10 most recent answered calls, 10 most recent calls you made and 10 most recent missed calls. If configured by the system administrator, it can also include calls missed by hunt groups of which you are a member.

- [Making a Call](#) 
- [Viewing Call Details](#) 
- [Deleting a Record](#) 
- [Deleting All Records](#) 
- [Add a Record to Your Contacts](#) 

Missed Calls

Missed calls are calls to you that you did not answer. Your system administrator can also configure if the log includes calls presented to you but answered by someone else or by voicemail.

The  **History** button is illuminated when you have any new missed calls in your call log. The lamp is extinguished when you have viewed the missed call in the call log or the record of that call is no longer in your call log.

The  icon is also used at the top left of the phone display to indicate missed calls and is prefixed with the number of missed calls.















Missed Group Call

If you are a member of any hunt groups, the system administrator can configure whether your missed calls log should also include missed hunt groups calls. The hunt group does not necessarily have to have rung your phone. It will be recorded as missed if it was presented to the hunt group and not answered by any of the members including you.

Notes









1. Centralized call log can be turned off by the [system administrator](#) . In that case the call log is one stored by the phone and is lost if the phone is reset. This guide only covers the centralized call log stored by the telephone system.
2. The call log on other types of phones is a local call log maintained by that phone. It will not move with you when you hot desk and it will be lost if the phone is restarted.
3. The redial function uses the outgoing call records stored in the call log.

11.1 Accessing the Call Log/History

1. Access the call log.
 - a. Press the  **HISTORY** button.
 - b. The display will change to show your call log records. The caller's name is shown if known, otherwise the number. If you have any new missed call records, the button is illuminated and the call log will open showing your missed calls.
 - c. Use the  left and right  arrow keys to select which call log records you are viewing. The options are **All**,  **Missed**,  **Incoming** and  **Outgoing**. On touch screen phones press the icon for the type of call log records to be displayed.
 - d. Use the  up and down  arrow keys to scroll through the records.
2. Pressing **OK** will make a call to the number stored with the currently displayed record.
3. You can use the functions listed at the bottom of the display by pressing the soft key below the function name.
 - **Call**  ⁵⁷
Make a call to the number stored in the currently displayed call log record.
 - **Details**  ⁵⁸
Display more details about the current call log record. You can then also [add the caller details to your personal directory](#)  ⁵⁹ if required.
 - **Delete**  ⁵⁹
Deletes the current displayed record.
 - **More**
Switch between the different sets of available soft key functions.
 - **Del All**  ⁵⁹
Delete all the call log records, not just the current types of records being shown.
 - **+Contact**  ⁵⁹
Add the currently highlighted call log record to your personal contacts.
4. To exit the call log, press the **PHONE/EXIT** button.

11.2 Making a Call

You can use the call log to make calls to the number included in the currently selected call record.

1. Access the call log.
 - a. Press the  **HISTORY** button.
 - b. The display will change to show your call log records. The caller's name is shown if known, otherwise the number. If you have any new missed call records, the button is illuminated and the call log will open showing your missed calls.
 - c. Use the  left and right  arrow keys to select which call log records you are viewing. The options are **All**,  **Missed**,  **Incoming** and  **Outgoing**. On touch screen phones press the icon for the type of call log records to be displayed.
 - d. Use the  up and down  arrow keys to scroll through the records.
2. Press **Call** to call the number displayed in the call record.





11.3 Viewing Call Details

You can view additional details about the currently shown call.

1. Access the call log.

a. Press the  **HISTORY** button.

b. The display will change to show your call log records. The caller's name is shown if known, otherwise the number. If you have any new missed call records, the button is illuminated and the call log will open showing your missed calls.



c. Use the  left and right  arrow keys to select which call log records you are viewing. The options are **All**,  **Missed**,  **Incoming** and  **Outgoing**. On touch screen phones press the icon for the type of call log records to be displayed.

d. Use the  up and down  arrow keys to scroll through the records.



2. Press the **Details** soft key. The individual details of the currently selected call record are displayed.

3. The possible values are:

Name	Call Type Icon
Number	Count
Time and Date	Duration









- **Name** - The name of the caller if known.
- **Number** - The number of the caller if available.
- **Time and Date** - The time of the call.
- **Call Type Icon** - The type of call record, ie.  = **Incoming**,  = **Outgoing** or  = **Missed**.
- **Count** - How many time a call of the same type, name and number has occurred. Only the details of the most recent call are kept in your call log. However the count will indicate if the caller has rung or has been rung several times.
- **Duration** - The length of the call.

4. While you are in the details of a call record, the soft key functions available are:

- **Call**
Call the number shown in the call record. You can also do this by pressing the **OK** button.
- **List**
Go back to the normal call screen to select another call record. You can also use the  up and down  arrow keys to view the previous or next record.
- **Delete**
Delete the currently displayed record.
- **More**
Switch between the different sets of available soft key functions.
- **+Contact**
Add the name and number to your personal directory. You can edit the details before they are added.
- **Delete All**
Delete all the records.









11.4 Deleting a Record

You can delete the currently displayed call record. If the record is a missed hunt group call, the record is also deleted from the call log of other users configured to see the same hunt group's missed calls.

1. Access the call log.
 - a. Press the  **HISTORY** button.
 - b. The display will change to show your call log records. The caller's name is shown if known, otherwise the number. If you have any new missed call records, the button is illuminated and the call log will open showing your missed calls.
 - c. Use the  left and right  arrow keys to select which call log records you are viewing. The options are **All**,  **Missed**,  **Incoming** and  **Outgoing**. On touch screen phones press the icon for the type of call log records to be displayed.
 - d. Use the  up and down  arrow keys to scroll through the records.
2. When the required record is highlight, press **More** and then press **Delete**.











11.5 Deleting All Records

You can delete all call records from your call log. This action deletes all call log record types (**Incoming**, **Missed** and **Outgoing**), not just the type you are currently viewing. This action deletes your personal call records and any hunt group call records.

1. Access the call log.
 - a. Press the  **HISTORY** button.
 - b. The display will change to show your call log records. The caller's name is shown if known, otherwise the number. If you have any new missed call records, the button is illuminated and the call log will open showing your missed calls.
 - c. Use the  left and right  arrow keys to select which call log records you are viewing. The options are **All**,  **Missed**,  **Incoming** and  **Outgoing**. On touch screen phones press the icon for the type of call log records to be displayed.
 - d. Use the  up and down  arrow keys to scroll through the records.
2. Press the **More** soft key.
3. Press the **Del All** soft key to delete all your call log records.

11.6 Adding a Record to Your Contacts

You can add a name and number shown in your call log to your personal contacts.

1. Access the call log.
 - a. Press the  **HISTORY** button.
 - b. The display will change to show your call log records. The caller's name is shown if known, otherwise the number. If you have any new missed call records, the button is illuminated and the call log will open showing your missed calls.
 - c. Use the  left and right  arrow keys to select which call log records you are viewing. The options are **All**,  **Missed**,  **Incoming** and  **Outgoing**. On touch screen phones press the icon for the type of call log records to be displayed.
 - d. Use the  up and down  arrow keys to scroll through the records.
2. Press **More** and then press the **+Contact** soft key.
3. Use the  up and down  arrow keys to switch between the name and number details for the new contact.
4. Using the telephone keypad and the **Bksp** soft key you can edit the name and the number. When editing the number, use the **Pause** soft key to enter a comma (,) for a 1 second pause in the number dialing.
5. When the name and number are set as required, press the **Save** soft key. To return without saving the name and number, press the **Cancel** soft key.

Chapter 12.

Voicemail

12. Voicemail

If your telephone system includes a voicemail server, pressing the  **MESSAGES** button accesses a series of menus referred to as "visual voice".^[1] You can use these menus to playback messages and change various voicemail settings.

- [Checking Messages](#) ^[63]
- [Record and Send a Message](#) ^[64]
- [Change Your Mailbox Greeting](#) ^[64]
- [Select a Voicemail Email Mode](#) ^[65]
- [Change Your Voicemail Code](#) ^[65]
- [Turn Use of Voicemail On/Off](#) ^[66]
- [Transfer to Voicemail](#) ^[66]
- [Send a Call to Voicemail](#) ^[66]

By default voicemail is used to answer calls to you that have rung unanswered for your no answer time. It is also used to answer calls when you have do not disturb enabled.

Default Short Codes

Short codes are numbers that you can dial to enable and disable various features. The following are default short codes that may be available. Your system administrator will confirm any additional short codes that they may have configured for your use.

- **Check Messages: *17**
Access mailboxes to check for messages.
- **Voicemail On: *18**
Allow voicemail to be used to answer calls.
- **Voicemail Off: *19**
Stop voicemail being used to answer calls.
- **Voicemail Ringback On: *48**
Have voicemail ring your phone when you have any new messages. It will call when you use the phone.
- **Voicemail Ringback Off: *49**
Switch off ringback.

Notes







1. The system administrator can change the default operation of the **MESSAGES** button to access either visual voice or a spoken voice prompts. That is a system wide setting that will affect all users. This guide assumes the default operation of using visual voice.

12.1 Message Waiting Indication

Both the  **MESSAGES** button and the message lamp on your phone are used to indicate when you have new messages in your voicemail mailbox. They remain lit until you have played each of the new messages.

The system administrator can also configure it so that you receive new message waiting indication for a hunt group or hunt groups.

12.2 Checking Messages

1. Press the  **MESSAGES** button.
 - Depending on how your system is configured, you may be required to enter your voicemail password and then press **Done**.
2. The visual voice menu is displayed. The numbers shown against the **Listen** option indicate the number of new, old and saved messages in your mailbox.
 - If the system administrator has configured you to receive message waiting indication for any hunt group mailboxes, you can also use the  up and down  arrow keys to highlight hunt group names and the number of messages in those mailboxes.
3. Highlight **Listen** and press **Select**.
4. Use the  up and down  arrow keys to highlight which messages (**New**, **Old** or **Saved**) that you want to listen to and press **Select**. The details of the first message of that type are displayed.
5. You can use the  up and down  arrow keys to scroll through the messages.
6. Use the soft keys to control the playback actions for the currently highlighted message:
 - **Play / Pause**
Start/stop playback of the currently displayed message.
 - **Call**
Call the person who left the message.
 - **Back**
Return to the previous menu.
 - **More**
Switch between the different sets of available soft key functions.
 - **Delete**
Delete the message.
 - **Save**
Mark the message as saved. Saved messages are not normally automatically deleted.^[1]
 - **Copy**
Copy the message to another mailbox. The menu will prompt you to enter the destination number.

Notes

1. Automatic Message Deletion

By default, messages are automatically deleted a set time after being played. The delay depends on the particular voicemail server (24 hours for embedded voicemail, 30 days for Voicemail Pro). For voicemail messages on a Voicemail Pro system, the system administrator can customize the delay and can also apply automatic deletion times to new and saved messages.

12.3 Sending a Message

You can use visual voice to record and send a voicemail message to other users' mailboxes.

1. Press the  **MESSAGES** button.
 - Depending on how your system is configured, you may be required to enter your voicemail password and then press the **Done** soft key.
2. The visual voice menu is displayed.
3. Use the ▲ up and down ▼ arrow keys to scroll to the option **Message** and press **Select**.
4. Press **Record** to start recording a messages.
5. To stop recording, press **Stop**.
6. You can now use the following soft keys:
 - **New**
Record the message again.
 - **Send To**
Enter the number to which you want to send the message and press **Add**. You can add several numbers. When the list of numbers to which the message should be sent is complete press **Send**.
 - **Play**
Listen to the recording.
 - **Cancel**
Abandon the message.

12.4 Mailbox Greeting

While the voicemail system will play a generic greeting to caller, prompting them to leave a message, you can record your own greeting.

1. Press the  **MESSAGES** button.
 - Depending on how your system is configured, you may be required to enter your voicemail password and then press the **Done** soft key.
1. The visual voice menu is displayed.
2. Use the ▲ up and down ▼ arrow keys to scroll to the option **Greeting**. Press **Select**.
3. Use the soft keys to listen to and record your mailbox greeting.
 - **Record**
Record a new greeting. Note that the greeting must be at least 3 seconds long or the voicemail system will discard it.
 - **Listen**
Listen to the current greeting or the new greeting just recorded.
 - **Submit**
Submit the new recording as your mailbox greeting.
 - **More**
Switch between the different sets of available soft key functions.
 - **Delete**
Delete your current mailbox greeting. The voicemail will use its default greeting.
 - **Cancel**
Return to the main visual voice menu.

Personal Greetings

Intuity voicemail allows a number of greeting to be recorded and then used for different call types (internal, external, etc). These greetings are setup and recorded through the mailbox voice prompt interface. They can also be setup and recorded using the one-X Portal for IP Office application.

12.5 Email Mode

Voicemail email is a feature where emails are sent to your email address when your voicemail mailbox receives a new voicemail message. The email can include the voicemail message as an attachment or it can be just an alert.

This option is only available if configured by your system administrator.

Through the visual voice menu you can change the mode of voicemail email operation.

1. Press the  **MESSAGES** button.
 - Depending on how your system is configured, you may be required to enter your voicemail password and then press the **Done** soft key.
2. The visual voice menu is displayed.
3. Use the ▲ up and down ▼ arrow keys to scroll to the option **Email**. This option is only available if your email address has been set in your voicemail settings by the system administrator.
4. The menu displays your current voicemail email mode setting. Press **Change** to scroll through the possible settings:
 - **Off**
Do not send any emails.
 - **Copy**
Send an email with a copy of the new voicemail message attached.
 - **Forward**
Send an email with the new voicemail message attached and delete the message from the voicemail mailbox.
 - **Alert**
Send an email telling you there is a new message but do not attach a copy of the message.
6. When the required setting is displayed, press **Save**. To exit without changing the setting, press **Cancel**.

12.6 Changing Your Voicemail Code

1. Press the  **MESSAGES** button.
 - Depending on how your system is configured, you may be required to enter your voicemail password and then press the **Done** soft key.
2. The visual voice menu is displayed.
3. Use the ▲ up and down ▼ arrow keys to scroll to the option **Password**. Press **Select**.
4. Enter your current password and press **Save**.
5. Enter the new password that you want to use.
 - The new password must be at least 4 digits long.
 - A series of numbers (for example 1234) or repeated numbers are not allowed.
6. When completed press **Save**.

12.7 Voicemail On/Off

You can control whether the telephone system uses voicemail to answer your unanswered calls. This does not switch off your mailbox which you can still access to play existing messages and use other functions.

1. Press the  **MESSAGES** button.
 - Depending on how your system is configured, you may be required to enter your voicemail password and then press the **Done** soft key.
2. The visual voice menu is displayed.
3. Use the ▲ up and down ▼ arrow keys to highlight **Voicemail**.
4. Press the **Change** to switch between **On** or **Off**.
5. Press **Save** to save the change.

12.8 Transfer to Voicemail

When set to visual voice mode, the  key can be used to transfer your current call to the voicemail mailbox of another user or group.

1. With the call connected, press the  key. You are still connected to the call and can continue talking.
2. Dial the extension number of the user or group to which you want to transfer the call.
3. When the number matches a user or group, their name is displayed.
 - To transfer the call to the user or group's mailbox, press **Select**. The caller will hear a few seconds of ringing and then the mailbox greeting.
 - To exit the transfer menu, press **Cancel**.

12.9 Send a Call to Voicemail

You can transfer a call targeted at you directly to your voicemail mailbox.

1. If the call is not the currently highlighted call on the display, use the ▲ up and down ▼ arrow keys to highlight it.
2. Press the **To VM** soft key. The call is redirected to your mailbox.

12.10 Visual Voice

This menu option provides a route into visual voice if the **MESSAGES** key has not been setup to do that.

1. Press the **Features** soft key if shown. To do this during a call, press the  **PHONE** key and then press the **Features** soft key.
2. Use the ▲ up and down ▼ arrow keys to highlight **Visual Voice**. Press **Select**.
3. Use the ▲ up and down ▼ arrow keys to highlight **Visual Voice**. Press **Select**.
 - Depending on how your system is configured, you may be required to enter your voicemail password and then press the **Done** soft key.
4. You will now see the visual voice menu.

Chapter 13.

Logging In/Out

13. Logging In/Out

You may always use the same phone in the same location. However the telephone system provides a number of features that allow you to use any phone on the system to make and receive your calls.

- **Log In** ⁶⁹
You can login at any phone that you want to use. All your calls are then directed to that phone and your user settings are applied to calls made and received. If it is a phone that stores your contacts and call history on the system, your contacts and call log are displayed by the phone.
 - Any existing user of the phone is logged out while you are logged in.
 - If you were logged in on another phone, you are logged out from that phone.
 - If your phone system is in a [Small Community Network](#) ¹⁴³ of phone systems, it may be possible to login at extensions located on other phone systems in the network. Your system administrator will advise you if you can remote hot desk and what features will still be available to you when you do.
- **Log Out** ⁷⁰
When you log out from a phone (or are logged out by another user logging in), the telephone system may apply several actions:
 - If you have a normal default extension and no one else is logged in there, you return to being logged in on that phone.
 - If you remain logged out, you are treated the same as being on do not disturb except that all calls to you go to voicemail if available.
 - If you have a mobile twinned number, the system administrator can configure the system so that calls are still presented to your mobile twin while you are logged out.
- **Lock/Unlock** ⁷⁰
Separately from logging in and out, you can lock your phone settings. While locked, the phone can still be used to answer your calls and can be used to make internal and emergency calls. However it cannot be used to make external calls and your user settings cannot be accessed through the phones menus.
 - You can set your phone to automatically lock itself after a period of inactivity.
- **Default Extension**
Each extension can be configured with a default user. If you are logged off from an extension, if you have a default extension the system will automatically log you in at your default extension if it is not in use by another user.
- **Login Idle Period**
Your system administrator can configure a timeout which will automatically log you out if you do not use the phone in that time to make or answer a call.

Default Short Codes

Short codes are numbers that you can dial to enable and disable various features. The following are default short codes that may be available. Your system administrator will confirm any additional short codes that they may have configured for your use.

- **Login: *35*N*P#**
Login to a phone using your extension number (**N**) and login code (**P**).
- **Log Out: *36**
Log yourself out from the phone where you are currently logged in.

13.1 Logging In

When you login to a phone, you take control of that phone. Incoming calls for you are redirected to it phone and your user information and settings are available. Any existing user on the phone is logged off when you login.

The method for logging in depends on the current state of the phone:

- **Phone In Use** 

If the phone is already in use you can still login. The existing user will be logged out.
- **Logged Out** 

If the phone has no current user, the basic menu with just the login option is displayed.
- **Unregistered Phone** 

If the phone is not registered with the phone system, the **Enter Extension** menu is displayed.

13.1.1 Logging In on a Phone Already in Use

You can login at a phone that is already in use by another user. The existing user is logged out.

1. If the phone is already in use:
 - Press the **Features** soft key.
 - Use the ▲ up and down ▼ arrow keys to highlight **Phone User**. Press **Select**.
 - Use the ▲ up and down ▼ arrow keys to highlight **Login....** Press **Select**.
2. The login menu is displayed.
3. Enter your extension number and press **Next** .
4. Enter your security PIN (login code).
5. Press **Done**.

13.1.2 Logging In on a Not Logged In Phone

This method is used to login at an extension where the previous user has [logged out](#)  and the phone has no current user. You can recognize a phone in this state by NOT LOGGED IN on the display.

1. Press **Select**.
2. The login menu is displayed.
3. Enter your extension number and press **Next** .
4. Enter your security PIN (login code).
5. Press **Done**.

13.1.3 Logging In on an Unregistered Phone

This method is used to login at an unregistered phone. You can recognize an unregistered phone by **Enter Extension** on the display. This method is not supported for hot desking on the system, you can only login using the original base extension number with which the phone was originally installed.

1. Enter your extension number. As you enter it, you can use the **Bksp** and **Clear** soft keys to make corrections.
2. When your number is displayed, press the **OK** soft key.
3. Enter your security PIN (login code). As you enter it, you can use the **Bksp** and **Clear** soft keys to make corrections.
4. When you have entered your security PIN, press **Done**. If the details are correct, you user details will be loaded into the phone.

13.2 Logout

1. Press the **Features** soft key if shown. To do this during a call, press the  **PHONE** key and then press the **Features** soft key.
2. Use the ▲ up and down ▼ arrow keys to highlight **Phone User**. Press **Select**.
3. Use the ▲ up and down ▼ arrow keys to highlight **Logout**. Press **Select**.
4. You will be logged out of the phone. The follow action will depend on several factors:
 - If the phone does not have a default user, or the default user is currently logged on elsewhere, the no user display is shown:
 - If the phone has a default user and they are not current logged on elsewhere, they are automatically logged back in.

13.3 Lock

Rather than logging out, you can lock your phone. You can either lock your phone manually using the steps below or have it [automatically locked](#) ^[71] after a period of phone inactivity.

To use this feature you need to [set a security PIN](#) ^[71].

When your phone is locked:

- It can only be used to make internal and emergency calls.
- None of the menus for your user settings can be accessed.
- To [unlock the phone](#) ^[70] requires your login code if you have [configured a login code](#) ^[71].

1. Press the **Features** soft key if shown. To do this during a call, press the  **PHONE** key and then press the **Features** soft key.
2. Use the ▲ up and down ▼ arrow keys to highlight **Phone User**. Press **Select**.
3. Use the ▲ up and down ▼ arrow keys to highlight **Lock**. Press the **Select**.
4. The phone is now locked as indicated by the display.

13.4 Unlock

The message **PHONE LOCKED** indicates that the phone has been [locked](#) ^[70]. While locked, the phone can only be used to make internal calls to other extensions and none of the phone and user menus can be accessed.

1. Press the **Unlock** soft key.
2. Enter your security PIN (login code).
3. Press the **Done** soft key.

13.5 Auto Lock

Rather than logging out, you can lock your phone. You can either [lock your phone manually](#)^[70] using the steps below or have it automatically locked after a period of phone inactivity. To use this feature you need a [security PIN](#)^[71] (login code) set.

When your phone is locked:

- It can only be used to make internal and emergency calls.
- None of the menus for your user settings can be accessed.
- To [unlock the phone](#)^[70] requires your login code if you have [configured a login code](#)^[71].

1. Press the **Features** soft key if shown. To do this during a call, press the  **PHONE** key and then press the **Features** soft key.
2. Use the ▲ up and down ▼ arrow keys to highlight **Phone User**. Press **Select**.
3. Use the ▲ up and down ▼ arrow keys to highlight **Phone Screen Settings**. Press **Select**.
4. Use the ▲ up and down ▼ arrow keys to highlight **Auto Lock (minutes)**.
5. Press the **Change** soft key to change the setting or use the ◀ left or right ▶ arrow keys.
 - **Disabled**
Do not use the inactivity timer.
 - **1 / 5 / 30 / 60**
Lock the phone after the indicated number of minutes.
6. Press the **Save** soft key.

13.6 Changing Your Security PIN

You can change your own security PIN (login code). If set, this PIN is used for logging in at other phones, [locking your phone](#)^[70] and [accessing system administration features](#)^[12b]. This is not your [voicemail code](#)^[6b] used for voicemail access.

1. Press the **Features** soft key if shown. To do this during a call, press the  **PHONE** key and then press the **Features** soft key.
2. Use the ▲ up and down ▼ arrow keys to highlight **Phone User**. Press **Select**.
3. Use the ▲ up and down ▼ arrow keys to highlight **Set Security PIN**. Press **Select**.
4. Enter your current security PIN if you already have one and press **Done**.
5. Enter your new password.
6. Press **Save**.
7. The security PIN changed message will appear for a few moments.

Chapter 14.

Redirecting Calls

14. Redirecting Calls

This section looks at the different ways that you can redirect your calls to another phone.

- **Follow Me** ^[75]
Temporarily redirect all your calls to another phone that you will be sharing with that phone's normal user. This function can be used in two ways:
 - **Follow Me To**
Set the follow me destination from your own phone.
 - **Follow Me Here**
Set the follow me destination from the phone that you want to use.
- **Forward** ^[77]
Forward calls to an internal or external number.
 - **Forward on Busy**
Forward calls when you have reached the limit of the number of calls that the phone can present to you.
 - **Forward on No Answer**
Forward calls if they have rung unanswered at your phone.
 - **Forward Unconditional**
Immediately forward calls. Forwarding to voicemail can be selected as an option.
- **Do Not Disturb** ^[82]
Redirect all calls to voicemail if available or otherwise to busy tone.
 - Do not disturb exception numbers can be used to allow calls from specific numbers to ignore do not disturb.
- **Twinning** ^[84]
Twinning is a process whereby you can have your calls ring at two different phones. You can answer calls at either phone. There are two variants of twinning, internal twinning which uses two internal extensions and mobile twinning which twins your internal extension with an external number.

Method		Calls Redirected			Destination		
		Internal	External	Group	Internal	External	Voicemail
Follow Me	Follow Me To	✓	✓	✓	✓	✗	✗
	Follow Me Here	✓	✓	✓	✓	✗	✗
Forward	Forward on Busy	✓	✓	✗	✓	✓	✗
	Forward on No Answer	✓	✓	✗	✓	✓	✗
	Forward Unconditional	✓	✓	✓	✓	✓	✓
Do Not Disturb		✓	✓	✗	✗	✗	✓
Twinning		✓	✓	✓	✓	✓	✓

14.1 Follow Me

Follow me to is used to redirect your calls to another extension where you will be working.

The calls are presented with your user name so that they can be distinguished from calls for the extensions normal user. This allows you to share another person's phone without logging them off their phone.

The calls are still subject to all your user settings as if they were ringing at your phone.

All calls are redirected.

Follow Me To

Follow me to is the function used to enable follow me from your own phone.

Follow Me Here

Follow here the function used to enable follow me at the extension to which you want your calls redirected.

Default Short Codes

Short codes are numbers that you can dial to enable and disable various features. The following are default short codes that may be available. Your system administrator will confirm any additional short codes that they may have configured for your use.

- **Follow Me Here: *12*N#**
Dialed at the extension to which you want you calls redirected. Use your own extension number (**N**) when dialing the short code.
- **Follow Me Here Cancel: *13*N#**
Dialed at the extension to which you want your calls were redirected. Use your own extension number (**N**) when dialing the short code.
- **Follow Me To: *14*N#**
Dialed at your phone. Dial the extension number (**N**) to which you want your calls redirected. You can dial just ***14#** to cancel follow me.
- **Cancel All Forwarding: *00**
Switch off any forwarding. Includes forward unconditional, forward on busy, forward on no answer, follow me and do not disturb.
- **!** The system administrator is able to configure whether you can access the **Forward** and **Follow Me** menu and status options.

14.1.1 Follow Me To (Features Menu)

Using the user menu you can set and clear follow me to settings.

1. Press the **Features** soft key if shown. To do this during a call, press the  **PHONE** key and then press the **Features** soft key.
 2. Use the ▲ up and down ▼ arrow keys to highlight **Forward**. Press **Select**.
 3. Use the ▲ up and down ▼ arrow keys to highlight **Follow me To**. Press **Select**.
 4. Dial the number of another user. When it matches a user their name is displayed. Alternatively use the **Dir** soft key to [select a user from the directory](#)^[52].
 - **Save**
Save the selected number as your follow me to destination. All calls to your extension number will be redirected to that destination.
 - **Clear**
Clear the currently selected or set number.
 - **Back**
Go back to the previous menu.
- **!** The system administrator is able to configure whether you can access the **Forward** and **Follow Me** menu and status options.

14.1.2 Follow Me (Status Menu)

If you have set a follow me destination for calls to your phone, you can clear or change the setting through the **Status** menu.

1. Press the **Status** soft key if shown.
 - To access the status menu during a call, press the  **PHONE** key and then press the **Status** soft key if shown.
 2. Use the ▲ up and down ▼ arrow keys to highlight **Follow Me To**.
 - To clear the follow me to setting, press the **Clear** soft key.
 - To change the destination of the setting, press the **Details** soft key.
- **!** The system administrator is able to configure whether you can access the **Forward** and **Follow Me** menu and status options.

14.1.3 Follow Me Here (Features Menu)

You may be able to change follow me here using the Features menu.

1. Press the **Features** soft key if shown. To do this during a call, press the  **PHONE** key and then press the **Features** soft key.
 2. Use the ▲ up and down ▼ arrow keys to highlight **Forward**. Press **Select**.
 3. Use the ▲ up and down ▼ arrow keys to highlight **Follow Me Here**. Press **Select**.
 - Use the menu to add or remove users.
 - Use the ▲ up and down ▼ arrow keys to scroll through the names.
 - To remove a user, press the **Clear** soft key.
 - To add a user, press the **Add** soft key.
 - Dial the number of another user. When it matches a user their name is displayed. Alternatively, use the **Dir** soft key to [select a user from the directory](#)^[52].
 - Press the **Save** soft key to set the follow me here.
- **!** The system administrator is able to configure whether you can access the **Forward** and **Follow Me** menu and status options.

14.2 Forwarding Calls

Forwarding is used to redirect calls to another extension or an external number.

Forward Unconditional

Forward unconditional can be used to immediately redirect your calls.

- By default this function is only applied to incoming external calls to you. However, if required internal calls and or hunt group calls can also be selected.
- When enabled, all calls matching the settings are forwarded to the number set as the forward unconditional destination. That number can be internal or external.
- You can still use the phone to make outgoing calls. When you go off-hook you will hear broken dial tone.
- The forward on busy and forward on no answer options use the same forwarding destination number. If no number is set, they use the same destination as set for forward unconditional.
- If you have [voicemail enabled](#) , the telephone system will attempt to redirect forwarded calls to voicemail if they are still unanswered after having rung for your no answer time (default 15 seconds). This is not always possible for calls that have been forwarded to an external number.
- **D = Diverting (Forwarding) Calls**
A **D** is shown after your extension name on the phone's idle display when you have forward unconditional enabled.

Forward on Busy

Forward on busy redirects your calls when your phone is not able to present you with any more alerting calls.

- By default this function is only applied to incoming external calls to you. However, if required internal calls can also be selected.
- When enabled, all calls matching the settings are forwarded to the number set as the forward on busy/no answer destination. That number can be internal or external.
- Busy is defined as having no available call appearance buttons on which further calls can be presented.
- Hunt group calls are not presented when you are busy and so are not forwarded by this setting.
- The forward on busy and forward on no answer options use the same forwarding destination number. If no number is set, they use the same destination as set for forward unconditional.
- If you have [voicemail enabled](#) , the telephone system will attempt to redirect forwarded calls to voicemail if they are still unanswered after having rung for your no answer time (default 15 seconds). This is not always possible for calls that have been forwarded to an external number.

Forward on No Answer

Forward on no answer redirects calls that have alerted your phone but have not been answered for some reason.

- By default this function is only applied to incoming external calls to you. However if required internal calls can also be selected.
- When enabled, all calls matching the settings are forwarded to the number set as the forward on busy/no answer destination. That number can be internal or external.
- No answer is defined as having been presented to your phone for your no answer time (default 15 seconds).
- Hunt group calls are not forwarded.
- The forward on busy and forward on no answer options use the same forwarding destination number. If no number is set, they use the same destination as set for forward unconditional.
- If you have [voicemail enabled](#) , the telephone system will attempt to redirect forwarded calls to voicemail if they are still unanswered after having rung for your no answer time (default 15 seconds). This is not always possible for calls that have been forwarded to an external number.

Default Short Codes

Short codes are numbers that you can dial to enable and disable various features. The following are default short codes that may be available. Your system administrator will confirm any additional short codes that they may have configured for your use.

- **Cancel All Forwarding: *00**
Switch off any forwarding. Includes forward unconditional, forward on busy, forward on no answer, follow me and do not disturb.
- **Set the Forward Unconditional Destination: *07*N#**
Set the destination number (**N**) for forward unconditional when it is switched on.
 - **Switch Forward Unconditional On: *01**
Switch on forward unconditional. A destination must have been set.
 - **Switch Forward Unconditional Off: *02**
 - **Include Hunt Group Calls in Forward Unconditional: *50**
 - **Exclude Hunt Group Calls from Forward Unconditional: *51**
- **Set the Forward On Busy/No Answer Destination: *57*N#**
Set the destination number (**N**) for forward on busy and forward on no answer. If no number has been set, those functions will use the forward unconditional number if set.
 - **Switch Forward On Busy On: *03**
 - **Switch Forward On Busy Off: *04**
 - **Switch Forward on No Answer On: *05**
 - **Switch Forward on No Answer Off: *06**
- **!** The system administrator is able to configure whether you can access the **Forward** and **Follow Me** menu and status options.

14.2.1 Forward Unconditional (Status Menu)

You can clear or change your forward unconditional settings through the **Status** menu.

1. Press the **Status** soft key if shown.
 - To access the status menu during a call, press the  **PHONE** key and then press the **Status** soft key if shown.
2. Use the ▲ up and down ▼ arrow keys to highlight **Fwd Uncon.**
 - To switch off forward unconditional, press the **Off** soft key.
 - To change the forwarding settings, press the **Details** soft key.
 - Use the ▲ up and down ▼ arrow keys to scroll through the editing options.
 - Use the ◀ left and right ▶ arrow keys to switch the forwarding on or off.
 - Use the ◀ left and right ▶ arrow keys to select which calls should be forwarded. The options are **External Only**, **External and Group**, **Non Group Calls** and **All Calls**.
 - Select edit to change the number to which calls are forwarded.
- ! The system administrator is able to configure whether you can access the **Forward** and **Follow Me** menu and status options.

14.2.2 Forward Unconditional (Features Menu)

You may be able to change your forward unconditional settings using the Features menu.

1. Press the **Features** soft key if shown. To do this during a call, press the  **PHONE** key and then press the **Features** soft key.
2. Use the ▲ up and down ▼ arrow keys to highlight **Forward**. Press **Select**.
3. Use the ▲ up and down ▼ arrow keys to highlight **Forward Unconditional**. Press **Select**.
4. The screen displayed will display your current forward unconditional settings.
 - **To Switch Forward Unconditional On/Off**
Highlight **Fwd Unconditional**. Press **On** or **Off** to change the current setting. If no destination is currently set when you switch forward unconditional on the display will jump to the destination field.
 - **To Select Which Calls as Forwarded**
Highlight Call Type. Press Change to see the different options. When the required option is displayed press **Save**. The options are **External Only**, **External and Group**, **Non Group Calls** and **All Calls**.
 - **To Set the Forward Destination**
Highlight **Destination**. Either press **Edit** and enter the number required or press **To VM** for a forward to voicemail.
 - If you select **Voicemail** as the destination, you will need to switch forward unconditional off in order to cancel it and enter a new destination.
- ! The system administrator is able to configure whether you can access the **Forward** and **Follow Me** menu and status options.

14.2.3 Forward On Busy/No Answer (Features Menu)

You may be able to use the Features menu to switch forward on no answer, forward on busy on or off.

1. Press the **Features** soft key if shown. To do this during a call, press the  **PHONE** key and then press the **Features** soft key.
2. Use the ▲ up and down ▼ arrow keys to highlight **Forward**. Press **Select**.
3. Use the ▲ up and down ▼ arrow keys to highlight **Fwd Busy/No Answer**. Press **Select**.
 - Use the ▲ up and down ▼ arrow keys to scroll through the menu options.
 - To switch forward on busy on or off, highlight **Fwd Busy** and press **On** or **Off**.
 - To switch forward on no answer on or off, highlight **Fwd No Answer** and press **On** or **Off**.
 - To select which calls are forwarded highlight **Call Type**. Press **Change** to change the option between **All Calls** or **External Calls Only**.
 - To change the destination highlight **Destination** and press **Edit**. Enter the number and press **Select**.
 - Press **Save** to save any changes.
- **!** The system administrator is able to configure whether you can access the **Forward** and **Follow Me** menu and status options.

14.2.4 Forward On No Answer (Status Menu)

If your phone is set to [forward on no answer](#)^[14], you can clear or change the forward settings through the **Status** menu.

1. Press the **Status** soft key if shown.
 - To access the status menu during a call, press the  **PHONE** key and then press the **Status** soft key if shown.
2. Use the ▲ up and down ▼ arrow keys to highlight **Fwd No Answer**.
3. To switch the forward off press **Off**.
4. To change the forward setting press **Details**.
 - Use the ▲ up and down ▼ arrow keys to scroll through the menu options.
 - To switch forward on busy on or off, highlight **Fwd Busy** and press **On** or **Off**.
 - To switch forward on no answer on or off, highlight **Fwd No Answer** and press **On** or **Off**.
 - To select which calls are forwarded highlight **Call Type**. Press **Change** to change the option between **All Calls** or **External Calls Only**.
 - To change the destination highlight **Destination** and press **Edit**. Enter the number and press **Select**.
 - Press **Save** to save any changes.
- **!** The system administrator is able to configure whether you can access the **Forward** and **Follow Me** menu and status options.

14.2.5 Forward On Busy (Status Menu)

If your phone is set to forward on busy, you can clear or change the forward settings through the **Status** menu.

1. Press the **Status** soft key if shown.

- To access the status menu during a call, press the  **PHONE** key and then press the **Status** soft key if shown.

2. Use the ▲ up and down ▼ arrow keys to highlight **Fwd Busy**.

3. To switch the forward off press **Off**.

4. To change the forward setting press **Details**.

- Use the ▲ up and down ▼ arrow keys to scroll through the menu options.
 - To switch forward on busy on or off, highlight **Fwd Busy** and press **On** or **Off**.
 - To switch forward on no answer on or off, highlight **Fwd No Answer** and press **On** or **Off**.
 - To select which calls are forwarded highlight **Call Type**. Press **Change** to change the option between **All Calls** or **External Calls Only**.
 - To change the destination highlight **Destination** and press **Edit**. Enter the number and press **Select**.
- Press **Save** to save any changes.
- **!** The system administrator is able to configure whether you can access the **Forward** and **Follow Me** menu and status options.

14.3 Do Not Disturb

- When you are in 'do not disturb', your callers are redirected to voicemail if available or otherwise hear busy tone.
- The only people who can call you are those calling from numbers in your do not disturb exceptions list. Forwarding can still be applied to these calls.
- Calls to any hunt group of which you are a member are not presented to you (unless you are the last available member of the group).
- Enabling do not disturb will not affect any calls already being presented to your phone.
- You can still use the phone to make outgoing calls. When you go off-hook you will hear broken dial tone.
- **N = No Calls (Do Not Disturb)**
An **N** is shown after your extension name on the phone's idle display when you have do not disturb enabled.



Default Short Codes

Short codes are numbers that you can dial to enable and disable various features. The following are default short codes that may be available. Your system administrator will confirm any additional short codes that they may have configured for your use.

- **Switch Do Not Disturb On: *08**
Set your phone to do not disturb.
- **Switch Do Not Disturb Off: *09**
Switch off do not disturb.
- **Add a Do Not Disturb Exception Number: *10*N#**
Add a number (**N**) to your list of do not disturb exceptions.
- **Delete a Do Not Disturb Exception Number: *11*N#**
Remove a number (**N**) from your list of do not disturb exceptions.
- **Cancel All Forwarding: *00**
Switch off any forwarding. Includes forward unconditional, forward on busy, forward on no answer, follow me and do not disturb.

14.3.1 DND On/Off (Features Menu)

You can use the Features menu to switch do not disturb on or off. Enabling DND will not affect any calls already being presented to your phone. Hunt group calls will also still be presented if you are the only available member of the group.

1. Press the **Features** soft key if shown. To do this during a call, press the  **PHONE** key and then press the **Features** soft key.
2. Use the  up and down  arrow keys to highlight **Call Settings**. Press **Select**.
3. Press **Change** to change the setting.
4. Press **Save** to save the setting.





14.3.2 DND Off (Status Menu)

You can use the **Status** menu to switch off do not disturb.

1. Press the **Status** soft key if shown.
 - To access the status menu during a call, press the  **PHONE** key and then press the **Status** soft key if shown.
2. If necessary use the  up and down  arrow keys to highlight **Do Not Disturb**.
 - To clear the do not disturb setting, press the **Off** soft key.

14.3.3 Do Not Disturb Exceptions

These numbers are used to indicate callers who you want to be allowed to call you as normal even when you have do not disturb on. This does not include group calls which are not presented when you are in do not disturb.

1. Press the **Features** soft key if shown. To do this during a call, press the  **PHONE** key and then press the **Features** soft key.
2. Use the  up and down  arrow keys to highlight **Call Settings**. Press **Select**.
4. Use the  up and down  arrow keys to highlight **DND Exceptions**. Press **Select**.
5. To add a number highlight **Add Another**. Dial the number and press **Add**.
6. To remove an existing number highlight it and press **Remove**.
7. Press **Done** when completed.

14.4 Twinning

Twining is a process whereby your calls ring on two phones. Twining is only available if configured by the system administrator.

There are two methods of twinning supported, [internal twinning](#)^[142] and [mobile twinning](#)^[142].

Internal Twinning

This method of twinning twins your normal phone with another internal phone. Your incoming calls will ring on both phones. You can also make your calls from either extension.

A typical example for internal twinning would be a user who uses both a normal desk phone and also needs a mobile phone while moving around the building.

Your settings are applied to both phones. Similarly message waiting indication and voicemail access from either phone will be to your mailbox.

If both phones are phones that store your contacts and call history on the system, the contacts and call history on each will be the same.

- **T = Twinned**

A **T** is shown after your extension name on the phone's idle display if it is internally twinned with your phone. Calls to you will alert on both phones and can be answered by you at either phone.

Mobile Twinning

Mobile twinning is [twinning](#)^[143] where your calls ring at both your phone and at another number which can include an external number. If you have been configured as a mobile twinning user, you can switch use of mobile twinning on or off through the phone's menus and also change the number to which you are twinned.

Using the phone menus you can switch use of mobile twinning on/off and change the destination number for twinned calls.

14.4.1 Mobile Twinning Control

This menu option is only available if you have been configured by the system administrator to be able to use mobile twinning.

- The addition of a button set to the **Twining** function is recommended, contact your system administrator. Such a button allows you to transfer a call to your twinning destination, retrieve a call from the twinning destination and access the menu options below to set the twinning destination number and switch twinning on/off.

1. Press the **Features** soft key if shown. To do this during a call, press the  **PHONE** key and then press the **Features** soft key.
2. Use the ▲ up and down ▼ arrow keys to highlight **Forward**. Press **Select**.
3. Use the ▲ up and down ▼ arrow keys to highlight **Mobile Twinning**. Press **Select**.
4. If no twinning number has been set, the menu will prompt you to enter a number.
5. When a number has been entered, you can access the **Enable** and **Disable** soft keys to turn use of mobile twinning on or off. The **Clear** soft key removes the existing twinning number in order to allow entry of a new number.

Chapter 15.

Groups

15. Groups

Your system administrator can include you as a member of a group along with other users. Each group has its own extension number which can be used as the destination for call.

When a call is presented to a group, it is presented to the available group members, either one at a time or all at the same time, until answered by one of the members.

How long a group call will ring at each group member before being presented to the next member is controlled by the group's own settings. Hunt groups also use voicemail and have their own settings for when an unanswered call should go to the group's mailbox. For group calls, the hunt group's voicemail settings are used rather than your settings.

The system administrator can enable a number of hunt group menu options on your phone. Each option is enabled for a selected hunt group or hunt groups of which you are a member:

- [Enable/Disable Your Group Membership](#) ⁸⁷
When your membership of a hunt group is disabled, you no longer receive hunt group calls for that group. You are still a member of the group and can re-enable your membership.
- [Change the Hunt Group Service Status](#) ⁸⁸
Each hunt group can be in service, in night service or out of service. When in night service or out of service, the groups calls are redirected to an alternate group or to voicemail.
- [Change the Hunt Group Fallback Destination](#) ⁸⁸
These menus allow you to change the alternate groups used for the groups calls when it is in night service or out of service status.

Default Short Codes

Short codes are numbers that you can dial to enable and disable various features. The following are default short codes that may be available. Your system administrator will confirm any additional short codes that they may have configured for your use.

- **Night Service Status On: *20*N#**
Set a hunt group into night service status by entering its extension number (**N**).
- **Night Service Status Off: *21*N#**
Take a hunt group out of night service status by entering its extension number (**N**).

15.1 Group Membership

Only the system administrator can change the groups of which you are a member. However, you can be provided with options to enable or disable your group membership. While your membership of a group is disabled, you will not receive any group calls for that group.

15.1.1 Group Membership On/Off (Status Menu)

If the system administrator has allowed you, you can enable/disable your membership of a group through the **Status** menu. When your membership of a group is disabled you do not receive group calls for that group.

1. Press the **Status** soft key if shown.
 - To access the status menu during a call, press the  **PHONE** key and then press the **Status** soft key if shown.
 2. Use the ▲ up and down ▼ arrow keys to highlight the hunt group name and your current membership status (**Enabled** or **Disabled**).
 3. Press the **Enable** or **Disable** soft key to change the status of your membership of that group.
 4. Press **Exit**.
- **!** The system administrator is able to configure if you can access the **Membership**, **State** and **Fallback** options of a group. If you are not configured for any groups then the **Group** menu is not shown.

15.1.2 Group Membership On/Off (Features Menu)

You may be able to enable or disable your group membership for some of the groups to which you belong.

1. Press the **Features** soft key if shown. To do this during a call, press the  **PHONE** key and then press the **Features** soft key.
 2. Use the ▲ up and down ▼ arrow keys to highlight **Group**. Press **Select**.
 3. Use the ▲ up and down ▼ arrow keys to highlight **Membership**. Press **Select**.
 4. Use the ▲ up and down ▼ arrow keys to scroll through the list of hunt groups you can configure.
 5. To change your membership of the highlighted group press **Change**.
 - To change your membership of all groups press **More** and then press either **All Ena** or **All Dis**.
- **!** The system administrator is able to configure if you can access the **Membership**, **State** and **Fallback** options of a group. If you are not configured for any groups then the **Group** menu is not shown.

15.2 Group Service Status and Fallback

- **Group Service Status**

A hunt group can be in one of the following service modes:

- **In Service**

The group operates a normal, distributing calls to available members of the group.

- **Night Service**

The group is in night service mode. Calls are redirected to its night service fallback group [if set](#)^[90], otherwise to voicemail if available.

- A hunt group can also be put into and out of night service automatically by the telephone system using a time profile. If that is the case, the night service state cannot be overridden using manual controls.

- **Out of Service**

The group is out of service. Calls are redirected to its out of service fallback group [if set](#)^[90], otherwise to voicemail if available.

- **Fallback Group**

For the night service and out of service states, the hunt group can be configured with a fallback destination to which its group calls are redirected. This destination is another hunt group. If no fallback destination is set, the group's voicemail is used if available. Separate night service and out of service fallback destinations can be set for the group.

Display Icon

- **O = Out of Service**

An **O** is shown on your phone's display when any of the groups of which you are enabled as a member is set to night service mode. In that mode calls to that group are diverted to its fallback if set or otherwise to voicemail if available.

- **!** The system administrator is able to configure if you can access the **Membership**, **State** and **Fallback** options of a group. If you are not configured for any groups then the **Group** menu is not shown.

15.2.1 Changing the Group Service Status (Features Menu)

Using the Features menu you may be able to change the service status of some groups to which you belong.

1. Press the **Features** soft key if shown. To do this during a call, press the  **PHONE** key and then press the **Features** soft key.
2. Use the ▲ up and down ▼ arrow keys to highlight **Group**. Press **Select**.
3. Use the ▲ up and down ▼ arrow keys to highlight **State**. Press **Select**.
4. Use the ▲ up and down ▼ arrow keys to scroll through the list of hunt groups you can configure. Use **All Groups** for all the groups you can configure. The soft keys available will vary depending on whether a particular or all groups is selected and the current state of the selection.
 - **All Groups**
 - **In Service**
The groups operates a normal, distributing calls to available members of the group.
 - **Night Service**
The group is in night service mode. Calls are redirected to its night service fallback group [if set](#)^[90], otherwise to voicemail if available.
 - A hunt group can also be put into and out of night service automatically by the telephone system using a time profile. If that is the case, the night service state cannot be overridden using manual controls.
 - **Out of Service**
The group is out of service. Calls are redirected to it out of service fallback group [if set](#)^[90], otherwise to voicemail if available.
 - **Particular Group**
 - **Change**
Change the status of the selected group.
 - **Save**
Exit the menus.
- **!** The system administrator is able to configure if you can access the **Membership**, **State** and **Fallback** options of a group. If you are not configured for any groups then the **Group** menu is not shown.

15.2.2 Changing the Group Service Status (Status Menu)

If the system administrator has allowed you, you can change the service state of a group through the **Status** menu.

1. Press the **Status** soft key if shown.
 - To access the status menu during a call, press the  **PHONE** key and then press the **Status** soft key if shown.
2. Use the ▲ up and down ▼ arrow keys to highlight the hunt group name and your current membership status.
3. Select the required state using the soft keys:
 - **In Service**
The groups operates a normal, distributing calls to available members of the group.
 - **Night Service**
The group is in night service mode. Calls are redirected to its night service fallback group [if set](#)^[90], otherwise to voicemail if available.
 - A hunt group can also be put into and out of night service automatically by the telephone system using a time profile. If that is the case, the night service state cannot be overridden using manual controls.
 - **Out of Service**
The group is out of service. Calls are redirected to it out of service fallback group [if set](#)^[90], otherwise to voicemail if available.
- **!** The system administrator is able to configure if you can access the **Membership**, **State** and **Fallback** options of a group. If you are not configured for any groups then the **Group** menu is not shown.

15.2.3 Changing the Group Fallback

You may be able to use the Features menu to change the fallback group destination for some of the hunt groups of which you are a member.

1. Press the **Features** soft key if shown. To do this during a call, press the  **PHONE** key and then press the **Features** soft key.
 2. Use the ▲ up and down ▼ arrow keys to highlight **Group**. Press **Select**.
 3. Use the ▲ up and down ▼ arrow keys to highlight **Fallback**. Press **Select**.
 - Use the ◀ left and right ▶ arrow keys to switch between altering night service (**NS**) or out of service (**OOS**) settings.
 - Use the ▲ up and down ▼ arrow keys to scroll through the list of hunt groups you can configure in the current mode.
 - To change the setting of the currently highlighted hunt group press **Edit**.
 - To change the setting of all the hunt groups press **More** and then press **Edit All**.
- **!** The system administrator is able to configure if you can access the **Membership**, **State** and **Fallback** options of a group. If you are not configured for any groups then the **Group** menu is not shown.

Chapter 16.

Button Features

16. Button Features

Functions can be assigned to the phone's call appearance/feature buttons by your system administrator or by yourself using [self-administration](#)^[92]. Note that you cannot replace call appearances features assigned to buttons by your system maintainer but you can replace other features. However also note there are features that the system maintainer can assign that are not available to you to assign. This guide just includes features that you can assign yourself if required.

Button Actions

There are a wide range of actions that can be assigned to the buttons. This guide only includes details of those that you can assign to a button using the self-administer menu. Functions that can only be assigned by your system administrator will be explained by the system administrator.

- Abbreviated Dial*
- Absence Text*
- Account Code
- Auto Callback
- Break Out
- Call Forward All*
- Call Park
- Call Park To Other
- Call Pickup*
- Call Pickup Any *
- Drop Call
- Flash Hook
- Group BLF
- HG Night Service
- Internal Auto Answer
- Page*
- Ringer Off
- Self Administer*
- Send All Calls*
- Suppress Digits
- User BLF

Some actions are not supported on all phones. However they may be set for users who hot desk between different types of phone. On 9621 and 9641 phones, those functions marked by a * can be assigned to a icon button on the phone's home screen.

Button Lamps

The use of the button lamp or icon will depend on the action associated with the button.

Fixed Buttons

On all the phones, the programmable button features appear below the call appearance buttons. The screen can be scrolled to display further buttons. For the 9650 phones, some of the programmable buttons remain permanently visible even if the display is scroll. On the 9641 phone, you can select to have some of the programmable buttons [permanently visible](#)^[117].

16.1 Editing Your Programmable Buttons

This process is used to select and apply a function to a feature key. It can be used to replace or delete existing functions.

1. Press the **Features** soft key if shown. To do this during a call, press the  **PHONE** key and then press the **Features** soft key.
2. Use the ▲ up and down ▼ arrow keys to highlight **Phone User**. Press **Select**.
3. Use the ▲ up and down ▼ keys to highlight **Self-Administer**. Press **Select**.
4. Enter your security PIN and press **Done**.
5. On 9621 and 941 phones, select **Button Features**. Use the ▲ up and down ▼ keys to scroll through the list of current functions assigned to each button.
 - To remove the existing function from a button press **Erase**.
 - You can also press **More** and use the **Copy** and **Paste** options to copy the settings of an existing button to another button.
 - To assign a function to the highlighted button press **Replace**.
 - Select the required function from the list and press **Select**.
 - Depending on the function you may need to enter some information such as a target extension number.
 - The button will be given a default label. To change the label, press **More** and then select **Label**. Use the keyboard to enter the text you want to display for the button label. Note that the label is only shown while editing the label and after you exit the administration menu.
7. When completed press **Back**.

16.2 Abbreviated Dial

This action can be used as a speed dial button. While setting up the button, enter the number you would like it to dial.

You can enter a partial number and complete the dialing after pressing the button. For example pre-program the button with a particular international dialing code.

16.3 Absence Text

Set or clear an absence text message for display on your phone. The text is also displayed on other extension when they call you. When setting the message you can select from a number of pre-configured messages and then add your own text.

16.4 Account Code

This action can be setup with or without an account code.

If the button is setup with an account code, that account code is applied to the current call when the button is pressed.

If the button is setup without an account code, pressing the button will display the [enter account code](#)  menu.

16.5 Automatic Callback

A button with this action can be used to set a callback on a user who does not answer. After ring the user, press the button. When the target user ends their next call, the system will ring you and then the targeted user.

When a callback has been set, the button's red lamp is lit. Pressing the button again cancels the callback.

16.6 Breakout

This action is useable within a [Small Community Network](#)  of IP Office systems. When the button is pressed, the menu will allow selection of another IP Office system within the network. The number that you then dial will be output from that IP Office system.

This feature is useful if you are able to hot desk to other IP Office systems within the network. While logged in on a remote system, it will allow you to dial out from your home system as if still working there.

16.7 Call Forward All

A button with this action can be used to switch forwarding unconditional on/off.

If setup with a preset number, that number is used as the forwarding destination.

If setup without a number, when the button is pressed you will be asked to confirm your existing forward unconditional destination number or to enter a new number.

The button's red lamp is lit when forwarding is enabled. On touch tone phones an icon is displayed. The button can be pressed again to switch forward unconditional off.

16.8 Call Park

A button setup with this action can be used to park and unpark calls. The button can be setup with or without a park slot number.

- When associated with a specific park slot number, the button will park and unpark calls from that park slot. When a call has been parked, the button's red lamp is lit. Pressing the button again shows the parked call details and enables you to retrieve the call.
- When not associated with a specific park slot number, the button will park calls by assigning them a park slot number based on your extension number. More than 1 call can be parked. When a call has been parked, the button's red lamp is lit. When you press the button all the calls that are parked are displayed. Select the call that you want to retrieve and press the connect soft button.
 - If pressed while a call is connected, that call will be parked using a park slot number assigned by the system based on your extension number.
 - If pressed with no call connected, your phone will display details of your parked calls.

16.9 Call Park to Other

A button setup with this action can be used to park a call against another extension. The park slot number used will be based on your extension number.

The button can be setup with a target user number or left blank for number entry when the button is pressed. The button's red lamp is lit when a call is parked. The button can be pressed again to retrieve the call.

16.10 Call Pickup

Answer a call ringing a user or hunt group.

The target user or group number from which to pickup a call can be set when the button is configured. If no number is set, pressing the button will display a menu for number entry.

16.11 Call Pickup Any

Answer a call currently ringing on the telephone system.

16.12 Drop Call

This action can be used to drop your current call without having to highlight it on the display.

16.13 Flash Hook

A button configured for this action will send a hook flash signal to a currently connected analog line.

16.14 Group BLF

A button can be programmed to indicate if there are any calls to a group waiting to be answered. A red flashing lamp indicates that there are calls waiting for the hunt group. Press the button to pickup the longest waiting call.

16.15 Hunt Group Night Service

A button configured with this action can be used to put a hunt group into or out of night service status.

The button cannot be used to override a hunt group put into night service by a time profile on the telephone system.

The button can be configured with a hunt group number or it can be left blank to toggle all groups of which you are a member.

16.16 Internal Auto Answer

A button configured with this action can be used to switch internal auto-answer on or off. When internal auto-answer is on, the button's red lamp is lit. Pressing the button again turns the internal auto-answer off.

16.17 Paging

A button configured with this action can be used to make a page call.

The button can be configured with the target user or group for the page. If configured with no number, pressing the button will display a menu for number entry before making the page call.

16.18 Ringer Off

A button configured with this action can be used to turn your phone's ringer on or off.

When you turn the ringer off the visual alerting is also turned off. When the ringer has been turned off, the button's red lamp is lit. Pressing the button again will turn the ringer on.

16.19 Self Administer

A button configured for this action can be used to access the self-administer menu.

16.20 Send All Calls

A button configured with this action can be used to switch [do not disturb](#)  on or off. When do not disturb is on, the button's red lamp is lit or a red warning icon is displayed. Pressing the button again turns do not disturb off.

16.21 Suppress Digits

Masks the display of digits as you dial them on the phone. Dialed digits are replaced with an **s** character. The button is used to switch the suppression on/off. When suppress digits has been set, the button's red lamp is lit. Pressing the button again cancels the suppression.

- If [en-block](#) ^[22] dialing is active you will see the digits as you dial them. When you make the call the digits will be suppressed.
- When the option suppress digits is used the call is not recorded in the call log.

16.22 User BLF

This type of button can be used to monitor the status of another user. The lamps state will indicate the status of the user.

- **Off = Available**
Pressing the button will make a call to the user.
- **Slow Flash = Ringing**
Pressing the button will display options to pickup the call.
- **Fast Flash = On a Call**
Pressing the button will display a number of options.
 - **Call**
Call the user.
 - **Message**
Cause a single burst of ringing on the user's phone. They will also see the message Please Call and your extension number.
 - **Voicemail**
Call the user's voicemail mailbox to leave a message.
 - **Auto Callback**
Set an automatic callback on the user. The callback will occur when the users ends their current call.

The following options are only available if configured for you by your system administrator.

- **Drop Call**
Disconnect the user's current call.
- **Acquire**
Seize the user's current call.
- **Intrude**
Join the user's current call, turning it into a conference call.
- **Listen**
Start silent monitoring of the user's call.

In addition to calling the user, the button can be used in processes such as transferring calls or starting a conference rather than dialing the user's extension number.

Chapter 17.

Phone Settings

17. Phone Settings

Pressing the **A MENU** key accesses a menu that can be used to control various phone settings. These are mainly settings stored by the phone rather than user settings that move with you.

General	Display Controls
<ul style="list-style-type: none"> • Mobile Twinning ^[101] • Withhold Number ^[101] • Redial Mode ^[101] • Backup/Restore ^[113] • En-Bloc Dialing ^[102] • Auto Lock ^[102] 	<ul style="list-style-type: none"> • Display Brightness ^[106] • Display Contrast ^[106] • Call Timer ^[109] • Show Last Call Duration ^[106] • Display Language ^[110] • Show Waiting Calls ^[110] • Exit Menu Inactivity Timer (Auto Return) ^[110] • Quick Touch Buttons ^[111]
Sounds	Ringer Controls
<ul style="list-style-type: none"> • Button Clicks ^[112] • Error Tones ^[112] • Ringer Volume ^[112] • Handset Volume ^[113] • Headset Volume ^[113] • Speaker Volume ^[113] • Automatic Gain Control ^[113] • Default Audio Path ^[114] 	<ul style="list-style-type: none"> • Switch the Ringer On/Off ^[104] • Flash the message lamp for calls (Visual Alerting) ^[104] • Coverage Ring ^[104] • Ring Sound ^[106] • Ring Volume ^[106] • Internal Auto Answer ^[106]

17.1 Mobile Twinning

This menu option is only available if you have been configured by the system administrator to be able to use mobile twinning.

- The addition of a button set to the **Twinning** function is recommended, contact your system administrator. Such a button allows you to transfer a call to your twinning destination, retrieve a call from the twinning destination and access the menu options below to set the twinning destination number and switch twinning on/off.

1. Press the **Features** soft key if shown. To do this during a call, press the  **PHONE** key and then press the **Features** soft key.
2. Use the ▲ up and down ▼ arrow keys to highlight **Forward**. Press **Select**.
3. Use the ▲ up and down ▼ arrow keys to highlight **Mobile Twinning**. Press **Select**.
4. If no twinning number has been set, the menu will prompt you to enter a number.
5. When a number has been entered, you can access the **Enable** and **Disable** soft keys to turn use of mobile twinning on or off. The **Clear** soft key removes the existing twinning number in order to allow entry of a new number.

17.2 Withhold Number

You can select to withhold your number on external calls. Note that this option may not be supported in all situations. It may depend on the configuration of your phone system and options supported by your telephone line provider.

1. Press the **Features** soft key if shown. To do this during a call, press the  **PHONE** key and then press the **Features** soft key.
2. Use the ▲ up and down ▼ arrow keys to highlight **Call Settings**. Press **Select**.
3. Use the ▲ up and down ▼ menu keys to highlight **Withhold Number**.
4. Press **Change** to switch the option **On** or **Off**.
5. Press **Save**.

17.3 Redial Mode

You can select whether your phone uses the redial list or last call redial mode.

1. Press the **Features** soft key if shown. To do this during a call, press the  **PHONE** key and then press the **Features** soft key.
2. Use the ▲ up and down ▼ arrow keys to highlight **Call Settings**. Press **Select**.
4. Use the ▲ up and down ▼ arrow keys to highlight **Redial Action**.
5. The current mode, **Open Call Log** or **Last Dialed** is displayed.
 - **Open Call Log**
If this mode is selected, pressing **Redial** will display a menu of the 10 most recent outgoing calls in your call log. You can select the call that you want to redial and perform a number of other functions.
 - **Last Dialed**
If this mode is selected, pressing **Redial** will immediately repeat the most recent outgoing call in your call log. None of the other redial functions will be accessible.
6. Press **Change** to change the mode.
7. When the required mode is displayed, press **Save**.

17.4 En-Bloc Dialing

By default, when you start dialing a number on your phone, the phone immediately connects to the telephone system and starts passing the digits you dial to the phone system. You cannot correct the digits you have already dialed except by ending the call and starting again. Also if you pause dialing for too long the phone system may think that you have finished dialing and will attempt to connect the call using only the digits you have completed dialing so far.

En-bloc dialing allows you to compose and edit the number to dial on your phone's display before it is sent to the phone system to be dialed.

Through the phone's menus you can select whether you want to use traditional or en-bloc dialing when making calls. Your chosen setting is then applied whenever you are using a phone that supports en-bloc dialing.

You can enable or disable your en-bloc dialing setting through the phone's **Features** menu.

1. Press the **Features** soft key if shown. To do this during a call, press the  **PHONE** key and then press the **Features** soft key.
2. Use the ▲ up and down ▼ arrow keys to highlight **Call Settings**. Press **Select**.
4. Use the ▲ up and down ▼ arrow keys to highlight **En-Bloc Dial**.
5. Use **Change** button to select **On** or **Off**.

17.5 Auto Lock

Rather than logging out, you can lock your phone. You can either [lock your phone manually](#) ^[70] using the steps below or have it automatically locked after a period of phone inactivity. To use this feature you need a [security PIN](#) ^[71] (login code) set.

When your phone is locked:

- It can only be used to make internal and emergency calls.
- None of the menus for your user settings can be accessed.
- To [unlock the phone](#) ^[70] requires your login code if you have [configured a login code](#) ^[71].

1. Press the **Features** soft key if shown. To do this during a call, press the  **PHONE** key and then press the **Features** soft key.
2. Use the ▲ up and down ▼ arrow keys to highlight **Phone User**. Press **Select**.
3. Use the ▲ up and down ▼ arrow keys to highlight **Phone Screen Settings**. Press **Select**.
4. Use the ▲ up and down ▼ arrow keys to highlight **Auto Lock (minutes)**.
5. Press the **Change** soft key to change the setting or use the ◀ left or right ▶ arrow keys.
 - **Disabled**
Do not use the inactivity timer.
 - **1 / 5 / 30 / 60**
Lock the phone after the indicated number of minutes.
6. Press the **Save** soft key.

17.6 Ringer Controls

This section covers controls for adjusting the ringing used by your phone.

- [Switch the Ringer On/Off](#) ⁽¹⁰⁴⁾
- [Flash the message lamp for calls \(Visual Alerting\)](#) ⁽¹⁰⁴⁾
- [Coverage Ring](#) ⁽¹⁰⁴⁾
- [Ring Sound](#) ⁽¹⁰⁵⁾
- [Ring Volume](#) ⁽¹⁰⁶⁾
- [Internal Auto Answer](#) ⁽¹⁰⁸⁾

Calls are presented with a number of different ring patterns.

- **Internal Calls:** *Repeated single ring.*
- **External Calls:** *Repeated double ring.*
- **Ringback/Return Calls:** *Repeated single-ring followed by two short rings.*
This type of ring is used for calls that are returning to your phone. For example, a call that you put on hold and which is returning due to being left on hold too long.
- **Coverage Ring:** *Variable*
You can also adjust the ringing used for call coverage and bridged appearance buttons. See [Coverage Ring](#) ⁽¹⁰⁴⁾. The options are normal ringing, an abbreviated ring (a non-repeated single ring) or no ring.
- **Attention Ring:** *Variable*
The system administrator can adjust the ring used for new calls when you are already talking to a caller. The options are an abbreviated ring (a non-repeated single ring) or no ring.
 - For calls alerting on a call coverage or bridged appearance button when you are already on a call, the shorter of the coverage ring or attention ring settings is used.

The system administrator can also adjust the when ringing is used for each specific appearance button. The ringing can be immediate, delayed for a set time or off.

17.6.1 Disabling the Ringer

This option can be used to turn off the ringer for all calls. If set to no ring, this disables both the phones audible alerting and [visual alerting](#) ^[104].

1. Press the **Features** soft key if shown. To do this during a call, press the  **PHONE** key and then press the **Features** soft key.
2. Use the ▲ up and down ▼ arrow keys to highlight **Call Settings**. Press **Select**.
4. Use the ▲ up and down ▼ arrow keys to highlight **Disable Ringer**.
5. Press the **Change** soft key to change the setting. Selecting **On** will turn the ringer off.

17.6.2 Visual Alerting

The message waiting lamp at the top-right corner of the phone can also be used to indicate when you have a call alerting your phone. The lamp is flashed to indicate a call waiting to be answered.

1. Press the **A MENU** button. On touch screen phones, press the **A HOME** button and select **Settings**.
2. Use the ▲ up and down ▼ arrow keys to highlight **Options & Settings**. Press **Select**.
3. Use the ▲ up and down ▼ arrow keys to highlight **Call Settings**. Press **Select**.
4. Use the ▲ up and down ▼ arrow keys to highlight **Visual Alerting**.
5. Press the **Change** soft key to change the setting.
6. When completed, press the **Save** soft key.
7. Press the **Back / Exit** soft keys to exit the menus.

17.6.3 Coverage Ring

If you have any bridged appearance and or call coverage buttons, you can [set the type of ringing \(coverage ring\)](#) ^[104] that should be used when a call alerts on any of those buttons. The options are to use normal ringing, a single non-repeated ring (abbreviated ring) or no ring. The coverage ring setting is only used if you do not already have a connected call. If you already have a connected call in progress, the shorter of your coverage ring and the system administrator set attention ring settings is used.

This is a user setting which will move with you if you hot desk another phone.

1. Press the **Features** soft key if shown. To do this during a call, press the  **PHONE** key and then press the **Features** soft key.
2. Use the ▲ up and down ▼ arrow keys to highlight **Call Settings**. Press **Select**.
4. Use the ▲ up and down ▼ arrow keys to highlight **Coverage Ring**.
5. Press the **Change** soft key to change the setting.
 - **Ring** - Use normal ringing.
 - **Abbreviated** - Use a single non-repeated ring (abbreviated ring).
 - **Off** - No ring.

17.6.4 Ring Sound

Calls are presented with a number of different ring patterns.

- **Internal Calls:** *Repeated single ring.*
- **External Calls:** *Repeated double ring.*
- **Ringback/Return Calls:** *Repeated single-ring followed by two short rings.*
This type of ring is used for calls that are returning to your phone. For example, a call that you put on hold and which is returning due to being left on hold too long.
- **Coverage Ring:** *Variable*
You can also adjust the ringing used for call coverage and bridged appearance buttons. See [Coverage Ring](#)^[104]. The options are normal ringing, an abbreviated ring (a non-repeated single ring) or no ring.
- **Attention Ring:** *Variable*
The system administrator can adjust the ring used for new calls when you are already talking to a caller. The options are an abbreviated ring (a non-repeated single ring) or no ring.
 - For calls alerting on a call coverage or bridged appearance button when you are already on a call, the shorter of the coverage ring or attention ring settings is used.

The system administrator can also adjust the when ringing is used for each specific appearance button. The ringing can be immediate, delayed for a set time or off.

You can adjust the sound of the ring used by the phone.

1. Press the **A MENU** button. On touch screen phones, press the **A HOME** button and select **Settings**.
2. Use the **▲** up and down **▼** arrow keys to highlight **Options & Settings**. Press **Select**.
3. Use the **▲** up and down **▼** arrow keys to highlight **Screen & Sound Options**. Press **Select**.
4. Use the **▲** up and down **▼** arrow keys to highlight **Personalized Ringing**. Press **Select**.
 - Use the **▲** up and down **▼** arrow keys to scroll through the different available ring patterns.
 - Press the **Play** soft key to repeat the currently display ring pattern.
 - Press **Other** to hear a different version of the ring sound.
 - To make the currently displayed ring pattern the selected ring pattern for the phone press the **Save** soft key.
 - To leave the menu without making any changes press the **Cancel** soft key.
5. Press **Back / Exit** to exit the menus.







17.6.5 Ringer Volume

You can adjust the ringer volume while the phone is idle or while it is ringing.

1. With the phone idle or ringing, press the  key.
2. Use the + plus and – minus keys to adjust the volume.
3. The display will return to normal after a few seconds.

17.6.6 Internal Auto Answer

You can select to have internal calls automatically connected if you are not already on a call. The call will be connected, after the phone gives a brief tone, using either the phone's speaker or the headset as set by the phone's [audio path setting](#) ^[114].

1. Press **Features**.
2. Use the  up and down  arrow keys to highlight **Options & Settings**. Press **Select**.
3. Use the  up and down  arrow keys to highlight **Call Settings**. Press **Select**.
4. Use the  up and down  arrow keys to highlight **Internal Auto-Answer**.
5. Press the **Change** soft key to change the setting.

This function can be assigned to a [feature button](#) ^[92] configured with the Internal Auto Answer action. The button lamp will indicate when internal auto answer is on.

17.7 Display Controls

This section covers controls for adjusting the phones display and the information shown on the display.

- **Display Brightness** ^[108]
Adjust the brightness of the display.
- **Display Contrast** ^[108]
Adjust the contrast of the display.
- **Call Timer** ^[109]
Adjust whether the ring/call time is displayed for calls on appearance buttons.
- **Show Last Call Duration** ^[108]
Display the duration of a call for a few seconds after the call is ended.
- **Display Language** ^[110]
Select the language used for the phones menus.
- **Show Waiting Calls** ^[110]
If, when already on a call, there is another call waiting to be answered, automatically toggle the call information displayed between details of the current call and those of the waiting call.
- **Exit Menu Inactivity Timer (Auto Return)** ^[110]
Return to the normal call display after a period of inactivity in a menu.
- **Quick Touch Buttons** ^[111]
On 9621 and 9641 phones you can display a fixed set of buttons at the bottom of the screen.

17.7.1 Display Brightness

1. Press the **A MENU** button. On touch screen phones, press the **A HOME** button and select **Settings**.
2. Use the ▲ up and down ▼ arrow keys to highlight **Options & Settings**. Press **Select**.
3. Use the ▲ up and down ▼ arrow keys to highlight **Screen & Sound Options**. Press **Select**.
4. Use the ▲ up and down ▼ arrow keys to highlight **Brightness**. Press **Select**.
5. Use the ◀ up and down ▶ arrow keys to adjust the brightness as required.
6. When completed, press the **Save** soft key.
7. Press **Back / Exit** to exit the menus.

17.7.2 Display Contrast

1. Press the **A MENU** button. On touch screen phones, press the **A HOME** button and select **Settings**.
2. Use the ▲ up and down ▼ arrow keys to highlight **Options & Settings**. Press **Select**.
3. Use the ▲ up and down ▼ arrow keys to highlight **Screen & Sound Options**. Press **Select**.
4. Use the ▲ up and down ▼ arrow keys to highlight **Contrast**. Press **Select**.
5. Use the ◀ left and right ▶ arrow keys to adjust the brightness as required.
6. When completed, press the **Done** soft key.
7. Press **Back / Exit** to exit the menus.

17.7.3 Last Call Duration Display

As an alternate to [call timer](#)^[109] display, you can have the phone briefly (4 seconds) display the duration of the call after it is ended.

1. Press the **Features** soft key if shown. To do this during a call, press the  **PHONE** key and then press the **Features** soft key.
2. Use the ▲ up and down ▼ arrow keys to highlight **Call Settings**. Press **Select**.
3. Use the ▲ up and down ▼ arrow keys to highlight **Show Last Call Duration**.
4. Press **Change** to change the setting between **On** or **Off**.
5. Press the **Save** soft key.

17.7.4 Call Timer Display

When you have calls alerting on appearance buttons, the phone can include a timer in the appearance details shown on the display. The timer shows how long the call has been alerting and, if you answer the call, resets to show how long the call has been connected. The timer will also show how long a call has been on hold when you hold the call.

You can turn the timer display on or off. Turning it off provides more space for other call details on the display.

9621 and 9641 Phones

By default, when you are connected on a call, the display will show details of that call. In order to see details of another call such as a held call or a waiting call you need to scroll the display using the up and down arrow buttons.

Using this option, you can select to have the current call display automatically toggle between details of the current call and the waiting call display.

1. Press the **Features** soft key if shown. To do this during a call, press the  **PHONE** key and then press the **Features** soft key.
2. Use the ▲ up and down ▼ arrow keys to highlight **Call Settings**. Press **Select**.
3. Use the ▲ up and down ▼ arrow keys to highlight **Call Timer**.
4. Press **Change** to change the setting between **On** or **Off**.
5. Press the **Save** soft key.

Other 9600 Phones

1. Press the **A MENU** button. On touch screen phones, press the **A HOME** button and select **Settings**.
2. Use the ▲ up and down ▼ arrow keys to highlight **Options & Settings**. Press **Select**.
3. Use the ▲ up and down ▼ arrow keys to highlight **Call Settings**. Press **Select**.
4. Use the ▲ up and down ▼ arrow keys to highlight **Display Call Timer**.
5. Press **Change** to change the setting between **On** or **Off**.
6. When completed, press the **Save** soft key.
7. Press **Back / Exit** to exit the menus.

17.7.5 Display Language

The system administrator can configure which languages are available for use by the phone for its own menus. Up to 5 languages can be made available.

Through the phone's menu you can select which of those languages the phone should use.

Note that many of the messages displayed on the phone use text sent from the telephone system. They will use the default language of the telephone system unless the system administrator has set you to use a specific language supported by the phone system.

1. Press the **A MENU** button. On touch screen phones, press the **A HOME** button and select **Settings**.
2. Use the **▲** up and down **▼** arrow keys to highlight **Options & Settings**. Press **Select**.
3. Use the **▲** up and down **▼** arrow keys to highlight **Screen & Sound Options**. Press **Select**.
4. Use the **▲** up and down **▼** arrow keys to highlight **Language**. Press **Select**.
5. Use the **▲** up and down **▼** arrow keys scroll through the different languages available.
6. To select the language currently highlighted, press **Select**.
7. When completed, press the **Save** soft key.
8. Press **Back / Exit** to exit the menus.

17.7.6 Show Call Waiting

By default, when you are connected on a call, the display will show details of that call. In order to see details of a another call such as a held call or a waiting call you need to scroll the display using the up and down arrow buttons.

Using this option, you can select to have the current call display automatically toggle between details of the current call and the waiting call display.

1. Press the **Features** soft key if shown. To do this during a call, press the  **PHONE** key and then press the **Features** soft key.
2. Use the **▲** up and down **▼** arrow keys to highlight **Call Settings**. Press **Select**.
4. Use the **▲** up and down **▼** arrow keys to highlight **Auto Display Waiting Call**.
5. Press **Change** to change the setting.
 - **Off**
Show details of the current call only.
 - **On**
Automatically toggle the display between details of the current call and the waiting call.
6. Press the **Save** soft key.

17.7.7 Inactivity Timer (Auto Return)

You can set a timer which will return the phone to its normal call display after a set period of phone inactivity. By default the phone will be set to auto return after 60 seconds.

Note that the timer is not applied to all menus. For example it is not applied to the A-menu and to the visual voice menu. It is also not applied to the **System Admin** section of the **Features** menus.

1. Press the **Features** soft key if shown. To do this during a call, press the  **PHONE** key and then press the **Features** soft key.
2. Use the **▲** up and down **▼** arrow keys to highlight **Phone User**. Press **Select**.
3. Use the **▲** up and down **▼** arrow keys to highlight **Phone Screen Settings**. Press **Select**.
4. Use the **▲** up and down **▼** arrow keys to scroll the display to the option **Auto Return (s)**.
5. Press **Change** to change the setting.
 - **Disabled**
Do not use the inactivity timer.
 - **30 / 60**
Apply the inactivity timer after the selected number of seconds.
6. Press the **Save** soft key.

17.7.8 Quick Touch Lines

For 9621 and 9641 phones you can select whether to display 0, 1 or 2 rows of fixed buttons across the bottom of the call display screen, each row containing 4 buttons. Fixed means the rows do not scroll out of view when the rest of the screen is scrolled.

The quick touch buttons match programmable feature button 4 to 11.

1. Press the **Features** soft key if shown. To do this during a call, press the  **PHONE** key and then press the **Features** soft key.
2. Use the ▲ up and down ▼ arrow keys to highlight **Phone User**. Press **Select**.
3. Use the ▲ up and down ▼ arrow keys to highlight **Phone Screen Settings**. Press **Select**.
4. Use the ▲ up and down ▼ arrow keys to scroll the display to the option **Quick Touch Lines**.
5. Press **Change** to change the setting.
 - **Off**
No quick touch rows.
 - **1**
Display 1 row of 4 quick touch buttons across the bottom.
 - **2**
Display 2 rows of 4 quick touch buttons across the bottom.
6. Press the **Save** soft key.

17.8 Volume and Sound

This section covers controls that relate to the various sounds that your phone uses and to the volume. These are in addition to the [ringer controls](#) ^[103] available.

- **Button Click** ^[112]
Turn the phone menu key click on or off.
- **Error Tones** ^[112]
Turn the phone menu error tones on or off.
- **Ringer Volume** ^[112]
Adjust the volume of the ringer used by the phone.
- **Handset Volume** ^[113]
Adjust the incoming call volume heard through the phone's handset.
- **Headset Volume** ^[113]
Adjust the incoming call volume heard through a headset attached to the phone.
- **Speaker Volume** ^[113]
Adjust the incoming call volume heard through the phone's speaker.
- **Automatic Gain Control** ^[113]
Switch automatic gain control on or off.

Note

The system administrator can set your phone to reset its volume after each call.

17.8.1 Button Clicks

While using the phone menus, the phone can provide a key press confirmation click sound. This can be turned off if it is annoying.

1. Press the **A MENU** button. On touch screen phones, press the **A HOME** button and select **Settings**.
2. Use the **▲** up and down **▼** arrow keys to highlight **Options & Settings**. Press **Select**.
3. Use the **▲** up and down **▼** arrow keys to highlight **Screen & Sound Options**. Press **Select**.
4. Use the **▲** up and down **▼** arrow keys to highlight **Button Clicks**.
5. Press **Change** to change the setting between **On** or **Off**.
6. When completed, press the **Save** soft key.
7. Press **Back / Exit** to exit the menus.

17.8.2 Error Tones

1. Press the **A MENU** button. On touch screen phones, press the **A HOME** button and select **Settings**.
2. Use the **▲** up and down **▼** arrow keys to highlight **Options & Settings**. Press **Select**.
3. Use the **▲** up and down **▼** arrow keys to highlight **Screen & Sound Options**. Press **Select**.
4. Use the **▲** up and down **▼** arrow keys to highlight **Error Tones**.
4. Press **Change** to change the setting between **On** or **Off**.
5. When completed, press the **Save** soft key.
6. Press **Back / Exit** to exit the menus.

17.8.3 Ringer Volume

You can adjust the ringer volume while the phone is idle or while it is ringing.

1. With the phone idle or ringing, press the **◀** key.
2. Use the **+** plus and **-** minus keys to adjust the volume.
3. The display will return to normal after a few seconds.

17.8.4 Handset Volume

While talking via the handset, you can adjust the volume of the incoming call.

1. With the call connected on the handset, press the  key.
2. Use the + plus and – minus keys to adjust the volume.
3. The display will return to normal after a few seconds.

17.8.5 Headset Volume

While talking via the headset, you can adjust the volume of the incoming call.

1. With the call connected on the headset, press the  key.
2. Use the + plus and – minus keys to adjust the volume.
3. The display will return to normal after a few seconds.









17.8.6 Speaker Volume

While talking handsfree via the phone's speaker, you can adjust the volume of the incoming call.

1. With the call connected on the speaker, press the  key.
2. Use the + plus and – minus keys to adjust the volume.
3. The display will return to normal after a few seconds.

17.8.7 Automatic Gain Control

When using automatic gain control (AGC), the phone tries to maintain a constant audio level even if the incoming call changes between loud and quiet.

1. Press the  **MENU** button. On touch screen phones, press the  **HOME** button and select **Settings**.
2. Use the  up and down  arrow keys to highlight **Advanced Options**. Press **Select**.
3. Use the  up and down  arrow keys to highlight **Automatic Gain Control**. Press **Select**.
 - Use the  up and down  arrow keys to switch between the **Handset**, **Headset** or **Speaker** settings for automatic gain control.
 - To change the highlighted setting, press **Change**.
4. When completed, press the **Save**.
5. Press **Back** / **Exit** to exit the menus.

17.8.8 Default Handsfree Audio Path

By default, when you make a call or answer a call without lifting the handset, the audio is played through the phone's speaker while you speak via the phone's microphone.

If you have a headset attached, you can change the phone's behavior so the audio is played through the headset by default rather than the speaker.

1. Press the **A MENU** button. On touch screen phones, press the **A HOME** button and select **Settings**.
2. Use the **▲** up and down **▼** arrow keys to highlight **Options & Settings**. Press **Select**.
3. Use the **▲** up and down **▼** arrow keys to highlight **Call Settings**. Press **Select**.
4. Use the **▲** up and down **▼** arrow keys to highlight **Audio Path**.
5. Press **Change** to change the setting between **Headset** and **Speaker**.
6. When completed, press the **Save** soft key.
7. Press the **Back / Exit** soft keys to exit the menus.

17.9 Backup/Restore

If backup/restore has been setup by your system administrator, it is used automatically when you login or log out from the phone.

Backup/restore is used for the phone settings that you have configured within the menu's provided by the phone's **A MENU** button. When you login at another 1600 or 9600 Series phone extension, your phone settings are restored and applied to that phone. They will remain applied to the phone until another user logs in and their phone settings are applied.

By default your call log and your personal contacts are stored on the telephone system. These will be restored by the telephone system when you login on another 1600 or 9600 Series phone regardless of whether backup/restore has been configured for 1600 and 9600 Series phones.

When backup/restore has been configured, the phone menu provides options to manually access backup and restore functions.

- [Manually Backup Phone Settings](#)^[115]
- [Manually Restore Phone Settings](#)^[115]

17.9.1 Backup

If backup/restore has been setup by your system administrator, it is used automatically when you login or log out from the phone.

In addition, the option below is available to manually trigger a backup of your user settings.

1. Press the **A MENU** button. On touch screen phones, press the **A HOME** button and select **Settings**.
 2. Use the ▲ up and down ▼ arrow keys to highlight **Advanced Options**. Press **Select**.
 3. Use the ▲ up and down ▼ arrow keys to highlight **Backup/Restore**. Press **Change**.
 4. Use the ▲ up and down ▼ arrow keys to highlight **Manual Backup**. Press **Backup**.
- **!** This option is only available if your system administrator has configured backup/restore operation.

17.9.2 Restore

If backup/restore has been setup by your system administrator, it is used automatically when you login or log out from the phone.

In addition, the option below is available to manually trigger a restore of your user settings.

1. Press the **A MENU** button. On touch screen phones, press the **A HOME** button and select **Settings**.
 2. Use the ▲ up and down ▼ arrow keys to highlight **Advanced Options**. Press **Select**.
 3. Use the ▲ up and down ▼ arrow keys to highlight **Backup/Restore**. Press **Change**.
 4. Use the ▲ up and down ▼ arrow keys to highlight **Manual Restore**. Press **Restore**.
- **!** This option is only available if your system administrator has configured backup/restore operation.



Chapter 18.

Status Menu

18. Status Menu

The **Status** menu is not always visible. It is shown when you have any special call routing features active. For example do not disturb switched on.

It is also shown if the system administrator has given you the rights to change the status of your hunt group memberships or to change the service status of the hunt groups.

- [Switching mobile twinning off](#) ^[12†]
- [View and unpark parked calls](#) ^[12‡]
- [Clear or change a follow me to setting](#) ^[11§]
- [Switch off do not disturb](#) ^[11§]
- [Clear or change forward unconditional](#) ^[12§]
- [Clear or change forward on no answer](#) ^[12§]
- [Clear or change forward on busy](#) ^[11§]
- [Clear or change follow me here settings](#) ^[11§]
- [Change hunt group membership status](#) ^[12†]
- [Change hunt group service status](#) ^[12†]
- [View System Alarms](#) ^[12‡]

18.1 Do Not Disturb

You can use the **Status** menu to switch off do not disturb.

1. Press the **Status** soft key if shown.
 - To access the status menu during a call, press the  **PHONE** key and then press the **Status** soft key if shown.
2. If necessary use the ▲ up and down ▼ arrow keys to highlight **Do Not Disturb**.
 - To clear the do not disturb setting, press the **Off** soft key.

18.2 Follow Me To

If you have set a follow me destination for calls to your phone, you can clear or change the setting through the **Status** menu.

1. Press the **Status** soft key if shown.
 - To access the status menu during a call, press the  **PHONE** key and then press the **Status** soft key if shown.
 2. Use the ▲ up and down ▼ arrow keys to highlight **Follow Me To**.
 - To clear the follow me to setting, press the **Clear** soft key.
 - To change the destination of the setting, press the **Details** soft key.
- **!** The system administrator is able to configure whether you can access the **Forward** and **Follow Me** menu and status options.

18.3 Follow Me Here

If other users has a follow me set to you phone, you can clear or change the setting through the **Status** menu.

1. Press the **Status** soft key if shown.
 - To access the status menu during a call, press the  **PHONE** key and then press the **Status** soft key if shown.
2. Use the ▲ up and down ▼ arrow keys to highlight **Follow Me Here**. There will be a separate entry for each user.
 - To clear the follow me to setting, press the **Clear** soft key.
 - To change the destination of the setting, press the **Details** soft key.
 - Use the menu to add or remove users.
 - Use the ▲ up and down ▼ arrow keys to scroll through the names.
 - To remove a user, press the **Clear** soft key.
 - To add a user, press the **Add** soft key.
 - Dial the number of another user. When it matches a user their name is displayed. Alternatively, use the **Dir** soft key to [select a user from the directory](#)^[52].
 - Press the **Save** soft key to set the follow me here.
- **!** The system administrator is able to configure whether you can access the **Forward** and **Follow Me** menu and status options.

18.4 Forward On Busy

If your phone is set to forward on busy, you can clear or change the forward settings through the **Status** menu.

1. Press the **Status** soft key if shown.
 - To access the status menu during a call, press the  **PHONE** key and then press the **Status** soft key if shown.
2. Use the ▲ up and down ▼ arrow keys to highlight **Fwd Busy**.
3. To switch the forward off press **Off**.
4. To change the forward setting press **Details**.
 - Use the ▲ up and down ▼ arrow keys to scroll through the menu options.
 - To switch forward on busy on or off, highlight **Fwd Busy** and press **On** or **Off**.
 - To switch forward on no answer on or off, highlight **Fwd No Answer** and press **On** or **Off**.
 - To select which calls are forwarded highlight **Call Type**. Press **Change** to change the option between **All Calls** or **External Calls Only**.
 - To change the destination highlight **Destination** and press **Edit**. Enter the number and press **Select**.
 - Press **Save** to save any changes.
- **!** The system administrator is able to configure whether you can access the **Forward** and **Follow Me** menu and status options.

18.5 Forward On No Answer

If your phone is set to [forward on no answer](#)^[14], you can clear or change the forward settings through the **Status** menu.

1. Press the **Status** soft key if shown.
 - To access the status menu during a call, press the  **PHONE** key and then press the **Status** soft key if shown.
 2. Use the ▲ up and down ▼ arrow keys to highlight **Fwd No Answer**.
 3. To switch the forward off press **Off**.
 4. To change the forward setting press **Details**.
 - Use the ▲ up and down ▼ arrow keys to scroll through the menu options.
 - To switch forward on busy on or off, highlight **Fwd Busy** and press **On** or **Off**.
 - To switch forward on no answer on or off, highlight **Fwd No Answer** and press **On** or **Off**.
 - To select which calls are forwarded highlight **Call Type**. Press **Change** to change the option between **All Calls** or **External Calls Only**.
 - To change the destination highlight **Destination** and press **Edit**. Enter the number and press **Select**.
 - Press **Save** to save any changes.
- **!** The system administrator is able to configure whether you can access the **Forward** and **Follow Me** menu and status options.

18.6 Forward Unconditional

You can clear or change your forward unconditional settings through the **Status** menu.

1. Press the **Status** soft key if shown.
 - To access the status menu during a call, press the  **PHONE** key and then press the **Status** soft key if shown.
 2. Use the ▲ up and down ▼ arrow keys to highlight **Fwd Uncon**.
 - To switch off forward unconditional, press the **Off** soft key.
 - To change the forwarding settings, press the **Details** soft key.
 - Use the ▲ up and down ▼ arrow keys to scroll through the editing options.
 - Use the ◀ left and right ▶ arrow keys to switch the forwarding on or off.
 - Use the ◀ left and right ▶ arrow keys to select which calls should be forwarded. The options are **External Only**, **External and Group**, **Non Group Calls** and **All Calls**.
 - Select edit to change the number to which calls are forwarded.
- **!** The system administrator is able to configure whether you can access the **Forward** and **Follow Me** menu and status options.

18.7 Forwarded Here

This option allows you to see the names of users who are currently forwarding calls to you. It includes forward unconditional, forward on no answer and forward on busy. A separate entry is shown for each user.

1. Press the **Status** soft key if shown.
 - To access the status menu during a call, press the  **PHONE** key and then press the **Status** soft key if shown.
 2. Use the ▲ up and down ▼ arrow keys to highlight **Fwd To Here**.
- **!** The system administrator is able to configure whether you can access the **Forward** and **Follow Me** menu and status options.

18.8 Group Membership

If the system administrator has allowed you, you can enable/disable your membership of a group through the **Status** menu. When your membership of a group is disabled you do not receive group calls for that group.

1. Press the **Status** soft key if shown.
 - To access the status menu during a call, press the  **PHONE** key and then press the **Status** soft key if shown.
2. Use the ▲ up and down ▼ arrow keys to highlight the hunt group name and your current membership status (**Enabled** or **Disabled**).
3. Press the **Enable** or **Disable** soft key to change the status of your membership of that group.
4. Press **Exit**.

18.9 Group Service Status

If the system administrator has allowed you, you can change the service state of a group through the **Status** menu.

1. Press the **Status** soft key if shown.
 - To access the status menu during a call, press the  **PHONE** key and then press the **Status** soft key if shown.
2. Use the ▲ up and down ▼ arrow keys to highlight the hunt group name and your current membership status.
3. Select the required state using the soft keys:
 - **In Service**
The groups operates a normal, distributing calls to available members of the group.
 - **Night Service**
The group is in night service mode. Calls are redirected to its night service fallback group [if set](#)^[90], otherwise to voicemail if available.
 - A hunt group can also be put into and out of night service automatically by the telephone system using a time profile. If that is the case, the night service state cannot be overridden using manual controls.
 - **Out of Service**
The group is out of service. Calls are redirected to it out of service fallback group [if set](#)^[90], otherwise to voicemail if available.
- **!** The system administrator is able to configure if you can access the **Membership**, **State** and **Fallback** options of a group. If you are not configured for any groups then the **Group** menu is not shown.

18.10 Mobile Twinning

If you have been configured as a mobile twinning user, you can use the status menu to switch mobile twinning mode off.

1. Press the **Status** soft key if shown.
 - To access the status menu during a call, press the  **PHONE** key and then press the **Status** soft key if shown.
2. If necessary use the ▲ up and down ▼ arrow keys to highlight **Mobile Twinning**.
 - To clear the setting, press the **Off** soft key.

18.11 Parked Calls

While parked calls are parked on the telephone system and can be unparked by any other user, the parked call indication is sent to a particular extension. If there are any calls parked against your phone, you can view and unpark them using the **Status** menu.

1. Press the **Status** soft key if shown.
 - To access the status menu during a call, press the  **PHONE** key and then press the **Status** soft key if shown.
2. If you have any parked calls, the **Parks** option is displayed. The option is not present if you do not have calls parked against your extension.
3. Press the **Details** soft key.
4. Use the ▲ up and down ▼ arrow keys to scroll through the parked calls.
5. To unpark a particular call, press the **Connect** soft key.

18.12 System Alarms

If you have been configured as a system administrator (also called a system phone user), an **S** on the phone's display indicates a system alarm message. While you are not expected to be able to fix the error causing the alarm, the error message allows you to report the problem to your system maintainer.

- **Memory Card Failure**
There is a problem with one of the memory cards used by the telephone system. Selecting Admin will take you to the system administration menu where you can check the [status of the memory cards](#)^[132].
- **Expansion Failure**
There is a problem with one of the external expansion modules attached to the telephone system.
- **Voicemail Failure**
The voicemail system is not available.
- **Voicemail Almost Full**
The voicemail system is nearly out of storage space for any more messages, prompts and recordings.
- **Voicemail Full**
The voicemail system cannot store any more messages, prompts and recordings.
- **Licence Key Failure**
There is a problem with the memory card used to license features and applications.
- **System Boot Error**
The telephone system has encountered an error while restarting.
- **Corrupt Date/Time**
There is an error in the date or time being used by the system. Selecting **Admin** will take you to the system administration menu where you can change the [date](#)^[128] and [time](#)^[130].

Chapter 19.

Short Codes

19. Short Codes

Short codes are numbers that you can dial to enable and disable various features. The following are default short codes that may be available. Your system administrator will confirm any additional short codes that they may have configured for your use.

These are useful as they can be dialed from any phone on the system. For example this allows you to login at a basic analog extension and still control a number of features.

Some short codes require you to enter some information when you dial them, typically an extension number. That is indicated by **N** in the short codes shown below.

Park/Unpark

- **Park Call: *37*N#**
Parks the held call using the park number dialed in place of **N**.
- **Unpark Call: *38*N#**
Unpark the call parked using the park number **N**.

Call Pickup

- **Pickup Any Call: *30**
Answer a call ringing on the telephone system.
- **Pickup a Group Call: *31**
Answer a call ringing a group of which you are a member. You can use this even if your group membership is currently set to disabled.
- **Pickup a Users Call: *32*N#**
Pickup a call ringing a user's extension number (**N**).
- **Pickup a Group Members Call: *53*N#**
Pickup a call ringing the members of a group (**N**). This does not necessarily have to be a group call.

Conference

- **Conference Held Calls: *47**
Start a conference between yourself and any calls that you have on hold.

Do Not Disturb

- **Switch Do Not Disturb On: *08**
Set your phone to do not disturb.
- **Switch Do Not Disturb Off: *09**
Switch off do not disturb.
- **Add a Do Not Disturb Exception Number: *10*N#**
Add a number (**N**) to your list of do not disturb exceptions.
- **Delete a Do Not Disturb Exception Number: *11*N#**
Remove a number (**N**) from your list of do not disturb exceptions.
- **Cancel All Forwarding: *00**
Switch off any forwarding. Includes forward unconditional, forward on busy, forward on no answer, follow me and do not disturb.

Follow Me

- **Follow Me Here: *12*N#**
Dialed at the extension to which you want you calls redirected. Use your own extension number (**N**) when dialing the short code.
- **Follow Me Here Cancel: *13*N#**
Dialed at the extension to which you want your calls were redirected. Use your own extension number (**N**) when dialing the short code.
- **Follow Me To: *14*N#**
Dialed at your phone. Dial the extension number (**N**) to which you want your calls redirected. You can dial just ***14#** to cancel follow me.
- **Cancel All Forwarding: *00**
Switch off any forwarding. Includes forward unconditional, forward on busy, forward on no answer, follow me and do not disturb.

Forwarding

- **Cancel All Forwarding: *00**
Switch off any forwarding. Includes forward unconditional, forward on busy, forward on no answer, follow me and do not disturb.
- **Set the Forward Unconditional Destination: *07*N#**
Set the destination number (**N**) for forward unconditional when it is switched on.
 - **Switch Forward Unconditional On: *01**
Switch on forward unconditional. A destination must have been set.
 - **Switch Forward Unconditional Off: *02**
 - **Include Hunt Group Calls in Forward Unconditional: *50**
 - **Exclude Hunt Group Calls from Forward Unconditional: *51**
- **Set the Forward On Busy/No Answer Destination: *57*N#**
Set the destination number (**N**) for forward on busy and forward on no answer. If no number has been set, those functions will use the forward unconditional number if set.
 - **Switch Forward On Busy On: *03**
 - **Switch Forward On Busy Off: *04**
 - **Switch Forward on No Answer On: *05**
 - **Switch Forward on No Answer Off: *06**

Hunt Group

- **Night Service Status On: *20*N#**
Set a hunt group into night service status by entering its extension number (**N**).
- **Night Service Status Off: *21*N#**
Take a hunt group out of night service status by entering its extension number (**N**).

Login

- **Login: *35*N*P#**
Login to a phone using your extension number (**N**) and login code (**P**).
- **Log Out: *36**
Log yourself out from the phone where you are currently logged in.

Voicemail

- **Check Messages: *17**
Access mailboxes to check for messages.
- **Voicemail On: *18**
Allow voicemail to be used to answer calls.
- **Voicemail Off: *19**
Stop voicemail being used to answer calls.
- **Voicemail Ringback On: *48**
Have voicemail ring your phone when you have any new messages. It will call when you use the phone.
- **Voicemail Ringback Off: *49**
Switch off ringback.

Chapter 20.

System Administration

20. System Administration

If necessary, the system administrator can configure you as a 'system phone' user. This allows you to perform a range of additional functions to help maintain your phone system.

- Edit external contacts stored by the phone system.
- Change the system date and time.
- Check the system type and software version.
- Check and perform various actions on any additional memory card installed in the telephone system.

20.1 Checking the System Information

Being able to check and report the system software version may be useful when reporting any potential problems to the system maintainer.

1. Press the **Features** soft key if shown. To do this during a call, press the  **PHONE** key and then press the **Features** soft key.
2. Use the ▲ up and down ▼ arrow keys to highlight **Phone User**. Press **Select**.
3. Use the ▲ up and down ▼ arrow keys to highlight **System Administration**. Press **Select**. If the option is not present then you may not have been configured as a system phone user by your system administrator.
4. Enter your security PIN (login code) and press **Done**.
5. Use the ▲ up and down ▼ arrow keys to highlight **System Information**. Press **Select**.
6. Various items of information about the system are displayed:
 - The system type and the level of software it is running.
 - The IP addresses of the two network interfaces.
 - The serial number of the license key.

20.2 Setting the Date

The process below can be used when the telephone system does not obtain the time and date automatically. On systems that are configured to obtain the time automatically, the option for checking the [Time Server Status](#)^[12] is available instead.

1. Press the **Features** soft key if shown. To do this during a call, press the  **PHONE** key and then press the **Features** soft key.
2. Use the ▲ up and down ▼ arrow keys to highlight **Phone User**. Press **Select**.
3. Use the ▲ up and down ▼ arrow keys to highlight **System Administration**. Press **Select**. If the option is not present then you may not have been configured as a system phone user by your system administrator.
4. Enter your security PIN (login code) and press **Done**.
5. Use the ▲ up and down ▼ arrow keys to highlight **Date**. Press **Select**.
6. The current date being used by the telephone system is displayed.
7. Enter the required date, using the either the * or # keys to enter the / separators. To delete the previous digit or character entered press **Bksp**.
8. When a complete valid date has been entered, the display will confirm that by showing the full date and the **Set** soft key option.
9. To set the date as the new date to be used by the telephone system press **Set**.

20.3 Checking the Time Server Status

For systems where the system automatically obtains the time from a time server, this option is available in place of the [Date](#)^[128], [Time](#)^[130] and [Time Offset](#)^[130] functions. It allows you to check the current status of the time server and the information the system has obtained from the time server.

1. Press the **Features** soft key if shown. To do this during a call, press the  **PHONE** key and then press the **Features** soft key.
2. Use the ▲ up and down ▼ arrow keys to highlight **Phone User**. Press **Select**.
3. Use the ▲ up and down ▼ arrow keys to highlight **System Administration**. Press **Select**. If the option is not present then you may not have been configured as a system phone user by your system administrator.
4. Enter your security PIN (login code) and press **Done**.
5. Use the ▲ up and down ▼ arrow keys to highlight **Time Server Status**. Press **Select**.
6. The time server information is listed. It includes the address of the time server, the current local time and the UTC time. If the phone system is configured for daylight savings then the current amount of daylight savings being applied to the local time is also shown.

20.4 Setting the Time

The process below can be used when the telephone system does not obtain the time and date automatically. On systems that are configured to obtain the time automatically, the option for checking the [Time Server Status](#) ^[129] is available instead.

1. Press the **Features** soft key if shown. To do this during a call, press the  **PHONE** key and then press the **Features** soft key.
2. Use the ▲ up and down ▼ arrow keys to highlight **Phone User**. Press **Select**.
3. Use the ▲ up and down ▼ arrow keys to highlight **System Administration**. Press **Select**. If the option is not present then you may not have been configured as a system phone user by your system administrator.
4. Enter your security PIN (login code) and press **Done**.
5. Use the up and down arrow keys to highlight **Time**. Press **Select**.
6. The current time being used by the telephone system is displayed.
7. Enter the required time in 24-hour clock format:
 - Use either the * or # keys to enter the : separator.
 - To delete the previous digit or character entered press **Bksp**.
8. When a complete valid time has been entered, the display will confirm that by showing the **Set** soft key option.
9. To set the time as the new time to be used by the telephone system press the **Set** soft key.

20.5 Setting the Time Offset

The process below can be used when the telephone system does not obtain the time and date automatically. On systems that are configured to obtain the time automatically, the option for checking the [Time Server Status](#) ^[129] is available instead.

1. Press the **Features** soft key if shown. To do this during a call, press the  **PHONE** key and then press the **Features** soft key.
2. Use the ▲ up and down ▼ arrow keys to highlight **Phone User**. Press **Select**.
3. Use the ▲ up and down ▼ arrow keys to highlight **System Administration**. Press **Select**. If the option is not present then you may not have been configured as a system phone user by your system administrator.
4. Enter your security PIN (login code) and press **Done**.
5. Use the up and down arrow keys to highlight **Local Time Offset**. Press **Select**.
6. The current offset is displayed.
7. Enter the offset required in hours and minutes:
 - To enter the : separator press either the * or # key.
 - To delete the previous digit or character entered press the **Bksp** key.
 - To change the offset from between positive or negative press the ► right arrow key.
8. When a valid offset has been entered, the **Set** soft key is displayed.
9. To apply the offset to the current telephone system time press the **Set** soft key.

20.6 System Shutdown

You can shutdown the telephone system for a specified number of minutes. Note that this is not a polite shut-down, once you have confirmed the action, any existing calls and services using the telephone system will start being disconnected. The telephone system will then remain unavailable for the duration you specify, the default being 10 minutes. After the shutdown duration it will take up to 5 more minutes for the telephone system to complete its restart.

! WARNINGS

- A shutdown must always be used to switch off the system. Simply removing the power cord or switching off the power input may cause errors.
- This is not a polite shutdown, any users calls and services in operation will be stopped. Once shutdown, the system cannot be used to make or receive any calls until restarted.
- The shutdown process takes up to a minute to complete. When shutdown, the CPU LED and the base card LEDs 1 and 9 (if trunk daughter card fitted) will flash red rapidly. The memory card LEDs are extinguished. Do not remove power from the system or remove any of the memory cards until the system is in this state.
- To restart a system when shutdown indefinitely, or to restart a system before the timed restart, switch power to the system off and on again.

1. Press the **Features** soft key if shown. To do this during a call, press the  **PHONE** key and then press the **Features** soft key.
2. Use the ▲ up and down ▼ arrow keys to highlight **Phone User**. Press **Select**.
3. Use the ▲ up and down ▼ arrow keys to highlight **System Administration**. Press **Select**. If the option is not present then you may not have been configured as a system phone user by your system administrator.
4. Enter your security PIN (login code) and press **Done**.
5. Use the up and down arrow keys to highlight **System Shutdown**. Press **Select**.
6. The current default timeout (10 minutes) setting is shown and can be used by pressing **OK** soft key. Otherwise enter the timeout required in hours and minutes and then press the **Ok** soft key.
 - The allowable range for the timeout is from **00:05** to **24:00**. Note that the **Ok** soft key is not displayed if the timeout entered is not within the allowed range.
 - To enter the : symbol in the timeout press either the * or # key.
 - To delete the previous digit or character entered press the ◀ left arrow key.
7. After pressing the **Ok** soft key, you will be asked to confirm whether you want to shutdown the telephone system. Only proceed if you are sure. If you are not sure press **Back**.
8. If you press the **Confirm** soft key, the telephone system will switch itself to a shutdown state. This will disconnect all current calls and services.

20.7 Memory Card Management

The telephone system can be fitted with an additional memory card or cards which are used for various functions. The memory card menu allows you to check the status of the card or cards fitted to your telephone system and to perform a number of actions on the cards.

1. Press the **Features** soft key if shown. To do this during a call, press the  **PHONE** key and then press the **Features** soft key.
2. Use the ▲ up and down ▼ arrow keys to highlight **Phone User**. Press **Select**.
3. Use the ▲ up and down ▼ arrow keys to highlight **System Administration**. Press **Select**. If the option is not present then you may not have been configured as a system phone user by your system administrator.
4. Enter your security PIN (login code) and press **Done**.
7. Use the up and down arrow keys to highlight **Memory Card**. Press **Select**.
8. The menu lists both the current state of the memory card or cards that can be added to the telephone system followed by the actions that can be performed on those cards.
 - The status of each memory card listed will be one of **No Card**, **Active** or **Inactive**. Entries are only listed for the types of cards that are supported on the telephone system to which you are connected:
 - **System** - This refers to the first SD memory card that must be fitted to the system.
 - **Option** - This refers to the second optional SD memory card that can be fitted to the system.
 - The actions that can be performed on the memory cards are listed after the status of the cards. The actions available will depend on the cards fitted and the current status of those cards. After selecting an action, you can then select the card on which you want the action performed and then press the Confirm soft key to start the action.
 - **System Backup**
This option is available when a **System** card is present and active. It allows the telephone system's current configuration settings to be copied to a backup file on the memory card.
 - **System Restore**
This option is available when a **System** card is present and active. It overwrites the telephone system's current configuration settings with those from a backup file on the card.
 - **Upgrade Configuration**
Copy configuration files from an **Optional** card to the **System** card in the system's control unit.
 - **Upgrade Binaries**
Copy software files from an **Optional** card to the **System** card in the system's control unit.
 - **Copy**
This option is available on systems where both a **System** and **Option** memory card are active. It copies the contents of the **System** card to the **Option** card.
 - **Shutdown**
This option is available when an **Active** card is present. It allows the card to be made inactive.
 - **Start Up**
This option is available when an **Inactive** card is present. It allows the card to be made active again.

20.8 System Alarms

If you have been configured as a system administrator (also called a system phone user), an **S** on the phone's display indicates a system alarm message. While you are not expected to be able to fix the error causing the alarm, the error message allows you to report the problem to your system maintainer.

- **Memory Card Failure**
There is a problem with one of the memory cards used by the telephone system. Selecting Admin will take you to the system administration menu where you can check the [status of the memory cards](#)^[132].
- **Expansion Failure**
There is a problem with one of the external expansion modules attached to the telephone system.
- **Voicemail Failure**
The voicemail system is not available.
- **Voicemail Almost Full**
The voicemail system is nearly out of storage space for any more messages, prompts and recordings.
- **Voicemail Full**
The voicemail system cannot store any more messages, prompts and recordings.
- **Licence Key Failure**
There is a problem with the memory card used to license features and applications.
- **System Boot Error**
The telephone system has encountered an error while restarting.
- **Corrupt Date/Time**
There is an error in the date or time being used by the system. Selecting **Admin** will take you to the system administration menu where you can change the [date](#)^[128] and [time](#)^[130].

Chapter 21.

Menus

21. Menus

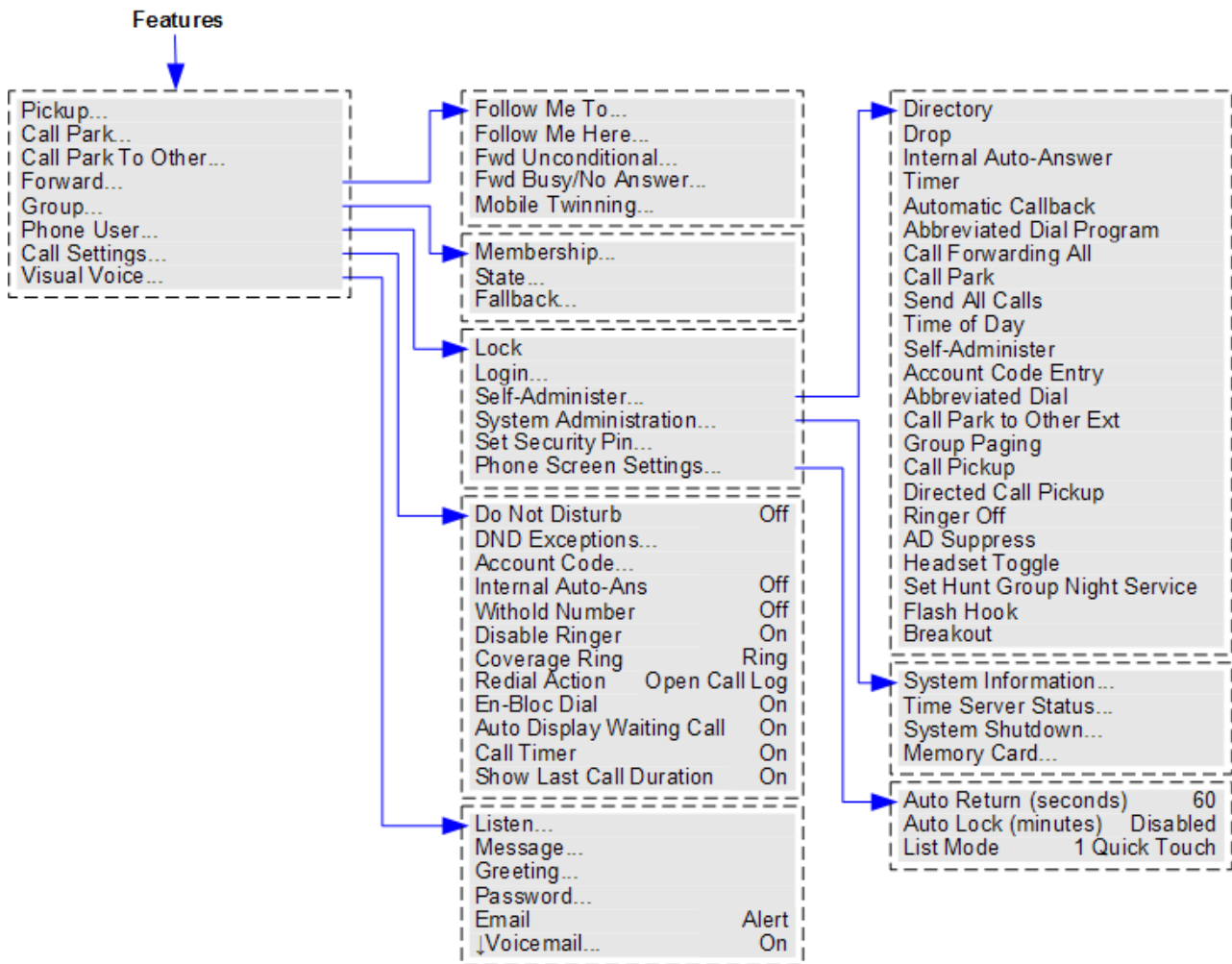

21.1 Features Menu

This menu is accessed by pressing the **Features** soft key. It can be used to access a range of user settings.



To exit the whole user menu and return to the appearance menu, press the  **PHONE/EXIT** button or, if displayed, press the **Exit** soft key.

Within the menu, the  up and down  arrows keys are used to scroll through menu options.

When the menu option displayed has sub menus, that is indicated by the ... 3 dots (ellipsis) icon after the menu option name. Except where they are being used to change the value of a setting (see below), the  left and right  arrow keys can be used to exit and enter sub-menus.

Entering a sub-menu can also be done by pressing the **Select** soft key or the **OK** button. Exiting a sub-menu can also be done by pressing the **Back** soft key.

! The system administrator controls whether you can access some of the menus. Others are only available if certain prerequisites are met:

- While the phone is [locked](#) ^[70], the **Features** menu cannot be accessed to change user settings.
- The system administrator is able to configure if you can access the **Membership**, **State** and **Fallback** options of a group. If you are not configured for any groups then the **Group** menu is not shown.
- The system administrator is able to configure whether you can access the **Forward** and **Follow Me** menu and status options.
- The **Park** menu and status options are only accessible while you are talking to a caller or already have parked calls.
- The **Account Code** menu is only accessible if the system has been configured with accounts codes.
- The **Mobile Twinning** options are only shown if you have been configured to use mobile twinning.
- The **System Administration** option is only shown if you have been configured as a 'System Phone' user.

21.2 Status Menu

This menu is accessed by pressing the **Status** soft key when displayed.

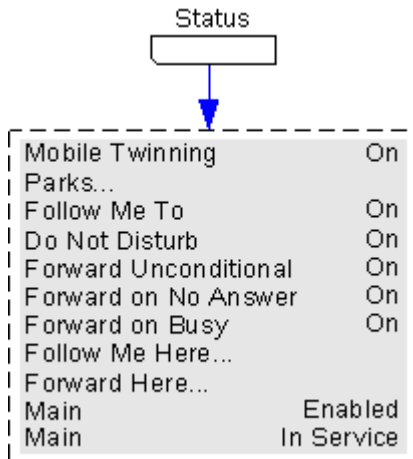

21.3 A Menu

This menu is used mainly for phone specific settings that are stored by the phone rather than settings that are stored by the phone system and move with you when you login on another phone.

The menu is accessed by pressing the **A** key. On some phones, press the **A** key and then select  **Settings**.

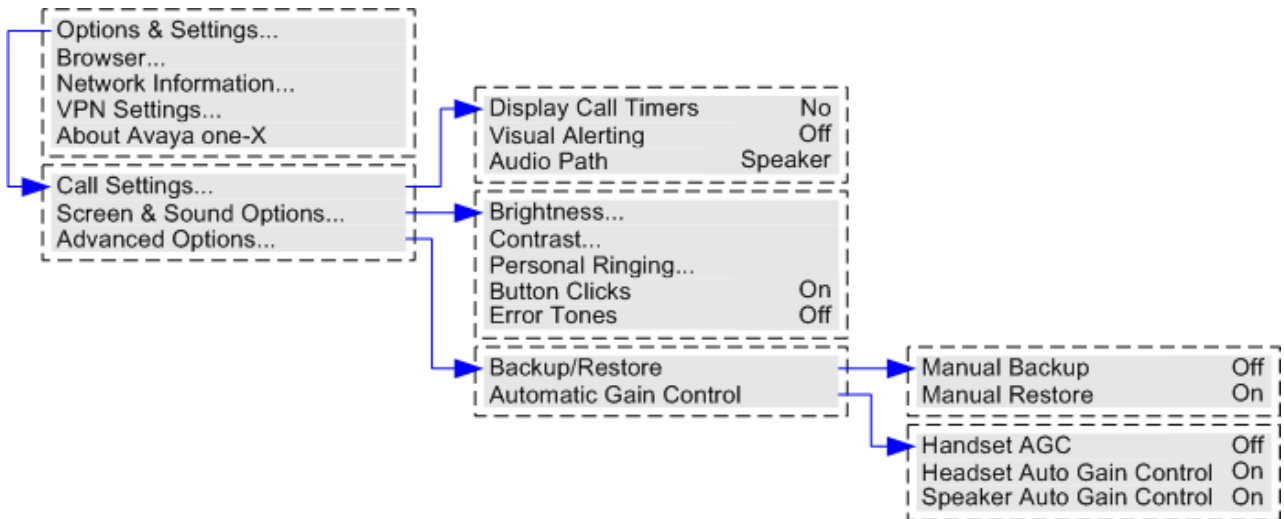

- **Options & Settings...**
This option is used to access a number of menus relating to phone settings.
- **Browser...**
This option is present if your system maintainer has setup access to a WML website. On touch screen phones, it is replaced by a **Web Applications** icon on the home screen.
- **Network Information...**
This option is used to display a range of IP network settings.
- **VPN Settings...**
Do not use this menu unless advised by your system maintainer. They will tell you the settings to use if your phone is connected via a VPN connection.

Chapter 22.

Glossary

22. Glossary

22.1 Abbreviated Ring

A single non-repeated ring. By default this is the type of ring used when another call alerts you when you already have a call in connected.

22.2 Appearance Button

Appearance buttons are used to represent calls made and received by you and other users on the telephone system. They are configured by your system administrator. Normally your first 3 buttons are call appearance buttons but additional buttons can be configured as appearance buttons.

22.3 Attention Ring

Your system administrator can set what ringing should be used if another call alerts you when you already have a call connected. The options are a single non-repeated ring (abbreviated ring) or no ring.

22.4 Auto Hold

By default, when you have a connected call in progress, if you press another appearance button, the connected call is automatically put on hold. Without auto-hold, the connected call is ended when you press another appearance button.

22.5 Bridged Appearance Button

A bridged appearance button shows the state of one of another user's call appearance buttons. It can be used to answer or join calls on that other user's call appearance button. It can also be used to make a call that the call appearance user can then join or retrieve from hold.

- When the user's call appearance button alerts, your matching bridged appearance button also alerts. The bridged appearance button can be used to answer the call on the call appearance button user's behalf.
- When the call appearance button user answers or makes a call using that call appearance, your matching bridged appearance button show the status of that call, for example connected, on hold, etc. The bridged appearance button can be used to retrieve the call if on hold or to join the call if active.
- Bridged appearance buttons are not supported between users on different systems in a [Small Community Network](#) ^[143].

22.6 Call Appearance Button

Call appearance buttons are used to display calls to and from your phone. By having several call appearance buttons, you are able to answer and make several calls, switch between calls and perform other actions.

When all your call appearance buttons are in use, any further calls to your number follow your forward on busy setting if set or otherwise go to voicemail if available.

22.7 Call Coverage Button

Each call coverage button is associated with another user on your telephone system. The button allows you to be alerted when that user has an unanswered call still ringing. You can view the details of the call and answer it if required.

The settings of the user being covered control how long it rings at their phone before it also starts alerting on your call coverage button for that user. Call coverage appearance buttons are not supported between users on different systems in a Small Community Network.

22.8 Coverage Ring

If you have any bridged appearance and or call coverage buttons, you can [set the type of ringing \(coverage ring\)](#) ^[104] that should be used when a call alerts on any of those buttons. The options are to use normal ringing, a single non-repeated ring (abbreviated ring) or no ring. The coverage ring setting is only used if you do not already have a connected call. If you already have a connected call in progress, the shorter of your coverage ring and the system administrator set attention ring settings is used.

22.9 Do Not Disturb

- When you are in 'do not disturb', your callers are redirected to voicemail if available or otherwise hear busy tone.
- The only people who can call you are those calling from numbers in your do not disturb exceptions list. Forwarding can still be applied to these calls.
- Calls to any hunt group of which you are a member are not presented to you (unless you are the last available member of the group).
- Enabling do not disturb will not affect any calls already being presented to your phone.
- You can still use the phone to make outgoing calls. When you go off-hook you will hear broken dial tone.
- **N = No Calls (Do Not Disturb)**
An **N** is shown after your extension name on the phone's idle display when you have do not disturb enabled.

22.10 Do Not Disturb Exceptions

- These are numbers for caller's who can call you even when you are set to do not disturb. This only applies for calls to you. It does not apply for calls to a hunt group of which you are a member.

22.11 Follow Me

Follow me to is used to redirect your calls to another extension where you will be working.

The calls are presented with your user name so that they can be distinguished from calls for the extensions normal user. This allows you to share another person's phone without logging them off their phone.

The calls are still subject to all your user settings as if they were ringing at your phone.

All calls are redirected.

22.12 Follow Me Here

Follow here the function used to enable follow me at the extension to which you want your calls redirected.

22.13 Follow Me To

Follow me to is the function used to enable follow me from your own phone.

22.14 Forward on Busy

Forward on busy redirects your calls when your phone is not able to present you with any more alerting calls.

- By default this function is only applied to incoming external calls to you. However, if required internal calls can also be selected.
- When enabled, all calls matching the settings are forwarded to the number set as the forward on busy/no answer destination. That number can be internal or external.
- Busy is defined as having no available call appearance buttons on which further calls can be presented.
- Hunt group calls are not presented when you are busy and so are not forwarded by this setting.
- The forward on busy and forward on no answer options use the same forwarding destination number. If no number is set, they use the same destination as set for forward unconditional.
- If you have [voicemail enabled](#) ^[66], the telephone system will attempt to redirect forwarded calls to voicemail if they are still unanswered after having rung for your no answer time (default 15 seconds). This is not always possible for calls that have been forwarded to an external number.

22.15 Forward on No Answer

Forward on no answer redirects calls that have alerted your phone but have not been answered for some reason.

- By default this function is only applied to incoming external calls to you. However if required internal calls can also be selected.
- When enabled, all calls matching the settings are forwarded to the number set as the forward on busy/no answer destination. That number can be internal or external.
- No answer is defined as having been presented to your phone for your no answer time (default 15 seconds).
- Hunt group calls are not forwarded.
- The forward on busy and forward on no answer options use the same forwarding destination number. If no number is set, they use the same destination as set for forward unconditional.
- If you have [voicemail enabled](#) ^[66], the telephone system will attempt to redirect forwarded calls to voicemail if they are still unanswered after having rung for your no answer time (default 15 seconds). This is not always possible for calls that have been forwarded to an external number.

22.16 Forward Unconditional

Forward unconditional can be used to immediately redirect your calls.

- By default this function is only applied to incoming external calls to you. However, if required internal calls and or hunt group calls can also be selected.
- When enabled, all calls matching the settings are forwarded to the number set as the forward unconditional destination. That number can be internal or external.
- You can still use the phone to make outgoing calls. When you go off-hook you will hear broken dial tone.
- The forward on busy and forward on no answer options use the same forwarding destination number. If no number is set, they use the same destination as set for forward unconditional.
- If you have [voicemail enabled](#) ^[66], the telephone system will attempt to redirect forwarded calls to voicemail if they are still unanswered after having rung for your no answer time (default 15 seconds). This is not always possible for calls that have been forwarded to an external number.

- **D = Diverting (Forwarding) Calls**

A **D** is shown after your extension name on the phone's idle display when you have forward unconditional enabled.

22.17 Group

Your system administrator can include you as a member of a group along with other users. Each group has its own extension number which can be used as the destination for call.

When a call is presented to a group, it is presented to the available group members, either one at a time or all at the same time, until answered by one of the members.

How long a group call will ring at each group member before being presented to the next member is controlled by the group's own settings. Hunt groups also use voicemail and have their own settings for when an unanswered call should go to the group's mailbox. For group calls, the hunt group's voicemail settings are used rather than your settings.

22.18 Idle Line Preference

Having one of your phone's call or line appearance buttons set as the currently selected appearance button, means it will be the appearance button used when you go off hook. If this was not the case, you would need to select an appearance button before going off hook.

Idle line preference automatically selects the first available call appearance or line appearance button as your currently selected button when you do not have a call connected.

22.19 Internal Twinning

This method of twinning twins your normal phone with another internal phone. Your incoming calls will ring on both phones. You can also make your calls from either extension.

A typical example for internal twinning would be a user who uses both a normal desk phone and also needs a mobile phone while moving around the building.

Your settings are applied to both phones. Similarly message waiting indication and voicemail access from either phone will be to your mailbox.

If both phones are phones that store your contacts and call history on the system, the contacts and call history on each will be the same.

22.20 Line Appearance Button

Line appearance buttons allow you to make and receive calls on a specific telephone line connected to your telephone system. The button also allows you to see when the line is in use by other users.

For incoming calls, the telephone system still determines the destination for the call. That may be a user or group. However, if you have a line appearance button for the line, you will see that there is a call alerting and can answer it if required.

- **Private Lines**

Special behaviour is applied to calls where the user has both a line appearance for the line involved and is also the Incoming Call Route destination of that call. Such calls will alert only on the Line Appearance button and not on any other buttons. These calls will also not follow any forwarding.

22.21 Logged Out

If you are logged out from any phone, you are treated as being busy to receiving any calls. Callers follow your forwarding settings if set or go to voicemail if available.

22.22 Login Code

You can use a login code to login at any phone on the telephone system and then use that phone as your own. While logged in, you can use the phone's menus to set and change your login code.

22.23 Missed Call

Missed calls are calls that ring at your phone but are not answered by you. Your 10 most recent missed calls are included in your call log.

The system administrator can configure whether missed calls should include calls that you did not answer but where answered for you by another user. For example by a user with a call coverage button set for your calls. If this mode is enabled, it will also include calls that were answered by your voicemail.

22.24 Missed Group Call

The system administrator can configure whether the telephone system should keep an internal log of missed hunt group calls. They can then also set which groups of which you are a member, should have their missed calls shown as part of your missed calls call log. This does not require the group call to have been presented to you and missed.

22.25 Mobile Twinning

Mobile twinning is [twinning](#)^[143] where your calls ring at both your phone and at another number which can include an external number. If you have been configured as a mobile twinning user, you can switch use of mobile twinning on or off through the phone's menus and also change the number to which you are twinned.

22.26 Park Call

Parking a call is similar to holding a call. However parked calls can be retrieved by other users on the telephone system.

A call that you park and leave parked for too long will recall to your phone. The recall will ignore any do not disturb and forwarding settings, recalling to the phone from which it was parked.

22.27 Park Slot Number

If you park a call without specifying a park slot number, the system will assign a number based on your extension number plus a single digit. For example for extension 201, the first parked call will use park slot number 2010 if available. If you already have one parked call, the next parked call will use park slot 2011 if available.

Call park buttons can be configured with a specific park slot numbers. A calls parked using that button will be given that park slot number. Any other users with a call park button set to the same number will see that there is a parked call and can unpark it using their button.

22.28 Ringing Line Preference

This setting is controlled by your system administrator and is normally on. When you are not connected to a call, if you receive an incoming call, ringing line preference will make the alerting appearance button your selected appearance button. You can answer the call on the selected appearance button by lifting the handset or pressing the Headset or Speaker button.

Without ringing line preference, to answer the call on the alerting appearance button you must press the appearance button to select it manually.

22.29 Short Codes

Short codes are numbers that you can dial to enable and disable various features. The following are default short codes that may be available. Your system administrator will confirm any additional short codes that they may have configured for your use.

22.30 Small Community Network

Several IP Office telephone systems can be connected together to form a Small Community Network. You can then dial the user on other systems in the same way as for internal calls on your own system. The remote users are listed in the directory.

The system administrator can also configure which hunt groups are accessible across the network. You may also be able to hot desk to a phone located on another system in the network.

22.31 System Administrator

The system administrator is able to make or arrange changes to the telephone system configuration. They are able to see and change most of your user settings.

22.32 System Phone User

Your system administrator can configure some user's as system phone users. They will be able to access a range of additional functions such as changing the system date and time. A system phone user is able to add, edit and delete system directory entries.

22.33 Twinning

Twining is a process whereby your calls ring on two phones. Twinning is only available if configured by the system administrator.

There are two methods of twinning supported, [internal twinning](#)^[142] and [mobile twinning](#)^[142].

Index

A

Abbreviated ring 104, 140
 Access Control
 Fallback 87, 88, 89, 90, 121
 Follow Me 75, 76, 77, 79, 80, 81, 118, 119, 120
 Forward 75, 76, 77, 79, 80, 81, 118, 119, 120
 Membership 87, 88, 89, 90, 121
 State 87, 88, 89, 90, 121
 Add
 Contact 53, 59
 External contact 50, 53, 54
 to conference call 42
 Alarm 122, 133
 All
 Call Log 24, 53, 57, 58, 59
 Contacts 24, 51, 52
 Forward 79, 120
 All Calls 79, 120
 Almost Full 122, 133
 A-Menu 100, 138
 Answered 24, 53, 57, 58, 59
 Attention Ring 103, 105
 Audio Path 46, 47, 114
 Auto-Answer 106
B
 B 17
 Backup
 Manual backup 115
 Barred 17
 BM32 18
 Boot Error 122, 133
 Bridged appearance
 Coverage ring 104, 140
 broken dial tone 77, 82, 140, 141
 Busy
 Forward 80, 81, 119, 120
 Button Module 18
C
 Call
 from Call Log 24, 57
 from Contacts 24, 52
 from redial list 25, 32
 Call coverage
 Coverage ring 104, 140
 CALL LOG 24, 53, 57, 58, 59
 Call from 24, 57
 Details 58
 Menu 56
 Call Settings 22, 25, 32, 40, 83, 101, 102, 104, 108, 109, 110
 Audio Path 46, 47, 114
 Auto-Answer 106
 Internal Auto-Answer 106
 Visual alerting on/off 104
 Withhold number 25, 101
 Call Waiting 110
 Caller
 Details 58
 Conference
 Add call 42
 Caller details 42, 43
 Drop caller 42, 43
 End automatically 35, 38, 43
 Hold 35, 43

 Last internal user 35, 38, 43
 Music on hold 35, 43
 Contact
 Add 53, 59
 add external 50, 53, 54
 delete external 50, 53, 54
 Edit 53, 54
 edit external 50, 53, 54
 CONTACTS 24, 50, 51, 52, 53, 54
 Make call 24, 52
 Corrupt Date/Time 122, 133
 Count 58
 Coverage ring 103, 104, 105, 140
 CPKUp 36, 122
D
 D 17, 77, 141
 Date 129
 Daylight Saving 129
 Delete
 External contact 50, 53, 54
 Follow me here 76, 119
 Details
 Call Log 58
 Dial tone
 Broken 77, 82, 140, 141
 Directory
 Add 53, 59
 add external 50, 53, 54
 delete external 50, 53, 54
 Edit 53, 54
 edit external 50, 53, 54
 Make call 24, 52
 Display
 Call Waiting 110
 Divert
 To voicemail 29, 66
 Diverting 17, 77, 141
 Do Not Disturb 17, 82, 140
 Off 83, 118
 Status 83, 118
E
 Edit
 Contact 53, 54
 External contact 50, 53, 54
 Follow me here 76, 119
 En-bloc 22, 102
 En-Bloc Dial 22, 102
 Expansion Failure 122, 133
 External 24, 51, 52
 Forward 79, 120
 Forward on Busy 80, 81, 119, 120
 External and Group 79, 120
 External Calls 103, 105
 external directory 50, 53, 54
 External Only 79, 120
F
 Failure 122, 133
 Features
 Menu 136
 Follow me here
 Clear 76, 119
 Edit 76, 119
 Off 119
 Status 119
 Follow Me To

Follow Me To
 Off 76, 118
 Status 76, 118
 Forward
 All Calls 79, 120
 External and Group 79, 120
 External Only 79, 120
 Non Group Calls 79, 120
 Off 79, 120
 on Busy 80, 81, 119, 120
 Forward on Busy
 Off 81, 119
 Status 81, 119
 Forward on No Answer
 Off 80, 120
 Status 80, 120
 Forward Unconditional 79, 120
 Off 79, 120
 Status 79, 120
 Forwarded to Here
 Off 120
 Status 120
 Forwarding 17, 77, 141
 Full 122, 133
 Fwd To Here 120
G
 G 17
 Group
 Call log 56
 Forward 79, 120
 Membership status 87, 121
 Missed 56
 Service status 88, 89, 121
 Group Member 17
 Groups 24, 51, 52
H
 Handset
 Volume 113
 Headset
 Volume 46, 113
 Held call
 Transfer 35, 38, 43
 Hold
 Conference 35, 43
 Transfer 35, 38, 43
 Hunt group
 Call log 56
 Forward 79, 120
 Membership status 87, 121
 Missed 56
 Service status 89, 121
I
 In Service 88, 89, 121
 Internal Auto-Answer 106
 Internal Calls 103, 105
L
 Lamp 104
 List 32, 101
 Local Time 129
 Login 69
M
 Make call
 from Call Log 24, 57
 from Contacts 24, 52
 from redial list 25, 32
 Manual
 Restore 115
 Memory Card Failure 122, 133
 Menu
 A-Menu 100, 138
 Call log 56
 Contacts 50
 Features 136
 Status 137
 Status menu 118
 Message waiting lamp 104
 Missed 24, 53, 57, 58, 59
 Missed calls
 Hunt group calls 56
 Mobile Twinning
 Number 84, 101
 Off 121
 On/Off 84, 101
 Status 121
 More 57, 58, 63, 64
 Music on hold 35, 43
N
 N 17, 82, 140
 New
 Contact 53, 59
 Night Service
 Automatic 88, 89, 121
 No answer
 Forward status 80, 120
 No Calls 17, 82, 140
 No ring 104, 140
 Non Group Calls 79, 120
O
 O 17, 88
 One 32, 101
 OOS 88, 89, 121
 Out of Service 17, 88, 89, 121
 Outgoing 24, 53, 57, 58, 59
P
 Parked calls
 Status 36, 122
 Password 69
 Personal 24, 51, 52
 Phone User 70, 71, 93, 102, 110, 111, 128, 129, 130, 131, 132
R
 R 17
 Reason 58
 Redial 25, 32
 List 25, 32
 Redial mode 32, 101
 Resilience 17
 Restore 115
 Ring
 Attention Ring 103, 105
 Coverage Ring 103, 105
 External Calls 103, 105
 Internal Calls 103, 105
 Ringback 103, 105
 Ring Time 58
 Ringback 103, 105
 Ringer
 Volume 106, 112

S

- S 17
- SBM32 18
- Send All Calls 79, 120
- Speaker
 - Volume 47, 113
- Status
 - Do Not Disturb 83, 118
 - Follow Me here 119
 - Follow Me To 76, 118
 - Forward on Busy 81, 119
 - Forward on No Answer 80, 120
 - Forward unconditional 79, 120
 - Forwarded to Here 120
 - Group membership 87, 121
 - Group service status 89, 121
 - Hunt group service status 89, 121
 - Membership 87, 121
 - Menu 137
 - Mobile twinning 121
 - Parked calls 36, 122
 - Service status 89, 121
- Status menu 118
- System Administrator 122, 133
- System Alarm 17, 122, 133
- System Boot Error 122, 133
- System Phone 50, 53, 54, 122, 133

T

- T 17, 84
- Time 129
- Time profile 88, 89, 121
- Time Server 129
- Transfer
 - Held call 35, 38, 43
 - To voicemail 29, 38, 66
- Twinned 17, 84
- Twinning
 - Number 84, 101
 - Off 121
 - On/Off 84, 101
 - Status 121

U

- Users 24, 51, 52
- UTC Time 129

V

- Visual Alerting 104
- Voicemail
 - Transfer 29, 38, 66
- Voicemail Almost Full 122, 133
- Voicemail Failure 122, 133
- Voicemail Full 122, 133
- Volume
 - Handset 113
 - Headset 46, 113
 - Ringer 106, 112
 - Speaker 47, 113

W

- Waiting Call 110
- Withhold Number 25, 101

Performance figures and data quoted in this document are typical, and must be specifically confirmed in writing by Avaya before they become applicable to any particular order or contract. The company reserves the right to make alterations or amendments to the detailed specifications at its discretion. The publication of information in this document does not imply freedom from patent or other protective rights of Avaya or others.

All trademarks identified by the ® or ™ are registered trademarks or trademarks, respectively, of Avaya Inc. All other trademarks are the property of their respective owners.

This document contains proprietary information of Avaya and is not to be disclosed or used except in accordance with applicable agreements.

© 2011 Avaya Inc. All rights reserved.