

APPLICABILITY

This manual is applicable to Piper Model PA-28-180 aircraft having serial numbers 28-7405001 through 28-7505259. Contact Piper Customer Services for specific information on the application of this manual.

REVISIONS

The information compiled in the Pilot's Operating Manual will be kept current by revisions distributed to the airplane owners.

Revision material will consist of information necessary to update the text of the present manual and/or to add information to cover added airplane equipment.

I. Revisions

Revisions will be distributed whenever necessary as complete page replacements or additions and shall be inserted into the manual in accordance with the instructions given below:

1. Revision pages will replace only pages with the same page number.
2. Insert all additional pages in proper numerical order within each section.
3. Page numbers followed by a small letter shall be inserted in direct sequence with the same common numbered page.

II. Identification of Revised Material

Revised text and illustrations shall be indicated by a black vertical line along the left hand margin of the page, opposite revised, added or deleted material. A line opposite the page number or section title and printing date, will indicate that the text or illustration was unchanged but material was relocated to a different page or that an entire page was added.

Black lines will indicate only current revisions with changes and additions to or deletions of existing text and illustrations. Changes in capitalization, spelling, punctuation or the physical location of material on a page will not be identified by symbols.

III. Original Pages Issued

The original pages issued for this manual prior to revision are given below:

1-1 through 1-3, 2-1 through 2-18, 3-1 through 3-18, 4-1 through 4-6, 5-1 through 5-27, 7-1 through 7-10, 8-1 through 8-2, 9-1 through 9-10, 10-1 through 10-15.

PILOT'S OPERATING MANUAL LOG OF REVISIONS (cont)

Revision	Revised Pages	Description	Date
Rev. 3 (cont)	9-i 9-2 9-3 9-4 9-5 9-6 9-7 9-8 9-9 9-10 10-11	Revised Performance Charts Index. Revised Takeoff Chart. Revised Climb Chart. Revised Range Chart. Revised Engine Chart. Revised Airspeed Chart Revised Stall Speed vs Weight Chart. Revised Stall Speed vs Angle of Bank Chart. Revised Glide Chart. Revised Landing Chart. Revised Battery Service.	
Rev. 4 - 761 556 (PR750120)	1-2 2-1 AF/M W/B 7-4 7-8 8-2 10-8	Added 0-360-A4M engine designation and footnote. Added 0-360-A4M engine designation and footnote. Added Rev. 3 to Report: VB-558. Added Rev. 4 to Report: VB-547. Added new item 9.; revised existing item nos. under TAKEOFF. Revised ELT info. Added item 11. Added 0-360-A4M engine designation under Oil Requirements.	Jan. 20, 1975
Rev. 5 - 761 556 (PR751121)	iii 1-1 1-2 2-1 AF/M W/B 8-1 9-4 9-6	Added concluding ser. no. to Applicability. Revised Cruise Speed and Range figures; revised Empty Weight and Useful Load; deleted footnote. Deleted footnote. Revised Airframe info; deleted footnote. Added Rev. 4 to Report: VB-558. Added Rev. 5 to Report: VB-547. Revised item 8 (Fuel Warning Tip). Revised Cruise Performance - Range chart. Revised Cruise Performance - True Airspeed chart.	Nov. 21, 1975
Rev. 6 - 761 556 (PR790326)	2-8 2-8a 2-14 W/B 7-2 7-8,7-9	Added Warning. Added info. Added Caution. Added Rev. 6 to Report: VB-547. Revised items. Revised ELT info.	March 26, 1979

TABLE OF CONTENTS

GENERAL SPECIFICATIONS
DESCRIPTION - AIRPLANE AND SYSTEMS
AIRPLANE FLIGHT MANUAL F.A.A. APPROVED
EMERGENCY PROCEDURES F.A.A. APPROVED
EMERGENCY PROCEDURES
WEIGHT AND BALANCE
LOADING INSTRUCTIONS
OPERATING INSTRUCTIONS
OPERATING TIPS
PERFORMANCE CHARTS
HANDLING AND SERVICING

BLANK PAGE

GENERAL SPECIFICATIONS

Performance	1-1
Weights	1-1
Power Plant	1-2
Fuel and Oil	1-2
Baggage	1-2
Dimensions	1-2
Landing Gear	1-2

BLANK PAGE

GENERAL SPECIFICATIONS

PERFORMANCE

Published figures are for standard airplanes flown at gross weight under standard conditions at sea level, unless otherwise stated. Performance for a specific airplane may vary from published figures depending upon the equipment installed, the condition of engine, airplane and equipment, atmospheric conditions and piloting technique. Each performance figure below is subject to the same conditions as on the corresponding performance chart from which it is taken in the Performance Charts Section.

Takeoff Ground Run, 25° flaps, sea level (ft)	720
Takeoff Distance Over 50-ft Obstacle, 25° flaps, sea level (ft)	1625
Best Rate of Climb Speed (mph)	85
Rate of Climb (ft per min)	725
Best Angle of Climb Speed, sea level (mph)	76
Max Speed, sea level (mph)	148*
Max Speed Optimum Altitude 9300 ft., 75% power (TAS) (mph)	141*
Service Ceiling (ft)	14,150
Absolute Ceiling (ft)	16,500
Cruise Speed at best power mixture (mph)	
65% power, 12,800 ft	132*
60% power, 14,000 ft	125*
Range at best power mixture (mi)**	
75% power, 9300 ft	645
65% power, 12,800 ft	705
Cruise speed at best economy mixture (mph)	
75% power, 9300 ft	131*
65% power, 12,600 ft	123*
Range at best economy mixture (mi)**	
75% power, 9300 ft	715
65% power, 12,600 ft	774
Stalling Speed, flaps down (CAS) (mph)	61
Stalling Speed, flaps up (CAS) (mph)	68
Landing Roll, sea level, flaps down (ft)	635
Landing Distance Over 50-ft Obstacle, sea level (ft)	1185

* All speeds stated are with optional wheel fairings installed. Subtract 3 mph if wheel fairings are not installed.

** No reserve.

WEIGHTS

Gross Weight (lbs)	2450
Standard Empty Weight (lbs)	1404
Maximum Useful Load (lbs)	1046

CHEROKEE ARCHER

POWER PLANT

Engine (Lycoming)	O-360-A4A or O-360-A4M
Rated Horsepower	180
Rated Speed (rpm)	2700
Bore (inches)	5.125
Stroke (inches)	4.375
Displacement (cubic inches)	361.0
Compression Ratio	8.5:1
Dry Weight (pounds)	285
Propeller	76EM8S5-0-60

FUEL

AVGAS ONLY

Fuel Capacity (U.S. gal) Usable	48
Fuel, Aviation Grade (min octane)	100/130

OIL

Oil Capacity (qts)	8
--------------------	---

BAGGAGE

Maximum Baggage (lbs)	200
Baggage Space (cubic ft)	24
Baggage Door Size (in.)	20 x 22

DIMENSIONS

Wing Span (ft)	32
Wing Area (sq ft)	170
Wing Loading (lbs per sq ft)	14.4
Length (ft)	24.0
Height (ft)	7.8
Power Loading (lbs per hp)	13.6

LANDING GEAR

Wheel Base (ft)	6.7
Wheel Tread (ft)	10
Tire Pressure (psi)	Nose 24
	Main 24
Tire Size	Nose (4 ply rating) 6.00 x 6
	Main (4 ply rating) 6.00 x 6

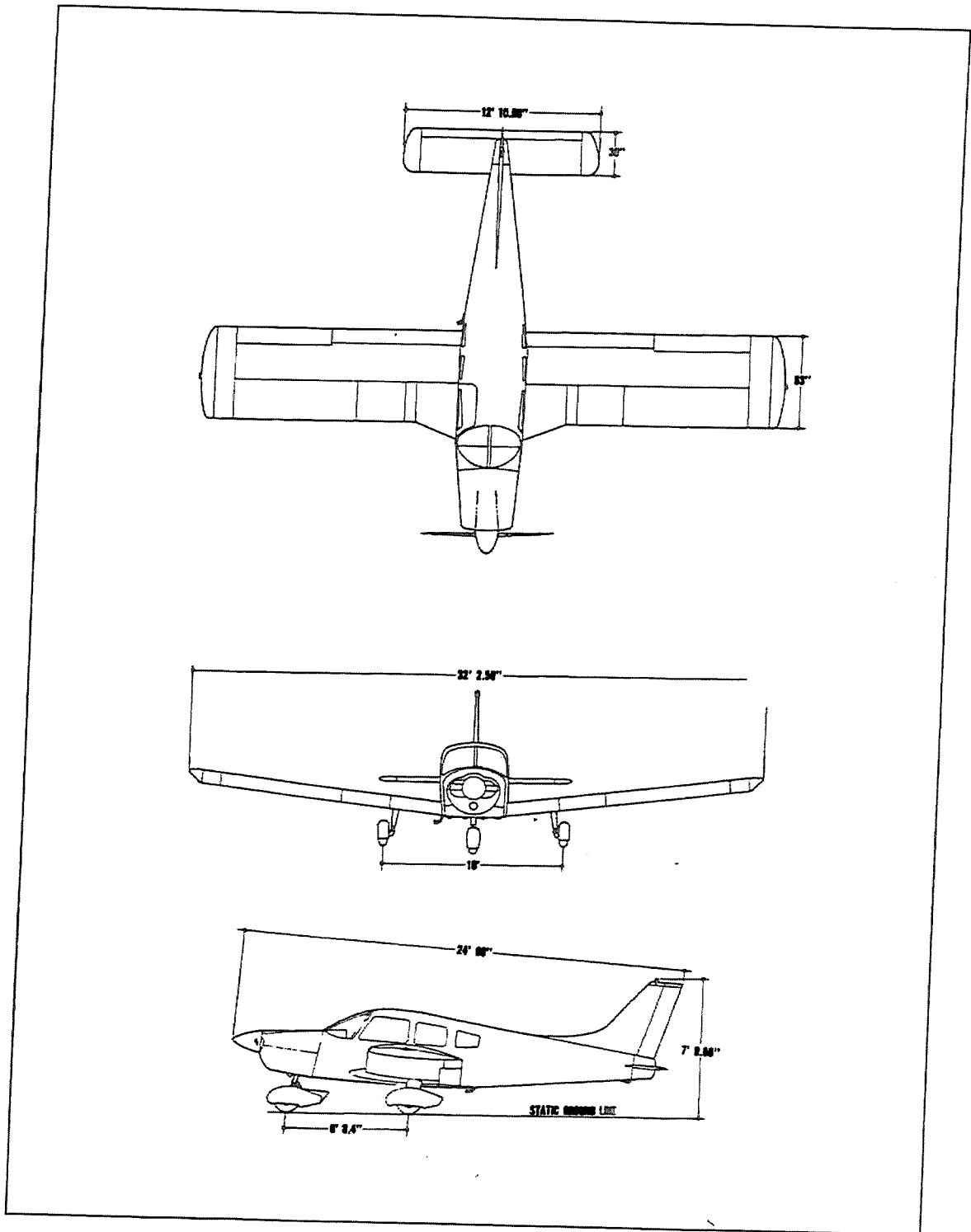

GENERAL SPECIFICATIONS
ISSUED: JULY 9, 1973

BLANK PAGE

DESCRIPTION

AIRPLANE AND SYSTEMS

The Airplane	2-1
Airframe	2-1
Engine and Propeller	2-1
Landing Gear	2-3
Flight Controls	2-3
Fuel System	2-4
Electrical System	2-6
Vacuum System	2-9
Instrument Panel	2-9
Pitot-Static System	2-12
Heating and Ventilating System	2-12
Cabin Features	2-14
Baggage Area	2-14
Stall Warning	2-14
Finish	2-14
Air Conditioning	2-15
Piper External Power	2-16

BLANK PAGE

DESCRIPTION

AIRPLANE AND SYSTEMS

The Airplane	2-1
Airframe	2-1
Engine and Propeller.....	2-1
Landing Gear	2-3
Flight Controls.....	2-3
Fuel System.....	2-4
Electrical System	2-6
Vacuum System.....	2-9
Instrument Panel	2-9
Pitot-Static System.....	2-12
Heating and Ventilating System.....	2-12
Cabin Features	2-14
Baggage Area.....	2-14
Stall Warning.....	2-14
Finish.....	2-14
Air Conditioning.....	2-15
Piper External Power	2-16

DESCRIPTION

AIRPLANE AND SYSTEMS

THE AIRPLANE

The PA-28-180 Cherokee is a single-engine, low-wing monoplane of all metal construction. Its full 4-place seating, two hundred pound baggage capacity, 645 mile range and economical operation, coupled with the lively performance of a 180 horsepower engine, make this Cherokee a versatile airplane in the business and personal aviation fields.

AIRFRAME

The **basic airframe**, except for a tubular steel engine mount, steel landing gear struts and other miscellaneous steel parts, is of aluminum alloy construction. The extremities - the wing tips, the cowling, the tail surfaces - are of tough fiberglass.

The **wings** are attached to each side of the fuselage by insertion of the butt ends of the respective main spars into a spar box carry-through which is an integral part of the fuselage structure, providing, in effect, a continuous main spar with splices at each side of the fuselage. There are also fore and aft attachments at the rear spar and at an auxiliary front spar.

The **wing airfoil section** is a laminar flow type, NACA65₂-415 with the maximum thickness about 40% aft of the leading edge. This permits the main spar carry-through structure to be located under the rear seat, providing unobstructed cabin floor space ahead of the rear seat.

ENGINE AND PROPELLER

The Cherokee 180 is powered by a Lycoming O-360-A4A or O-360-A4M four cylinder, direct drive, horizontally opposed engine rated at 180 horsepower at 2700 rpm. It is furnished with a starter, a 60 ampere, 14 volt alternator, a shielded ignition, vacuum pump drive, a fuel pump, and a dry, automotive type carburetor air filter.

The **exhaust system** is of the cross-over type to reduce back pressure and improve performance. It is made entirely from stainless steel and is equipped with dual mufflers. A heater shroud around the mufflers is provided to supply heat for the cabin and windshield defrosting.

The Sensenich 76EM8S5-0-60 fixed-pitch **propeller** is made from a one-piece alloy forging.

DESCRIPTION
AIRPLANE AND SYSTEMS

THE AIRPLANE

The PA-28-180 Cherokee is a single-engine, low-wing monoplane of all metal construction. Its full 4-place seating, two hundred pound baggage capacity, 645 mile range and economical operation, coupled with the lively performance of a 180 horsepower engine, make this Cherokee a versatile airplane in the business and personal aviation fields.

AIRFRAME

The **basic airframe**, except for a tubular steel engine mount, steel landing gear struts and other miscellaneous steel parts, is of aluminum alloy construction. The extremities - the wing tips, the cowling, the tail surfaces - are of tough fiberglass.

The **wings** are attached to each side of the fuselage by insertion of the butt ends of the respective main spars into a spar box carry-through which is an integral part of the fuselage structure, providing, in effect, a continuous main spar with splices at each side of the fuselage. There are also fore and aft attachments at the rear spar and at an auxiliary front spar.

The **wing airfoil section** is a laminar flow type, NACA65₂-415 with the maximum thickness about 40% aft of the leading edge. This permits the main spar carry-through structure to be located under the rear seat, providing unobstructed cabin floor space ahead of the rear seat.

ENGINE AND PROPELLER

The Cherokee 180 is powered by a Lycoming O-360-A4A or O-360-A4M four cylinder, direct drive, horizontally opposed engine rated at 180 horsepower at 2700 rpm. It is furnished with a starter, a 60 ampere, 14 volt alternator, a shielded ignition, vacuum pump drive, a fuel pump, and a dry, automotive type carburetor air filter.

The **exhaust system** is of the cross-over type to reduce back pressure and improve performance. It is made entirely from stainless steel and is equipped with dual mufflers. A heater shroud around the mufflers is provided to supply heat for the cabin and windshield defrosting.

The Sensenich 76EM8S5-0-60 fixed-pitch **propeller** is made from a one-piece alloy forging.

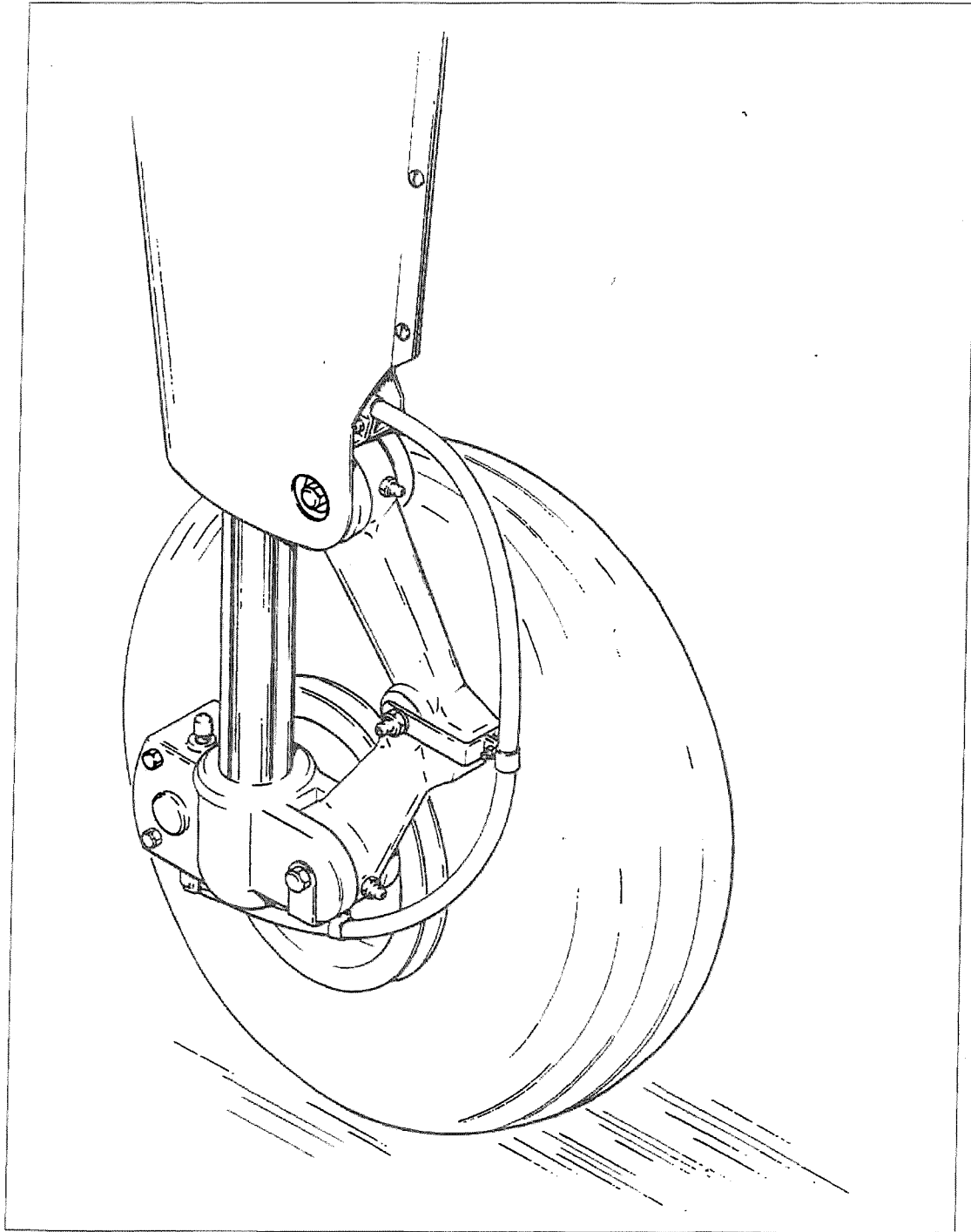

Main Wheel Assembly

LANDING GEAR

The three **landing gears** use Cleveland 6.00 x 6 wheels, the main gear wheels being provided with brake drums and Cleveland single disc hydraulic brake assemblies. All three wheels use 6.00 x 6, four-ply rating, Type III tires with tubes.

The **nose gear** is steerable through a 30 degree arc either side of center by use of the rudder pedals and brakes. A spring device incorporated in the rudder pedal torque tube assembly aids in rudder centering and provides rudder trim. The nose gear steering mechanism also incorporates a bungee assembly to reduce steering effort and to dampen shocks and bumps during taxiing. A shimmy dampener is included in the nose gear.

The three **struts** are of the air-oil type, with a normal extension of 3.25 inches for the nose gear and 4.50 inches for the main gear.

The standard **brake system** for this Cherokee consists of dual toe brakes attached to the rudder pedals and a hand lever and master cylinder located below and behind the left center of the instrument sub-panel. The toe brakes and the hand brake have their own brake cylinders, but they share a common reservoir. The brake fluid reservoir is installed on the top left front face of the fire wall. The **parking brake** is incorporated in the master cylinder and is actuated by pulling back on the brake lever, depressing the knob attached to the left side of the handle, and releasing the brake lever. To release the parking brake, pull back on the brake lever to disengage the catch mechanism and allow the handle to swing forward.

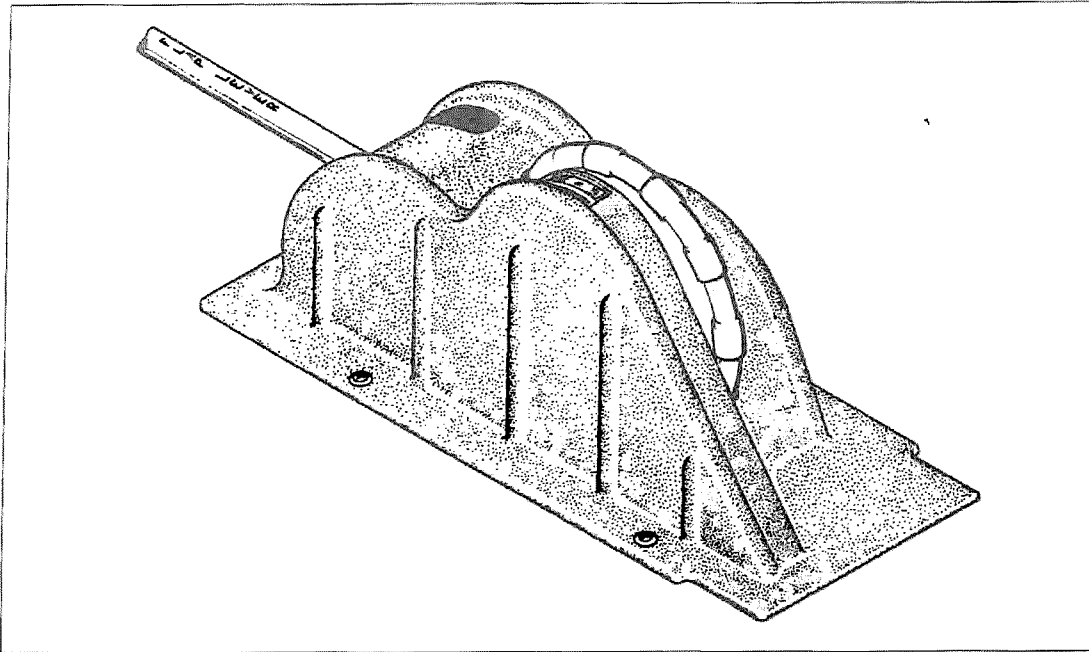

Console

FLIGHT CONTROLS

Dual controls are provided as standard equipment, with a cable system used between the controls and the surfaces. The horizontal tail (**stabilator**) is of the all-movable slab type with a **trim tab** mounted on the trailing edge of the stabilator to reduce the control system forces. This tab is actuated by a control wheel on the floor between the front seats.

The **stabilator** provides extra stability and controllability with less size, drag and weight than conventional tail surfaces. The **ailerons** are provided with a differential action which tends to reduce adverse yaw in turning maneuvers, and which also reduces the amount of coordination required in normal turns. A rudder trim adjustment is mounted on the right side of the pedestal below the throttle quadrant and permits directional trim as needed in flight.

The **flaps** are manually operated, balanced for light operating forces and spring-loaded to return to the up position. A past-center lock incorporated in the actuating linkage holds the flap when it is in the up position so that it may be used as a step on the right side. The flap will not support a step load except when in the full up position, so it must be completely retracted when used as a step. The flaps have three extended positions, 10, 25 and 40 degrees.

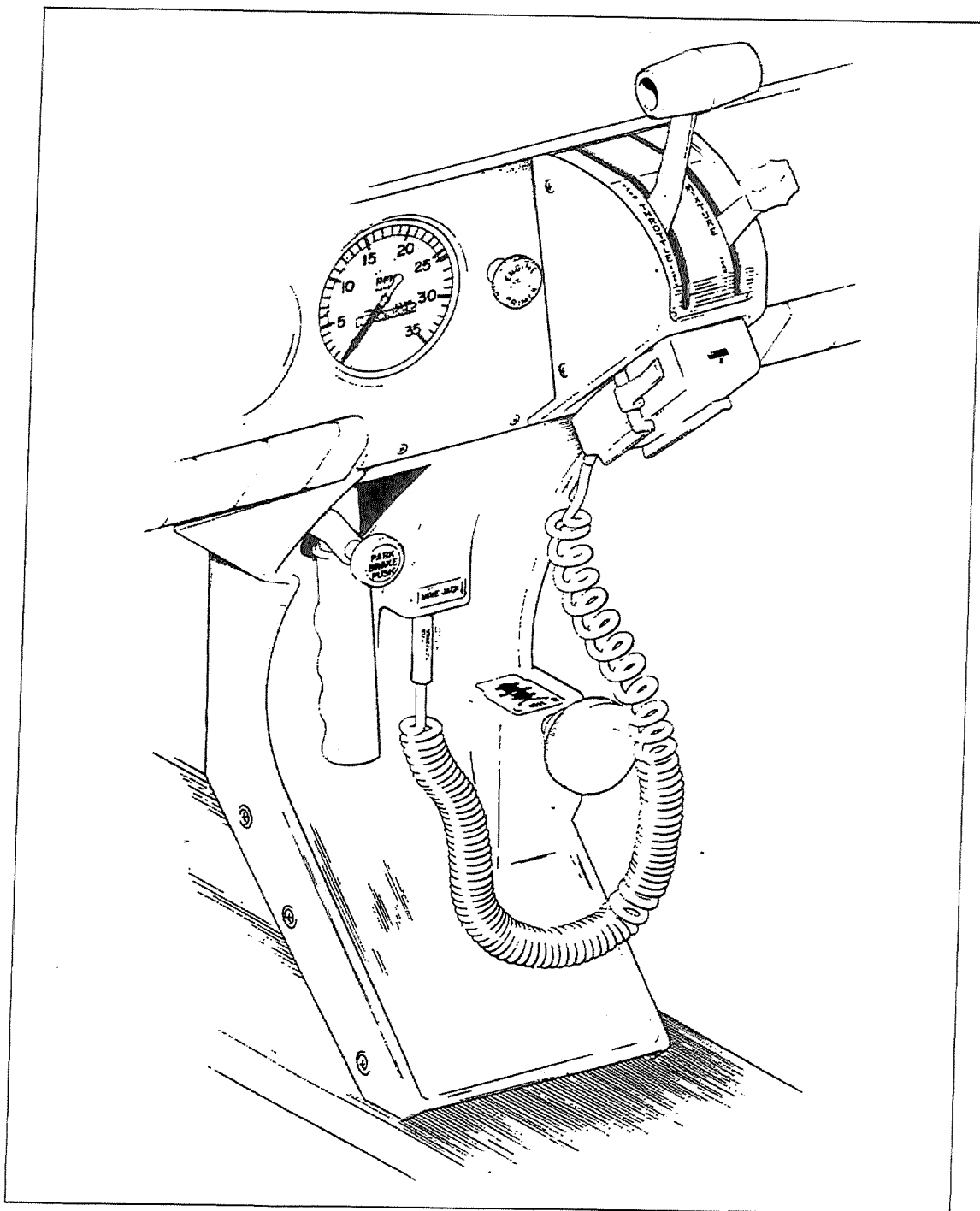

Throttle Quadrant and Console

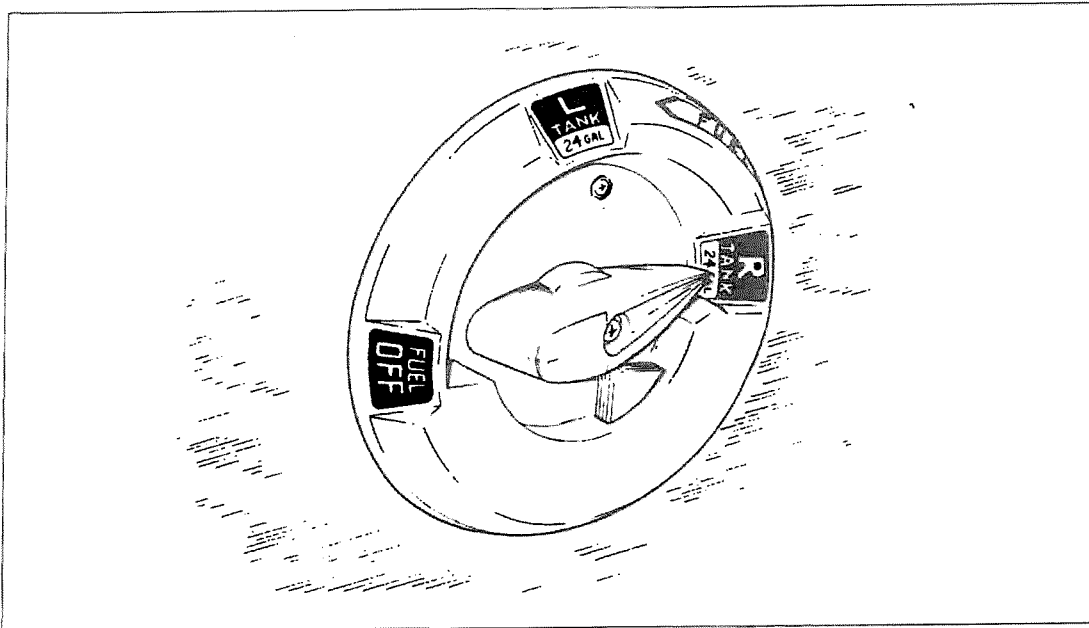

Fuel Selector

FUEL SYSTEM

Fuel is stored in two twenty-five gallon (24 gallons usable) tanks which are secured to the leading edge structure of each wing by screws and nut plates. This allows easy removal for service or inspection.

The **fuel selector control** is located on the left side-panel, forward of the pilot's seat. The button on the selector cover must be depressed and held while the handle is moved to the OFF position. The button releases automatically when the handle is moved back into the ON position.

An **auxiliary electric fuel pump** is provided in case of failure of the engine driven pump. The electric pump should be on for all takeoffs and landings, and when switching tanks. The pump switch is located in the switch panel above the throttle quadrant.

Each tank has an **individual quick drain** located at the bottom, inboard rear corner, and should be drained to check for water before each flight (a special container is furnished for this operation). The **fuel strainer**, which is also equipped with a quick drain, is located on the front lower left corner of the fire wall. This strainer should be drained regularly to check for water or sediment accumulation. To drain the lines from the tanks, the tank selector valve must be switched to each tank in turn, with the electric pump on, and the gascolator drain valve opened. (Refer to the Handling and Servicing Section for the complete procedure.)

Fuel quantity and pressure are indicated on gauges located in a cluster on the left side of the instrument panel.

An optional **engine priming system** is available to facilitate starting. The primer pump is located to the immediate left of the throttle quadrant.

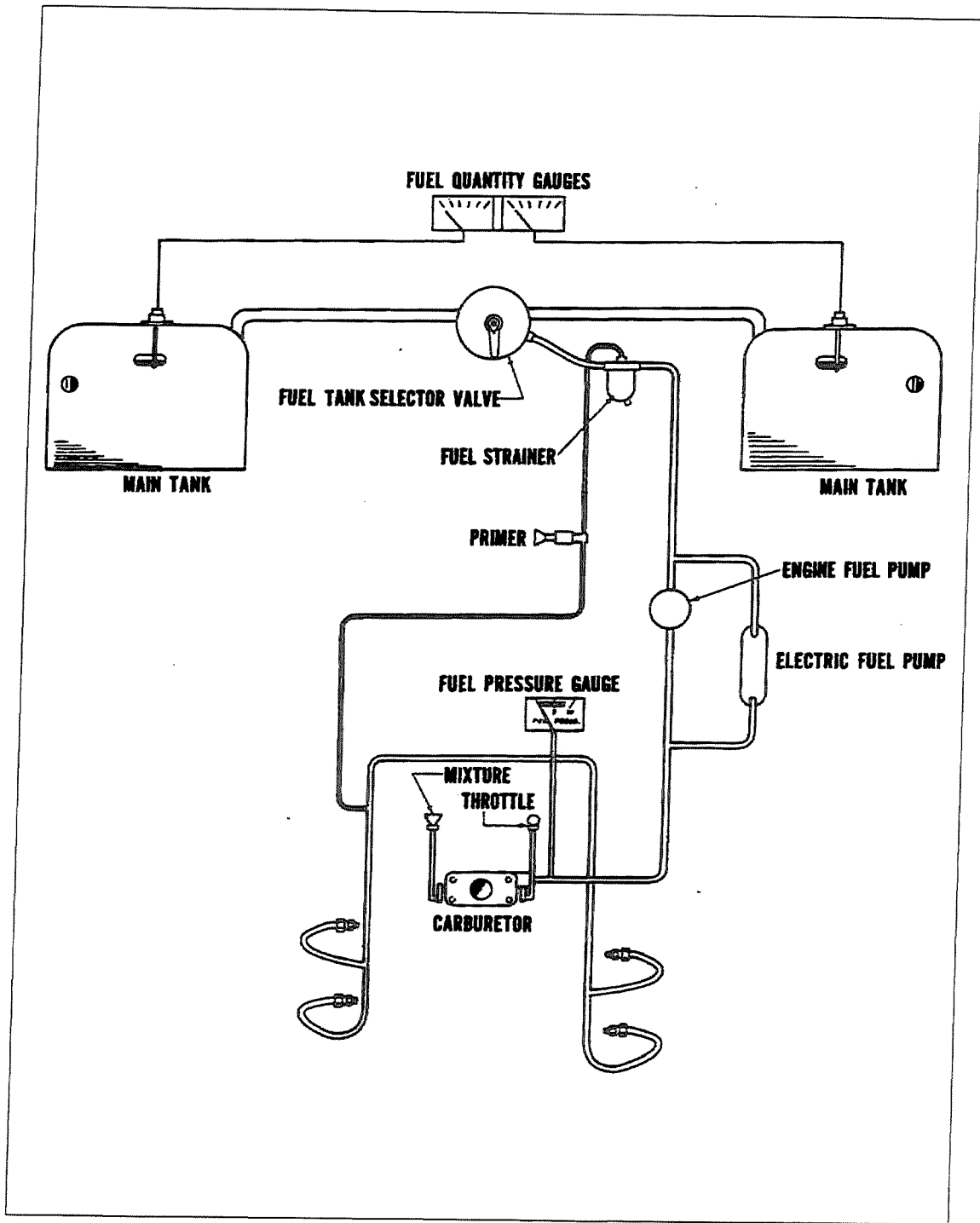

Fuel System Schematic

CHEROKEE ARCHER

ELECTRICAL SYSTEM

The **electrical system** includes a 14-volt, 60 amp alternator, a 12-volt battery, a voltage regulator, an overvoltage relay and a master switch relay. The battery is mounted in a stainless steel box immediately aft of the baggage compartment. The regulator and overvoltage relay are located on the forward left side of the fuselage behind the instrument panel.

Electrical switches are located on the right center instrument panel, and the **circuit breakers** are located on the lower right instrument panel. A rheostat switch on the left side of the switch panel controls the navigational lights and the radio lights. The similar switch on the right side controls and dims the panel lights.

The **alternator system** offers many advantages over the generator system both in operation and maintenance. The main advantage is full electrical power output at lower engine RPM. This is a great improvement for radio and electrical equipment operation. Since the alternator output is available at all times, the battery will be charging for a greater percentage of use. This will make cold weather starting easier.

Standard electrical accessories include a starter, electric fuel pump, stall warning indicator, cigar lighter, fuel gauge, ammeter, and annunciator panel*.

The annunciator panel includes alternator and low oil pressure indicator lights. When the optional gyro system is installed, the annunciator panel also includes a low vacuum indicator light. The annunciator panel lights are provided only as a warning to the pilot that a system may not be operating properly, and that he should check and monitor the applicable system gauge to determine when or if any necessary action is required.

Optional electrical accessories include navigation lights, anti-collision light, landing light, instrument lighting, and cabin dome light. Circuits will handle a full complement of communications and navigational equipment.

WARNING

Strobe lights should not be operating when flying through overcast and clouds since reflected light can produce spacial disorientation. Do not operate strobe lights in close proximity to ground, during takeoff and landing.

The words "**master switch**" used hereafter in this manual indicate both sides of the switch: battery side "BAT" and alternator side "ALT" are to be depressed simultaneously to OFF or ON as directed.

*Serial nos. 7505001 and up

Unlike previous generator systems, the ammeter does not indicate battery discharge; rather it displays in amperes the load placed on the alternator. With all electrical equipment off (except master switch) the ammeter will be indicating the amount of charging current demanded by the battery. As each item of electrical equipment is turned on, the current will increase to a total appearing on the ammeter. This total includes the battery. The maximum continuous load for night flight, with radios on, is about 30 amperes. This 30 ampere value, plus approximately two amperes for a fully charged battery, will appear continuously under these flight conditions. The amount of current shown on the ammeter will tell immediately if the alternator system is operating normally, as the amount of current shown should equal the total amperage drawn by the equipment which is operating.

If no output is indicated on the ammeter during flight, reduce the electrical load by turning off all unnecessary electrical equipment. Check both 5 ampere field breaker and 60 ampere output breaker and reset if open. If neither circuit breaker is open, turn off the "ALT" switch for 1 second to reset the overvoltage relay. If ammeter continues to indicate no output, maintain minimum electrical load and terminate flight as soon as practical.

Maintenance on the alternator should prove to be a minor factor. Should service be required, contact the local Piper Dealer.

CHEROKEE ARCHER

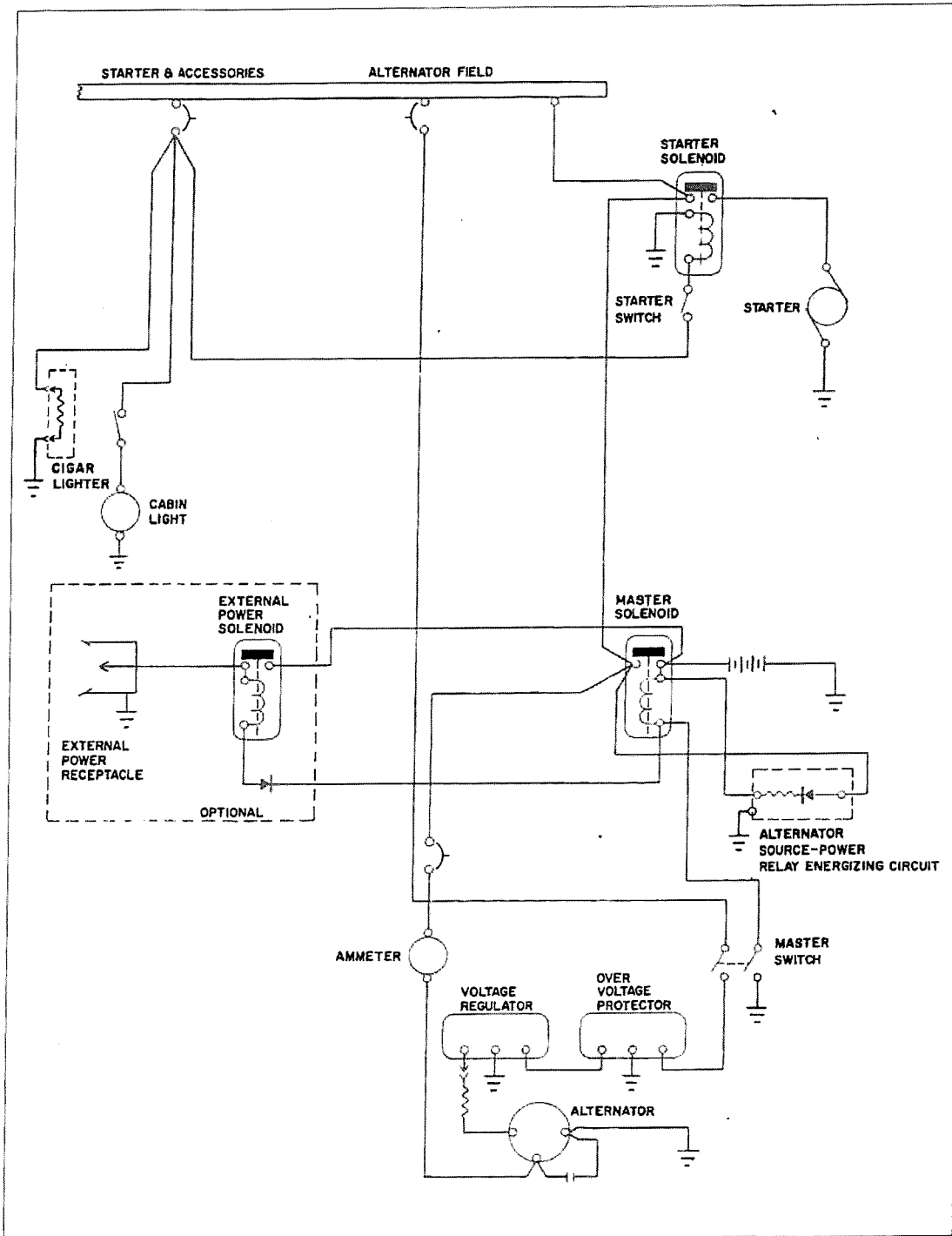

Alternator and Starter Schematic (Ser. nos. 7405001 through 7405290)

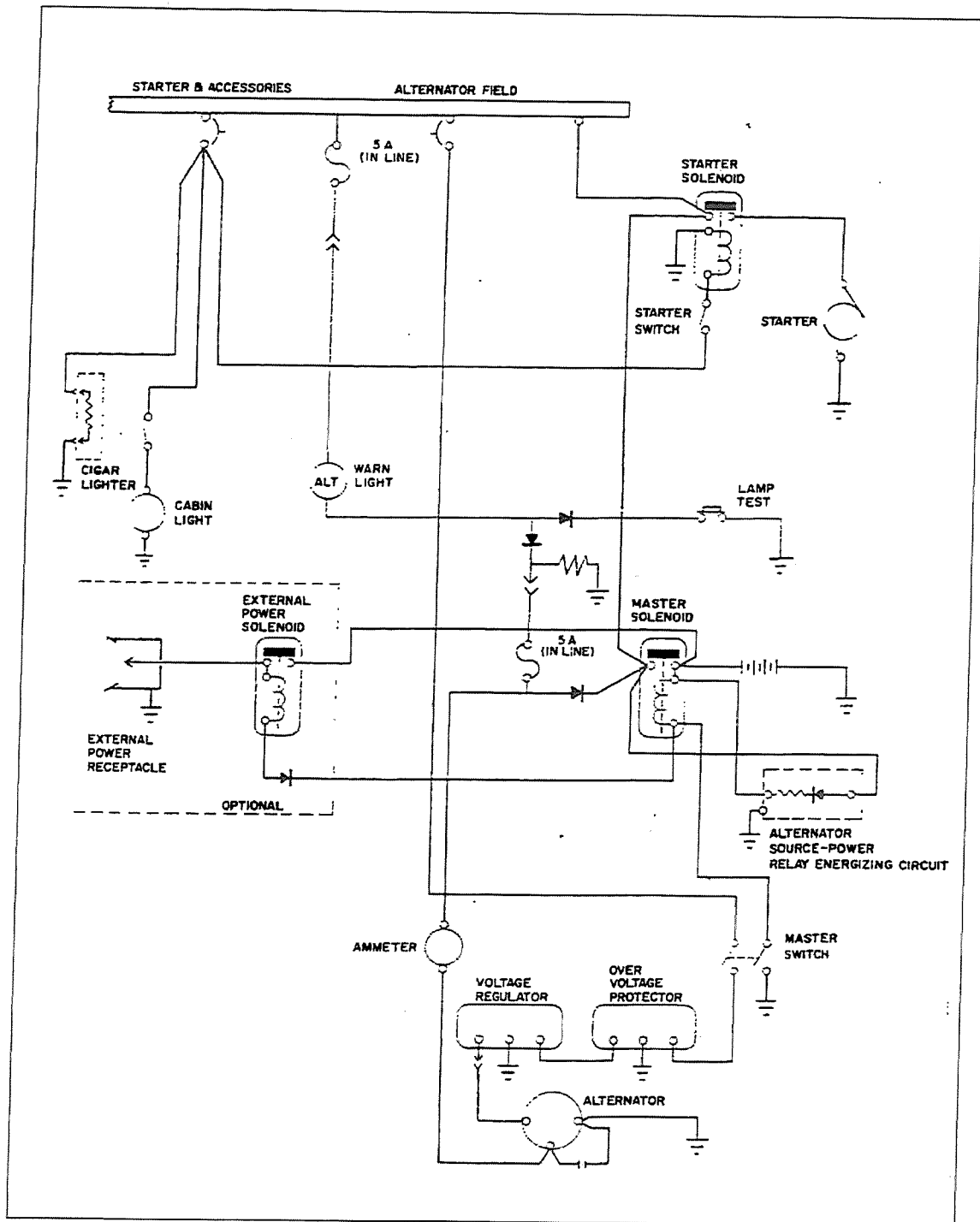

Alternator and Starter Schematic (Ser. nos. 7505001 and up)

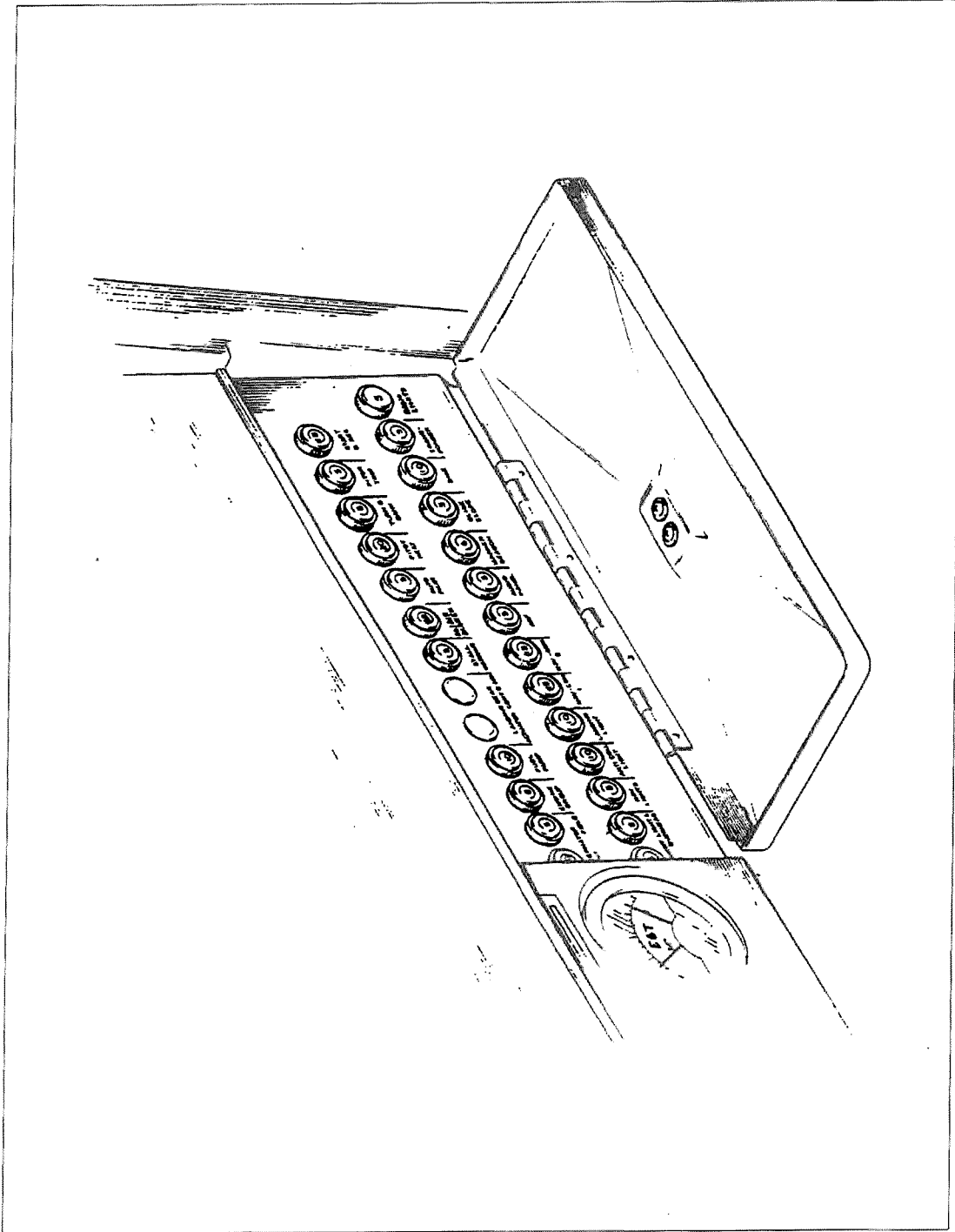

Circuit Breaker Panel

VACUUM SYSTEM

The vacuum system is designed to operate the air driven gyro instruments. This includes the directional and attitude gyros when installed. The system consists of an engine driven vacuum pump, a vacuum regulator, a filter and the necessary plumbing.

The **vacuum pump** is a dry type pump which eliminates the need for an air/oil separator and its plumbing. A shear drive protects the pump from damage. If the drive shears, the gyros will become inoperative.

The vacuum gauge, mounted on the right instrument panel to the right of the radios, provides valuable information to the pilot about the operation of the vacuum system. A decrease in pressure in a system that has remained constant over an extended period may indicate a dirty filter, dirty screens, possibly a sticking vacuum regulator or leak in system (a low vacuum indicator light is provided in the annunciator panel*). Zero pressure would indicate a sheared pump drive, defective pump, possibly a defective gauge or collapsed line. In the event of any gauge variation from the norm, the pilot should have a mechanic check the system to prevent possible damage to the system components or eventual failure of the system.

A vacuum regulator is provided in the system to protect the gyros. The valve is set so the normal vacuum reads $5.0 \pm .1$ inches of mercury, a setting which provides sufficient vacuum to operate all the gyros at their rated R.P.M. Higher settings will damage the gyros and with a low setting the gyros will be unreliable. The regulator is located behind the instrument panel and is accessible from below the instrument panel.

INSTRUMENT PANEL

The **instrument panel** of the Cherokee is designed to accommodate the customary advanced flight instruments and the normally required power plant instruments. The artificial horizon and directional gyro are vacuum operated through use of a vacuum pump installed on the engine, while the turn and bank instrument is electrically operated. A vacuum gauge is mounted on the far right side of the instrument panel. A natural separation of the **flight group** and power group is provided by the placement of the flight group in the upper instrument panel and the power group in the center and lower instrument panels. The radios and circuit breakers are on the right hand instrument panel. Extra circuits are provided for a complete line of optional radio equipment. An annunciator panel* is mounted in the upper instrument panel to warn the pilot of a possible malfunction in the alternator, oil pressure. or vacuum systems.

*Serial nos. 7505001 and up

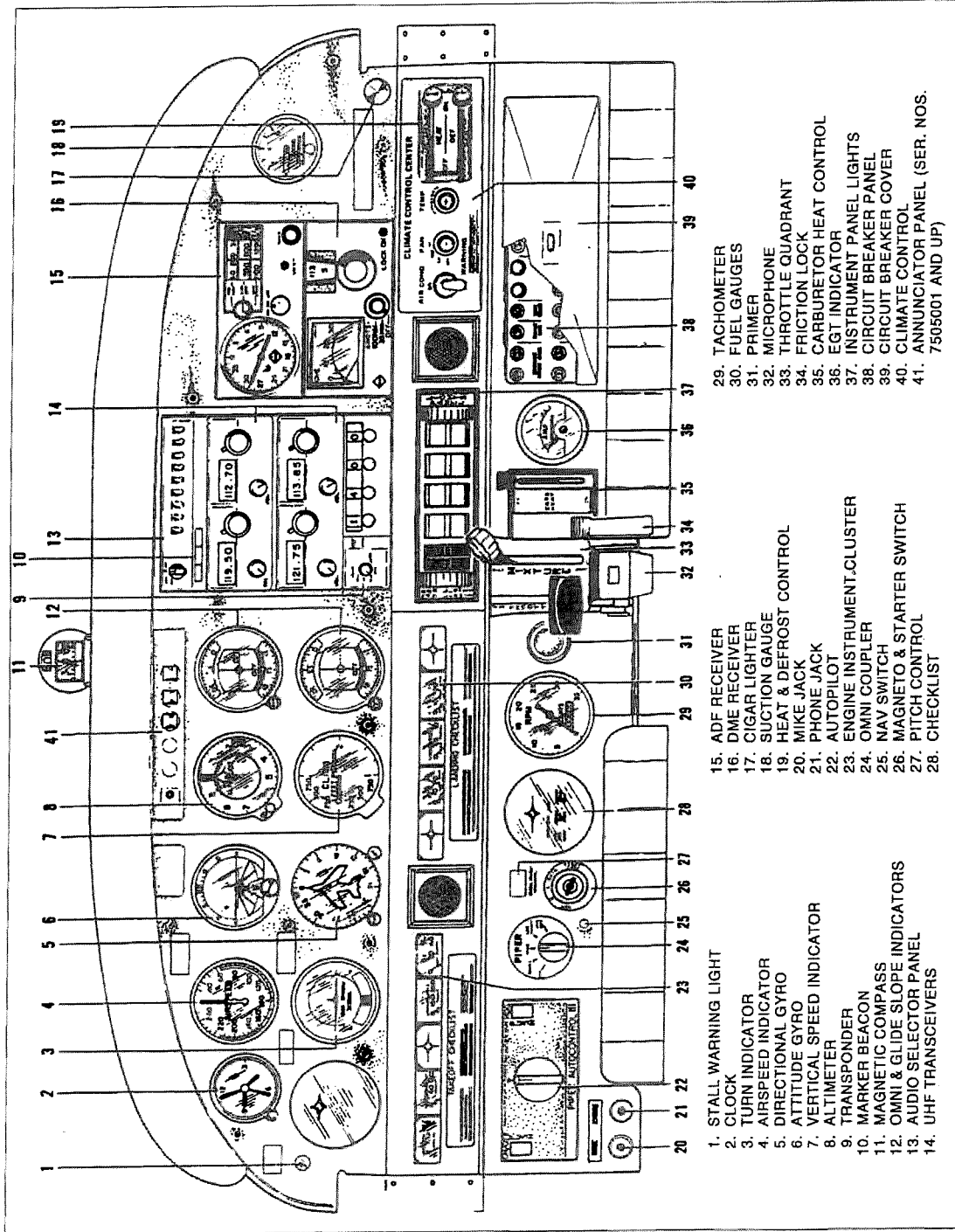

- 29. TACHOMETER
- 30. FUEL GAUGES
- 31. PRIMER
- 32. MICROPHONE
- 33. THROTTLE QUADRANT
- 34. FRICTION LOCK
- 35. CARBURETOR-HEAT CONTROL
- 36. EGT INDICATOR
- 37. INSTRUMENT PANEL LIGHTS
- 38. CIRCUIT BREAKER PANEL
- 39. CIRCUIT BREAKER COVER
- 40. CLIMATE CONTROL
- 41. ANNUNCIATOR PANEL (SER. NOS. 7505001 AND UP)

- 15. ADF RECEIVER
- 16. DME RECEIVER
- 17. CIGAR LIGHTER
- 18. SUCTION GAUGE
- 19. HEAT & DEFROST CONTROL
- 20. MIKE JACK
- 21. PHONE JACK
- 22. AUTOPILOT
- 23. ENGINE INSTRUMENT CLUSTER
- 24. OMNI COUPLER
- 25. NAV SWITCH
- 26. MAGNETO & STARTER SWITCH
- 27. PITCH CONTROL
- 28. CHECKLIST

- 1. STALL WARNING LIGHT
- 2. CLOCK
- 3. TURN INDICATOR
- 4. AIRSPEED INDICATOR
- 5. DIRECTIONAL GYRO
- 6. ATTITUDE GYRO
- 7. VERTICAL SPEED INDICATOR
- 8. ALTIMETER
- 9. TRANSPONDER
- 10. MARKER BEACON
- 11. MAGNETIC COMPASS
- 12. OMNI & GLIDE SLOPE INDICATORS
- 13. AUDIO SELECTOR PANEL
- 14. UHF TRANSCIVERS

Instrument Panel

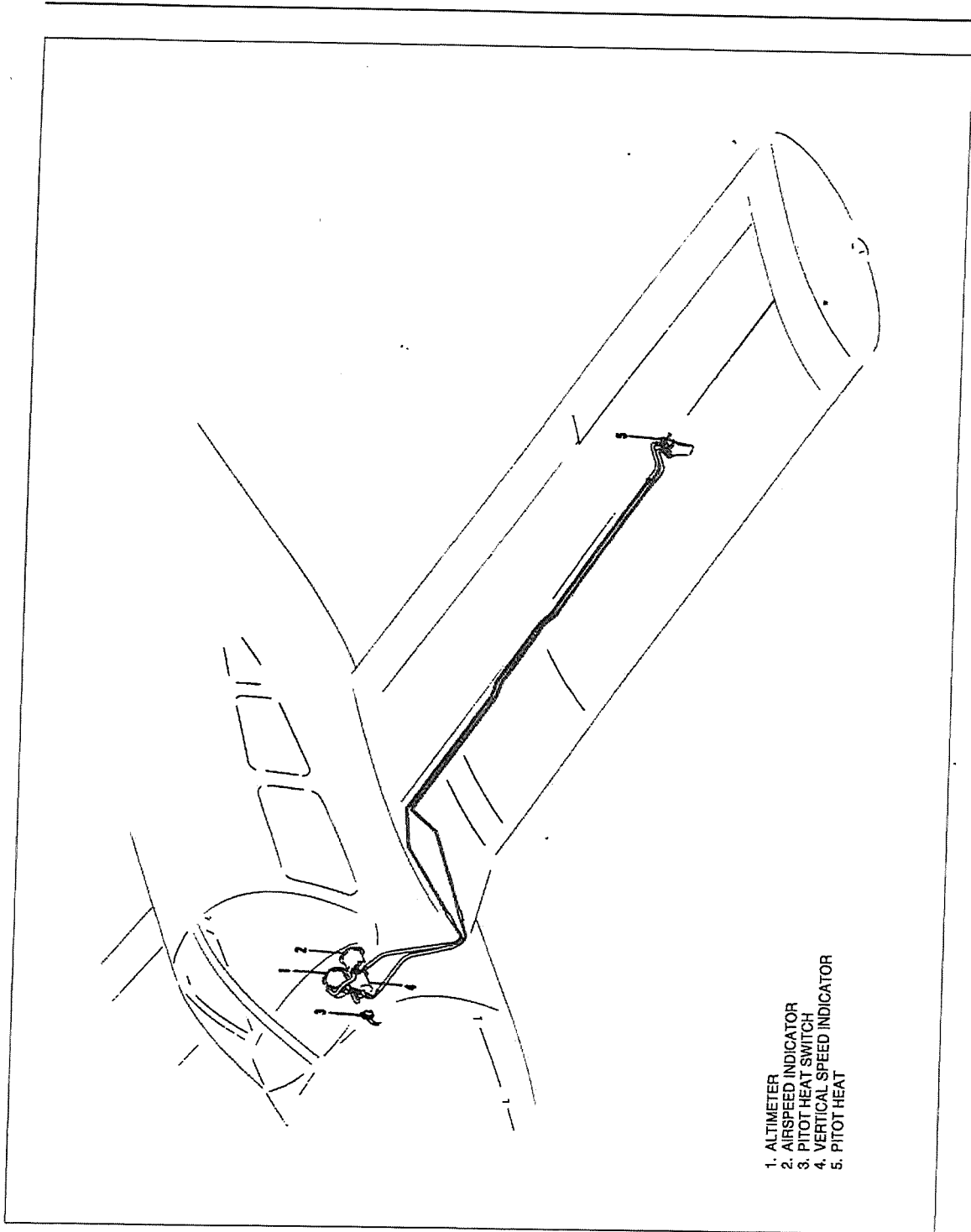

Pitot - Static System

CHEROKEE ARCHER

PITOT-STATIC SYSTEM

The system supplies both pitot and static pressure for the airspeed indicator, altimeter and vertical speed indicator (when installed).

Pitot and static pressure are picked up by the pitot head on the bottom of the left wing. An optional heated pitot head, which alleviates problems with icing or heavy rain, is available. The switch for pitot heat is located on the switch panel above the throttle quadrant.

To prevent bugs and water from entering the pitot and static pressure holes, when the airplane is parked, a cover should be placed over the pitot head. A partially or completely blocked pitot head will give erratic or zero readings on the instruments.

NOTE

During the preflight, check to make sure the pitot cover is removed.

HEATING AND VENTILATING SYSTEM

Heat for the cabin interior and the defroster system is provided by a heater muff attached to the exhaust system. The amount of heat desired can be regulated with the controls located on the far right side of the instrument panel.

The air flow can be regulated between the front and rear seats by levers located on top of the heat ducts next to the console.

Fresh air inlets are located in the leading edge of the wing at the intersection of the tapered and straight sections. A large adjustable outlet is located on the side of the cabin near the floor at each seat location; overhead air outlets are offered as optional equipment. Air is exhausted through an outlet under the rear seat. A **cabin air blower**, incorporated in the ventilating system, is also available as optional equipment. An optional overhead ventilating system with a cabin air blower is available on models without air conditioning. This blower is operated by a "FAN" switch with 4 positions - "OFF," "LOW," "MED," or "HIGH."

CAUTION

When cabin heat is operated, heat duct surface becomes hot. This could result in burns if arms or legs are placed too close to heat duct outlets or surface.

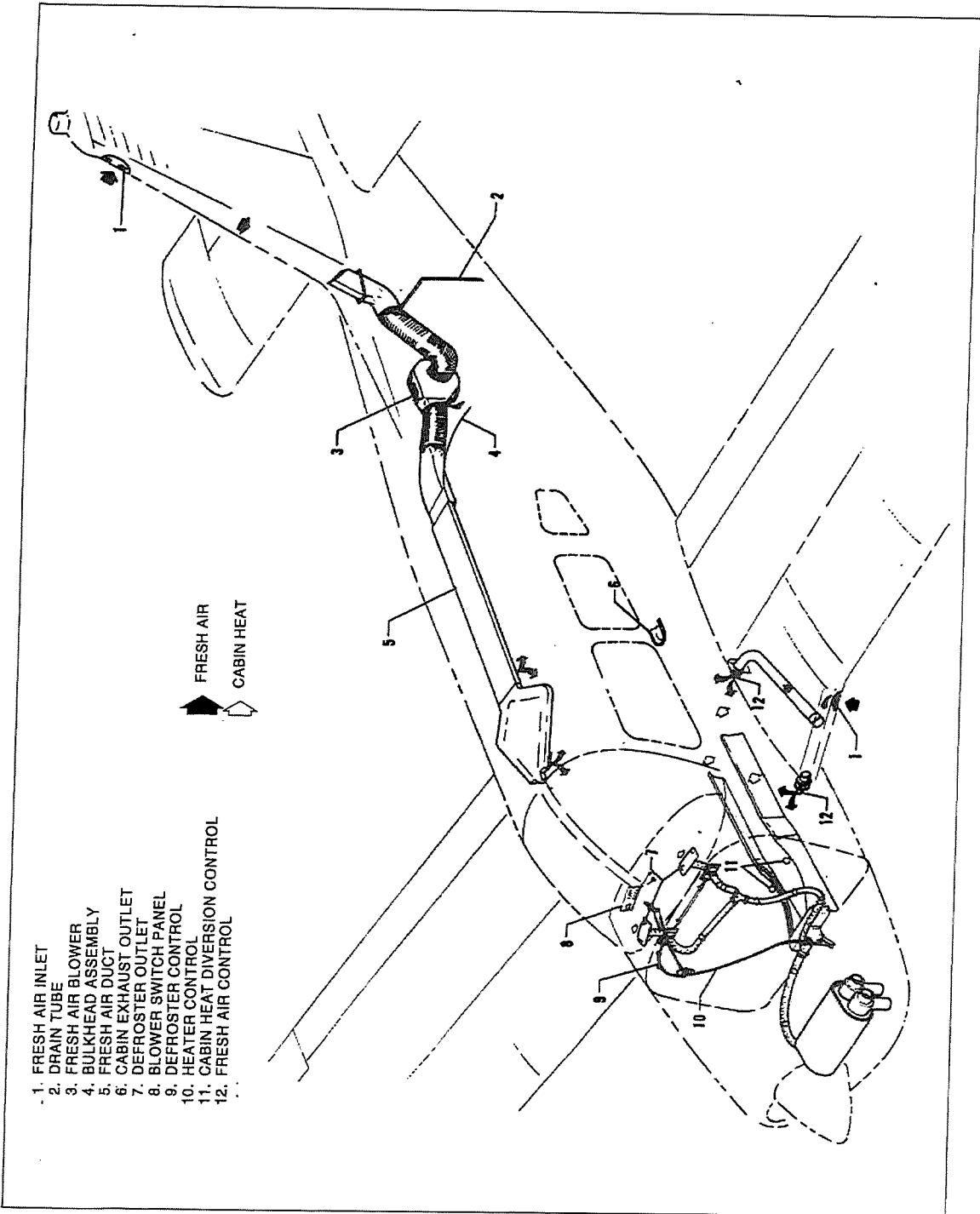

Heating and Ventilating System

CHEROKEE ARCHER

CABIN FEATURES

For ease of entry and exit and pilot-passenger comfort, the front seats are adjustable fore and aft. The back of the right front seat contains two latches, an outboard latch which allows the seat to be moved forward or aft for ease of entry, and an inboard latch which allows the seat back to be tilted forward to allow easy entry to the rear seats. The rear seats are easily removed to provide room for bulky items. Some rear seat installations incorporate leg retainers with latching mechanisms which must be released before the rear seats can be removed. Releasing the retainers is easily accomplished by turning the latching mechanisms 90° with a coin or screwdriver. Armrests are also provided for the front seats. All seats are available with optional headrests and optional vertical adjustment may be added to the front seats.

The cabin interior includes a pilot storm window, two sun visors, ash trays, two map pockets, and pockets on the backs of each front seat.

A single strap shoulder harness controlled by an inertia reel is standard equipment for the front seats, and is offered as an option for the rear seats. The shoulder strap is routed over the shoulder adjacent to the windows and attached to the lap belt in the general area of the person's inboard hip.

A check of the inertia reel mechanism is made by pulling sharply on the strap. The reel will lock in place under this test and prevent the strap from extending. Under normal movement the strap will extend and retract as required.

BAGGAGE AREA

A 24 cubic foot baggage area, located behind the rear seats, is accessible either from the cabin or through a large 20 x 22 inch outside baggage door on the right side of the aircraft. Maximum capacity is 200 pounds. Tie-down straps are provided and should be used at all times.

NOTE

It is the pilot's responsibility to be sure when the baggage is loaded that the aircraft C.G. falls within the allowable C.G. Range. (See Weight and Balance Section.)

STALL WARNING

An approaching stall is indicated by a stall warning light located on the left side of the instrument panel. The red light illuminates automatically between five and ten miles per hour above stall speed.

FINISH

All exterior surfaces are primed with etching primer and finished with a durable acrylic lacquer in a variety of tasteful colors to suit individual owners.

AIR CONDITIONING*

The air conditioning system is a recirculating air system. The major items include; evaporator, condenser, compressor, blower, switches and temperature controls.

The evaporator is located behind the left rear side of the baggage compartment. This cools the air that is used for air conditioning.

The condenser is mounted on a retractable scoop located on the bottom of the fuselage and to the rear of the baggage compartment area. The scoop extends when the air conditioner is "ON" and retracts to a flush position when the system is "OFF."

The compressor is mounted on the forward right underside of the engine. It has an electric clutch which automatically engages or disengages the compressor to the belt drive system of the compressor.

An electrical blower is mounted on the aft side of the rear cabin panel. Air from the baggage area is drawn through the evaporator by the blower and distributed through an overhead duct to individual outlets located adjacent to each occupant.

The switches and temperature control are located on the lower right side of the instrument panel in the climate control center panel. The temperature control regulates the desired temperature of the cabin. Turn the control clockwise for increased cooling, counterclockwise for decreased cooling.

Located inboard of the temperature control is the fan speed switch and the air conditioning "ON-OFF" switch. The fan can be operated independently of the air conditioning. However, it must be on for air conditioner operation. Turning either switch off will disengage the compressor clutch and retract the condenser door. Cooling air should be felt within one minute after the air conditioner is turned on.

NOTE

If the system is not operating in 5 minutes, turn the system "OFF" until the fault is corrected.

The "FAN" switch allows operation of the fan with the air conditioner turned "OFF" to aid cabin air circulation if desired. A "LOW," "MED" or "HIGH" flow of air can be selected to the air conditioner outlets located in the overhead duct. The outlets can be adjusted or turned off by each occupant to regulate individual cooling effect.

The "DOOR OPEN" indicator light is located to the left of the radio stack in front of the pilot. The light illuminates whenever the condenser door is open and remains on until the door is closed.

A circuit breaker located on the circuit breaker panel protects the air conditioning electrical system.

*Optional equipment

CHEROKEE ARCHER

Whenever the throttle is in the full throttle position, it actuates a micro switch which disengages the compressor and retracts the scoop. This is done to obtain maximum power and maximum rate of climb. The fan continues to operate and the air will remain cool for approximately one minute. When the throttle is retarded approximately 1/4 inch, the clutch will engage and the scoop will extend, again supplying cool, dry air.

PIPER EXTERNAL POWER*

An optional starting installation known as Piper External Power (PEP) is accessible through a receptacle located on the right side of the fuselage aft of the wing. An external battery can be connected to the socket, thus allowing the operator to crank the engine without having to gain access to the airplane's battery.

*Optional equipment

AIRPLANE FLIGHT MANUAL

Log of Revisions 3-iii

Limitations 3-1

Procedures 3-7

Performance 3-9

Supplements 3-11

BLANK PAGE

DUPLICATE

AIRPLANE FLIGHT MANUAL

FOR

CHEROKEE ARCHER

APPLICABLE TO SERIAL NUMBERS 28-7405001 THROUGH 28-7505259

WARNING

EXTREME CARE MUST BE EXERCISED TO LIMIT THE USE OF THIS MANUAL TO APPLICABLE AIRCRAFT. THIS MANUAL REVISED AS INDICATED BELOW OR SUBSEQUENTLY REVISED IS VALID FOR USE WITH THE AIRPLANE IDENTIFIED BELOW WHEN APPROVED BY PIPER AIRCRAFT CORPORATION. SUBSEQUENT REVISIONS SUPPLIED BY PIPER AIRCRAFT CORPORATION MUST BE PROPERLY INSERTED.

MODEL PA-28-180

AIRCRAFT SERIAL NO. 28-7405237 REGISTRATION NO. _____

AIRPLANE FLIGHT MANUAL, REPORT NUMBER VB-558 REVISION 5

PIPER AIRCRAFT CORPORATION
APPROVAL SIGNATURE AND STAMP

[Handwritten Signature]

NOTE

THIS MANUAL MUST BE KEPT IN THE AIRPLANE AT ALL TIMES

FAA APPROVED BY:

[Handwritten Signature: H.W. Barnhouse]

H.W. BARNHOUSE
PIPER AIRCRAFT CORPORATION
D.O.A. No. SO-1
VERO BEACH, FLORIDA

DATE OF APPROVAL: MAY 14, 1973

APPROVAL BASIS: CAR 3

REPORT: VB-558
MODEL: PA-28-180

TABLE OF CONTENTS

Log of Revisions	3-iii
SECTION I	
Limitations	3-1
A. Engine	3-1
B. Fuel	3-1
C. Propeller	3-1
D. Power Instruments	3-1
E. Airspeed Limitations and Airspeed Instrument Markings	3-2
F. Maximum Weight	3-2
G. Baggage Capacity	3-2
H. C. G. Range	3-2
I. Maneuvers	3-3
J. Placards	3-3
K. Air Conditioned Airplanes	3-5
 SECTION II	
Procedures	3-7
 SECTION III	
Performance	3-9
 SECTION IV	
Optional Equipment	3-11
A. Electric Pitch Trim Installation	3-13
B. AutoFlite II Installation	3-16
C. Air Conditioner Installation	3-17
D. Installation Of Piper AutoControl III and/or AutoControl IIIB	3-19

AIRPLANE FLIGHT MANUAL LOG OF REVISIONS

Revision	Revised Pages	Description and Revisions	FAA Approved Date
1	Title	Added PAC Approval Form. (NOTE: AIRCRAFT DELIVERED WITH MANUALS PRIOR TO THIS REVISION DO NOT REQUIRE THIS REVISION.)	<i>D. H. Trompler</i> D. H. Trompler May 30, 1974
2	3-i 3-11 3-19, 3-20, 3-21, 3-22	Added item F. Installation of Piper Auto-Control IIIB to Supplements. Added item F. Installation of Piper Auto-Control IIIB. Added Pages (AutoControl IIIB Supplement).	<i>D. H. Trompler</i> D. H. Trompler June 17, 1974
3	3-i 3-1 3-11 3-13 3-14 3-15 3-16 3-17 3-19 3-22	Changed Section IV title from Supplements to Optional Equipment; deleted (With Pitch Trim Switch) from item A.; deleted items B. and C.; revised existing item letters; added AutoControl III to new item D. Added O-360-A4M engine designation and ser. nos. Changed Section IV title from Supplements to Optional Equipment; revised NOTE; deleted items B. and C.; revised existing item letters; added AutoControl III to new item D. Deleted (With Pitch Trim Switch) from title. Deleted item B. AutoFlite Installation. Deleted item C. AutoControl III Installation. Changed item letter (D. to B.); revised item 2.b. (3). Changed item letter (E. to C.). Changed item letter (F. to D.); added Auto Control III to title. Deleted IIIB designation from items 2. c. (1) and (2).	<i>Ward Evans</i> Ward Evans Jan. 20, 1975
4	Title 3-1	Added Applicable Serial Nos. Removed Serial Nos. from item A.	<i>Ward Evans</i> Ward Evans Nov. 21, 1975

FAA APPROVED MAY 14, 1973
REVISED: NOVEMBER 21, 1975

REPORT: VB-558 PAGE 3-iii
MODEL: PA-28-180

AIRPLANE FLIGHT MANUAL LOG OF REVISIONS

Revision	Pages	Description	FAA Approved Date
5	3-1	Revised item B.	<i>Ward Evans</i> Ward Evans March 16, 1984

SECTION I
LIMITATIONS

The following limitations must be observed in the operation of this airplane:

A. ENGINE

Lycoming O-360-A4A or O-360-A4M with carburetor setting IO-3878

ENGINE LIMITS

For all operations 2700 RPM, 180 HP

B. FUEL (AVGAS ONLY)

100/130 minimum octane aviation fuel

C. PROPELLER

Sensenich M76EMMS or 76EM8S5. Maximum diameter 76 inches, minimum diameter 76 inches. Static RPM at maximum permissible throttle setting. Not over 2425, not under 2325. No additional tolerance permitted.

D. POWER INSTRUMENTS

OIL TEMPERATURE

Green Arc (Normal Operating Range)	75°F to 245°F
Red Line (Maximum)	245°F

OIL PRESSURE

Green Arc (Normal Operating Range)	60 PSI to 90 PSI
Yellow Arc (Caution Range)	25 PSI to 60 PSI
Red Line (Minimum)	25 PSI
Red Line (Maximum)	90 PSI

FUEL PRESSURE

Green Arc (Normal Operating Range)	.5 PSI to 8 PSI
Red Line (Minimum)	.5 PSI
Red Line (Maximum)	8 PSI

TACHOMETER

Green Arc (Normal Operating Range)	500 to 2700 RPM
Red Line (Maximum Continuous Power)	2700 RPM

CHEROKEE ARCHER

E. AIRSPEED LIMITATIONS AND AIRSPEED INSTRUMENT MARKINGS

NEVER EXCEED	171 MPH
MAXIMUM STRUCTURAL CRUISE	140 MPH
MANEUVERING	127 MPH
FLAPS EXTENDED	115 MPH
MAXIMUM POSITIVE LOAD FACTOR	(Normal Category) 3.8
MAXIMUM POSITIVE LOAD FACTOR	(Utility Category) 4.4
MAXIMUM NEGATIVE LOAD FACTOR	No inverted maneuvers approved

AIRSPEED INSTRUMENT MARKINGS

Red Radial Line (Never Exceed)	171 MPH (148 KTS)
Yellow Arc (Caution Range) (Smooth Air Only)	140 MPH to 171 MPH (121 KTS to 148 KTS)
Green Arc (Normal Operating Range)	68 MPH to 140 MPH (59 KTS to 121 KTS)
White Arc (Flaps Down Range)	61 MPH to 115 MPH (53 KTS to 100 KTS)

F. MAXIMUM WEIGHT

Normal Category	2450 LBS
Utility Category	1950 LBS

G. BAGGAGE CAPACITY

200 LBS

H. C. G. RANGE

The datum used is 78.4 inches ahead of wing leading edge at the intersection of the straight and tapered section.

1. Normal Category

<u>Weight</u> <u>(Pounds)</u>	<u>Forward Limit</u> <u>(In. Aft of Datum)</u>	<u>Rearward Limit</u> <u>(In. Aft of Datum)</u>
2450	87.4	93.0
2050	82.0	93.0

2. Utility Category

<u>Weight</u> <u>(Pounds)</u>	<u>Forward Limit</u> <u>(In. Aft of Datum)</u>	<u>Rearward Limit</u> <u>(In. Aft of Datum)</u>
1950	82.0	86.5

Straight line variation between points given.

NOTE

It is the responsibility of the airplane owner and the pilot to insure that the airplane is properly loaded. See Weight and Balance Section for proper loading instructions.

I. MANEUVERS

1. Normal Category - All acrobatic maneuvers including spins prohibited.
2. Utility Category - Approved maneuvers for Utility Category only.

	Entry Speed
Steep Turns	127 MPH
Lazy Eights	127 MPH
Chandelles	127 MPH

J. PLACARDS

In full view of the pilot:

“THIS AIRPLANE MUST BE OPERATED AS A NORMAL OR UTILITY CATEGORY AIRPLANE IN COMPLIANCE WITH THE OPERATING LIMITATIONS STATED IN THE FORM OF PLACARDS, MARKINGS AND MANUALS.

ALL MARKINGS AND PLACARDS ON THIS AIRPLANE APPLY TO ITS OPERATION AS A UTILITY CATEGORY AIRPLANE. FOR NORMAL AND UTILITY CATEGORY OPERATIONS, REFER TO THE AIRPLANE FLIGHT MANUAL.

NO ACROBATIC MANEUVERS ARE APPROVED FOR NORMAL CATEGORY OPERATIONS. SPINS ARE PROHIBITED FOR BOTH NORMAL AND UTILITY CATEGORIES. “

In full view of the pilot, the following takeoff and landing check lists will be installed:

TAKEOFF CHECK LIST

Fuel on proper tank	Mixture set	Fasten belts/harness
Electric fuel pump on	Seat backs erect	Trim tab - set
Engine gauges checked		Controls - free
Flaps - set		Door - latched
Carb heat off		Air Conditioner- off

LANDING CHECK LIST

Fuel on proper tank		Flaps - set (115 mph)
Mixture rich	Seat backs erect	Fasten belts/harness
Electric fuel pump on		Air Conditioner - off

The “AIR COND OFF” item in the above takeoff and landing check lists is mandatory for air conditioned aircraft only.

CHEROKEE ARCHER

In full view of the pilot, in the area of the air conditioner control panel when the air conditioner is installed:

“WARNING - AIR CONDITIONER MUST BE OFF TO INSURE NORMAL TAKEOFF CLIMB PERFORMANCE.”

Adjacent to upper door latch:

“ENGAGE LATCH BEFORE FLIGHT.”

On inside of the baggage compartment door:

“BAGGAGE MAXIMUM 200 LBS”
“UTILITY CATEGORY OPERATION - NO BAGGAGE OR AFT PASSENGERS ALLOWED. NORMAL CATEGORY OPERATION - SEE AIRPLANE FLIGHT MANUAL WEIGHT AND BALANCE SECTION FOR BAGGAGE AND AFT PASSENGER LIMITATIONS.”

In full view of the pilot:

“ROUGH AIR OR MANEUVERING SPEED - 127 MPH.”

“UTILITY CATEGORY OPERATION - NO AFT PASSENGERS ALLOWED.”

On the instrument panel in full view of the pilot when the oil cooler winterization kit is installed:

“OIL COOLER WINTERIZATION PLATE TO BE REMOVED WHEN AMBIENT TEMPERATURE EXCEEDS 50°F.”

On the instrument panel in full view of the pilot when the AutoFlite is installed:

“FOR HEADING CHANGES: PRESS DISENGAGE SWITCH ON CONTROL WHEEL. CHANGE HEADING, RELEASE DISENGAGE SWITCH.”

In full view of the pilot:

“UTILITY CATEGORY ONLY.”

ACROBATIC MANEUVERS ARE LIMITED TO THE FOLLOWING:

	ENTRY SPEED
STEEP TURNS	127 MPH
LAZY EIGHTS	127 MPH
CHANDELLES	127 MPH

On the instrument panel in full view of the pilot when the AutoFlite II is installed:

“TURN AUTOFLITE ON. ADJUST TRIM KNOB FOR MINIMUM HEADING CHANGE. FOR HEADING CHANGE, PRESS DISENGAGE SWITCH ON CONTROL WHEEL, CHANGE HEADING, RELEASE SWITCH. ROTATE TURN KNOB FOR TURN COMMANDS. PUSH TURN KNOB IN TO ENGAGE TRACKER. PUSH TRIM KNOB IN FOR HI SENSITIVITY. LIMITATIONS: AUTOFLITE OFF FOR TAKEOFF AND LANDING.”

On the instrument panel in full view of the pilot when the supplementary white strobe lights are installed:

“WARNING - TURN OFF STROBE LIGHTS WHEN TAXIING IN VICINITY OF OTHER AIRCRAFT, OR DURING FLIGHT THROUGH CLOUD, FOG OR HAZE.”

- K. AIR CONDITIONED AIRPLANES
Air Conditioner must be off for takeoff and landing.

THIS PAGE INTENTIONALLY LEFT BLANK

SECTION II
PROCEDURES

1. The stall warning system is inoperative with the master switch off.
2. Electric fuel pump must be on for both landing and takeoff.
3. The PA-28-180 airplane is approved under FAA Regulation CAR 3 which prohibits intentional spins for both normal and utility category operation. The following information is noteworthy:
 - a. The stall characteristics of the PA-28-180 are normal with the nose pitching down moderately following the stall, occasionally with a moderate roll which can be corrected by normal use of ailerons and rudder against the roll.
 - b. Prolonged use of full rudder during stall practice may result in a rapid roll followed by a spin and should be avoided. Recovery from an incipient spin may be effected in less than one additional turn by use of opposite rudder followed by full forward control wheel.
 - c. In the event that a fully developed spin is inadvertently experienced, recovery is best made by using full opposite rudder followed by full forward wheel and full opposite aileron. The control positions against the spin should be maintained during the entire recover, which may require several turns and a substantial loss of altitude if the airplane is loaded heavily with a rearward center of gravity.
4. Except as noted above, all operating procedures for this airplane are normal.
5. Air Conditioned Models only: Warning - The air conditioner must be off to insure normal takeoff performance.

THIS PAGE INTENTIONALLY LEFT BLANK

SECTION III
PERFORMANCE

The following performance figures were obtained during FAA type tests and may be realized under conditions indicated with the airplane and engine in good condition and with average piloting technique. All performance is given for 2450 pounds.

Loss of altitude during stalls varied from 100 to 250 feet, depending on configuration and power.

Stalling speeds, in mph, power off, versus angle of bank (Calibrated Airspeed):

Angle of Bank	0°	20°	40°	50°	60°
Flaps Up	68	70	78	85	96
Flaps Down	61	-	-	-	-

Air Conditioned Models only:

When the full throttle position is not used or in the event of a malfunction which causes the compressor to operate and the condenser door to remain extended, a decrease in rate of climb of as much as 100 fpm can be expected at all altitudes.

CHEROKEE ARCHER

THIS PAGE INTENTIONALLY LEFT BLANK

**REPORT: VB-558 PAGE 3-10
MODEL: PA-28-180**

FAA APPROVED MAY 14, 1973

SECTION IV
OPTIONAL EQUIPMENT

NOTE

THE INFORMATION CONTAINED IN THIS SECTION
APPLIES WHEN THE RELATED EQUIPMENT IS INSTALLED
IN THE AIRCRAFT.

- A. Electric Pitch Trim Installation
- B. AutoFlite II Installation
- C. Air Conditioner Installation
- D. Installation of Piper AutoControl III and/or AutoControl IIIB

CHEROKEE ARCHER

THIS PAGE INTENTIONALLY LEFT BLANK

**REPORT: VB-558 PAGE 3-12
MODEL: PA-28-180**

FAA APPROVED MAY 14, 1973

A. ELECTRIC PITCH TRIM INSTALLATION

The following emergency information applies in case of electric pitch trim malfunction:

1. In case of malfunction, disengage electric pitch trim by pushing pitch trim switch on instrument panel to OFF position.
2. In an emergency, electric pitch trim may be overpowered using manual pitch trim.
3. In cruise configuration, malfunction results in 10° pitch change and 200 ft altitude variation.
4. In approach configuration, a malfunction can result in a 5° pitch change and 50 ft altitude loss.

THIS PAGE INTENTIONALLY LEFT BLANK

THIS PAGE INTENTIONALLY LEFT BLANK

**FAA APPROVED MAY 14, 1973
REVISED: JANUARY 20, 1975**

**REPORT: VB-558 PAGE 3-15
MODEL: PA-28-180**

CHEROKEE ARCHER

B. AUTOFLITE II INSTALLATION

1. LIMITATIONS

AutoFlite off for takeoff and landing.
AutoFlite use prohibited above 160 mph CAS.

2. PROCEDURES

a. Normal Operation

Refer to Manufacturer's Operation Manual.

b. Emergency Operation

- (1) In case of malfunction, PRESS disconnect switch on pilot's control wheel.
- (2) Rocker switch on instrument panel - OFF.
- (3) Unit may be overpowered manually.
- (4) In climb, cruise or descending flight an autopilot runaway, with a 3 second delay could result in 60° bank, and 190 ft altitude loss.
- (5) In approach configuration an autopilot runaway, with a 1 second delay results in 15° bank and 40 ft altitude loss.

C. AIR CONDITIONER INSTALLATION

Prior to takeoff, the air conditioner should be checked for proper operation as follows:

1. Check aircraft master switch on.
2. Turn the air conditioner control switch to "ON" and the fan switch to one of the operating positions - the "AIR COND DOOR OPEN" warning light will turn on, thereby indicating proper air conditioner condenser door actuation.
3. Turn the air conditioner control switch to OFF - the "AIR COND DOOR OPEN" warning light will go out, thereby indicating the air conditioner condenser door is in the up position.
4. If the "AIR COND DOOR OPEN" light does not respond as specified above, an air conditioner system or indicator bulb malfunction is indicated and further investigation should be conducted prior to flight.

The above operational check may be performed during flight if an in flight failure is suspected.

WARNING

The air conditioner must be off to insure normal takeoff performance.

CHEROKEE ARCHER

THIS PAGE INTENTIONALLY LEFT BLANK

**REPORT: VB-558 PAGE 3-18
MODEL: PA-28-180**

FAA APPROVED MAY 14, 1973

D. INSTALLATION OF PIPER AUTOCONTROL III AND/OR AUTOCONTROL IIIB

1. LIMITATIONS

- a. Autopilot OFF during takeoff and landing.
- b. Autopilot use prohibited above 160 MPH CAS.

2. PROCEDURES

a. PREFLIGHT

(1) Roll Section

- (a) Place Radio Coupler in "Heading" mode and place A/P ON/OFF switch in the "ON" position to engage roll section. Rotate roll command knob Left and Right and observe control wheel describes a corresponding Left and Right turn, then center knob.
- (b) Set proper D.G. Heading on D.G. and turn Heading Indice to aircraft heading. Engage "Heading" mode switch and rotate Heading Indice right and left. Aircraft control wheel should turn same direction as Indice. While D.G. indice is set for a left turn, grasp control wheel and override the servo to the right. Repeat in opposite direction for right turn.
- (c) If VOR signal available check Omni mode on Radio Coupler by swinging Omni needle left and right slowly. Observe that control wheel rotates in direction of needle movement.
- (d) Disengage by placing the A/P ON/OFF switch to the "OFF" position.

b. IN-FLIGHT

- (1) Trim airplane (ball centered).
- (2) Check air pressure or vacuum to ascertain that the Directional Gyro and Attitude Gyro are receiving sufficient air.
- (3) Roll Section
 - (a) To engage, center Roll Command Knob, place the A/P ON/OFF switch to the "ON" position. To turn rotate roll command knob in desired direction. (Maximum angle of bank should not exceed 30°.)
 - (b) For heading mode, set Directional Gyro with Magnetic Compass. Push directional gyro HDG knob in, rotate to aircraft heading. Place the console HDG ON/OFF switch to the "ON" position. To select a new aircraft heading, push D.G. heading knob IN and rotate, in desired direction of turn, to the desired heading.

NOTE

In HDG mode the maximum bank angles are limited to approximately 20° and single command, heading changes should be limited to 150°. (HDG Indice not more than 150° from actual aircraft heading.)

CHEROKEE ARCHER

(4) VOR

(a) To Intercept:

1. Using OMNI Bearing Selector, dial desired course, inbound or outbound.
2. Set identical heading on Course Selector D.G.
3. After aircraft has stabilized, position coupler mode selector knob to OMNI mode. As aircraft nears selected radial, interception and crosswind correction will be automatically accomplished without further switching.

NOTE

If aircraft position is less than 45° from selected radial, aircraft will intercept before station. If position is more than 45°, interception will occur after station passage. As the aircraft nears the OMNI station, (1/2 mile) the zone of confusion will direct an "S" turn in alternate directions as the OMNI indicator needle swings. This alternate banking limited to the standard D.G. bank angle, is an indication of station passage.

(b) To select new course:

1. To select a new course or radial, rotate the HDG indice to the desired HDG (match course).
2. Rotate OBS to the new course. Aircraft will automatically turn to the intercept heading for the new course.

(c) To change stations:

1. If same course is desired, merely tune receiver to new station frequency.
2. If different course is desired, position coupler mode selector to HDG mode. Dial course selector D.G. to new course. Dial OBS to new course and position coupler mode selector to OMNI mode.

(5) VOR Approach

Track inbound to station as described in VOR navigation section.
After station passage:

- (a) Dial outbound course on Course Selector D.G., then dial same course on OBS.
- (b) After established on outbound radial, position coupler mode selector to HDG mode and select outbound procedure turn heading. After 40 seconds to 1 minute select a turn in the desired direction with the Course Selector D.G. to the inbound procedure turn heading.
- (c) Set OBS to inbound course.
- (d) When aircraft heading is 45° to the inbound course, dial Course Selector D.G. to inbound course and position coupler mode selector to OMNI mode.

NOTE

For precise tracking over OMNI station, without "S" turn, position coupler mode selector to HDG mode just prior to station passage. If holding pattern is desired, position coupler mode selector to HDG mode at station passage inbound and select outbound heading in direction of turn. After elapsed time, dial inbound course on Course Selector D.G. When aircraft heading is 45 ° to radial, position coupler mode selector to OMNI mode.

(6) LOC Approach Only

- (a) To intercept dial ILS outbound course on Course Selector D.G. When stabilized, position coupler mode selector to LOC REV mode.
- (b) After interception and when beyond outer marker, position coupler mode selector to HDG mode and dial outbound procedure turn heading. After one minute, dial inbound procedure turn heading in direction of turn.
- (c) When aircraft heading is 45° to ILS inbound course dial inbound course on Course Selector D.G. and position coupler mode selector to LOC NORM mode.
- (d) At the missed approach point (M.A.P.), or when missed approach is elected, position coupler mode selector to HDG mode and execute missed approach procedure.

(7) LOC Approach - Back Course (Reverse)

- (a) To intercept dial ILS Back Course outbound heading on Course Selector D.G. When stabilized, position coupler mode selector to LOC NORM mode.
- (b) After interception and when beyond fix, position coupler mode selector to HDG and dial outbound procedure turn heading. After one minute, dial inbound procedure turn heading in direction of turn.
- (c) When heading 45° to inbound course, dial inbound course on Course Selector D.G. and position coupler mode selector to LOC REV mode.
- (d) Approximately 1/2 mile from runway, position coupler mode selector to HDG mode to prevent "S" turn over ILS station near runway threshold.
- (e) Missed approach - same as Front Course. (See (6) d)

CHEROKEE ARCHER

c. EMERGENCY OPERATION

- (1) In an emergency the AutoControl can be disconnected by placing the A/P ON/OFF switch to the "OFF" position.
- (2) The AutoControl can be overpowered at either control wheel.
- (3) An Autopilot runaway, with a 3 second delay in the initiation of recovery, while operating in a climb, cruise or descending flight could result in a 60° bank and 100 foot altitude loss.
- (4) An Autopilot runaway, with a 1 second delay in the initiation of recovery, during an approach operation, coupled or uncoupled, could result in a 10° bank and 10 foot altitude loss.

3. PERFORMANCE

No change.

**F.A.A. APPROVED
EMERGENCY PROCEDURES**

NONE APPLICABLE TO THIS AIRPLANE

BLANK PAGE

EMERGENCY PROCEDURES

Introduction	4-1
Engine Power Loss During Takeoff	4-1
Engine Power Loss In Flight	4-2
Power Off Landing	4-3
Spins	4-3
Open Door	4-3
Fire.....	4-4
Loss of Oil Pressure.....	4-5
Loss of Fuel Pressure.....	4-5
High Oil Temperature	4-5
Alternator Failure.....	4-6
Engine Roughness	4-6

BLANK PAGE

EMERGENCY PROCEDURES

INTRODUCTION

This section contains procedures that are recommended if an emergency condition should occur during ground operation, takeoff, or in flight. These procedures are suggested as the best course of action for coping with the particular condition described, but are not a substitute for sound judgment and common sense. Since emergencies rarely happen in modern aircraft, their occurrence is usually unexpected, and the best corrective action may not always be obvious. Pilots should familiarize themselves with the procedures given in this section and be prepared to take appropriate action should an emergency arise.

Most basic emergency procedures, such as power off landings, are a normal part of pilot training. Although these emergencies are discussed here, this information is not intended to replace such training, but only to provide a source of reference and review, and to provide information on procedures which are not the same for all aircraft. It is suggested that the pilot review standard emergency procedures periodically to remain proficient in them.

ENGINE POWER LOSS DURING TAKEOFF

The proper action to be taken if loss of power occurs during takeoff will depend on circumstances.

1. If sufficient runway remains for a normal landing, land straight ahead.
2. If insufficient runway remains, maintain a safe airspeed and make only a shallow turn if necessary to avoid obstructions. Use of flaps depends on circumstances. Normally, flaps should be fully extended for touchdown.
3. If you have gained sufficient altitude to attempt a restart, proceed as follows:
 - a. MAINTAIN SAFE AIRSPEED
 - b. FUEL SELECTOR - SWITCH TO ANOTHER TANK CONTAINING FUEL
 - c. ELECTRIC FUEL PUMP - CHECK ON
 - d. MIXTURE - CHECK RICH
 - e. CARBURETOR HEAT - ON

NOTE

If engine failure was caused by fuel exhaustion, power will not be regained after tanks are switched until empty fuel lines are filled, which may require up to ten seconds.

If power is not regained, proceed with the POWER OFF LANDING procedure.

CHEROKEE ARCHER

ENGINE POWER LOSS IN FLIGHT

Complete engine power loss is usually caused by fuel flow interruption, and power will be restored shortly after fuel flow is restored. If power loss occurs at low altitude, the first step is to prepare for an emergency landing (See POWER OFF LANDING). Maintain an airspeed of at least 80 MPH IAS, and if altitude permits, proceed as follows:

1. Fuel Selector - Switch to another tank containing fuel.
2. Electric Fuel Pump - On
3. Mixture - Rich
4. Carburetor Heat - On
5. Engine Gauges - Check for an indication of the cause of power loss.
6. Primer- Check Locked
7. If no fuel pressure is indicated, check tank selector position to be sure it is on a tank containing fuel.

When power is restored:

8. Carburetor Heat - Off
9. Electric Fuel Pump - Off

If the above steps do not restore power, prepare for an emergency landing.

If time permits:

1. Ignition Switch - "L" then "R" then back to "BOTH."
2. Throttle and Mixture - Different settings. (This may restore power if the problem is too rich or too lean a mixture, or if there is partial fuel system restriction.)
3. Try other fuel tank. (Water in the fuel could take some time to be used up, and allowing the engine to windmill may restore power. If power loss is due to water, fuel pressure indications will be normal.)

NOTE

If engine failure was caused by fuel exhaustion, power will not be regained after tanks are switched until empty fuel lines are filled, which may require up to ten seconds.

If power is not restored, proceed with POWER OFF LANDING procedure.

POWER OFF LANDING

If loss of power occurs at altitude, trim the aircraft for best gliding angle (80 MPH IAS - Air Cond. OFF) and look for a suitable field. If measures taken to restore power are not effective, and if time permits, check your charts for airports in the immediate vicinity; it may be possible to land at one if you have sufficient altitude. If possible, notify the FAA by radio of your difficulty and intentions. If another pilot or passenger is aboard, let them help.

When you have located a suitable field, establish a spiral pattern around this field. Try to be at 1000 feet above the field at the downwind position to make a normal approach. Excess altitude may be lost by widening your pattern, using flaps or slipping, or a combination of these.

Touchdown should normally be made at the lowest possible airspeed, with full flaps.

When committed to landing:

1. Ignition - Off
2. Master Switch - Off
3. Fuel Selector - Off
4. Mixture - Idle Cut-Off
5. Seat Belt (and harness if available) - Tight

SPINS

Intentional spins are prohibited in this aircraft. If a spin is inadvertently entered, immediately use the following recovery procedures:

1. THROTTLE - IDLE
2. RUDDER - FULL OPPOSITE TO DIRECTION OF ROTATION
3. CONTROL WHEEL - FULL FORWARD
4. RUDDER - NEUTRAL (WHEN ROTATION STOPS)
5. CONTROL WHEEL - AS REQUIRED TO SMOOTHLY REGAIN LEVEL FLIGHT ATTITUDE

OPEN DOOR

The cabin door on the Cherokee is double latched, so the chances of its springing open in flight at both the top and bottom are remote. However, should you forget the upper latch, or not fully engage the lower latch, the door may spring partially open. This will usually happen at takeoff or soon afterward. A partially open door will not affect normal flight characteristics, and a normal landing can be made with the door open.

CHEROKEE ARCHER

If both upper and lower latches are open, the door will trail slightly open, and airspeed will be reduced slightly.

To close the door in flight, proceed as follows:

1. Slow aircraft to 100 MPH IAS.
2. Cabin Vents - Close
3. Storm Window - Open
4. If upper latch is open - latch. If lower latch is open - open top latch, push door further open, and then close rapidly. Latch top latch.

A slip in the direction of the open door will assist in latching procedure.

FIRE

The presence of fire is noted through smoke, smell, and heat in the cabin. It is essential that the source of the fire be promptly identified through instrument readings, character of the smoke, or other indications, since the action to be taken differs somewhat in each case.

SOURCE OF FIRE- CHECK

1. Electrical Fire (Smoke in Cabin):
 - a. Master Switch - Off
 - b. Vents - Open
 - c. Cabin Heat - Off
 - d. Land as soon as possible.
2. Engine Fire (In Flight):
 - a. Fuel Selector - Off
 - b. Throttle - Closed
 - c. Mixture - Idle Cut-Off
 - d. Heater - Off (In all cases of fire)
 - e. Defroster - Off (In all cases of fire)
 - f. If terrain permits, land immediately.

NOTE

The possibility of an engine fire in flight is extremely remote. The procedure given above is general and pilot judgment should be the deciding factor for action in such an emergency.

3. Engine Fire (During Start):

Engine fires during start are usually the result of overpriming. The following procedure is designed to draw the excess fuel back into the induction system.

 - a. If engine has not started:
 - (1) Mixture - Idle Cut-Off
 - (2) Throttle - Open
 - (3) Turn engine with starter (This is an attempt to pull the fire into the engine.)

- b. If engine has already started and is running, continue operating to try pulling the fire into the engine.
- c. In either case stated in (a) and (b), if the fire continues longer than a few seconds, the fire should be extinguished by the best available external means.
- d. If external fire extinguishing is to be applied:
 - (1) Fuel Selector Valves - Off
 - (2) Mixture - Idle Cut-Off

LOSS OF OIL PRESSURE

Loss of oil pressure may be either partial or complete. A partial loss of oil pressure usually indicates a malfunction in the oil pressure regulating system, and a landing should be made as soon as possible to investigate the cause and prevent engine damage.

A complete loss of oil pressure indication may signify oil exhaustion or may be the result of a faulty gauge. In either case, proceed toward the nearest airport, and be prepared for a forced landing. If the problem is not a pressure gauge malfunction, the engine may stop suddenly. Maintain altitude until such time as a dead stick landing can be accomplished. Don't change power settings unnecessarily, as this may hasten complete power loss.

Depending on the circumstances, it may be advisable to make an off airport landing while power is still available, particularly if other indications of actual oil pressure loss, such as sudden increases in temperatures, or oil smoke, are apparent, and an airport is not close.

If engine stoppage occurs, proceed to POWER OFF LANDING.

LOSS OF FUEL PRESSURE

1. Electric Boost Pump - On
2. Fuel Selector - Check on full tank

If problem is not an empty fuel tank, land as soon as practical and have engine-driven fuel pump checked.

HIGH OIL TEMPERATURE

An abnormally high oil temperature indication may be caused by a low oil level, an obstruction in the oil cooler, damaged or improper baffle seals, a defective gauge, or other causes. Land as soon as practical at an appropriate airport and have the cause investigated.

A steady, rapid rise in oil temperature is a sign of trouble. Land at the nearest airport and let a mechanic investigate the problem. Watch the oil pressure gauge for an accompanying loss of pressure.

CHEROKEE ARCHER

ALTERNATOR FAILURE

Loss of alternator output is detected through a zero reading on the ammeter. Before executing the following procedure, insure that the reading is zero and not merely low by actuating an electrically powered device, such as the landing light. If no increase in the ammeter reading is noted, alternator failure can be assumed.

1. Reduce Electrical Load.
2. Alternator Circuit Breakers- Check
3. "Alt" Switch - Off (for 1 second), then On

If the ammeter continues to indicate no output, or alternator will not stay reset, turn off "Alt" switch, maintain minimum electrical load and land as soon as practical. All electrical load is being supplied by the battery.

ENGINE ROUGHNESS

Engine roughness is usually due to carburetor icing which is indicated by a drop in RPM, and may be accompanied by a slight loss of airspeed or altitude. If too much ice is allowed to accumulate, restoration of full power may not be possible; therefore, prompt action is required.

Turn carburetor heat on (See Note). RPM will decrease slightly and roughness will increase. Wait for a decrease in engine roughness or an increase in RPM, indicating ice removal. If no change in approximately one minute, return the carburetor heat to COLD. If the engine is still rough, try steps below:

1. Mixture - Adjust for maximum smoothness. Engine will run rough if too rich or too lean.
2. Electric Fuel Pump - On
3. Fuel Selector - Change tanks to see if fuel contamination is the problem.
4. Engine Gauges - Check for abnormal readings. If any gauge readings are abnormal, proceed accordingly.
5. Magneto Switch - "L" then "R", then back to "BOTH." If operation is satisfactory on either magneto, proceed on that magneto at reduced power, with mixture full rich, to a landing at the first available airport.

If roughness persists, prepare for a precautionary landing at pilot's discretion.

NOTE

Partial carburetor heat may be worse than no heat at all, since it may partially melt ice, which will refreeze in the intake system. When using carburetor heat, therefore, always use full heat, and when ice is removed return the control to the full cold position.

WEIGHT AND BALANCE

Log of Revisions.....	5-iii
Weight and Balance	5-1
Weight and Balance Data - Weighing Procedure.....	5-3
Weight and Balance Data.....	5-7
C. G. Range and Weight Instructions	5-8
Equipment List	5-11

WEIGHT AND BALANCE FOR CHEROKEE ARCHER

APPLICABLE TO SERIAL NUMBERS 28-7405001 THROUGH 28-7505259

WARNING

EXTREME CARE MUST BE EXERCISED TO LIMIT THE USE OF THIS REPORT TO APPLICABLE AIRCRAFT. THIS REPORT REVISED AS INDICATED BELOW OR SUBSEQUENTLY REVISED IS VALID FOR USE WITH THE AIRPLANE IDENTIFIED BELOW WHEN APPROVED BY PIPER AIRCRAFT CORPORATION. SUBSEQUENT REVISIONS SUPPLIED BY PIPER AIRCRAFT CORPORATION MUST BE PROPERLY INSERTED.

MODEL PA-28-180

AIRCRAFT SERIAL NO. _____ REGISTRATION NO. _____

WEIGHT AND BALANCE, REPORT NUMBER VB-547 REVISION _____

PIPER AIRCRAFT CORPORATION
APPROVAL SIGNATURE AND STAMP _____

ISSUED: MAY 14, 1973
REVISED: NOVEMBER 21, 1975

REPORT: VB-547
MODEL: PA-28-180

WEIGHT AND BALANCE LOG OF REVISIONS

Revision	Revised Pages	Description and Revision	Approved Date
1	5-11	Revised Propeller Weight and Moment;	Nov. 6, 1973
	5-13	Revised Spinner Weight, Arm and Moment. Added Arm and Moment and Removed Dwg. No. for Nose Wheel.	
	5-14	Revised Voltage Regulator and Battery Weights and Moments.	
	5-16	Revised Toe Brakes Weight and Moment.	
	5-18	Revised Battery Weights and Moment.	
	5-23	Revised Selector Panel and Marker Beacon Weights, Arms and Moments.	
	5-25	Revised Microphones Weights, Arms and Moments.	
	5-26	Revised Main and Nose Wheel Fairings Weights, Arms and Moments; Revised Left and Right Vert. Adj. Front Seats Weights, Arms and Moments; Added Overhead Vent System and revised Weight and Moment for Ground Vent Blower; Revised Overhead Vent System Weight, Arm and Moment.	
	5-27	Added Corrosive Resistant Kit.	<i>N. J. Pratt</i>
2	Title	Added PAC Approval Form. (NOTE: AIRCRAFT DELIVERED WITH MANUALS PRIOR TO THIS REVISION DO NOT REQUIRE THIS REVISION.)	May 30, 1974
3	5-12	Added Oil Filters; added footnote.	June 17, 1974
	5-14	Added Annunciator Lights and footnote.	
	5-16	Revised Inertia Safety Belts Weights, Moment and Part No.	
	5-17	Added Oil Filter - Lycoming, Vacuum Pump - Airborne, Low Vacuum Regulator Light, and Vacuum Regulator- Airborne #2H3-19; revised Weight and Moment of Vacuum Regulator - Airborne #133A4; added footnotes.	
	5-20	Added Encoding Altimeter and footnote.	
	5-21	Added AutoControl IIIB and footnotes.	
	5-22	Revised King VHF Transceivers and added footnotes.	

ISSUED: MAY 14, 1973
 REVISED: JUNE 17, 1974

REPORT: VB-547 PAGE 5-iii
 MODEL: PA-28-180

WEIGHT AND BALANCE LOG OF REVISIONS (cont)

Revision	Revised Pages	Description and Revision	Approved Date
7	5-1 5-3 5-7	Revised text info. Revised text info. Revised Weight and Balance Data.	<p><i>Ward Evans</i> March 16, 1984</p>

WEIGHT AND BALANCE

In order to achieve the performance and flying characteristics which are designed into the airplane, it must be flown with the weight and center of gravity (C.G.) position within the approved envelope. The aircraft offers flexibility in loading. However, you cannot fill the airplane, with the maximum number of adult passengers, full fuel tanks and maximum baggage. With the flexibility comes responsibility. The pilot must insure that the airplane is loaded within the loading envelope before he makes a takeoff.

Misloading carries consequences for any aircraft. An overloaded airplane will not take off, climb or cruise as well as a properly loaded one. The heavier the airplane is loaded, the less climb performance it will have.

Center of gravity is a determining factor in flight characteristics. If the C.G. is too far forward in any airplane, it may be difficult to rotate for takeoff or landing. If the C.G. is too far aft, the airplane may rotate prematurely on takeoff or try to pitch up during climb. Longitudinal stability will be reduced. This can lead to inadvertent stalls and even spins; and spin recovery becomes more difficult as the center of gravity moves aft of the approved limit.

A properly loaded aircraft, however, will perform as intended. Before the airplane is licensed, a basic weight and C.G. location is computed. (Basic weight consists of the empty weight of the aircraft plus the unusable fuel and full oil capacity.) Using the basic weight and C.G. location, the pilot can easily determine the weight and C.G. position for the loaded airplane by computing the total weight and moment and then determining whether they are within the approved envelope.

The basic weight and C.G. location for a particular airplane are recorded in the Weight and Balance section of the Airplane Flight Manual. The current values should always be used. Whenever new equipment is added or any modification work is done, the mechanic responsible for the work is required to compute a new basic weight and basic C.G. position and to write these in the aircraft log book. The owner should make sure that it is done.

A weight and balance calculation is necessary in determining how much fuel or baggage can be boarded so as to keep within allowable limits. Check calculations prior to adding fuel to insure against improper loading.

The following pages are forms used in weighing an airplane in production and in computing basic weight, basic C.G. position, and useful load. Note that the useful load includes fuel, oil, baggage, cargo and passengers. Following this is the method for computing takeoff weight and C.G.

THIS PAGE INTENTIONALLY LEFT BLANK

WEIGHT AND BALANCE DATA

WEIGHING PROCEDURE

At the time of licensing, Piper Aircraft Corporation provides each airplane with the licensed empty weight and center of gravity location. This data is on Page 5-7.

The removal or addition of an excessive amount of equipment or excessive airplane modifications can affect the licensed empty weight and empty weight center of gravity. The following is a weighing procedure to determine this licensed empty weight and center of gravity location:

1. PREPARATION

- a. Be certain that all items checked in the airplane equipment list are installed in the proper location in the airplane.
- b. Remove excessive dirt, grease, moisture, foreign items such as rags and tools from the airplane before weighing.
- c. Defuel airplane. Then open all fuel drains until all remaining fuel is drained. Operate engine on each tank until all undrainable fuel is used and engine stops.
- d. Drain all oil from the engine, by means of the oil drain, with the airplane in ground attitude. This will leave the undrainable oil still in the system. Engine oil temperature should be in the normal operating range before draining.
- e. Place pilot and copilot seats in fourth (4th) notch, aft of forward position. Put flaps in the fully retracted position and all control surfaces in the neutral position. Tow bar should be in the proper location and all entrance and baggage doors closed.
- f. Weigh the airplane inside a closed building to prevent errors in scale readings due to wind.

2. LEVELING

- a. With airplane on scales, block main gear oleo pistons in the fully extended position.
- b. Level airplane (see diagram) deflating nose wheel tire, to center bubble on level.

CHEROKEE ARCHER

3. WEIGHING - AIRPLANE EMPTY WEIGHT

- a. With the airplane level and brakes released, record the weight shown on each scale. Deduct the tare, if any, from each reading.

Scale Position and Symbol	Scale Reading	Tare	Net Weight
Nose Wheel (N)			
Right Main Wheel (R)			
Left Main Wheel (L)			
Airplane Empty Weight, as Weighed (T)			

4. EMPTY WEIGHT CENTER OF GRAVITY

- a. The following geometry applies to the PA-28-180 airplane when airplane is level (See Item 2).

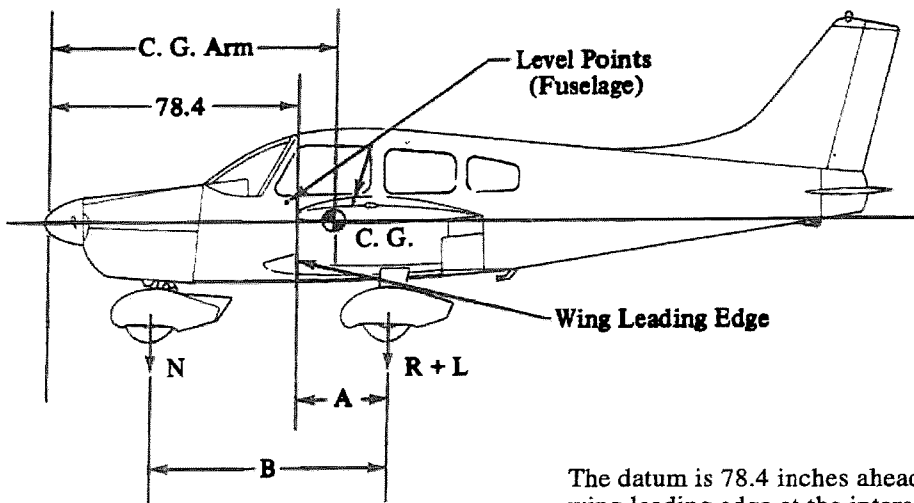

The datum is 78.4 inches ahead of the wing leading edge at the intersection of the straight and tapered section.

A =

B =

- b. Obtain measurement "A" by measuring from a plumb bob dropped from one wing leading edge, at the intersection of the straight and tapered section, horizontally and parallel to the airplane centerline, to the main wheel centerline.
- c. Obtain measurement "B" by measuring the distance from the main wheel centerline, horizontally and parallel to the airplane centerline, to each side of the nose wheel axle. Then average the measurements.
- d. The empty weight center of gravity (as weighed including optional equipment and undrainable oil) can be determined by the following formula:

$$C.G. \text{ Arm} = 78.4 + A - \frac{B(N)}{T}$$

$$C. G. \text{ Arm} = 78.4 + (\quad) - \frac{(\quad)(\quad)}{(\quad)} = \quad \text{inches}$$

5. LICENSED EMPTY WEIGHT AND EMPTY WEIGHT CENTER OF GRAVITY

	Weight	Arm	Moment
Empty Weight (as weighed)			
Unusable Fuel (13-1/3 pints)	+10.0	103.0	+1030
Licensed Empty Weight			

THIS PAGE INTENTIONALLY LEFT BLANK

WEIGHT AND BALANCE DATA

MODEL PA-28-180 CHEROKEE

Airplane Serial Number _____

Registration Number _____

Date _____

AIRPLANE EMPTY WEIGHT

Item	Weight (Lbs)		X	C. G. Arm (Inches Aft of Datum)	=	Moment (In-Lbs)
	Actual	Computed				
*Empty Weight						
Unusable Fuel (13-1/3 pints)			10.0	103.0		1030
Standard Empty Weight						
Optional Equipment						
Licensed Empty Weight						

*Empty weight is defined as dry empty weight (including paint and hydraulic fluid) plus 1.8 lbs undrainable engine oil.

AIRPLANE USEFUL LOAD

$$(\text{Gross Weight}) - (\text{Licensed Empty Weight}) = \text{Useful Load}$$

Normal Category: (2450 lbs) - (lbs) = lbs
 Utility Category: (1950 lbs) - (lbs) = lbs

THIS LICENSED EMPTY WEIGHT, C.G. AND USEFUL LOAD FOR THE AIRPLANE AS LICENSED AT THE FACTORY. REFER TO APPROPRIATE AIRCRAFT RECORD WHEN ALTERATIONS HAVE BEEN MADE.

ISSUED: MAY 14, 1973
 REVISED: MARCH 16, 1984

REPORT: VB-547 PAGE 5-7
 MODEL: PA-28-180

C. G. RANGE AND WEIGHT INSTRUCTIONS

1. Add the weight of all items to be loaded to the licensed empty weight.
2. Use the loading graph to determine the moment of all items to be carried in the airplane.
3. Add the moment of all items to be loaded to the licensed empty weight moment.
4. Divide the total moment by the total weight to determine the C.G. location.
5. By using the figures of Item 1 and Item 4, locate a point on the C.G. range and weight graph. If the point falls within the C.G. envelope, the loading meets the weight and balance requirements.

SAMPLE LOADING PROBLEM (Normal Category)

	Weight (Lbs)	Arm Aft Datum (Inches)	Moment (In-Lbs)
Licensed Empty Weight			
Oil (8 quarts)	15	27.5	413
Pilot and Front Passenger	340	80.5	27370
Passengers, Aft* (Rear Seat)	340	118.1	40154
Fuel (48 Gal. Maximum)		95.0	
Baggage*		142.8	
Total Loaded Airplane			

The center of gravity (C.G.) of this sample loading problem is at _____ inches aft of the datum line. Locate this point (_____) on the C.G. range and weight graph. Since this point falls within the weight - C.G. envelope, this loading meets the weight and balance requirements.

IT IS THE RESPONSIBILITY OF THE PILOT AND AIRCRAFT OWNER TO INSURE THAT THE AIRPLANE IS LOADED PROPERLY.

*Utility Category Operation - No baggage or aft passengers allowed.

LOADING GRAPH

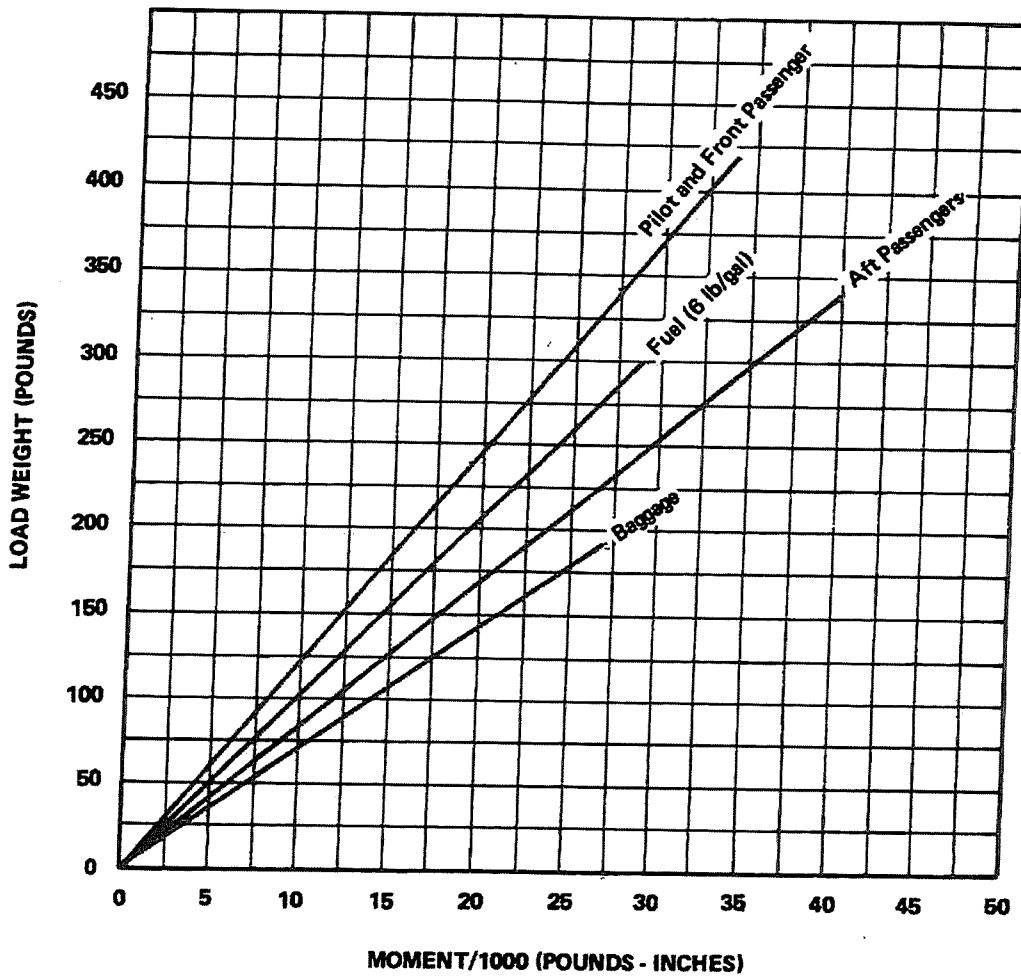

ISSUED: MAY 14, 1973

REPORT: VB-547 PAGE 5-9
MODEL: PA-28-180

C.G. RANGE AND WEIGHT

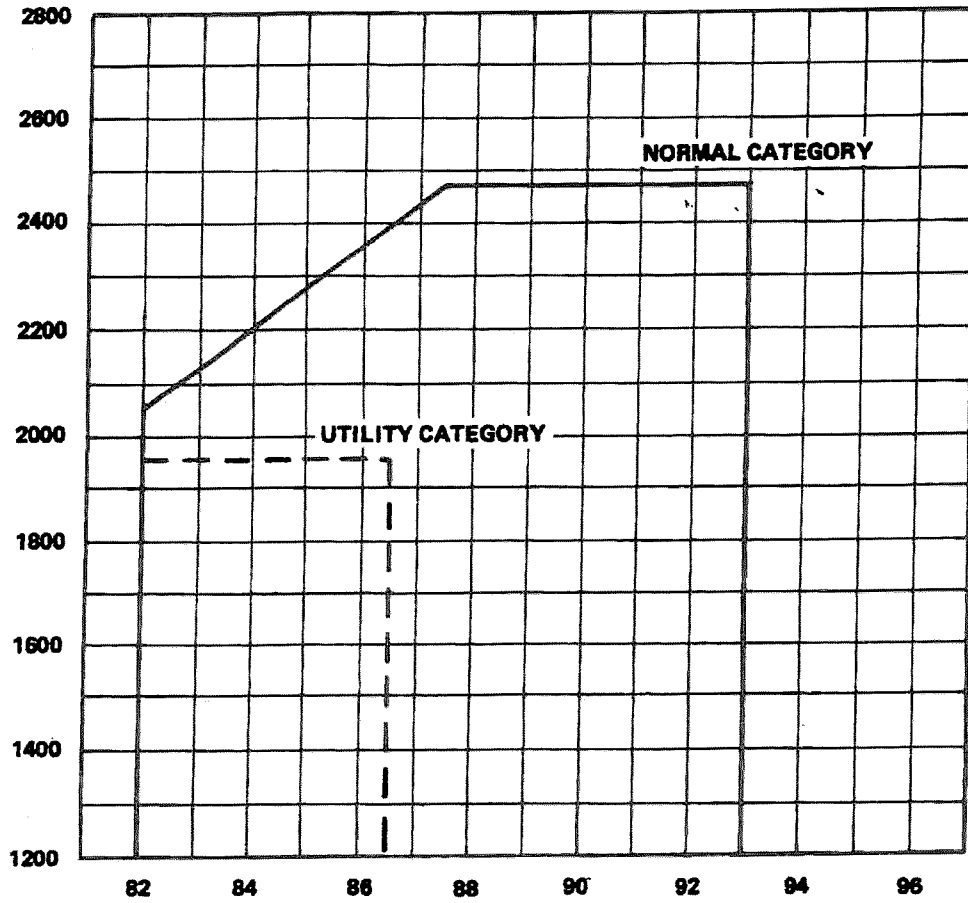

EQUIPMENT LIST

The following is a list of equipment which may be installed in the PA-28-180. Items marked with an "X" are items installed when the airplane was delivered by the manufacturer.

Item	Item	Weight Lbs.	Arm Aft Datum	Moment	Cert. Basis
A.	Propeller and Propeller Accessories				
_____	Propeller, Sensenich 76EM8S5-0-60 Piper Spec. PS50077-8	39.2	3.8	149	TC P4EA
_____	Spinner and Attachment Plates Piper Dwg. 65803, 65804, 65805	4.5	3.4	15	TC 2A13

CHEROKEE ARCHER

Item	Item	Weight Lbs.	Arm Aft Datum	Moment	Cert. Basis
	C. Landing Gear and Brakes				
_____	Two Main Wheel Assemblies Piper Dwg. 63370-0 & -1	32.3	109.6	3540	TC 2A13
	(a) Cleveland Aircraft Products Wheel Assembly No. 40-86 Brake Assembly No. 30-55				
	(b) Two Main 4-Ply Rating Tires 6.00-6 with Regular Tubes				
_____	One Nose Wheel 6.00-6	12.8	31.0	397	TC 2A13
	(a) Cleveland Aircraft Products Wheel Assembly No. 40-76B (Less Brake Drum)				
	(b) One Nose Wheel 4-Ply Rating Tire 6.00-6 with Regular Tube				

CHEROKEE ARCHER

Item	Item	Weight Lbs.	Arm Aft Datum	Moment	Cert. Basis
E.	Instruments				
_____	Compass - Piper Dwg. 67462	.9	59.9	54	TSO C7c
_____	Airspeed Indicator Piper Dwg. 63205-2	.6	61.8	37	TSO C2b
_____	Tachometer, Piper Dwg. 62177-3	.7	61.2	43	TC 2A13
_____	Altimeter, Piper PS50008-2 or -3	1.0	60.9	61	TSO C10b
_____	Engine Cluster, Piper Dwg 95241-14	.8	62.4	50	TC 2A13
_____	Engine Cluster, Piper Dwg. 95241-11	.8	62.4	50	TC 2A13

ISSUED: MAY 14, 1973
 REVISED: JANUARY 20, 1975

REPORT: VB-547 PAGE 5-15
 MODEL: PA-28-180

CHEROKEE ARCHER

Item	Item	Weight Lbs.	Arm Aft Datum	Moment	Cert. Basis
G.	Engine and Engine Accessories (Optional Equipment)				
_____	Vacuum Pump, Airborne Mfg. Co., Model No. 10-113A1, 113A5, or 200cc and Drive	5.0	32.0	160	TC 2A13
_____	Oil Filter - Lycoming No. 75528 (AC *OF5578770) *	3.3	35.5	117	TC 2A13
_____	Oil Filter - Lycoming *LW-13743 (Champion *CH-48110)*	2.8	35.5	99	TC 2A13
_____	Vacuum Regulator, Airborne* Mfg. Co., #133A4	.6	52.0	31	TC 2A13
_____	Vacuum Filter, Airborne Mfg. Co., #1J7-1 Piper Dwg. 66673	.3	52.0	16	TC 2A13
_____	Vacuum Pump, Airborne Mfg. Co., Model 211cc and Drive, PAC 79399-0	3.2	32.0	103	TC 2A13
_____	Low Vacuum Annunciator Light **	Neglect			TC 2A13
_____	Vacuum Regulator, Airborne ** Mfg. Co. #2H3-19	.5	52.0	26	TC 2A13

*Serial nos. 7405001 through 7405290
 **Serial nos. 7505001 and up

Item	Item	Weight Lbs.	Arm Aft Datum	Moment	Cert. Basis
H. Electrical Equipment (Optional Equipment) (cont)					
Red Strobe Light, Whelen Engineering Co. Piper Dwg. 99033					
_____	Power Supply, Whelen Model HS *A4-12A-14 with Fin Light only	2.3	198.0	455	TC 2A13
_____	Light (Fin Tip)	.4	263.4	105	TC 2A13
_____	Cable	.4	230.7	92	TC 2A13
Red/White Strobe Light, Whelen Engineering Co.					
_____	Power Supply, Whelen Model HD, T3	3.0	198.0	594	TC 2A13
_____	Light (Fin Tip)	.4	263.4	105	TC 2A13
_____	Cable	.4	230.7	92	TC 2A13
_____	Lights (Wing Tip) (2)	.3	106.6	32	TSO C30b
_____	Cables	2.0	115.6	231	TC 2A13

CHEROKEE ARCHER

Item	Item	Weight Lbs.	Arm Aft Datum	Moment	Cert. Basis
J. Autopilots (Optional Equipment)					
AutoControl III *					
_____	Roll Servo, *1C363-1-183R	2.5	122.2	306	STC SA1406SW
_____	Console, *1C338 (thru S/N 9999)	1.2	60.1	72	STC SA1406SW
_____	Cables	.7	95.5	67	STC SA1406SW
_____	Attitude Gyro, *52D66	2.3	59.4	137	STC SA1406SW
_____	Directional Gyro, *52D54	3.2	59.0	189	STC SA1406SW
_____	Omni Coupler, *1C388	.9	59.3	53	STC SA1406SW
AutoFlite II					
_____	Roll Servo, *1C363-1-183R	2.5	122.2	306	STC SA1406SW
_____	Cable	.7	93.4	65	STC SA1406SW
_____	Panel Unit, *52D75-3 or -4	2.4	59.4	143	STC SA1406SW
AutoControl III B **					
_____	Roll Servo *1C363-1-183R	2.5	122.2	306	STC SA1406SW
_____	Console, *1C338 (S/N 10000 & up)	1.0	60.1	60	STC SA1406SW
_____	Cables	.5	95.5	48	STC SA1406SW
_____	Attitude Gyro, *52D66	2.7	59.4	160	STC SA1406SW
_____	Directional Gyro, *52D54	2.9	59.0	171	STC SA1406SW
_____	Omni Coupler, *1C388	1.0	59.3	59	STC SA1406SW

* Serial nos. 7405001 through 7405290

**Serial nos. 7505001 and up

CHEROKEE ARCHER

Item	Item	Weight Lbs.	Arm Aft Datum	Moment	Cert. Basis
K. Radio Equipment (Optional Equipment) (cont)					
_____	Narco CP-25B/125 Selector Panel *	1.2	55.0	66	TC 2A13
_____	Narco MBT-12-R Marker Beacon	3.1	69.1	214	TC 2A13
_____	Narco Comm 110*	3.0	57.4	172	TC 2A13
_____	Narco Comm 111	3.0	57.4	172	TC 2A13
_____	Narco Nav 110*	1.7	58.6	100	TC 2A13
_____	Narco Nav 111	2.5	58.6	147	TC 2A13
_____	Narco Nav 112	3.3	58.6	193	TC 2A13
_____	King KX-170/175 () (VHF Comm/Nav)				
_____	Transceiver, Single	7.5	56.6	425	TC 2A13
_____	Transceiver, Dual	15.0	56.6	849	TC 2A13
_____	King KI-201 () VOR/LOC Ind.	2.5	59.6	149	TC 2A13
_____	King Dual KI-201 () VOR/LOC Ind.	5.0	59.9	300	TC 2A13
_____	King KI-214 () VOR/LOC/GS Ind.	3.3	59.9	198	TC 2A13
_____	Nav Receiving Antenna	.5	265.0	133	TC 2A13
_____	Cable, Nav Antenna	.9	157.0	141	TC 2A13
_____	*1 VHF Comm Antenna	.3	157.8	47	TC 2A13
_____	Cable, Antenna *1 VHF	.4	103.4	41	TC 2A13
_____	*2 VHF Comm Antenna	.3	192.8	58	TC 2A13
_____	Cable, Antenna *2 VHF	.5	120.9	60	TC 2A13

*Serial nos. 7405001 through 7405290

ISSUED: MAY 14, 1973
REVISED: JUNE 17, 1974

REPORT: VB-547 PAGE 5-23
MODEL: PA-28-180

CHEROKEE ARCHER

Item	Item	Weight Lbs.	Arm Aft Datum	Moment	Cert. Basis
K.	Radio Equipment (Optional Equipment) (cont)				
_____	Narco AT-50A Transponder Panel Unit	* 3.0	57.3	172	TC 2A13
_____	King KT76/78 Transponder Panel Unit	3.1	58.1	180	TC 2A13
_____	Antenna and Cable	—	—	—	TC 2A13
_____	King KMA-20 () Audio Panel	2.8	60.2	169	TC 2A13
_____	Antenna	.5	116.3	58	TC 2A13
_____	Cable	.4	87.5	35	TC 2A13
_____	King KN60C DME Receiver	6.8	56.7	386	TC 2A13
_____	Antenna	.2	107.1	21	TC 2A13
_____	Cable, Antenna	0.3	80.6	24	TC 2A13
_____	Piper Automatic Locator, Piper Dwg. 99890 Transmitter	1.7	236.2	402	TC 2A13
_____	Antenna and Cable	.2	224.4	45	TC 2A13
_____	Shelf and Access Plate	.3	235.4	71	TC 2A13
_____	Audio Selector Panel,** Piper Dwg. 99395-0, -2 or -3	.7	61.3	43	TC 2A13
_____	Microphone (Dynamic) Piper Dwg. 68856-12	.3	64.9	19	TC 2A13
_____	Microphone (Carbon), Piper Dwg. 68856-10	.3	64.9	19	TC 2A13
_____	Headset, Piper Dwg. 68856-10	.5	60.0	30	TC 2A13

* Weight includes Antenna and Cable.

** Serial nos. 7405001 through 7405290

Item	Item	Weight Lbs.	Arm Aft Datum	Moment	Cert. Basis
K.	Radio Equipment (Optional Equipment) (cont)				
_____	Narco Dual Comm 111B VHF Transceiver *	7.8	57.4	448	TC 2A13
_____	Narco Nav 14 VHF Receiver *	2.5	57.4	144	TC 2A13
_____	Narco Nav 114 VHF Receiver *	2.5	57.4	144	TC 2A13
_____	Narco UGR-3 Glide Slope *				
_____	Receiver	2.4	173.8	417	TC 2A13
_____	Cable	1.8	128.0	230	TC 2A13
_____	Antenna	0.4	87.4	35	TC 2A13
_____	Cable, Antenna	0.5	145.0	73	TC 2A13
_____	Narco CP-125 Audio Selector Panel *	2.2	55.0	121	TC 2A13
_____	Narco ADF-140 *				
_____	Receiver	2.5	58.3	146	TC 2A13
_____	Servo Indicator	1.3	61.0	79	TC 2A13
_____	Loop Antenna	1.6	162.0	259	TC 2A13
_____	Cable, Loop	0.6	105.5	63	TC 2A13
_____	Sense Antenna and Cable	0.4	147.5	59	TC 2A13
_____	Narco Dual ADF-140 *				
_____	Receivers	5.0	58.3	292	TC 2A13
_____	Dual Needle Indicator	3.5	61.0	214	TC 2A13
_____	Loop Antenna *1	1.6	162.0	259	TC 2A13
_____	Cable, Loop *1	0.6	105.5	63	TC 2A13
_____	Sense Antenna and Cable *1	0.4	143.8	58	TC 2A13
_____	Loop Antenna *2	1.6	150.0	240	TC 2A13
_____	Cable, Loop *2	0.6	93.5	56	TC 2A13
_____	Sense Antenna and Cable *2	3.0	143.8	431	TC 2A13
_____	Remote for Dual Ind.	2.0	185.5	371	TC 2A13
_____	Narco DME-190 *				
_____	Receiver	5.2	61.8	321	TC 2A13
_____	Antenna	0.3	113.9	34	TC 2A13
_____	Cable, Antenna	0.4	85.6	34	TC 2A13
_____	Microphone (Dynamic)* Piper Dwg. 68856-11	0.6	69.9	42	TC 2A13

* Serial nos. 7505001 and up

CHEROKEE ARCHER

Item	Item	Weight Lbs.	Arm Aft Datum	Moment	Cert. Basis
L. Miscellaneous (Optional Equipment) (cont)					
_____	Overhead Vent System with Ground Ventilating Blower Piper Dwg. 76304-2	13.2	170.4	2249	TC 2A13
_____	Overhead Vent System Piper Dwg. 76304-0	5.6	157.3	881	TC 2A13
_____	Overhead Vent System, Piper Dwg. 76304-9	6.4	159.6	1022	TC 2A13
_____	Overhead Vent System with Ground Ventilating Blower, Piper Dwg. 76304-10	14.0	170.7	2390	TC 2A13
_____	Alternate Static Source	.4	61.0	24	TC 2A13
	Calibrated Alternate Static Source				
	Placard Required: Yes _____ No _____				
_____	Headrest (2) (Front) Piper Dwg. 99255-3 or 79337-18	2.2	94.5	208	TC 2A13
_____	Headrest (2) (Rear) Piper Dwg. 99255-3 or 79337-18	2.2	132.1	291	TC 2A13
_____	Air Conditioning Installation 99575-0	67.4	102.8	6929	TC 2A13
_____	Zinc Chromate Finish Piper Dwg. 65665	5.0	158.0	790	TC 2A13
_____	Corrosive Resistant Kit	3.0	106.0	318	TC 2A13
_____	Stainless Steel Control Cables	—	—	—	TC 2A13
	TOTAL OPTIONAL EQUIPMENT	_____	_____	_____	

LOADING INSTRUCTIONS

**THIS SECTION IS NOT
APPLICABLE TO THIS AIRPLANE**

BLANK PAGE

OPERATING INSTRUCTIONS

Preflight	7-1
Starting Engine	7-2
Starting Engine When Cold	7-2
Starting Engine When Hot	7-2
Starting Engine When Flooded	7-3
Starting Engine With External Power Source	7-3
Warm-Up and Ground Check	7-3
Takeoff	7-4
Climb	7-4
Stalls	7-5
Cruising	7-5
Rough Air Operation	7-6
Approach and Landing	7-6
Stopping Engine	7-6
Airspeed Data	7-7
Engine Power Loss	7-7
Mooring	7-7
Weight and Balance	7-7
Emergency Locator Transmitter	7-8
Air Conditioning	7-9
Air Conditioner Operational Check Procedure	7-10
Air Conditioner Effects on Airplane Performance	7-10

BLANK PAGE

OPERATING INSTRUCTIONS

PREFLIGHT

1.
 - a. Release seat belt securing controls.
 - b. Master switch ON.
 - c. Check fuel quantity indicators.
 - d. Master switch and ignition OFF.
2.
 - a. Check for external damage and operational interference of control surfaces or hinges.
 - b. Insure that wings and control surfaces are free of snow, ice or frost.
3.
 - a. Visually check fuel supply and secure caps.
 - b. Drain fuel tank sumps (two), check for water, sediment and proper fuel.
 - c. Drain fuel system sump (left side of aircraft), check for water, sediment and proper fuel.
 - d. Check that fuel system vents are open.
 - e. Check main landing gear shock struts for proper inflation (approximately 4.50 inches showing).
 - f. Check tires for cuts, wear and proper inflation.
 - g. Check brake blocks and discs for wear and damage.

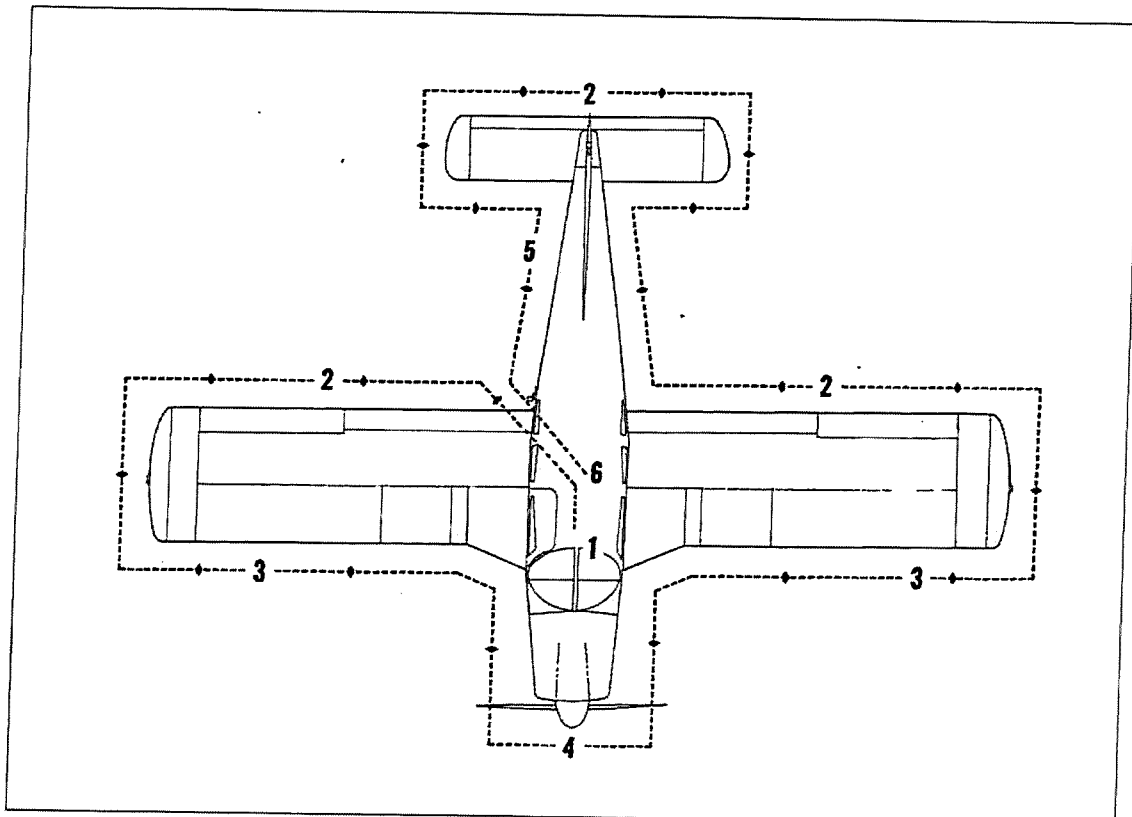

CHEROKEE ARCHER

4.
 - a. Check windshield for cleanliness.
 - b. Check propeller and spinner for defects or nicks.
 - c. Check for obvious fuel or oil leaks.
 - d. Check oil level (Insure dipstick is properly seated.)
 - e. Check cowling and inspection covers for security.
 - f. Check nose wheel tire for inflation and wear.
 - g. Check nose gear shock strut for proper inflation (approximately 3.25 inches showing).
 - h. Check for foreign matter in air inlets.
5.
 - a. Stow tow bar and control locks if used.
 - b. Check baggage for storage and security.
 - c. Close and secure the baggage compartment door.
6.
 - a. Upon entering airplane remove seat belt securing control wheel. Check that all primary flight controls operate properly.
 - b. Close and secure cabin door.
 - c. Check that required papers are in order and in the airplane.
 - d. Fasten seat belts and shoulder harness. Check function of inertia reel.

STARTING ENGINE

1. Set parking brake ON.
2. Set the carburetor heat control in the full COLD position.
3. Select the desired tank with fuel selector valve.

STARTING ENGINE WHEN COLD

1. Open throttle approximately 1/4 inch.
2. Turn the master switch ON.
3. Turn the electric fuel pump ON.
4. Move the mixture control to FULL RICH.
5. Engage the starter by rotating magneto switch clockwise and pressing in.
6. When the engine fires, advance throttle to desired setting. If the engine does not fire within five to ten seconds, disengage starter and prime with one to three strokes of the priming pump. Repeat starting procedure.

STARTING ENGINE WHEN HOT

1. Open the throttle approximately 1/2 inch.
2. Turn the master switch ON.
3. Turn the electric fuel pump ON.
4. Put mixture control in FULL RICH.
5. Engage the starter by rotating magneto switch clockwise and pressing in. When the engine tires, move the throttle to desired setting.

STARTING ENGINE WHEN FLOODED

1. Open the throttle full.
2. Turn the master switch ON.
3. Turn the electric fuel pump OFF.
4. Put mixture control in IDLE CUT-OFF.
5. Engage the starter by rotating magneto switch clockwise and pressing in. When the engine fires, advance the mixture control and retard the throttle.

When the engine is firing evenly, advance the throttle to 800 RPM. If oil pressure is not indicated within thirty seconds, stop the engine and determine the trouble. In cold weather it will take a few seconds longer to get an oil pressure indication. If the engine has failed to start, refer to the "Lycoming Operating Handbook, Engine Troubles and Their Remedies."

Starter manufacturers recommend that cranking periods be limited to thirty seconds with a two minute rest between cranking periods. Longer cranking will shorten the life of the starter.

STARTING ENGINE WITH EXTERNAL POWER SOURCE*

An optional feature known as Piper External Power (PEP) allows the operator to use an external battery to crank the engine without having to gain access to the aircraft battery.

The procedure is as follows:

1. Turn aircraft MASTER SWITCH to OFF.
2. Connect RED lead of PEP kit jumper cable to POSITIVE (+) terminal of external 12-volt battery and BLACK lead to NEGATIVE (-) terminal.
3. Insert plug of jumper cable into socket located on aircraft fuselage.
4. Turn aircraft MASTER SWITCH to ON and proceed with NORMAL engine starting technique.
5. After engine has been started, turn MASTER SWITCH to OFF and remove jumper cable plug from aircraft.
6. Turn aircraft MASTER SWITCH to ON and check alternator ammeter for indication of output. DO NOT ATTEMPT FLIGHT IF THERE IS NO INDICATION OF ALTERNATOR OUTPUT.

WARM-UP AND GROUND CHECK

Warm-up the engine at 800 to 1200 RPM for not more than two minutes in warm weather, four minutes in cold weather. Avoid prolonged idling at low RPM as this practice may result in fouled spark plugs. If necessary to hold before takeoff, it is recommended that the engine be idled at 1200 RPM.

The magnetos should be checked at 2000 RPM. The drop on either magneto should not exceed 175 RPM and should be within 50 RPM of the other. Prolonged operation on one magneto should be avoided.

Check vacuum gauge; indicator should read 5" ± .1 " Hg at 2000 RPM.

*Optional equipment

CHEROKEE ARCHER

Check both the oil temperature and pressure. The temperature may be low for some time if the engine is being run for the first time of the day, but as long as the pressure is within limits, the engine is ready for takeoff. Release the parking brake prior to taxiing.

Check the annunciator panel lights with the press-to-test button.*

Carburetor heat should also be checked prior to takeoff to be sure that the control is operating properly and to clear any ice which may have formed during taxiing. Avoid prolonged ground operation with carburetor heat ON as the air is unfiltered.

Operation of the engine driven fuel pump should be checked while taxiing or during pretake-off engine run up by switching off the electric fuel pump and observing fuel pressure. The electric fuel pump should be on during takeoff to prevent loss of power should the engine driven pump fail. The engine is warm enough for takeoff when the throttle can be opened without the engine faltering. For air conditioner ground check refer to page 7-8.

TAKEOFF

Just before takeoff the following items should be checked:

1. Fuel on proper tank
2. Electric fuel pump - on
3. Engine gauges - checked
4. Flaps - set
5. Carburetor heat - off
6. Mixture - set
7. Seat backs - erect
8. Safety Belts/harness - fastened
9. Empty seats - seat belts snugly fastened
10. Trim tab - set
11. Controls - free
12. Door - latched
13. Air conditioner - off

The takeoff technique is conventional for the Cherokee. The tab should be set slightly aft of neutral, with the exact setting determined by the loading of the aircraft. Allow the airplane to accelerate to 50 to 60 MPH, then ease back on the wheel enough to let the airplane fly itself from the ground. Premature raising of the nose or raising it to an excessive angle will result in a delayed takeoff. After takeoff let the aircraft accelerate to the desired climb speed by lowering the nose slightly.

Takeoffs are normally made with flaps up. However, for short field takeoffs, and for takeoffs under difficult conditions such as deep grass or on a soft surface, distances can be reduced appreciably by lowering flaps to 25°.

CLIMB

The best rate of climb at gross weight will be obtained at 85 MPH. The best angle of climb may be obtained at 74 MPH. At lighter than gross weight these speeds are reduced somewhat. For climbing en route a speed of 100 MPH is recommended. This will produce better forward speed and increased visibility over the nose during the climb. The air conditioner may be turned on after all obstacles have been cleared.

*Serial nos. 7505001 and up

STALLS

All controls are effective at speeds down through the stalling speed, and stalls are gentle and easily controlled.

The stall speed chart is at gross weight. Stall speeds at lower weights will be correspondingly less.

STALL SPEED TABLE

Angle of Bank	Flaps 40°	Flaps Retracted
0°	61 MPH	68 MPH
20°	63 MPH	70 MPH
40°	70 MPH	78 MPH
60°	86 MPH	96 MPH
Power Off—Gross Weight 2450 Lbs.		

CRUISING

The cruising speed is determined by many factors, including power setting, altitude, temperature, loading and equipment installed on the airplane.

The normal cruising power is 75% of the rated horsepower of the engine. True airspeeds, which may be obtained at various altitudes and power settings, can be determined from the charts in Performance Charts Section.

Use of the mixture control in cruising flight reduces fuel consumption significantly, especially at higher altitudes. The mixture should be leaned during cruising operation above 5000 feet altitude and at pilot's discretion at lower altitudes when 75% power or less is being used. If any doubt exists as to the amount of power being used, the mixture should be in the FULL RICH position for all operations under 5000 feet.

To lean the mixture, pull the mixture control until the engine becomes rough, indicating that the lean mixture limit has been reached in the leaner cylinders. Then enrich the mixture by pushing the control towards the instrument panel until engine operation becomes smooth.

If the airplane is equipped with the optional exhaust gas temperature (EGT) gauge, a more accurate means of leaning is available to the pilot. For this procedure, refer to the AVCO Lycoming Operator's Manual.

In order to keep the airplane in best lateral trim during cruising flight, the fuel should be used alternately from each tank. It is recommended that one tank be used for one hour after takeoff, then the other tank be used for two hours; then return to the first tank, which will have approximately one and one half hours of fuel remaining if the tanks were full at takeoff. The second tank will contain approximately one half hour of fuel. Do not run tanks completely dry in flight.

CHEROKEE ARCHER

ROUGH AIR OPERATION

In keeping with good operating practice used in all aircraft, it is recommended that when turbulent air is encountered or expected the airspeed be reduced to maneuvering speed to reduce the structural loads caused by gusts and to allow for inadvertent speed build-ups which may occur as a result of the turbulence or distractions caused by the conditions.

APPROACH AND LANDING

Before landing check list:

1. Fuel on proper tank
2. Mixture - rich
3. Electric fuel pump on
4. Seat backs - erect
5. Flaps - set (115 MPH)
6. Safety Belts/harness - fastened
7. Air conditioner - off

The airplane should be trimmed to an approach speed of about 85 MPH with flaps up. The flaps can be lowered at speeds up to 115 MPH, if desired, and the approach speed reduced 3 MPH for each additional notch of flaps. Carburetor heat should not be applied unless there is an indication of carburetor icing, since the use of carburetor heat causes a reduction in power which may be critical in case of a go-around. Full throttle operation with carburetor heat on is likely to cause detonation.

The amount of flap used during landings and the speed of the aircraft at contact with the runway should be varied according to the landing surface and conditions of wind and airplane loading. It is generally good practice to contact the ground at the minimum possible safe speed consistent with existing conditions.

Normally, the best technique for short and slow landings is to use full flap and enough power to maintain the desired airspeed and approach flight path. Reduce the airspeed during flareout and contact the ground close to stalling speed. After ground contact hold the nose wheel off as long as possible. As the airplane slows down, drop the nose and apply brakes. There will be less chance of skidding the tires if the flaps are retracted before applying the brakes. Braking is most effective when back pressure is applied to the control wheel, putting most of the airplane weight on the main wheels. In high wind conditions, particularly in strong crosswinds, it may be desirable to approach the ground at higher than normal speeds with partial or no flaps.

STOPPING ENGINE

At the pilot's discretion, the flaps should be raised and the electric fuel pump turned off. After parking, the air conditioner and radios should be turned off and the engine stopped by pulling the mixture control to idle cut-off. The throttle should be left full aft to avoid engine vibration while stopping. Then the magneto and master switches should be turned off and the parking brake set.

AIRSPEED DATA

All airspeeds quoted in this manual are calibrated unless otherwise noted. Calibrated airspeed is indicated airspeed corrected for instrument and position errors. The following table gives the correlation between indicated airspeed and calibrated airspeed if zero instrument error is assumed. This calibration is valid only when flown at maximum gross weight in level flight.

AIRSPEED CORRECTION TABLE

Flaps 0°											
IAS-MPH	60	70	80	90	100	110	120	130	140	150	160
CAS -MPH	68	76	84	92	101	110	119	128	137	147	156
Flaps 40°											
IAS -MPH	60	70	80	90	100	110	120				
CAS - MPH	66	74	82	90	99	109	118				

ENGINE POWER LOSS

The most common cause of engine power loss is mismanagement of the fuel. Therefore, the first step to take after engine power loss is to move the fuel selector valve to the tank not being used. This will often keep the engine running even if there is no apparent reason for the engine to stop on the tank being used.

If changing to another tank does not restore the engine:

1. Check fuel pressure and turn on electric fuel pump if off.
2. Push mixture control to full "RICH."
3. Check ignition switch. Turn to best operating magneto - left, right, or both.

MOORING

The Cherokee should be moved on the ground with the aid of the nose wheel tow bar provided with each plane and secured in the baggage compartment. Tie down ropes may be secured to rings provided under each wing and to the tail skid. The aileron and stabilator controls should be secured by looping the seat belt through the control wheel and pulling it snug. The rudder is held in position by its connections to the nose wheel steering and normally does not have to be secured. The flaps are locked when in the full up position and should be left retracted.

WEIGHT AND BALANCE

It is the responsibility of the owner and pilot to determine that the airplane remains within the allowable weight vs. center of gravity envelope while in flight. For weight and balance data see the Airplane Flight Manual and Weight and Balance form supplied with each airplane.

CHEROKEE ARCHER

EMERGENCY LOCATOR TRANSMITTER*

The Emergency Locator Transmitter (ELT) when installed, is located in the aft portion of the fuselage just below the stabilator leading edge and is accessible through a plate on the right side of the fuselage. (On aircraft manufactured prior to mid-1975, this plate is retained by three steel Phillips head screws. On aircraft manufactured from mid-1975 and on, this plate is attached with three slotted-head nylon screws for ease of removal; these screws may be readily removed with a variety of common items such as a dime, a key, a knife blade, etc. If there are no tools available in an emergency the screw heads may be broken off by any means.) The ELT is an emergency locator transmitter which meets the requirements of FAR 91.52. The unit operates on a self-contained battery.

A battery replacement date is marked on the transmitter label. To comply with FAA regulations, the battery must be replaced on or before this date. The battery must also be replaced if the transmitter has been used in an emergency situation or if the accumulated test time exceeds one hour, or if the unit has been inadvertently activated for an undetermined time period.

On the unit itself is a three position selector switch labeled "OFF," "ARM" and "ON." The "ARM" position is provided to set the unit to the automatic position so that it will transmit only after impact and will continue to transmit until the battery is drained to depletion or until the switch is manually moved to the "OFF" position. The "ARM" position is selected when the transmitter is installed at the factory and the switch should remain in that position whenever the unit is installed in the airplane. The "ON" position is provided so the unit can be used as a portable transmitter or in the event the automatic feature was not triggered by impact or to periodically test the function of the transmitter.

Select the "OFF" position when changing the battery, when rearming the unit if it has been activated for any reason, or to discontinue transmission.

NOTE

If the switch has been placed in the "ON" position for any reason, the "OFF" position must be selected before selecting "ARM." If "ARM" is selected directly from the "ON" position, the unit will continue to transmit in the "ARM" position.

A pilot's remote switch, located on the left side panel, is provided to allow the transmitter to be controlled from inside the cabin. The pilot's remote switch is placarded "ON," "ARM," "OFF RESET." If the pilot's remote switch has been placed in the "ON" position for any reason, the "OFF RESET" position must be selected for one second before the switch is placed in the "ARM" position.

The unit is equipped with a portable antenna to allow the locator to be removed from the airplane in case of an emergency and used as a portable signal transmitter.

*Optional equipment

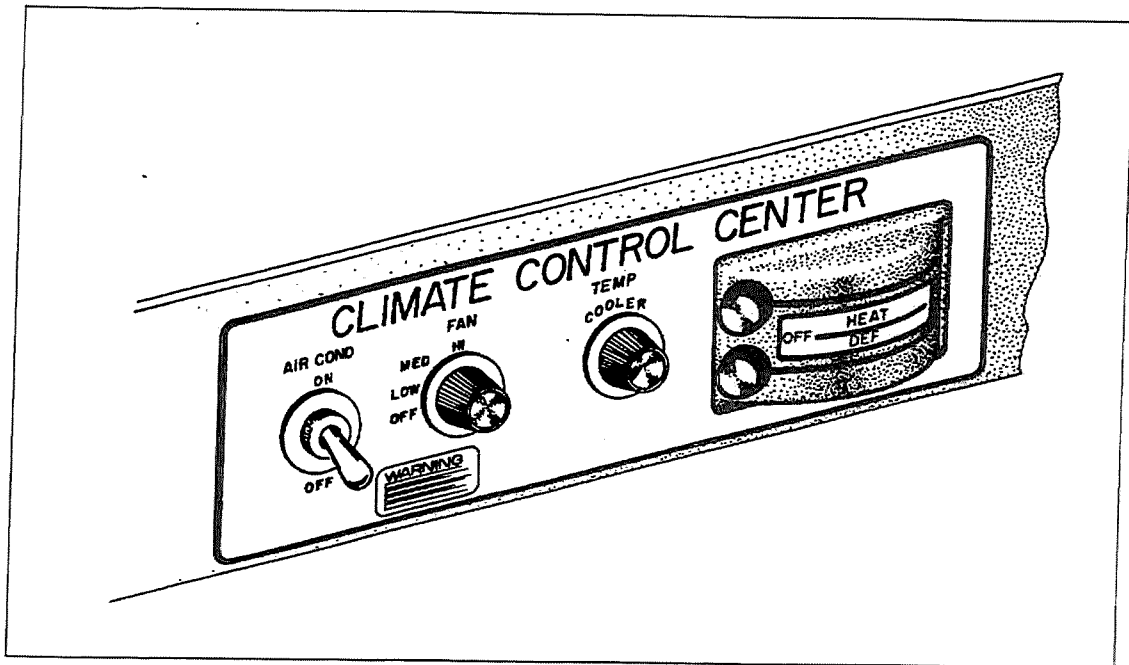

Air Conditioner Controls

The locator should be checked during the ground check to make certain the unit has not been accidentally activated. Check by tuning a radio receiver to 121.5 MHz. If there is an oscillating sound, the locator may have been activated and should be turned off immediately. Reset to the "ARM" position and check again to insure against outside interference.

NOTE

If for any reason a test transmission is necessary, the test transmission should be conducted only in the first five minutes of any hour and limited to three audio sweeps. If tests must be made at any other time, the tests should be coordinated with the nearest FAA tower or flight service station.

AIR CONDITIONING*

To operate the air conditioning system either on the ground or in flight:

1. Start the engine (ground operation).
2. Turn the air conditioning Master Switch to "ON."
3. Turn "TEMP" control to desired temperature. Clockwise rotation increases cooling.
4. Select desired "FAN" position, "LOW," "MED" or "HIGH."

*Optional equipment

AIR CONDITIONER OPERATIONAL CHECK PROCEDURE

Prior to takeoff the air conditioner should be checked for proper operation as follows:

1. Check aircraft Master Switch ON.
2. Select desired "FAN" position, "LOW," "MED" or "HIGH."
3. Turn the air conditioner control switch to "ON." The "Air Cond. Door Open" warning light will turn on, thereby indicating proper air conditioner condenser door actuation.
4. Turn the air conditioner control switch to "OFF." The "Air Cond. Door Open" warning light will go out, thereby indicating the air conditioner condenser door is in the up position.
5. If the "Air Cond. Door Open" light does not respond as specified above, an air conditioner system or indicator bulb malfunction is indicated, and further investigation should be conducted prior to flight.

The above operational check may be performed during flight if an inflight failure is suspected.

AIR CONDITIONER EFFECTS ON AIRPLANE PERFORMANCE

Operation of the air conditioner will cause slight decreases in the cruise speed and range of the Cherokee 180. Power from the engine is required to run the compressor, and the condenser door, when extended, causes a slight increase in drag. When the air conditioner is turned off there is normally no measurable difference in climb, cruise or range performance of the airplane.

NOTE

To insure maximum climb performance the air conditioner must be turned off manually before takeoff to disengage the compressor and retract the condenser door. Also the air conditioner must be turned off manually before the landing approach in preparation for a possible go-around.

Although the cruise speed and range are only slightly affected by the air conditioner operation, these changes should be considered in preflight planning. To be conservative, the following figures assume that the compressor is operating continuously while the airplane is airborne. This will be the case only in extremely hot weather.

1. The decrease in true airspeed is approximately 5 mph at all power settings.
2. The decrease in range may be as much as 37 statute miles for the 50 gal. capacity.

NOTE

To read power from the Power vs. Density Altitude Chart in this manual, add 50 rpm to the value observed on the tachometer when the air conditioner is operating.

The climb performance of Cherokee 180 is not compromised measurably with the air conditioner operating since the compressor is declutched and the condenser door is retracted, both automatically, when a full throttle position is selected. When the full throttle position is not used or in the event of a malfunction which would cause the compressor to operate and the condenser door to be extended, a decrease in rate of climb of as much as 100 fpm can be expected. Should a malfunction occur which prevents condenser door retraction when the compressor is turned off, a decrease in rate of climb of as much as 50 fpm can be expected.

THIS PAGE INTENTIONALLY LEFT BLANK

OPERATING TIPS

Operating Tips 8-1

BLANK PAGE

OPERATING TIPS

The following Operating Tips are of particular value in the operation of the Cherokee.

1. Learn to trim for takeoff so that only a very light back pressure on the wheel is required to lift the airplane off the ground.
2. The best speed for takeoff is about 60 MPH under normal conditions. Trying to pull the airplane off the ground at too low an airspeed decreases the controllability of the airplane in event of engine failure.
3. Flaps may be lowered at airspeeds up to 115 MPH. To reduce flap operating loads, it is desirable to have the airplane at a slower speed before extending the flaps.
4. Before attempting to reset any circuit breaker, allow a two to five minute cooling off period.
5. Before starting the engine, check that all radio switches, light switches and the pitot heat switch are in the off position so as not to create an overloaded condition when the starter is engaged.
6. The overvoltage relay is provided to protect the electronics equipment from a momentary overvoltage condition (approximately 16.5 volts and up), or a catastrophic regulator failure. In the event of a momentary condition, the relay will open and the ammeter will indicate "0" output from the alternator. The relay may be reset by switching the ALT switch to OFF for approximately 1 second and then returning the ALT switch to ON. The ALT light on the annunciator panel* will illuminate if the alternator fails. Recycle the ALT switch and check the ALT FIELD circuit breaker. If the failure persists after this action, reduce electrical loads and land as soon as practical.
7. The vacuum gauge is provided to monitor the pressure available to assure the correct operating speed of the vacuum driven gyroscopic flight instruments. It also monitors the condition of the common air filter by measuring the flow of air through the filter.
 If the vacuum gauge does not register $5" \pm .10"$ Hg at 2000 RPM, the following items should be checked before flight:
 - a. Common air filter could be dirty or restricted.
 - b. Vacuum lines could be collapsed or broken.
 - c. Vacuum pump worn.
 - d. Vacuum regulator, not adjusted correctly. The pressure, even though set correctly, can read lower under two conditions: (1) Very high altitude, above 12,000 feet, (2) Low engine RPM, usually on approach or during training maneuvers. This is normal and should not be considered a malfunction.
8. The shape of the wing fuel tanks is such that in certain maneuvers the fuel may move away from the tank outlet. If the outlet is uncovered, the fuel flow will be interrupted and a temporary loss of power may result. Pilots can prevent inadvertent uncovering of the outlet by avoiding maneuvers which could result in uncovering the outlet.

Extreme running turning takeoffs should be avoided as fuel flow interruption may occur.

Prolonged slips or skids which result in excess of 2000 feet of altitude loss, or other radical or extreme maneuvers which could cause uncovering of the fuel outlet must be avoided as fuel flow interruption may occur when tank being used is not full.

*Serial nos. 7505001 and up

CHEROKEE ARCHER

9. Anti-collision lights should not be operating when flying through overcast and clouds, since reflected light can produce spacial disorientation. Do not operate strobe lights when taxiing in the vicinity of other aircraft.
10. The rudder pedals are suspended from a torque tube which extends across the fuselage. The pilot should become familiar with the proper positioning of his feet on the rudder pedals so as to avoid interference with the torque tube when moving the rudder pedals or operating the toe brakes.
11. In an effort to avoid accidents, pilots should obtain and study the safety related information made available in FAA publications such as regulations, advisory circulars, Aviation News, AIM and safety aids.

PERFORMANCE CHARTS

Altitude Conversion Chart	9-1
Takeoff Performance	9-2
Climb Performance	9-3
Cruise Performance - Range	9-4
Engine Performance	9-5
Cruise Performance - True Airspeed	9-6
Stalling Speed vs Weight	9-7
Stalling Speed vs Angle of Bank	9-8
Glide Performance	9-9
Landing Distance vs Density Altitude	9-10

WARNING

Performance information derived by extrapolation beyond the limits shown on the charts should not be used for flight planning purposes.

BLANK PAGE

PA-28-180 CHEROKEE

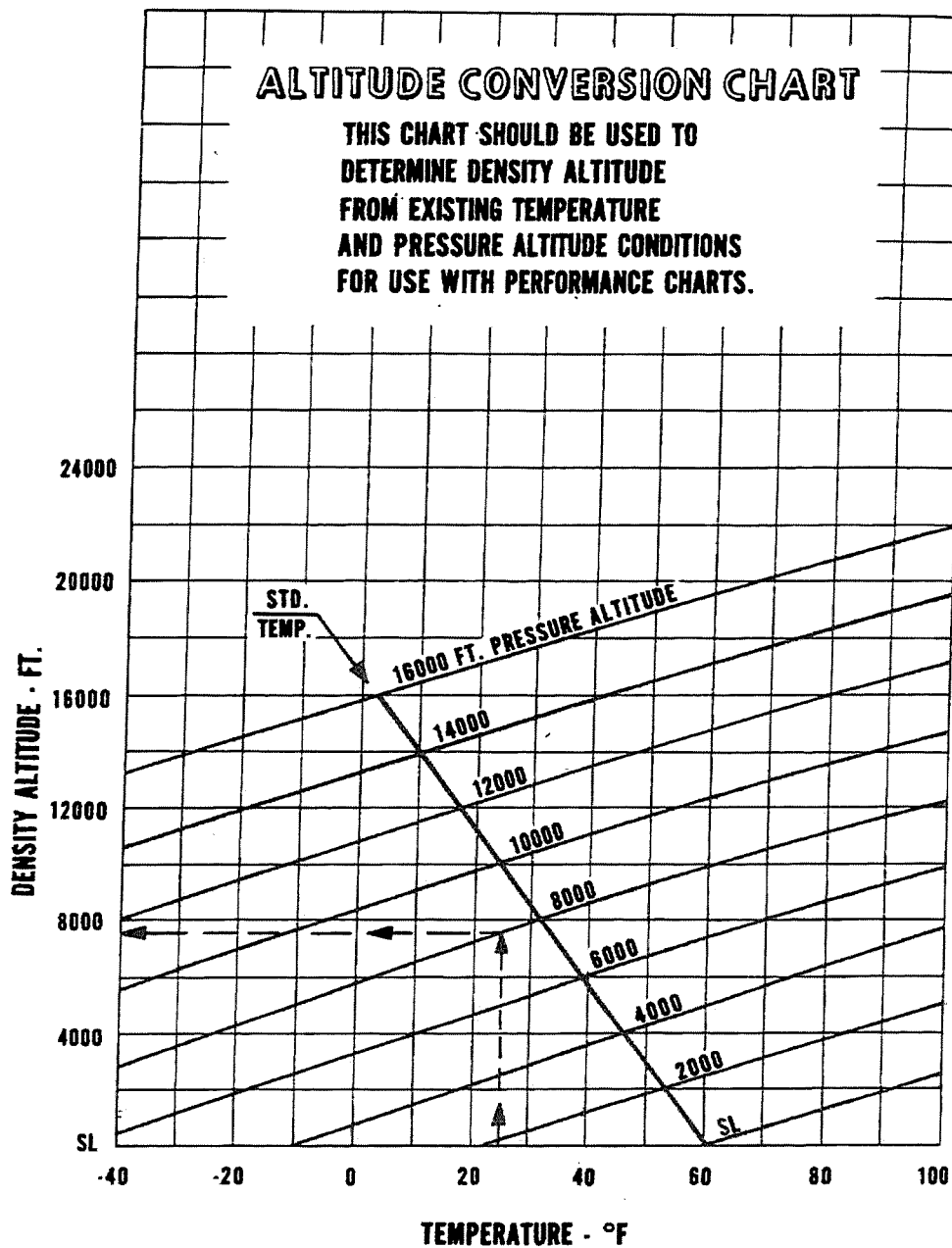

PERFORMANCE CHARTS
ISSUED: JULY 9, 1973

PA-28-180 CHEROKEE

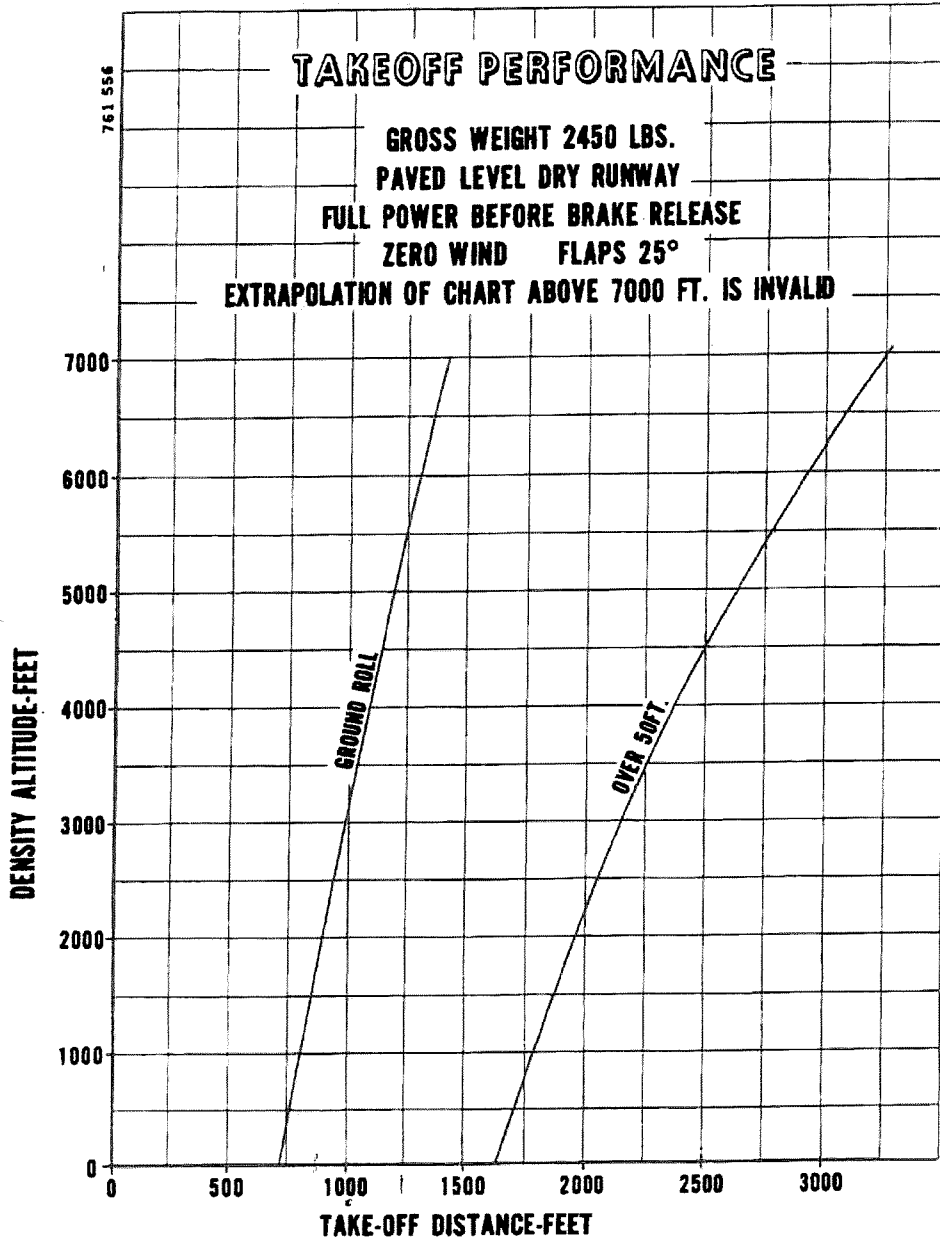

NOTE: SEE SECTION 7 FOR EFFECTS OF AIR CONDITIONING
INSTALLATION ON PERFORMANCE.

PA-28-180 CHEROKEE

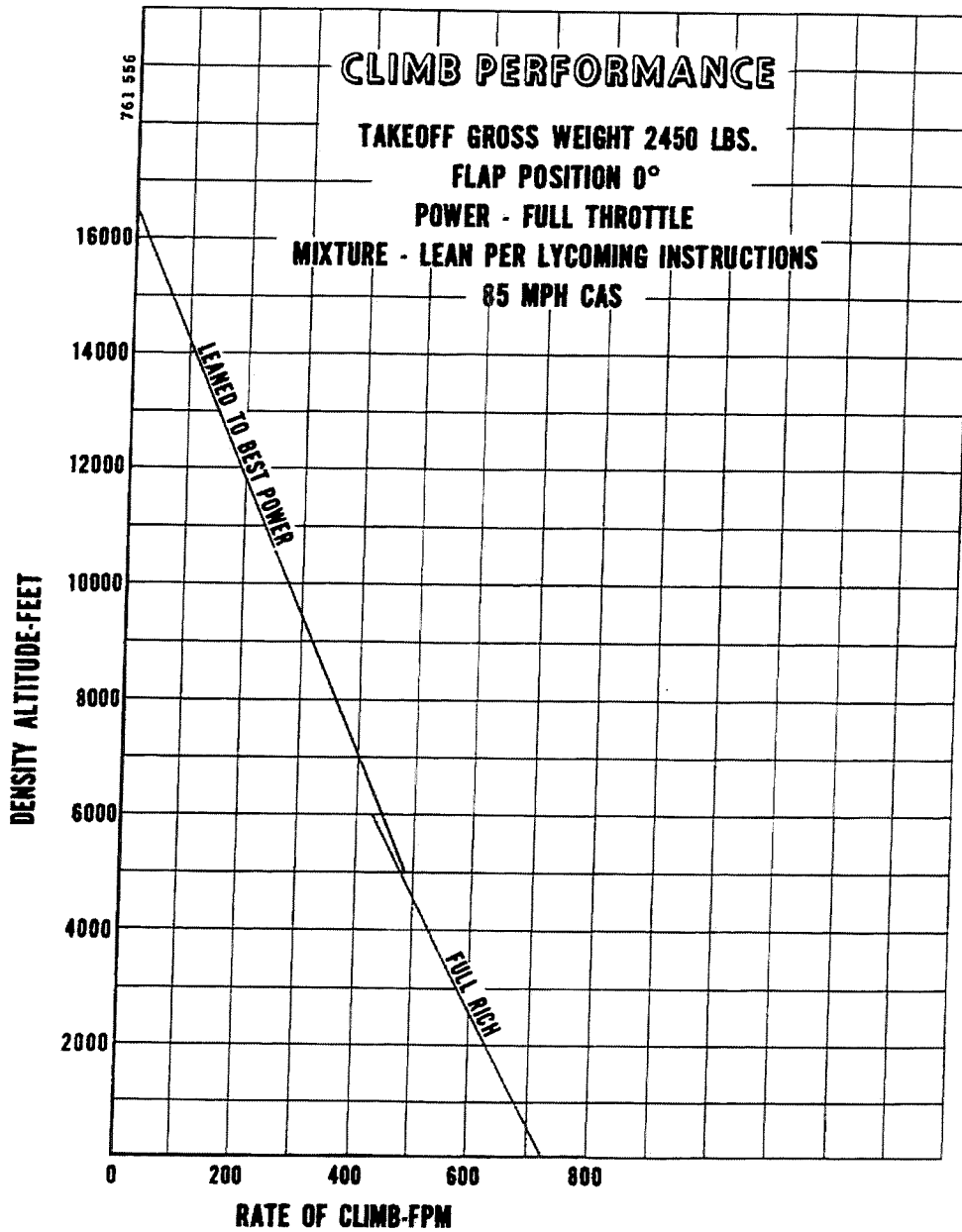

NOTE: SEE SECTION 7 FOR EFFECTS OF AIR CONDITIONING
INSTALLATION ON PERFORMANCE.

PA-28-180 CHEROKEE

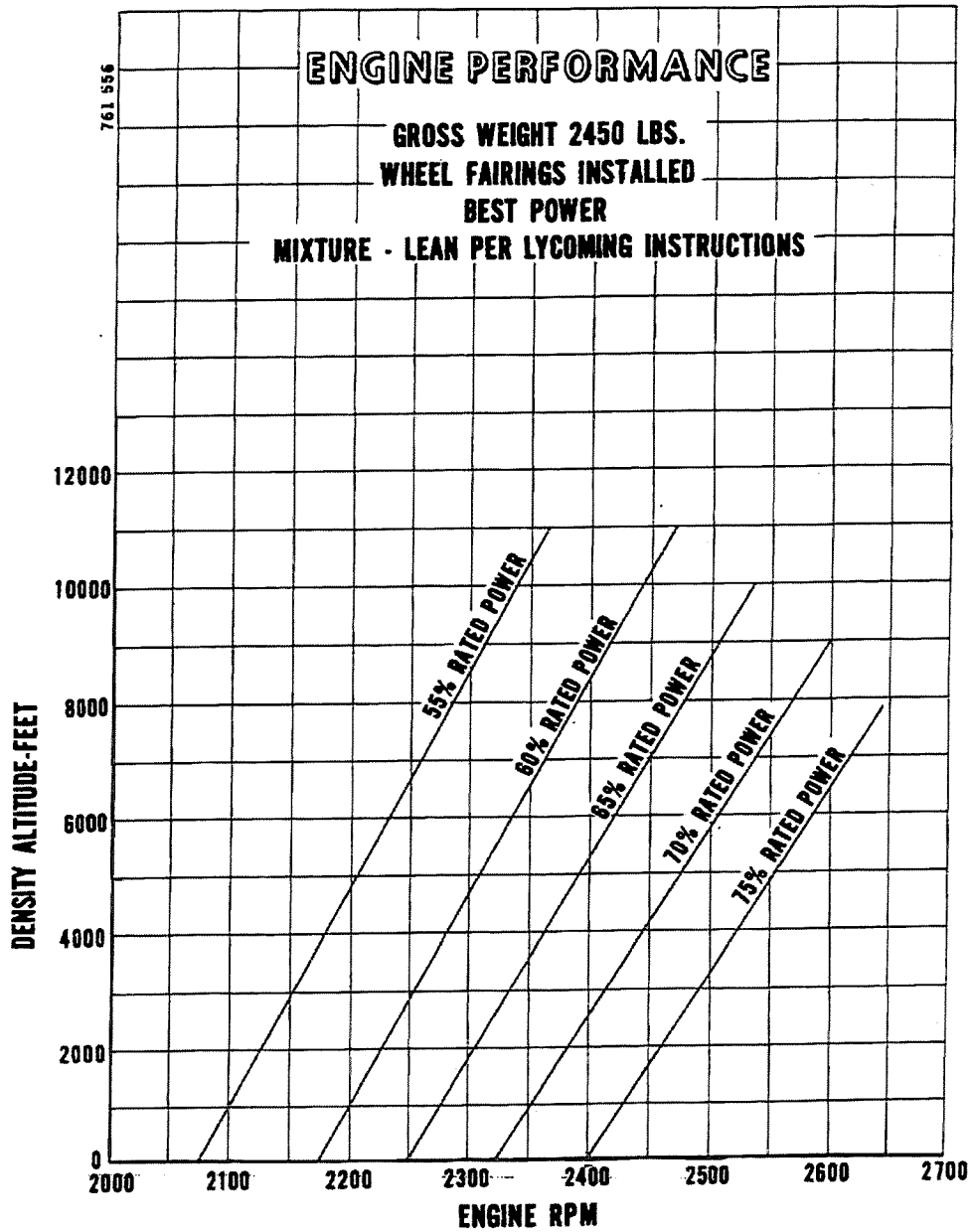

NOTE: SEE SECTION 7 FOR EFFECTS OF AIR CONDITIONING
INSTALLATION ON PERFORMANCE.

PA-28-180 CHEROKEE

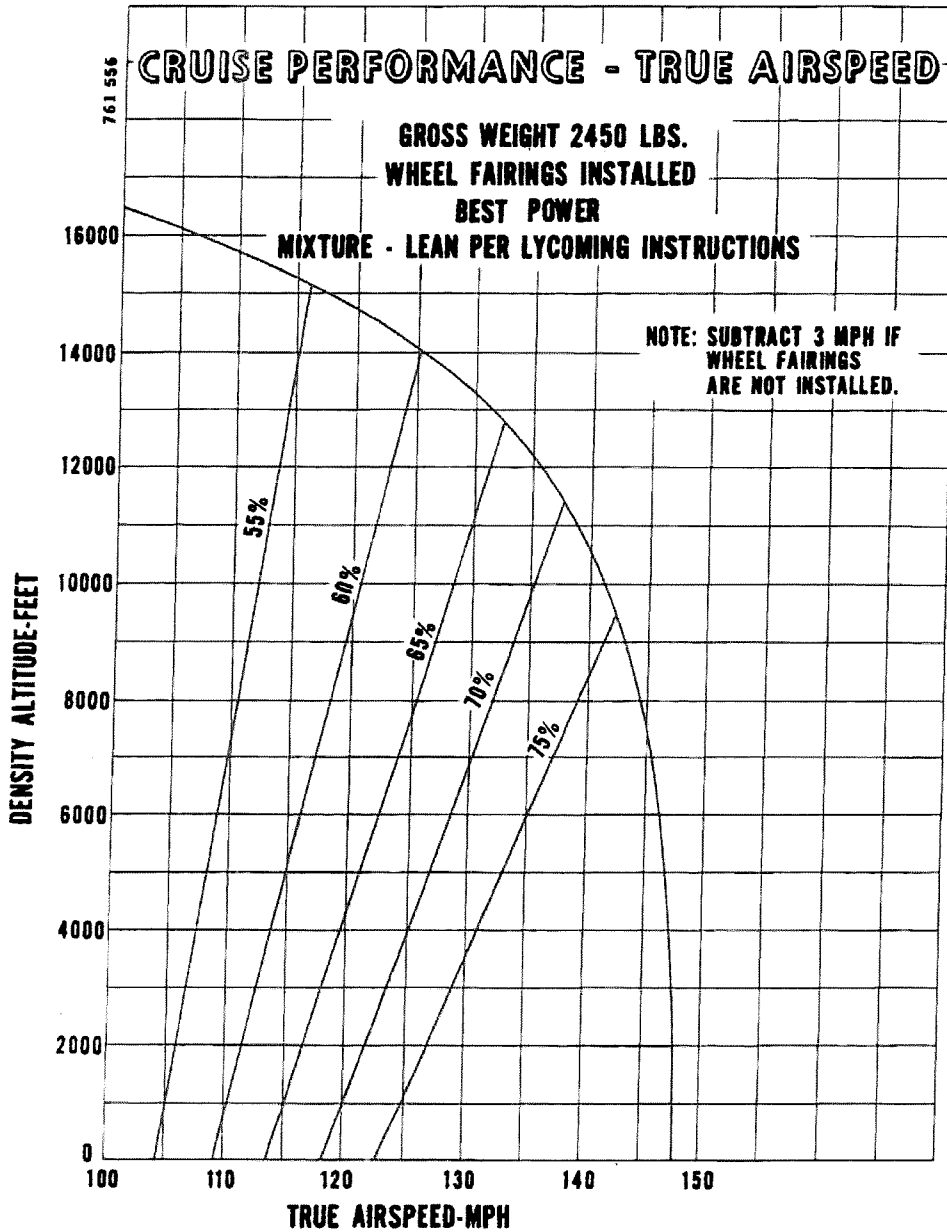

NOTE: SEE SECTION 7 FOR EFFECTS OF AIR CONDITIONING
INSTALLATION ON PERFORMANCE.

PA-28-180 CHEROKEE

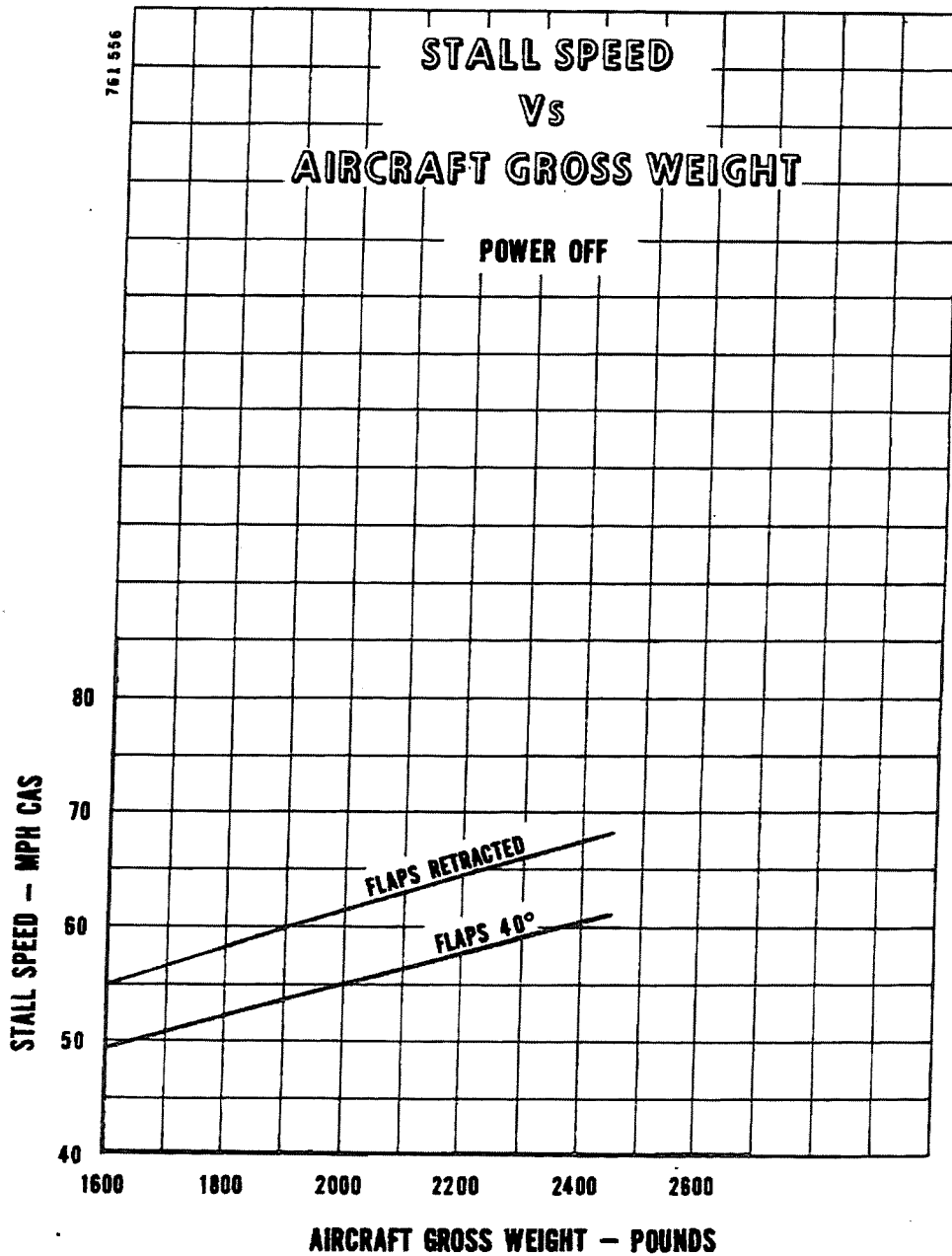

NOTE: SEE SECTION 7 FOR EFFECTS OF AIR CONDITIONING
INSTALLATION ON PERFORMANCE.

PA-28-180 CHEROKEE

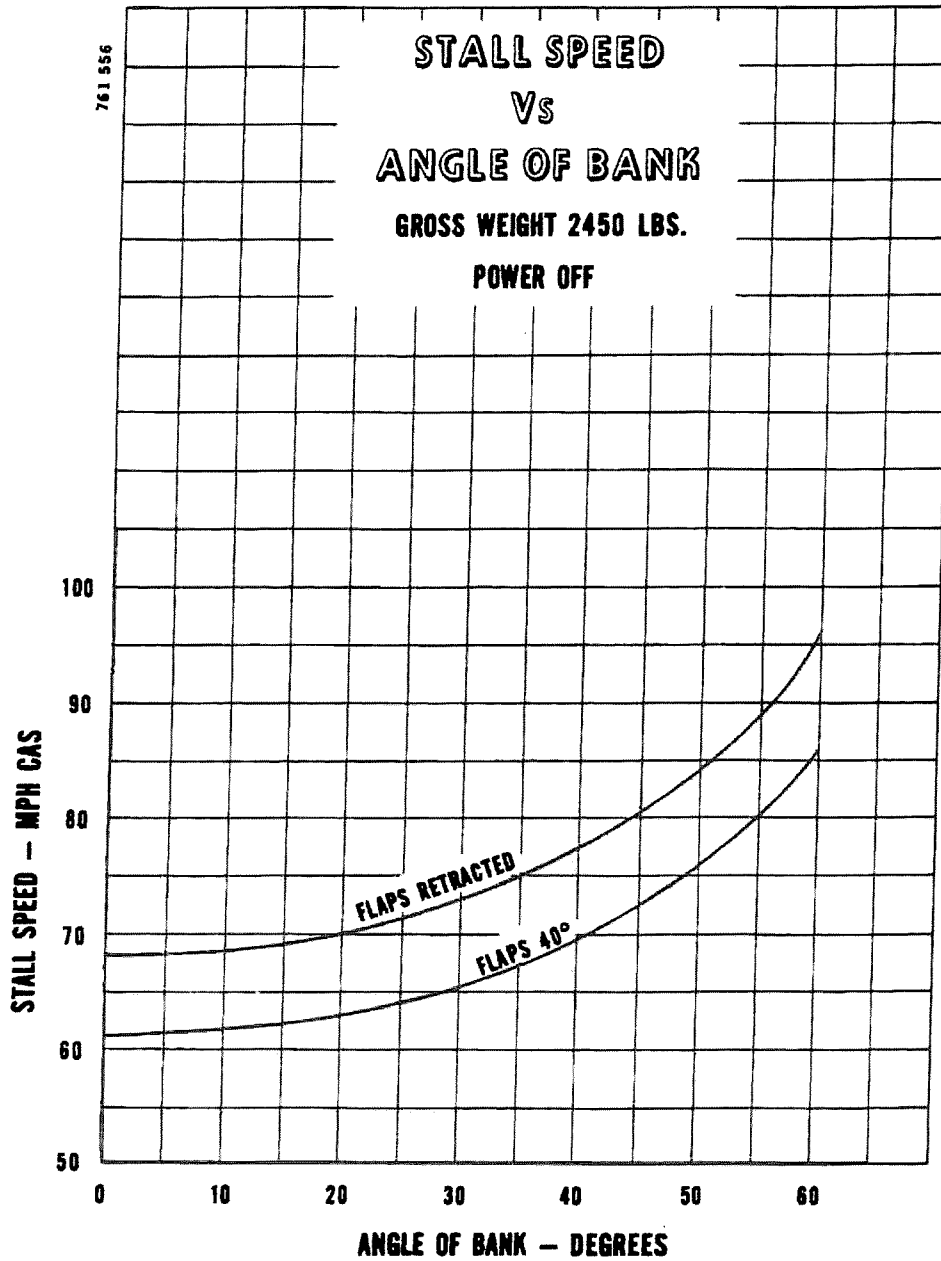

NOTE: SEE SECTION 7 FOR EFFECTS OF AIR CONDITIONING
INSTALLATION ON PERFORMANCE.

PA-28-180 CHEROKEE

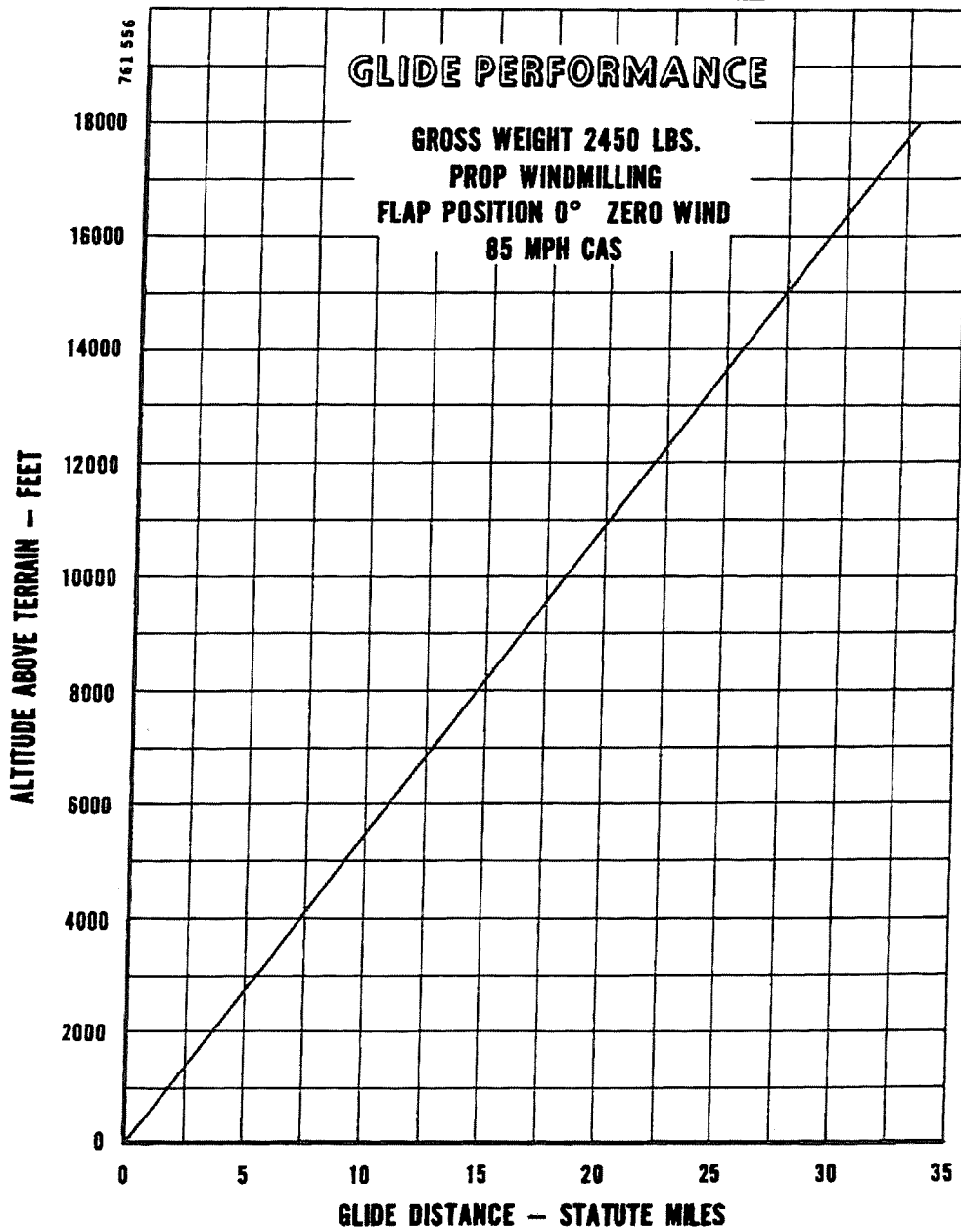

NOTE: SEE SECTION 7 FOR EFFECTS OF AIR CONDITIONING
INSTALLATION ON PERFORMANCE.

PA-28-180 CHEROKEE

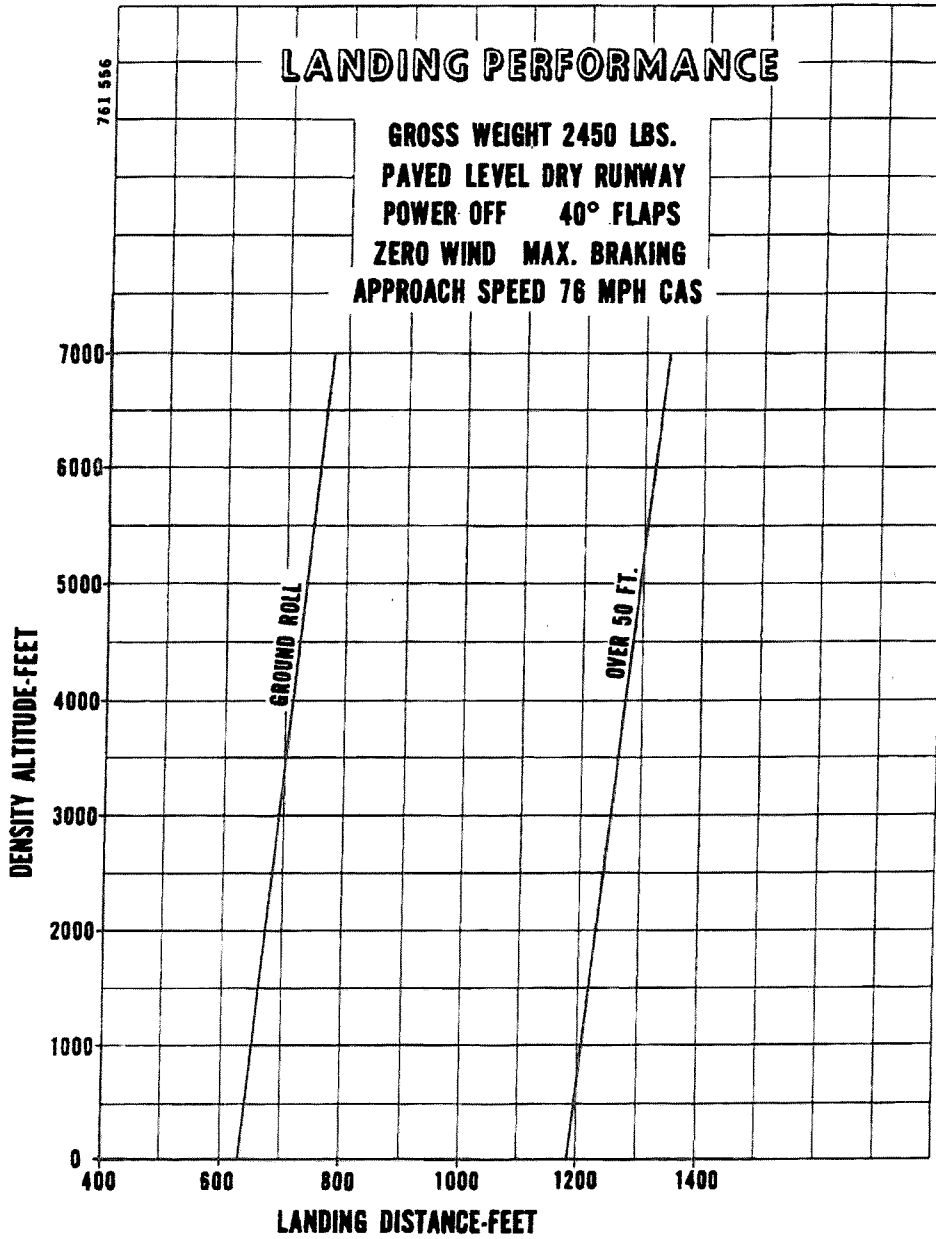

NOTE: SEE SECTION 7 FOR EFFECTS OF AIR CONDITIONING
INSTALLATION ON PERFORMANCE.

HANDLING AND SERVICING

Ground Handling	10-1
Towing	10-1
Taxiing	10-1
Parking	10-2
Mooring	10-2
Cleaning	10-3
Cleaning Engine Compartment	10-3
Cleaning Landing Gear	10-3
Cleaning Exterior Surfaces	10-4
Cleaning Windshield and Windows	10-4
Cleaning Headliner, Side Panels and Seats	10-4
Cleaning Carpets	10-4
Power Plant Induction Air Filter	10-5
Removal of Induction Air Filter	10-5
Cleaning Induction Air Filter	10-5
Installation of Induction Air Filter	10-5
Brake Service	10-7
Landing Gear Service	10-7
Propeller Service	10-8
Oil Requirements	10-8
Fuel System	10-9
Fuel Requirements	10-9
Filling Fuel Tanks	10-9
Draining Fuel Valves and Lines	10-9
Draining Fuel System	10-10
Tire Inflation	10-10
Battery Service	10-11
Facts You Should Know	10-11
Preventive Maintenance	10-12
Required Service and Inspection Periods	10-13

BLANK PAGE

HANDLING AND SERVICING

This section contains information on preventive maintenance. Refer to the PA-28 Service Manual for further maintenance procedures. Any complex repair or modification should be accomplished by a Piper Certified Service Center.

GROUND HANDLING

TOWING

The airplane may be moved by using the nose wheel steering bar provided, or power equipment that will not damage or cause excess strain to the nose gear assembly. The steering bar is stowed in the baggage compartment.

CAUTION

When towing with power equipment, do not turn nose gear more than 30 degrees in either direction, as this will result in damage to the nose gear and steering mechanism.

TAXIING

Before attempting to taxi the airplane, ground personnel should be instructed and approved by a qualified person authorized by the owner. Engine starting and shut-down procedures as well as taxi techniques should be covered. When it is ascertained that the propeller back blast and taxi areas are clear, power should be applied to start the taxi roll, and the following checks should be performed, after releasing the parking brake.

- a. Taxi forward a few feet and apply brakes to determine their effectiveness.
- b. While taxiing, make slight turns to ascertain the effectiveness of the steering.
- c. Observe wing clearances when taxiing near buildings or other stationary objects. If possible, station a guide outside the airplane to observe.
- d. When taxiing on uneven ground, look for holes and ruts.
- e. Do not operate the engine at high RPM when running up or taxiing over ground containing loose stones, gravel or any loose material that may cause damage to the propeller blades.

CHEROKEE ARCHER

PARKING

When parking the airplane, insure that it is sufficiently protected against adverse weather conditions and presents no danger to other aircraft. When parking the airplane for any length of time or overnight, it is recommended that it be moored securely.

- a. To park the airplane, head it into the wind, if possible.
- b. Set the parking brake. (Use wheel chocks if available.)

NOTE

Care should be taken when setting brakes that are overheated or during cold weather when accumulated moisture may freeze a brake.

MOORING

The airplane should be moored to insure its immovability, protection and security under varying weather conditions. The following procedure should be used for proper mooring of the airplane.

- a. Head the airplane into the wind, if possible.
- b. Lock the aileron and stabilator controls by looping the seat belt through the control wheel and pulling it snug.
- c. Block the wheels.
- d. Secure tie down ropes to the wing tie down rings and tail skid at approximately 45-degree angles to the ground. When using rope of non-synthetic material, leave sufficient slack to avoid damage to the airplane should the ropes contract.

CAUTION

Use bowline knots or locked slip knots. Do not use a plain slip knot.

NOTE

Additional preparations for high winds include using tie down ropes from the landing gear forks, and securing the rudder.

- e. Install a pitot head cover, if available.

CLEANING

CLEANING ENGINE COMPARTMENT

Before cleaning the engine compartment, place a strip of tape on the magneto vents to prevent solvent from entering these units.

- a. Place a large pan under the engine to catch waste.
- b. With the engine cowling removed, spray or brush the engine with solvent or a mixture of solvent and degreaser, as desired. Where heavy grease and dirt deposits have collected, it may be necessary to brush areas that were sprayed in order to clean them.

CAUTION

Do not spray solvent into the alternator, vacuum pump, starter or air intakes.

- c. Allow the solvent to remain on the engine from five to ten minutes. Then rinse the engine clean with additional solvent and allow to dry.

CAUTION

Do not operate the engine until excess solvent has evaporated or otherwise been removed.

- d. Remove the protective covers from the magnetos.
- e. Lubricate controls, bearing surfaces, etc., in accordance with the Lubrication Chart.

CLEANING LANDING GEAR

Before cleaning the landing gear, place a plastic cover or similar material over the wheel and brake assembly.

- a. Place a pan under the gear to catch waste.
- b. Spray or brush the gear area with solvent or a mixture of solvent and degreaser, as desired. Where heavy grease and dirt deposits have collected, it may be necessary to brush areas that were sprayed in order to clean them.
- c. Allow the solvent to remain on the gear from five to ten minutes. Then rinse the gear with additional solvent and allow to dry.
- d. Remove the cover from the wheel and remove the catch pan.
- e. Lubricate the gear in accordance with the Lubrication Chart.

CHEROKEE ARCHER

CLEANING EXTERIOR SURFACES

The airplane should be washed with a mild soap and water. Harsh abrasive or alkaline soaps or detergents used on painted or plastic surfaces could make scratches or cause corrosion of metal surfaces. Cover areas where cleaning solution could cause damage. To wash the airplane, the following procedure may be used:

- a. Flush away loose dirt with water.
- b. Apply cleaning solution with a rag, sponge or soft bristle brush.
- c. To remove stubborn oil and grease, use a cloth dampened with naphtha.
- d. Where exhaust stains exist, allow solution to remain on the surface longer.
- e. Any good automotive wax may be used to preserve the painted surfaces. Soft cleaning cloths or a chamois should be used to prevent scratches when cleaning or polishing. A heavier coating of wax on the leading surfaces will reduce the abrasion problems in these areas.

CLEANING WINDSHIELD AND WINDOWS

A certain amount of care is needed to keep the plexiglas windows clean and unmarred. The following procedure is recommended:

- a. Remove dirt, mud, and other marks from exterior surface with clean water.
- b. Wash with mild soap and warm water or an aircraft plastic cleaner. Use a soft cloth or sponge using a straight rubbing motion. Do not rub surface harshly.
- c. Remove oil and grease with a cloth moistened with kerosene.

NOTE

Do not use gasoline, alcohol, benzene, carbon tetrachloride, thinner, acetone, or window cleaning sprays.

- d. After cleaning plastic surfaces, apply a thin coat of hard polishing wax. Rub lightly with a soft cloth. Do not use a circular motion.
- e. A severe scratch or mar in plastic can be removed by using jeweler's rouge to rub out the scratch. Smooth both sides and apply wax.

CLEANING HEADLINER, SIDE PANELS AND SEATS

- a. Clean headliner, side panels and seats with a stiff bristle brush, and vacuum where necessary.
- b. Soiled upholstery, except leather, may be cleaned by using an approved foam upholstery cleaner. Carefully follow the manufacturer's instructions. Avoid soaking or harsh rubbing.

CAUTION

Solvent cleaners require adequate ventilation.

CLEANING CARPETS

Use a small whisk broom or vacuum cleaner to remove dirt. For soiled spots, use a nonflammable dry cleaning fluid.

POWER PLANT INDUCTION AIR FILTER

The air filter must be cleaned at least once every fifty hours. Under extremely adverse conditions of operation it may be necessary to clean the filter daily. Extra filters are inexpensive and a spare should be kept on hand and used as a rapid replacement.

REMOVAL OF INDUCTION AIR FILTER

The filter is located on the right side and midway in the engine compartment and may be removed by the following procedure:

- a. Remove the two nuts and washers on the cover assembly and pull off the cover.
- b. Remove the filter.

CLEANING INDUCTION AIR FILTER

- a. Tap filter gently to remove dirt particles. Do not use compressed air or cleaning solvents.
- b. Inspect filter. If paper element is torn or ruptured or gasket is damaged, the filter should be replaced. The usable life of the filter should be restricted to one year or 500 hours, whichever comes first.

INSTALLATION OF INDUCTION AIR FILTER

After cleaning or replacing the filter, install it in the reverse order of removal.

CHEROKEE ARCHER

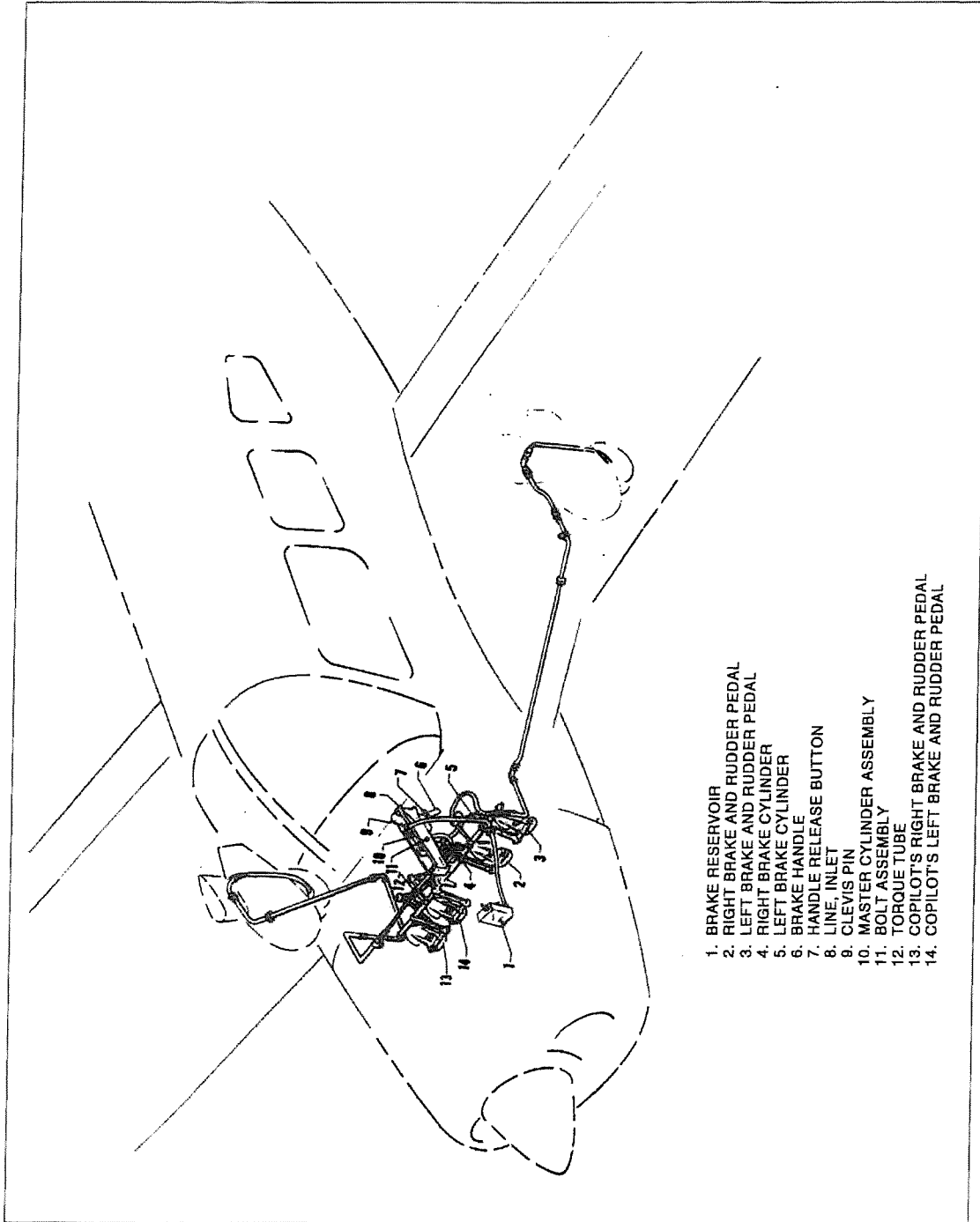

1. BRAKE RESERVOIR
2. RIGHT BRAKE AND RUDDER PEDAL
3. LEFT BRAKE AND RUDDER PEDAL
4. RIGHT BRAKE CYLINDER
5. LEFT BRAKE CYLINDER
6. BRAKE HANDLE
7. HANDLE RELEASE BUTTON
8. LINE, INLET
9. CLEVIS PIN
10. MASTER CYLINDER ASSEMBLY
11. BOLT ASSEMBLY
12. TORQUE TUBE
13. COPILOT'S RIGHT BRAKE AND RUDDER PEDAL
14. COPILOT'S LEFT BRAKE AND RUDDER PEDAL

Brake System

BRAKE SERVICE

The brake system is filled with MIL-H-5606 (petroleum base) hydraulic brake fluid. This should be checked at every 50 hour inspection and replenished when necessary by filling the brake reservoir on the firewall to the indicated level. If the entire system has to be refilled, it should be done by filling from the brake end of the system with fluid under pressure. This will eliminate air from the system.

No adjustment of brake clearances is necessary on the Cherokee. If after extended service the brake blocks become worn excessively, they are easily replaced with new segments.

LANDING GEAR SERVICE

The three landing gears use Cleveland 6.00 x 6 wheels, the main gear wheels being provided with brake drums and Cleveland single disc hydraulic brake assemblies. All three wheels use 6.00 x 6, four-ply rating, Type III tires with tubes.

Main wheels are removed by taking off the wheel fairings, hub cap, axle nut, and the two bolts holding the brake segment into place. The wheel will slip easily from the axle.

Tires are removed from the wheels by first deflating the tire, then removing the through bolts, and separating the wheel halves.

Landing gear oleo struts should be checked for proper strut exposures and fluid leaks. The required extensions for the strut when under normal static load (empty weight of airplane plus full fuel and oil) are 3-1/4 inches for the nose gear and 4-1/2 inches for the main gear. Should the strut exposure be below that required, it should be determined whether air or oil is required by first raising the airplane on jacks. Depress the valve core to allow air to escape from the strut housing chamber. Remove the filler plug and slowly raise the strut to full compression. If the strut has sufficient fluid, it will be visible up to the bottom of the filler plug hole and will then require only proper inflation.

Should fluid be below the bottom of the filler plug hole, oil should be added. Replace the plug with valve core removed; attach a clear plastic hose to the valve stem of the filler plug and submerge the other end in a container of hydraulic fluid (MIL-H-5606). Fully compress and extend the strut several times, thus drawing fluid from the container and expelling air from the strut chamber. To allow fluid to enter the bottom chamber of the main gear strut housing, the torque link assembly must be disconnected to let the strut be extended a minimum of 10 inches (the nose gear torque links need not be disconnected). Do not allow the strut to extend more than 12 inches. When air bubbles cease to flow through the hose, compress the strut fully and again check fluid level. Reinstall the valve core and filler plug, and the main gear torque links, if disconnected.

With fluid in the strut housing at the correct level, attach a strut pump to the air valve and with the airplane on the ground, inflate the oleo strut to the correct height.

In jacking the Cherokee for landing gear service, a jack kit (available through the Piper Dealers and Distributors) should be used. This kit consists of two hydraulic jacks and a tail stand. At least 250 pounds of ballast should be placed on the tail stand before jacking the aircraft. The jacks should be placed under the jack points on the wing and the airplane jacked up until the tail skid is at the right height to attach the tail stand. After attaching the tail stand and adding ballast, jacking may be continued until the aircraft is at the height desired.

CHEROKEE ARCHER

The steering arms from the rudder pedals to the nose wheel are adjusted at the rudder pedals or at the nose wheel by turning in or out the threaded rod end bearings. Adjustment is normally accomplished at the forward end of the rods and should be done in such a way that the nose wheel is in line with the fore and aft axis of the plane when the rudder pedals and rudder are centered. Alignment of the nose wheel can be checked by pushing the airplane back and forth with the rudder centered to determine that the plane follows a perfectly straight line. The turning arc of the nose wheel is 30 degrees in either direction and is factory adjusted at stops on the bottom of the forging.

The steering arm stops should be carefully adjusted so that the nose wheel reaches its full travel just after the rudder hits its stops. This guarantees that the rudder will be allowed to move through its full travel.

PROPELLER SERVICE

The spinner and backing plate should be cleaned and inspected frequently for cracks. The propeller should be inspected before each flight for nicks, scratches, and corrosion. If found, they should be taken care of as soon as possible by a rated mechanic, because nicks and scratches cause areas of increased stress which can cause serious damage or loss of a propeller tip. The back face of the blades should be painted when necessary with flat black paint to retard glare to the pilot's eyes. To prevent corrosion, the surface should be cleaned and waxed periodically.

OIL REQUIREMENTS

The oil capacity of the Lycoming O-320-A4A and O-360-A4M series engines is 8 quarts, and the minimum safe quantity is 2 quarts. It is recommended that engine oil be drained and renewed every 50 hours. The oil filter element should be changed every 50 hours of operation. The interval between oil and oil filter changes should not exceed a total of four months. Under unfavorable dusty conditions, the oil and oil filter should be changed more frequently. Should fuel other than the specified octane rating for the power plant be used, refer to the latest issue of Lycoming Service Letter No. L185 for additional information and recommended service procedures.

The following seasonal aviation oil grades and seasonal ambient temperature ranges are recommended:

Average Ambient Temperature	MIL-L-6082B Mineral SAE Grade	MIL-L-22851 Ashless Dispersant SAE Grades
All Temperatures	—	15W-50 or 20W-50
Above 80°F	60	60
Above 60°F	50	40 or 50
30°F to 90°F	40	40
0°F to 70°F	30	30,40 or 20W40
0°F to 90°F	20W-50	20W-50 or 15W-50
Below 10°F	20	30 or 20W-30

When operating temperatures overlap indicated ranges, use the lighter grade oil.

NOTE

Refer to the latest issue of Textron Lycoming Service Instruction 1014 (Lubricating Oil Recommendations) for further information.

FUEL SYSTEM

FUEL REQUIREMENTS (AVGAS ONLY)

Aviation grade 100/130 Octane (minimum) fuel must be used in the Cherokee. The use of lower grades can cause serious engine damage in a very short period of time, and is considered of such importance that the engine warranty is invalidated by such use.

FILLING FUEL TANKS

Observe all required precautions for handling gasoline. Fuel is stored in two twenty-five gallon (24 gal. usable) tanks. To obtain the standard quantity of thirty-six U.S. gallons total, fill the tanks only to the bottom of the filler neck tube or visual indicator. To obtain the standard plus reserve quantity, fill the tanks to the top of the filler neck.

DRAINING FUEL VALVES AND LINES

The fuel system should be drained daily prior to first flight and after refueling to avoid the accumulation of water or sediment. Each fuel tank is equipped with an individual quick drain located at the lower inboard rear corner of the tank. The fuel strainer is equipped with an easy drain valve. It is located on the front lower left corner of the fire wall. It is important that the fuel system be drained in the following manner:

- a. Open the easy drain valve with the fuel selector valve on one tank, and allow fuel to flow for a few seconds.
- b. Place a container under the drain and examine the contents for sediment, water and proper fuel.
- c. When enough fuel has flowed to ensure that the lines and strainers are free of water and sediment, close the drain and dispose of the contents of the container.
- d. Repeat the procedure with the fuel selector valve changed to the other tank.

CAUTION

When draining any amount of fuel, care should be taken to ensure that no fire hazard exists before starting engine.

After using the quick drain, it should be checked to make sure it has closed completely and is not leaking.

CHEROKEE ARCHER

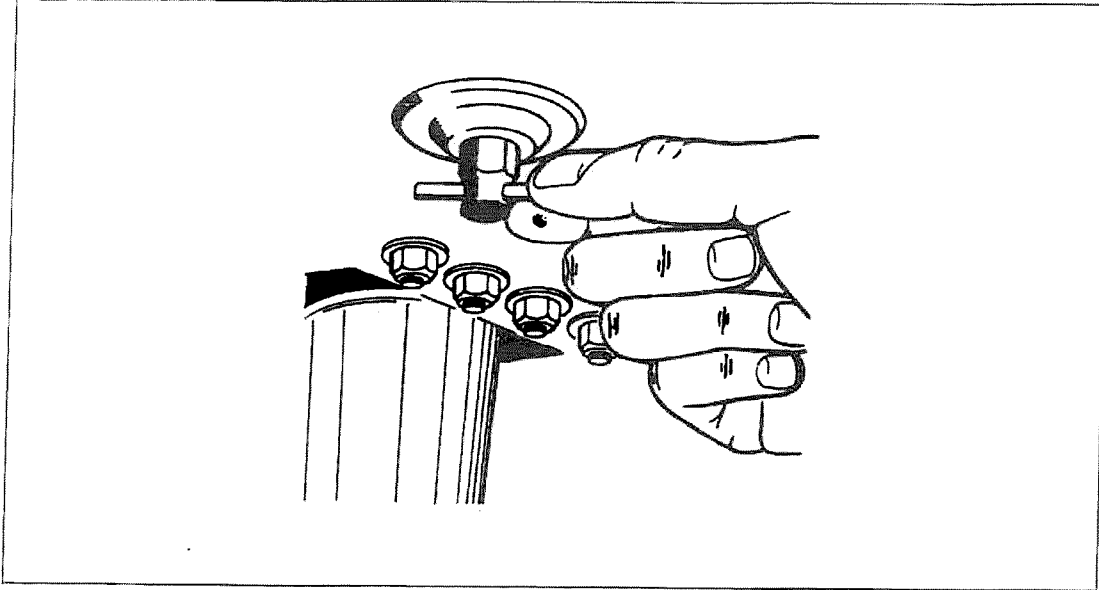

Fuel Drain

DRAINING FUEL SYSTEM

The bulk of the fuel may be drained from the system by opening the valve at the inboard end of each fuel tank. Push up on the arms of the drain valve and turn counterclockwise to hold the drain open. The remaining fuel in the system may be drained through the filter bowl. Any individual tank may be drained by closing the selector valve and then draining the desired tank.

TIRE INFLATION

For maximum service from the tires, keep all three tires inflated to a pressure of 24 pounds. If necessary, interchange the tires on the main wheels to produce even wear. All wheels and tires are balanced before original installation, and the relationship of the tire, tube and wheel should be maintained if possible. Out of balance wheels can cause extreme vibration on takeoff. In the installation of new components, it may be necessary to rebalance the wheel with the tire mounted.

BATTERY SERVICE

Access to the 12-volt battery is through the removal of the panel at the right rear side of the baggage compartment. The battery box has a plastic drain tube which should be opened occasionally to drain off any accumulation of liquid. Check the battery for proper fluid level. (Do not fill above the baffle plates.) Use only water - no acid. A hydrometer check should be performed to determine the percent of charge present in the battery.

If the battery is not up to charge, recharge starting at a 4 amp rate and finishing with a 2 amp rate. Quick charges are not recommended.

FACTS YOU SHOULD KNOW

The Federal Aviation Administration (FAA) occasionally publishes Airworthiness Directives (ADs) that apply to specific groups of aircraft. They are mandatory changes and are to be complied with within a time limit set by the FAA. When an AD is issued, it is sent by the FAA to the latest registered owner of the affected aircraft and also to subscribers of their service. Owners should periodically check with their Piper Service Center or Piper's Customer Services Department to see whether they have the latest AD against their airplane. The owner is solely responsible for keeping up with ADs.

Piper Aircraft Corporation takes a continuing interest in having owners get the most efficient use from their airplane and keeping it in the best mechanical condition. Consequently, Piper Aircraft, from time to time, issues service releases including Service Bulletins, Service Letters, Service Spares Letters, and others relating to the airplane.

Piper Service Bulletins are of special importance and Piper considers compliance mandatory. These are sent directly to the latest FAA-registered owners in the United States (U.S.) and Piper Service Centers worldwide. Depending on the nature of the release, material and labor allowances may apply. This information is provided to all authorized Piper Service Centers.

Service Letters deal with product improvements and servicing techniques pertaining to the airplane. They are sent to Piper Service Centers and, if necessary, to the latest FAA-registered owners in the U.S. Owners should give careful attention to Service Letter information.

Service Spares Letters offer improved parts, kits, and optional equipment which were not available originally, and which may be of interest to the owner.

Piper Aircraft Corporation offers a **subscription service** for Service Bulletins, Service Letters, and Service Spares Letters. This service is available to interested persons such as owners, pilots, and mechanics at a nominal fee, and may be obtained through an authorized Piper Service Center or Piper's Customer Services Department.

Service manuals, parts catalogs, and revisions to both, are available from Piper Service Centers or Piper's Customer Services Department. Any correspondence regarding the airplane should include the airplane model and serial number to ensure proper response.

CHEROKEE ARCHER

Pilot's Operating Manual supplements are distributed by the manufacturer as necessary. These revisions and additions should be studied and put into the operating manual to keep it up to date. This manual contains important information about the operation of the aircraft and should be kept with the aircraft at all times, even after resale. Every owner, to avail themselves of the latest information concerning their airplane, should stay in close contact with an authorized Piper Service Center or Piper's Customer Services Department.

If the owner desires to have his aircraft modified, he must obtain FAA approval for the alteration. **Major alterations** accomplished in accordance with Advisory Circular 43.13-2, when performed by an A & P mechanic, may be approved by the local FAA office. Major alterations to the basic airframe or systems not covered by AC43.13-2 require a Supplemental Type Certificate.

The owner or pilot is required to ascertain that the following **Aircraft Papers** are in order and in the aircraft.

- a. To be displayed in the aircraft at all times:
 1. Aircraft Airworthiness Certificate Form FAA-1362B.
 2. Aircraft Registration Certificate Form FAA-500A.
 3. Aircraft Radio Station License FCC-404A, if transmitters are installed.
- b. To be carried on the aircraft at all times:
 - (1) Aircraft Flight Manual.
 - (2) Weight and Balance Data plus a copy of the latest Repair and Alteration Form FAA-337, if applicable.
 - (3) Aircraft equipment list.

Although the aircraft and engine logbooks are not required to be in the aircraft, they should be made available upon request. Logbooks should be complete and up to date. Good records will reduce maintenance cost by giving the mechanic information about what has or has not been accomplished.

PREVENTIVE MAINTENANCE

The holder of a Pilot Certificate issued under FAR Part 61 may perform certain preventive maintenance described in FAR Part 43. This maintenance may be performed only on an aircraft which the pilot owns or operates and which is not used to carry persons or property for hire, except as provided in applicable FAR's. Although such maintenance is allowed by law, each individual should make a self-analysis as to whether he has the ability to perform the work.

All other maintenance required on the airplane should be accomplished by appropriately licensed personnel.

If maintenance is accomplished, an entry must be made in the appropriate logbook. The entry should contain:

- (a) The date the work was accomplished.
- (b) Description of the work.
- (c) Number of hours on the aircraft.
- (d) The certificate number of pilot performing the work.
- (e) Signature of the individual doing the work.

REQUIRED SERVICE AND INSPECTION PERIODS

The Owner Service Agreement which the owner receives upon delivery of the aircraft should be kept in the aircraft at all times. This identifies him to authorized Piper dealers and entitles the owner to receive service in accordance with the regular service agreement terms. This agreement also entitles the transient owner full warranty by any Piper dealer in the world.

Piper Aircraft Corporation has developed inspection items and required inspection intervals for the PA-28 (see PA-28 Service and Inspection Manuals). The PA-28 Inspection Manual contains appropriate forms, and all inspection procedures should be complied with by a properly trained, knowledgeable, and qualified mechanic at an authorized Piper Service Center or a reputable repair shop. Piper Aircraft Corporation cannot accept responsibility for the continued airworthiness of any aircraft not maintained to these standards, and/or not brought into compliance with applicable Service Bulletins issued by Piper Aircraft Corporation, instructions issued by the engine, propeller, or accessory manufacturers, or Airworthiness Directives issued by the FAA.

A Programmed Inspection, approved by the Federal Aviation Administration (FAA), is also available to the owner. This involves routine and detailed inspections to allow maximum utilization of the airplane. Maintenance inspection costs are reduced, and the maximum standard of continued airworthiness is maintained. Complete details are available from Piper Aircraft Corporation.

In addition, but in conjunction with the above, the FAA requires periodic inspections on all aircraft to keep the Airworthiness Certificate in effect. The owner is responsible for assuring compliance with these inspection requirements and for maintaining proper documentation in logbooks and/or maintenance records.

A spectrographic analysis of the engine oil is available from several sources. This inspection, if performed properly, provides a good check of the internal condition of the engine. To be accurate, induction air filters must be cleaned or changed regularly, and oil samples must be taken and sent in at regular intervals.

CHEROKEE ARCHER

IDENTIFICATION LETTER	LUBRICANT	SPECIFICATION	PREFERRED PRODUCT AND VENDOR
A	LUBRICATING OIL, GENERAL PURPOSE, LOW TEMP	MIL-L-7870	
B	LUBRICATING OIL, AIRCRAFT (PISTON) GRADE AS SPECIFIED SAE 50 ABOVE 60 F AIR TEMP. SAE 40 30 F TO 90 F AIR TEMP. SAE 30 20 BELOW 10 F AIR TEMP. HYDRAULIC FLUID, PETROLEUM BASE	MIL-L-6082 MIL-H-5606 MIL-G-23827	
C	GREASE, AIRCRAFT AND INSTRUMENT, GEAR AND ACTUATOR SCREW GREASE, AIRCRAFT, HIGH TEMP.		TEXACO MARFAK ALL PURPOSE GREASE, MOBIL GREASE 77 (OR MOBILUX EP2), SHELL ALVANIA EP GREASE 2
F	PARKER "O" RING LUBRICANT		FISKE BROS. REFINING CO.
G	AERO LUBRIPLATE		
H	FLUOROCARBON RELEASE AGENT DRY LUBRICANT	*MS-122	
I	GEN. PURPOSE AIRCRAFT	MIL-G-7711	

TYPE OF LUBRICANT		SPECIAL INSTRUCTIONS	
METHOD OF LUBRICATION	FREQUENCY OF LUBRICATION	1. AIR FILTER - TO CLEAN FILTER, TAP GENTLY TO REMOVE DIRT PARTICLES. DO NOT BLOW OUT WITH COMPRESSED AIR OR USE OIL. REPLACE FILTER IF PUNCTURED OR DAMAGED.	1. AIR FILTER - TO CLEAN FILTER, TAP GENTLY TO REMOVE DIRT PARTICLES. DO NOT BLOW OUT WITH COMPRESSED AIR OR USE OIL. REPLACE FILTER IF PUNCTURED OR DAMAGED.
TYPE OF LUBRICANT	SPECIAL INSTRUCTIONS	2. BEARINGS AND BUSHINGS - CLEAN EXTERIOR WITH A DRY TYPE SOLVENT BEFORE LUBRICATING.	2. BEARINGS AND BUSHINGS - CLEAN EXTERIOR WITH A DRY TYPE SOLVENT BEFORE LUBRICATING.
		3. WHEEL BEARINGS - DISASSEMBLE AND CLEAN WITH A DRY TYPE SOLVENT. ASCERTAIN THAT GREASE IS PACKED BETWEEN THE BEARING ROLLER AND CONE. DO NOT PACK GREASE IN WHEEL HOUSING.	3. WHEEL BEARINGS - DISASSEMBLE AND CLEAN WITH A DRY TYPE SOLVENT. ASCERTAIN THAT GREASE IS PACKED BETWEEN THE BEARING ROLLER AND CONE. DO NOT PACK GREASE IN WHEEL HOUSING.
		4. OLEO STRUTS AND BRAKE RESERVOIR - FILL PER INSTRUCTIONS ON UNIT OR CONTAINER, OR REFER TO SERVICE MANUAL, SECTION II	4. OLEO STRUTS AND BRAKE RESERVOIR - FILL PER INSTRUCTIONS ON UNIT OR CONTAINER, OR REFER TO SERVICE MANUAL, SECTION II
		5. "O" RING CONTROL SHAFT BUSHING (WITH 1.125 INCH SHAFT ONLY) - DISASSEMBLE "O" RING RETAINER PLATES FROM INSTRUMENT PANEL. LUBRICATE "O" RING AND REASSEMBLE.	5. "O" RING CONTROL SHAFT BUSHING (WITH 1.125 INCH SHAFT ONLY) - DISASSEMBLE "O" RING RETAINER PLATES FROM INSTRUMENT PANEL. LUBRICATE "O" RING AND REASSEMBLE.
		6. LUBRICATION POINTS - WIPE ALL LUBRICATION POINTS CLEAN OF OLD GREASE, OIL, DIRT, ETC. BEFORE LUBRICATING.	6. LUBRICATION POINTS - WIPE ALL LUBRICATION POINTS CLEAN OF OLD GREASE, OIL, DIRT, ETC. BEFORE LUBRICATING.
		7. INTERVALS BETWEEN OIL CHANGES CAN BE INCREASED AS MUCH AS 100% ON ENGINES EQUIPPED WITH FULL FLOW (CARTRIDGE TYPE) OIL FILTERS, PROVIDED THE ELEMENT IS REPLACED EACH 50 HOURS OF OPERATION.	7. INTERVALS BETWEEN OIL CHANGES CAN BE INCREASED AS MUCH AS 100% ON ENGINES EQUIPPED WITH FULL FLOW (CARTRIDGE TYPE) OIL FILTERS, PROVIDED THE ELEMENT IS REPLACED EACH 50 HOURS OF OPERATION.

SPECIAL INSTRUCTIONS (cont)

- STABILATOR TRIM PULLEYS - LUBRICATION MAY BE EXTENDED TO 250 HOURS WHEN DUSTY CONDITIONS ARE AT A MINIMUM.
- ALLERON HINGES WITH TEFLON SLEEVES SHOULD NOT BE LUBRICATED. ALLERON HINGES WITHOUT TEFLON SLEEVES SHOULD FIRST BE CLEANED WITH A DRY TYPE SOLVENT THEN LUBRICATED WITH MIL-L-7870 LUBRICATING OIL.
- THIS TRANSMISSION TO BE 1/2 FULL OF GREASE. APPLY GREASE DURING ASSEMBLY AND LUBRICATE TRANSMISSION BALL NUT AND SCREW WITH MIL-G-23827 GREASE.

NOTES

- PILOT AND PASSENGER SEATS - LUBRICATE TRACK ROLLERS AND STOP PINS AS REQUIRED. (TYPE OF LUBRICANT: "A")
- WHEEL BEARINGS REQUIRE CLEANING AND REPACKING AFTER EXPOSURE TO AN ABNORMAL QUANTITY OF WATER.
- FUEL SELECTOR VALVE - LUBRICATE FUEL SELECTOR VALVE AS REQUIRED. REFER TO PIPER SERVICE LETTERS NO. 351
- SEE LYCOMING SERVICE INSTRUCTIONS NO. 1014 FOR USE OF DETERGENT OIL.

CAUTIONS

- DO NOT USE HYDRAULIC FLUID WITH A CASTOR OIL OR ESTER BASE.
- DO NOT OVER-LUBRICATE COCKPIT CONTROLS.
- DO NOT APPLY LUBRICANT TO RUBBER PARTS.

EXAMPLE

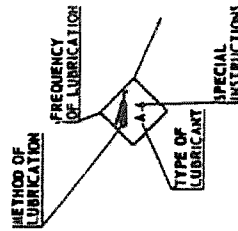

Lubrication Nomenclature

Garmin International, Inc.
1200 E. 151st Street
Olathe, Kansas 66062 U.S.A.

FAA APPROVED

AIRPLANE FLIGHT MANUAL SUPPLEMENT

or

SUPPLEMENTAL AIRPLANE FLIGHT MANUAL

for the

Garmin GTX 33X and GTX 3X5 Transponders with ADS-B
as installed in

Piper PA 28-180

Make and Model Airplane

Registration Number: N1992TF Serial Number: 28-7405237

This document serves as an FAA Approved Airplane Flight Manual Supplement or Supplemental Airplane Flight Manual when the GTX 33X or GTX 3X5 with ADS-B is installed in accordance with Supplemental Type Certificate SA01714WI. This document must be incorporated into the FAA Approved Airplane Flight Manual or provided as an FAA Approved Supplemental Airplane Flight Manual.

The information contained herein supplements the FAA approved Airplane Flight Manual. For limitations, procedures, loading and performance information not contained in this document, refer to the FAA approved Airplane Flight Manual, markings, or placards.

FAA Approved By:

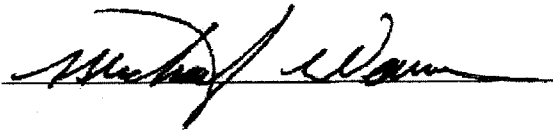

Michael Warren
ODA STC Unit Administrator
Garmin International, Inc.
ODA-240087-CE

Date: 08-MAR-2016

LOG OF REVISIONS

Revision Number	Page		Description	FAA Approved
	Date	Number		
1	05/01/2013	All	Complete Supplement	<i>Robert Murray</i> Robert Murray ODA STC Unit Administrator Garmin International, Inc. ODA-240087-CE Date: <u>05/01/2013</u>
2	03/08/2016	All	New supplement format with GTX 3X5 added.	See cover page

Table of Contents

SECTION	PAGE
Section 1. GENERAL	4
1.1 GTX 33X	4
1.2 GTX 3X5	6
1.3 Capabilities	8
1.4 Installation Configuration	9
1.5 Definitions	11
Section 2. LIMITATIONS	12
2.1 Minimum Equipment	12
2.2 ADS-B Out	12
2.3 TIS Traffic Display with User Navigation Angle	12
2.4 Applicable System Software	13
2.5 Pressure Altitude Broadcast Inhibit (PABI)	13
2.6 Datalinked Weather Display (GTX 345 Only)	13
2.7 Portable Electronic Devices	13
Section 3. EMERGENCY PROCEDURES	14
3.1 Emergency Procedures	14
3.2 Abnormal Procedures	14
Section 4. NORMAL PROCEDURES	16
4.1 Unit Power On	16
4.2 Before Takeoff	17
Section 5. PERFORMANCE	17
Section 6. WEIGHT AND BALANCE	17
Section 7. SYSTEM DESCRIPTION	18
7.1 GTX TIS Behavior	18
7.2 GTX 345R and G950/1000 No Bearing Traffic Alerts	18

Section 1. GENERAL

1.1 GTX 33X

The Garmin GTX 33X family consists of the GTX 330 ES and GTX 33 ES (Non-Diversity Mode S Transponders) and the GTX 330D ES and GTX 33D ES (Diversity Mode S Transponders). The ES option of any of the transponders provides ADS-B extended squitter functionality.

All Garmin GTX 33X transponders are a radio transmitter/receiver that operates on radar frequencies, receiving ground radar or TCAS interrogations at 1030 MHz and transmitting a coded response of pulses to ground-based radar on a frequency of 1090 MHz. Each unit is equipped with IDENT capability and will reply to ATCRBS Mode A, Mode C and Mode S All-Call interrogation. Interfaces to the GTX 33X are shown in the following block diagrams.

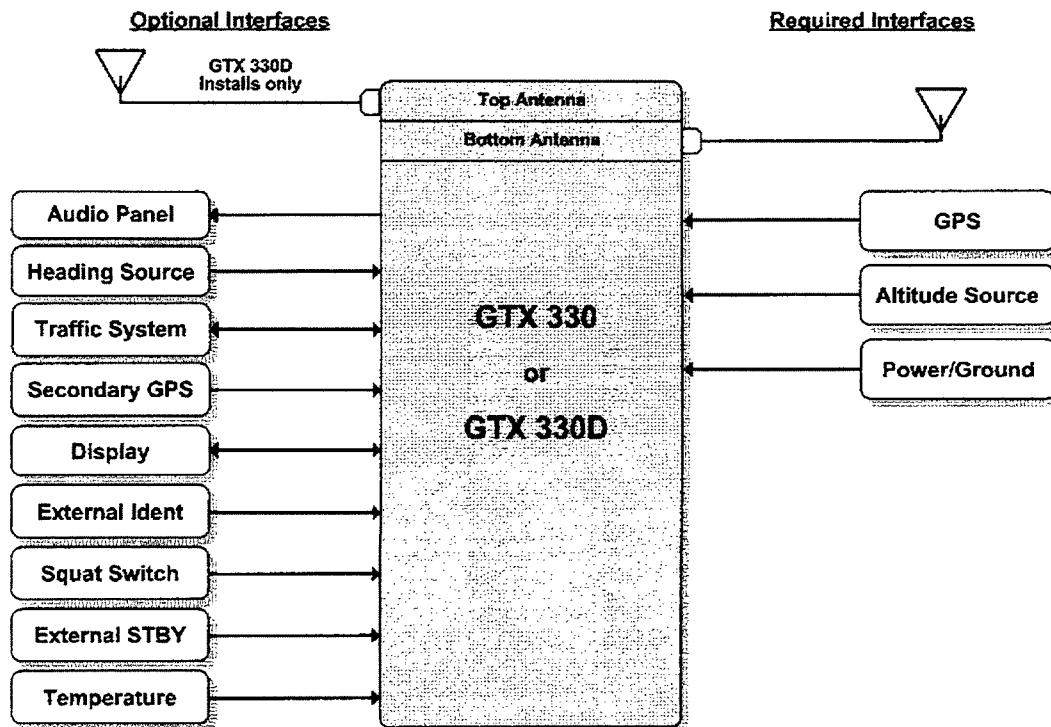

Figure 1 – GTX 330 or GTX 330D Interface Summary

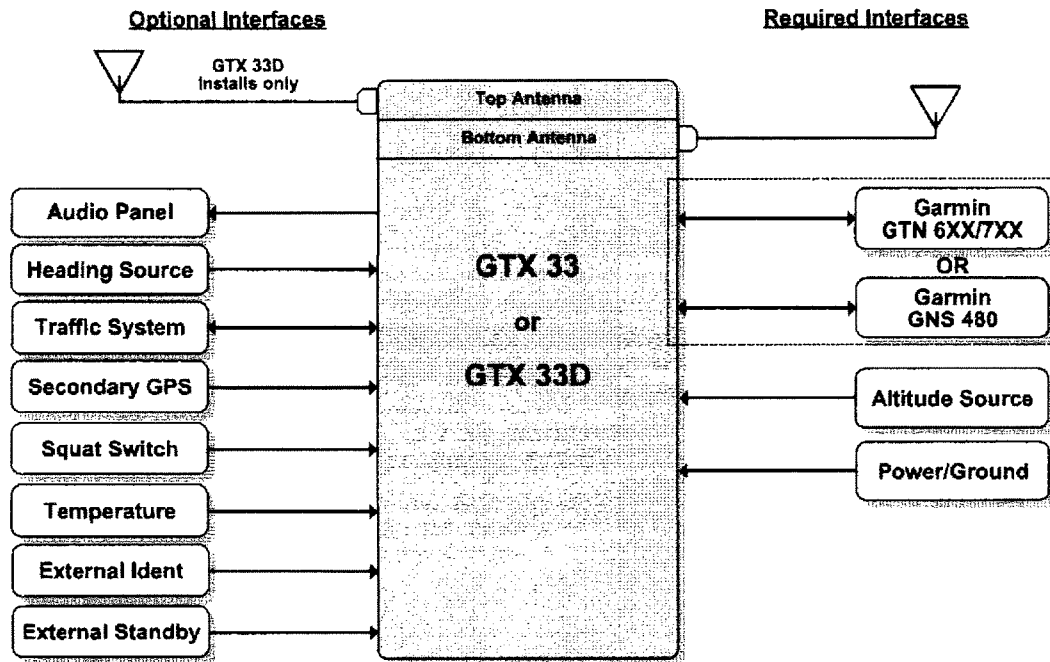

Figure 2 – GTX 33 or GTX 33D Interface Summary

The GTX 33X performs the following functions:

- Transmission of ADS-B out data on 1090 extended squitter (1090ES) (1090 MHz)
 - Integration of data from internal and external sources to transmit the following data per 14 CFR 91.227:
 - GPS Position, Altitude, and Position Integrity
 - Ground Track and/or Heading, Ground Speed, and Velocity Integrity
 - Air Ground Status
 - Flight ID, Call Sign, ICAO Registration Number
 - Capability and Status Information
 - Transponder Squawk Code, IDENT, and Emergency Status
 - Pressure Altitude Broadcast Inhibit
- Reception of TIS-A traffic data from a ground station
- Provide TIS-A traffic alerting to the pilot via interfaced display and audio output

1.2 GTX 3X5

The Garmin GTX 3X5 family consists of the GTX 335, 335R, 345, and 345R transponders. The functional differences between each of these transponders are described in Table 1.

Function	GTX 335	GTX 335 w GPS	GTX 335R	GTX 335R w GPS	GTX 345	GTX 345 w GPS	GTX 345R	GTX 345R w GPS
Panel mount	x	x			x	x		
Remote mount			x	x			x	x
Mode S	x	x	x	x	x	x	x	x
ADS-B (out)	x	x	x	x	x	x	x	x
ADS-B Traffic					x	x	x	x
FIS-B					x	x	x	x
Internal GPS		x		x		x		x
Bluetooth					x	x	x	x
Optional Garmin Altitude Encoder	x	x	x	x	x	x	x	x

Table 1 – GTX 3X5 Unit Configurations

Interfaces to the GTX 3X5 are shown in Figure 3.

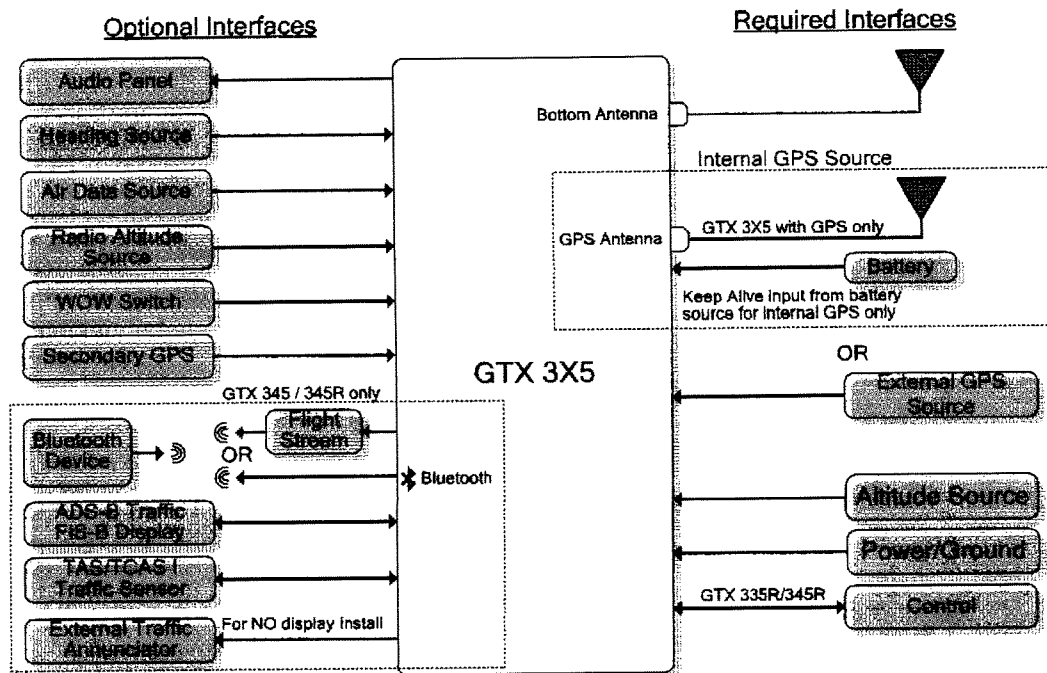

Figure 3 – GTX 3X5 Interface Summary

The GTX 3X5 performs the following functions:

- Transmission of ADS-B out data on 1090 extended squitter (1090ES) (1090 MHz)
 - Integration of data from internal and external sources to transmit the following data per 14 CFR 91.227:
 - GPS Position, Altitude, and Position Integrity
 - Ground Track and/or Heading, Ground Speed, and Velocity Integrity
 - Air Ground Status
 - Flight ID, Call Sign, ICAO Registration Number
 - Capability and Status Information
 - Transponder Squawk Code, IDENT, and Emergency Status
 - Pressure Altitude Broadcast Inhibit

The GTX 335 performs the following additional functions:

- Reception of TIS-A traffic data from a ground station
- Provide TIS-A traffic alerting to the pilot via interfaced display and audio output.

The GTX 345 performs the following additional functions:

- Reception of ADS-B In data on 1090 MHz
 - ADS-B (Data directly from another transmitting aircraft)
 - ADS-R (Rebroadcast of ADS-B data from a ground station)
- Reception of ADS-B In data on UAT (978 MHz)
 - ADS-B (Data directly from another transmitting aircraft)
 - ADS-R (Rebroadcast of ADS-B data from a ground station)
 - TIS-B (Broadcast of secondary surveillance radar) (SSR) derived traffic information from a ground station.
 - FIS-B (Broadcast of aviation data from a ground station)
- Provide ADS-B traffic information and alerting to the pilot via an interfaced display
 - Correlation and consolidation of traffic data from multiple traffic sources
 - Aural and visual traffic alerting
- Provide FIS-B data to the pilot via an interfaced display
 - Graphical and textual weather products
 - NEXRAD
 - PIREPs
 - AIRMET/SIGMETs
 - METARs
 - TAFs
 - Winds Aloft
 - Aviation Data
 - TFRs
 - NOTAMs

1.3 Capabilities

The Garmin GTX 33X and GTX 3X5 as installed in this aircraft have been shown to meet the equipment requirements of 14 CFR § 91.227 when operating in accordance with sections 2.1 and 2.2 of this supplement.

1.4 Installation Configuration

This aircraft is equipped with a GTX 33X and/or GTX 3X5 with the following interfaces/ features:

Equipment Installed:

Transponder #1

- GTX 330
- GTX 330D
- GTX 33
- GTX 33D
- GTX 335
- GTX 335R
- GTX 345
- GTX 345R

Transponder #2 (if installed)

- GTX 330
- GTX 330D
- GTX 33
- GTX 33D
- GTX 335
- GTX 335R
- GTX 345
- GTX 345R

Interfaced GPS/SBAS Position Source(s):

GPS #1

- Internal
- GTN 6XX/7XX Series
- GNS 400W/500W Series
- GNS 480
- GIA 63
- GDL 88 (GTX 330 only)

GPS #2 (if installed)

- Internal
- GTN 6XX/7XX Series
- GNS 400W/500W Series
- GNS 480
- GIA 63
- GDL 88 (GTX 330 only)

Interfaced Pressure Altitude Source:

Pressure Altitude Source #1

- _____
- Garmin Altitude Encoder

Pressure Altitude Source #2 (if installed)

- _____
- Garmin Altitude Encoder

Interfaced Remote Control Display (Required for remotely mounted GTX variants):

Transponder #1 Remote Control Display

- GTN 6XX/7XX
- GNS 480
- G950/1000 Display

Transponder #2 Remote Control Display
(if installed)

- GTN 6XX/7XX
- GNS 480
- G950/1000 Display

Interfaced Active Traffic System:

- None
- TCAD
- TAS/TCAS

NOTE

If the system includes all of the following components:

- GTX 345R,
- G950/1000 Display, and
- TCAD or TAS/TCAS

Then the aircraft is no longer equipped with a TSO compliant active TCAD, TAS or TCAS system. Any operational requirement to be equipped with such system is no longer met.

1.5 Definitions

The following terminology is used within this document:

ADS-B:	Automatic Dependent Surveillance-Broadcast
AFM:	Airplane Flight Manual
AFMS:	Airplane Flight Manual Supplement
ATCRBS:	Air Traffic Control Radar Beacon System
CFR:	Code of Federal Regulations
ES:	Extended Squitter
GNSS:	Global Navigation Satellite System
GNS:	Garmin Navigation System
GPS:	Global Positioning System
GTX:	Garmin Transponder
GTN:	Garmin Touchscreen Navigator
ICAO:	International Civil Aviation Organization
LRU:	Line Replaceable Unit
PABI:	Pressure Altitude Broadcast Inhibit
POH:	Pilot Operating Handbook
SBAS:	Satellite-Based Augmentation System
SW:	Software
TCAS:	Traffic Collision Avoidance System
TIS:	Traffic Information Service
TX:	Transmit

Section 2. LIMITATIONS

2.1 Minimum Equipment

The GTX 33X and GTX 3X5 must have the following system interfaces fully functional in order to be compliant with the requirements for 14 CFR 91.227 ADS-B Out operations:

Interfaced Equipment	Number Installed	Number Required
Uncorrected Pressure Altitude Source	1	1
GPS SBAS Position Source	1 or more	1
Remote Control Display (for remotely mounted transponders)	1 or more	1

Table 2 – Required Equipment

2.2 ADS-B Out

The GTX 33X and GTX 3X5 only comply with 14 CFR 91.227 for ADS-B Out when all required functions are operational. When the system is not operational, ADS-B Out transmit failure messages will be present on the remote control display interface, or the GTX 330 or GTX 3X5 panel display.

2.3 TIS Traffic Display with User Navigation Angle

Display of TIS traffic from a GTX 33/330 or GTX 335 is not permitted with an interfacing display configured for a navigation angle of “user”.

2.4 Applicable System Software

This AFMS/AFM is applicable to the software versions shown in Table 3.

The Main GTX software version is displayed on the splash screen during start up for the GTX 330 and GTX 3X5 panel mounted units, and the External LRU or System page on the interfaced remote control display for remotely mounted GTX transponders.

Software Item	Software Version <i>(or later FAA Approved versions for this STC)</i>
GTX 33X Main SW Version	8.02
GTX 3X5 Main SW Version	2.02

Table 3 - Software Versions

2.5 Pressure Altitude Broadcast Inhibit (PABI)

Pressure Altitude Broadcast Inhibit shall only be enabled when requested by Air Traffic Control while operating within airspace requiring an ADS-B Out compliant transmitter per 14 CFR 91.227. PABI is enabled by selecting the GTX to ON mode.

2.6 Datalinked Weather Display (GTX 345 Only)

Do not use datalink weather information for maneuvering in, near, or around areas of hazardous weather. Information provided by datalink weather products may not accurately depict current weather conditions.

Do not use the indicated datalink weather product age to determine the age of the weather information shown by the datalink weather product. Due to time delays inherent in gathering and processing weather data for datalink transmission, the weather information shown by the datalink weather product may be significantly older than the indicated weather product age.

Do not rely solely upon datalink services to provide Temporary Flight Restriction (TFR) or Notice to Airmen (NOTAM) information.

2.7 Portable Electronic Devices

This STC does not relieve the operator from complying with the requirements of 91.23 or any other operational regulation regarding portable electronic devices.

Section 3. EMERGENCY PROCEDURES

3.1 Emergency Procedures

No Change.

3.2 Abnormal Procedures

3.2.1 LOSS OF AIRCRAFT ELECTRICAL POWER GENERATION

XPDR Circuit Breaker **PULL**

Transponder and ADS-B Out functions will no longer be available.

NOTE

This guidance is supplementary to any guidance provided in the POH or AFM for the installed aircraft for loss of power generation.

3.2.2 LOSS OF GPS/SBAS POSITION DATA

When the GPS/SBAS receiver is inoperative or GPS position information is not available or invalid, the GTX will no longer be transmitting ADS-B Out data.

For GTX 330 installations:

NO ADSB annunciator illuminated:

Interfaced GPS position sources **VERIFY VALID POSITION**

For GTX 3X5 installations:

NO 1090ES TX annunciator illuminated:

Interfaced GPS position sources **VERIFY VALID POSITION**

For GTX 33 and GTX 3X5R installations:

Reference Display Device documentation for applicable annunciation:

Interfaced GPS position sources **VERIFY VALID POSITION**

3.2.3 Dual GTX 3X5R Transponders in a G950/1000 installation

If Transponder #1 fails and Transponder #2 is activated by the pilot, the G1000 display will provide nuisance alerts unless power is removed from Transponder #1.

Transponder #1 Failed, Transponder #2 Active

Transponder #1 Circuit Breaker **PULL**

Section 4. NORMAL PROCEDURES

The procedures described below are specific only to the panel mounted GTX 330 or GTX 3X5 transponders. Cockpit Reference Guides and Pilot Guides for interfaced remote control displays will provide additional operating information specific to the displays or other traffic systems.

ADS-B Out functionality resides within the GTX transponders thereby providing a single point of entry for Mode 3/A code, Flight ID, IDENT functionality and activating or deactivating emergency status for both transponder and ADS-B Out functions. Details on performing these procedures are located in the GTX 330/330D Pilot's Guide and GTX 3X5 Series Transponder Pilot's Guide.

4.1 Unit Power On

For GTX 330 installations:

GTX Mode..... **VERIFY ALT**
NO ADSB **CONSIDERED**

For GTX 3X5 installations:

GTX Mode..... **VERIFY ALT**
NO 1090ES TX..... **CONSIDERED**

NOTE

The NO ADS-B or NO 1090ES TX Annunciation (or associated display annunciations) may illuminate as the unit powers on and begins to receive input from external systems, to include the SBAS position source.

4.2 Before Takeoff

For GTX 330 installations:

ADS-B TX..... **VERIFY ON**
NO ADSB..... **EXTINGUISHED**

For GTX 3X5 installations:

1090ES TX CTL..... **VERIFY ON**
NO 1090ES TX..... **EXTINGUISHED**

NOTE

The ADS-B TX or 1090ES TX CTL must be turned on and the NO ADS-B or NO 1090ES TX Annunciation (or associated display annunciations) must be **EXTINGUISHED** for the system to meet the requirements specified in 14 CFR 91.227. This system must be operational in certain airspaces after January 1, 2020 as specified by 14 CFR 91.225.

Section 5. PERFORMANCE

No change.

Section 6. WEIGHT AND BALANCE

See current weight and balance data.

Section 7. SYSTEM DESCRIPTION

The Garmin GTX 330 and GTX 3X5 Pilot's Guides, part numbers, and revisions listed below contain additional information regarding GTX system description, control, and function.

<u>Title</u>	<u>Part Number</u>	<u>Revision</u>
GTX 330 Pilot's Guide	190-00207-00	Rev. G (or later)
GTX 3X5 Pilot's Guide	190-01499-00	Rev. A (or later)

Pilot's Guides for interfaced displays, part numbers and revisions listed below, provide additional operating information for the Garmin GTX 33 and GTX 3X5R.

<u>Title</u>	<u>Part Number</u>	<u>Revision</u>
Garmin GTN 725/750 Pilot's Guide	190-01007-03	Rev. E (or later)
Garmin GTN 625/635/650 Pilot's Guide	190-01004-03	Rev. E (or later)
GNS 480 Pilot's Guide	190-00502-00	Rev. D (or later)
GTX 3X5 Series Transponder G1000 Pilot's Guide	190-01499-01	Rev. A (or later)

7.1 GTX TIS Behavior

The TIS Standby/Operate controls for GTX 33/330 and GTX 335 units only function when the aircraft is airborne.

7.2 GTX 345R and G950/1000 No Bearing Traffic Alerts

No visual indication is provided for no bearing traffic alerts. Only an aural indication of the no bearing traffic alert is provided. If an aural alert for no bearing traffic has been previously issued, a "no bearing traffic clear" aural indication will be provided once all traffic alerts are resolved.

All aural alerts are inhibited below 500' AGL, therefore a "no bearing traffic clear" aural may not be heard in a landing or touch and go flight scenario.

