

FASTENERS





JIMSOAR INTERNATIONAL CORP.,
P. O. BOX 96-10 TAIPEI, TAIWAN, R.O.C.
TEL: 886-2-27040238 FAX: 882-2-27040177
E-MAIL : jimsoar@ms13.hinet.net

Drop In Anchor

Types: plain, knurling, with lip

Material: carbon steel, stainless steel A2/A4, Brass



Wedge Anchor

Types: with one/two clips

Material: carbon steel, stainless steel A2/A4

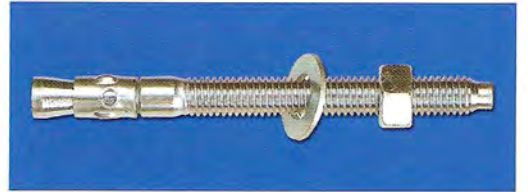

Chemical Anchor

Types: hex socket, external hex /
flat end, single cut end, double cuts end

Material: carbon steel, stainless steel A2/A4



Metal Frame Anchor

Sizes Available:

8x72/92/112/132/152/172

10x52/72/92/112/132/152/182/202



Ceiling Anchor

Size Available: 6x35, 65

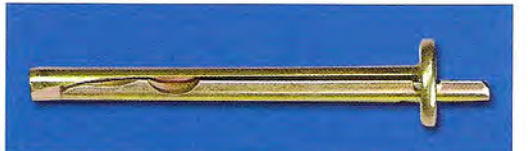

Ceiling Bracket

Size Available: 25x25



Tie Wire Anchor

Size Available: 6x50/60/120, 1/4x2, 1/4x2 1/2

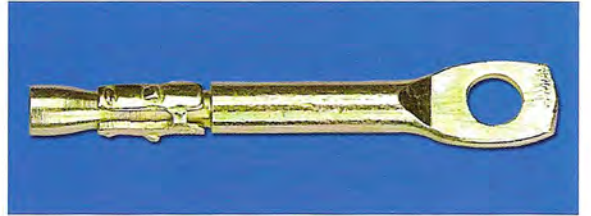

Hollow Wall Anchor

Size Available: M4x21/32/38/46/54/59
 M5x37/52/65/80
 M6x37/52/65/80
 M8x37/52/65/80

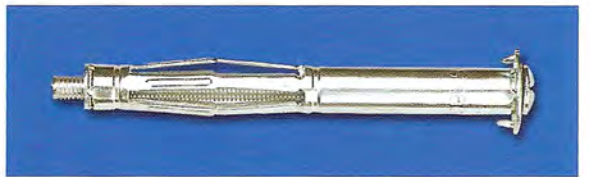

Zinc Alloy Nail In Anchor

Size Available:
 5x20, 6x30/40/50/65
 3/16x7/8, 1/4x3/4, 1, 1-1/4, 2, 2-1/2, 3



All Steel Nail In Anchor

Size Available: 6x30/40/50



Express Nail

Size Available:
 6x30/40/50/60/80/100
 8x70/90/110/130/150/180



Sleeve Anchor

Types:
With hex bolt, flat washer, cone nut;
With hex flange nut, plow bolt;
Countersunk / round head Philip Drive
Ceiling suspension head
With eyebolt / hook bolt
With forged eyebolt / hook bolt
Material: carbon steel, stainless steel A2/A4



Two Pieces Heavy Duty Anchor

Types:
With shield body only
With Hex bolt / Threaded stud;
With pressed eyebolt / hook bolt;
With forged eyebolt / hook bolt;

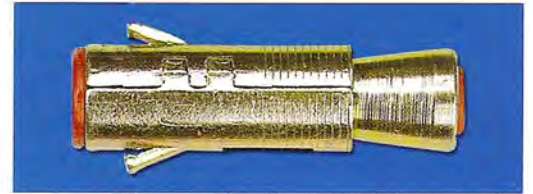

Three Pieces Heavy Duty Shield Anchor

Types:
With shield body only;
With Hex bolt / Threaded stud;
With pressed eyebolt / hook bolt;
With forged eyebolt / hook bolt;



Four Pieces Heavy Duty Shield Anchor

Types:
Four pieces shield with square cone nut;
With expansion body only;
With Hex bolt / Threaded stud;
With pressed eyebolt / hook bolt;
With forged eyebolt / hook bolt;
With square head stud;
(Stainless steel available upon request)



Cut Anchor

Size Available: M6/8/10/12/16/20/22
1/4, 5/16, 3/8, 1/2, 5/8, 3/4, 7/8

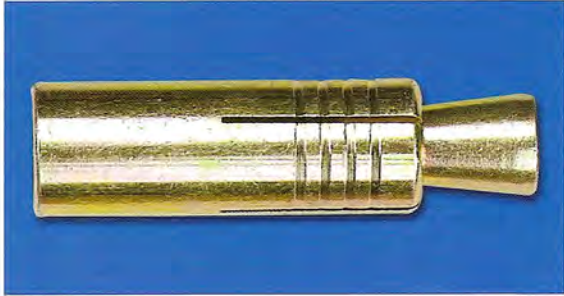

Bolt Anchor

Size Available: M6x50, M8x65/70
M10x70/80/100/120
M12x100/120/150/200
M16x100/120/150/200
M20x160/200, M24x200



Hit Anchor

Size Available: M6x45/65, M8x50/70,
M10x50/60/80/90/100/120
M12x60/70/90/100/120/150
M16x100/120/150/190,
M20x130/150/190/230

Material: carbon steel, stainless steel A2/A4



Self Drilling Anchor

Size Available: M6/8/10/12/16/20/22
1/4, 5/16, 3/8, 1/2, 5/8, 3/4, 7/8

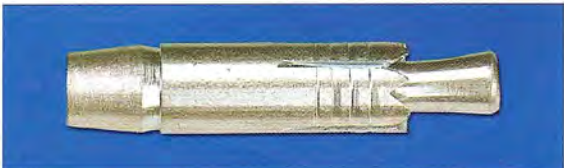

Stud Anchor

Size Available: 1/4, 5/16, 3/8, 1/2



Pipe Anchor

Size Available: M6/8/10/12

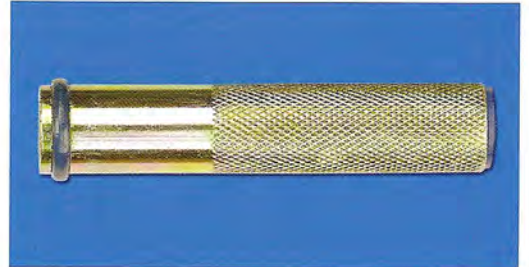

Saw Anchor

Size Available: 5x30, 6x32, 8x38, 8x60, 10x60



Wing Nut Toggle

Material: carbon steel, stainless steel;
(Stainless steel available upon request)



Wing Nut Toggle Bolt

With machine screw / Acoustical screw / eye
bolt / hook bolt;

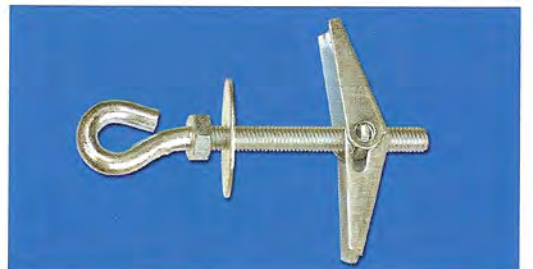

Gravity Toggle

Types:
With screw / threaded stud / eye bolt / hook bolt;

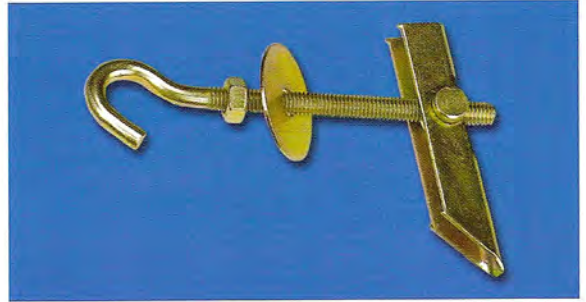

Pipe Clamps

Types:
Heavy clamp with glue;
Open heavy clamp with glue;
Heavy clamp adhesive tape single side fastened;
Heavy clamp without glue;
Open heavy clamp without glue;
Heavy clamp plastic sprayed / dipped;

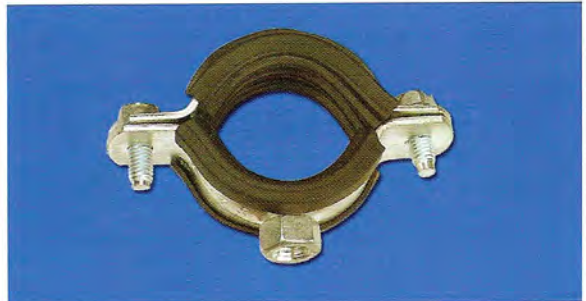

Worm-drive

Material: Carbon Steel, Stainless Steel A2/A4



Light Duty Sleeve Steel Anchor

Types:
With screw / L screw / eyebolt / Hook bolt / Threaded Studs

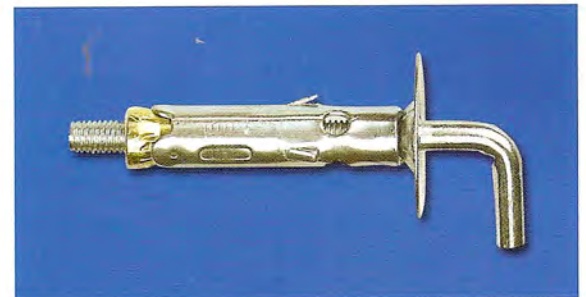

Zinc Alloy Speed Plug

Size Available: 28/32/38

**Zinc Alloy Expansion Anchor**

Types: Double/Single

**Zinc Alloy Lag Screw Shield**

Types: Short / Long

**Zinc Alloy Wood Screw Anchor****Zinc Alloy Machine Screw Anchor**

Split Drive Anchor

Types: Flat / Round / Tie Wire head, Double Flat Heads

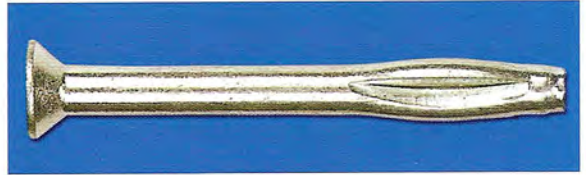

T-Nuts

Thread: ISO M3-M10, IFI 6#-3/8, BS 1/8-3/8
Material: Carbon steel, stainless steel



Timber Tooth Connectors

Sizes Available: 50/63mm single / double sided



Round/Hex Coupling Nuts



Eye Coupling nuts



Steel Pipe Coupling Nuts



Spring Nuts

Material: carbon steel, stainless steel A2/A4

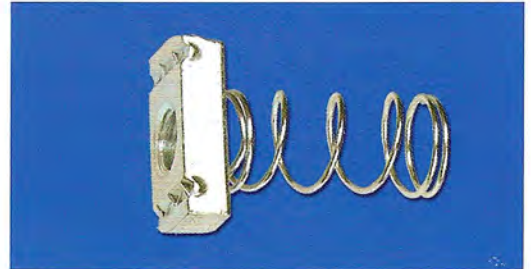

Nylon Window Frame Anchor

Size Available: 8x75/100/120/140, 10x75/100/120/140/165



Nylon Hammer Fixing Anchor

Types: countersunk head / round head / truss head

Material: Nylon / PE

Size Available: 5x25/30/35/40/45/50
6x30/35/40/45/50/55/60/70/80
8x40/45/50/60/80/100/120/135
10x80/100/120/135



Nylon Frame Fixing Anchor

Types: two wings / six wings

Size available: 6x35/40/50/60/80
8x40/50/60/80/100/120/135
10x80/100/115/135/160



Nylon Nail In Anchor

Types: round head / mushroom head / flat head

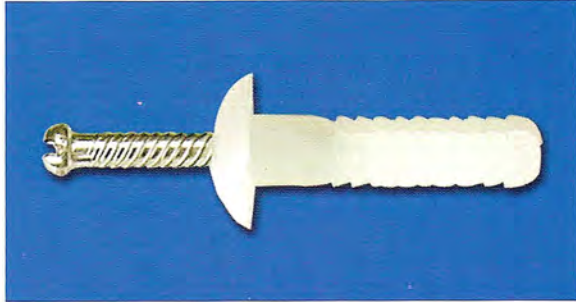

Nylon Screw In Anchor

Types: Pan / Countersunk Head



Nylon Toggle Anchor

Size available: 12/19/28



Nylon Toggle Wing

Size Available: 8x28, 8x32, 8x38

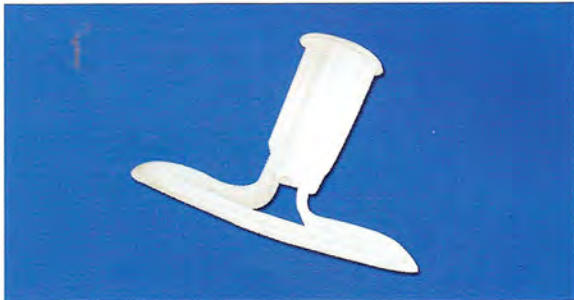

Nylon Easy Drive Anchor



American Style Plastic Conical Plug

Types: yellow/white/blue/green/super long 8#

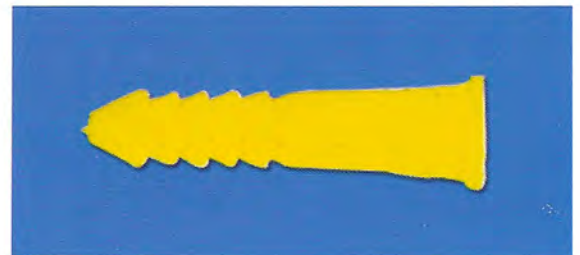

British Style Plastic Conical Plug

Types: yellow/red/brown/grey

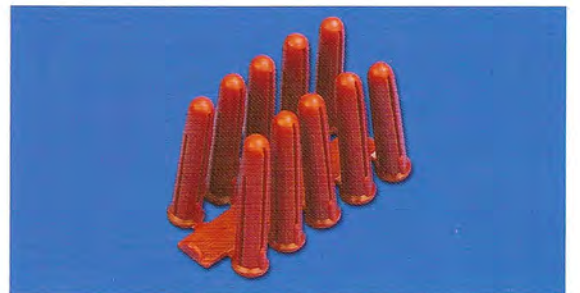

Nylon Screw Plug

Size Available: 5x25, 6x30, 7x35, 8x40, 10x50, 12x60

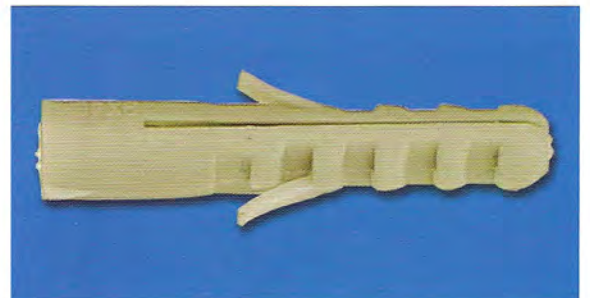

Plastic Screw Plug

Size Available: 5,6,8,10,12

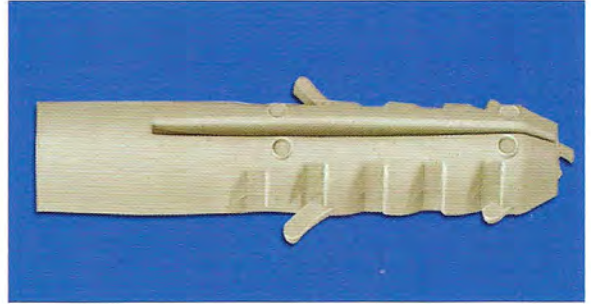

Vertical Type Plastic Conical Plug

Size Available: 3/16, 1/4, 5/16

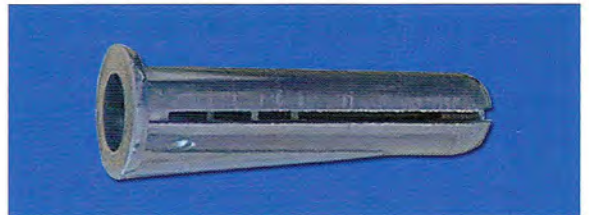

Open Type Plastic Conical Plug

Size Available: 3/16, 1/4, 5/16

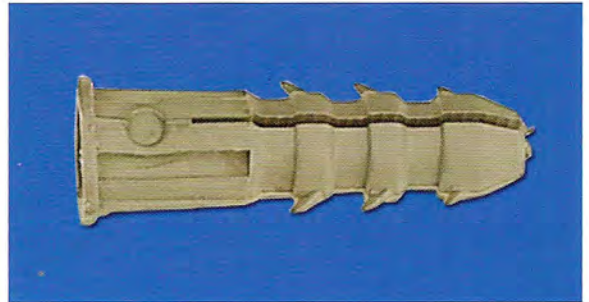

PE Universal Plug

Size Available: 6x36, 8x50, 10x60

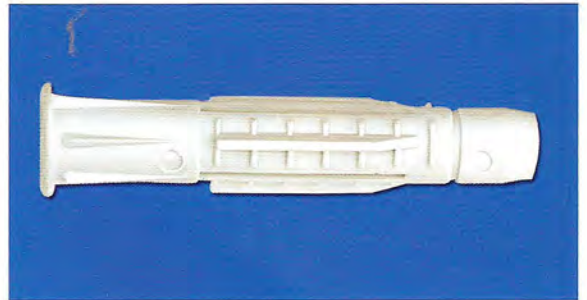

Nylon Hollow Wall Anchor

Size Available: 6x35, 8x50, 10x60

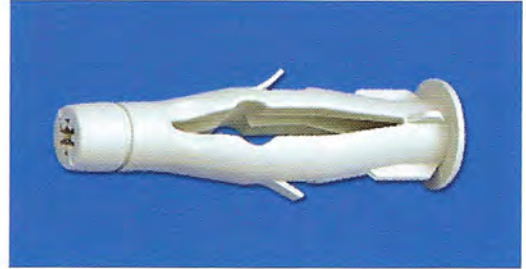

MYT NYLON PLUG

Size Available: 6,8,10,12

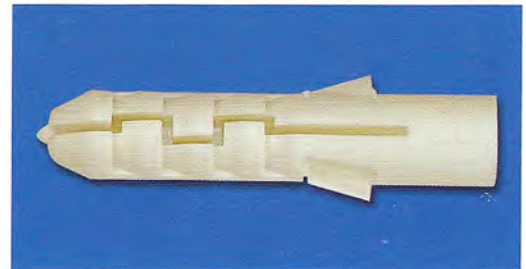

Light Duty Nylon Sleeve Anchor

Types:

With Pozi drive machine screw;

With L bolt;

With L long bolt;

With threaded studs;

With hook bolt;

With eye bolt;

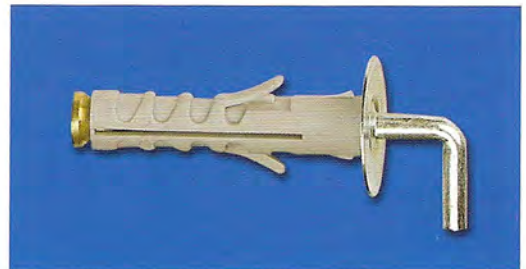

Plastic caps and washers

Types: white/brown/black/beige / chrome plated caps

Triangle washe





JIMSOAR INTERNATIONAL CORP.,
P. O. BOX 96-10 TAIPEI, TAIWAN, R.O.C.
TEL: 886-2-27040238 FAX: 882-2-27040177
E-MAIL : jimsoar@ms13.hinet.net

Hexagon Head Bolts

According to: DIN931, 601, 960, 6914
ISO4014, 4016
IFI C-6, C-8, E-34

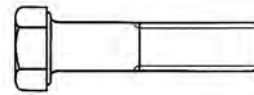

Hexagon Head Screws

According to: DIN933, 558, 961
ISO4017, 4018
B.S.4190
IFI C-10

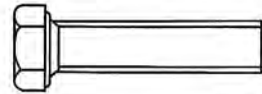

Hexagon Socket Head Cap Screws

According to: DIN912
ISO4762
B.S.4165

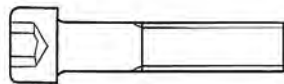

Hexagon Socket Countersunk Head Cap Screws

According to: DIN7991

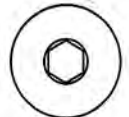
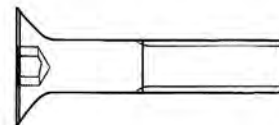

Hexagon Bolts With Hexagon Nuts

According to: DIN7990

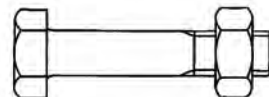

Flat Countersunk Head Square Neck Bolts

According to: DIN605, 608

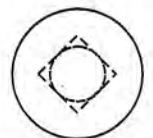
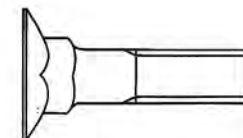

Hexagon Flange Bolts

According to: DIN6921
IFI C-28

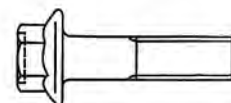

Mushroom Head Square Neck Bolts

According to: DIN603
IFI C-40
B.S.

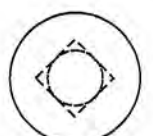
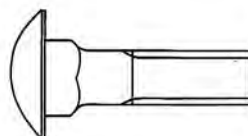

Lifting Eye Bolts

According to: DIN580

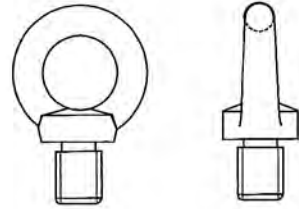

Cross Recessed Raised Cheese Head Screws

According to: DIN7985
ISO7045
IFI I-23

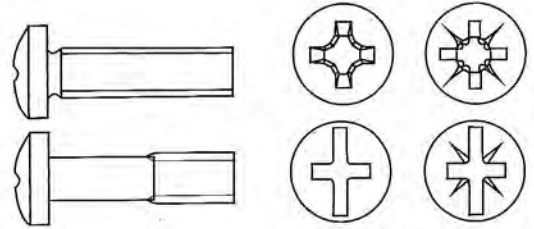

Cross Recessed Countersunk Flat Head Screws

According to: DIN965
ISO7046
IFI I-7

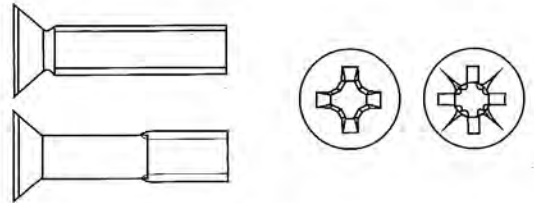

Cross Recessed Raised Countersunk Head Screws

According to: DIN966
ISO7047
IFI I-17

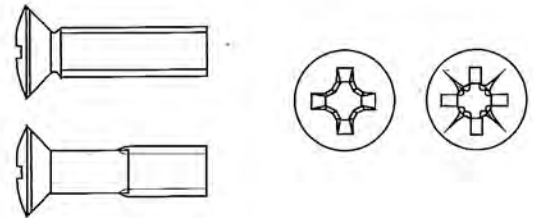

Slotted Pan Head Screws

According to: DIN85
ISO1580
IFI I-22

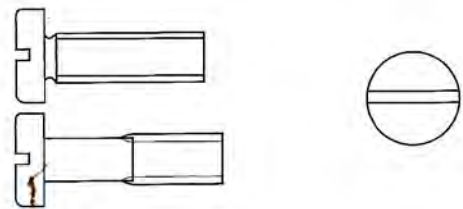

Slotted Cheese Head Screw

According to: DIN84
ISO1207
B.S.4183

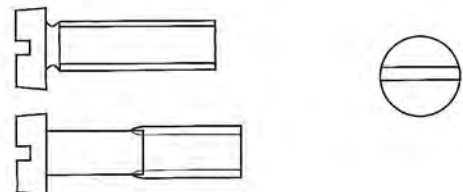

Slotted Countersunk Head Screws

According to: DIN963
ISO2009
B.S.4183
IFI I-6

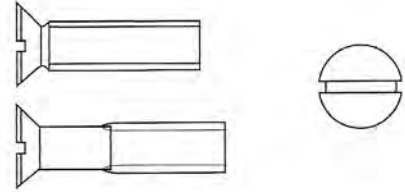

Slotted Raised/Oval Countersunk Head Screws

According to: DIN964
ISO2010
B.S.4183
IFI I-16

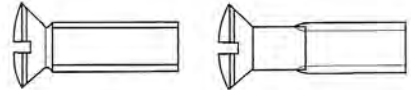

Roofing Bolts & Nuts

According to: DIN
B.S.
ART.J1252,J1253

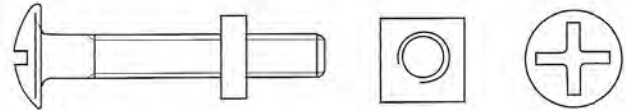

Truss Head Machine Screws

According to: IFI I-26
IFI I-27

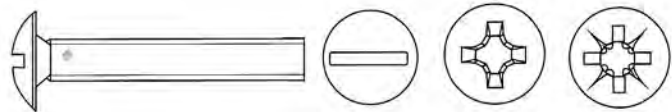

Thread Rods

According to: DIN975,976
B.S.
ANSI

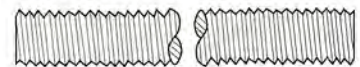

Thread Studs

According to: DIN835
DIN938
DIN939

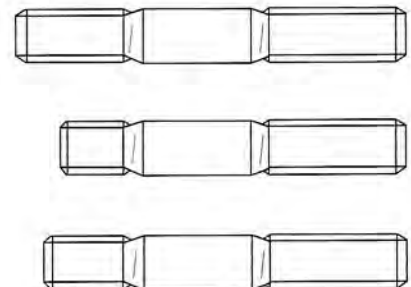

Bent Bolts

According to: DIN3570
IFIC-86-87

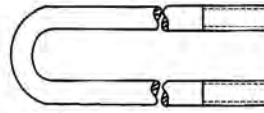

U-Bolt, Round Bend

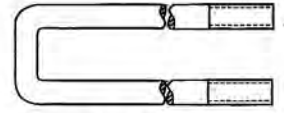

U-Bolt, Square Bend

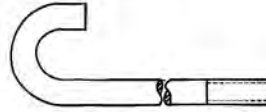

Hook Bolt, Round Bend

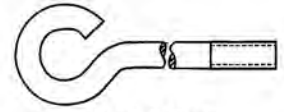

Eye Bolt, Open

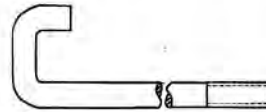

Hook Bolt, Square Bend

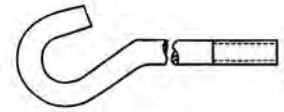

J-Bolt

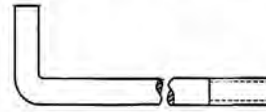

Hook Bolt, Right Angle Bend

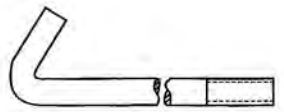

Hook Bolt, Special

Slotted Set Screws With Cup / Flat Point

According to: DIN438, DIN551
ISO7436, ISO4766
B.S.4219



Hexagon Socket Set Screws

According to: DIN913,914,915,916
ISO4029
B.S.4168

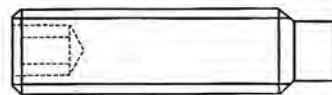
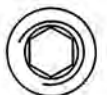
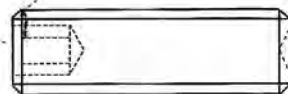
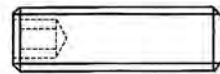
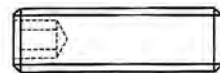

Hexagon Nuts

According to: DIN934,555,6915
 ISO4032,4033,4034
 B.S.916,1083,1768,1769
 IFI D-5,D-6,D-8,D-12,D-14,
 AS 1112
 UNI 5587
 JIS B1181-1961,B1181 JIS



Hexagon Thin Nuts

According to: DIN439,936
 ISO4035,1036



Square Nuts

According to: DIN562,557
 IFI D-3,D-12,D-26
 B.S.



Hexagon Nuts With Flange

According to: DIN6923
 ISO4161
 IFI D-21

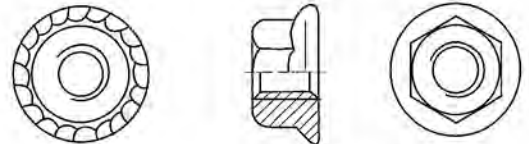

Hexagon Cap Nuts

According to: DIN917,1587,986

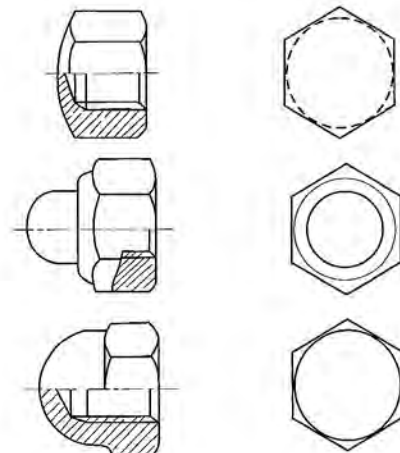

Square Weld Nuts

According to: DIN928

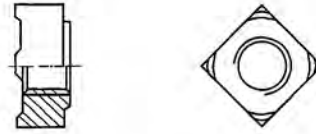

Hexagon Weld Nuts

According to: DIN929



Hexagon Slotted Nuts

According to: DIN935,937,979

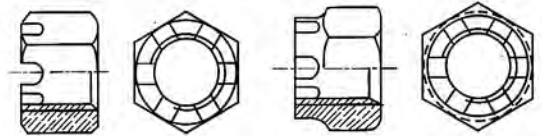

Prevailing Torque Type Hexagon Nuts

According to: DIN980,985

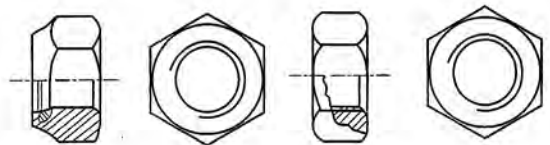

Lifting Eye Nuts

According to: DIN582

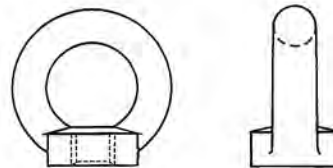

Wing Nuts

According to: DIN315

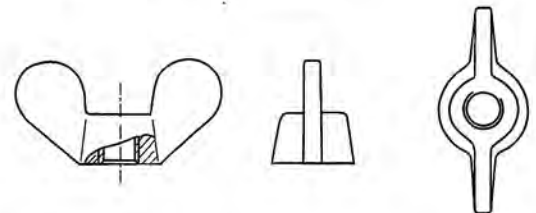

Hexagon Head Wood Screws

According to: DIN571,
IFI C-18



Cross Recessed Raised Countersunk Head Wood Screws

According to: DIN7995
B.S.1210
IFI J-39

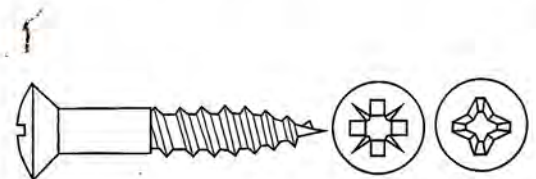

Cross Recessed Round Head Wood Screws

According to: DIN7996



Cross Recessed Countersunk Head Wood Screws

According to: DIN7997
B.S.1210
IFI J-37

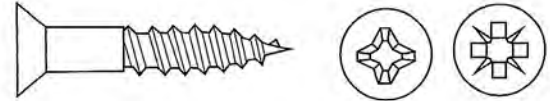

Slotted Raised Countersunk Head Wood Screws

According to: DIN95
IFI J-38
B.S.1210

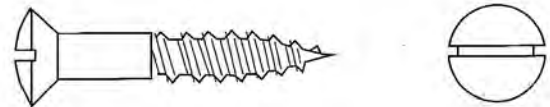

Slotted Round Head Wood Screws

According to: DIN96
B.S.1210



Slotted Countersunk Head Wood Screws

According to: DIN97
IFI J-36
B.S.1210



Pozidrive Twinfast Head Wood Screws

According to: B.S.

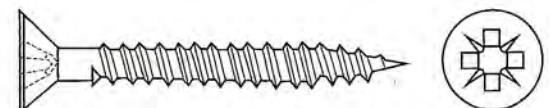

Pan Head Tapping Screws With Slot

According to: DIN7971
ISO1481
B.S.4174
IFI H-38

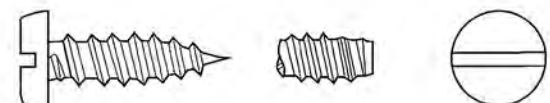

Countersunk Head Tapping Screws With Slot

According to: DIN7972
IFI H-24
B.S.4174
ISO1482

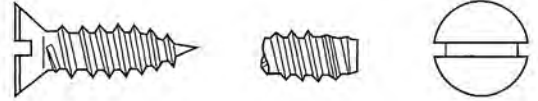

Raised Countersunk Head Tapping Screws With Slot

According to: DIN7973
IFI H-32
B.S.4174
ISO1483

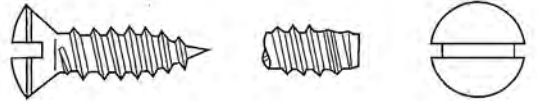

Hexagon Head/Washer Head Tapping Screws

According to: DIN7976,6928
ISO1479
B.S.4174

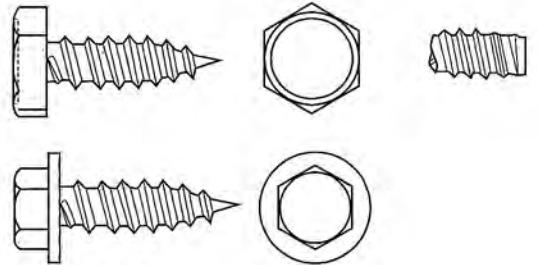

Cross Recessed Pan Head Tapping Screws

According to: DIN7981
IFI H-39
ISO7049

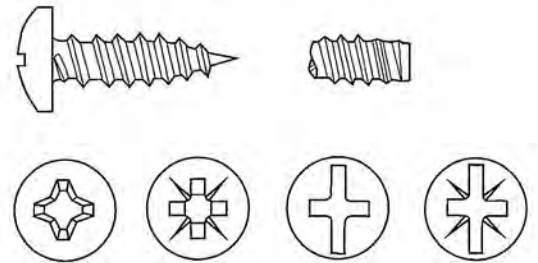

Cross Recessed Countersunk Head Tapping Screws

According to: DIN7982
IFI H-25
ISO7050

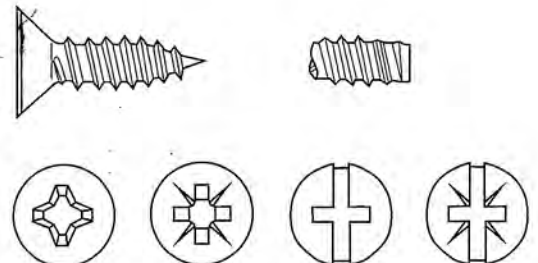

Cross Recessed Raised Countersunk Head Tapping Screws

According to: DIN7983
IFI H-33
ISO7051

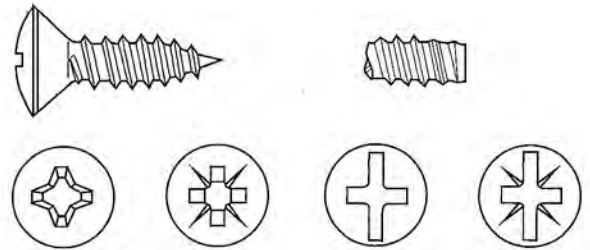

Cross Recessed Pan Head Tapping Screws With Collar

According to: DIN968

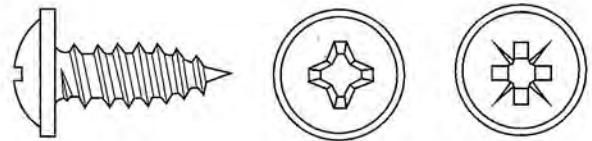

Self-Drilling Tapping Screws

According to: DIN7504

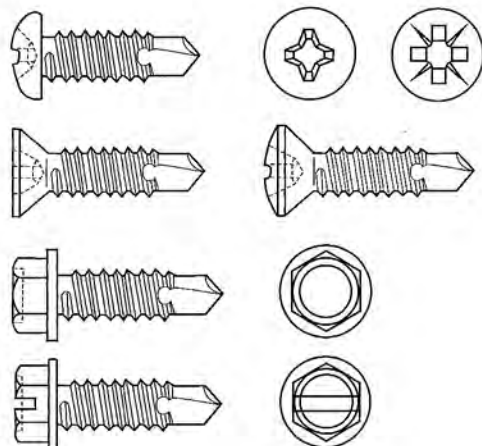

Chipboard Screws

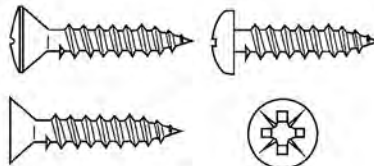

Chipboard Screws With Ribs Under Head

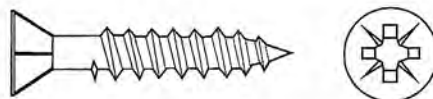

Drywall Screws

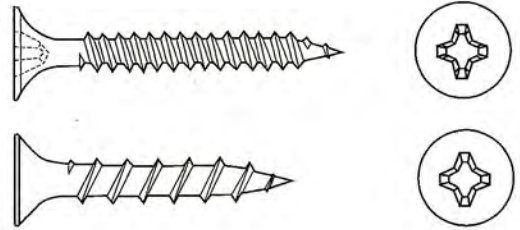

Plain Washers

According to: DIN125,126,433,436,440,
7349,7989,9021
ISO7089,7090,7091,7092,
7093
SAE, USS, FENDER
NFE 25-513
B.S.3410, 4320

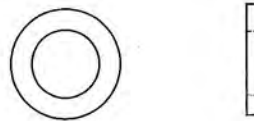

Spring Lock Washers

According to: DIN127
IFIL-9
B.S.

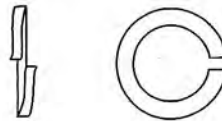

Pins

According to: DIN94
ISO 1234
IFIL-38
B.S.

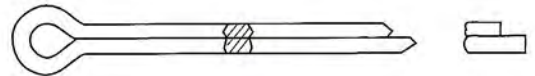

Modified Truss Head Self-drilling Screws



Bugle Head Self-drilling Screws



Bonded Washers with EPDM Washers



Concrete Screws

Type: Flat countersunk head T-30
 Sizes: 7.5x42/52/62/72/82/92/102/112/122
 7.5x132/142/152/162/182/202/212



Concrete Screws

Type: Round head T-25
 Sizes: 7.5x72/92/112/132/182



Torx Drive Chipboard Screws Double countersunk Head

Sizes Available:
 6x60/70/80/90/100/110/120/140/160/180/200/220
 8x60/70/80/90/100/110/120/140/160/180/200/220/
 240/260



Furniture Screws

Type: Hex socket / Philip drive without hole
 Sizes: 5.0x50, 6.3x50, 7.0x40/45/50/60/70



Furniture Screws

Type: Hex socket / Philip drive with hole
 Sizes: 5.0x30/50, 6.3x50, 7.0x50/70



Furniture Screws

Type: Pozidrive with hole, Hi-Lo thread, with flute
 Size: 6.3x50



Nail Screw

Type: Indent Flat Head Pozi Drive, Reduced Shank
 Sizes Available: 4x45/65/85, 5x65/85/105/125



Nail Screw

Type: Flat Head Pozi Drive, without Indent, Reduced Shank
 Sizes Available: 4x45/65/85, 5x65/85/105/125



Nail Screw

Type: Oval Head Posi Drive, Reduced Shank
 Sizes Available: 3.3x33/38/43/55
 3.8x38/45/55/65/85
 4.8x65/85/105/125/145/165
 6.8x105/125/145/165



Nail Screw

Type: Square head
 Size Available: 3/8x3



Nail Screw

Type: Indent Hex Washer Head



Woodscrew, 70mm Thread Length

Type: Hex Head;
 Sizes Available: 7.0x65/85/105/125/145/165



Woodscrew, 70mm Thread Length

Type: Flat Head Torx recess; Flat Head Pozi Drive
 Sizes Available: 7.0x65/85/105/125/145/165



Hanger Bolts

Types: Square Shank



Hanger Bolts

Types: Hex Shank



Hanger Bolts

Types: Hex Shank with Torx Drive



Acoustical Lag Screws

Size Available: 1/4x3, 4, 5



Toggle bolts

Size Available: 1/4x3, 3-1/2, 4

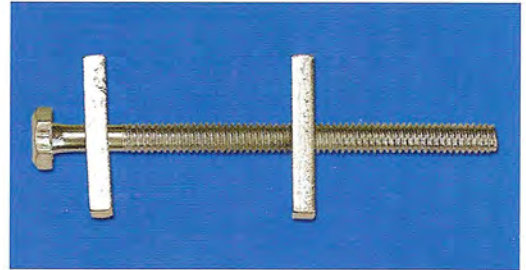

Eye Hook Screws



C Type Hook Screws



Ltype Hook Screws

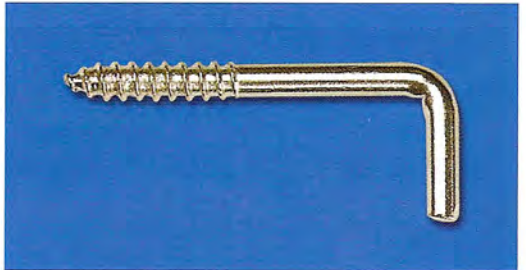

Welded Eye Woodscrew

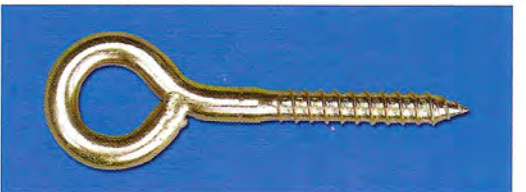

Thumb Screw

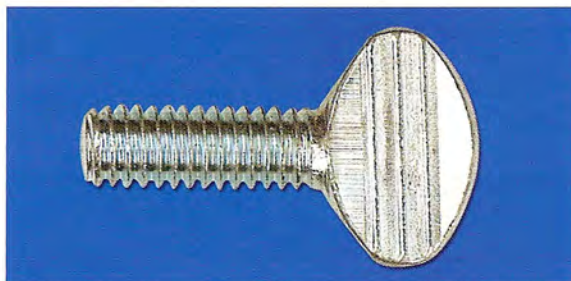

Welding Screw

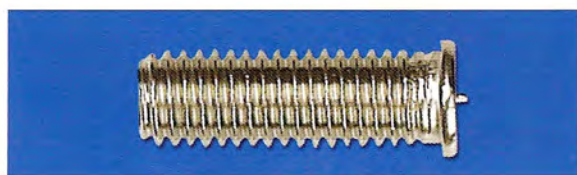

Kep Nut



Adjustable Nut



Retaining Ring for Shaft

According To: DIN471



Retaining Ring for Bore

According To: DIN472



Serrated Lock Washer

According To: DIN6798



Retaining Washer

According To: DIN6797



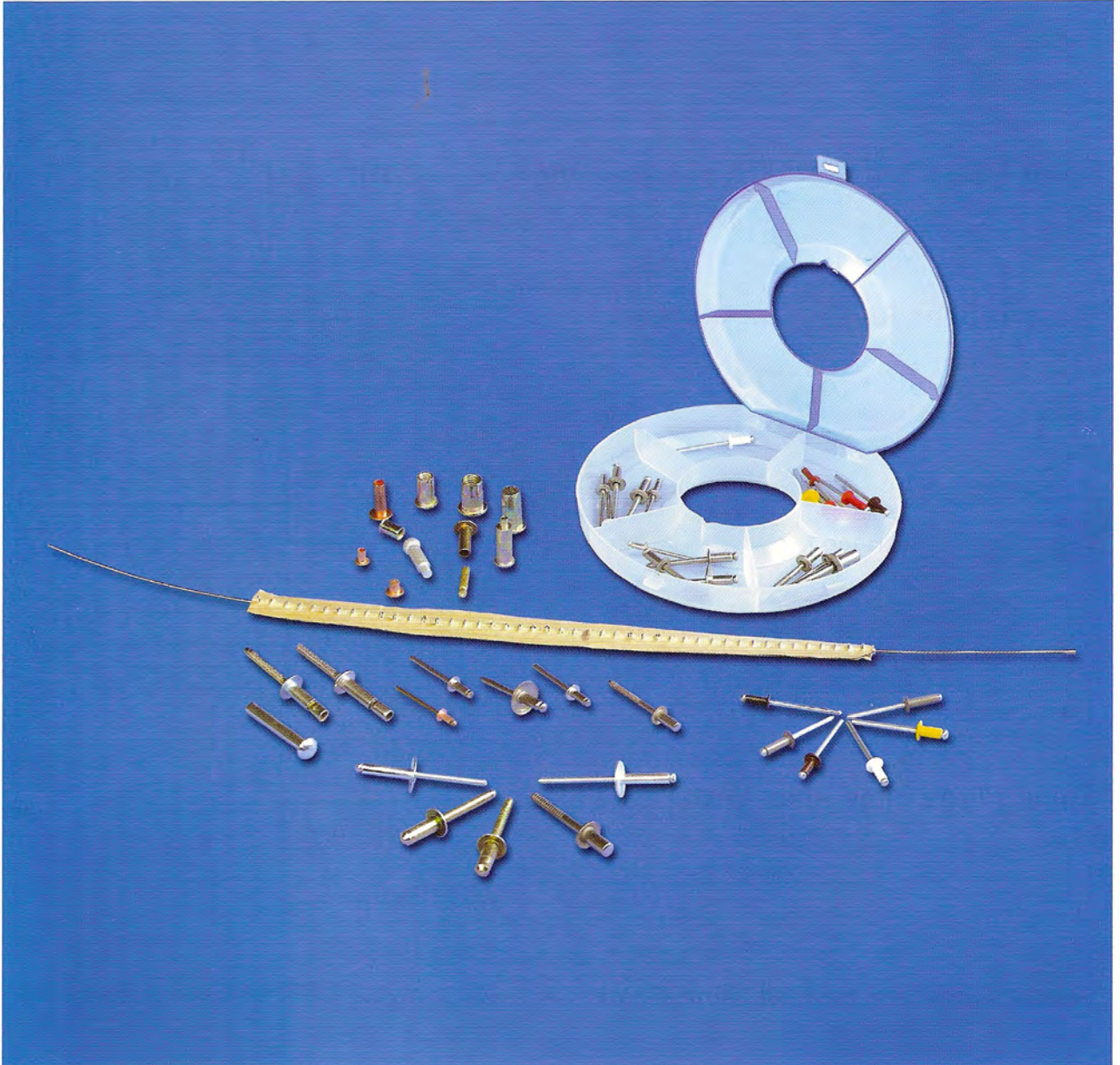

Open Type Blind Rivet

According to: DIN7337, IFI 114
 Types: Dome / Flat Head
 Material: All Aluminum, Aluminum/Steel, All Steel
 Stainless Steel / Steel, All Stainless Steel

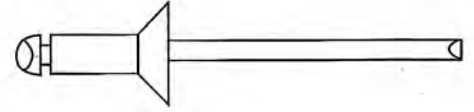
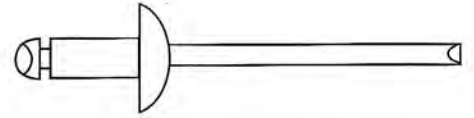

Open Type Blind Rivet With Large Flange

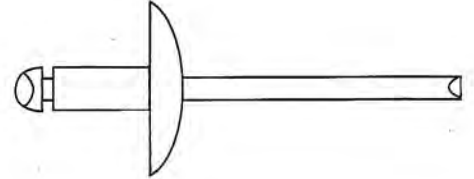

Tubular Blind Rivet

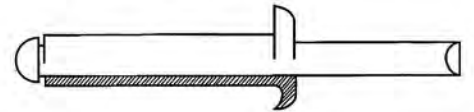

Sealed Type Blind Rivet

Types: Dome / Flat Head

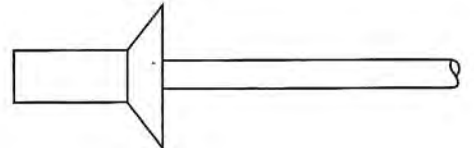
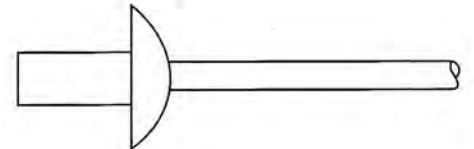

Sealed Type Blind Rivet With Large Flange

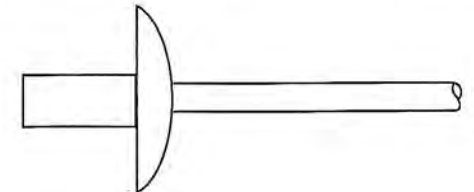

Sealed Type Round End Blind Rivet

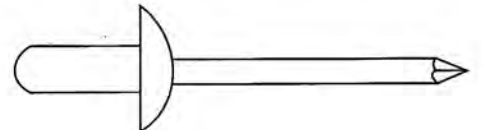

Drive Rivet

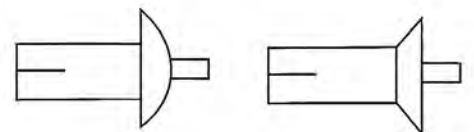

Multigrip Type Blind Rivet

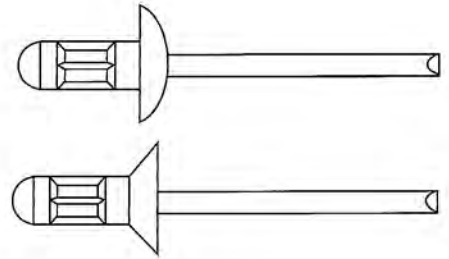

Multigrip Type Blind Rivet With Large Flange

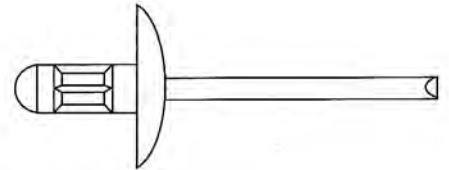

Ring-Grooved Lockbolt

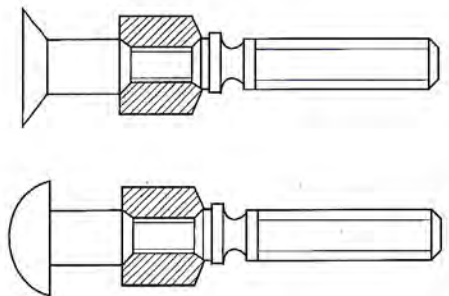

Grooved Type Blind Rivet

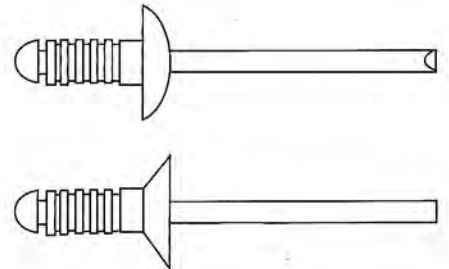

Peel Type Blind Rivet

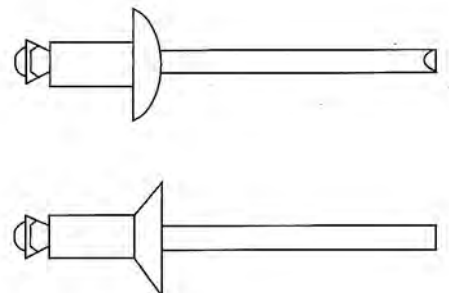

Q-Lok Structural Monobolt



Steel Structural Rivet



Speedy Hollow Rivet



Flat Head Rivet Nut

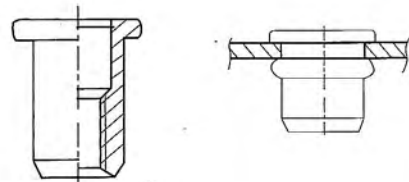

Countersunk Head Rivet Nut

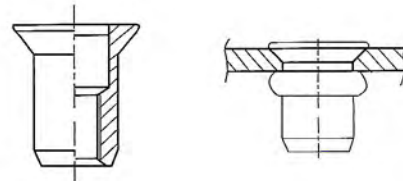

120 Small Countersunk Head Rivet Nut

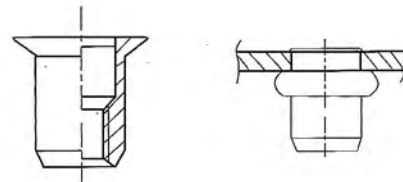

Flat Head Hexagon Rivet Nut



Internally Threaded Rivet Nut

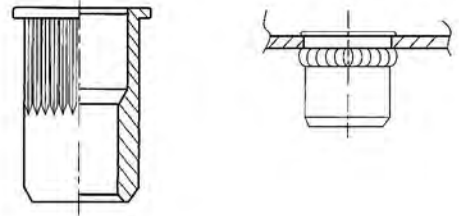

Round Head Rivet

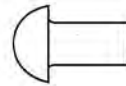

Universal Head Rivet

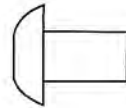

Flat Head Rivet

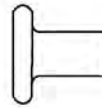

Brazier Head Rivet

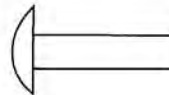

Countersunk Head Rivet

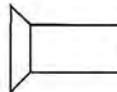

Modified Brazier Head Rivet

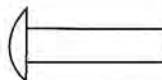

Mushroom Head Rivet

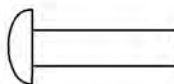



JIMSOAR INTERNATIONAL CORP.
P. O. BOX 96-10, TAIPEI, TAIWAN

TEL.: 886-2-27040238, 886-2-89285975, 886-2-89285976

FAX : 886-2-27040177, 886-2-89284811, 886-2-89284648

E-MAIL: jimsoar@ms13.hinet.net