

**KORTA**

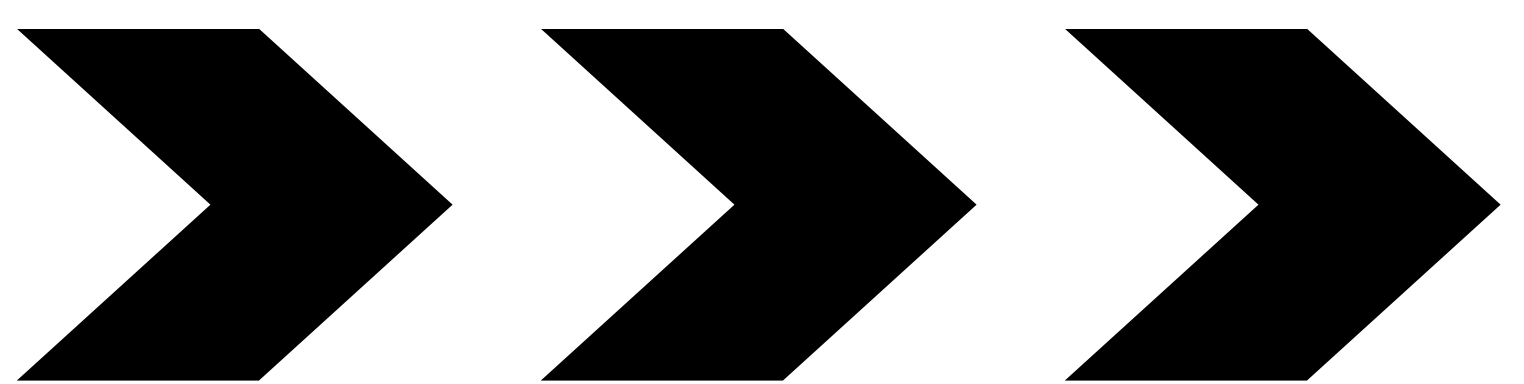



Discover our world of KORTA products.



*"This catalog is about a hedonistic adventure we want to  
take you to."*

*"We only design and create products that we enjoy  
ourselves."*

*Stefano Ladavac*  
Co-founder & CEO

# KORTA

## Inspiration

Istria 7

Natural stone 10

## Who we are

Our philosophy 13

KORTA 19

## The story

History 21

Timeline 23

## Production

Hand-made 29

Premium Technology 31





## Outdoor Relaxation Zones 34

### Aqua Zone 36

Marbella 37

Odino 59

Minimo 73

Kada 85

### Fuoco Zone 94

Gardenzio 95

Kamin 114

### Aria Zone 121

Ponte 122

Dipinto 129

Cara 137

### Designer's hub 145

Specification sheets 150

Codes & Production time 154

Certificates 157

Other materials 161

# ISTRIA

Every now and then, life surprises us by reminding us how beautiful it can be. Rich in colors and excitement, full of joy and delight, very simple, cheerful. Sometimes we experience that moment while grilling with friends, in an evening walk with the person we love, with the smell of morning coffee...

But what if we told you that this is not about the moment at all, but about the place? About the place where you are always at your best. The place that invites you to be spontaneous, daring, and smiling. The place where you feel life as it should be. That place is called Istria.

*The place that inspires us.*







# NATURAL STONE

Drawing inspiration from the materials that surround us and guided by the wisdom and expertise of our ancestors in stone craftsmanship, we embarked on our journey with the Istrian stone at its heart. The very quarries that once provided stone for the construction of Venetian architecture continue to be the source of our materials today.

We always choose materials that share the same characteristics: durability, quality, and beauty. Natural stone has excellent technical and mechanical properties in terms of absorption, freezing, and wear. It is incredibly durable and available in various finishes: polished, sandblasted, burnt or rigatto.

*The inspiration, the material.*





# OUR PHILOSOPHY

Istria, our home and creative haven, still preserves the Italian tradition and heritage of enjoying the lifestyle of outdoor living. This is enabled by its splendid climate, landscape, architecture, and enveloping materials. Our mission is to elevate this heritage by bringing joy to you through our products.

We craft distinctive environments worldwide. Our brand mirrors an elegantly casual lifestyle, offering products that cater to both mind and body for relaxation—a key to our well-being. This equilibrium is achieved through designs that blend comfort, quality, and aesthetic pleasure, always tailored to the unique needs of our clients.

At KORTA our mission has always been to encourage people to sense harmony at home and wherever they are. This approach resonates with both hospitality and wellness projects. Our general desire is that each outdoor living space becomes an experience of the Istrian lifestyle.

Our doors open to stunning exteriors, where products harmonize with nature to establish the desired ambiance. This encapsulates our essence: fashioning environments where life can be embraced, lived, and enriched with hedonistic sensations.

*Timeless Beauty, Carved in Stone. A Piece of Istria, to Call Your Own.*



*Mediterranean roots, passion for life, sun, and beautiful design.*

At KORTA, we transcend mere shape and aesthetics, prioritizing the dynamics of interactions that unfold among humans, objects, and spaces.

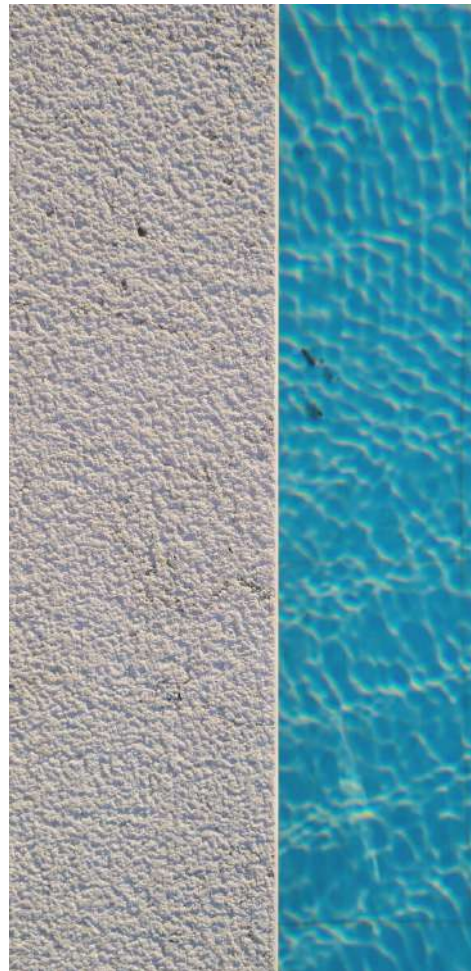

KORTA reveals hidden spaces, experiences, materials, and processes within everyday life.

We challenge ecological values and explore the perceptual and emotional experiences that the distinctive materiality of products can offer.







Our design charrettes, where multiple participants meet to exchange ideas and brainstorm solutions, stand as an example of transparency, and collaboration.

We encourage all our team members to be active participants in the design process, contributing ideas and suggestions for new product development.



We consistently look forward, assessing processes and outcomes that are both dependable and essential for a better future, while also becoming agents of tradition and transformation.



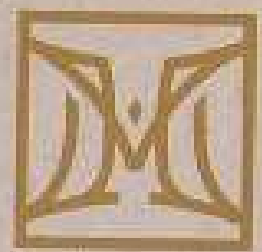

MAIORA

CHAMBER OF COMMERCE



# KORTA

kôrta f <G pl kôrâta/-i>

DEFINITION

a fenced outdoor area, backyard or patio

ETYMOLOGY

ital. corte

KORTA is based on the Mediterranean heritage of joy of outdoor living and aims to spread this lifestyle worldwide. Korta is a place of gathering and celebrating special moments, and a place to relax. We believe that everyone in the world deserves a *korta* filled with products with which they will feel comfortable and connected to.

We want to create a place for you where you can unwind, where you can feel the sun and get a sense of the Istrian lifestyle. Can you imagine the value of an hour of relaxation in your backyard? We make our products for these precious moments. There are unlimited possibilities and finishes for every style in the selection of our products and accessories.



*The freedom to be yourself.*

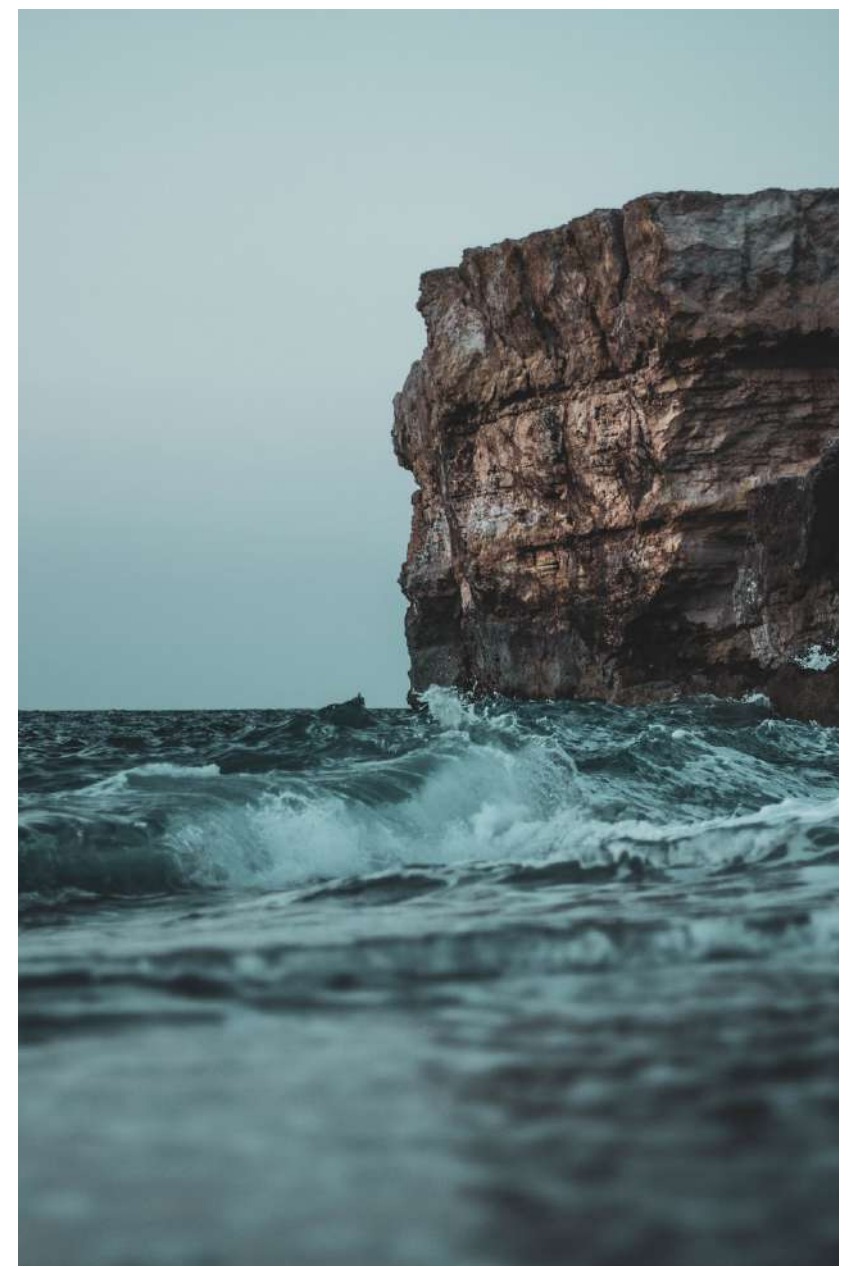
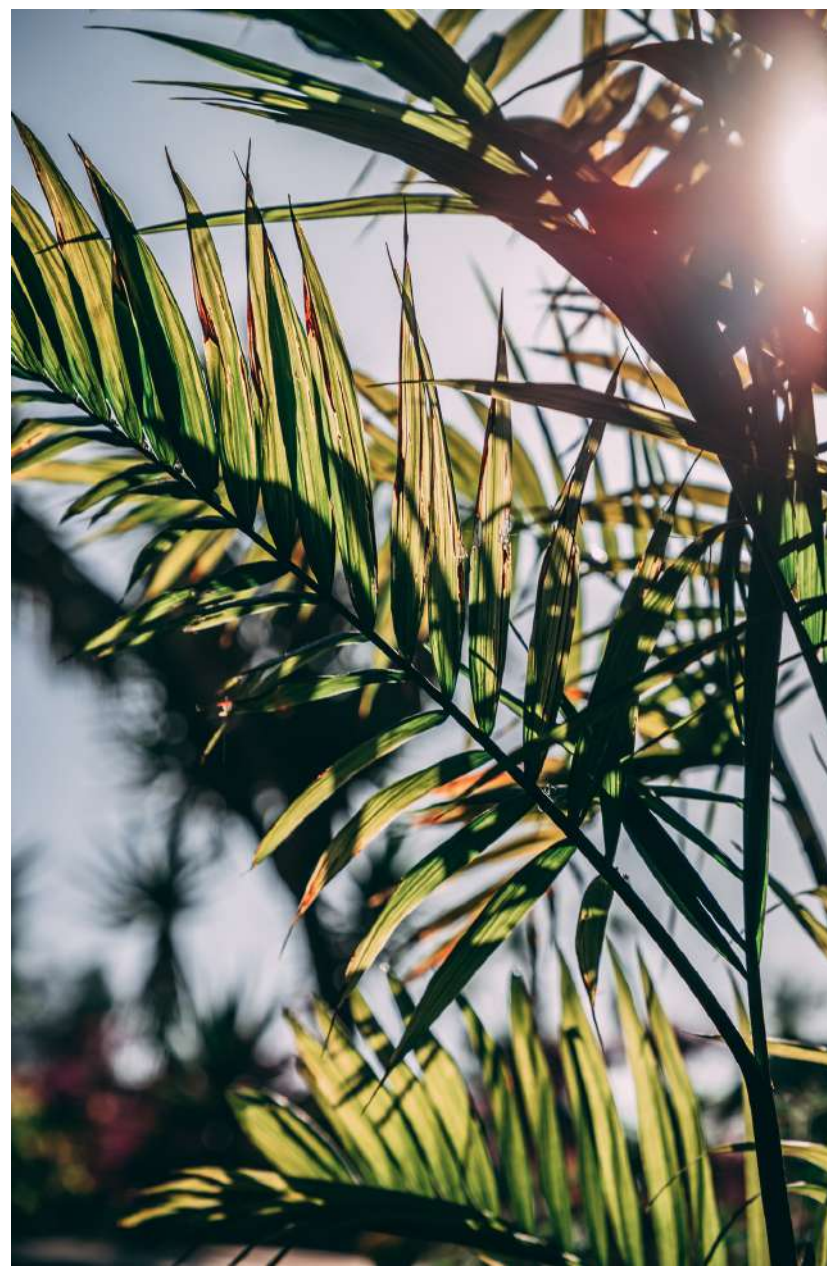
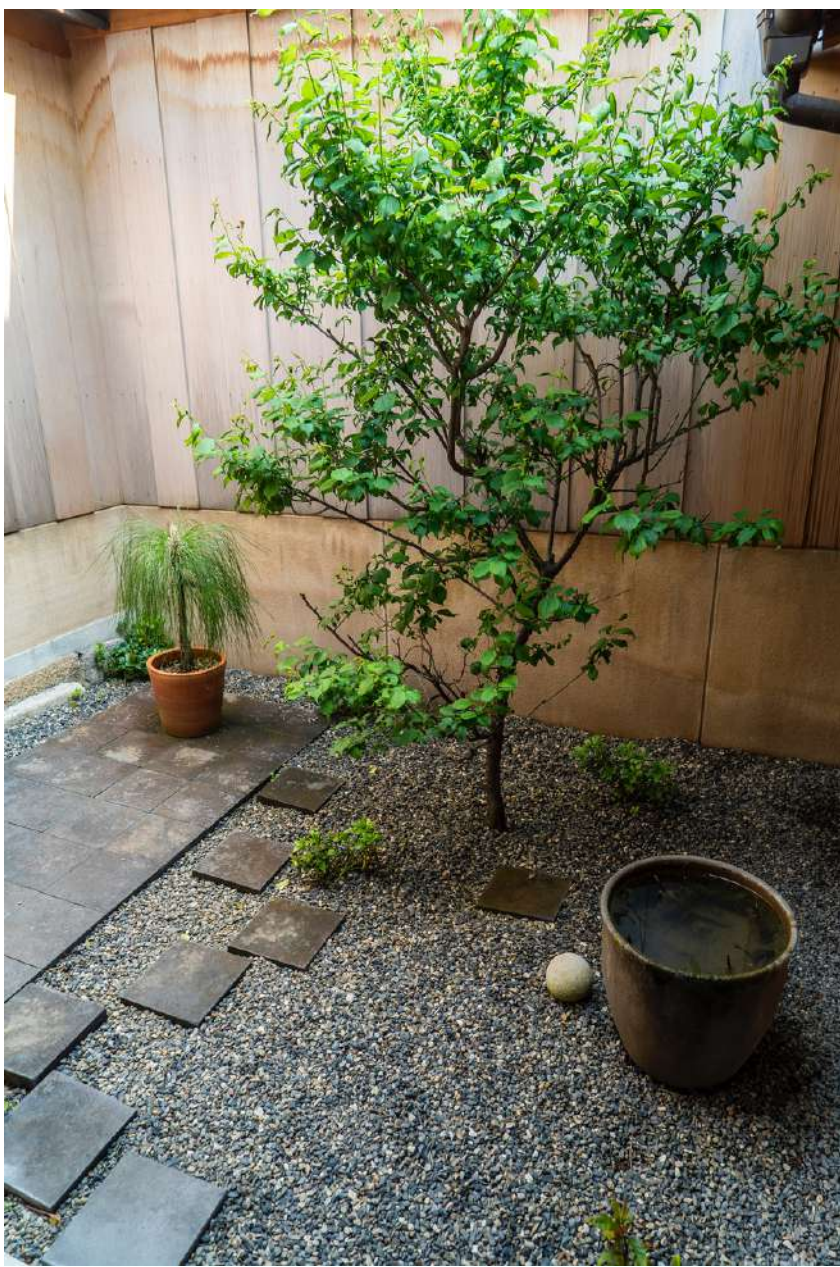

*We established an international reputation for designing meaningful and inspiring products that connect people to a place, elevate the human experience, strengthen the spirit of community, and exceed expectations. Since our beginnings, we prioritized staying true to our values to create a strong sense of a product that resonates with nature, humans, and places on an emotional level.*



# THE STORY



*Legacy.*



Working with stone and similar materials is in the family's blood. Our legacy traces to 1995 when Stefano's grandfather and father started a business of natural stone processing. Their experience has been transferred to him, and he used it to create the first outdoor shower made of stone. His father is still active and now serves as our manufacturing advisor. We believe that it is crucial to have someone with experience on board.

We always deliver products of the very best quality. All our products are carefully engineered, manufactured, and internally tested; ensuring that they abide by our high standards of quality and performance. All of that to deliver the very best solutions to our clients. Most of our products are designed in-house, while Sandro Užila, a designer with whom we share the same values and philosophy, is the creator of particular design collections.

*Heritage.*

1995.

Franko and Sandro Ladavac opened their small craft for the production and stone processing.

2018.

The first shower was sold, and the customer was Dejan Lovren - a Croatian national football team player.

---

2017.

Stefano Ladavac founded Infinity Luxury d.o.o. and made the first outdoor shower made of stone.



2019.

Miloš Jarić joined the company as an investor. We completed the first project co-financed by EU funds to the amount of € 200,000.

2022.

We created KORTA, our new brand which brings it all together: our place, our legacy, our material, and who we are.

---

2021.

Marko & Nikola Jurman became partners and invested in the company to develop a world-known brand.

2023.

KORTA's brand can be found across 35 countries in the world: USA, Middle East and Europe

*What truly motivates me in my  
work is witnessing the  
acceptance of my ideas, their  
feasibility in implementation,  
and their tangible contributions  
to concrete results.*

*Jasmina Čerina*

*Business Development  
Manager for Spain & Portugal*





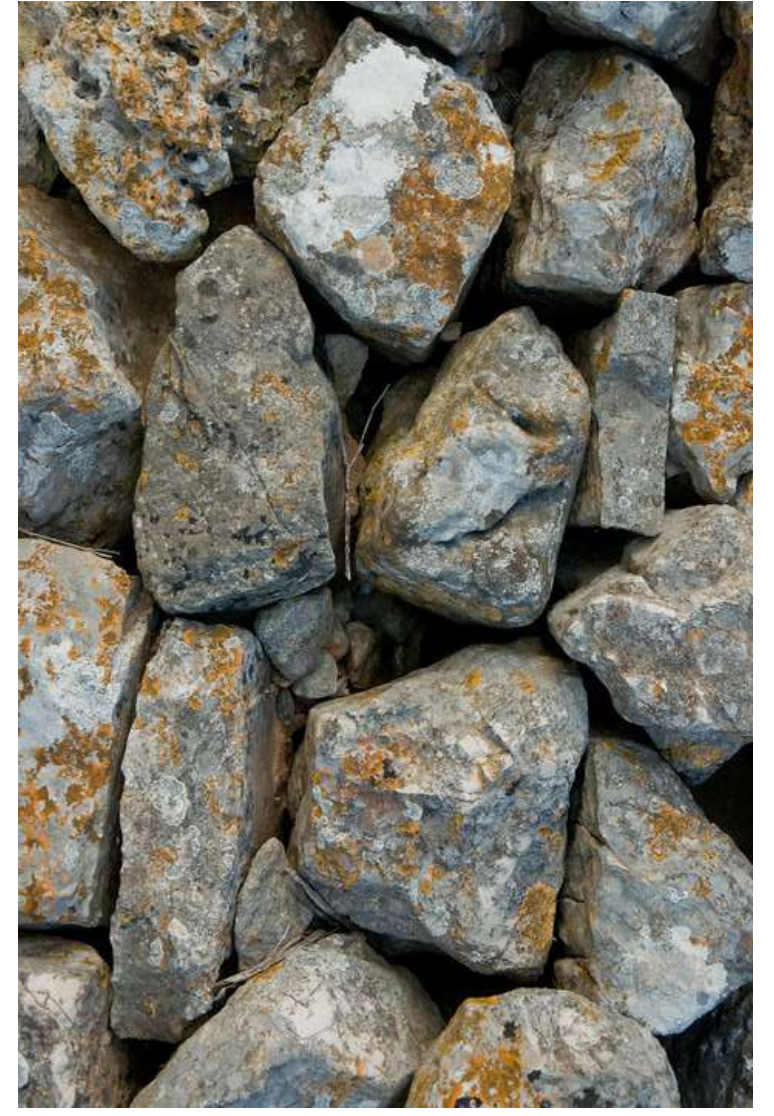

# HAND-MADE

Our strength lies in the ability to delight others with our uniqueness and the courage in engaging in hands-on craftsmanship, all while remaining open to new, better ways that enhance our work. We enjoy playing with robust materials, elegant proportions, and unparalleled comfort, drawing inspiration from nature's finest and purest elements and carefully detailing harmonious shapes.

Manual processing allows us to invest ourselves in every intricately crafted piece. Thanks to the final hand-finish, each product delivered to the client emerges as a personalized, one-of-a-kind creation.





Location: KORTA production facility  
Product: ODINO outdoor shower

Material: Marazzi Porcelain slabs

*Touch of passion.*

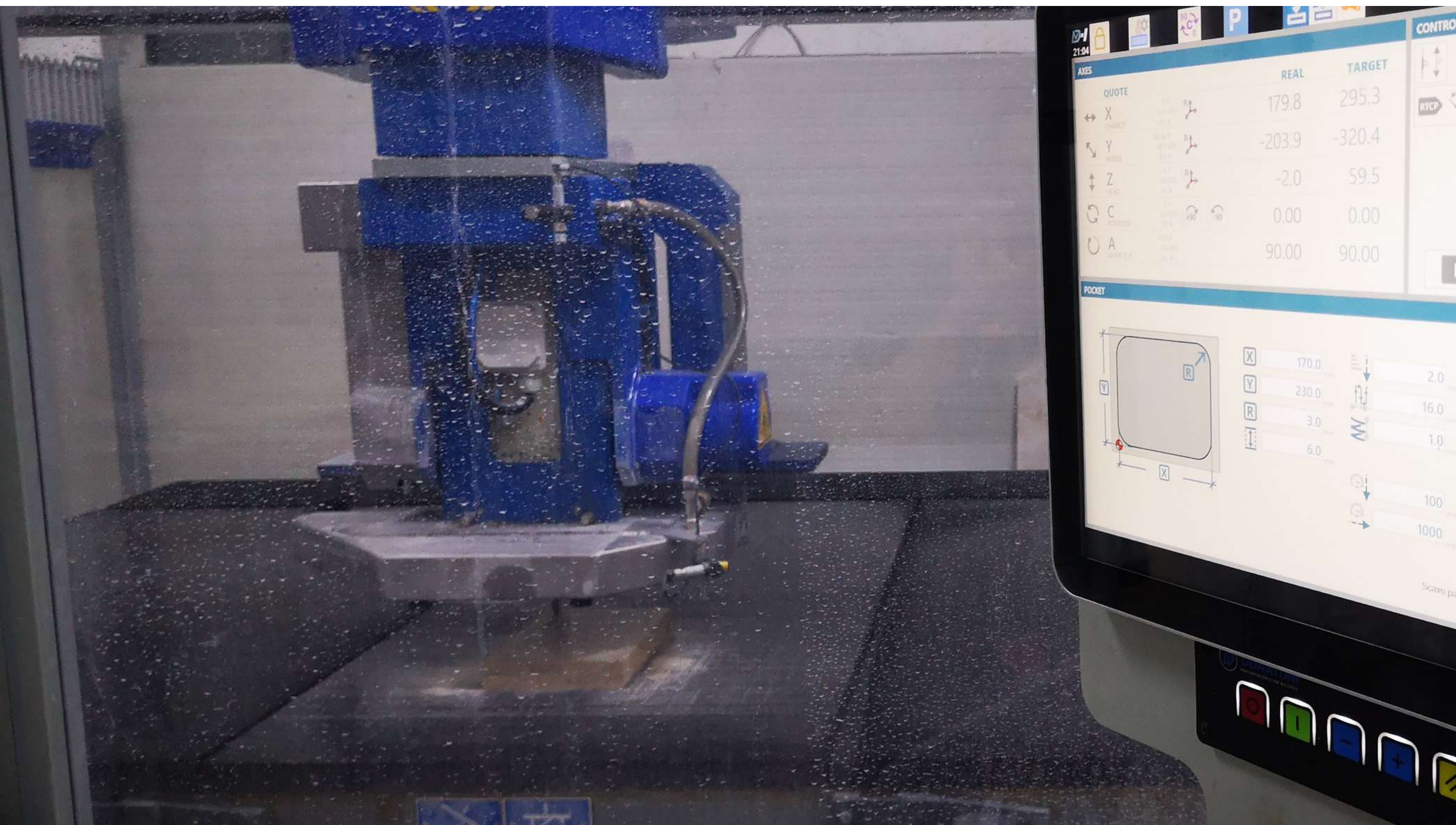

Manufacturer: Donatoni Macchine  
Perfect for: marble and porcelain cutting

Machine: CNC 625 JET

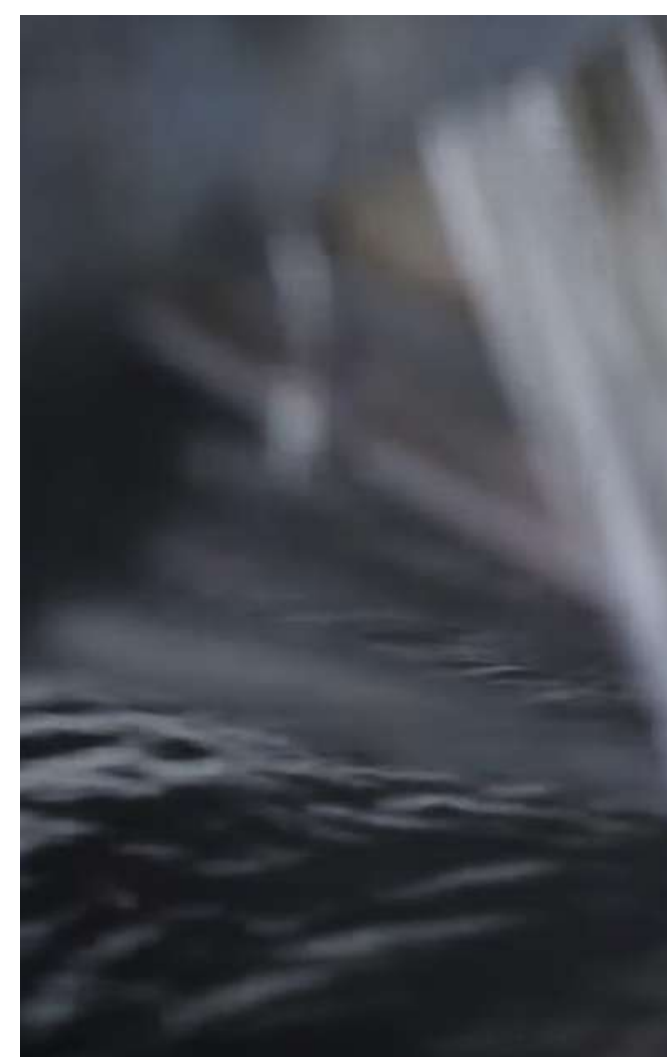





# PREMIUM TECHNOLOGY



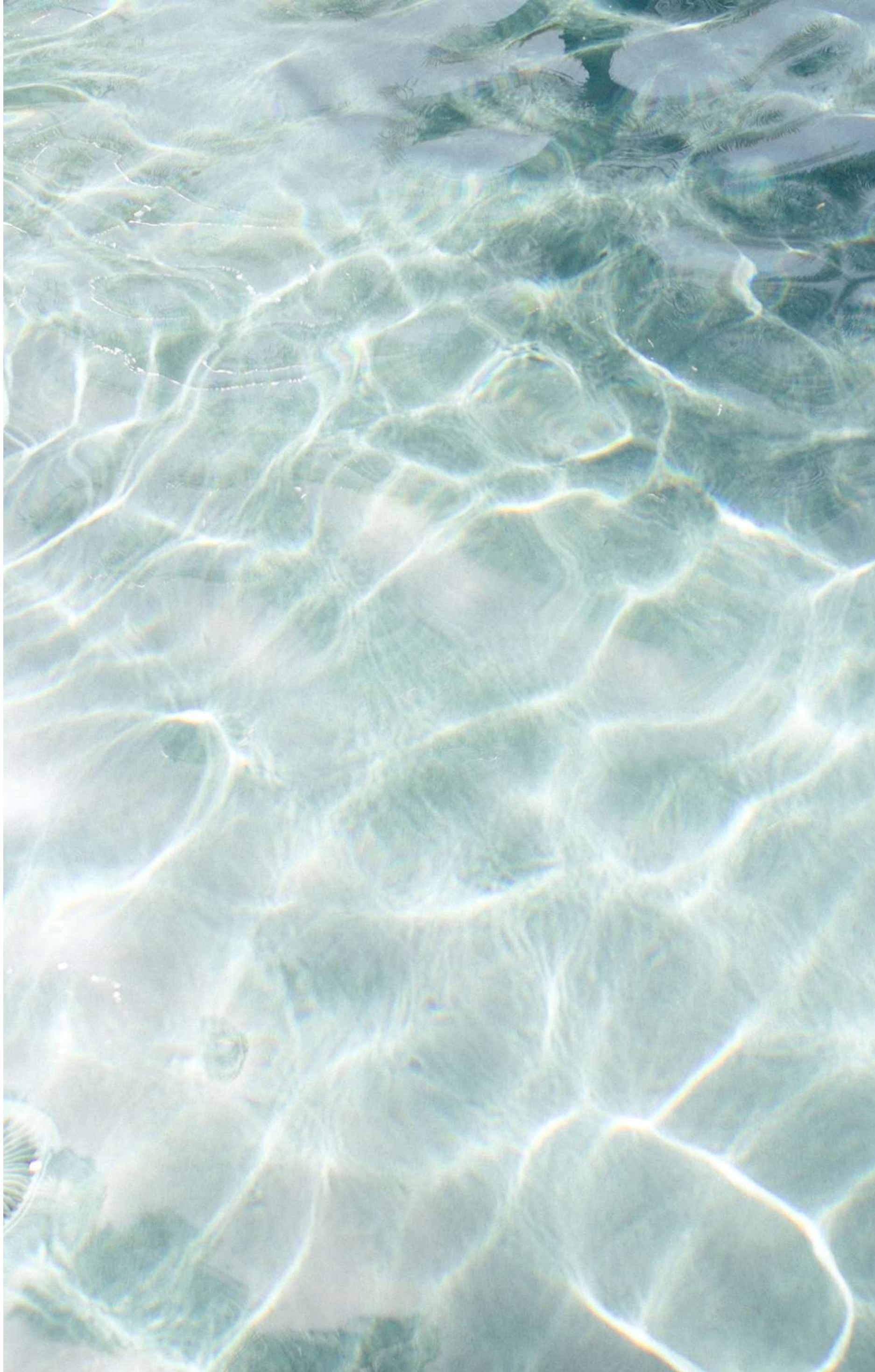

*Resonate with nature, humans, and places.*

A serene outdoor relaxation zone featuring a large infinity pool that perfectly reflects the sky and surrounding landscape. In the background, a minimalist stone frame stands on a sandy area, framing a view of a large tree and the horizon. The sky is a soft, pale blue with wispy clouds. The overall atmosphere is peaceful and modern.

# OUTDOOR RELAXATION ZONES



At KORTA, we believe that outdoor spaces should be designed to provide a sense of tranquility, comfort, and rejuvenation. With this philosophy in mind, we have developed an innovative concept of Outdoor Relaxation Zones, which are centered around three essential elements of life: water, fire, and air. The Aqua, Fuoco, and Aria zones are designed to transform any outdoor space into a haven of relaxation.

Whether you want to unwind by the tranquil sound of water, gather around a cozy fire pit with loved ones, or take in the fresh outdoor air, our Relaxation Zones offer the perfect solution. With KORTA's Outdoor Relaxation Zones, you can create a space that perfectly suits your relaxation needs, and allows you to fully enjoy your outdoor living experience.

# AQUA ZONE

The Aqua Zone provides a revitalizing retreat from everyday life. Tailored to harness the revitalizing effects of water, this area presents an assortment of amenities that enable you to relish the calming advantages of indoor surroundings whilst enjoying the serene allure of the outdoor environment. Whether you seek rest from the sun or merely desire a haven to decompress and de-stress, the Aqua Zone serves as an ideal sanctuary.



This Zone presents a serene haven for those seeking solace from the stresses of daily life. Built to harness the revitalizing properties of water, this Zone showcases an array of products that let you revel in the calming advantages of interior spaces whilst immersing yourself in the natural beauty of the outdoors. Whether you crave relief from the bustle of city life or yearn for a quiet place to gather your thoughts and relax, the Aqua Zone is the perfect destination.

MARBELLA





Marbella outdoor shower boasts clean lines and a minimalist design, making it a timeless and elegant addition to any outdoor space. It's perfect for use by the pool or in outdoor bathrooms.

Crafted by hand using natural Kanfanar stone or ceramics by Marazzi, Marbella shower serves as a symbolic tribute to nature. It seamlessly blends in with the landscape, becoming an integral part of it, and ages gracefully along with nature's transformative journey.

The porcelain slabs we utilize are sourced from Marazzi, an esteemed Italian manufacturer with whom we have forged a robust friendship and partnership. Marazzi's origins trace back to 1935 in Sassuolo, and it presently embodies the pinnacle of Italian style and manufacturing excellence in the realm of interior decoration and design.

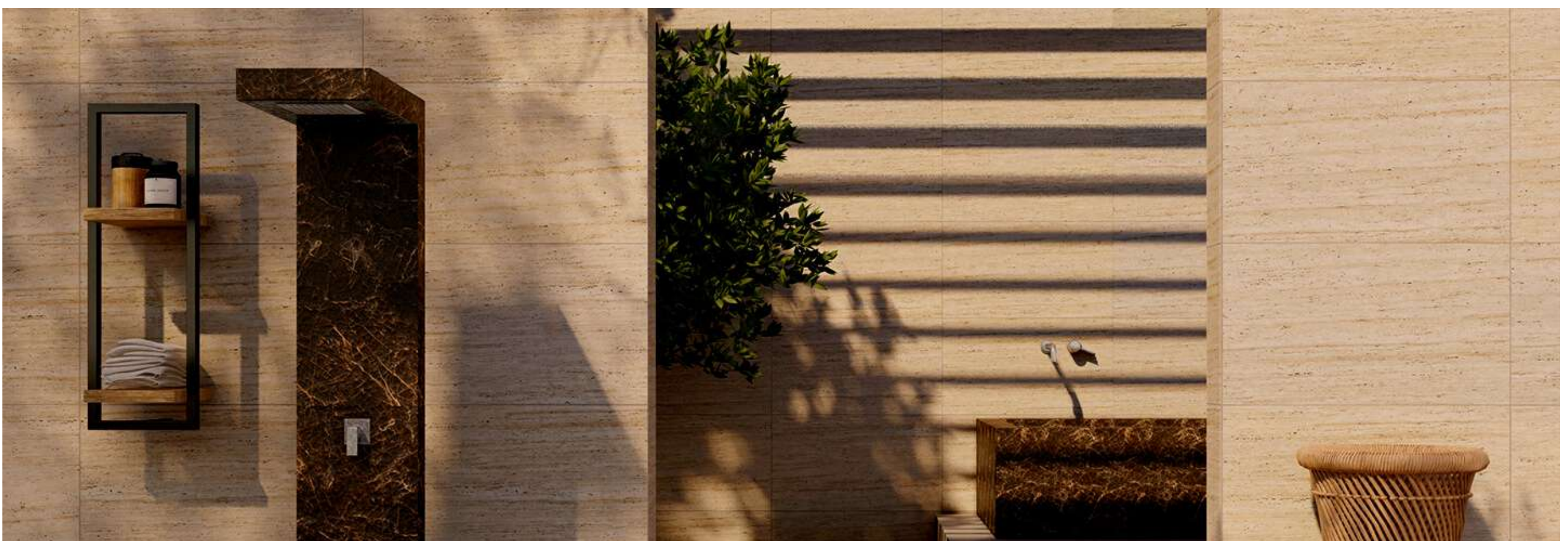

Product: Outdoor shower *Marbella*  
Material: Marazzi - Saint Laurent SAT  
Code: MARCSLS





Product: Custom made Outdoor shower *Marbella*  
Material: Granite Assoluto Nero - brushed  
Code: MARGANBLEL

# STONE FINISHES



*Polished / Sandblasted+brushed / Flamed+brushed*

## DECORS BY MARAZZI



*Statuario / Smoke / Sahara Noir*



*Golden White / Saint Laurent / Grigio Carico*

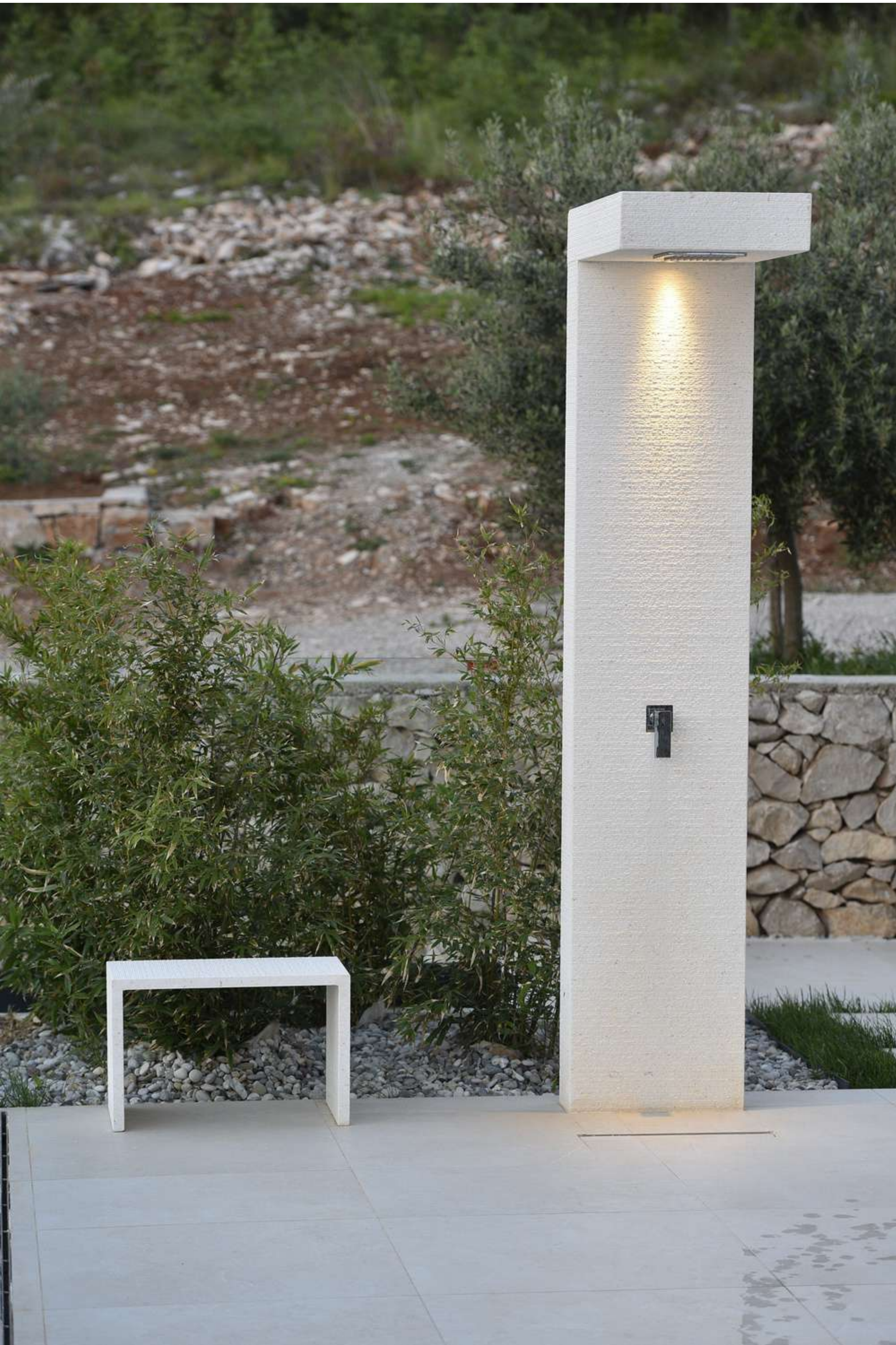

Product: Coffee table *Ponte* / Outdoor shower *Marbella*  
Material: Kanfanar - rigato  
Code: CTPXLR / MARSRL

# PRODUCT DIMENSIONS

## STONE

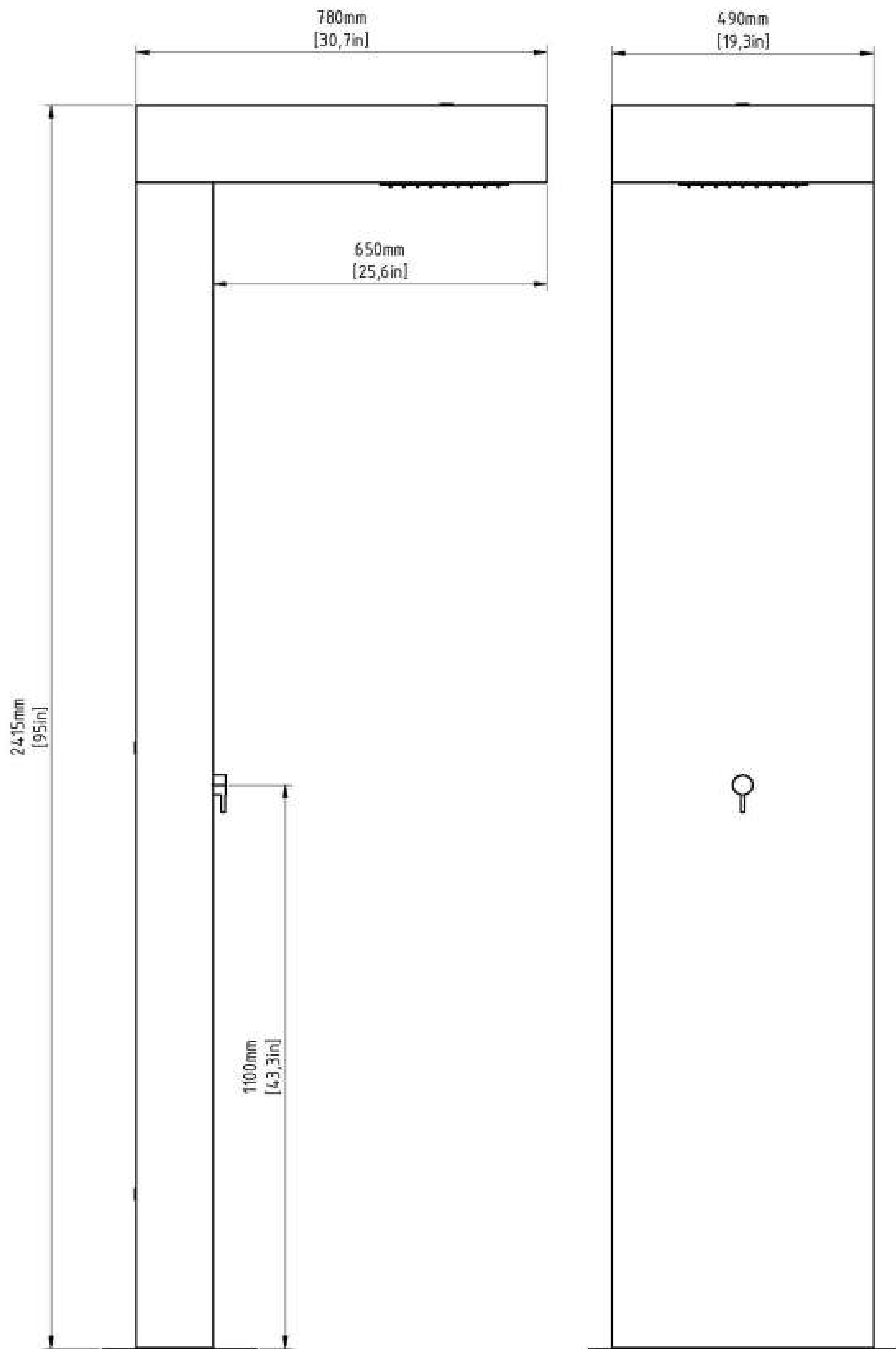

255kg / 562lbs





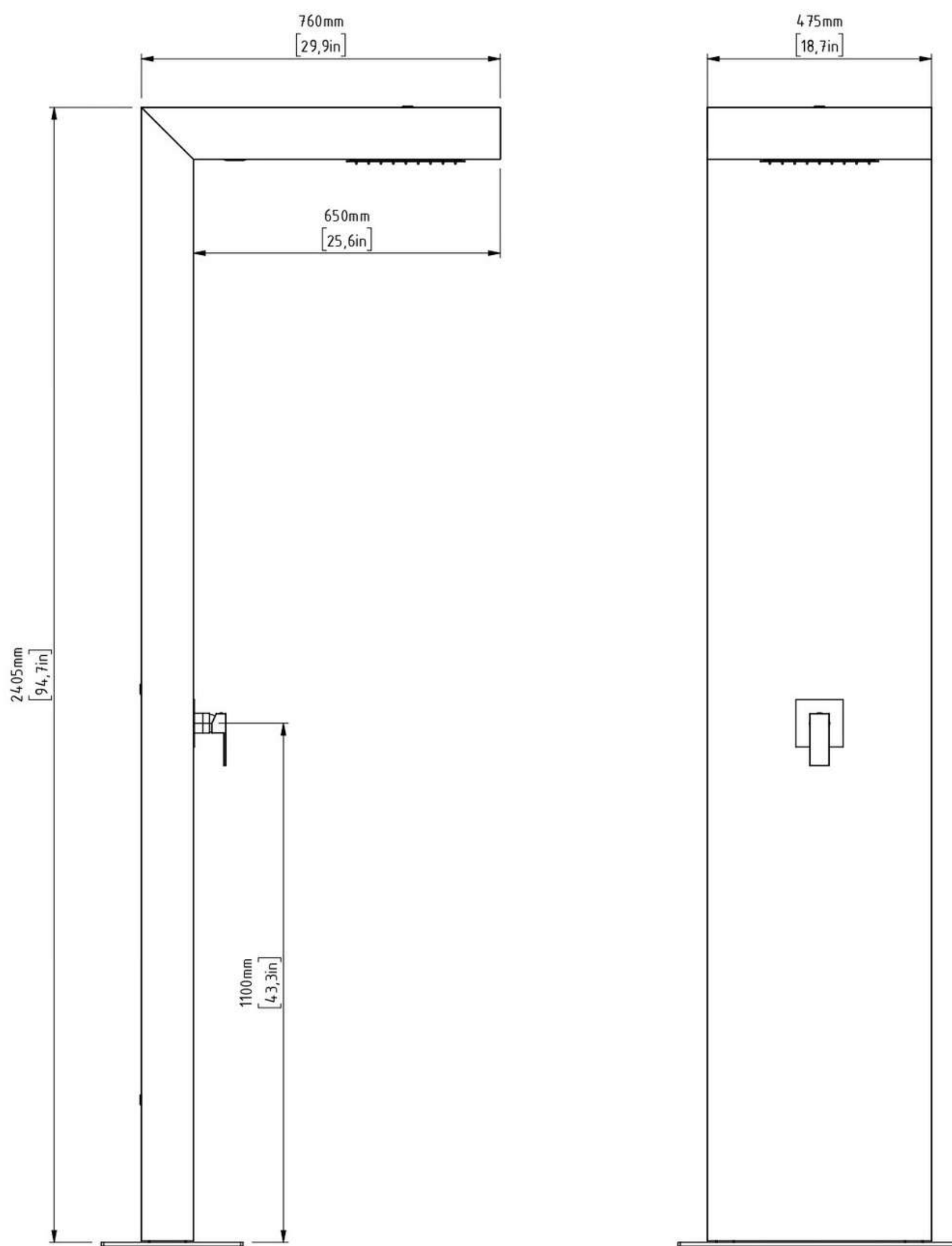

# PRODUCT DIMENSIONS

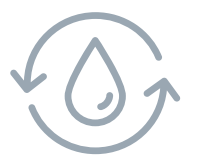
## CERAMICS









## SHOWER SYSTEM STANDARD FEATURES



-  4 flexible stainless steel knitted hose 1/2"
-  2-way mixing mechanism with faucet and handle designed by Mariner Rubinetterie
-  Ecotech shower head by Mariner Rubinetterie which enables water savings of up to 50 %
-  The informed Nattura S shower catalyst with beneficial well-being effects
-  Protective shower cover
-  Protective base plate cover
-  Water flow 4-8 L / min

## SHOWER SYSTEM ADDITIONAL FEATURES

-  Ambient LED lighting designed by Filix
-  Anti-frost heating cable
-  Logo engraving
-  Motion sensor
-  Additional shower handle
-  Hot water tank (*exclusively available in dark decors*)





Product: Outdoor shower *Marbella*  
Material: Kanfanar - polished  
Code: MARSPL



Product: Outdoor shower *Marbella*  
Material: Kanfanar - sandblasted+brushed  
Code: MARSSBLE





Product: Outdoor shower *Marbella*

Material: Kanfanar - polished

Code: MARSPLLE



Product: Outdoor shower *Marbella*

Material: Kanfanar - rigato

Code: MARSRL



Product: Custom made Outdoor shower *Marbella*  
Material: Plano - polished  
Code: MARPPLLE





Product: Custom made Outdoor shower *Marbella*

Material: Avorio - polished

Code: MARAPLE









Product: Custom made Outdoor shower *Marbella*  
Material: Plano - polished  
Code: MARPPLLE

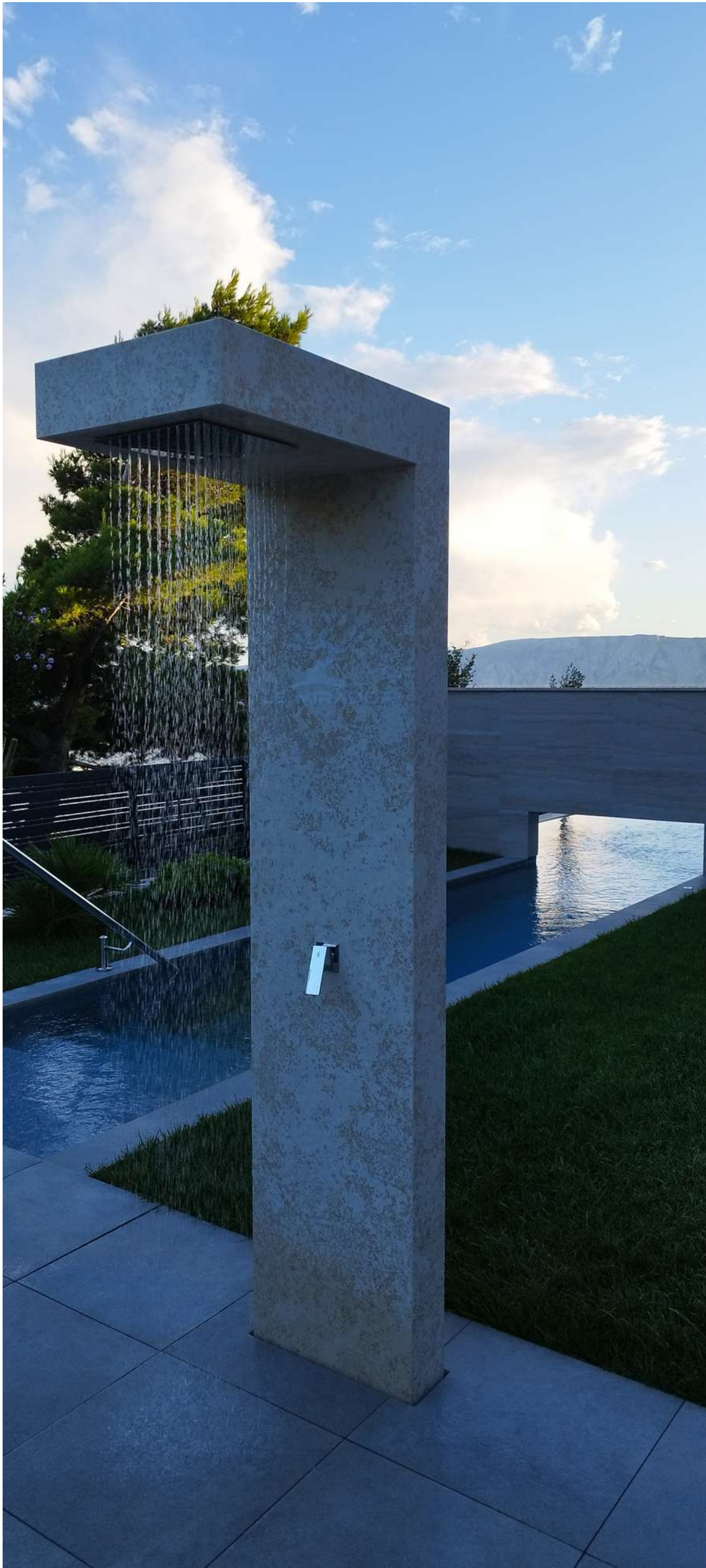

Product: Outdoor shower *Marbella*  
Material: Kanfanar - polished  
Code: MARSP

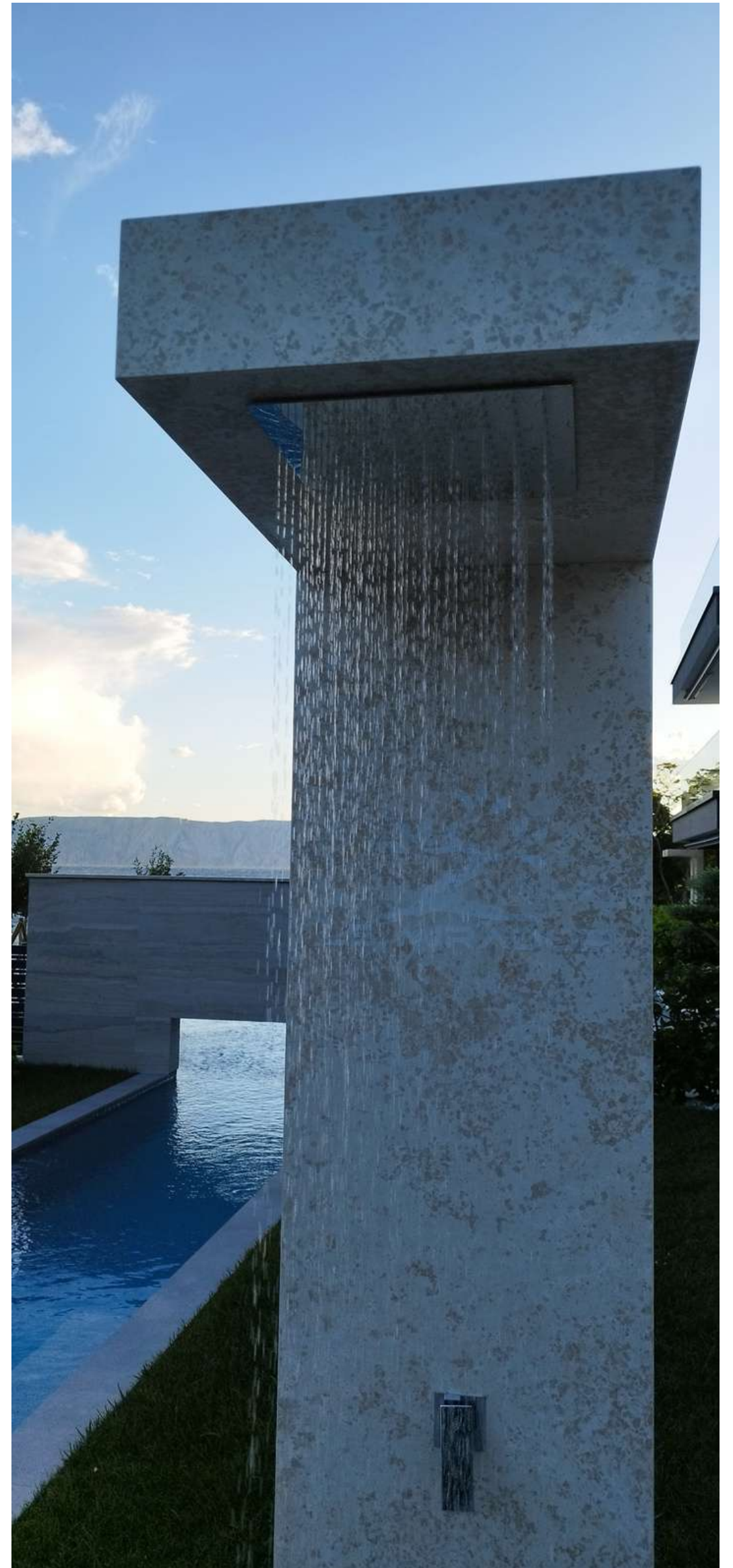



ODINO



Product: Outdoor shower *Odino*  
Material: Marazzi Golden White LUX  
Code: ODCGWL

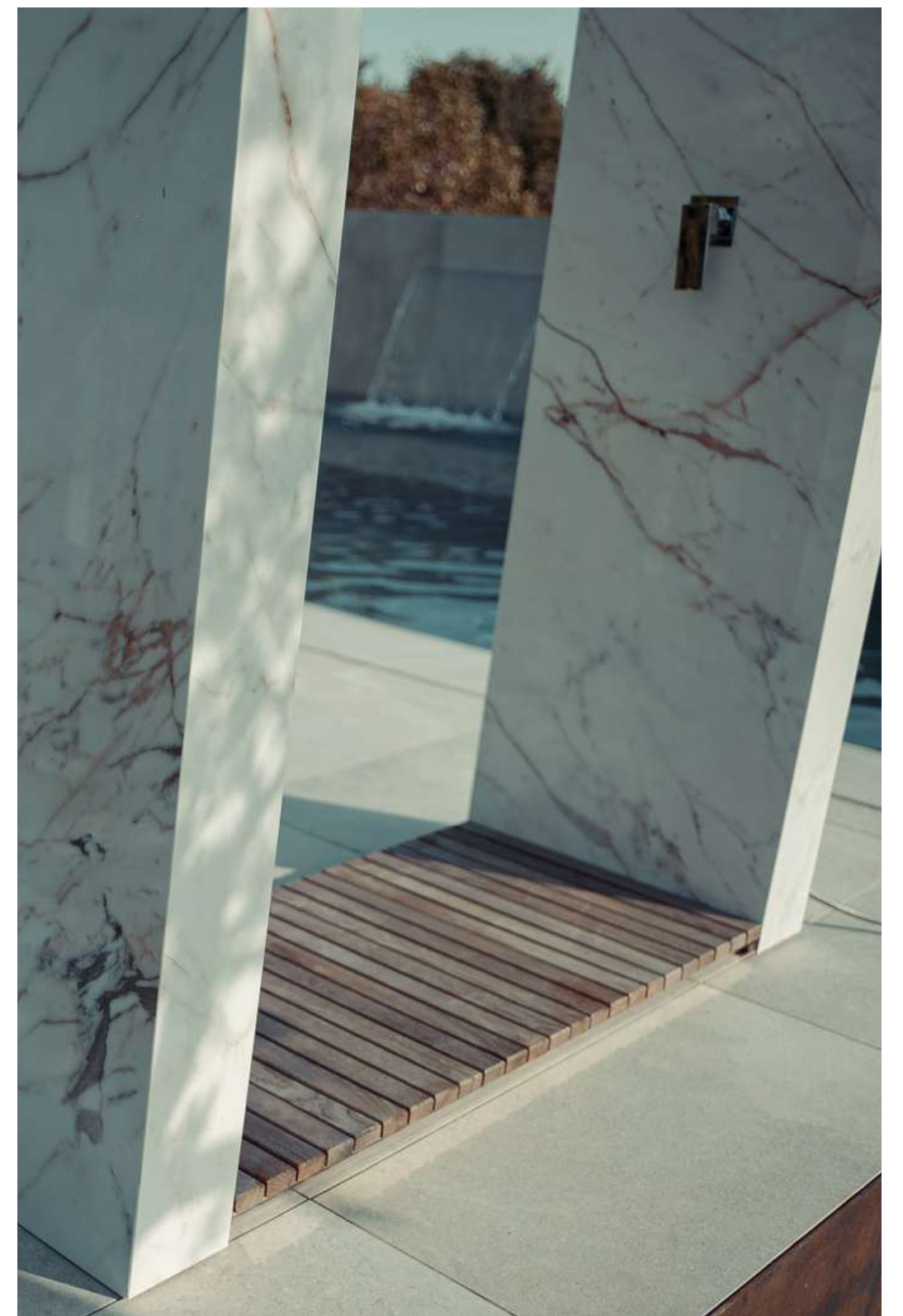

Product: Floor decking  
Material: Thermal Ash  
Code: FDTA







A true embodiment of elegance and contemporary design, Odino stands as the flagship of the esteemed KORTA collections. With its remarkable simplicity and clean lines, this outdoor shower exudes an air of timeless beauty that effortlessly captures attention. The Odino Outdoor Shower is a stunning amalgamation of monumentality and grace, resulting in a truly mesmerizing piece. Its sleek and streamlined structure commands a strong presence, while its refined aesthetic offers a touch of refinement to any outdoor space.

Beyond its striking appearance, Odino also boasts exceptional functionality. Designed to provide a revitalizing shower experience, it delivers a cascade of water with precision and grace. In addition to its functional excellence, Odino possesses an inherent photogenic quality. Every angle and detail has been meticulously crafted to ensure breathtaking visuals, making it a remarkable focal point for any outdoor setting. Capture the essence of contemporary style and create picture-perfect moments with Odino's captivating allure.



# STONE FINISHES



*Polished / Sandblasted+brushed / Flamed+brushed*

## DECORS BY MARAZZI



*Statuario / Smoke / Sahara Noir*



*Golden White / Saint Laurent / Grigio Carico*

# PRODUCT DIMENSIONS

STONE

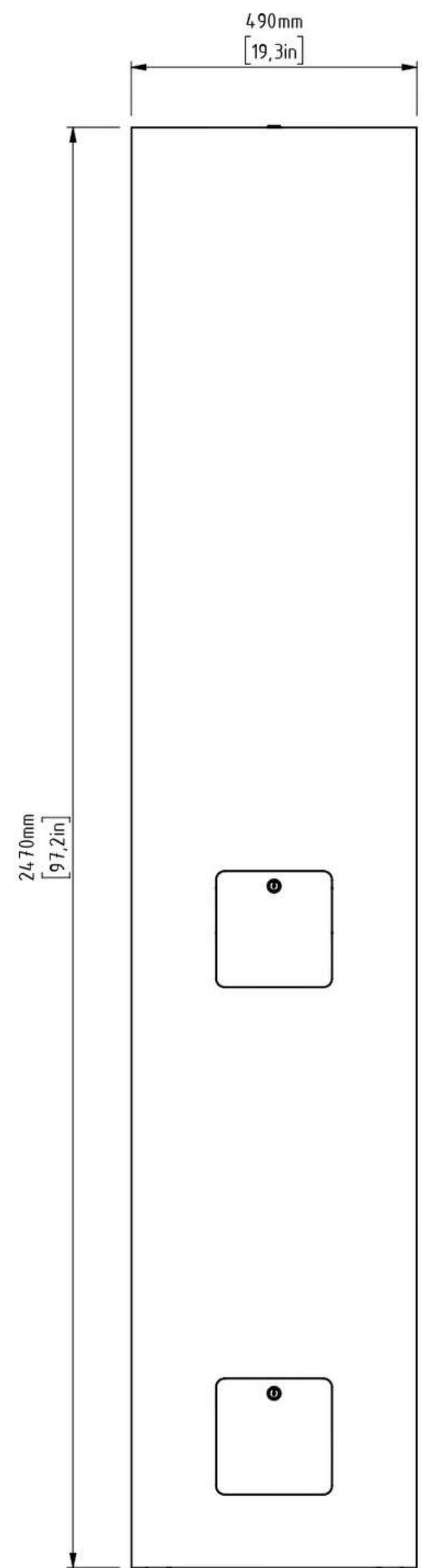
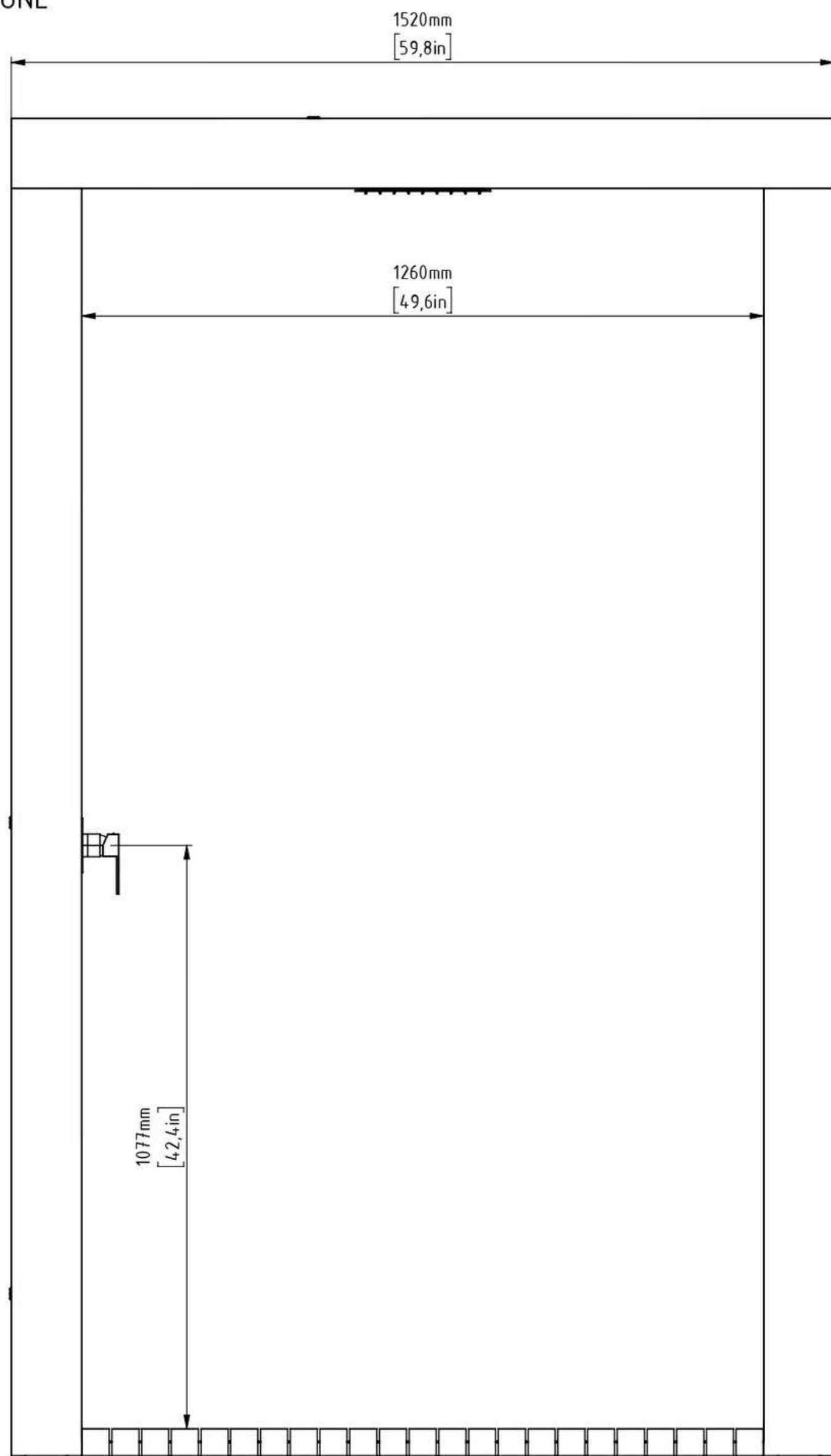





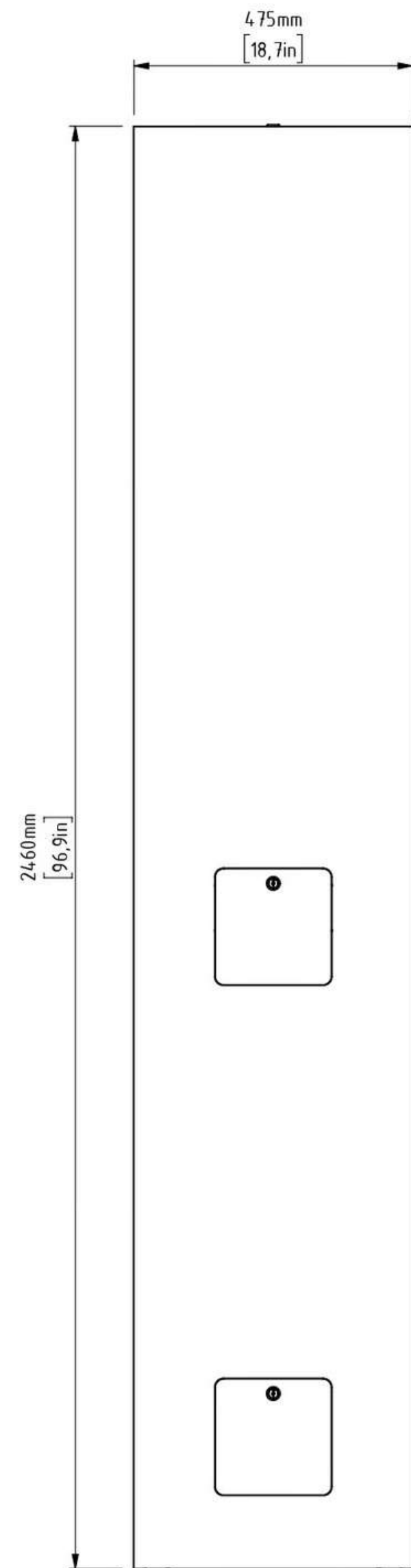
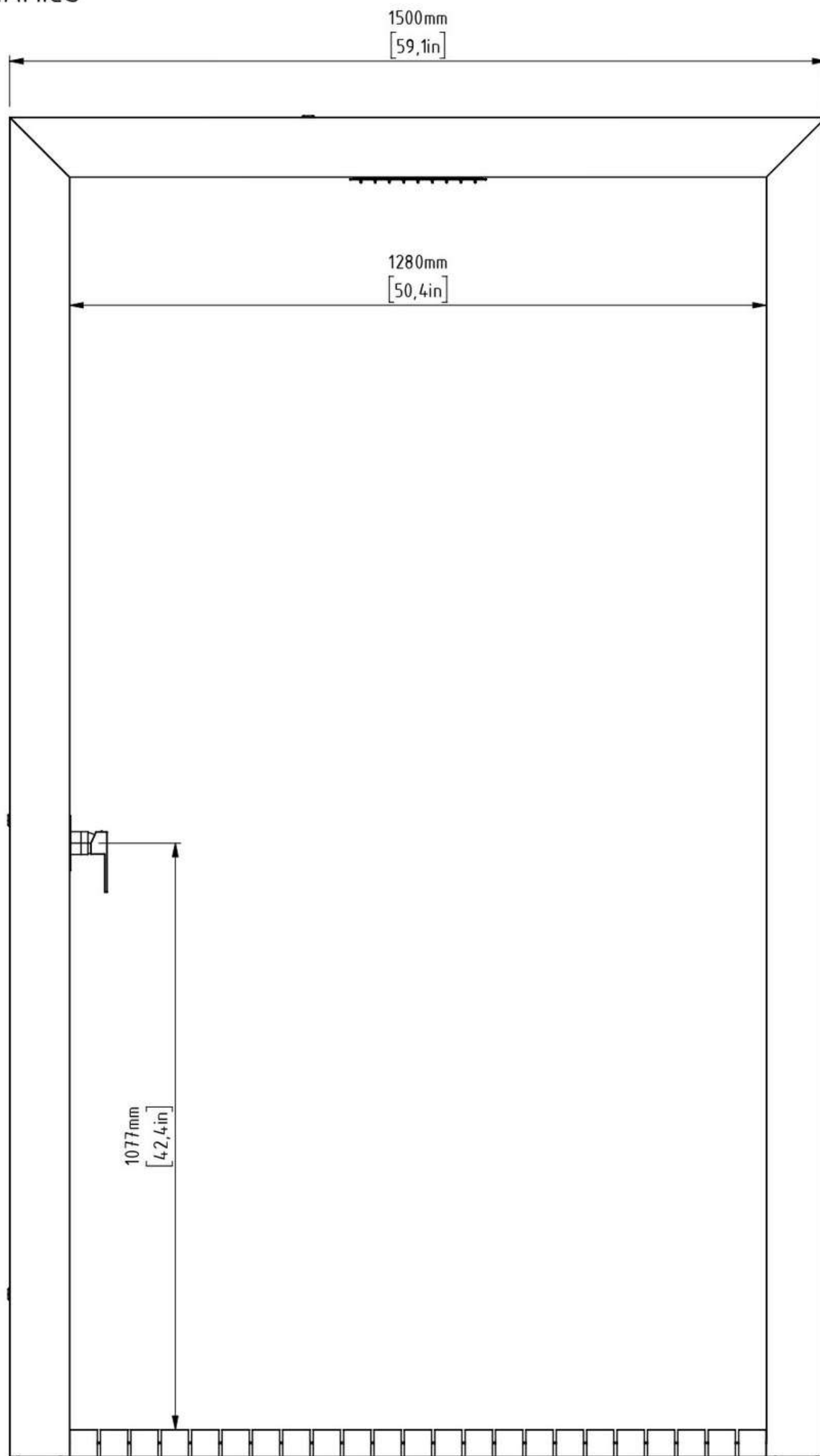

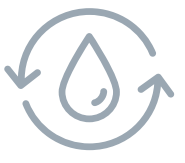

# PRODUCT DIMENSIONS

CERAMICS









## SHOWER SYSTEM STANDARD FEATURES



-  4 flexible stainless steel knitted hose ½”
-  2-way mixing mechanism with faucet and handle designed by Mariner Rubinetterie
-  Ecotech shower head by Mariner Rubinetterie which enables water savings of up to 50 %
-  The informed Nattura S shower catalyst with beneficial well-being effects
-  Protective shower cover
-  Protective base plate cover
-  Water flow 4-8 L / min

## SHOWER SYSTEM ADDITIONAL FEATURES

-  Ambient LED lighting designed by Filix
-  Anti-frost heating cable
-  Logo engraving
-  Motion sensor
-  Additional shower handle
-  Hot water tank (*exclusively available in dark decors*)



Product: Outdoor shower *Odino*  
Material: Kanfanar - polished  
Code: ODSP



Product: Outdoor shower *Odino*

Material: Kanfanar - polished

Code: ODSP



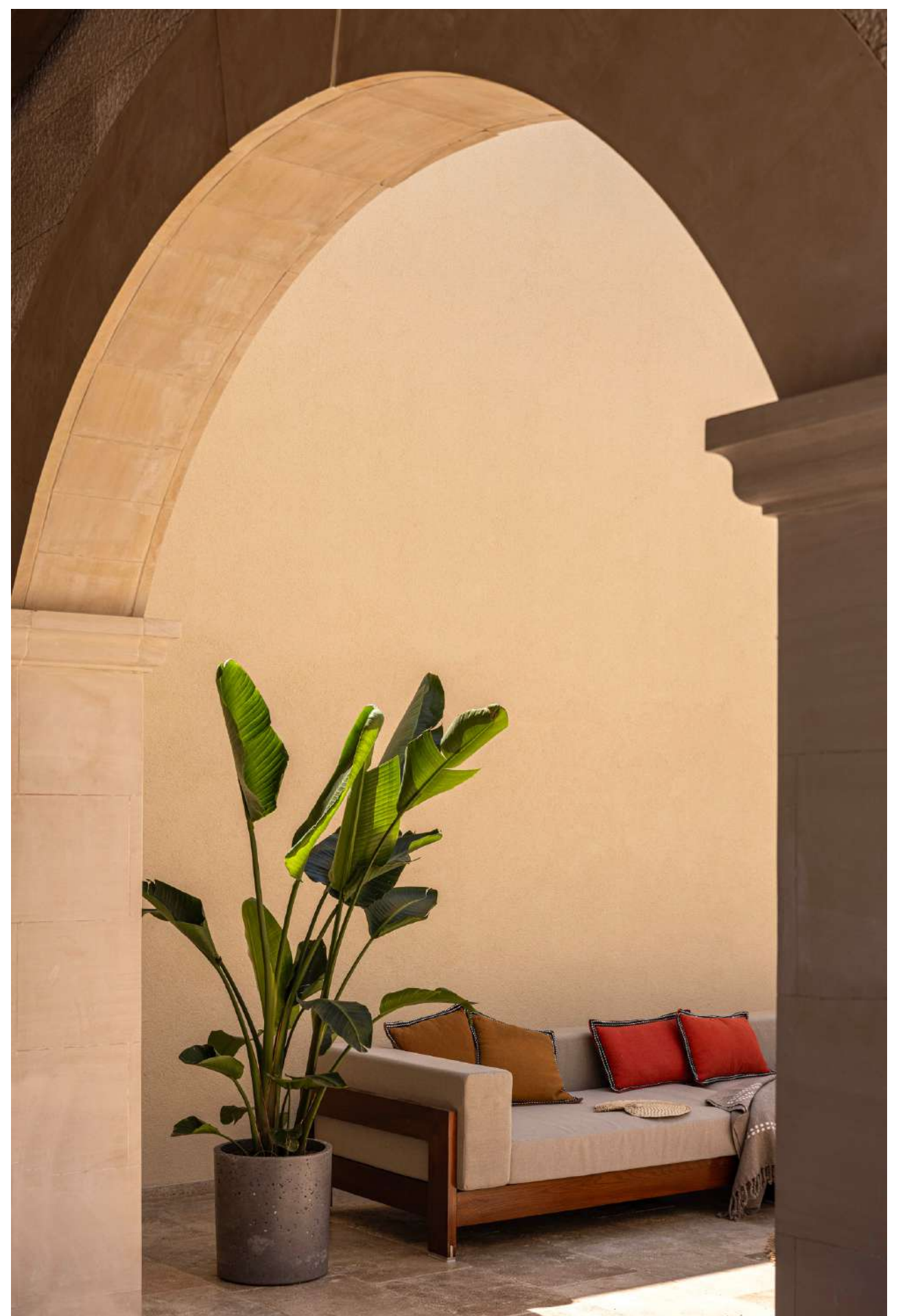

MINIMO



Our idea was to create something more than an outdoor shower - a sculpture with a feature of an outdoor shower. The uniqueness behind MINIMO is the passion for natural stone and hand-crafting. We can proudly say that we are the first company in history to produce outdoor showers from natural stone, completely assembled in the factory as serial production units, and delivered to customers in one piece.

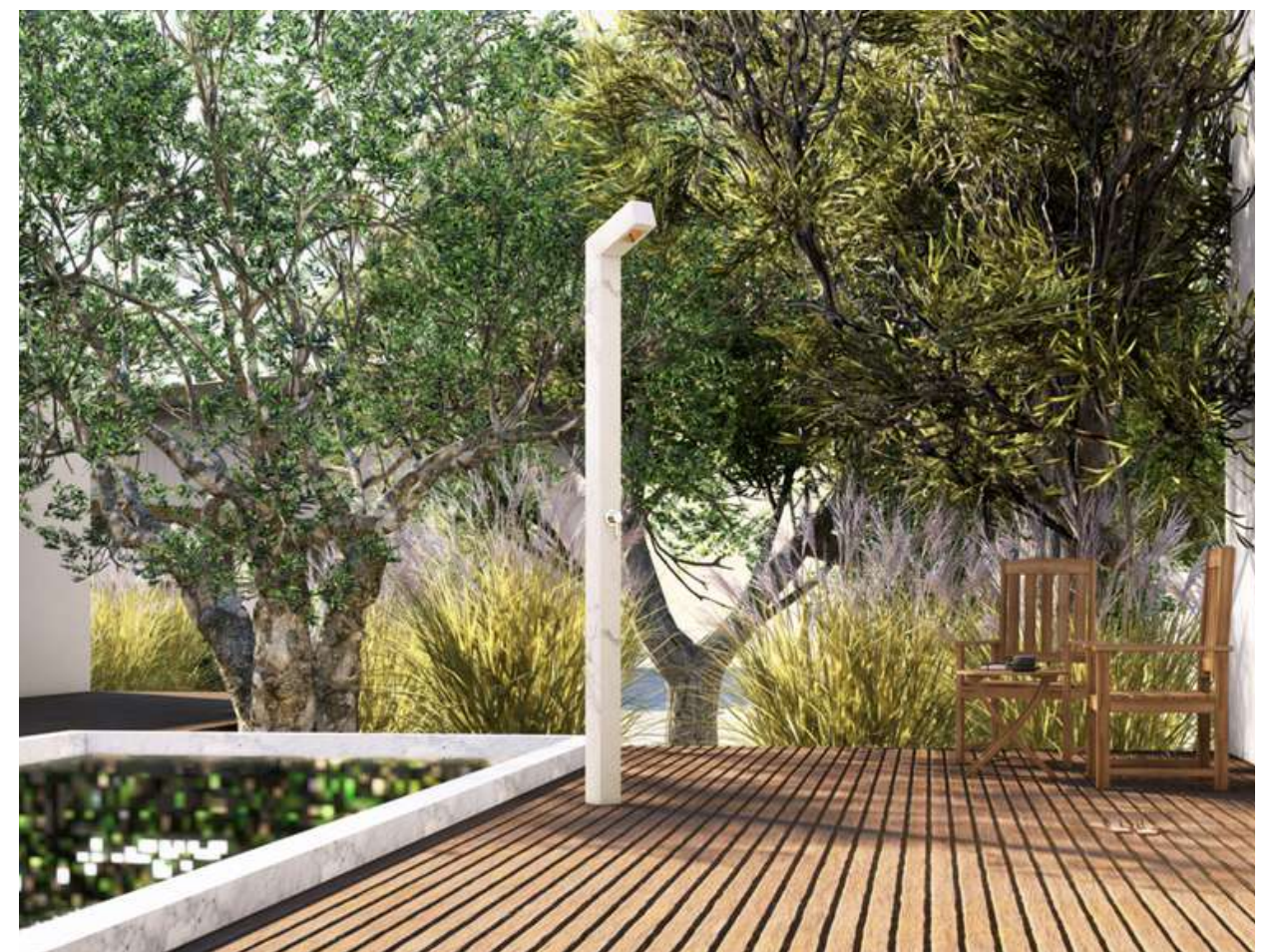

**Product:** Outdoor shower *Minimo*  
**Material:** Marazzi Golden White LUX  
**Code:** MINCGWL

MINIMO outdoor shower is made to stand out, elevate any exterior area, and give that wow effect to a backyard once it's complete. MINIMO, together with nature's aromatherapy such as plants, trees, and water, makes a blend that creates the perfect relaxing outdoor area.



# STONE FINISHES



*Polished / Sandblasted+brushed / Flamed+brushed*

## DECORS BY MARAZZI



*Statuario / Smoke / Sahara Noir*



*Golden White / Saint Laurent / Grigio Carico*



Product: Outdoor shower *Minimo*  
Material: Kanfanar - sandblasted + brushed  
Code: MINCGWL



Product: Custom made Outdoor shower *Minimo*  
Material: Granit Assoluto Nero - brushed  
Code: MINGANBWTMS



# PRODUCT DIMENSIONS

STONE

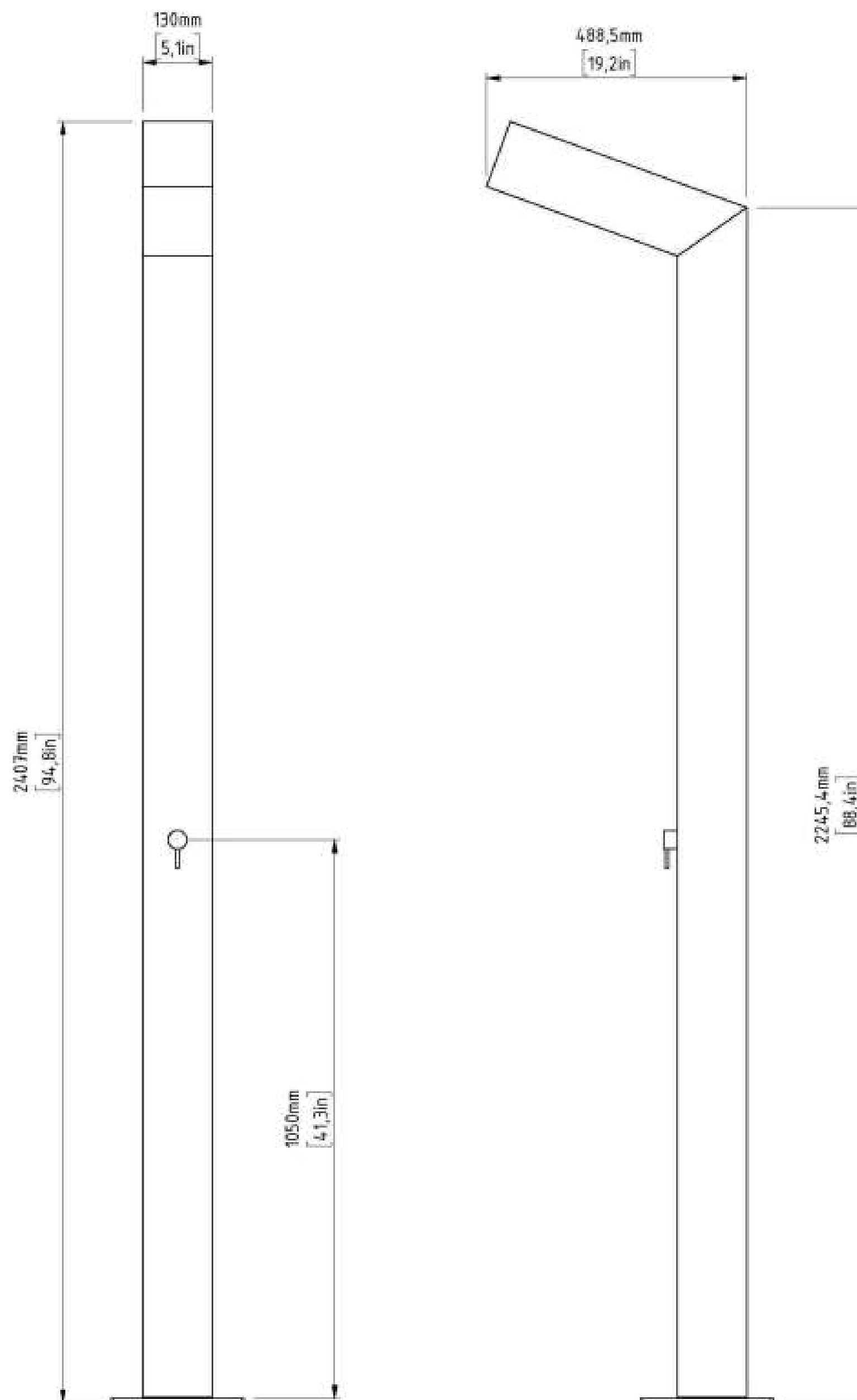

78kg / 172lbs

# PRODUCT DIMENSIONS



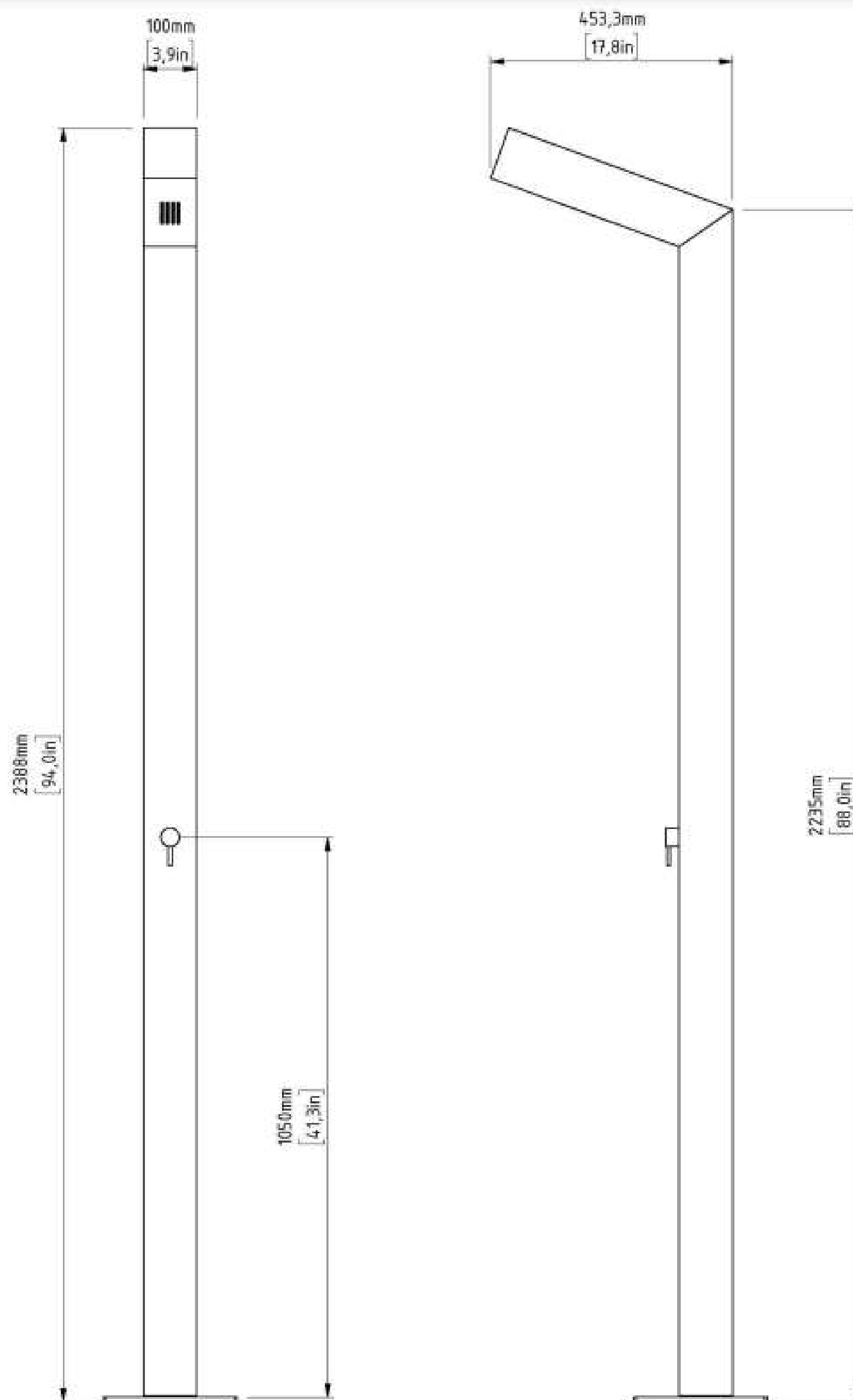



## CERAMICS

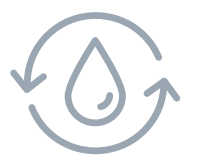







30kg / 66lbs

## SHOWER SYSTEM STANDARD FEATURES



-  4 flexible stainless steel knitted hose 1/2"
-  2-way mixing mechanism with faucet and handle designed by Mariner Rubinetterie
-  Ecotech shower head by Mariner Rubinetterie which enables water savings of up to 50 %
-  The informed Nattura S shower catalyst with beneficial well-being effects
-  Protective shower cover
-  Protective base plate cover
-  Water flow 4-8 L / min

## SHOWER SYSTEM ADDITIONAL FEATURES

-  Ambient LED lighting designed by Filix
-  Anti-frost heating cable
-  Logo engraving
-  Motion sensor
-  Additional shower handle
-  Hot water tank (*exclusively available in dark decors*)



Product: Outdoor shower *Minimo*  
Material: Kanfanar - polished  
Code: MINSP





KADA



## STONE FINISHES



*Brushed*



Bringing the outdoors indoors, and infusing our living spaces with plants and natural elements, undeniably uplifts our spirits. Yet, a similarly revitalizing effect can be achieved by taking the indoors outdoors. The trend of outdoor spa areas and garden bathtubs has gained immense popularity. While initially embraced by upscale hotels and retreats, this concept can be seamlessly replicated at home.

The KADA represents a selection of outdoor bathtubs made from natural stone Kanfanar. These bathtubs offer a luxurious and relaxing bathing experience whilst immersed in nature.

An outdoor bathtub is a lovely addition to give any garden a touch of luxury, particularly when combined with an outdoor shower. It's a clever way to create a spa-like vibe without going all out with a hot tub or pool.



**Product:** Outdoor bathtub KADA - ANIA  
**Material:** Kanfanar - brushed  
**Code:** KANIASB



# PRODUCT DIMENSIONS

## LATIA

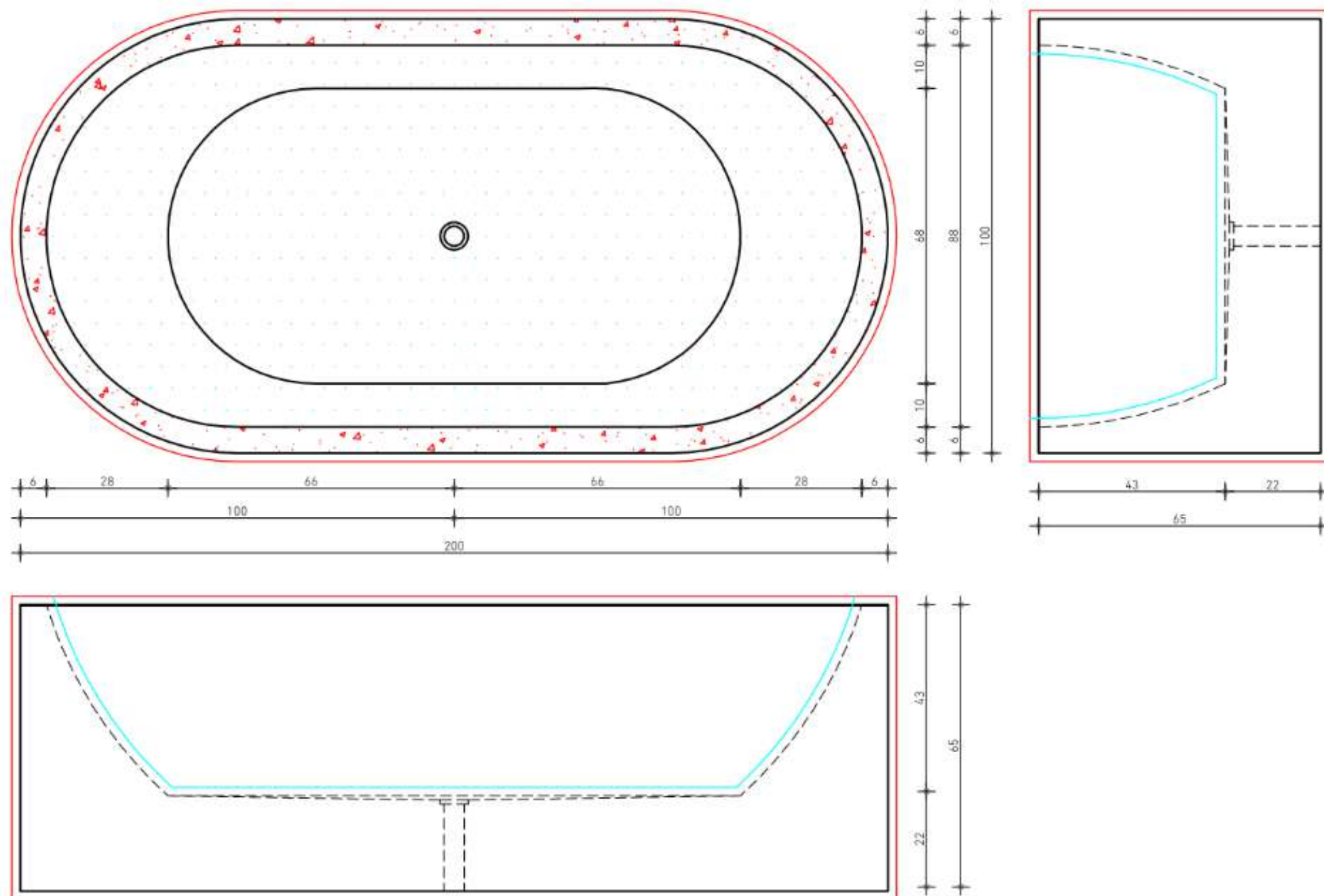

## ENEA

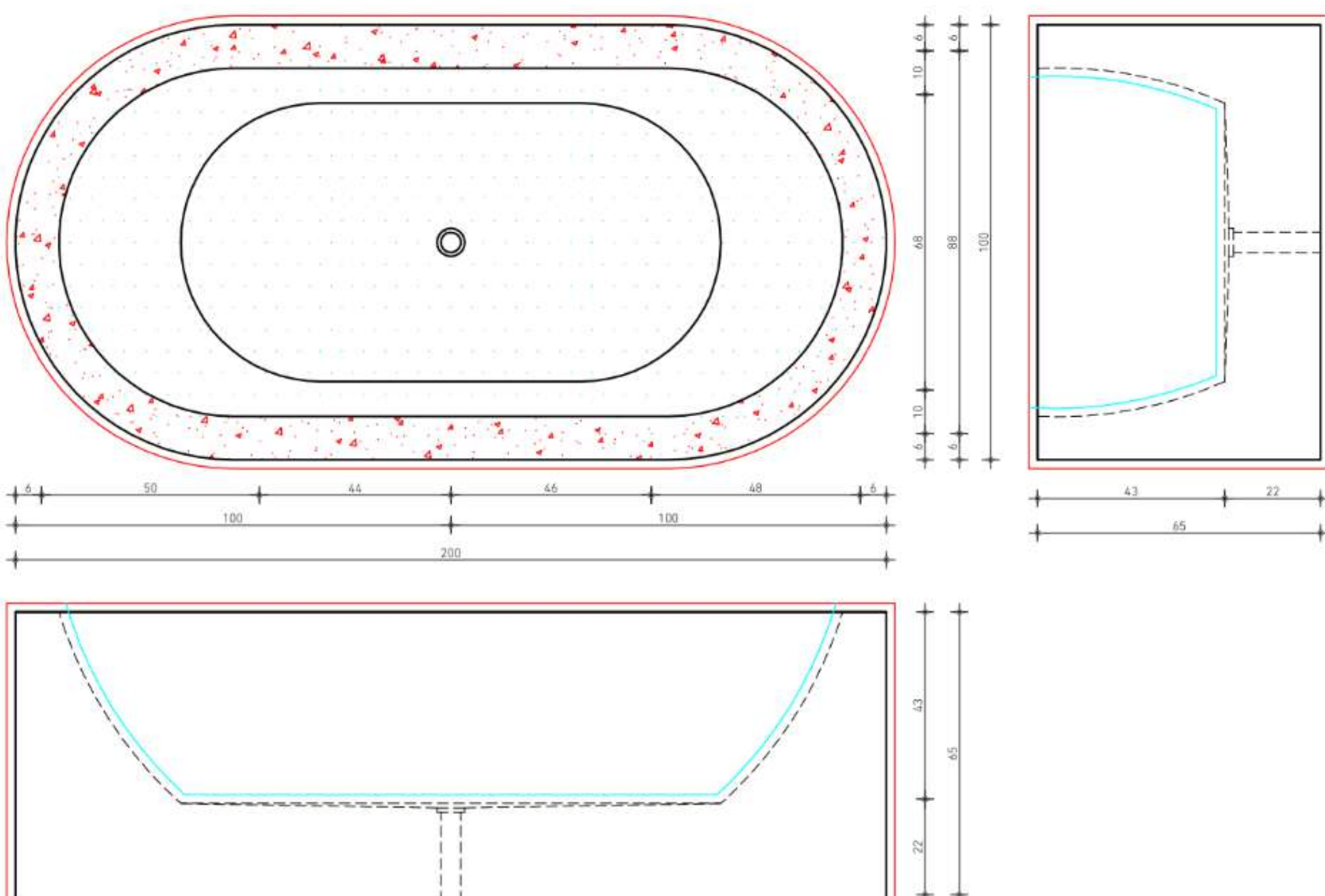

# PRODUCT DIMENSIONS

## ANIA

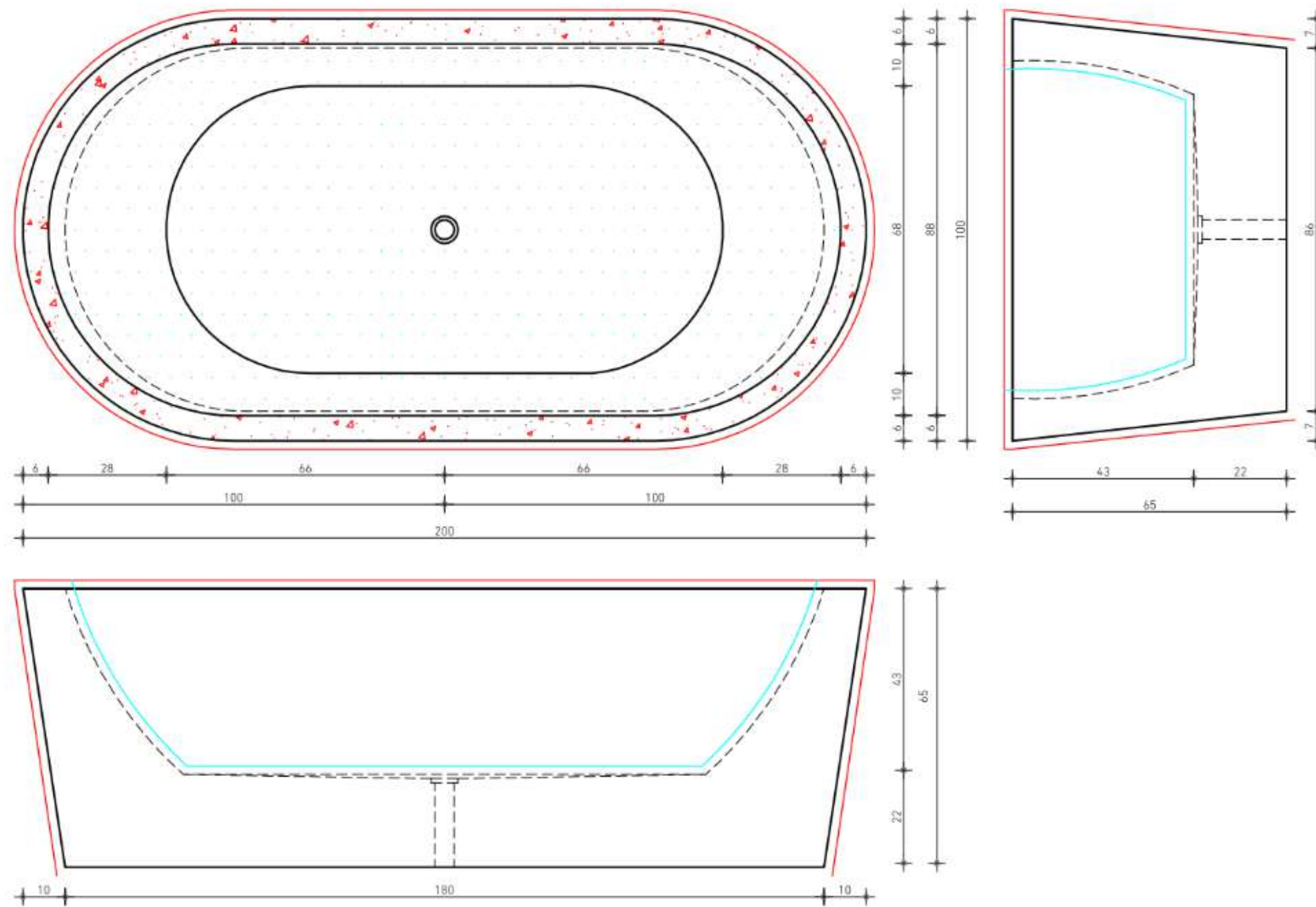

## GAIA

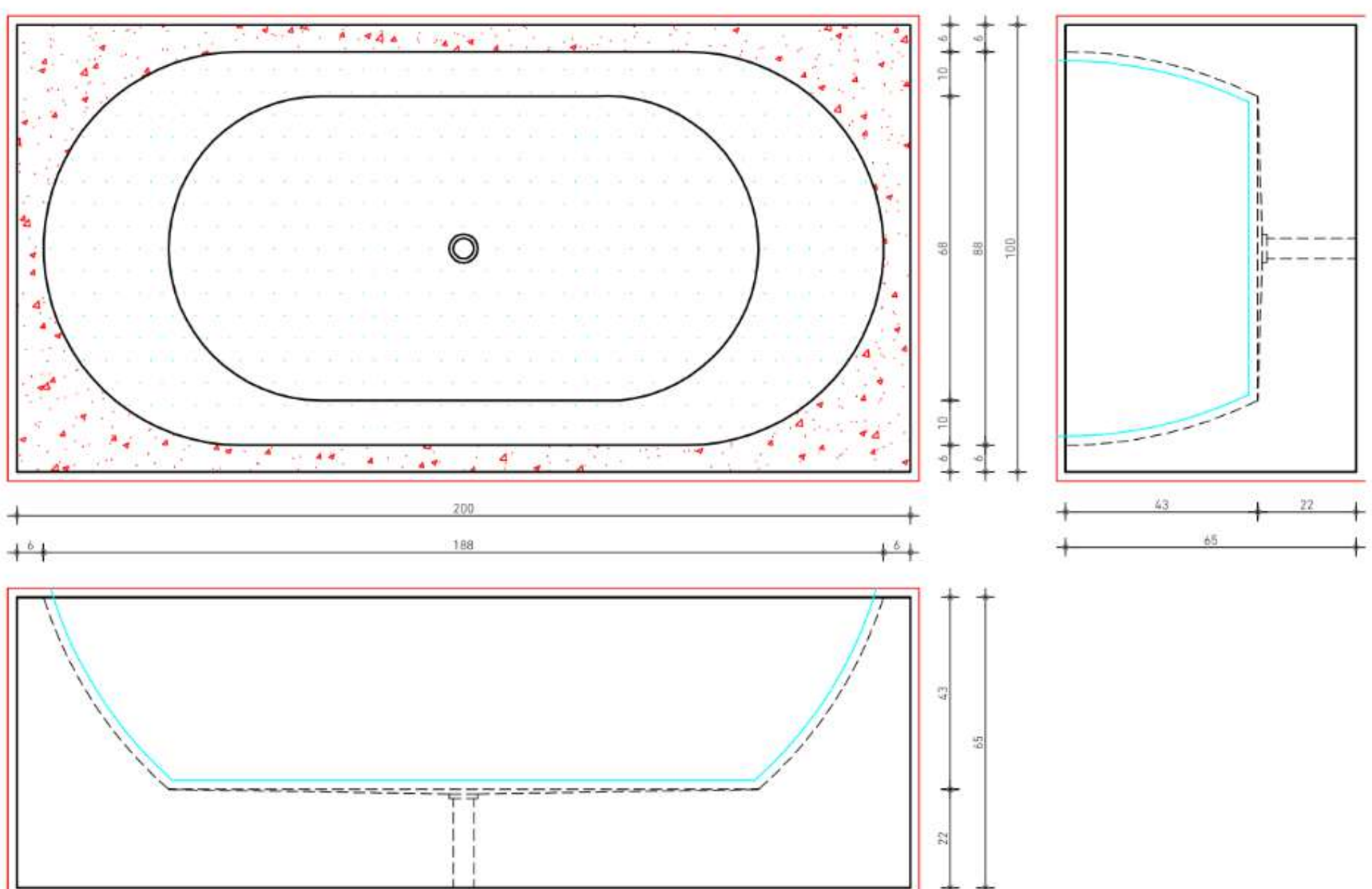

# PRODUCT DIMENSIONS

## LUCE

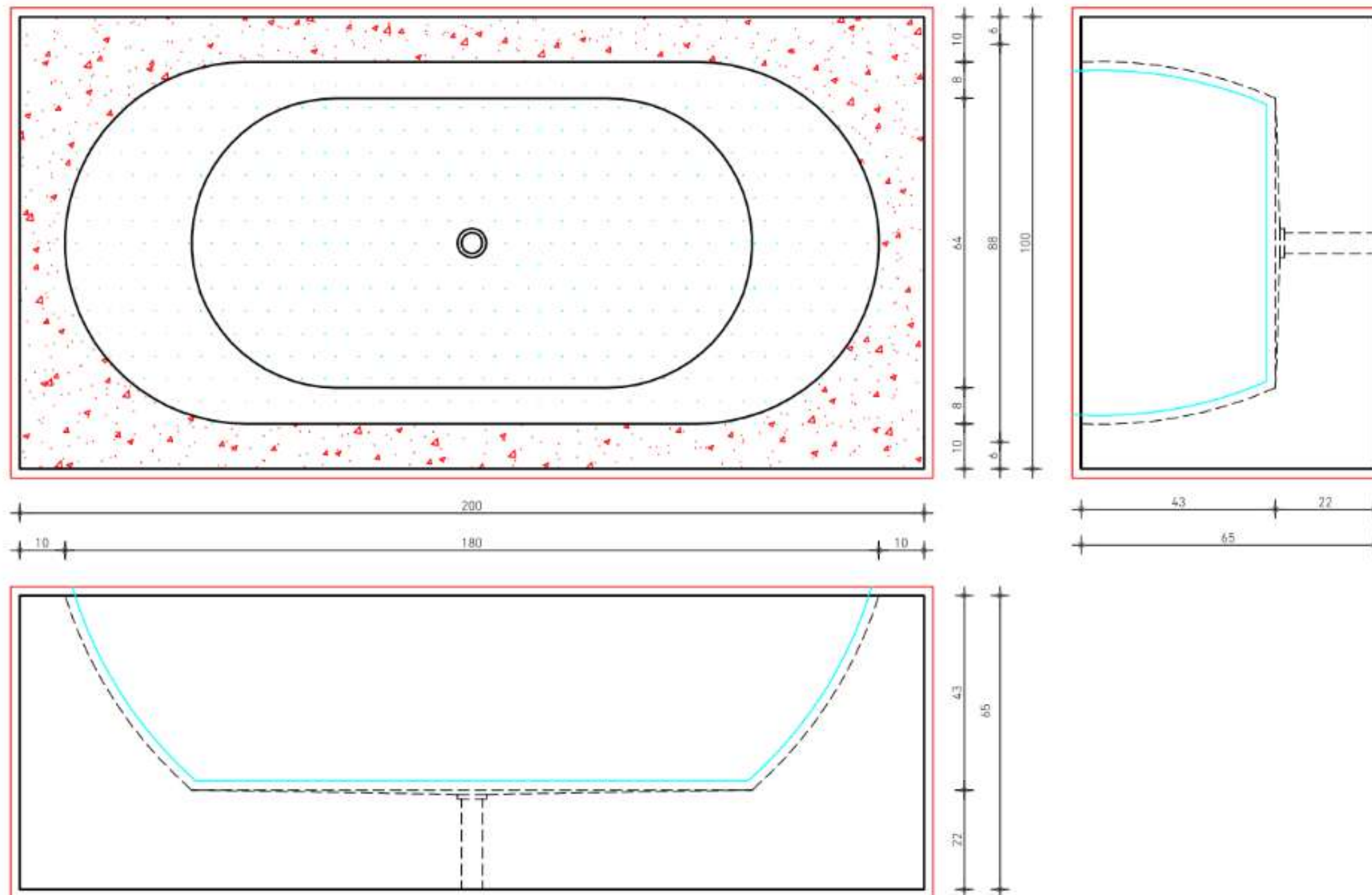

## MENA

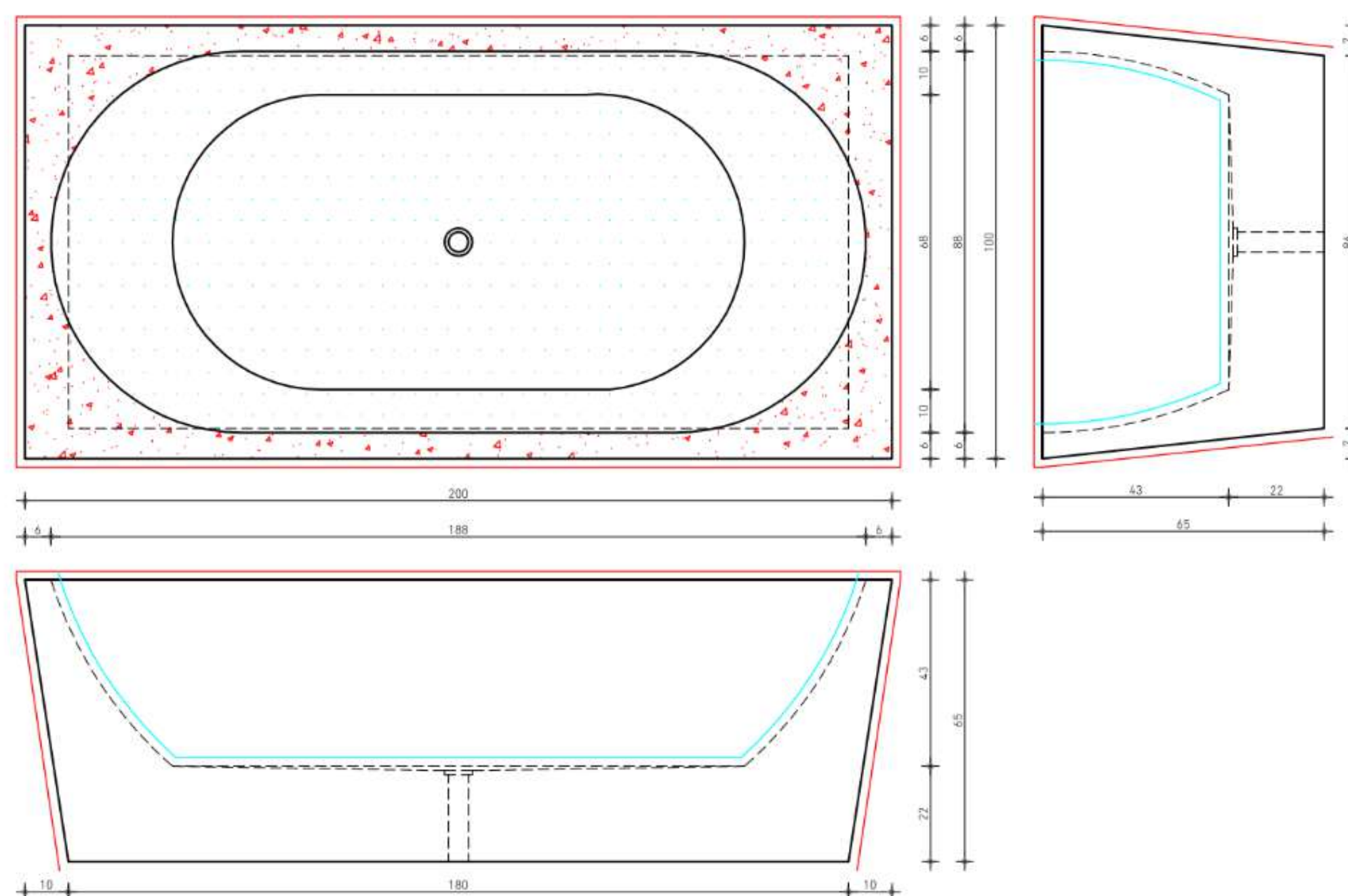



Product: Outdoor bathtub KADA - ANIA

Material: Kanfanar - brushed

Code: KANIASB





**Product:** Outdoor bathtub KADA - GAIA  
**Material:** Kanfanar - brushed  
**Code:** KGAIASB

# FUOCO ZONE

Immerse yourself in the captivating ambiance of the Fuoco Zone, where the power of fire brings people together and fuels creativity. Inspired by the age-old tradition of gathering and sharing stories around a warm and inviting flame, this zone embodies the essence of timeless connection. Our carefully curated products within the Fuoco Zone are more than just functional; they are works of art that ignite conversation and create unforgettable moments. Whether you're entertaining guests or seeking solace in quiet contemplation, these visually stunning pieces are designed to enhance your experience and elevate any setting. Let the Fuoco Zone become the heart of your outdoor space, where warmth, beauty, and unforgettable memories come to life.



GARDENZIO





TA

Carefully selected materials and multiple design options is what makes the GARDENZIO range of outdoor kitchens so unique.

Our kitchens will enhance any outdoor space, serving as the focal point of your alfresco dining encounters; offering a harmonious design that accommodates diverse applications.

Developed in partnership with Gardenzio - Outdoor Living.



Product: Outdoor kitchen *COMPATTO*  
Code: ROKC75KANMOKDUB



Product: Outdoor kitchen *COMPATTO*  
Code: EOKC75GOL20LATDUB



# WOOD



*European Oak / Brazilian IPE / Siberian Larch*

*\* In addition, we offer an array of HPL finishes made by Fundermax as a non-wood alternative.*

# STONE



*Kanfana: Sandblasted+brushed / Polished*

*\*In addition, we offer Nero Assoluto, Steel Gray, Vizag Blue, Verde Marina and THE TOP collection by Marazzi as a non-stone alternative.*

## METAL

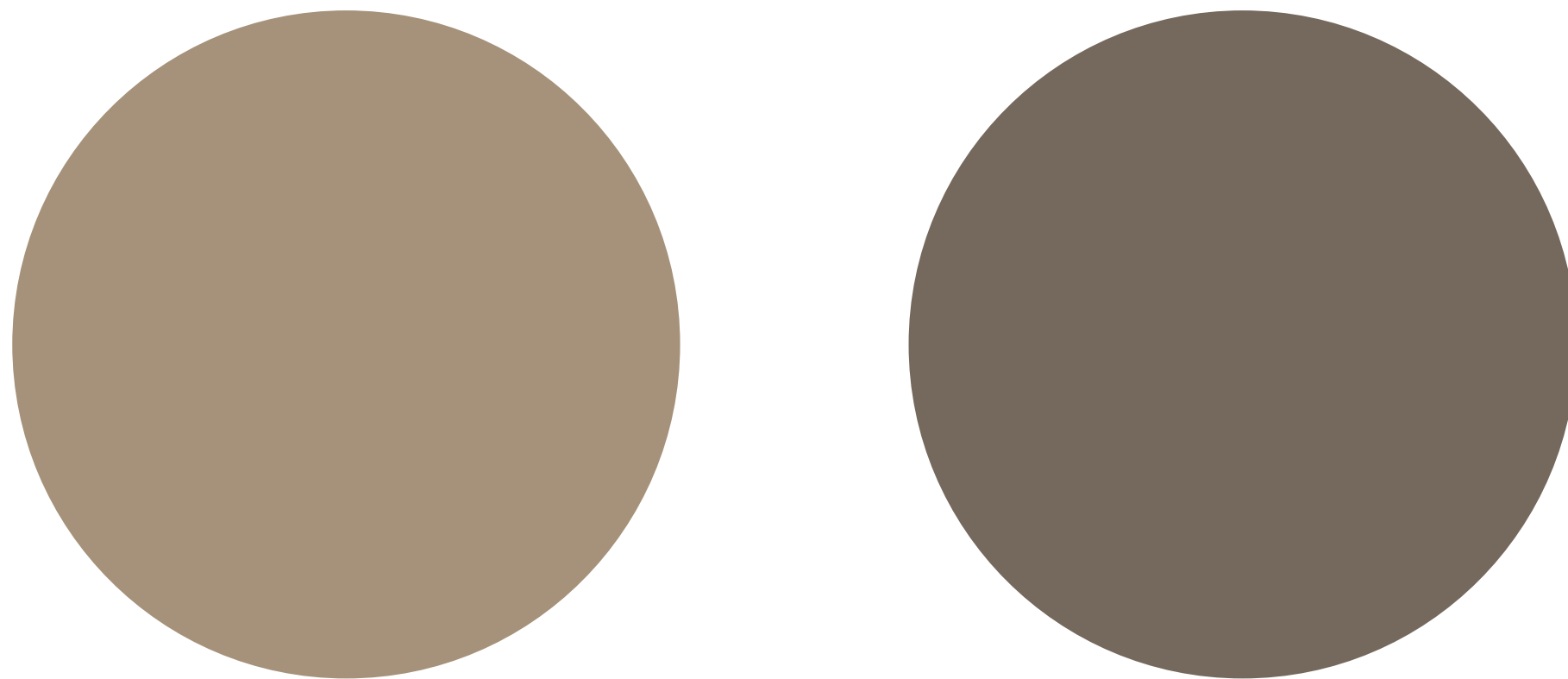

*Black / Anthracite / Gray  
Latte / Mocha*

*\* The metal construction is powder-coated and is currently available in five colors.*

# PRODUCT DIMENSIONS

## ROBUSTA - 75

COMPATTO

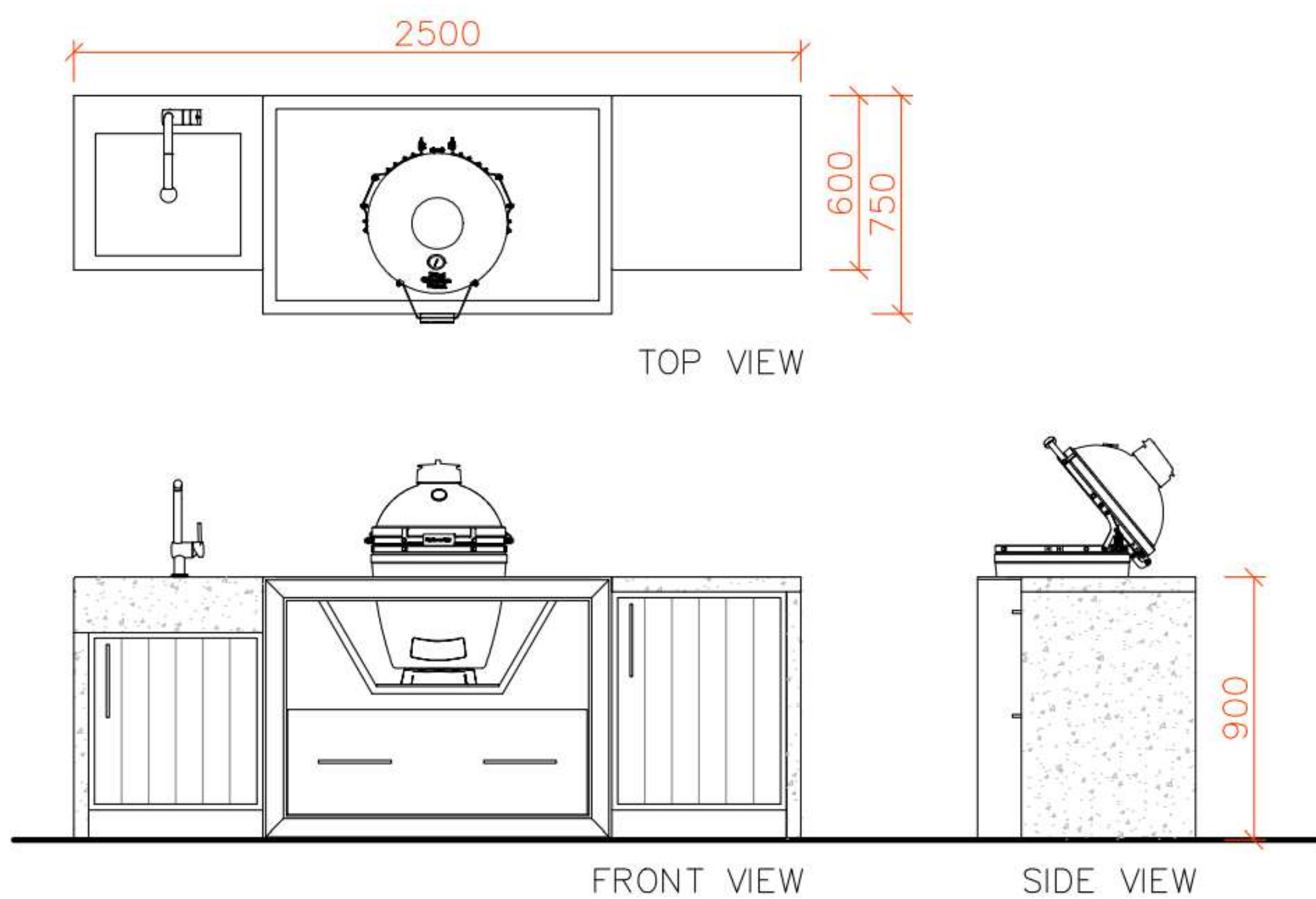

*Kanfanaar stone worktop (50 mm), European Oak wood cupboards,  
Big Green Egg ( Size M ) and Kanfanaar stone sink*

# PRODUCT DIMENSIONS

## ROBUSTA - 75

MEDIO

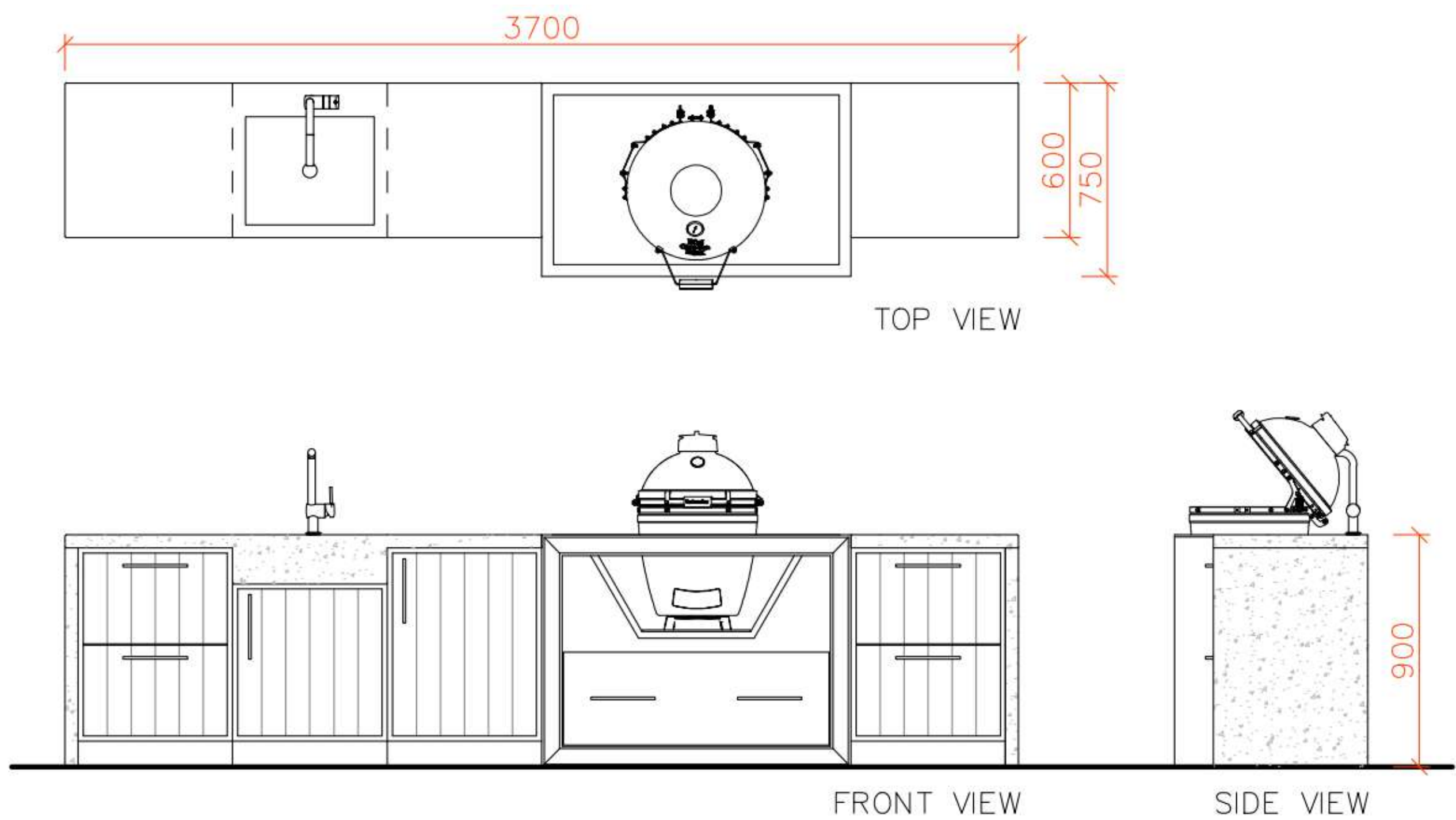

*Kanfanar stone worktop (50 mm), European Oak wood cupboards,  
Big Green Egg ( size M ) and Kanfanar stone sink*

# PRODUCT DIMENSIONS

## ROBUSTA - 75

GRANDE

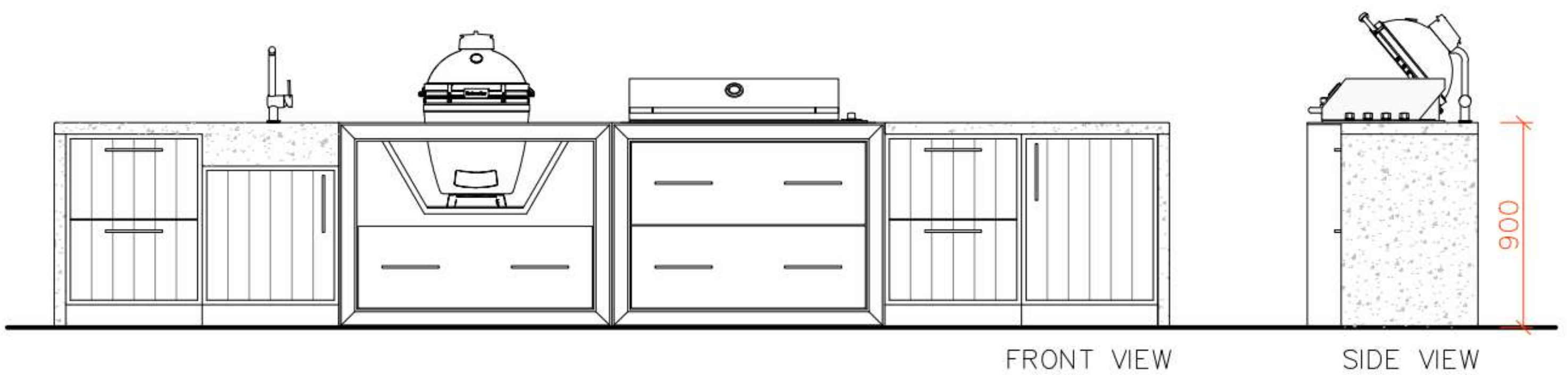
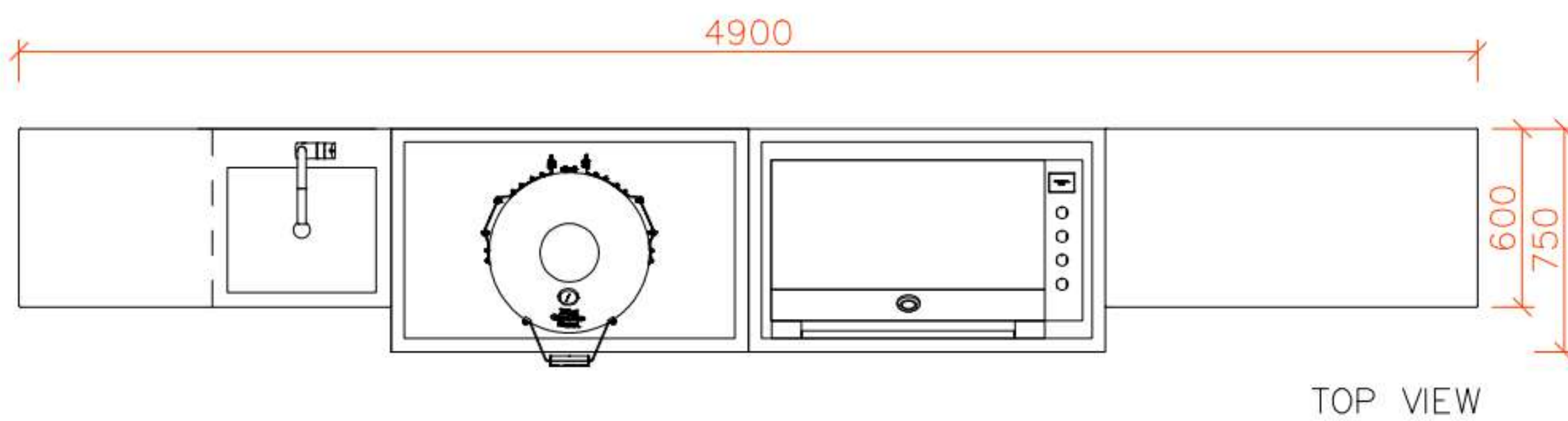

*Kanfana stone worktop (50 mm), European Oak wood cupboards,  
Big Green Egg ( size M ), Indu + Gazzgrill and Kanfana stone sink*



# PRODUCT DIMENSIONS

## ELEGANTE

COMPATTO '90'

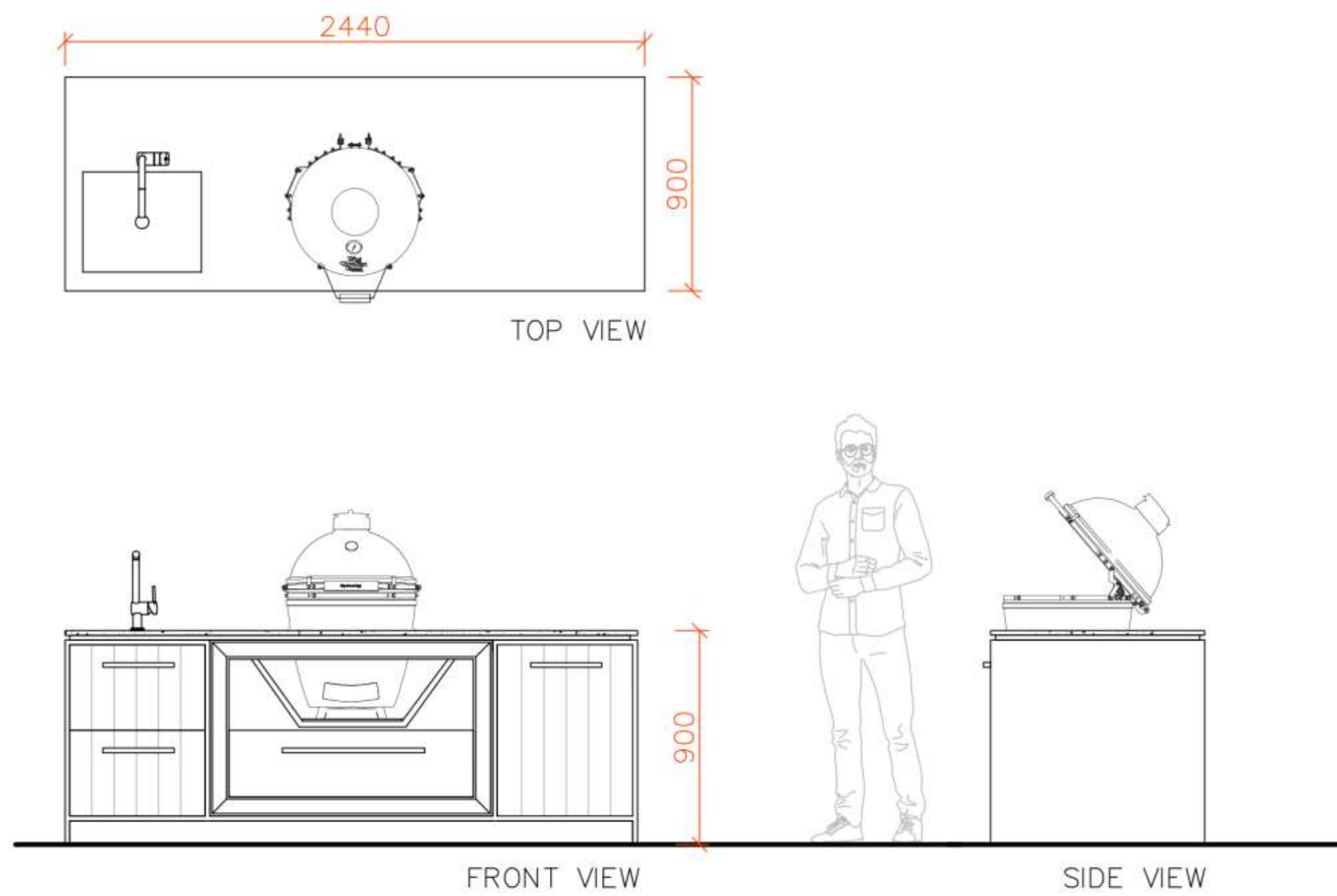

*Kanfana stone worktop (30 mm), European Oak wood cupboards,  
Big Green Egg ( size M ) and Kanfana stone sink*

# PRODUCT DIMENSIONS

## ELEGANTE

### MEDIO '90'

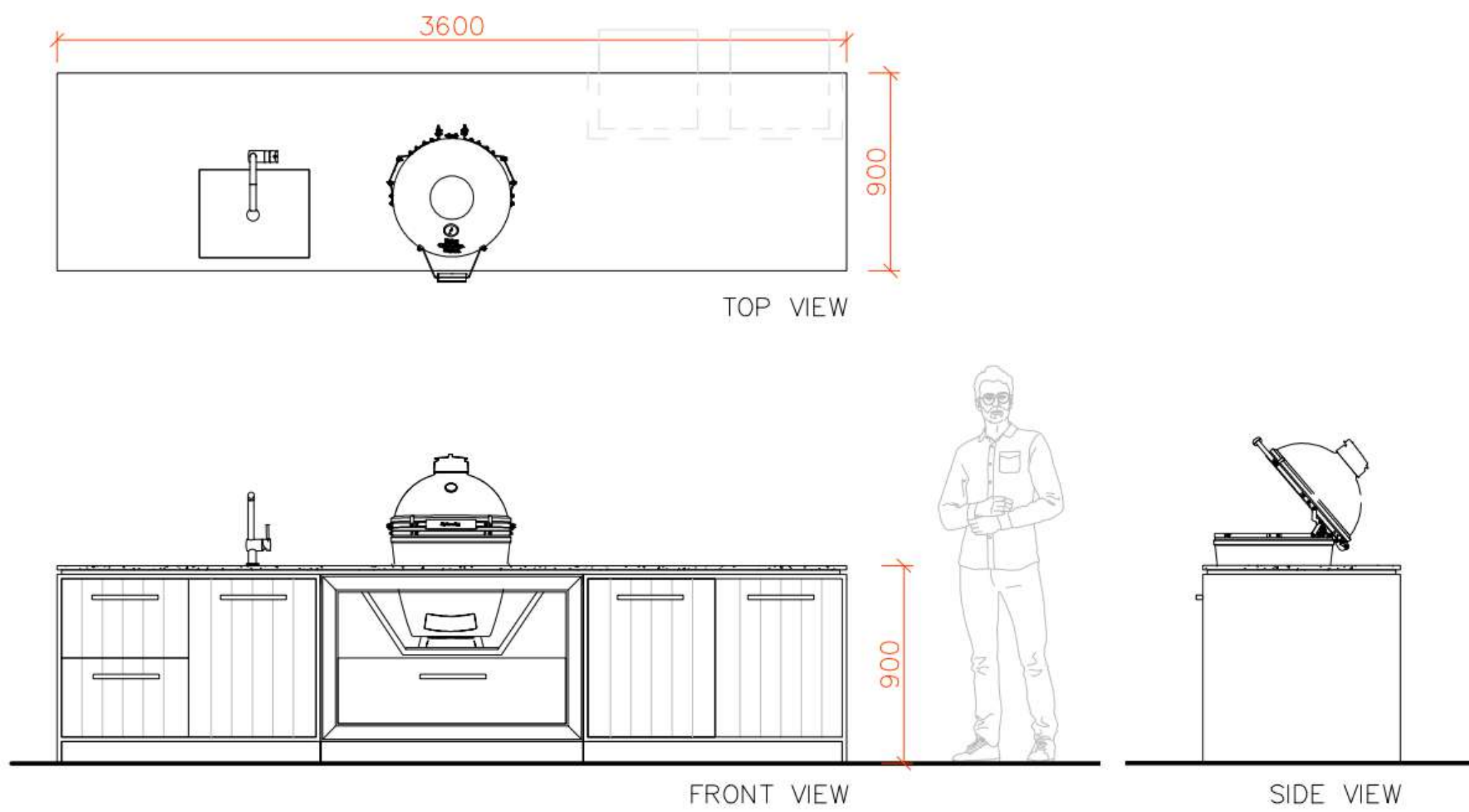

### MEDIO '120'

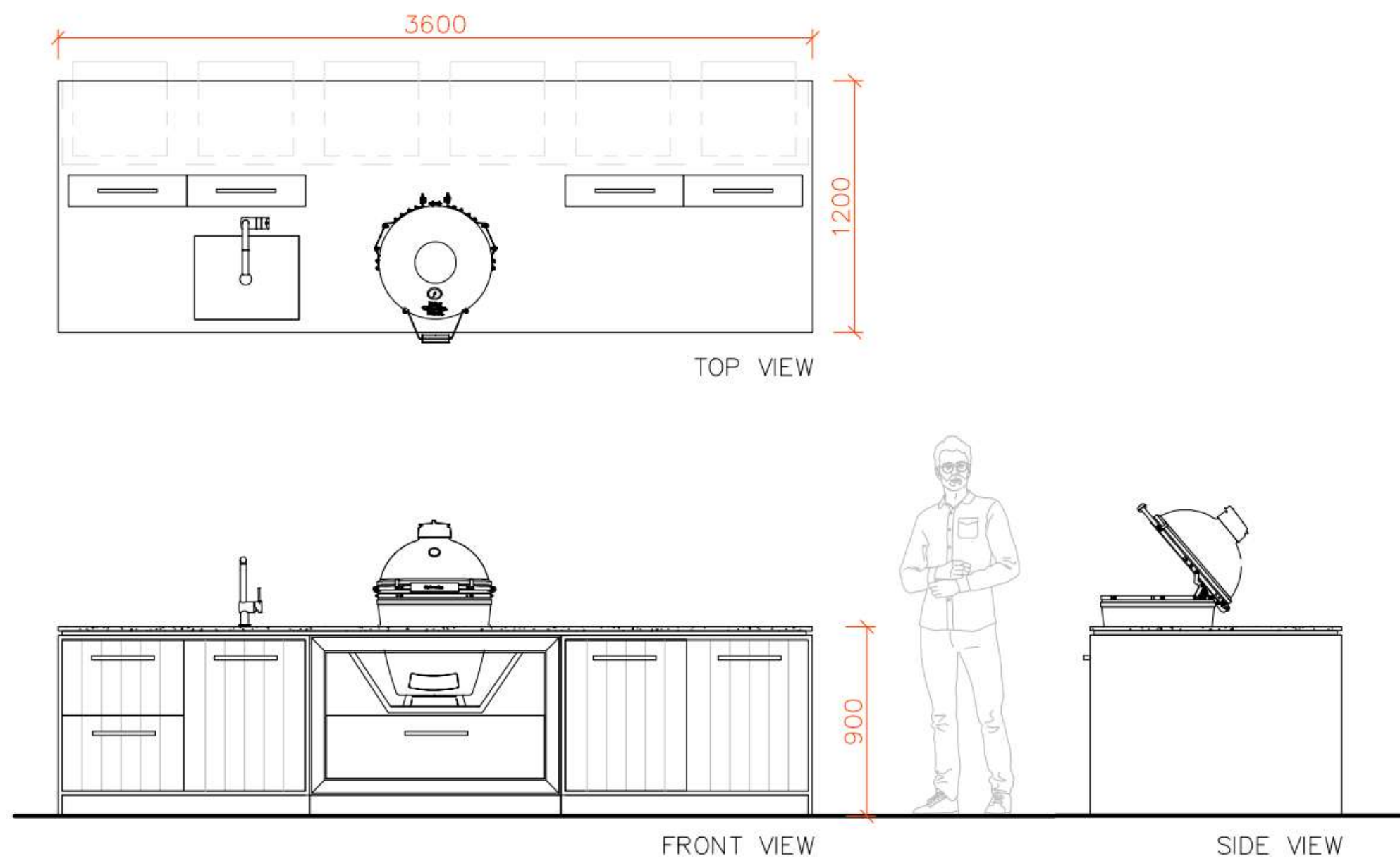

*Kanfana stone worktop (30 mm), European Oak wood cupboards,  
Big Green Egg ( size M ) and Kanfana stone sink*

# PRODUCT DIMENSIONS

## ELEGANTE

GRANDE '90'

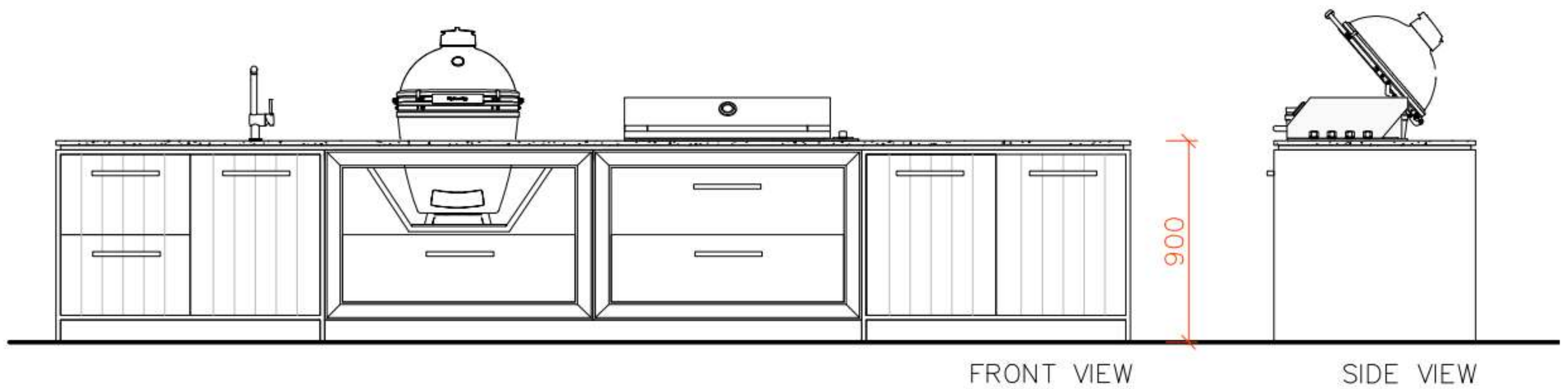
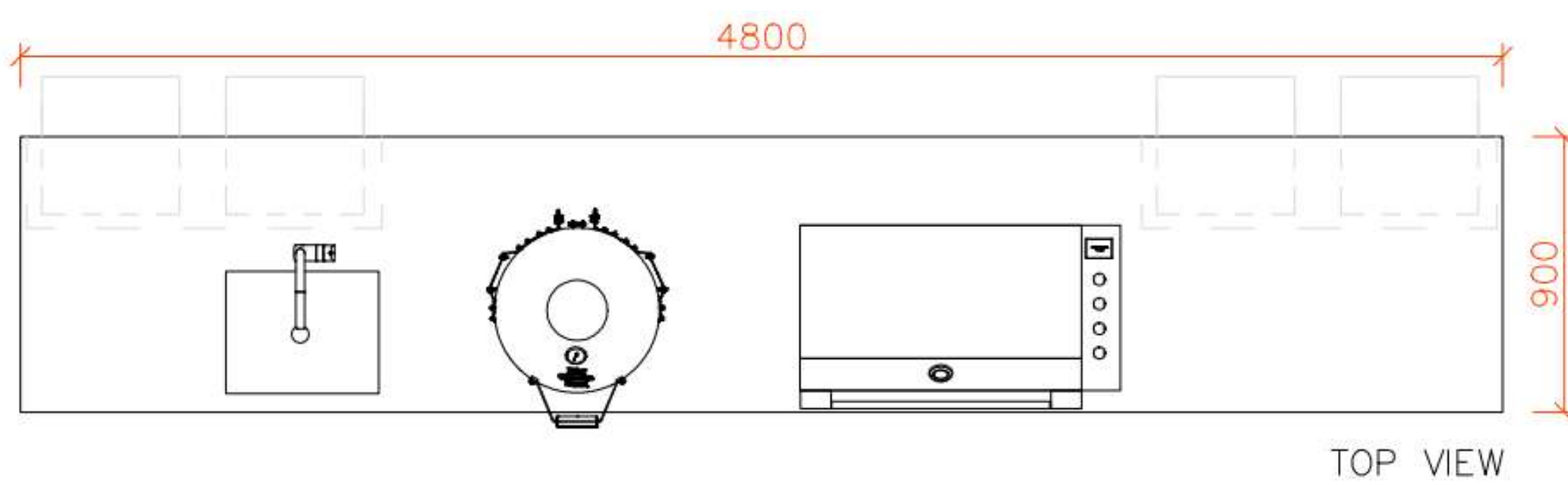

*Kanfana stone worktop (30 mm), European Oak wood cupboards,  
Big Green Egg ( size M ), Indu+Gazzgrill and Kanfana stone sink*

# PRODUCT DIMENSIONS

## ELEGANTE

G2 - GRANDE '120'

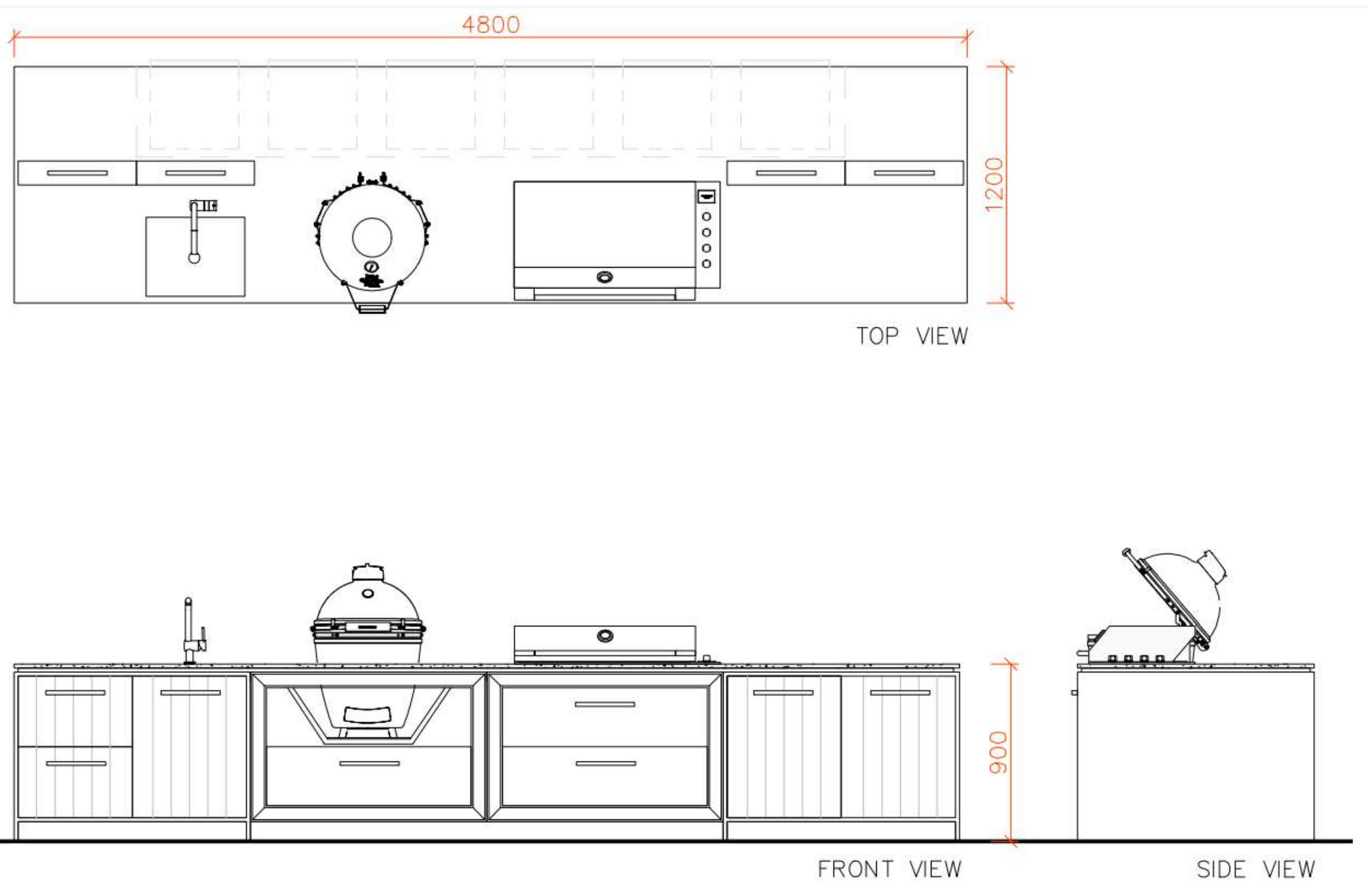

*Kanfana stone worktop (30 mm), European Oak wood cupboards,  
Big Green Egg ( size M ), Indu + Gazzgrill and Kanfana stone sink*

## APPLIANCES



**vivandio**

**Miele**



Product: Outdoor kitchen *COMPATTO*  
Code: ROKC75KANMOKDUB





Product: Outdoor kitchen *GRANDE*  
Code: ROKG75STEMANTHPL



Product: Outdoor kitchen *MEDIO*  
Code: ROKM75NERANTIPE









Product: Custom made Outdoor kitchen *MEDIO*



KAMIN



KAMIN, an Istrian word for fireplace, represents the heritage of our premium-designed outdoor fire pits. Unique surfaces for unique gardens.

Experience the harmonious fusion of elegance and warmth with our fire pit, elevating your surroundings with its stunning aesthetics that ignite a sublime sense of serenity and charm.

The base of the fire pit is crafted from authentic Istrian stone, Kanfanar, which offers a variety of finishes.



Product: Outdoor fire pit KAMIN  
Material: Kanfanar - polished  
Code: KAMSP

*Created by nature, made by people.*





# STONE FINISHES



*Polished / Sandblasted+brushed / Flamed+brushed*

# PRODUCT DIMENSIONS

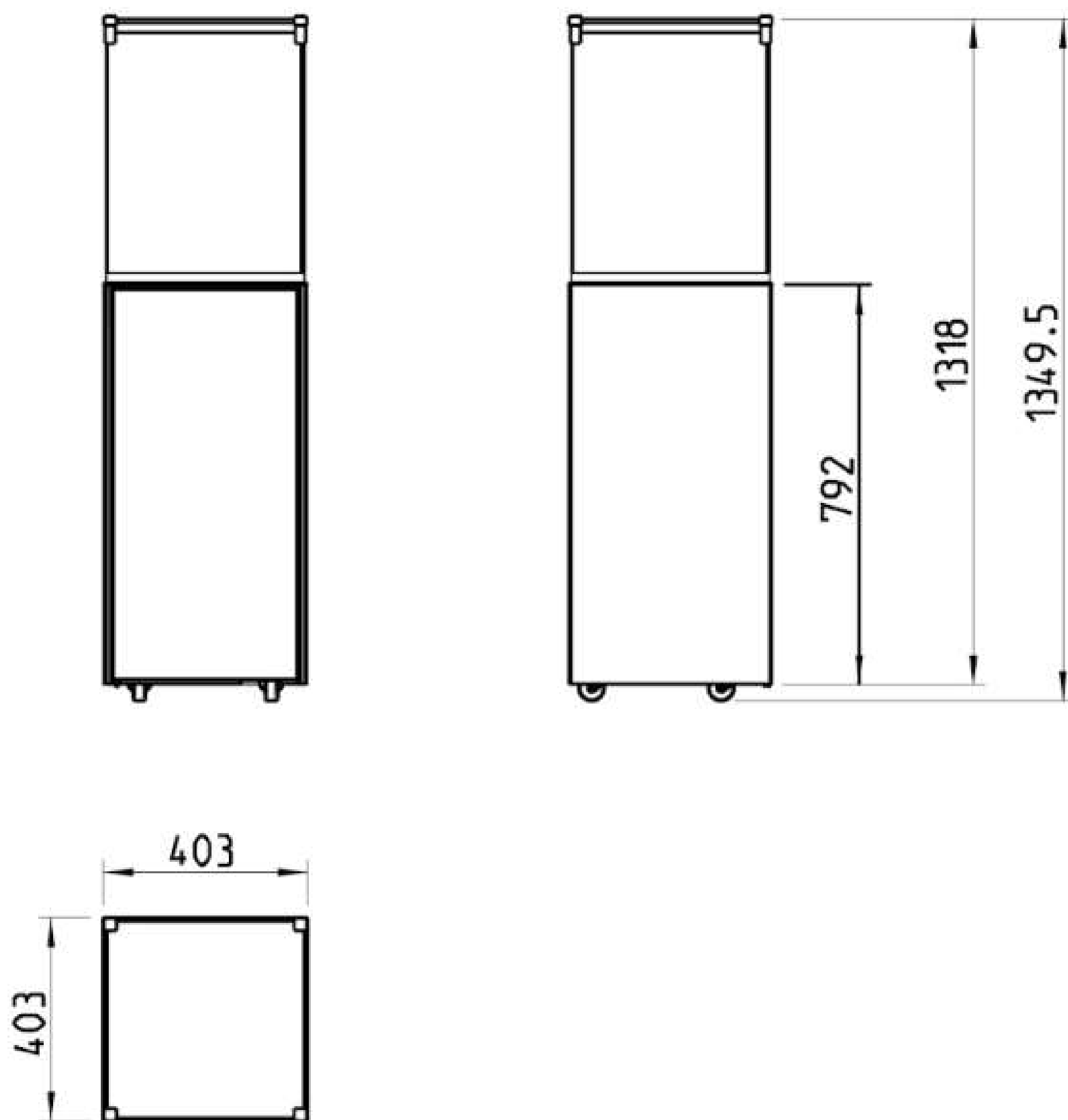





# ARIA ZONE

Aria Zone offers an idyllic sanctuary from the demands of everyday life. Step into a world of serenity and tranquility as you explore our carefully curated range of products designed to help you unwind in the great outdoors. Whether you seek a peaceful spot for meditation, a cozy corner to delve into your favorite book, or a space to create lasting memories with your loved ones, the Aria Zone welcomes you with open arms, inviting you to indulge in moments of pure bliss.



Envision a place where time slows down, and your worries effortlessly drift away. The Aria Zone is that perfect haven, crafted to provide an escape from the stresses of daily life. As you relax and recharge in this oasis of tranquility, you'll find yourself enveloped in a sense of calm and rejuvenation. With the Aria Zone, you can savor every precious moment, cherishing the simple joys of life, like drinking coffee or nurturing the plants and creating cherished memories that will last a lifetime. Indulge yourself and experience the true essence of relaxation amidst the captivating allure of the Aria Zone.

PONTE



Ponte is a part of KORTA collections, serving as both a functional and decorative element – either a coffee table to place between sun loungers or a side table of an outdoor bathroom. Following the clean lines of the Marbella and Odino showers, it unobtrusively serves the purpose and elevates the aesthetic perception of the space.



Product: Coffee table *Ponte*  
Material: Marazzi Sahara Noir - SATIN  
Code: CTPXLCSNS / CTPLCSNS

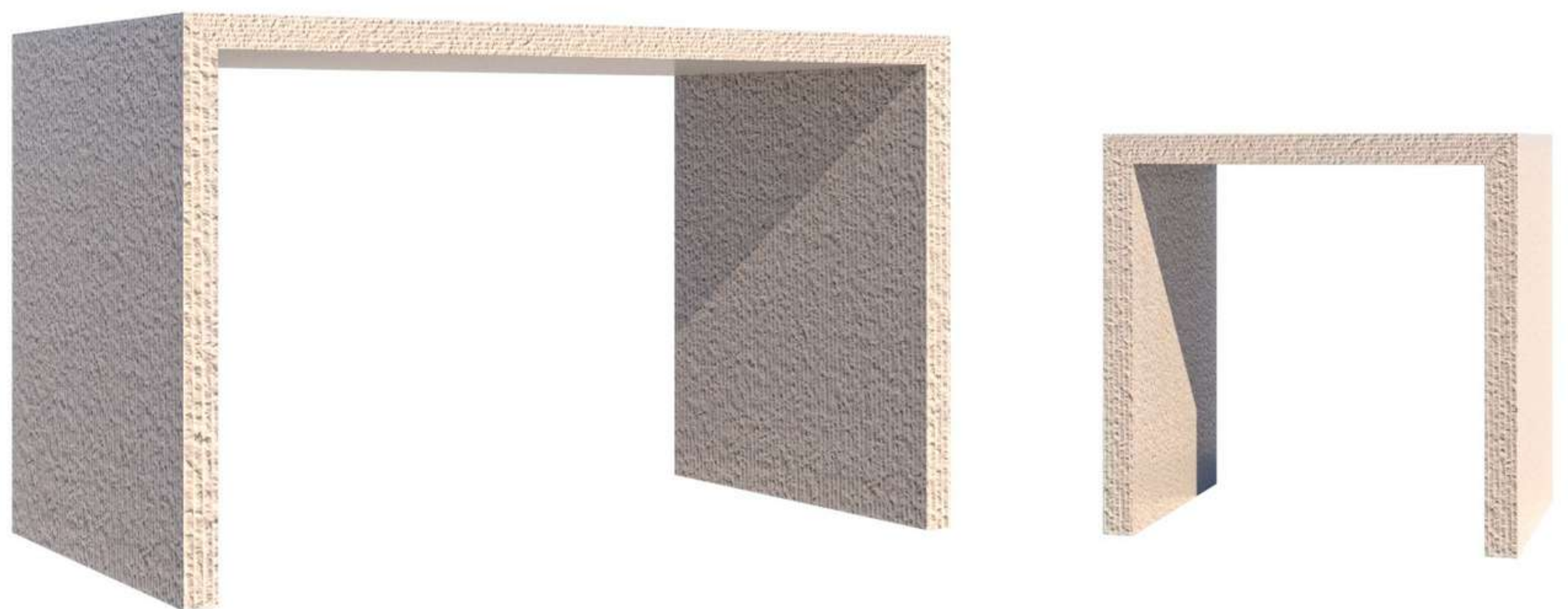

Product: Coffee table *Ponte*  
Material: Kanfanar - rigato  
Code: CTPXLSR / CTPLSR



Product: Coffee table *Ponte*  
Material: Kanfanar - sandblasted + brushed  
Code: CTPXLSSB / CTPLSSB



Product: Coffee table *Ponte*  
Material: Marazzi Saint Laurent - SATIN  
Code: CTPXLCSL / CTPLCSL

# STONE FINISHES



*Polished / Sandblasted+brushed / Flamed+brushed*

## DECORS BY MARAZZI



*Statuario / Smoke / Sahara Noir*



*Golden White / Saint Laurent / Grigio Carico*



# PRODUCT DIMENSIONS

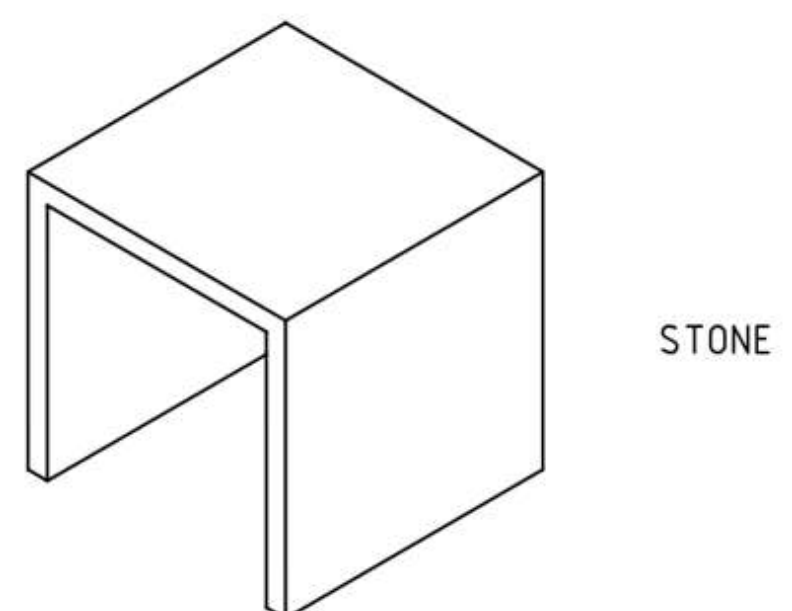
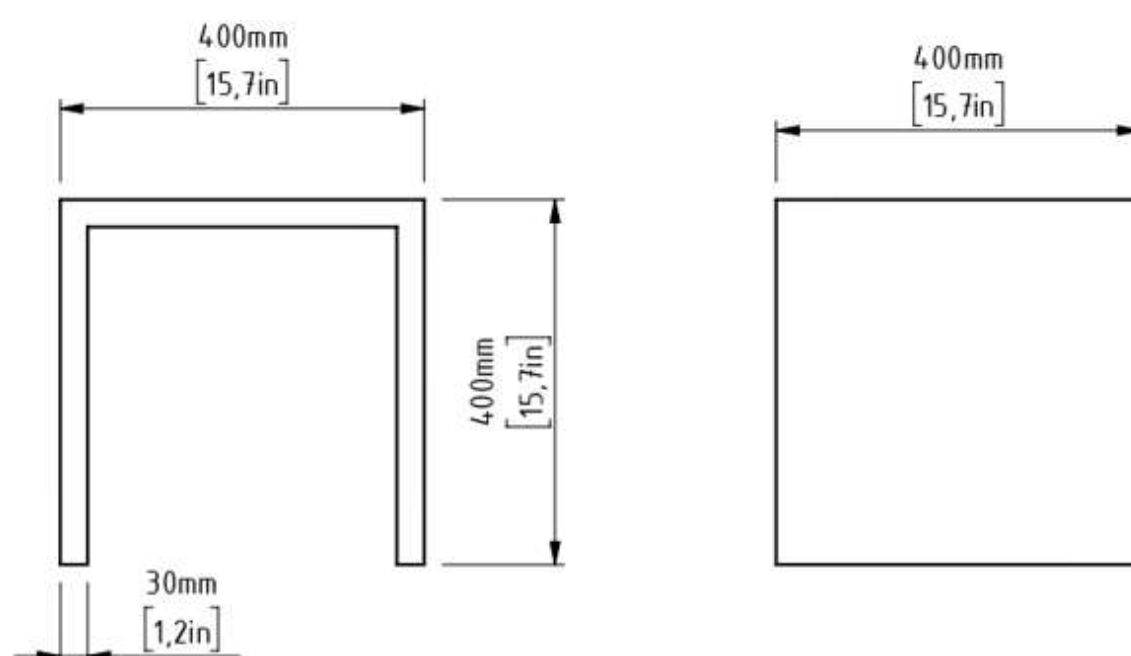
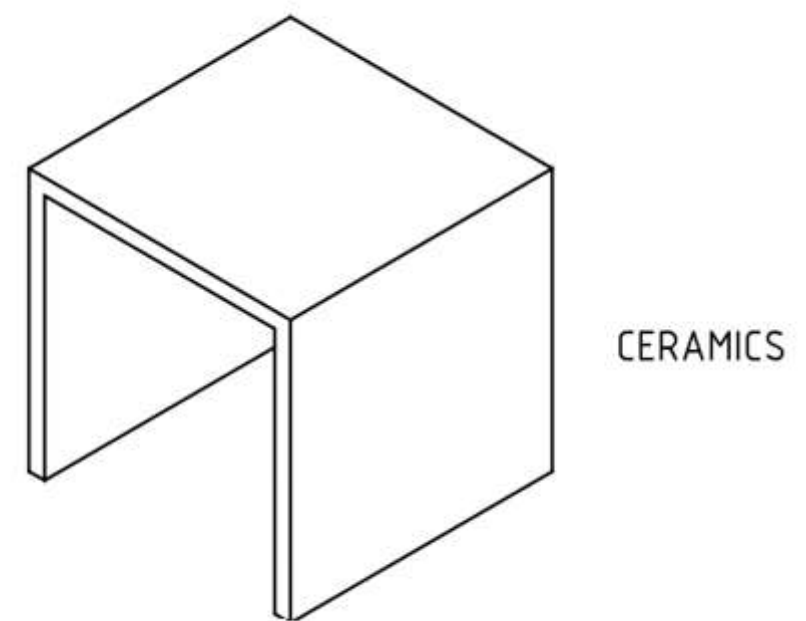
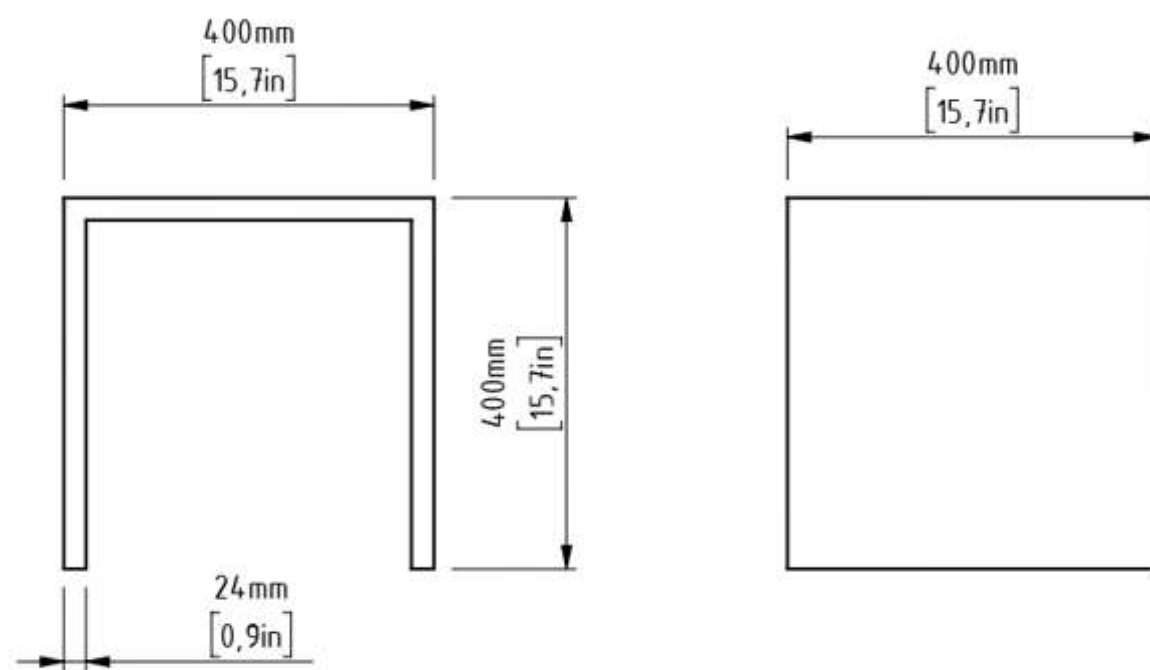
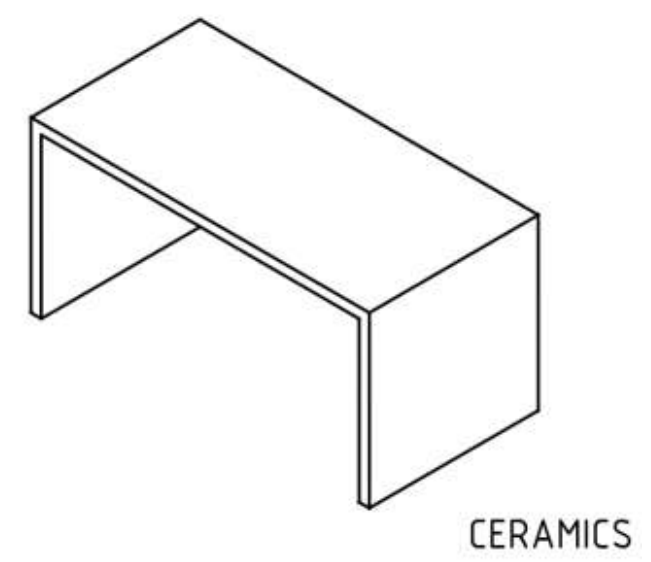
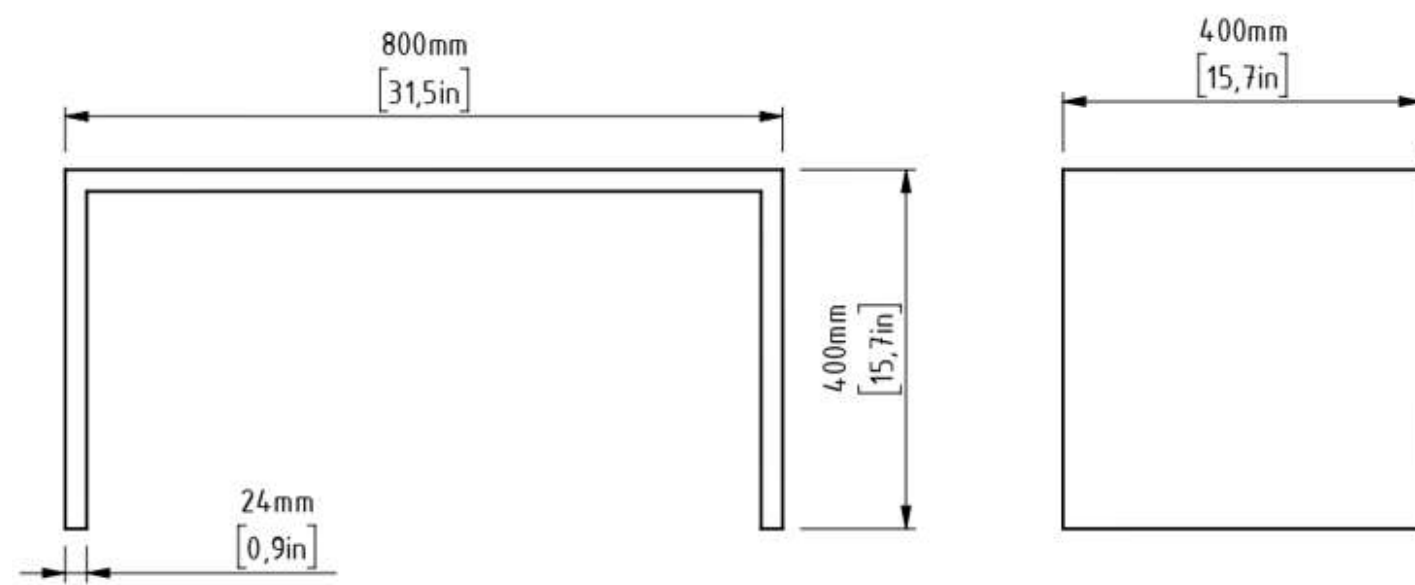
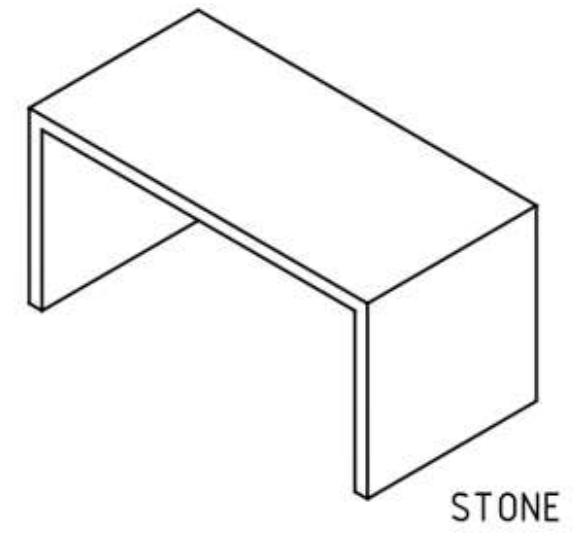
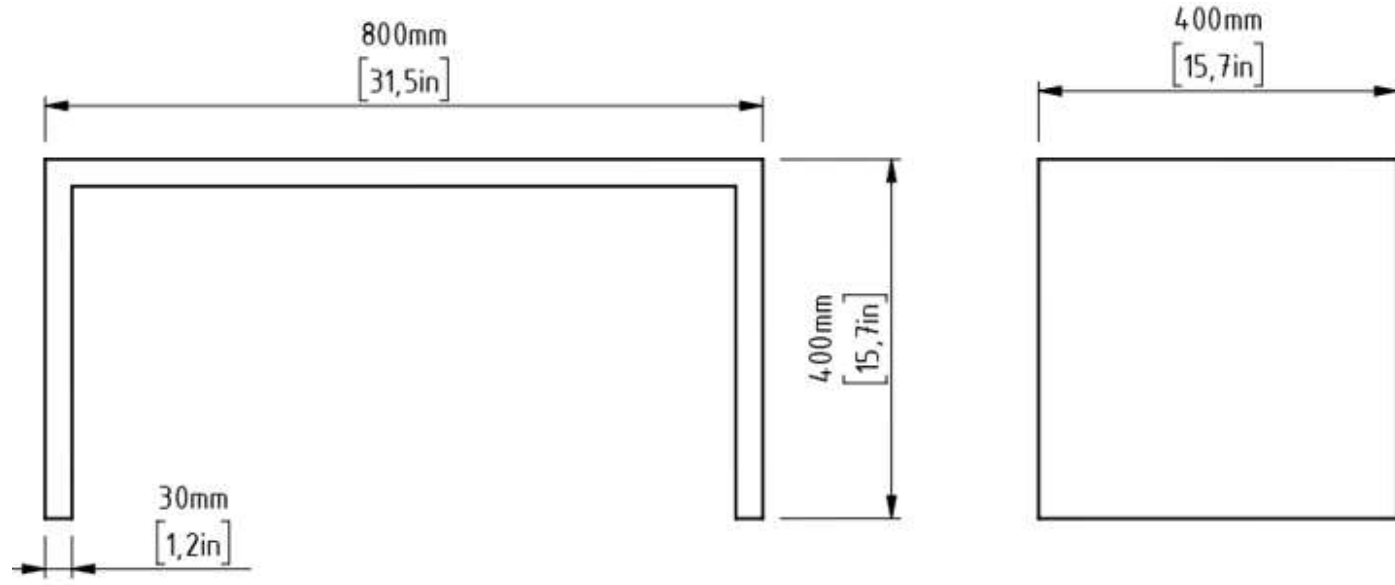

DIPINTO

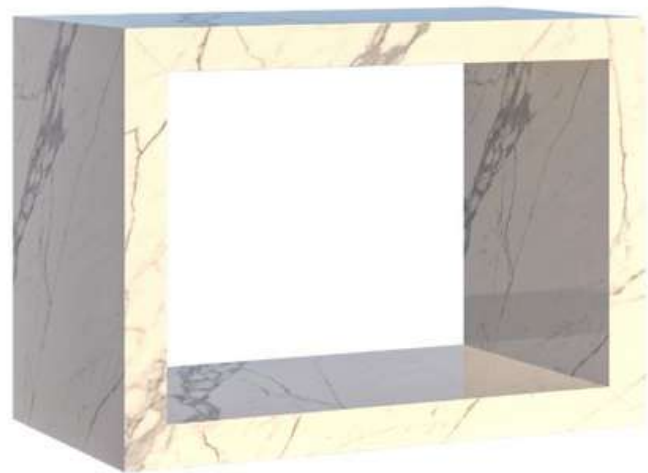

Product: Side table *Dipinto*  
Processing: Statuario SATIN  
Code: STDCSS

Just like Ponte, Dipinto is a product that has both a practical and decorative role within the KORTA collections. Placed in a space as a single piece or a group of side tables for various purposes, it contributes to creation of dynamic ambiances.



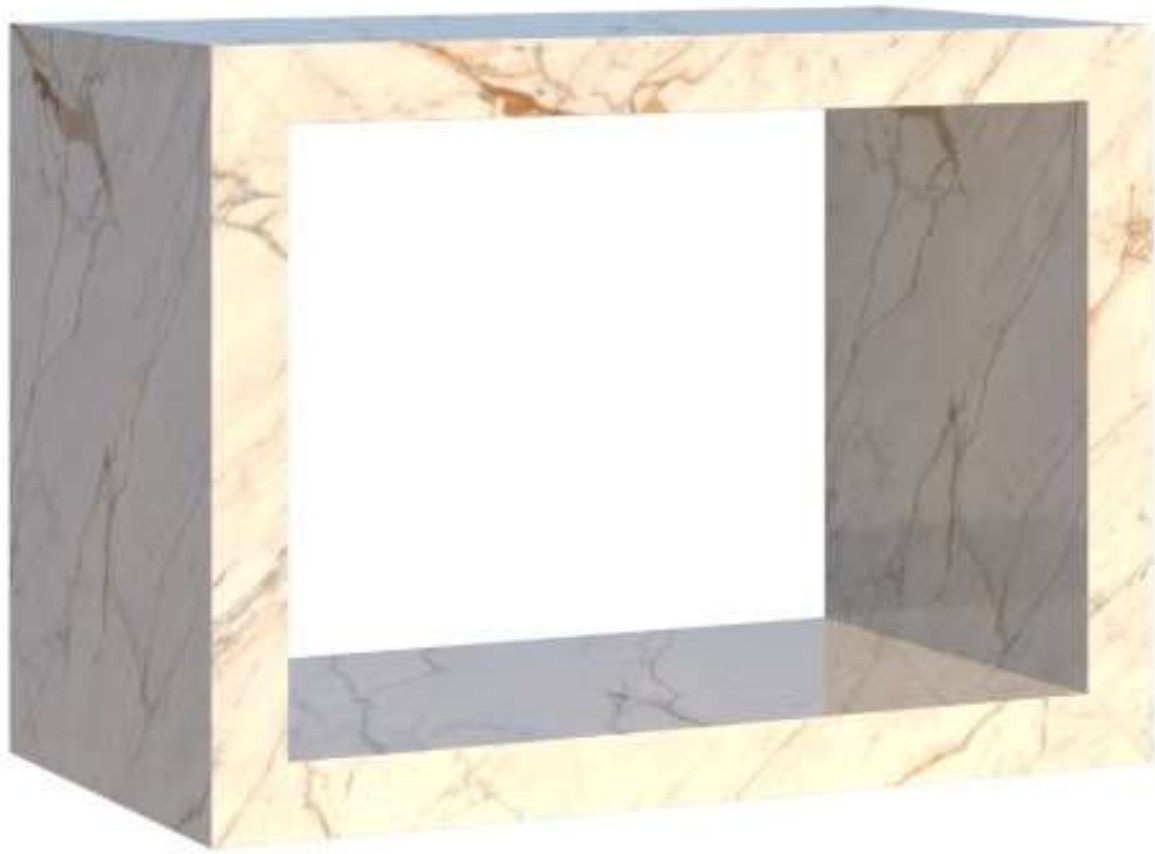

Product: Side table *Dipinto*  
Material: Marazzi Golden White - LUX  
Code: STDCGWL

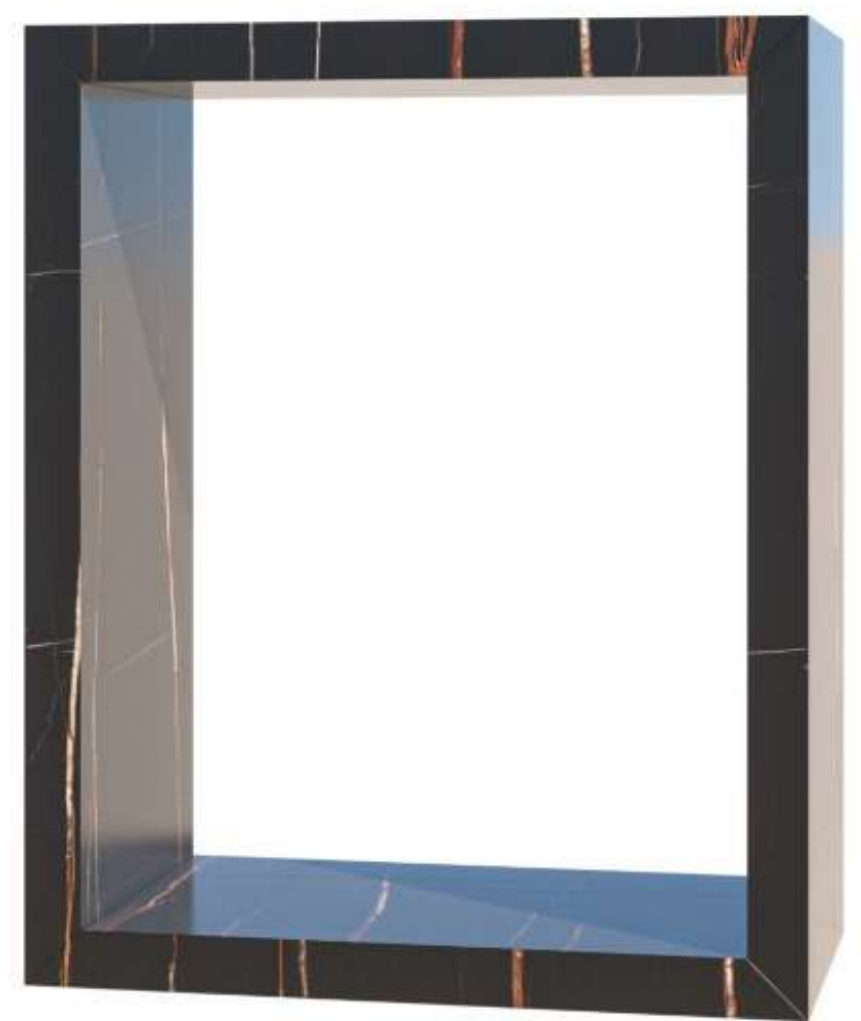
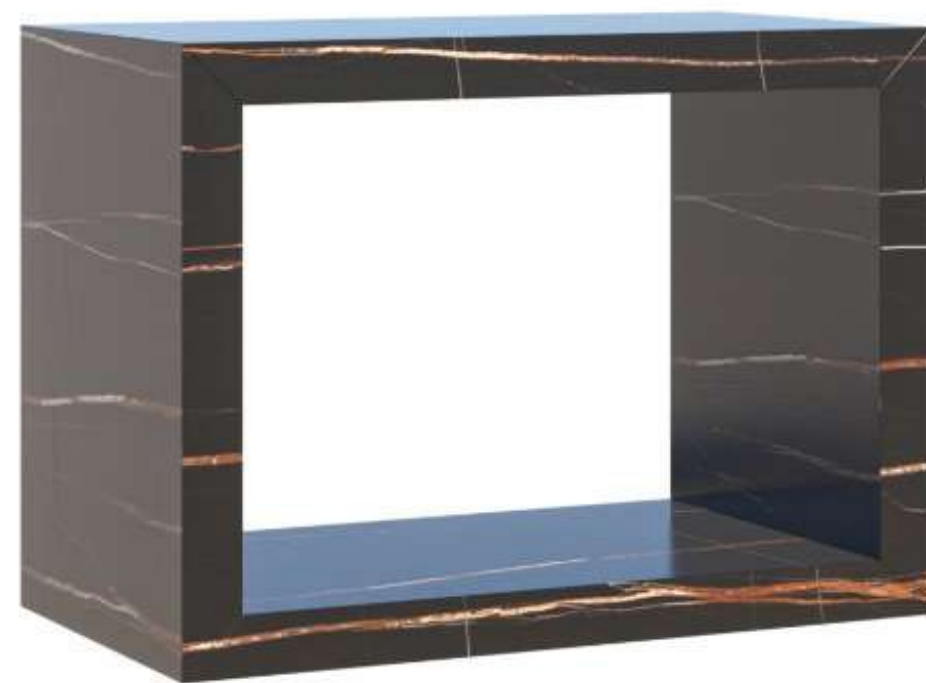

Product: Side table *Dipinto*  
Material: Marazzi Sahara Noir - SATIN  
Code: STDCSNS

## STONE FINISHES



*Polished / Sandblasted+brushed / Flamed+brushed*

## DECORS BY MARAZZI



*Statuario / Smoke / Sahara Noir*



*Golden White / Saint Laurent / Grigio Carico*

# PRODUCT DIMENSIONS

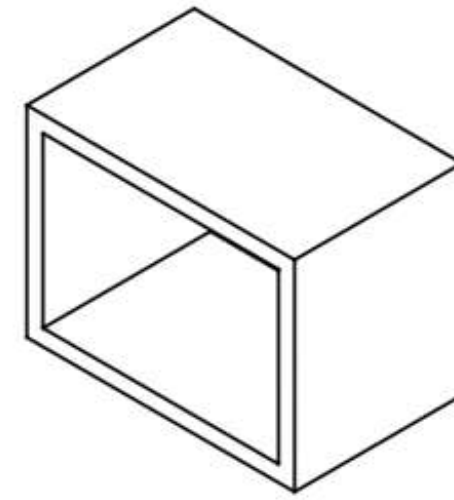
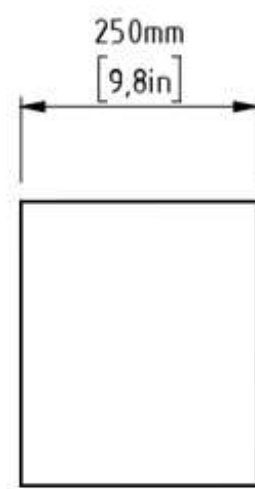
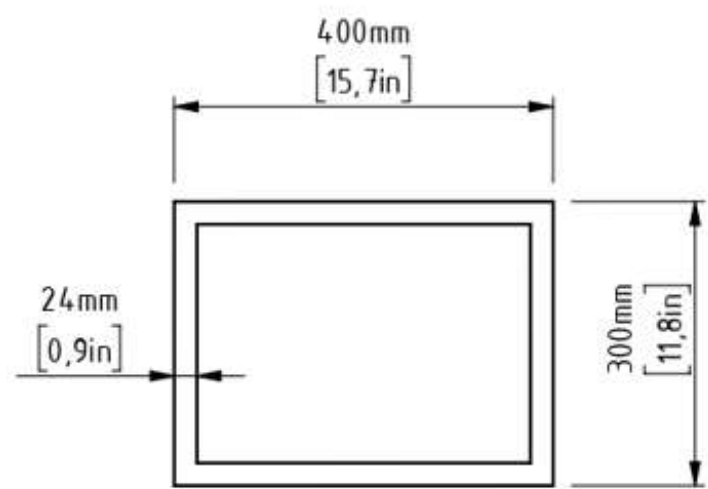

CERAMICS

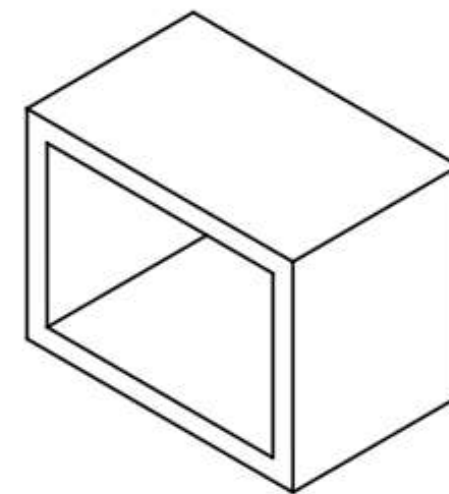
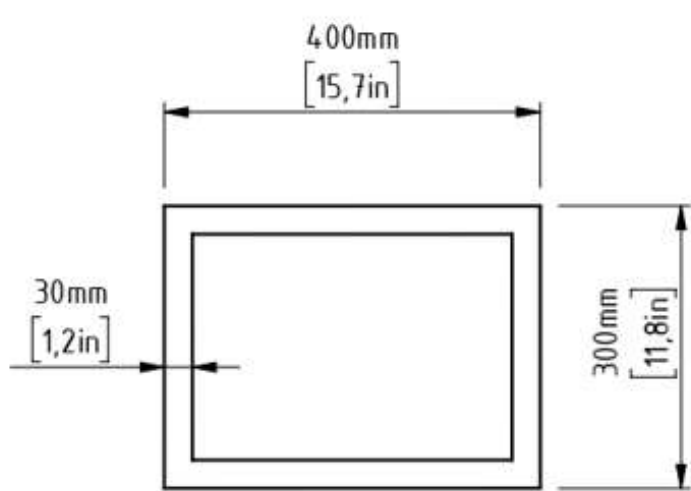

STONE





Product: Custom made Side table *Dipinto* / Coffee table *Ponte*  
Material: Avorio - polished  
Code: STDAP / CTPAP

CARA



Cara is a product line of planters available in two different shapes, perfectly matching the rest of the KORTA collections. As standalone elements, they are used to make a minimalist design statement.





Product: Planter *Cara*  
Material: Kanfanar - polished  
Code: PCSPO/PCSPI

# STONE FINISHES



*Polished / Sandblasted+brushed / Flamed+brushed*

## DECORS BY MARAZZI



*Statuario / Smoke / Sahara Noir*



*Golden White / Saint Laurent / Grigio Carico*

# PRODUCT DIMENSIONS

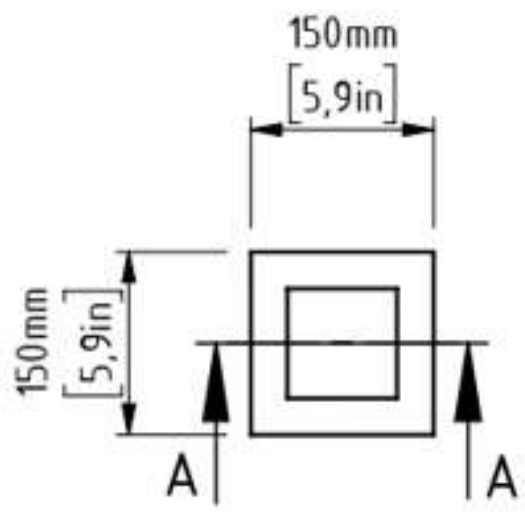

SECTION A-A

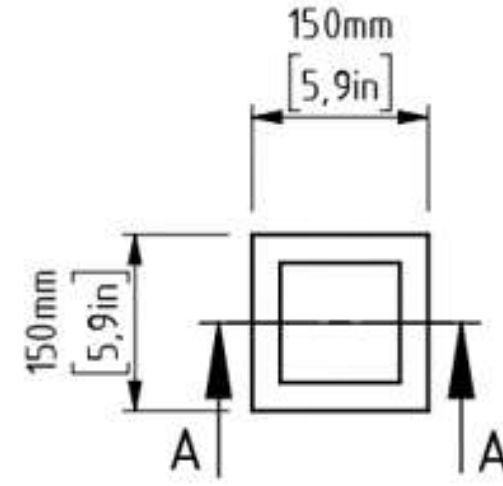

SECTION A-A

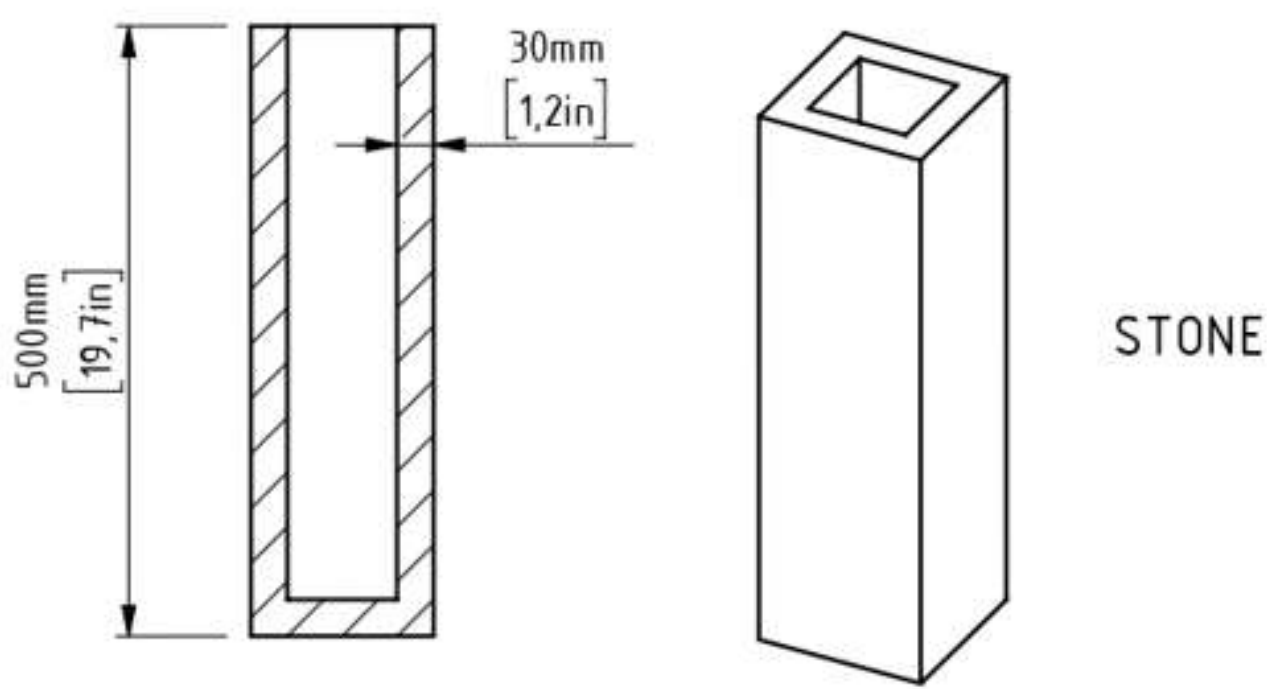

STONE

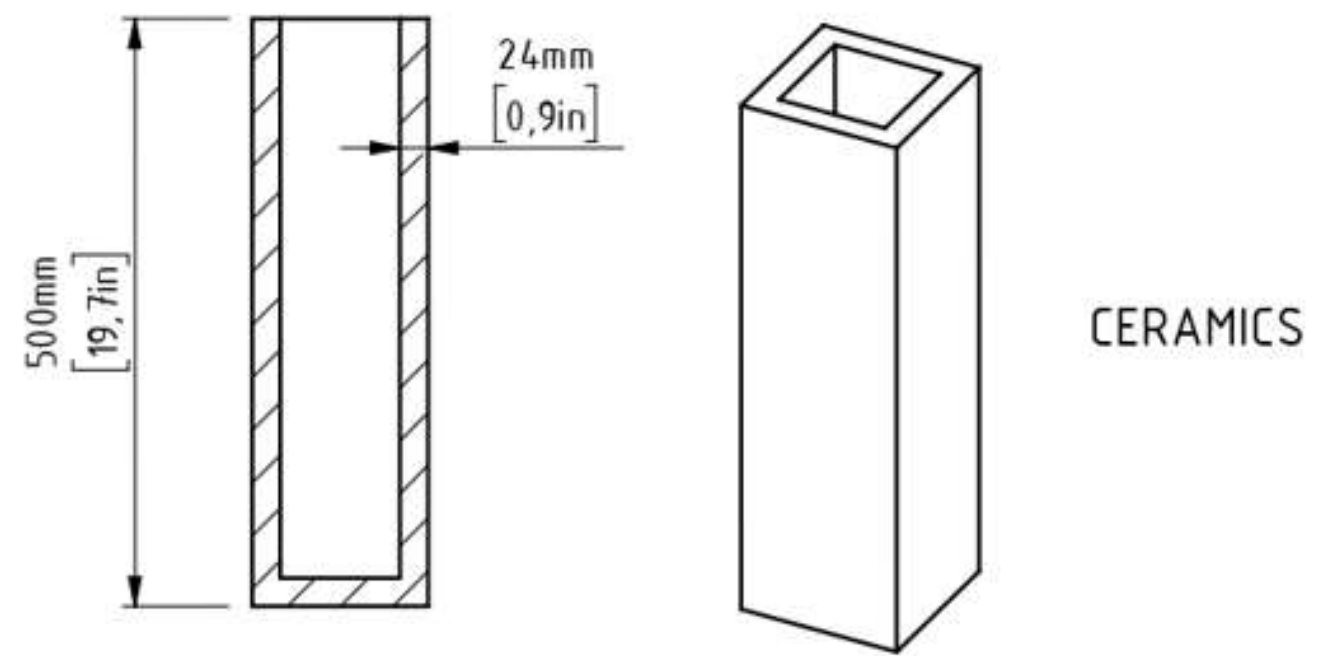

CERAMICS

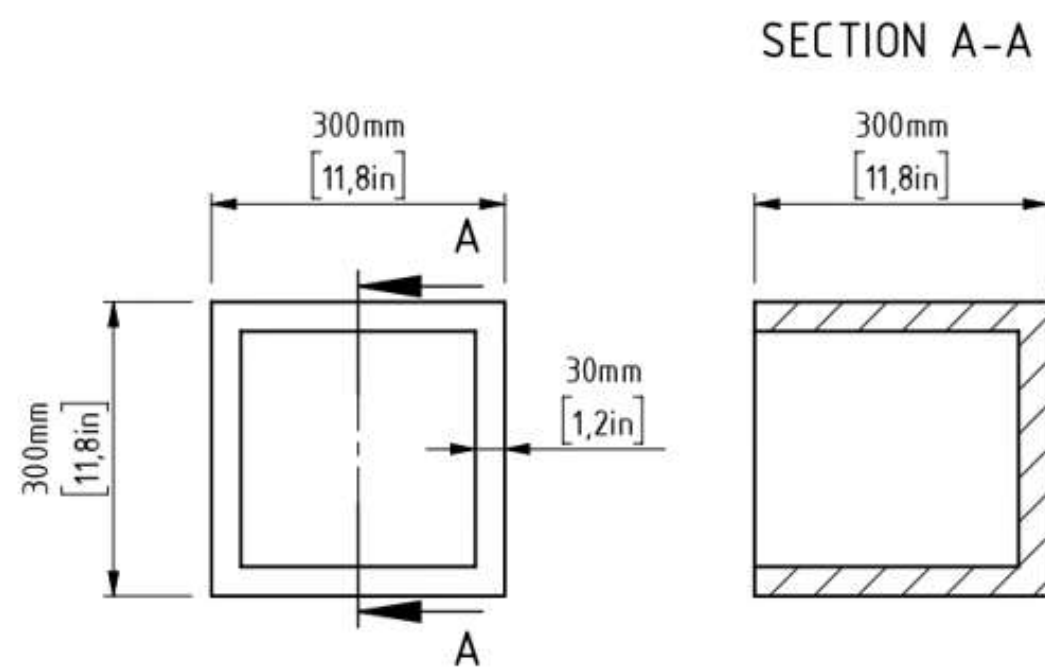

SECTION A-A

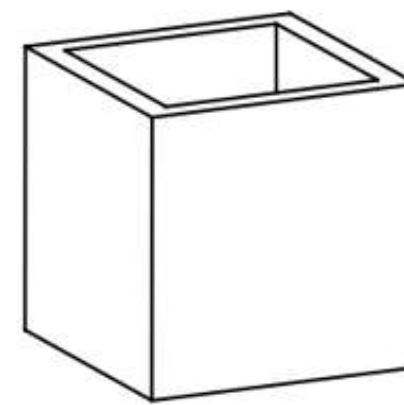
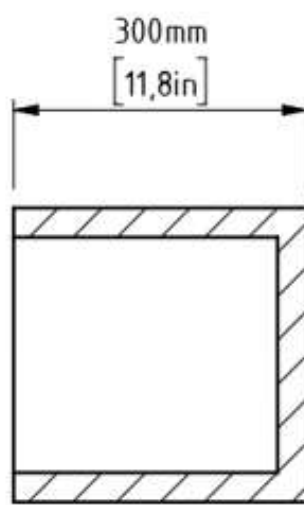

STONE

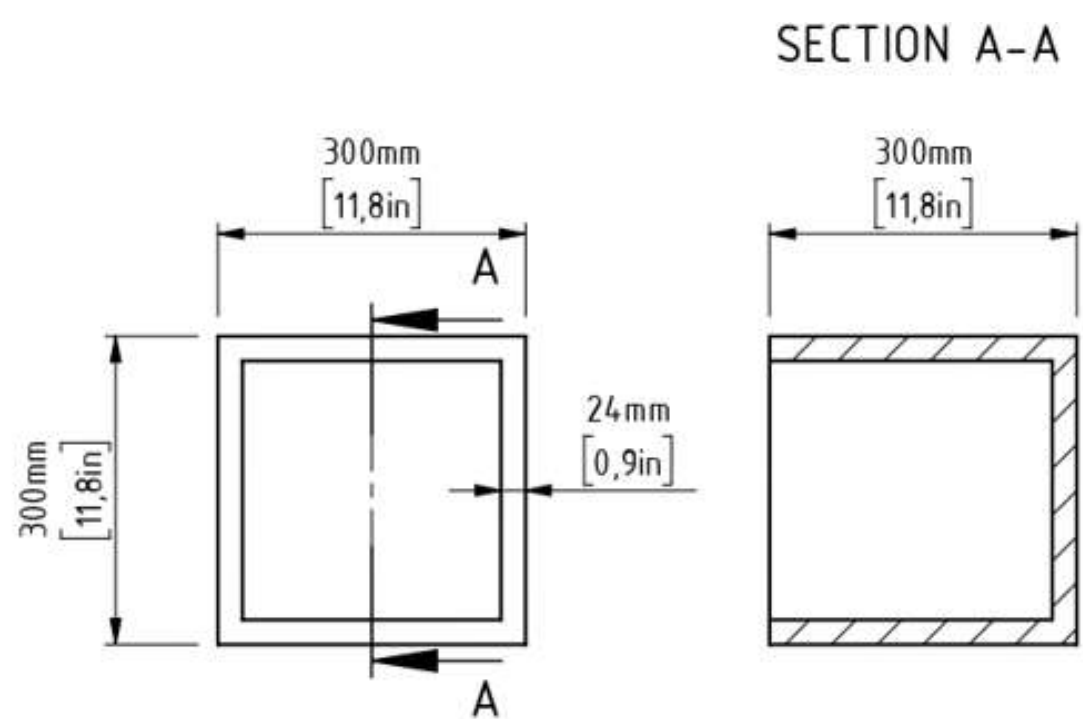

SECTION A-A

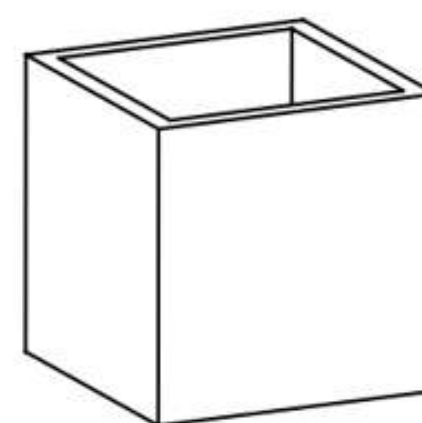
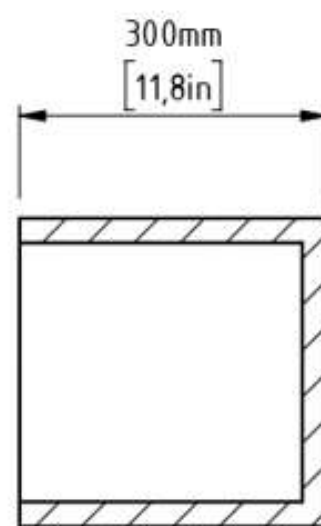

CERAMICS





DESIGNER'S HUB

Creating unique pieces, playing with materials, all with the aim of cultivating a timeless and harmoniously balanced design.



Unleash your creativity on the blank pages ahead as you join forces with us and our products, sketching your visionary projects that will pave the way for collaborative masterpieces. Capture your designs and share them with us by scanning the provided QR code, allowing us to embark on an artistic journey together, bringing your ideas to life in stunning harmony.





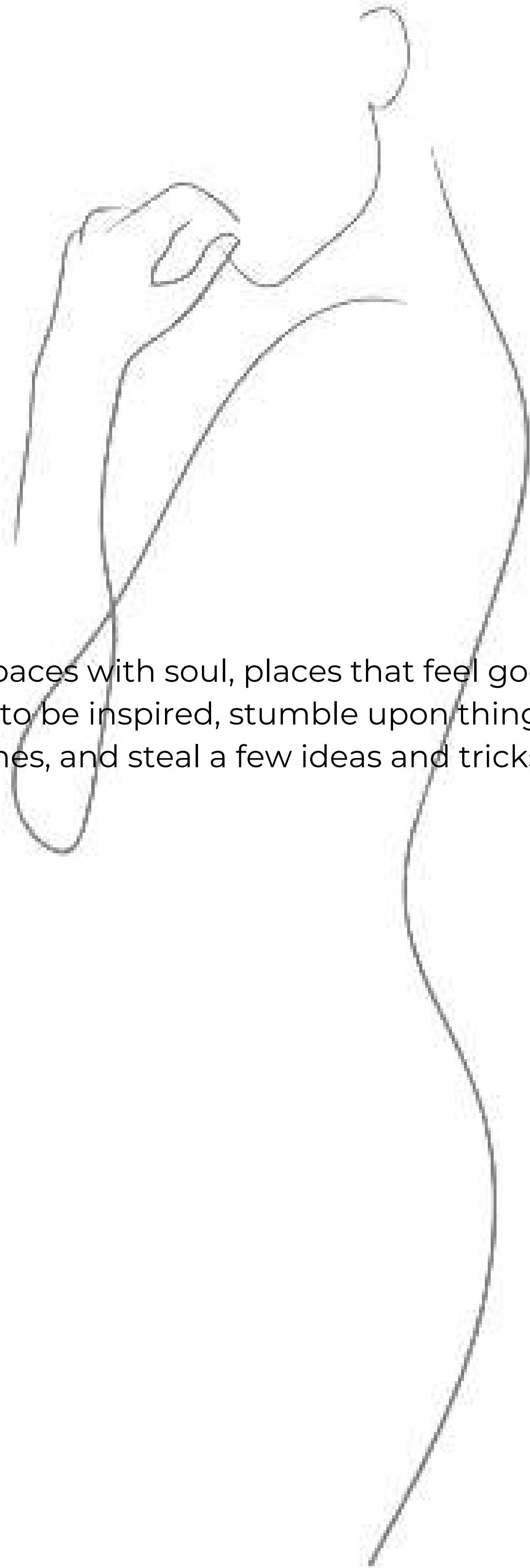

If you love to create spaces with soul, places that feel good to be in, let this be a place you can come to be inspired, stumble upon things that you love, crank some good tunes, and steal a few ideas and tricks along the way.

# SPECIFICATION SHEETS

## SPECIFICATION FEATURES - MARBELLA

### Shower System

Consists of:

- 4 flexible knitted hose ½"
- 2-way mixing mechanism with faucet and handle designed by Mariner Rubinetterie
- Ecotech shower head by Mariner Rubinetterie which enables water savings of up to 50 %
- The informed Nattura S shower catalyst which has beneficial well being effects

This basic system is subject to change depending on chosen additions.

### Water Pressure

- Min = 2 bar    29 PSI [lb/in<sup>2</sup>]
- Max = 4 bar    58 PSI [lb/in<sup>2</sup>]

### Operating Voltage

- 24VDC

### Maintenance

Regularly clean with soft cloth.

### Usage

- Outdoor/Indoor

### Delivery Box Dimensions & Weight

- 2533 x 1068 x 740 mm    100 x 42 x 29 in (Length x Height x Width)
- 33 kg / 73 lbs

### Warranty

3 years warranty regarding defects in material and shower system.

### IPX4 degree of protection

### Foundation Type:

2 options for shower installation:

- Existing floor, floor covering and drain - installation using chemical dowel and anchor bolts
- On site foundation pouring with inlaid plate and threaded anchor rods



## SPECIFICATION FEATURES - ODINO

### Shower System

Consists of:

- 4 flexible knitted hose ½"
- 2-way mixing mechanism with faucet and handle designed by Mariner Rubinetterie
- Ecotech shower head by Mariner Rubinetterie which enables water savings of up to 50 %
- The informed Nattura S shower catalyst which has beneficial well being effects

This basic system is subject to change depending on chosen additions.

### Water Pressure

- Min = 2 bar    29 PSI [lb/in<sup>2</sup>]
- Max = 4 bar    58 PSI [lb/in<sup>2</sup>]

### Operating Voltage

- 24VDC

### Maintenance

Regularly clean with soft cloth.

### Usage

- Outdoor

### Delivery Box Dimensions & Weight

- 2533 x 1600 x 710 mm    100 x 63 x 28 in (Length x Height x Width)
- 67 kg / 148 lbs

### Warranty

3 years warranty regarding defects in material and shower system.

### IPX4 degree of protection

### Foundation Type:

Shower installation:

- Existing floor, floor covering and drain - installation using chemical dowel and anchor bolts,

## SPECIFICATION FEATURES - MINIMO

### Shower System

Consists of:

- 4 flexible knitted hose ½"
- 2-way mixing mechanism with faucet and handle designed by Mariner Rubinetterie
- Ecotech shower head by Mariner Rubinetterie which enables water savings of up to 50 %
- The informed Nattura S shower catalyst which has beneficial well being effects

This basic system is subject to change depending on chosen additions.

### Water Pressure

- Min = 2 bar    29 PSI [lb/in<sup>2</sup>]
- Max = 4 bar    58 PSI [lb/in<sup>2</sup>]

### Operating Voltage

- 24VDC

### Maintenance

Regularly clean with soft cloth.

### Usage

- Outdoor/Indoor

### Delivery Box Dimensions & Weight

- 2533 x 1068 x 740 mm    100 x 42 x 29 in (Length x Height x Width)
- 29 kg / 73 lbs

### Warranty

3 years warranty regarding defects in material and shower system.

### IPX4 degree of protection

### Foundation Type:

2 options for shower installation:

- Existing floor, floor covering and drain - installation using chemical dowel and anchor bolts
- On site foundation pouring with inlaid plate and threaded anchor rods

CODES &  
PRODUCTION  
TIME

Product category	Name	Material	Processing	Code	Delivery time
Outdoor shower	Minimo	Kanfanar	Polished	MINSP	4 weeks
Outdoor shower	Minimo	Kanfanar	Sandblasted+brushed	MINSSB	4 weeks
Outdoor shower	Minimo	Kanfanar	Flammed+brushed	MINSFB	10 weeks
Outdoor shower	Minimo	Marazzi	Statuario SATIN	MINCSS	2-10 weeks
Outdoor shower	Minimo	Marazzi	Smoke NAT	MINCSN	2-10 weeks
Outdoor shower	Minimo	Marazzi	Sahara Noir SATIN	MINCSNS	2-10 weeks
Outdoor shower	Minimo	Marazzi	Golden White LUX	MINCGWL	2-10 weeks
Outdoor shower	Minimo	Marazzi	Saint Laurent SATIN	MINCSLS	2-10 weeks
Outdoor shower	Minimo	Marazzi	Grigio Carico SAT	MINCGCS	2-10 weeks
Outdoor shower	Marbella	Kanfanar	Polished	MARSP	4 weeks
Outdoor shower	Marbella	Kanfanar	Sandblasted+brushed	MARSSB	4 weeks
Outdoor shower	Marbella	Kanfanar	Flammed+brushed	MARSFB	10 weeks
Outdoor shower	Marbella	Marazzi	Statuario SATIN	MARCSS	2-10 weeks
Outdoor shower	Marbella	Marazzi	Smoke NAT	MARCSN	2-10 weeks
Outdoor shower	Marbella	Marazzi	Sahara Noir SATIN	MARCSNS	2-10 weeks
Outdoor shower	Marbella	Marazzi	Golden White LUX	MARCGWL	2-10 weeks
Outdoor shower	Marbella	Marazzi	Saint Laurent SATIN	MARCSLS	2-10 weeks
Outdoor shower	Marbella	Marazzi	Grigio Carico SAT	MARCGCS	2-10 weeks
Outdoor shower	Odino	Kanfanar	Polished	ODSP	6 weeks
Outdoor shower	Odino	Kanfanar	Sandblasted+brushed	ODSSB	6 weeks
Outdoor shower	Odino	Kanfanar	Flammed+brushed	ODSFB	12 weeks
Outdoor shower	Odino	Marazzi	Statuario SATIN	ODCSS	4-12 weeks
Outdoor shower	Odino	Marazzi	Smoke NAT	ODCSS	4-12 weeks
Outdoor shower	Odino	Marazzi	Sahara Noir SATIN	ODCSN	4-12 weeks
Outdoor shower	Odino	Marazzi	Golden White LUX	ODCWL	4-12 weeks
Outdoor shower	Odino	Marazzi	Saint Laurent SATIN	ODCSLS	4-12 weeks
Outdoor shower	Odino	Marazzi	Grigio Carico LUX	ODCGCS	4-12 weeks

Additions	Available for	Material	Processing	Code	Delivery time
Motion Sensor	All showers	Stainless Steel	Brushed	MS	1 week
Heating Cable	All showers	N/A	N/A	HC	4 weeks
Logo Engraving	All showers	N/A	N/A	LE	2 weeks
Water Tank	Only dark colours	Stainless Steel	Polished	WT	4-6 weeks
Lighting	Marbella and Odino	Stainless Steel	Polished	L	2 weeks
Floor Decking	Odino	Thermal Ash	N/A	FD	4-6 weeks
XL Showerhead	Odino	Stainless Steel	Brushed	XLS	6-10 weeks
Shower Handle	All showers	Stainless Steel	Brushed	SH	6-8 weeks

Product category	Name	Material	Processing	Code	Delivery time
Kada	Latia	Kanfanar	Brushed	KLATIASB	10-12 weeks
Kada	Enea	Kanfanar	Brushed	KENEASB	10-12 weeks
Kada	Ania	Kanfanar	Brushed	KANIASB	10-12 weeks
Kada	Gaia	Kanfanar	Brushed	KGAIASB	10-12 weeks
Kada	Luce	Kanfanar	Brushed	KLUCESB	10-12 weeks
Kada	Mena	Kanfanar	Brushed	KMENASB	10-12 weeks

Product category	Model	Name	Back type	Code	Delivery time
Outdoor kitchen	Robusta	Compatto 75	Flat back	ROKC75	10-12 weeks
Outdoor kitchen	Robusta	Medio 75	Flat back	ROKM75	10-12 weeks
Outdoor kitchen	Robusta	Grande 75	Flat back	ROKG75	10-12 weeks
Outdoor kitchen	Elegante	Compatto 80	Wall adjacent	ROKEC80	10-12 weeks
Outdoor kitchen	Elegante	Compatto 90	Island	ROKEC90	10-12 weeks
Outdoor kitchen	Elegante	Medio 80	Wall adjacent	ROKEM80	10-12 weeks
Outdoor kitchen	Elegante	Medio 90	Island	ROKEM90	10-12 weeks
Outdoor kitchen	Elegante	Medio 120	Island	ROKEM120	10-12 weeks
Outdoor kitchen	Elegante	Grande 80	Wall adjacent	ROKEG80	10-12 weeks
Outdoor kitchen	Elegante	Grande 90	Island	ROKEG90	10-12 weeks
Outdoor kitchen	Elegante	Grande 120	Island	ROKEG120	10-12 weeks

Frame colour	Top and side option	Door inlay options	Appliance options
Black - CIE	Kanfanar Polished - SP	European Oak - DUB	Big Green Egg L - BGEL
Anthracite - ANT	Nero Assoluto - NA	Brazil Nut - IPE	Indu + Gazzgrill - IG
Grey - SIV	Marazzi Golden White - GW	Siberian Larch - SIB	Caso BBQ Coer - CHLD
Mocha - MOK		Laminate - HPL	Rubbish Bins - RB
Latte - LAT			

Product category	Name	Material	Processing	Code	Delivery time
Outdoor fire pit	Kamin	Kanfanar	Polished	KAMSP	8-10 weeks
Outdoor fire pit	Kamin	Kanfanar	Sandblasted+brushed	KAMSSB	8-10 weeks
Outdoor fire pit	Kamin	Kanfanar	Flammed + brushed	KAMSFB	10-12 weeks
Coffee Table	Ponte L/XL	Kanfanar	Polished	CTPLSP/CTPXLSP	2-4 weeks
Coffee Table	Ponte L/XL	Kanfanar	Sandblasted+brushed	CTPLSSB/CTPXLSSB	2-4 weeks
Coffee Table	Ponte L/XL	Kanfanar	Flammed + brushed	CTPLSFB/CTPXLFB	2-4 weeks
Coffee Table	Ponte L/XL	Marazzi	Statuario SATIN	CTPLCSS/CTPXLCS	2-10 weeks
Coffee Table	Ponte L/XL	Marazzi	Smoke NAT	CTPLCSN/CTPXLCSN	2-10 weeks
Coffee Table	Ponte L/XL	Marazzi	Sahara Noir SATIN	CTPLCSNS/CTPXLCSNS	2-10 weeks
Coffee Table	Ponte L/XL	Marazzi	Golden White LUX	CTPLCGWL/CTPXLCGWL	2-10 weeks
Coffee Table	Ponte L/XL	Marazzi	Saint Laurent SATIN	CTPLCSLS/CTPXLCSLS	2-10 weeks
Coffee Table	Ponte L/XL	Marazzi	Grigio Carico SAT	CTPLCGCS/CTPXLCGCS	2-10 weeks
Side table	Dipinto	Kanfanar	Polished	STDSP	2-4 weeks
Side table	Dipinto	Kanfanar	Sandblasted+brushed	STDSSB	2-4 weeks
Side table	Dipinto	Kanfanar	Flammed + brushed	STDSFB	2-4 weeks
Side table	Dipinto	Marazzi	Statuario SATIN	STDCSS	2-10 weeks
Side table	Dipinto	Marazzi	Smoke NAT	STDCSN	2-10 weeks
Side table	Dipinto	Marazzi	Sahara Noir SATIN	STDCSNS	2-10 weeks
Side table	Dipinto	Marazzi	Golden White LUX	STDCGWL	2-10 weeks
Side table	Dipinto	Marazzi	Saint Laurent SATIN	STDCSLS	2-10 weeks
Side table	Dipinto	Marazzi	Grigio Carico SAT	STDCGCS	2-10 weeks
Planter	Cara I/O	Kanfanar	Polished	PCISP/PCOSP	2-4 weeks
Planter	Cara I/O	Kanfanar	Sandblasted+brushed	PCISSB/PCOSSB	2-4 weeks
Planter	Cara I/O	Kanfanar	Flammed + brushed	PCISFB/PCOSFB	2-4 weeks
Planter	Cara I/O	Marazzi	Statuario SATIN	PCICSS/PCOCSS	2-10 weeks
Planter	Cara I/O	Marazzi	Smoke NAT	PCICSN/PCOCSN	2-10 weeks
Planter	Cara I/O	Marazzi	Sahara Noir SATIN	PCICSNS/PCOCSNS	2-10 weeks
Planter	Cara I/O	Marazzi	Golden White LUX	PCICGWL/PCOCGWL	2-10 weeks
Planter	Cara I/O	Marazzi	Saint Laurent SATIN	PCICSL/PCOCSL	2-10 weeks
Planter	Cara I/O	Marazzi	Grigio Carico SAT	PCICGCS/PCOCGCS	2-10 weeks

-

CERTIFICATES



### Certificate of Conformity

Number: C211-0050/21 Project file: C20212197

Product: Shower with led light

Type reference: MARBELLA

Trademark: INFINITY LUXURY

Applicant: Infinity Luxury d.o.o.  
Stancija Pataj 52A, Bertoši, HR-52000 Pazin, Croatia

Manufacturer: Infinity Luxury d.o.o.  
Stancija Pataj 52A, Bertoši, HR-52000 Pazin, Croatia

Place of manufacture: Infinity Luxury d.o.o.  
Stancija Pataj 52A, Bertoši, HR-52000 Pazin, Croatia

This certificate is granted subject to the SIQ's rules on product certification. SIQ certifies the conformity of the products with the requirements of the listed standards.

Ratings: 220-240 V-; IPX4; 5 W; class II

Standard: EN 60335-2-105:2005 + A1:2008 + A11:2010 + A2:2020  
EN 60335 1:2012 + A11:2014 + A13:2017 + A1:2019 + A14:2019 + A2:2019

Test report: T211-0902/21 (2021-09-30)

Remarks: This certificate shall apply to the products identical to the tested sample and shall remain valid for the period of 3 years until 2024-10-29 or until the validity date of the listed standards, whichever occurs earlier.

Date: 2021-10-29 Authorized signature: Bojan Pečavar



Only integral publication of this certificate is allowed. This certificate may only be reproduced in its entirety and without any changes. On request SIQ will give information about the validity of the certificate.

SIQ Ljubljana, Mašera-Spasičeva ulica 10, SI-1000 Ljubljana, Slovenia  
T +386 1 4778 100, F +386 1 4778 444, info@siq.si, www.siq.si

CH000E-01

World Intellectual Property Office  
34, chemin des Colombettes  
P.O. Box 18  
CH - 1211 Geneva  
Switzerland

### HAGUE AGREEMENT CONCERNING THE INTERNATIONAL REGISTRATION OF INDUSTRIAL DESIGNS

#### - STATEMENT OF GRANT OF PROTECTION -

#### Rule 18bis(1) of the Common Regulations

I. Office sending the statement:	The Norwegian Industrial Property Office PO Box 4863 Nydalen, N-0422 Oslo website: <a href="http://www.patentstyret.no">www.patentstyret.no</a>	Telephone + 47 22 38 73 00 Telefax + 47 22 38 73 01 e-mail: <a href="mailto:post@patentstyret.no">post@patentstyret.no</a>
II. Number of the international registration:	DM/213763	
III. <input checked="" type="checkbox"/> Protection is (to be) granted for all the industrial designs <input type="checkbox"/> Protection is (to be) granted for the following industrial designs: (followed by design numbers)		
IV. Date on which the international registration produced or shall produce the effect as a grant of protection under the applicable law (in respect of the industrial designs indicated under item III):	2021.03.31	
V. Date of the statement:	2021.06.06	
VI. Signature or official seal of the Office sending the statement:	THE NORWEGIAN INDUSTRIAL PROPERTY OFFICE Sabrina Fregosi	



World Intellectual Property Office  
34, chemin des Colombettes  
P.O. Box 18  
CH - 1211 Geneva  
Switzerland

Date: 06/06/2021

The product "MARBELLA" outdoor shower, made by the company Infinity Luxury d.o.o., has the industrial design protected. It is protected under the code: DM/213763, by the World Intellectual Property Organization or the European Union Intellectual Property Office (World Intellectual Property Organization - WIPO or the European Union Intellectual Property Office - EUIPO).



### DECLARATION OF PERFORMANCE No 0008

- Unique identification code of the product-type: **SUPERFLEX**
- Intended use/es:  
**Improved reaction resin adhesive for all internal and external tiling.**
- Manufacturer: **Kerakoll S.p.A Via dell'Artigianato, 9 - 41049 Sassuolo (MO) Italia**
- System/s of AVCP:  
**System 3**  
**System 3 for reaction to fire**
- Harmonised standard: **EN 12004:2007 + A1:2012**  
Notified body/ies: **Modena Centro Prove No. 1599**  
**Istituto Giordano No. 0407**
- Declared performance/s:

Essential characteristics	Performance
<b>Reaction to fire</b>	<b>Class B-s1,d0/B1-s1</b>
<b>Bond strength as: initial shear adhesion strength</b>	<b>≥ 2,0 N/mm²</b>
<b>Durability for: shear adhesion strength after thermal shock shear adhesion strength after water immersion</b>	<b>≥ 2,0 N/mm²</b> <b>≥ 2,0 N/mm²</b>
<b>Release of dangerous substances</b>	<b>See SDS</b>

The performance of the product identified above is in conformity with the set of declared performance/s. This declaration of performance is issued, in accordance with Regulation (EU) No 305/2011, under the sole responsibility of the manufacturer identified above.

Signed for and on behalf of the manufacturer by: **Romano Sghedoni (legal representative)**  
At Sassuolo, on 07/05/2020



[www.kerakoll.com](http://www.kerakoll.com)

KERAKOLL Spa - Soggetta a direzione e coordinamento di Fin-Firel Spa  
via dell'Artigianato, 9 - 41049 Sassuolo (MO) Italia - Tel +39 0536 816 511 - Fax +39 0536 816 581 - e-mail: [info@kerakoll.com](mailto:info@kerakoll.com)  
Rea MO n. 231812 - Reg. Imp. / Cod. Fisc. / P. Iva IT 01174510360 - Cap. Soc. € 2.000.000,00 i.v.

EN.IT.0008.004







# OTHER MATERIALS

made upon request

# MARBLE - GRANITE

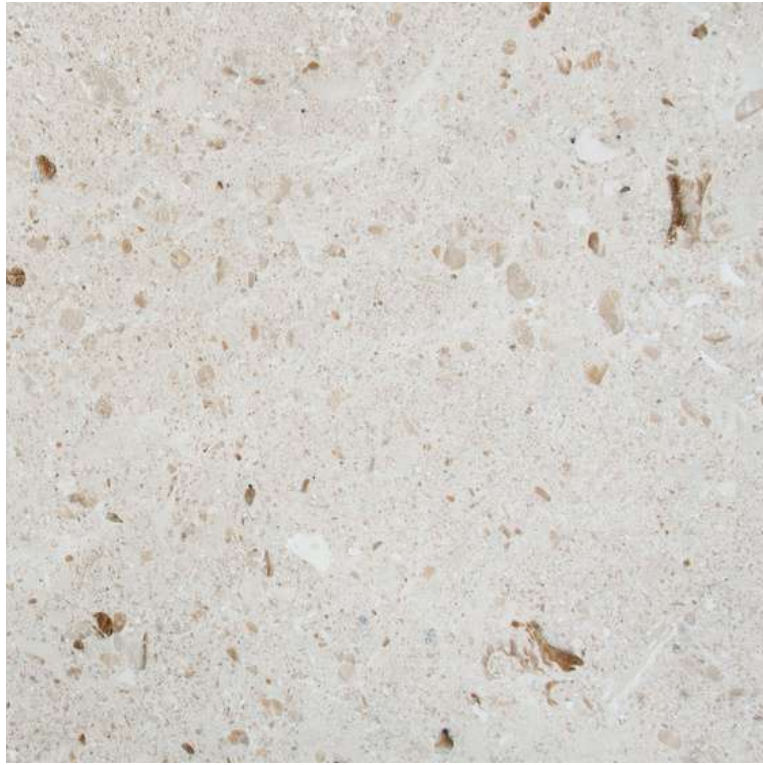

Plano Polished



Rigato



Grigio Ardesio



Giallo Siena



Moncervetto

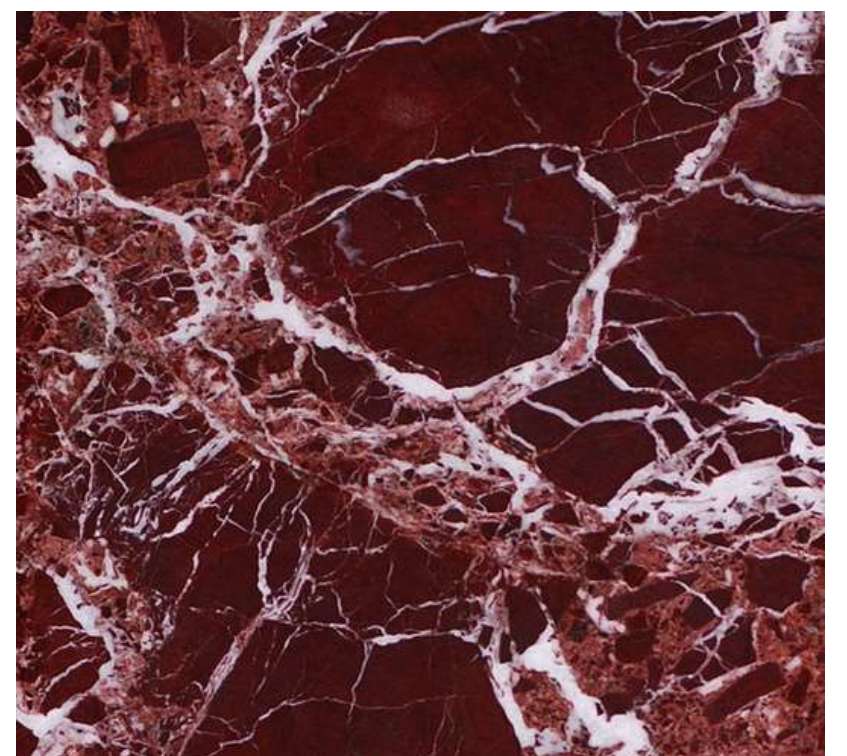

Rosso Levanto



Portoro

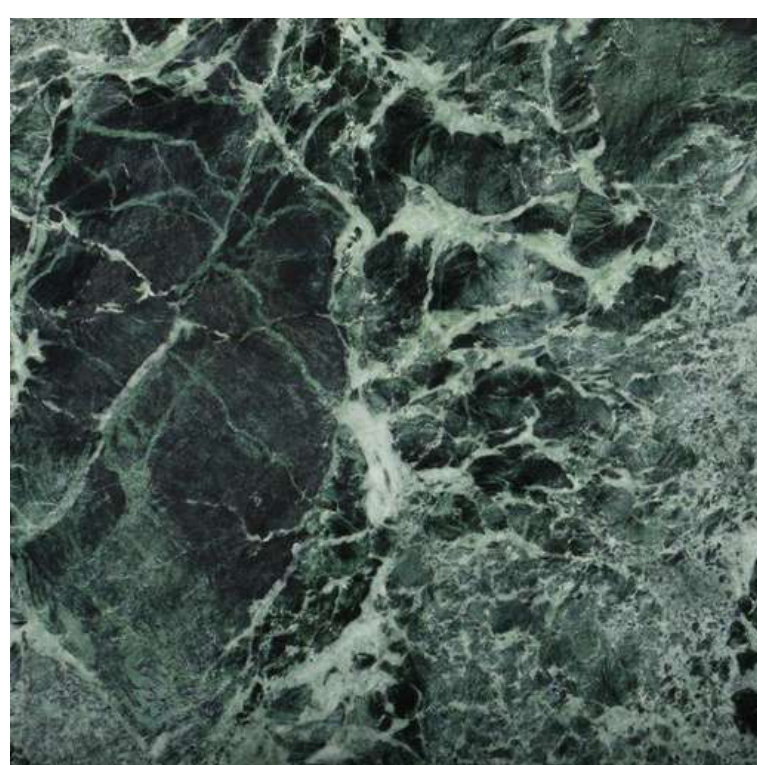

Verde Alpi



Nero Assoluto

# PORCELAIN SLABS -



Brera Grey



Bianco Arni



Capraia



Ceppo di Gré



Imperiale



Elegant Black



Limestone Sand



Terrazzo Grey



Verde Borgogna



Travertino Classico



Quartzo Bluegray

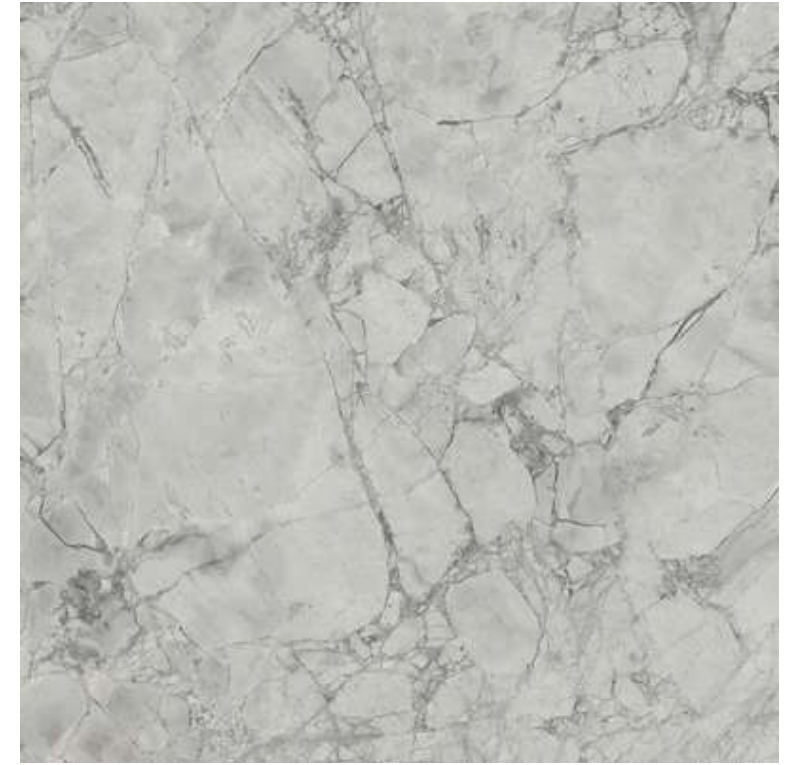

Superwhite



Onice Nero



Fior di Pesco Carnico

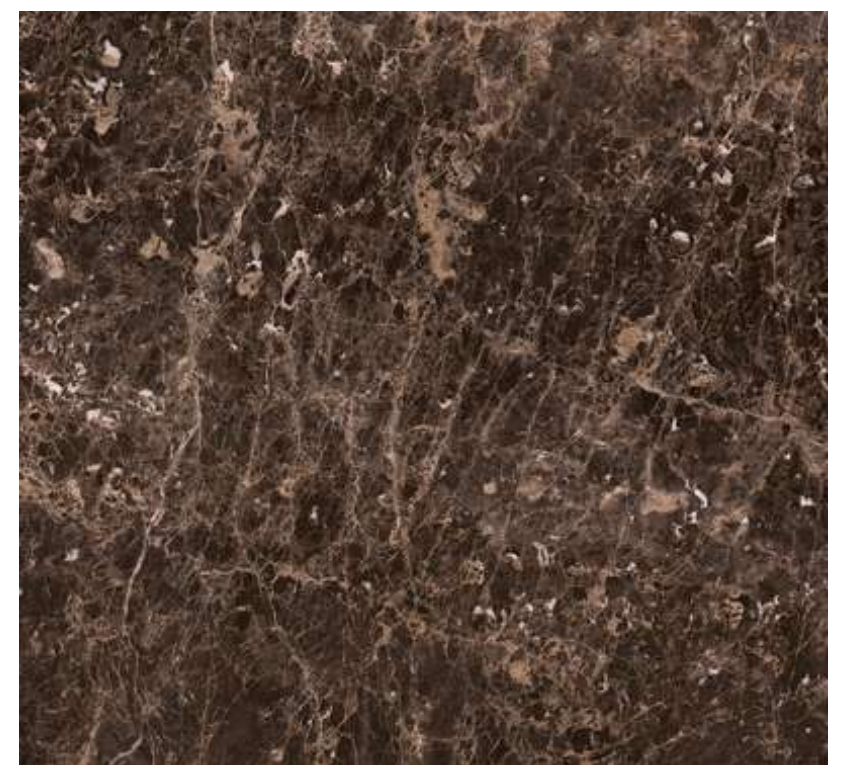

Emperador



Calacatta Vena Vecchia



Calacatta Extra



Calacatta Black



This is how it all started..

MADE IN ISTRIA, LOVED WORLDWIDE.



Europe: Spain, Germany, Austria, Italy, Croatia, Montenegro, The Netherlands, Belgium, Poland, Czech Republic, Greece, France, Malta, Slovakia, Portugal

USA: Florida, New York, Massachusetts, New Jersey

World: Middle East, Australia, New Zealand, China, Caribbean, Colombia

...And this is where we are now.

INFINITY LUXURY D.O.O.

+385 52 743 776

[info@kortadesign.com](mailto:info@kortadesign.com)

[www.kortadesign.com](http://www.kortadesign.com)