

MATERIAL	FINISH	COLOR	DIMENSION	QUANTITIES
<input type="checkbox"/> 24 GA. GALV.	<input type="checkbox"/> KYNAR		A=	LINEAL FT.
<input type="checkbox"/> .032 ALUMIN.	<input type="checkbox"/> MILL FINISH			OUTSIDE MITERS @ DEG.
<input type="checkbox"/> 16 OZ COPPER	<input type="checkbox"/> ENAMEL			INSIDE MITERS @ DEG.
<input type="checkbox"/> 20 OZ COPPER	<input type="checkbox"/> ANODIZED		HEM <input type="checkbox"/> YES	
<input type="checkbox"/> 16 OZ LCC	<input type="checkbox"/> OTHER		<input type="checkbox"/> NO	
<input type="checkbox"/> 20 OZ LCC				
<input type="checkbox"/> 26 GA STAINLESS				

PROJECT:	FABRICATION WILL PROCEED ONLY AFTER RECEIPT OF SIGNED DRAWING APPROVAL DRAWING APPROVAL ARCHITECT AND /OR CONTRACTOR SHALL VERIFY ALL DIMENSIONS, SIZES AND QUANTITIES. ALL PRODUCTS TO BE INSTALLED IN STRICT ACCORDANCE WITH FAIRFIELD METAL'S PRINTED INSTRUCTIONS. APPROVED BY _____ DATE _____
ARCHITECT:	
ROOFING CONTRACTOR:	
REPRESENTATIVE:	

 Fairfield Metal 9 Audrey Place, Fairfield, NJ 07004 Phone: 973-276-8440 www.fairfieldmetal.com	Drawing Title: SLIP FLASHING	Drawing No. RF-001
	Drawn By: MD	Date: 05.04.2015

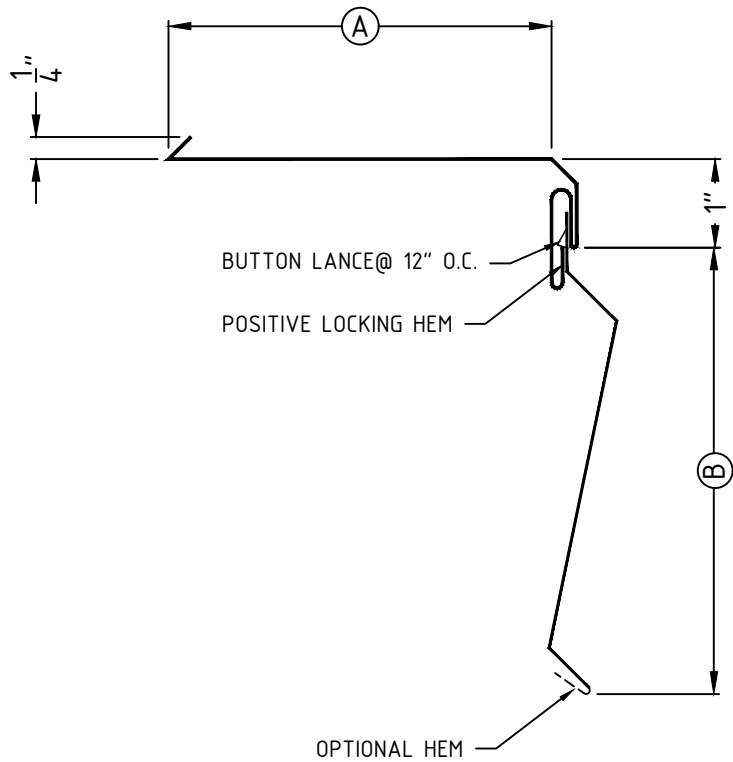

MATERIAL	FINISH	COLOR	DIMENSION	QUANTITIES
<input type="checkbox"/> 24 GA. GALV.	<input type="checkbox"/> KYNAR		A=	LINEAL FT.
<input type="checkbox"/> .032 ALUMIN.	<input type="checkbox"/> MILL FINISH		B=	OUTSIDE MITERS @ DEG.
<input type="checkbox"/> 16 OZ COPPER	<input type="checkbox"/> ENAMEL			INSIDE MITERS @ DEG.
<input type="checkbox"/> 20 OZ COPPER	<input type="checkbox"/> ANODIZED		HEM <input type="checkbox"/> YES	
<input type="checkbox"/> 16 OZ LCC	<input type="checkbox"/> OTHER		<input type="checkbox"/> NO	
<input type="checkbox"/> 20 OZ LCC				
<input type="checkbox"/> 26 GA STAINLESS				

PROJECT:

ARCHITECT:

ROOFING CONTRACTOR:

REPRESENTATIVE:

FABRICATION WILL PROCEED ONLY AFTER RECEIPT OF SIGNED DRAWING APPROVAL

DRAWING APPROVAL

ARCHITECT AND /OR CONTRACTOR SHALL VERIFY ALL DIMENSIONS, SIZES AND QUANTITIES. ALL PRODUCTS TO BE INSTALLED IN STRICT ACCORDANCE WITH FAIRFIELD METAL'S PRINTED INSTRUCTIONS.

APPROVED BY _____ DATE _____

 <p>Fairfield Metal 9 Audrey Place, Fairfield, NJ 07004 Phone: 973-276-8440 www.fairfieldmetal.com</p>	Drawing Title: REGLET FLASHING 2 PIECE	Drawing No. RF-002
	Drawn By: MD	Date: 05.04.2015

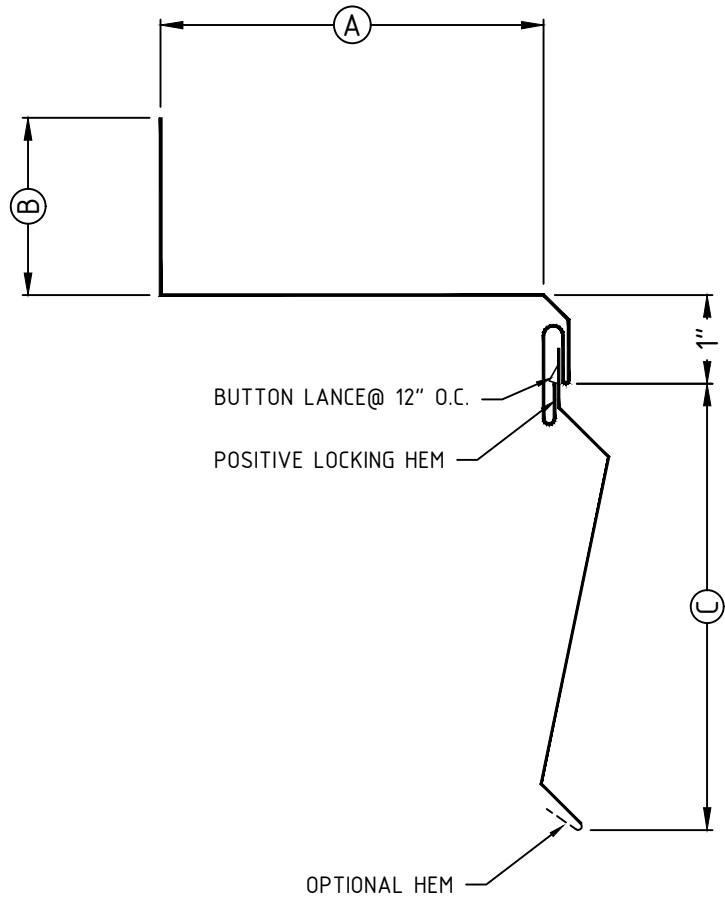

MATERIAL	FINISH	COLOR	DIMENSION	QUANTITIES
<input type="checkbox"/> 24 GA. GALV.	<input type="checkbox"/> KYNAR		A=	LINEAL FT.
<input type="checkbox"/> .032 ALUMIN.	<input type="checkbox"/> MILL FINISH		B=	OUTSIDE MITERS @ DEG.
<input type="checkbox"/> 16 OZ COPPER	<input type="checkbox"/> ENAMEL		C=	INSIDE MITERS @ DEG.
<input type="checkbox"/> 20 OZ COPPER	<input type="checkbox"/> ANODIZED		HEM <input type="checkbox"/> YES	
<input type="checkbox"/> 16 OZ LCC	<input type="checkbox"/> OTHER		<input type="checkbox"/> NO	
<input type="checkbox"/> 20 OZ LCC				
<input type="checkbox"/> 26 GA STAINLESS				

PROJECT: _____

ARCHITECT: _____

ROOFING CONTRACTOR: _____

REPRESENTATIVE: _____

FABRICATION WILL PROCEED ONLY AFTER RECEIPT OF SIGNED DRAWING APPROVAL

DRAWING APPROVAL

ARCHITECT AND /OR CONTRACTOR SHALL VERIFY ALL DIMENSIONS, SIZES AND QUANTITIES. ALL PRODUCTS TO BE INSTALLED IN STRICT ACCORDANCE WITH FAIRFIELD METAL'S PRINTED INSTRUCTIONS.

APPROVED BY _____ DATE _____

 <p>Fairfield Metal 9 Audrey Place, Fairfield, NJ 07004 Phone: 973-276-8440 www.fairfieldmetal.com</p>	Drawing Title: REGLET FLASHING 2 PIECE	Drawing No. RF-003
	Drawn By: MD	Date: 05.04.2015

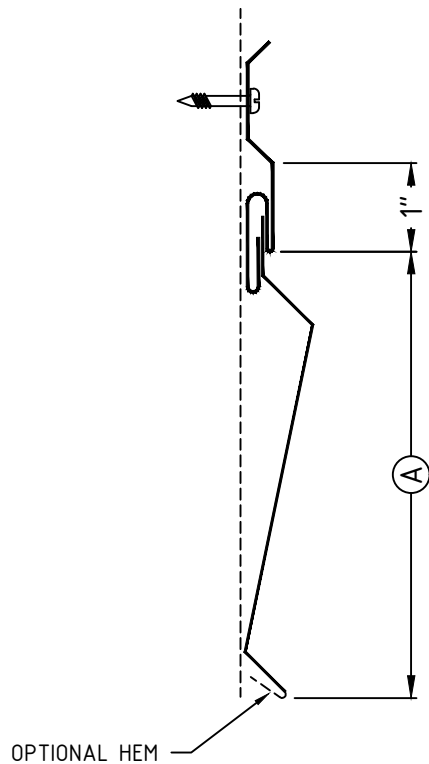

MATERIAL		FINISH	DIMENSION	QUANTITIES
<input type="checkbox"/> 24 GA. GALV.	<input type="checkbox"/> 26 GA SS	<input type="checkbox"/> KYNAR	A=	LINEAL FT.
<input type="checkbox"/> .032 ALUMIN.		<input type="checkbox"/> MILL FINISH		OUTSIDE MITERS @ DEG.
<input type="checkbox"/> .040 ALUMIN.		<input type="checkbox"/> ENAMEL		INSIDE MITERS @ DEG.
<input type="checkbox"/> 16 OZ COPPER		<input type="checkbox"/> ANODIZED	HEM <input type="checkbox"/> YES	
<input type="checkbox"/> 20 OZ COPPER		<input type="checkbox"/> OTHER	<input type="checkbox"/> NO	
<input type="checkbox"/> 16 OZ LCC		COLOR		
<input type="checkbox"/> 20 OZ LCC				

PROJECT:	FABRICATION WILL PROCEED ONLY AFTER RECEIPT OF SIGNED DRAWING APPROVAL DRAWING APPROVAL ARCHITECT AND /OR CONTRACTOR SHALL VERIFY ALL DIMENSIONS, SIZES AND QUANTITIES. ALL PRODUCTS TO BE INSTALLED IN STRICT ACCORDANCE WITH FAIRFIELD METAL'S PRINTED INSTRUCTIONS. APPROVED BY _____ DATE _____
ARCHITECT:	
ROOFING CONTRACTOR:	
REPRESENTATIVE:	

 Fairfield Metal 9 Audrey Place, Fairfield, NJ 07004 Phone: 973-276-8440 www.fairfieldmetal.com	Drawing Title: REGLET SURFACE MOUNT 2 PIECE	Drawing No. RF-004
	Drawn By: MD	Date: 05.04.2015

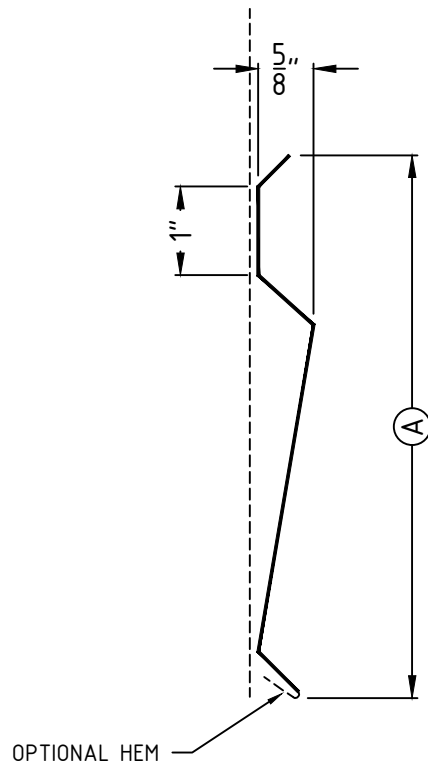

MATERIAL		FINISH	DIMENSION	QUANTITIES
<input type="checkbox"/> 24 GA. GALV.	<input type="checkbox"/> 24 GA SS	<input type="checkbox"/> KYNAR	A=	LINEAL FT.
<input type="checkbox"/> .032 ALUMIN.	<input type="checkbox"/> 26 GA SS	<input type="checkbox"/> MILL FINISH		OUTSIDE MITERS @ DEG.
<input type="checkbox"/> .040 ALUMIN.		<input type="checkbox"/> ENAMEL		INSIDE MITERS @ DEG.
<input type="checkbox"/> 16 OZ COPPER		<input type="checkbox"/> ANODIZED	HEM <input type="checkbox"/> YES	
<input type="checkbox"/> 20 OZ COPPER		<input type="checkbox"/> OTHER	<input type="checkbox"/> NO	
<input type="checkbox"/> 16 OZ LCC		COLOR		
<input type="checkbox"/> 20 OZ LCC				

PROJECT:	FABRICATION WILL PROCEED ONLY AFTER RECEIPT OF SIGNED DRAWING APPROVAL DRAWING APPROVAL ARCHITECT AND /OR CONTRACTOR SHALL VERIFY ALL DIMENSIONS, SIZES AND QUANTITIES. ALL PRODUCTS TO BE INSTALLED IN STRICT ACCORDANCE WITH FAIRFIELD METAL'S PRINTED INSTRUCTIONS. APPROVED BY _____ DATE _____
ARCHITECT:	
ROOFING CONTRACTOR:	
REPRESENTATIVE:	

 Fairfield Metal 9 Audrey Place, Fairfield, NJ 07004 Phone: 973-276-8440 www.fairfieldmetal.com	Drawing Title: REGLET SURFACE MOUNT K FLASHING	Drawing No. RF-005
	Drawn By: MD	Date: 05.04.2015

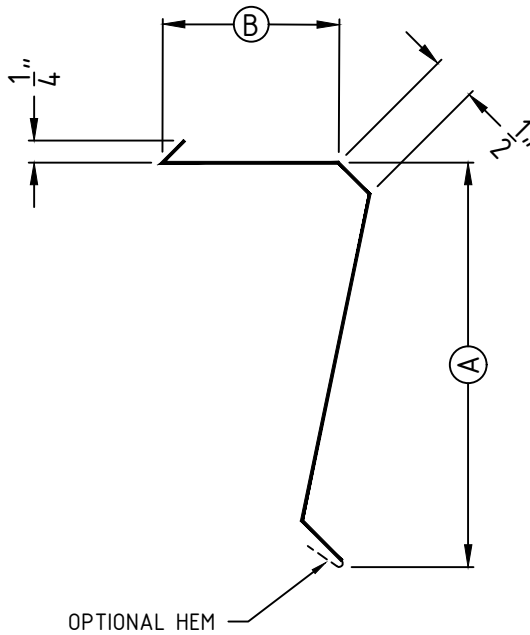

MATERIAL		FINISH	DIMENSION	QUANTITIES
<input type="checkbox"/> 24 GA. GALV.	<input type="checkbox"/> 24 GA SS	<input type="checkbox"/> KYNAR	A=	LINEAL FT.
<input type="checkbox"/> .032 ALUMIN.	<input type="checkbox"/> 26 GA SS	<input type="checkbox"/> MILL FINISH	B=	OUTSIDE MITERS @ DEG.
<input type="checkbox"/> .040 ALUMIN.		<input type="checkbox"/> ENAMEL		INSIDE MITERS @ DEG.
<input type="checkbox"/> 16 OZ COPPER		<input type="checkbox"/> ANODIZED	HEM <input type="checkbox"/> YES	
<input type="checkbox"/> 20 OZ COPPER		<input type="checkbox"/> OTHER	<input type="checkbox"/> NO	
<input type="checkbox"/> 16 OZ LCC		COLOR		
<input type="checkbox"/> 20 OZ LCC				

PROJECT: _____

ARCHITECT: _____

ROOFING CONTRACTOR: _____

REPRESENTATIVE: _____

FABRICATION WILL PROCEED ONLY AFTER RECEIPT OF SIGNED DRAWING APPROVAL

DRAWING APPROVAL

ARCHITECT AND /OR CONTRACTOR SHALL VERIFY ALL DIMENSIONS, SIZES AND QUANTITIES. ALL PRODUCTS TO BE INSTALLED IN STRICT ACCORDANCE WITH FAIRFIELD METAL'S PRINTED INSTRUCTIONS.

APPROVED BY _____ DATE _____

 <p>Fairfield Metal 9 Audrey Place, Fairfield, NJ 07004 Phone: 973-276-8440 www.fairfieldmetal.com</p>	Drawing Title: REGLET FLASHING MASONRY	Drawing No. RF-006
	Drawn By: MD	Date: 05.04.2015

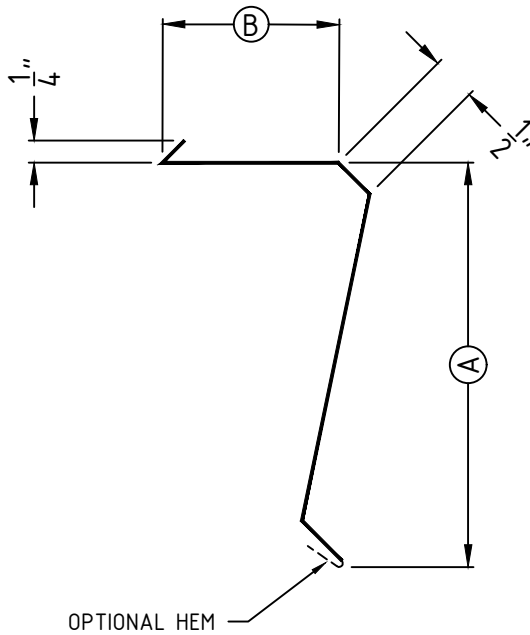

MATERIAL		FINISH	DIMENSION	QUANTITIES
<input type="checkbox"/> 24 GA. GALV.	<input type="checkbox"/> 26 GA SS	<input type="checkbox"/> KYNAR	A=	LINEAL FT.
<input type="checkbox"/> .032 ALUMIN.		<input type="checkbox"/> MILL FINISH	B=	OUTSIDE MITERS @ DEG.
<input type="checkbox"/> .040 ALUMIN.		<input type="checkbox"/> ENAMEL		INSIDE MITERS @ DEG.
<input type="checkbox"/> 16 OZ COPPER		<input type="checkbox"/> ANODIZED	HEM <input type="checkbox"/> YES	
<input type="checkbox"/> 20 OZ COPPER		<input type="checkbox"/> OTHER	<input type="checkbox"/> NO	
<input type="checkbox"/> 16 OZ LCC		COLOR		
<input type="checkbox"/> 20 OZ LCC				

PROJECT: _____

ARCHITECT: _____

ROOFING CONTRACTOR: _____

REPRESENTATIVE: _____

FABRICATION WILL PROCEED ONLY AFTER RECEIPT OF SIGNED DRAWING APPROVAL

DRAWING APPROVAL

ARCHITECT AND /OR CONTRACTOR SHALL VERIFY ALL DIMENSIONS, SIZES AND QUANTITIES. ALL PRODUCTS TO BE INSTALLED IN STRICT ACCORDANCE WITH FAIRFIELD METAL'S PRINTED INSTRUCTIONS.

APPROVED BY _____ DATE _____

 <p>Fairfield Metal 9 Audrey Place, Fairfield, NJ 07004 Phone: 973-276-8440 www.fairfieldmetal.com</p>	Drawing Title: REGLET FLASHING MASONRY	Drawing No. RF-007
	Drawn By: MD	Date: 05.04.2015