



# 2022 EDITION

---

## LOS ANGELES REGIONAL UNIFORM CODE PROGRAM

Recommended Code Amendments to  
the 2022 Edition of the California  
Building Code, California Residential  
Code, and California Green Building  
Standards Code.

Final Version: 07-01-22





## PREFACE

In 1957 our founding members established one of the earliest chapters of the International Conference of Building Officials. Today the Chapter has grown to over eighty-nine Southern California jurisdictions, plus consulting firms and other members of the construction industry. ICBO merged with two other building official organizations to create the International Code Council. The Los Angeles Basin Chapter officially became an ICC Chapter in December 2002.

The Los Angeles Basin Chapter has been very active throughout the years in leading an effort to create uniformity of building codes and regulations in the greater Los Angeles region as well as addressing policy issues of interest to building officials and the construction industry.

One such effort to promote uniformity of building regulations is through the Los Angeles Regional Uniform Code Program (“LARUCP”). The LARUCP program began in July 1999 with the purpose of developing uniform interpretations and handouts to serve as guidelines for building officials, contractors, engineers and architects in the consistent application of the codes. The mission of the program was to minimize the number of and to develop uniformity in local code amendments to the California codes for adoption by jurisdictions in the greater Los Angeles region and beyond.

Leading the efforts to creating uniformity of building codes and regulations within the region are the dedicated jurisdictional members and partners in the greater Los Angeles region. Through the coordination of the ICC Los Angeles Basin Chapter’s Structural Committee, Sustainability Committee, and Administration Committee (herein collectively referred to as “ICC-LABC Committees”), the following regulatory streamlining tasks to be completed are:

1. Create uniformity of building standards code that can be adopted by jurisdictions in the greater Los Angeles region;
2. Reduce the total number of local amendments to the California codes in the greater Los Angeles region;
3. Receive support from many, if not all, of the 89 jurisdictions in the greater Los Angeles region;
4. Obtain active participation from jurisdictions in the greater Los Angeles region in formulating and implementing the LARUCP program; and
5. With construction valuation of over \$5 billion in the region, conservatively assuming that the program produces a 1% construction cost savings, achieve an estimated cost saving of \$50 million per year in the greater Los Angeles region.

## DISCUSSION

Sections 13145.3, 17922, 17958 and 18941.5 of the California Health and Safety Code requires that the latest California Building Standards Codes apply to local construction 180 days after they become effective at the State level. The California Building Standards Commission will be adopting (or has adopted) the 2022 Edition of the California Building Code, California Residential Code, and California Green Building Standards Code. State Law requires that these Codes become effective at the local level on January 1, 2023.

Sections 17958.5 and 17958.7 of the California Health and Safety Code requires that local amendments to the California Building Standards Codes and other regulations, including but not limited to, green building standards, be enacted only when an express finding is made that such modifications or changes are reasonably necessary because of local climatic, geological, or topographical conditions.

The ICC-LABC Committees are recommending that the 2022 Edition of the LARUCP Recommended Code Amendments contained in this document, some of which continues amendments enacted during the previous code adoption cycle, be considered for local code adoption for the following reasons:

1. To protect the community within the greater Los Angeles region from a vast array of fault systems capable of producing major earthquakes and/or climate systems capable of producing major winds, fire and rain related disaster.
2. To ensure and encourage energy efficiency and sustainable practices are incorporated into building designs and constructions.

The 2022 Edition of the LARUCP Recommended Code Amendments have been widely circulated and discussed over the past several months with various jurisdictional members, Structural Engineers Association of Southern California's members, design professionals in the construction industry, and other interested groups or individuals. The proposed code language along with the reasons and findings are detailed in this document for each of the recommended code amendments to the 2022 Edition of the California Building Standards Code.

## **STATEMENT ON USE OF DOCUMENT**

The primary purpose of the ICC-LABC Committees is to serve and benefit its members. To this end, the ICC-LABC Committees provide a forum for the exchange, consideration, and discussion of ideas and proposals that are relevant to the construction industry and the consensus of which forms the basis for the proposed amendments contained in this document.

By making available the recommendations in this document, the ICC-LABC Committees do not ensure any jurisdiction using the information it contains against any liability arising from that use. The Committees disclaims liability for any injury to persons or to property, or other damages of any nature whatsoever, whether special, indirect, consequential or compensatory, directly or indirectly resulting from the publication, use of, or reliance on this document. The ICC-LABC Committees makes no guaranty or warranty as to the accuracy or completeness of any information provided herein. Any jurisdiction using this document should rely on their own independent judgment and exercise reasonable care in any given circumstances. Each jurisdiction adopting the proposed amendments contained in this document should make an independent, substantiating investigation of the validity of that information for their particular use.

## **ACKNOWLEDGEMENT**

The ICC Los Angeles Basin Chapter would like to express its gratitude and appreciation to all the participating ICC-LABC Committees and correspondents that spent countless hours over the past several months assisting in the review, discussion, evaluation and drafting of the proposed recommended code amendments to the 2022 Edition of the California Building Code, California Residential Code and California Green Building Standards Code. Special thanks go out members of the Administration Committee, Structural Committee, and Sustainability Committee and specifically to the following individuals without whose support and effort the recommendations presented herein would not be possible.

Aleeta Dene, APA – The Engineered Wood Association  
 Ariana Vito, City of Santa Monica, Transportation Electrification  
 Gregory Bowser, City of Long Beach, Building and Safety Bureau  
 Kristin Norman, County of Los Angeles, Building and Safety Division  
 Razmig Shamim, County of Los Angeles, Building and Safety Division  
 Truong Huynh, City of Long Beach, Building and Safety Bureau  
 Uykheang Keo, City of Torrance, Building and Safety Division

## EXPRESS TERM LANGUAGE

### LOCAL GOVERNMENT AMENDMENTS UNDER THE CALIFORNIA BUILDING STANDARDS LAW:

Pursuant to Sections 17958.5, 17958.7 and 18941.5 of the Health and Safety Code, the California Building Standards Law permits local amendments under the following conditions:

- The governing body of the local government must make express findings that amendments to the building standards, including green building standards but excluding residential, historic or energy standards, contained in the California Codes of Regulation Title 24 are reasonably necessary because of local climatic, geological, or topographical conditions.
- The local government amendments must provide more restrictive building standards than that contained in California Codes of Regulation Title 24.
- The amendments are not effective until copies of both the express findings and the amendments, with the amendments expressly marked and identified as to the applicable findings, have been filed with the California Building Standards Commission.

### LOCAL GOVERNMENT AMENDMENTS UNDER THE STATE HOUSING LAW:

Pursuant to Sections 17958, 17958.5 and 17958.7 of the Health and Safety Code, the State Housing Law permits local amendments are permitted under the following conditions:

- The governing body of the local government must make express findings that amendments to the building standards, including green building standards, for residential occupancies contained in the California Codes of Regulation Titles 24 or 25 are reasonably necessary because of local climatic, geological, or topographical conditions.
- The local government amendments must provide equivalent or more restrictive building standards than that contained in California Codes of Regulation Titles 24 or 25.
- The amendments are not effective until copies of both the express findings and the amendments, with the amendments expressly marked and identified as to the applicable findings, have been filed with the California Building Standards Commission.

### LEGEND FOR PROPOSING AMENDMENTS TO PROPOSED BUILDING STANDARDS:

1. Existing California amendments or code language being modified: *All such language shown in italics, modified language is underlined or shown in ~~strikeout~~.*
2. Model code language with new California amendments: Model code language shown in Arial 10 fonts; California amendments to the model code texts shown *underlined and in italics*.
3. Proposed amended or adopted text: All language shown in underline.
4. Repealed text: All language shown in ~~strikeout~~.



## TABLE OF CONTENT

<u>TITLE/DESCRIPTION</u>	<u>PAGE</u>
Preface	2
Discussion	2
Statement on Use of Document	3
Acknowledgement	3
Express Term Language	4
Table of Content	5
 <b>PART I</b>	 7
Summary of Recommended LARUCP Amendments to the 2022 CBC	8
2022 LARUCP 16-01 Add CBC Sections 1613.5 and 1613.5.1 Amendments to ASCE 7	9
2022 LARUCP 16-02 Add CBC Section 1613.5.2 Wood Diaphragms	10
2022 LARUCP 16-03 Add CBC Section 1613.5.3 Structural Separation	11
2022 LARUCP 16-04 Add CBC Section 1613.6 Seismic Design Provisions for Hillside Buildings	12
2022 LARUCP 16-05 Add CBC Section 1613.7 Suspended Ceilings	18
2022 LARUCP 17-01 Amend CBC Section 1704.6 Structural Observations	20
2022 LARUCP 17-02 Amend CBC Section 1704.6.1 Structural Observations for Structures	21
2022 LARUCP 17-03 Amend CBC Section 1705.3 Concrete Construction	22
2022 LARUCP 17-04 Amend CBC Section 1705.13 Special Inspections for Seismic Resistance	23
2022 LARUCP 18-01 Amend CBC Section 1807.1.4 Permanent Wood Foundation Systems	24
2022 LARUCP 18-02 Amend CBC Section 1807.1.6 Prescriptive Design of Concrete and Masonry Foundation Walls	25
2022 LARUCP 18-03 Amend CBC Section 1807.2 Retaining Walls	26
2022 LARUCP 18-04 Amend CBC Section 1807.3.1 Limitations	27
2022 LARUCP 18-05 Amend CBC Section 1809.3 Stepped Footings	28
2022 LARUCP 18-06 Amend CBC Section 1809.7 and Table 1809.7 Prescriptive Footings for Light- Frame Construction	29
2022 LARUCP 18-07 Amend CBC Section 1809.12 Timber Footings	30
2022 LARUCP 18-08 Amend CBC Section 1810.3.2.4 Timber	31
2022 LARUCP 19-01 Amend CBC Section 1905.1.7 ACI 318, Section 14.1.4	32
2022 LARUCP 19-02 Amend CBC Section 1905.1 and Add Sections 1905.1.9 thru 19.05.1.11 General	34
2022 LARUCP 23-01 Amend CBC Section 2304.10.2 Fastener Requirements	36
2022 LARUCP 23-02 Add CBC Section 2304.10.3.1 Quality of Nails	37
2022 LARUCP 23-03 Amend CBC Section 2304.12.2.8 Wood Used in Retaining Walls and Cribs	38
2022 LARUCP 23-04 Add CBC Section 2305.4 Hold-Down Connectors	39
2022 LARUCP 23-05 Amend CBC Section 2306.2 Wood-Frame Diaphragms	40
2022 LARUCP 23-06 Amend CBC Section 2306.3 Wood-Frame Shear Walls	42
2022 LARUCP 23-07 Add CBC Section 2307.2 Wood-Frame Shear Walls	44
2022 LARUCP 23-08 Amend CBC Table 2308.6.1 Wall Bracing Requirements	45
2022 LARUCP 23-09 Amend CBC Sections 2308.6.5.1 and 2308.6.5.2, and Figures 2308.6.5.1 and 2308.6.5.2 Alternative Bracing	47
2022 LARUCP 23-10 Amend CBC Section 2308.6.8.1 Foundation Requirements	50
2022 LARUCP 23-11 Amend CBC Section 2308.6.9 Attachment of Sheathing	52
2022 LARUCP 31-01 Amend CBC Section 3115 Intermodal Shipping Containers	53
 <b>PART II</b>	 60
Summary of Recommended LARUCP Amendments to the 2022 CRC	61
2022 LARUCP R3-01 Amend CRC Section R301.1.3.2 Woodframe Structures	62
2022 LARUCP R3-02 Add CRC Section R301.1.5 Seismic Design Provisions for Buildings on Slopes Steeper than 33%	63
2022 LARUCP R3-03 Amend CRC Items 1, 3, and 5 of Section R301.2.2.6 Irregular Buildings	64
2022 LARUCP R3-04 Add CRC Section R301.2.2.11 Anchorage of Mechanical, Electrical, or Plumbing Components and Equipment	66
2022 LARUCP R4-01 Amend CRC Section R401.1 Application	67

<u>TITLE/DESCRIPTION</u>	<u>PAGE</u>
2022 LARUCP R4-02 Amend CRC Sections R403.1.2, R403.1.3.6, and R403.1.5 General Footings	68
2022 LARUCP R4-03 Amend CRC Section R404.2 Wood Foundation Walls	70
2022 LARUCP R5-01 Amend CRC Section R501.2 Requirements	71
2022 LARUCP R5-02 Add CRC Section R503.2.4 Openings in Horizontal Diaphragms	72
2022 LARUCP R6-01 Amend CRC Table R602.3(1) Fastening Schedule	73
2022 LARUCP R6-02 Amend CRC Table R602.3(2) Alternate Attachments to Table R602.3(1)	75
2022 LARUCP R6-03 Amend CRC Section R602.3.2 and Table R602.3.2 Top Plate	76
2022 LARUCP R6-04 Amend CRC Section R602.10.2.3 Minimum Number of Braced Wall Panels	77
2022 LARUCP R6-05 Amend CRC Table R602.10.3(3) Bracing Requirements Based on Seismic Design Category	78
2022 LARUCP R6-06 Amend CRC Table R602.10.4 Bracing Methods	81
2022 LARUCP R6-07 Amend CRC Table R602.10.5 Minimum Length of Braced Wall Panels	84
2022 LARUCP R6-08 Amend CRC Figure R602.10.6.1 Method ABW - Alternate Braced Wall Panel	86
2022 LARUCP R6-09 Amend CRC Figure R602.10.6.2 Method PFH - Portal Frame with Hold-downs at Detached Garage Door Openings	88
2022 LARUCP R6-10 Amend CRC Figure R602.10.6.4 Method CS-PF - Continuously Sheathed Portal Frame Panel Construction	89
2022 LARUCP R6-11 Amend CRC Section R606.4.4 Parapet Walls	91
2022 LARUCP R6-12 Amend CRC Section R606.12.2.2.3 Reinforcement Requirements for Masonry Elements	92
2022 LARUCP R8-01 Add CRC Section R803.2.4 Openings in Horizontal Diaphragms	93
2022 LARUCP R10-01 Amend CRC Section R1001.3.1 Vertical Reinforcing	94
<b>PART III</b>	95
Summary of Recommended LARUCP Amendments to the 2022 CALGreen	96
2022 LARUCP G4-01 Amend CALGreen Section 4.106.4.2.1 EV for New Multifamily Development Projects	97
2022 LARUCP G4-02 Amend CALGreen Section 4.106.4.2.2 EV for New Multifamily Development Projects	99
2022 LARUCP G5-01 Amend CALGreen Exception 2 of Section 5.106.5.3 EV for New Nonresidential Development Projects	101



## PART I

# LARUCP RECOMMENDED CODE AMENDMENTS TO THE 2022 EDITION OF THE CALIFORNIA BUILDING CODE

## SUMMARY OF RECOMMENDED LARUCP AMENDMENTS TO THE 2022 CBC

2022 LARUCP NO.	TITLE/DESCRIPTION	STATUS <sup>1</sup>
16-01	Add CBC Sections 1613.5 and 1613.5.1 Amendments to ASCE 7	E
16-02	Add CBC Section 1613.5.2 Wood Diaphragms	E
16-03	Add CBC Section 1613.5.3 Structural Separation	E
16-04	Add CBC Section 1613.6 Seismic Design Provisions for Hillside Buildings	E
16-05	Add CBC Section 1613.7 Suspended Ceilings	E
17-01	Amend CBC Section 1704.6 Structural Observations	E
17-02	Amend CBC Section 1704.6.1 Structural Observations for Structures	E
17-03	Amend CBC Section 1705.3 Concrete Construction	E
17-04	Amend CBC Section 1705.13 Special Inspections for Seismic Resistance	E
18-01	Amend CBC Section 1807.1.4 Permanent Wood Foundation Systems	E
18-02	Amend CBC Section 1807.1.6 Prescriptive Design of Concrete and Masonry Foundation Walls	E
18-03	Amend CBC Section 1807.2 Retaining Walls	E
18-04	Amend CBC Section 1807.3.1 Limitations	E
18-05	Amend CBC Section 1809.3 Stepped Footings	E
18-06	Amend CBC Section 1809.7 and Table 1809.7 Prescriptive Footings for Light-Frame Construction	E
18-07	Amend CBC Section 1809.12 Timber Footings	E
18-08	Amend CBC Section 1810.3.2.4 Timber	E
19-01	Amend CBC Section 1905.1.7 ACI 318, Section 14.1.4	E
19-02	Amend CBC Section 1905.1 and Add Sections 1905.1.9 thru 1905.1.11 General	E
23-01	Amend CBC Section 2304.10.2 Fastener Requirements	E
23-02	Add CBC Section 2304.10.3.1 Quality of Nails	E
23-03	Amend CBC Section 2304.12.2.8 Wood Used in Retaining Walls and Cribs	E
23-04	Add CBC Section 2305.4 Hold-Down Connectors	E
23-05	Amend CBC Section 2306.2 Wood-Frame Diaphragms	E
23-06	Amend CBC Section 2306.3 Wood-Frame Shear Walls	E
23-07	Add CBC Section 2307.2 Wood-Frame Shear Walls	E
23-08	Amend CBC Table 2308.6.1 Wall Bracing Requirements	E
23-09	Amend CBC Sections 2308.6.5.1 and 2308.6.5.2, and Figures 2308.6.5.1 and 2308.6.5.2 Alternative Bracing	E
23-10	Amend CBC Section 2308.6.8.1 Foundation Requirements	E
23-11	Amend CBC Section 2308.6.9 Attachment of Sheathing	E
31-01	Amend CBC Section 3115 Intermodal Shipping Containers	E

**FOOTNOTE:**

1. N = New amendment proposed  
 E = Existing amendment updated as necessary



## 2022 LARUCP 16-01

Sections 1613.5 and 1613.5.1 are added to Chapter 16 of the 2022 Edition of the California Building Code to read as follows:

**1613.5 Amendments to ASCE 7.** The provisions of Section 1613.5 shall be permitted as an amendment to the relevant provisions of ASCE 7.

**1613.5.1 Values for vertical combinations.** Modify ASCE 7 Section 12.2.3.1 Exception 3 as follows:

3. Detached one- and two-family dwellings up to two stories in height of light frame construction.

### RATIONALE:

Observed damages to one- and two-family dwellings of light frame construction after the Northridge Earthquake may have been partially attributed to vertical irregularities common to this type of occupancy and construction. In an effort to improve quality of construction and incorporate lesson learned from studies after the Northridge Earthquake, the proposed modification to ASCE 7-16 Section 12.2.3.1 Exception 3 by limiting the number of stories and height of the structure to two stories will significantly minimize the impact of vertical irregularities and concentration of inelastic behavior from mixed structural systems. This proposed amendment is a continuation of an amendment adopted during previous code adoption cycles.

### FINDINGS:

Local Geological Conditions – The greater Los Angeles region is a densely populated area having buildings and structures constructed over and near a vast array of fault systems capable of producing major earthquakes, including but not limited to the 1994 Northridge Earthquake. The proposed modification to limit mixed structural system to two stories is intended to improve quality of construction by reducing potential damages that may result from vertical irregularities of the structural system in buildings subject to high seismic load and therefore need to be incorporated into the code to assure that new buildings and structures and additions or alterations to existing buildings or structures are designed and constructed in accordance with the scope and objectives of the California Building Code.

## 2022 LARUCP 16-02

Section 1613.5.2 is added to Chapter 16 of the 2022 Edition of the California Building Code to read as follows:

**1613.5.2 Wood diaphragms.** Modify ASCE 7 Section 12.11.2.2.3 as follows:

**12.11.2.2.3 Wood diaphragms.** The anchorage of concrete or masonry structural walls to wood diaphragms shall be in accordance with AWC SDPWS 4.1.5.1 and this section. Continuous ties required by this section shall be in addition to the diaphragm sheathing. Anchorage shall not be accomplished by use of toenails or nails subject to withdrawal, nor shall wood ledgers or framing be used in cross-grain bending or cross-grain tension. The diaphragm sheathing shall not be considered effective for providing the ties or struts required by this section

For structures assigned to Seismic Design Category D, E or F, wood diaphragms supporting concrete or masonry walls shall comply with the following:

1. The spacing of continuous ties shall not exceed 40 feet. Added chords of diaphragms may be used to form subdiaphragms to transmit the anchorage forces to the main continuous crossties.
2. The maximum diaphragm shear used to determine the depth of the subdiaphragm shall not exceed 75% of the maximum diaphragm shear.

### RATIONALE:

A Joint Structural Engineers Association of Southern California (SEAOSC), Los Angeles County and Los Angeles City Task Force investigated the performance of concrete and masonry construction with flexible wood diaphragm failures after the Northridge earthquake. It was concluded at that time that continuous ties are needed at specified spacing to control cross grain tension in the interior of the diaphragm. Additionally, there was a need to limit subdiaphragm allowable shear loads to control combined orthogonal stresses within the diaphragm. Recognizing the importance and need to continue the recommendation made by the task force while taking into consideration the improve performances and standards for diaphragm construction today, this proposal increases the continuous tie spacing limit to 40 ft in lieu of 25 ft and to use 75% of the allowable code diaphragm shear to determine the depth of the sub-diaphragm in lieu of the 300 plf and is deemed appropriate and acceptable. Due to the frequency of this type of failure during the past significant earthquakes, various jurisdictions within the Los Angeles region have taken this additional step to prevent roof or floor diaphragms from pulling away from concrete or masonry walls. This proposed amendment is a continuation of an amendment adopted during previous code adoption cycles.

### FINDINGS:

Local Geological Conditions – The greater Los Angeles region is a densely populated area having buildings and structures constructed over and near a vast array of fault systems capable of producing major earthquakes, including but not limited to the 1994 Northridge Earthquake. The proposed modification to require special anchorage of the diaphragm to the wall and limit the allowable shear will address special needs for concrete and masonry construction with flexible wood diaphragm and therefore need to be incorporated into the code to assure that new buildings and structures and additions or alterations to existing buildings or structures are designed and constructed in accordance with the scope and objectives of the California Building Code.

## 2022 LARUCP 16-03

Section 1613.5.3 is added to Chapter 16 of the 2022 Edition of the California Building Code to read as follows:

**1613.5.3 Structural separation.** Modify ASCE 7 Section 12.12.3 Equation 12.12-1 as follows:

$$\delta_M = \frac{C_d \delta_{\max}}{I_e} \quad (12.12-1)$$

### RATIONALE:

The inclusion of the importance factor in this equation has the unintended consequence of reducing the minimum seismic separation distance for important facilities such as hospitals, schools, police and fire stations from adjoining structures. The proposal to omit the importance factor from Equation 12.12-1 will ensure that a safe seismic separation distance is provided. This proposed amendment is a continuation of an amendment adopted during previous code adoption cycles.

### FINDINGS:

Local Geological Conditions – The greater Los Angeles region is a densely populated area having buildings and structures constructed over and near a vast array of fault systems capable of producing major earthquakes, including but not limited to the 1994 Northridge Earthquake, the 1987 Whittier Narrows Earthquake, the 1971 San Fernando Earthquake and the 1933 Long Beach Earthquake. The proposed modification to omit the importance factor in the equation ensures that a safe seismic separation distance is maintained for important facilities from adjoining structures and therefore need to be incorporated into the code to assure that new buildings and structures and additions or alterations to existing buildings or structures are designed and constructed in accordance with the scope and objectives of the California Building Code.

## 2022 LARUCP 16-04

Section 1613.6 is added to Chapter 16 of the 2022 Edition of the California Building Code to read as follows:

### **1613.6 Seismic design provisions for hillside buildings.**

**1613.6.1 Purpose.** The purpose of this section is to establish minimum regulations for the design and construction of new buildings and additions to existing buildings when constructing such buildings on or into slopes steeper than one unit vertical in three units horizontal (33.3%). These regulations establish minimum standards for seismic force resistance to reduce the risk of injury or loss of life in the event of earthquakes.

**1613.6.2 Scope.** The provisions of this section shall apply to the design of the lateral-force-resisting system for hillside buildings at and below the base level diaphragm. The design of the lateral-force-resisting system above the base level diaphragm shall be in accordance with the provisions for seismic and wind design as required elsewhere in this division.

**Exception:** Non-habitable accessory buildings and decks not supporting or supported from the main building are exempt from these regulations.

### **1613.6.3 Definitions.** For the purposes of this section certain terms are defined as follows:

BASE LEVEL DIAPHRAGM is the floor at, or closest to, the top of the highest level of the foundation.

DIAPHRAGM ANCHORS are assemblies that connect a diaphragm to the adjacent foundation at the uphill diaphragm edge.

DOWNHILL DIRECTION is the descending direction of the slope approximately perpendicular to the slope contours.

FOUNDATION is concrete or masonry which supports a building, including footings, stem walls, retaining walls, and grade beams.

FOUNDATION EXTENDING IN THE DOWNHILL DIRECTION is a foundation running downhill and approximately perpendicular to the uphill foundation.

HILLSIDE BUILDING is any building or portion thereof constructed on or into a slope steeper than one unit vertical in three units horizontal (33.3%). If only a portion of the building is supported on or into the slope, these regulations apply to the entire building.

PRIMARY ANCHORS are diaphragm anchors designed for and providing a direct connection as described in Sections 1613.6.5 and 1613.6.7.3 between the diaphragm and the uphill foundation.

SECONDARY ANCHORS are diaphragm anchors designed for and providing a redundant diaphragm to foundation connection, as described in Sections 1613.6.6 and 1613.6.7.4.

UPHILL DIAPHRAGM EDGE is the edge of the diaphragm adjacent and closest to the highest ground level at the perimeter of the diaphragm.

UPHILL FOUNDATION is the foundation parallel and closest to the uphill diaphragm edge.

### **1613.6.4 Analysis and design.**

**1613.6.4.1 General.** Every hillside building within the scope of this section shall be analyzed, designed, and constructed in accordance with the provisions of this division. When the code-prescribed wind design produces greater effects, the wind design shall govern, but detailing requirements and limitations prescribed in this and referenced sections shall be followed.

**1613.6.4.2 Base level diaphragm-downhill direction.** The following provisions shall apply to the seismic analysis and design of the connections for the base level diaphragm in the downhill direction.

**1613.6.4.2.1 Base for lateral force design defined.** For seismic forces acting in the downhill direction, the base of the building shall be the floor at or closest to the top of the highest level of the foundation.

**1613.6.4.2.2 Base shear.** In developing the base shear for seismic design, the response modification coefficient (R) shall not exceed 5 for bearing wall and building frame systems. The total base shear shall include the forces tributary to the base level diaphragm including forces from the base level diaphragm.

### **1613.6.5 Base shear resistance-primary anchors.**

**1613.6.5.1 General.** The base shear in the downhill direction shall be resisted through primary anchors from diaphragm struts provided in the base level diaphragm to the foundation.

**1613.6.5.2 Location of primary anchors.** A primary anchor and diaphragm strut shall be provided in line with each foundation extending in the downhill direction. Primary anchors and diaphragm struts shall also be provided where interior vertical lateral-force-resisting elements occur above and in contact with the base level diaphragm. The spacing of primary anchors and diaphragm struts or collectors shall in no case exceed 30 feet (9144 mm).

**1613.6.5.3 Design of primary anchors and diaphragm struts.** Primary anchors and diaphragm struts shall be designed in accordance with the requirements of Section 1613.6.8.

**1613.6.5.4 Limitations.** The following lateral-force-resisting elements shall not be designed to resist seismic forces below the base level diaphragm in the downhill direction:

1. Wood structural panel wall sheathing,
2. Cement plaster and lath,
3. Gypsum wallboard, and
4. Tension only braced frames.

Braced frames designed in accordance with the requirements of Section 2205.2.1.2 may be used to transfer forces from the primary anchors and diaphragm struts to the foundation provided lateral forces do not induce flexural stresses in any member of the frame or in the diaphragm struts. Deflections of frames shall account for the variation in slope of diagonal members when the frame is not rectangular.

### **1613.6.6 Base shear resistance-secondary anchors.**

**1613.6.6.1 General.** In addition to the primary anchors required by Section 1613.6.5, the base shear in the downhill direction shall be resisted through secondary anchors in the uphill foundation connected to diaphragm struts in the base level diaphragm.

**Exception:** Secondary anchors are not required where foundations extending in the downhill direction spaced at not more than 30 feet (9144 mm) on center extend up to and are directly connected to the base level diaphragm for at least 70% of the diaphragm depth.

**1613.6.6.2 Secondary anchor capacity and spacing.** Secondary anchors at the base level diaphragm shall be designed for a minimum force equal to the base shear, including forces tributary to the base level diaphragm, but not less than 600 pounds per lineal foot (8.76 kN/m) based on Allowable Stress Design (ASD) levels. The secondary anchors shall be uniformly distributed along the uphill diaphragm edge and shall be spaced a maximum of 4 feet (1219 mm) on center.

**1613.6.6.3 Design.** Secondary anchors and diaphragm struts shall be designed in accordance with Section 1613.6.8.

**1613.6.7 Diaphragms below the base level-downhill direction.** The following provisions shall apply to the lateral analysis and design of the connections for all diaphragms below the base level diaphragm in the downhill direction.



**1613.6.7.1 Diaphragm defined.** Every floor level below the base level diaphragm shall be designed as a diaphragm.

**1613.6.7.2 Design force.** Each diaphragm below the base level diaphragm shall be designed for all tributary loads at that level using a minimum seismic force factor not less than the base shear coefficient.

**1613.6.7.3 Design force resistance-primary anchors.** The design force described in Section 1613.6.7.2 shall be resisted through primary anchors from diaphragm struts provided in each diaphragm to the foundation. Primary anchors shall be provided and designed in accordance with the requirements and limitations of Section 1613.6.5.

**1613.6.7.4 Design force resistance-secondary anchors.**

**1613.6.7.4.1 General.** In addition to the primary anchors required in Section 1613.6.7.3, the design force in the downhill direction shall be resisted through secondary anchors in the uphill foundation connected to diaphragm struts in each diaphragm below the base level.

**Exception:** Secondary anchors are not required where foundations extending in the downhill direction, spaced at not more than 30 feet (9144 mm) on center, extend up to and are directly connected to each diaphragm below the base level for at least 70% of the diaphragm depth.

**1613.6.7.4.2 Secondary anchor capacity.** Secondary anchors at each diaphragm below the base level diaphragm shall be designed for a minimum force equal to the design force but not less than 300 pounds per lineal foot (4.38 kN/m) based on Allowable Stress Design (ASD) levels. The secondary anchors shall be uniformly distributed along the uphill diaphragm edge and shall be spaced a maximum of 4 feet (1219 mm) on center.

**1613.6.7.4.3 Design.** Secondary anchors and diaphragm struts shall be designed in accordance with Section 1613.6.8.

**1613.6.8 Primary and secondary anchorage and diaphragm strut design.** Primary and secondary anchors and diaphragm struts shall be designed in accordance with the following provisions:

1. **Fasteners.** All bolted fasteners used to develop connections to wood members shall be provided with square plate washers at all bolt heads and nuts. Washers shall be minimum 0.229 inch by 3 inches by 3 inches (5.82 mm by 76 mm by 76 mm) in size. Nuts shall be tightened to finger tight plus one half (1/2) wrench turn prior to covering the framing.
2. **Fastening.** The diaphragm to foundation anchorage shall not be accomplished by the use of toenailing, nails subject to withdrawal, or wood in cross-grain bending or cross-grain tension.
3. **Size of Wood Members.** Wood diaphragm struts collectors, and other wood members connected to primary anchors shall not be less than 3 inch (76 mm) nominal width. The effects of eccentricity on wood members shall be evaluated as required per Item 9.
4. **Design.** Primary and secondary anchorage, including diaphragm struts, splices, and collectors shall be designed for 125% of the tributary force.
5. **Allowable Stress Increase.** The one-third allowable stress increase permitted under Section 1605.3.2 shall not be taken when the working (allowable) stress design method is used.
6. **Steel Element of Structural Wall Anchorage System.** The strength design forces for steel elements of the structural wall anchorage system, with the exception of anchor bolts and reinforcing steel, shall be increased by 1.4 times the forces otherwise required.
7. **Primary Anchors.** The load path for primary anchors and diaphragm struts shall be fully developed into the diaphragm and into the foundation. The foundation must be shown to be adequate to resist the concentrated loads from the primary anchors.

8. Secondary Anchors. The load path for secondary anchors and diaphragm struts shall be fully developed in the diaphragm but need not be developed beyond the connection to the foundation.
9. Symmetry. All lateral force foundation anchorage and diaphragm strut connections shall be symmetrical. Eccentric connections may be permitted when demonstrated by calculation or tests that all components of force have been provided for in the structural analysis or tests.
10. Wood Ledgers. Wood ledgers shall not be used to resist cross-grain bending or cross-grain tension.

#### **1613.6.9 Lateral-force-resisting elements normal to the downhill direction.**

**1613.6.9.1 General.** In the direction normal to the downhill direction, lateral-force-resisting elements shall be designed in accordance with the requirements of this section.

**1613.6.9.2 Base shear.** In developing the base shear for seismic design, the response modification coefficient (R) shall not exceed 5 for bearing wall and building frame systems.

**1613.6.9.3 Vertical distribution of seismic forces.** For seismic forces acting normal to the downhill direction the distribution of seismic forces over the height of the building using Section 12.8.3 of ASCE 7 shall be determined using the height measured from the top of the lowest level of the building foundation.

**1613.6.9.4 Drift limitations.** The story drift below the base level diaphragm shall not exceed 0.007 times the story height at strength design force level. The total drift from the base level diaphragm to the top of the foundation shall not exceed 3/4 inch (19 mm). Where the story height or the height from the base level diaphragm to the top of the foundation varies because of a stepped footing or story offset, the height shall be measured from the average height of the top of the foundation. The story drift shall not be reduced by the effect of horizontal diaphragm stiffness.

#### **1613.6.9.5 Distribution of lateral forces.**

**1613.6.9.5.1 General.** The design lateral force shall be distributed to lateral-force-resisting elements of varying heights in accordance with the stiffness of each individual element.

**1613.6.9.5.2 Wood structural panel sheathed walls.** The stiffness of a stepped wood structural panel shear wall may be determined by dividing the wall into adjacent rectangular elements, subject to the same top of wall deflection. Deflections of shear walls may be estimated by AWC SDPWS Section 4.3.2. Sheathing and fastening requirements for the stiffest section shall be used for the entire wall. Each section of wall shall be anchored for shear and uplift at each step. The minimum horizontal length of a step shall be 8 feet (2438 mm) and the maximum vertical height of a step shall be 2 feet 8 inches (813 mm).

**1613.6.9.5.3 Reinforced concrete or masonry shear walls.** Reinforced concrete or masonry shear walls shall have forces distributed in proportion to the rigidity of each section of the wall.

**1613.6.9.6 Limitations.** The following lateral force-resisting-elements shall not be designed to resist lateral forces below the base level diaphragm in the direction normal to the downhill direction:

1. Cement plaster and lath.
2. Gypsum wallboard, and
3. Tension-only braced frames.

Braced frames designed in accordance with the requirements of Section 2205.2.1.2 of this Code may be designed as lateral-force-resisting elements in the direction normal to the downhill direction, provided lateral forces do not induce flexural stresses in any member of the frame. Deflections of frames shall account for the variation in slope of diagonal members when the frame is not rectangular.

#### **1613.6.10 Specific design provisions.**

**1613.6.10.1 Footings and grade beams.** All footings and grade beams shall comply with the following:

1. Grade beams shall extend at least 12 inches (305 mm) below the lowest adjacent grade and provide a minimum 24 inch (610 mm) distance horizontally from the bottom outside face of the grade beam to the face of the descending slope.
2. Continuous footings shall be reinforced with at least two No. 4 reinforcing bars at the top and two No. 4 reinforcing bars at the bottom.
3. All main footing and grade beam reinforcement steel shall be bent into the intersecting footing and fully developed around each corner and intersection.
4. All concrete stem walls shall extend from the foundation and reinforced as required for concrete or masonry walls.

**1613.6.10.2 Protection against decay and termites.** All wood to earth separation shall comply with the following:

1. Where a footing or grade beam extends across a descending slope, the stem wall, grade beam, or footing shall extend up to a minimum 18 inches (457 mm) above the highest adjacent grade.

**Exception:** At paved garage and doorway entrances to the building, the stem wall need only extend to the finished concrete slab, provided the wood framing is protected with a moisture proof barrier.

2. Wood ledgers supporting a vertical load of more than 100 pounds per lineal foot (1.46 kN/m) based on Allowable Stress Design (ASD) levels and located within 48 inches (1219 mm) of adjacent grade are prohibited. Galvanized steel ledgers and anchor bolts, with or without wood nailers, or treated or decay resistant sill plates supported on a concrete or masonry seat, may be used.

**1613.6.10.3 Sill plates.** All sill plates and anchorage shall comply with the following:

1. All wood framed walls, including nonbearing walls, when resting on a footing, foundation, or grade beam stem wall, shall be supported on wood sill plates bearing on a level surface.
2. Power-driven fasteners shall not be used to anchor sill plates except at interior nonbearing walls not designed as shear walls.

**1613.6.10.4 Column base plate anchorage.** The base of isolated wood posts (not framed into a stud wall) supporting a vertical load of 4,000 pounds (17.8 kN) based on Allowable Stress Design (ASD) levels or more and the base plate for a steel column shall comply with the following:

1. When the post or column is supported on a pedestal extending above the top of a footing or grade beam, the pedestal shall be designed and reinforced as required for concrete or masonry columns. The pedestal shall be reinforced with a minimum of four No. 4 bars extending to the bottom of the footing or grade beam. The top of exterior pedestals shall be sloped for positive drainage.
2. The base plate anchor bolts or the embedded portion of the post base, and the vertical reinforcing bars for the pedestal, shall be confined with two No. 4 or three No. 3 ties within the top 5 inches (127 mm) of the concrete or masonry pedestal. The base plate anchor bolts shall be embedded a minimum of 20 bolt diameters into the concrete or masonry pedestal. The base plate anchor bolts and post bases shall be galvanized and each anchor bolt shall have at least 2 galvanized nuts above the base plate.

**1613.6.10.5 Steel beam to column supports.** All steel beam to column supports shall be positively braced in each direction. Steel beams shall have stiffener plates installed on each side of the beam web

at the column. The stiffener plates shall be welded to each beam flange and the beam web. Each brace connection or structural member shall consist of at least two 5/8 inch (15.9 mm) diameter machine bolts.

**RATIONALE:**

Due to the difficulty of fire suppression vehicles accessing winding and narrow hillside properties and the probabilities for future earthquakes in the Los Angeles region, this technical amendment is required to address the special needs for buildings constructed on hillside locations. A joint Structural Engineers Association of Southern California (SEAOSC) and both the Los Angeles County and Los Angeles City Task Force investigated the performance of hillside building failures after the Northridge earthquake. Numerous hillside failures resulted in loss of life and millions of dollars in damage. These criteria were developed to minimize the damage to these structures and have been in use by both the City and County of Los Angeles for several years with much success. This proposed amendment is a continuation of an amendment adopted during previous code adoption cycles.

**FINDINGS:**

Local Topographical and Geological Conditions – The greater Los Angeles region is a densely populated area having buildings and structures constructed over and near a vast array of fault systems capable of producing major earthquakes, including but not limited to the recent 1994 Northridge Earthquake. Additionally, the topography within the Los Angeles region includes significant hillsides with narrow and winding access that makes timely response by fire suppression vehicles challenging and difficult. The proposed modification establishes design parameters to better mitigate and limit property damage that are the results of increased seismic forces which are imparted upon hillside buildings and structures and therefore need to be incorporated into the code to assure that new buildings and structures and additions or alterations to existing buildings or structures are designed and constructed in accordance with the scope and objectives of the California Building Code.

## 2022 LARUCP 16-05

Section 1613.7 is added to Chapter 16 of the 2022 Edition of the California Building Code to read as follows:

**1613.7 Suspended ceilings.** Minimum design and installation standards for suspended ceilings shall be determined in accordance with the requirements of Section 2506.2.1 of this Code and this section.

**1613.7.1 Scope.** This part contains special requirements for suspended ceilings and lighting systems. Provisions of Section 13.5.6 of ASCE 7 shall apply except as modified herein.

**1613.7.2 General.** The suspended ceilings and lighting systems shall be limited to 6 feet (1828 mm) below the structural deck unless the lateral bracing is designed by a licensed engineer or architect.

**1613.7.3 Sprinkler heads.** All sprinkler heads (drops) except fire-resistance-rated floor/ceiling or roof/ceiling assemblies, shall be designed to allow for free movement of the sprinkler pipes with oversize rings, sleeves or adaptors through the ceiling tile. Sprinkler heads and other penetrations shall have a 2 inch (50mm) oversize ring, sleeve, or adapter through the ceiling tile to allow for free movement of at least 1 inch (25mm) in all horizontal directions. Alternatively, a swing joint that can accommodate 1 inch (25 mm) of ceiling movement in all horizontal directions is permitted to be provided at the top of the sprinkler head extension.

Sprinkler heads penetrating fire-resistance-rated floor/ceiling or roof/ceiling assemblies shall comply with Section 714 of this Code.

**1613.7.4 Special requirements for means of egress.** Suspended ceiling assemblies located along means of egress serving an occupant load of 30 or more and at lobbies accessory to Group A Occupancies shall comply with the following provisions.

**1613.7.4.1 General.** Ceiling suspension systems shall be connected and braced with vertical hangers attached directly to the structural deck along the means of egress serving an occupant load of 30 or more and at lobbies accessory to Group A Occupancies. Spacing of vertical hangers shall not exceed 2 feet (610 mm) on center along the entire length of the suspended ceiling assembly located along the means of egress or at the lobby.

**1613.7.4.2 Assembly device.** All lay-in panels shall be secured to the suspension ceiling assembly with two hold-down clips minimum for each tile within a 4-foot (1219 mm) radius of the exit lights and exit signs.

**1613.7.4.3 Emergency systems.** Independent supports and braces shall be provided for light fixtures required for exit illumination. Power supply for exit illumination shall comply with the requirements of Section 1008.3 of this Code.

**1613.7.4.4 Supports for appendage.** Separate support from the structural deck shall be provided for all appendages such as light fixtures, air diffusers, exit signs, and similar elements.

### RATIONALE:

The California Building Code has little to no information regarding the safe design and construction requirements for ceiling suspension systems subject to seismic loads. It is through the experience of prior earthquakes, such as the Northridge Earthquake, that this amendment is proposed so as to minimize the amount of bodily and building damage within the spaces in which this type of ceiling will be installed. This proposed amendment complements ASCE 7-16 Chapter 13 Section 13.5.6.2.2 and the cited reference to ASTM E580. The amended requirements retained herein are a continuation of portions of an amendment adopted during the previous code adoption cycles.

### FINDINGS:

Local Geological Conditions – The greater Los Angeles region is a densely populated area having buildings constructed over and near a vast array of fault systems capable of producing major earthquakes, including but



not limited to the 1994 Northridge Earthquake. The proposed modification requiring safe design and construction requirements for ceiling suspension systems to resist seismic loads is intended to minimize the amount of damage within a building and therefore need to be incorporated into the code to assure that new buildings and additions to existing buildings are designed and constructed in accordance with the scope and objectives of the California Building Code.

## 2022 LARUCP 17-01

Section 1704.6 of the 2022 Edition of the California Building Code is amended to read as follows:

**1704.6 Structural observations.** Where required by the provisions of Section 1704.6.1, the owner or the owner's authorized agent shall employ a ~~registered design professional~~ structural observer to perform structural observations. The structural observer shall visually observe representative locations of structural systems, details and load paths for general conformance to the approved construction documents. Structural observation does not include or waive the responsibility for the inspections in Section 110 or the special inspections in Section 1705 or other sections of this code. The structural observer shall be one of the following individuals:

1. The registered design professional responsible for the structural design, or
2. A registered design professional designated by the registered design professional responsible for the structural design.

Prior to the commencement of observations, the structural observer shall submit to the building official a written statement identifying the frequency and extent of structural observations.

~~At the conclusion of the work included in the permit, the structural observer shall submit to the building official a written statement that the site visits have been made and identify any reported deficiencies that, to the best of the structural observer's knowledge, have not been resolved.~~

The owner or owner's authorized agent shall coordinate and call a preconstruction meeting between the structural observer, contractors, affected subcontractors and special inspectors. The structural observer shall preside over the meeting. The purpose of the meeting shall be to identify the major structural elements and connections that affect the vertical and lateral load resisting systems of the structure and to review scheduling of the required observations. A record of the meeting shall be included in the report submitted to the building official. Observed deficiencies shall be reported in writing to the owner or owner's authorized agent, special inspector, contractor and the building official. Upon the form prescribed by the building official, the structural observer shall submit to the building official a written statement at each significant construction stage stating that the site visits have been made and identifying any reported deficiencies which, to the best of the structural observer's knowledge, have not been resolved. A final report by the structural observer which states that all observed deficiencies have been resolved is required before acceptance of the work by the building official.

### RATIONALE:

The language in Section 1704.6 of the California Building Code permits the owner to employ any registered design professional to perform structural observations with minimum guideline. However, it is important to recognize that the registered design professional responsible for the structural design has thorough knowledge of the building he/she designed. By requiring the registered design professional responsible for the structural design or their designee who were involved with the design to observe the construction, the quality of the observation for major structural elements and connections that affect the vertical and lateral load resisting systems of the structure will greatly be increased. Additional requirements are provided to help clarify the role and duties of the structural observer and the method of reporting and correcting observed deficiencies to the building official. This proposed amendment is a continuation of an amendment adopted during previous code adoption cycles.

### FINDINGS:

Local Geological Conditions – The greater Los Angeles region is a densely populated area having buildings and structures constructed over and near a vast array of fault systems capable of producing major earthquakes, including but not limited to the 1994 Northridge Earthquake. The proposed modification to require the registered design professional in responsible charge for the structural design to observe the construction will help ensure acceptable standards of workmanship is provided and to improve the quality of the observation and therefore need to be incorporated into the code to assure that new buildings and structures and additions or alterations to existing buildings or structures are designed and constructed in accordance with the scope and objectives of the California Building Code.

## 2022 LARUCP 17-02

Section 1704.6.1 of the 2022 Edition of the California Building Code is amended to read as follows:

**1704.6.1 Structural observations for structures.** Structural observations shall be provided for those structures where one or more of the following conditions exist:

1. The structure is classified as Risk Category III or IV.
2. The structure is a high-rise building.
3. ~~The structure is assigned to Seismic Design Category E, and is greater than two stories above the grade plane.~~ A lateral design is required for the structure or portion thereof.

**Exception:** One-story wood framed Group R-3 and Group U Occupancies less than 2,000 square feet in area, provided the adjacent grade is not steeper than 1 unit vertical in 10 units horizontal (10% sloped), assigned to Seismic Design Category D.

4. Such observation is required by the registered design professional responsible for the structural design.
5. Such observation is specifically required by the building official.

### RATIONALE:

With the higher seismic demand placed on buildings and structures in this region, the language in Section 1704.6.1 of the California Building Code would permit many low-rise buildings and structures with complex structural elements to be constructed without the benefit of a structural observation. By requiring a registered design professional to observe the construction, the quality of the observation for major structural elements and connections that affect the vertical and lateral load resisting systems of the structure will greatly be increased. An exception is provided to permit simple structures and buildings to be excluded. This proposed amendment is a continuation of an amendment adopted during previous code adoption cycles.

### FINDINGS:

Local Geological Conditions – The greater Los Angeles region is a densely populated area having buildings and structures constructed over and near a vast array of fault systems capable of producing major earthquakes, including but not limited to the 1994 Northridge Earthquake. The proposed modification to require the registered design professional in responsible charge for the structural design to observe the construction will help ensure acceptable standards of workmanship is provided and to improve the quality of the observation and therefore need to be incorporated into the code to assure that new buildings and structures and additions or alterations to existing buildings or structures are designed and constructed in accordance with the scope and objectives of the California Building Code.

## 2022 LARUCP 17-03

Section 1705.3 of the 2022 Edition of the California Building Code is amended to read as follows:

**1705.3 Concrete construction.** Special inspections and tests of concrete construction shall be performed in accordance with this section and Table 1705.3.

**Exceptions:** Special inspections and tests shall not be required for:

1. Isolated spread concrete footings of buildings three stories or less above grade plane that are fully supported on earth or rock where the structural design of the footing is based on a specified compressive strength,  $f_c$ , not more than 2,500 pounds per square inch (psi) (17.2 Mpa) regardless of the compressive strength specified in the construction documents or used in the footing construction.
2. Continuous concrete footings supporting walls of buildings three stories or less above grade plane that are fully supported on earth or rock where:
  - 2.1. The footings support walls of light-frame construction;
  - 2.2. The footings are designed in accordance with Table 1809.7; or
  - 2.3. The structural design of the footing is based on a specified compressive strength,  $f_c$ , not more than 2,500 pounds per square inch (psi) (17.2 Mpa), regardless of the compressive strength specified in the construction documents or used in the footing construction.
3. Nonstructural concrete slabs supported directly on the ground, including prestressed slabs on grade, where the effective prestress in the concrete is less than 150 psi (1.03 Mpa).
- ~~4. Concrete foundation walls constructed in accordance with Table 1807.1.6.2.~~
- ~~5~~4. Concrete patios, driveways and sidewalks, on grade.

### RATIONALE:

Results from studies after the 1994 Northridge Earthquake indicated that a lot of the damage was attributed to a lack of quality control during construction resulting in poor performance of the building or structure. Therefore, the proposed amendment requires special inspection for concrete with a compressive strength greater than 2,500 pounds per square inch. This proposed amendment is a continuation of an amendment adopted during previous code adoption cycles.

### FINDINGS:

Local Geological Conditions – The greater Los Angeles region is a densely populated area having buildings and structures constructed over and near a vast array of fault systems capable of producing major earthquakes, including but not limited to the 1994 Northridge Earthquake. The proposed modification to require special inspection for concrete with a compressive strength greater than 2,500 psi to improve quality of control during construction and therefore need to be incorporated into the code to assure that new buildings and structures and additions or alterations to existing buildings or structures are designed and constructed in accordance with the scope and objectives of the California Building Code.

## 2022 LARUCP 17-04

Section 1705.13 of the 2022 Edition of the California Building Code is amended to read as follows:

**1705.13 Special inspections for seismic resistance.** Special inspections for seismic resistance shall be required as specified in Sections 1705.13.1 through 1705.13.9, unless exempted by the exceptions of Section 1704.2.

**Exception:** The special inspections specified in Sections 1705.13.1 through 1705.13.9 are not required for structures designed and constructed in accordance with one of the following:

1. The structure consists of light-frame construction; the design spectral response acceleration at short periods,  $S_{DS}$ , as determined in Section 1613.2.4, does not exceed 0.5; and the building height of the structure does not exceed 35 feet (10 668 mm).
2. The seismic force-resisting system of the structure consists of reinforced masonry or reinforced concrete; the design spectral response acceleration at short periods,  $S_{DS}$ , as determined in Section 1613.2.4, does not exceed 0.5; and the building height of the structure does not exceed 25 feet (7620 mm)
3. The structure is a detached one- or two-family dwelling not exceeding two stories above grade plane, is not assigned to Seismic Design Category D, E or F, and does not have any of the following horizontal or vertical irregularities in accordance with Section 12.3 of ASCE 7:
  - 3.1 Torsional or extreme torsional irregularity.
  - 3.2 Nonparallel systems irregularity.
  - 3.3 Stiffness-soft story or stiffness-extreme soft story irregularity.
  - 3.4 Discontinuity in lateral strength-weak story irregularity.

### RATIONALE:

In Southern California, very few detached one- or two-family dwellings not exceeding two stories above grade plane are built as “box-type” structures, especially those in hillside areas and near the oceanfront. Many steel moment frames or braced frames and/or cantilevered columns within buildings can still be shown as “regular” structures by calculations. With the higher seismic demand placed on buildings and structures in this region, the language in Section 1705.13 Exception 3 of the California Building Code would permit many detached one- or two-family dwellings not exceeding two stories above grade plane with complex structural elements to be constructed without the benefit of special inspections. By requiring special inspections, the quality of major structural elements and connections that affect the vertical and lateral load resisting systems of the structure will greatly be increased. The exception should only be allowed for detached one- or two-family dwellings not exceeding two stories above grade plane assigned to Seismic Design Category A, B and C.

### FINDINGS:

Local Geological Conditions – The greater Los Angeles region is a densely populated area having buildings and structures constructed over and near a vast array of fault systems capable of producing major earthquakes, including but not limited to the 1994 Northridge Earthquake. The proposed modification to require special inspections for detached one- or two-family dwellings not exceeding two stories above grade plane assigned to Seismic Design Category D, E and F will help ensure that acceptable standards of workmanship and quality of construction are provided and therefore needs to be incorporated into the code to assure that new buildings and structures and additions or alterations to existing buildings or structures are designed and constructed in accordance with the scope and objectives of the California Building Code.



## 2022 LARUCP 18-01

Section 1807.1.4 of the 2022 Edition of the California Building Code is amended to read as follows:

**1807.1.4 Permanent wood foundation systems.** Permanent wood foundation systems shall be designed and installed in accordance with AWC PWF. Lumber and plywood shall be treated in accordance with AWPA U1 (Commodity Specification A, Special Requirement 4.2) and shall be identified in accordance with Section 2303.1.9.1. Permanent wood foundation systems shall not be used for structures assigned to Seismic Design Category D, E or F.

### RATIONALE:

No substantiating data has been provided to show that wood foundation systems are effective in supporting buildings and structures during a seismic event while being subject to deterioration caused by the combined detrimental effects of constant moisture in the soil and wood-destroying organisms. Wood foundation systems not properly treated and protected against deterioration, have performed very poorly and have led to slope failures. Most contractors are typically accustomed to construction in dry and temperate weather in the Southern California region and are not generally familiar with the necessary precautions and treatment of wood that makes it suitable for both seismic events and wet applications. The proposed amendment takes the precautionary steps to reduce or eliminate potential problems that may result in using wood foundation systems that experience relatively rapid decay due to the fact that the region does not experience temperatures cold enough to destroy or retard the growth and proliferation of wood-destroying organisms. This proposed amendment is a continuation of an amendment adopted during previous code adoption cycles.

### FINDINGS:

Local Climatic and Geological Conditions – The greater Los Angeles region is a densely populated area having buildings and structures constructed over and near a vast array of fault systems capable of producing major earthquakes, including but not limited to the 1994 Northridge Earthquake. In addition, the region is within a climate system capable of producing major winds, fire and rain related disasters, including but not limited to those caused by the Santa Ana winds and El Nino (or La Nina) subtropical-like weather. This region is especially susceptible to more active termite and wood attacking insects and microorganisms. The proposed modification to prohibit the use of wood foundation systems as well as limit prescriptive design provisions in an effort to mitigate potential problems or deficiencies due to the proliferation of wood-destroying organisms and therefore needs to be incorporated into the code to assure that new buildings and structures and additions or alterations to existing buildings or structures are designed and constructed in accordance with the scope and objectives of the California Building Code.

## 2022 LARUCP 18-02

Section 1807.1.6 of the 2022 Edition of the California Building Code is amended to read as follows:

**1807.1.6 Prescriptive design of concrete and masonry foundation walls.** Concrete and masonry foundation walls that are laterally supported at the top and bottom shall be permitted to be designed and constructed in accordance with this section. Prescriptive design of foundation walls shall not be used for structures assigned to Seismic Design Category D, E or F.

### RATIONALE:

With the higher seismic demand placed on buildings and structures in this region, it is deemed necessary to take precautionary steps to reduce or eliminate potential problems that may result by following prescriptive design provisions that does not take into consideration the surrounding environment. Plain concrete performs poorly in withstanding the cyclic forces resulting from seismic events. In addition, no substantiating data has been provided to show that under-reinforced foundation walls are effective in resisting seismic loads and may potentially lead to a higher risk of failure. It is important that the benefit and expertise of a registered design professional be obtained to properly analyze the structure and take these issues into consideration. This proposed amendment is a continuation of an amendment adopted during previous code adoption cycles.

### FINDINGS:

Local Geological Conditions – The greater Los Angeles region is a densely populated area having buildings and structures constructed over and near a vast array of fault systems capable of producing major earthquakes, including but not limited to the 1994 Northridge Earthquake. The proposed modification to prohibit prescriptive design provisions for foundation walls as plain concrete have performed poorly in withstanding the cyclic forces resulting from seismic events and to require the walls to be designed by a registered design professional to ensure that the proper analysis of the structure takes into account the surrounding condition and therefore need to be incorporated into the code to assure that new buildings and structures and additions or alterations to existing buildings or structures are designed and constructed in accordance with the scope and objectives of the California Building Code.

## 2022 LARUCP 18-03

Section 1807.2 of the 2022 Edition of the California Building Code is amended to read as follows:

**1807.2 Retaining walls.** Retaining walls shall be designed in accordance with Section 1807.2.1 through 1807.2.4. Retaining walls assigned to Seismic Design Category D, E or F shall not be partially or wholly constructed of wood.

### RATIONALE:

No substantiating data has been provided to show that wood foundation systems are effective in supporting buildings and structures during a seismic event while being subject to deterioration caused by the combined detrimental effects of constant moisture in the soil and wood-destroying organisms. Wood foundation systems not properly treated and protected against deterioration, have performed very poorly and have led to slope failures. Most contractors are typically accustomed to construction in dry and temperate weather in the Southern California region and are not generally familiar with the necessary precautions and treatment of wood that makes it suitable for both seismic events and wet applications. The proposed amendment takes the precautionary steps to reduce or eliminate potential problems that may result in using wood foundation systems that experience relatively rapid decay due to the fact that the region does not experience temperatures cold enough to destroy or retard the growth and proliferation of wood-destroying organisms. This proposed amendment is a continuation of an amendment adopted during previous code adoption cycles.

### FINDINGS:

Local Climatic and Geological Conditions – The greater Los Angeles region is a densely populated area having buildings and structures constructed over and near a vast array of fault systems capable of producing major earthquakes, including but not limited to the 1994 Northridge Earthquake. In addition, the region is within a climate system capable of producing major winds, fire and rain related disasters, including but not limited to those caused by the Santa Ana winds and El Nino (or La Nina) subtropical-like weather. This region is especially susceptible to more active termite and wood attacking insects and microorganisms. The proposed modification to prohibit the use of wood foundation systems as well as limit prescriptive design provisions in an effort to mitigate potential problems or deficiencies due to the proliferation of wood-destroying organisms and therefore needs to be incorporated into the code to assure that new buildings and structures and additions or alterations to existing buildings or structures are designed and constructed in accordance with the scope and objectives of the California Building Code.

## 2022 LARUCP 18-04

Section 1807.3.1 of the 2022 Edition of the California Building Code is amended to read as follows:

**1807.3.1 Limitations.** The design procedures outlined in this section are subject to the following limitations:

1. The frictional resistance for structural walls and slabs on silts and clays shall be limited to one-half of the normal force imposed on the soil by the weight of the footing or slab.
2. Posts embedded in earth shall not be used to provide lateral support for structural or nonstructural materials such as plaster, masonry or concrete unless bracing is provided that develops the limited deflection required.

Wood poles shall be treated in accordance with AWPA U1 for sawn timber posts (Commodity Specification A, Use Category 4B) and for round timber posts (Commodity Specification B, Use Category 4B). Wood poles and posts embedded in direct contact with soil shall not be used for structures assigned to Seismic Design Category D, E or F.

**Exception:** Wood poles and posts embedded in direct contact with soil may be used to support nonhabitable, nonoccupiable structures such as fences when approved by the building official.

### RATIONALE:

No substantiating data has been provided to show that wood foundation systems are effective in supporting buildings and structures during a seismic event while being subject to deterioration caused by the combined detrimental effects of constant moisture in the soil and wood-destroying organisms. Wood foundation systems not properly treated and protected against deterioration, have performed very poorly and have led to slope failures. Most contractors are typically accustomed to construction in dry and temperate weather in the Southern California region and are not generally familiar with the necessary precautions and treatment of wood that makes it suitable for both seismic events and wet applications. The proposed amendment takes the precautionary steps to reduce or eliminate potential problems that may result in using wood foundation systems that experience relatively rapid decay due to the fact that the region does not experience temperatures cold enough to destroy or retard the growth and proliferation of wood-destroying organisms. This proposed amendment is a continuation of an amendment adopted during previous code adoption cycles.

### FINDINGS:

Local Climatic and Geological Conditions – The greater Los Angeles region is a densely populated area having buildings and structures constructed over and near a vast array of fault systems capable of producing major earthquakes, including but not limited to the 1994 Northridge Earthquake. In addition, the region is within a climate system capable of producing major winds, fire and rain related disasters, including but not limited to those caused by the Santa Ana winds and El Nino (or La Nina) subtropical-like weather. This region is especially susceptible to more active termite and wood attacking insects and microorganisms. The proposed modification to prohibit the use of wood foundation systems as well as limit prescriptive design provisions in an effort to mitigate potential problems or deficiencies due to the proliferation of wood-destroying organisms and therefore needs to be incorporated into the code to assure that new buildings and structures and additions or alterations to existing buildings or structures are designed and constructed in accordance with the scope and objectives of the California Building Code.

## 2022 LARUCP 18-05

Section 1809.3 of the 2022 Edition of the California Building Code is amended to read as follows:

**1809.3 Stepped footings.** The top surface of footings shall be level. The bottom surface of footings shall be permitted to have a slope not exceeding one unit vertical in 10 units horizontal (10-percent slope). Footings shall be stepped where it is necessary to change the elevation of the top surface of the footing or where the surface of the ground slopes more than one unit vertical in 10 units horizontal (10-percent slope).

For structures assigned to Seismic Design Category D, E or F, the stepping requirement shall also apply to the top surface of continuous footings supporting walls. Footings shall be reinforced with four No. 4 deformed reinforcing bars. Two bars shall be placed at the top and bottom of the footings as shown in Figure 1809.3.

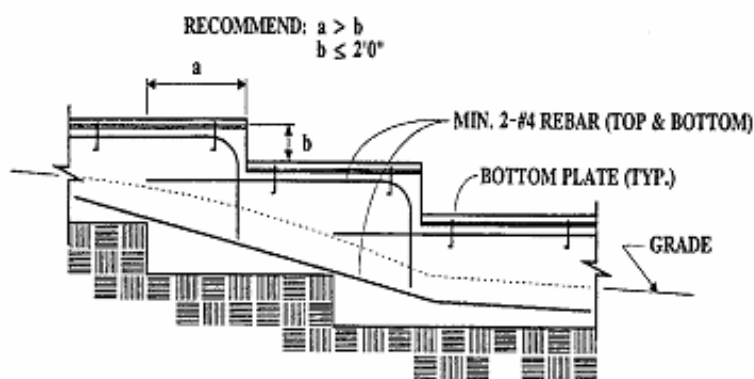

STEPPED FOUNDATIONS

**FIGURE 1809.3**  
**STEPPED FOOTING**

### RATIONALE:

With the higher seismic demand placed on buildings and structures in this region, precautionary steps are proposed to reduce or eliminate potential problems that may result for under reinforced footings located on sloped surfaces. Requiring minimum reinforcement for stepped footings is intended to address the problem of poor performance of plain or under-reinforced footings during a seismic event. This proposed amendment is a continuation of an amendment adopted during previous code adoption cycles.

### FINDINGS:

Local Geological Conditions – The greater Los Angeles region is a densely populated area having buildings and structures constructed over and near a vast array of fault systems capable of producing major earthquakes, including but not limited to the recent 1994 Northridge Earthquake. The proposed modification to require minimum reinforcement in stepped footings is intended to improve performance of buildings and structures and therefore need to be incorporated into the code to assure that new buildings and structures and additions or alterations to existing buildings or structures are designed and constructed in accordance with the scope and objectives of the California Building Code.

## 2022 LARUCP 18-06

Section 1809.7 and Table 1809.7 of the 2022 Edition of the California Building Code are amended to read as follows:

**1809.7 Prescriptive footings for light-frame construction.** Where a specific design is not provided, concrete or masonry-unit footings supporting walls of light-frame construction shall be permitted to be designed in accordance with Table 1809.7. Light-frame construction using prescriptive footings in Table 1809.7 shall not exceed one story above grade plane for structures assigned to Seismic Design Category D, E or F.

**TABLE 1809.7**  
**PRESCRIPTIVE FOOTINGS SUPPORTING WALLS OF**  
**LIGHT-FRAME CONSTRUCTION** <sup>a, b, c, d, e</sup>

NUMBER OF FLOORS SUPPORTED BY THE FOOTING <sup>f</sup>	WIDTH OF FOOTING (inches)	THICKNESS OF FOOTING (inches)
1	12	6
2	15	6
3	18	8 <sup>g</sup>

For SI: 1 inch = 25.4 mm, 1 foot = 304.8 mm

- Depth of footings shall be in accordance with Section 1809.4.
- The ground under the floor shall be permitted to be excavated to the elevation of the top of the footing.
- ~~Interior stud-bearing walls shall be permitted to be supported by isolated footings. The footing width and length shall be twice the width shown in this table, and footings shall be spaced not more than 6 feet on center. Not Adopted.~~
- See Section 1905 for additional requirements for concrete footings of structures assigned to Seismic Design Category C, D, E or F.
- For thickness of foundation walls, see Section 1807.1.6.
- Footings shall be permitted to support a roof addition to the stipulated number of floors. Footings supporting roof only shall be as required for supporting one floor.
- ~~Plain concrete footings for Group R-3 occupancies shall be permitted to be 6 inches thick.~~

### RATIONALE:

No substantiating data has been provided to show that under-reinforced footings are effective in resisting seismic loads and may potentially lead to a higher risk of failure. Therefore, this proposed amendment requires minimum reinforcement in continuous footings to address the problem of poor performance of plain or under-reinforced footings during a seismic event. With the higher seismic demand placed on buildings and structures in this region, precautionary steps are proposed to reduce or eliminate potential problems that may result by following prescriptive design provisions for footing that does not take into consideration the surrounding environment. It was important that the benefit and expertise of a registered design professional be obtained to properly analyze the structure and take these issues into consideration. This amendment reflects the recommendations by the Structural Engineers Association of Southern California (SEAOSC) and the Los Angeles City Task Force that investigated the poor performance observed in the 1994 Northridge Earthquake. This proposed amendment is a continuation of an amendment adopted during previous code adoption cycles.

### FINDINGS:

Local Geological Conditions – The greater Los Angeles region is a densely populated area having buildings and structures constructed over and near a vast array of fault systems capable of producing major earthquakes, including but not limited to the recent 1994 Northridge Earthquake. The proposed modification to limit the use of the prescriptive design provisions and under-reinforced or plain concrete is to ensure that the proper analysis of the structure takes into account the surrounding condition and therefore need to be incorporated into the code to assure that new buildings and structures and additions or alterations to existing buildings or structures are designed and constructed in accordance with the scope and objectives of the California Building Code.



## 2022 LARUCP 18-07

Section 1809.12 of the 2022 Edition of the California Building Code is amended to read as follows:

**1809.12 Timber footings.** Timber footings shall be permitted for buildings of Type V construction and as otherwise approved by the Building Official. Such footings shall be treated in accordance with AWWA U1 (Commodity Specification A, Use Category 4B). Treated timbers are not required where placed entirely below permanent water level, or where used as capping for wood piles that project above the water level over submerged or marsh lands. The compressive stresses perpendicular to grain in untreated timber footings supported on treated piles shall not exceed 70 percent of the allowable stresses for the species and grade of timber as specified in the ANSI/AWC NDS. Timber footings shall not be used in structures assigned to Seismic Design Category D, E or F.

### RATIONALE:

No substantiating data has been provided to show that timber footings are effective in supporting buildings and structures during a seismic event, especially while being subjected to deterioration caused by the combined detrimental effects of moisture in the soil and wood-destroying organisms. Timber footings, when they are not properly treated and protected against deterioration, have performed very poorly. Most contractors are typically accustomed to construction in dry and temperate weather in the Southern California region and are not generally familiar with the necessary precautions and treatment of wood that makes it suitable for both seismic event and wet applications. The proposed amendment takes the precautionary steps to reduce or eliminate potential problems that may result by using timber footings that experience relatively rapid decay due to the fact that the region does not experience temperatures cold enough to destroy or retard the growth and proliferation of wood-destroying organisms. This proposed amendment is a continuation of an amendment adopted during previous code adoption cycles.

### FINDINGS:

Local Climatic and Geological Conditions – The greater Los Angeles region is a densely populated area having buildings and structures constructed over and near a vast array of fault systems capable of producing major earthquakes, including but not limited to the recent 1994 Northridge Earthquake. In addition, the region is within a climate system capable of producing major winds, fire and rain related disasters, including but not limited to those caused by the Santa Ana winds and El Nino (or La Nina) subtropical-like weather. This region is especially susceptible to more active termite and wood attacking insects and microorganisms. The proposed modification to prohibit the use of timber footings in an effort to mitigate potential problems or deficiencies due to the proliferation of wood-destroying organisms and therefore need to be incorporated into the code to assure that new buildings and structures and additions or alterations to existing buildings or structures are designed and constructed in accordance with the scope and objectives of the California Building Code.

## 2022 LARUCP 18-08

Section 1810.3.2.4 of the 2022 Edition of the California Building Code is amended to read as follows:

**1810.3.2.4 Timber.** Timber deep foundation elements shall be designed as piles or poles in accordance with ANSI/AWC NDS. Round timber elements shall conform to ASTM D 25. Sawn timber elements shall conform to DOC PS-20. Timber deep foundation elements shall not be used in structures assigned to Seismic Design Category D, E or F.

### RATIONALE:

No substantiating data has been provided to show that timber deep foundation is effective in supporting buildings and structures during a seismic event while being subject to deterioration caused by the combined detrimental effect of constant moisture in the soil and wood-destroying organisms. Timber deep foundation, when they are not properly treated and protected against deterioration, has performed very poorly. Most contractors are typically accustomed to construction in dry and temperate weather in the Southern California region and are not generally familiar with the necessary precautions and treatment of wood that makes it suitable for both seismic event and wet applications. The proposed amendment takes the precautionary steps to reduce or eliminate potential problems that may result by using timber deep foundation that experience relatively rapid decay due to the fact that the region does not experience temperatures cold enough to destroy or retard the growth and proliferation of wood-destroying organisms. This proposed amendment is a continuation of an amendment adopted during previous code adoption cycles.

### FINDINGS:

Local Climatic and Geological Conditions – The greater Los Angeles region is a densely populated area having buildings and structures constructed over and near a vast array of fault systems capable of producing major earthquakes, including but not limited to the recent 1994 Northridge Earthquake. In addition, the region is within a climate system capable of producing major winds, fire and rain related disasters, including but not limited to those caused by the Santa Ana winds and El Nino (or La Nina) subtropical-like weather. This region is especially susceptible to more active termite and wood attacking insects and microorganisms. The proposed modification to prohibit the use of timber deep foundation in an effort to mitigate potential problems or deficiencies due to the proliferation of wood-destroying organisms and therefore need to be incorporated into the code to assure that new buildings and structures and additions or alterations to existing buildings or structures are designed and constructed in accordance with the scope and objectives of the California Building Code.

## 2022 LARUCP 19-01

Section 1905.1.7 of the 2022 Edition of the California Building Code is amended to read as follows:

**1905.1.7 ACI 318, Section 14.1.4.** Delete ACI 318, Section 14.1.4, and replace with the following:

14.1.4 – Plain concrete in structures assigned to Seismic Design Category C, D, E or F.

14.1.4.1 – Structures assigned to Seismic Design Category C, D, E or F shall not have elements of structural plain concrete, except as follows:

~~(a) Structural plain concrete basement, foundation or other walls below the base as defined in ASCE 7 are permitted in detached one- and two-family dwellings three stories or less in height constructed with stud-bearing walls. In dwellings assigned to Seismic Design Category D or E, the height of the wall shall not exceed 8 feet (2438 mm), the thickness shall not be less than 7½ inches (190 mm), and the wall shall retain no more than 4 feet (1219 mm) of unbalanced fill. Walls shall have reinforcement in accordance with 14.6.1. Concrete used for fill with a minimum cement content of two (2) sacks of Portland cement or cementitious material per cubic yard.~~

~~(b) Isolated footings of plain concrete supporting pedestals or columns are permitted, provided the projection of the footing beyond the face of the supported member does not exceed the footing thickness.~~

~~Exception: In detached one- and two-family dwellings three stories or less in height, the projection of the footing beyond the face of the supported member is permitted to exceed the footing thickness.~~

~~(c) Plain concrete footings supporting walls are permitted, provided the footings have at least two continuous longitudinal reinforcing bars. Bars shall not be smaller than No. 4 and shall have a total area of not less than 0.002 times the gross cross-sectional area of the footing. For footings that exceed 8 inches (203 mm) in thickness, a minimum of one bar shall be provided at the top and bottom of the footing. Continuity of reinforcement shall be provided at corners and intersections.~~

Exceptions:

~~1. In Seismic Design Categories A, B and C, Detached one- and two-family dwellings three stories or less in height and constructed with stud-bearing walls, are permitted to have plain concrete footings without longitudinal reinforcement with at least two continuous longitudinal reinforcing bars not smaller than No. 4 and are permitted to have a total area of longitudinal reinforcement less than 0.002 times the gross cross-sectional area of the footing.~~

~~2. For foundation systems consisting of a plain concrete footing and a plain concrete stemwall, a minimum of one bar shall be provided at the top of the stemwall and at the bottom of the footing.~~

~~3. Where a slab on ground is cast monolithically with the footing, one No. 5 bar is permitted to be located at either the top of the slab or bottom of the footing.~~

### RATIONALE:

This proposed amendment requires minimum reinforcement in continuous footings to address the problem of poor performance of plain or under-reinforced footings during a seismic event. This amendment reflects the recommendations by the Structural Engineers Association of Southern California (SEAOSC) and the Los Angeles City Joint Task Force that investigated the poor performance observed in 1994 Northridge Earthquake. This proposed amendment is a continuation of an amendment adopted during previous code adoption cycles.

**FINDINGS:**

Local Geological Conditions – The greater Los Angeles region is a densely populated area having buildings and structures constructed over and near a vast array of fault systems capable of producing major earthquakes, including but not limited to the recent 1994 Northridge Earthquake. The proposed modification to require minimum reinforcement to address the problem of poor performance of plain or under-reinforced footings during a seismic event and therefore need to be incorporated into the code to assure that new buildings and structures and additions or alterations to existing buildings or structures are designed and constructed in accordance with the scope and objectives of the California Building Code.

## 2022 LARUCP 19-02

Section 1905.1 is amended and Sections 1905.1.9 thru 1905.1.11 are added to Chapter 19 of the 2022 Edition of the California Building Code to read as follows:

**1905.1 General.** The text of ACI 318 shall be modified as indicated in Sections 1905.1.1 through ~~1905.1.8~~ 1905.1.11.

**1905.1.9 ACI 318, Section 18.7.5.** Modify ACI 318, Section 18.7.5, by adding Section 18.7.5.8 and 18.7.5.9 as follows:

*18.7.5.8 Where the calculated point of contraflexure is not within the middle half of the member clear height, provide transverse reinforcement as specified in ACI 318 Sections 18.7.5.1, Items (a) through (c), over the full height of the member.*

*18.7.5.9 – At any section where the design strength,  $\phi P_n$ , of the column is less than the sum of the shears  $V_e$  computed in accordance with ACI 318 Sections 18.7.6.1 and 18.6.5.1 for all the beams framing into the column above the level under consideration, transverse reinforcement as specified in ACI 318 Sections 18.7.5.1 through 18.7.5.3 shall be provided. For beams framing into opposite sides of the column, the moment components are permitted to be assumed to be of opposite sign. For the determination of the design strength,  $\phi P_n$ , of the column, these moments are permitted to be assumed to result from the deformation of the frame in any one principal axis.*

**1905.1.10 ACI 318, Section 18.10.4.** Modify ACI 318, Section 18.10.4, by adding Section 18.10.4.7 as follows:

*18.10.4.7 – Walls and portions of walls with  $P_u > 0.35P_o$  shall not be considered to contribute to the calculated shear strength of the structure for resisting earthquake-induced forces. Such walls shall conform to the requirements of ACI 318 Section 18.14.*

**1905.1.11 ACI 318, Section 18.12.6.** Modify ACI 318, by adding Section 18.12.6.2 as follows:

*18.12.6.2 Collector and boundary elements in topping slabs placed over precast floor and roof elements shall not be less than 3 inches (76 mm) or  $6 d_b$  in thickness, where  $d_b$  is the diameter of the largest reinforcement in the topping slab.*

### RATIONALE:

This amendment is intended to carry over critical provisions for the design of concrete columns in moment frames from the legacy 1997 Uniform Building Code. Increased confinement is critical to the integrity of such columns and these modifications ensure that it is provided when certain thresholds are exceeded.

In addition, this amendment carries over from the legacy 1997 Uniform Building Code a critical provision for the design of concrete shear walls. It essentially limits the use of very highly gravity-loaded walls in being included in the seismic load resisting system, since their failure could have catastrophic effect on the building.

Furthermore, this amendment was incorporated in the code based on observations from the 1994 Northridge Earthquake. Rebar placed in very thin concrete topping slabs have been observed in some instances to have popped out of the slab due to insufficient concrete coverage. This modification ensures that critical boundary and collector rebars are placed in sufficiently thick topping slab to prevent buckling of such reinforcements.

This proposed amendment is a continuation of an amendment adopted during previous code adoption cycles.

### FINDINGS:

Local Geological Conditions – The greater Los Angeles region is a densely populated area having buildings and structures constructed over and near a vast array of fault systems capable of producing major earthquakes,

including but not limited to the recent 1994 Northridge Earthquake. The proposed modification to increase confinement in critical columns, limiting the use of highly gravity loaded walls, and increase concrete coverage in thin slabs will have to prevent failure of the structure and therefore need to be incorporated into the code to assure that new buildings and structures and additions or alterations to existing buildings or structures are designed and constructed in accordance with the scope and objectives of the California Building Code.



## 2022 LARUCP 23-01

Section 2304.10.2 of the 2022 Edition of the California Building Code is amended to read as follows:

**2304.10.2 Fastener requirements.** Connections for wood members shall be designed in accordance with the appropriate methodology in Section 2302.1. The number and size of fasteners connecting wood members shall not be less than that set forth in Table 2304.10.2. Staple fasteners in Table 2304.10.2 shall not be used to resist or transfer seismic forces in structures assigned to Seismic Design Category D, E or F.

**Exception:** Staples may be used to resist or transfer seismic forces when the allowable shear values are substantiated by cyclic testing and approved by the building official.

### RATIONALE:

Due to the high geologic activities in the Southern California area and the expected higher level of performance on buildings and structures, this proposed local amendment limit the use of staple fasteners in resisting or transferring seismic forces. In September 2007, limited cyclic testing data was provided to the ICC Los Angeles Chapter Structural Code Committee showing that stapled wood structural shear panels do not exhibit the same behavior as the nailed wood structural shear panels. The test results of the stapled wood structural shear panels appeared much lower in strength and drift than the nailed wood structural shear panel test results. Therefore, the use of staples as fasteners to resist or transfer seismic forces shall not be permitted without being substantiated by cyclic testing. This proposed amendment is a continuation of a similar amendment adopted during previous code adoption cycles.

### FINDINGS:

Local Geological Conditions – The greater Los Angeles region is a densely populated area having buildings and structures constructed over and near a vast array of fault systems capable of producing major earthquakes, including but not limited to the recent 1994 Northridge Earthquake. The proposed modification to limit the use of staple fasteners to resist or transfer seismic load improve the performance of buildings and structures during a seismic event and therefore need to be incorporated into the code to assure that new buildings and structures and additions or alterations to existing buildings or structures are designed and constructed in accordance with the scope and objectives of the California Building Code.

## 2022 LARUCP 23-02

Section 2304.10.3.1 is added to Chapter 23 of the 2022 Edition of the California Building Code to read as follows:

**2304.10.3.1 Quality of nails.** In Seismic Design Category D, E or F, mechanically driven nails used in wood structural panel shear walls shall meet the same dimensions as that required for hand-driven nails, including diameter, minimum penetration and minimum head diameter. Clipped head or box nails are not permitted in new construction. The allowable design value for clipped head nails in existing construction shall be multiplied by the nail-head-area ratio of clipped head nails to that of the same size hand-driven nails.

### RATIONALE:

The overdriving of nails into the structural wood panel still remains a concern when pneumatic nail guns are used for wood structural panel shear wall nailing. Box nails were observed to cause massive and multiple failures of the typical 3/8-inch thick plywood during the 1994 Northridge Earthquake. The use of clipped head nails as allowed in Table A1 of ANSI/AWC SDPWS footnote referencing to ASTM F1667, continues to be restricted from being used in wood structural panel shear walls where the minimum nail head size must be maintained in order to minimize nails from pulling through sheathing materials. Clipped or mechanically over-driven nails used in wood structural panel shear wall construction were found to perform much more poorly in previous wood structural panel shear wall testing done at the University of California Irvine. The existing test results indicated that, under cyclic loading, the wood structural panel shear walls were less energy absorbent and less ductile. The panels reached ultimate load capacity and failed at substantially less lateral deflection than those using same size hand-driven nails. This amendment reflects the recommendations by the Structural Engineers Association of Southern California (SEAOSC) and the Los Angeles City Joint Task Force that investigated the poor performance observed in 1994 Northridge Earthquake. This proposed amendment is a continuation of an amendment adopted during previous code adoption cycles.

### FINDINGS:

Local Geological Conditions – The greater Los Angeles region is a densely populated area having buildings and structures constructed over and near a vast array of fault systems capable of producing major earthquakes, including but not limited to the recent 1994 Northridge Earthquake. The proposed modification to require mechanically driven nails to have the same dimensions as hand-driven nail will result in improved quality of construction and performance of wood structural panel shear walls and therefore need to be incorporated into the code to assure that new buildings and structures and additions or alterations to existing buildings or structures are designed and constructed in accordance with the scope and objectives of the California Building Code.

## 2022 LARUCP 23-03

Section 2304.12.2.8 of the 2022 Edition of the California Building Code is amended to read as follows:

**2304.12.2.8 Wood used in retaining walls and cribs.** Wood installed in retaining or crib walls shall be preservative treated in accordance with AWPA U1 for soil and fresh water use. Wood shall not be used in retaining or crib walls for structures assigned to Seismic Design Category D, E or F.

### RATIONALE:

No substantiating data has been provided to show that wood used in retaining or crib walls are effective in supporting buildings and structures during a seismic event while being subject to deterioration caused by the combined detrimental effect of constant moisture in the soil and wood-destroying organisms. Wood used in retaining or crib walls, when they are not properly treated and protected against deterioration, have performed very poorly. Most contractors are typically accustomed to construction in dry and temperate weather in the Southern California region and are not generally familiar with the necessary precautions and treatment of wood that makes it suitable for both seismic event and wet applications. The proposed amendment takes the precautionary steps to reduce or eliminate potential problems that may result by using wood in retaining or crib walls that experience relatively rapid decay due to the fact that the region does not experience temperatures cold enough to destroy or retard the growth and proliferation of wood-destroying organisms. This proposed amendment is a continuation of an amendment adopted during previous code adoption cycles.

### FINDINGS:

Local Climatic and Geological Conditions – The greater Los Angeles region is a densely populated area having buildings and structures constructed over and near a vast array of fault systems capable of producing major earthquakes, including but not limited to the recent 1994 Northridge Earthquake. In addition, the region is within a climate system capable of producing major winds, fire and rain related disasters, including but not limited to those caused by the Santa Ana winds and El Nino (or La Nina) subtropical-like weather. This region is especially susceptible to more active termite and wood attacking insects and microorganisms. The proposed modification to prohibit the use of wood in retaining or crib walls in an effort to mitigate potential problems or deficiencies due to the proliferation of wood-destroying organisms and therefore need to be incorporated into the code to assure that new buildings and structures and additions or alterations to existing buildings or structures are designed and constructed in accordance with the scope and objectives of the California Building Code.

## 2022 LARUCP 23-04

Section 2305.4 is added to Chapter 23 of the 2022 Edition of the California Building Code to read as follows:

**2305.4 Hold-down connectors.** In Seismic Design Category D, E or F, hold-down connectors shall be designed to resist shear wall overturning moments using approved cyclic load values or 75 percent of the allowable seismic load values that do not consider cyclic loading of the product. Connector bolts into wood framing shall require steel plate washers on the post on the opposite side of the anchorage device. Plate size shall be a minimum of 0.229 inch by 3 inches by 3 inches (5.82 mm by 76 mm by 76 mm) in size. Hold-down connectors shall be tightened to finger tight plus one half (1/2) wrench turn just prior to covering the wall framing.

### RATIONALE:

ICC-ES AC 155 Acceptance Criteria for Hold-downs (Tie-Downs) Attached to Wood Members is widely used to establish allowable values for hold-down connectors in evaluation reports. AC 155 uses monotonic loading to establish allowable values. Yet, cyclic and dynamic forces imparted on buildings and structures by seismic activity cause more damage than equivalent forces that are applied in a monotonic manner. However, the engineering, regulatory and manufacturing industries have not reached consensus on the appropriate cyclic or dynamic testing protocols. This condition is expected to continue for some time. In the interim, this proposed amendment continues to limit the allowable capacity to 75% of the evaluation report value to provide an additional factor of safety for statically tested anchorage devices. Steel plate washers will reduce the additional damage that can result when hold-down connectors are fastened to wood framing members. This amendment reflects the recommendations by the Structural Engineers Association of Southern California (SEAOSC) and the Los Angeles City Joint Task Force that investigated the poor performance observed in 1994 Northridge Earthquake. This proposed amendment is a continuation of an amendment adopted during previous code adoption cycles with additional editorial revisions for clarification.

### FINDINGS:

Local Geological Conditions – The greater Los Angeles region is a densely populated area having buildings and structures constructed over and near a vast array of fault systems capable of producing major earthquakes, including but not limited to the recent 1994 Northridge Earthquake. The proposed modification to establish minimum performance requirements for hold-down connectors will reduce failure of wood structural panel shear walls due to excessive deflection and therefore need to be incorporated into the code to assure that new buildings and structures and additions or alterations to existing buildings or structures are designed and constructed in accordance with the scope and objectives of the California Building Code.

## 2022 LARUCP 23-05

Section 2306.2 of the 2022 Edition of the California Building Code is amended to read as follows:

**2306.2 Wood-frame diaphragms.** Wood-frame diaphragms shall be designed and constructed in accordance with AWC SDPWS. Where panels are fastened to framing members with staples, requirements and limitations of AWC SDPWS shall be met and the allowable shear values set forth in Table 2306.2(1) or 2306.2(2) shall only be permitted for structures assigned to Seismic Design Category A, B, or C.

**Exception:** Allowable shear values where panels are fastened to framing members with staples may be used if such values are substantiated by cyclic testing and approved by the building official.

The allowable shear values in Tables 2306.2(1) and 2306.2(2) are permitted to be increased 40 percent for wind design.

Wood structural panels used to resist seismic diaphragm forces in structures assigned to Seismic Design Category D, E or F shall be applied directly to the framing members.

**Exception:** Wood structural panels are permitted to be fastened over solid lumber planking or laminated decking, provided the panel joints and lumber planking or laminated decking joints do not coincide.

### RATIONALE:

The Structural Engineers Association of Southern California (SEAOSC) and the Los Angeles City Joint Task Force that investigated the damages to buildings and structures during the 1994 Northridge Earthquake recommended reducing allowable shear values in wood structural panel shear walls or diaphragms that were not substantiated by cyclic testing. That recommendation was consistent with a report to the Governor from the Seismic Safety Commission of the State of California recommending that code requirements be "more thoroughly substantiated with testing." The allowable shear values for wood structural panel shear walls or diaphragms fastened with staples are based on monotonic testing and does not take into consideration that earthquake forces load shear wall or diaphragm in a repeating and fully reversible manner.

In September 2007, limited cyclic testing was conducted by a private engineering firm to determine if wood structural panels fastened with staples would exhibit the same behavior as the wood structural panels fastened with common nails. The test result revealed that wood structural panel fastened with staples appeared to be much lower in strength and stiffness than wood structural panels fastened with common nails. It was recommended that the use of staples as fasteners for wood structural panel shear walls or diaphragms not be permitted to resist seismic forces in structures assigned to Seismic Design Category D, E and F unless it can be substantiated by cyclic testing.

Furthermore, the cities and county within the Los Angeles region has taken extra measures to maintain the structural integrity of the framing of shear walls and diaphragms designed for high levels of seismic forces by requiring wood sheathing be applied directly over the framing members and prohibiting the use of panels placed over gypsum sheathing. This proposed amendment is intended to prevent the undesirable performance of nails when gypsum board softens due to cyclic earthquake displacements and the nail ultimately does not have any engagement in a solid material within the thickness of the gypsum board.

This proposed amendment continues the previous amendment adopted during the 2010 code adoption cycle.

### FINDINGS:

Local Geological Conditions – The greater Los Angeles region is a densely populated area having buildings and structures constructed over and near a vast array of fault systems capable of producing major earthquakes, including but not limited to the recent 1994 Northridge Earthquake. The proposed modification to place design and construction limits on staples as fasteners used in wood structural panel or diaphragms not substantiated with cyclic testing will help to maintain minimum quality of construction and performance standards of structures and therefore need to be incorporated into the code to assure that new buildings and structures and additions or

alterations to existing buildings or structures are designed and constructed in accordance with the scope and objectives of the California Building Code.



## 2022 LARUCP 23-06

Section 2306.3 of the 2022 Edition of the California Building Code is amended to read as follows:

**2306.3 Wood-frame shear walls.** Wood-frame shear walls shall be designed and constructed in accordance with ANSI/AWC SDPWS. For structures assigned to Seismic Design Category D, E, or F, application of Table 4.3A of ANSI/AWC SDPWS shall include the following:

1. Wood structural panel thickness for shear walls shall not be less than 3/8 inch thick and studs shall not be spaced at more than 16 inches on center.
2. The maximum nominal unit shear capacities for 3/8 inch wood structural panels resisting seismic forces in structures assigned to Seismic Design Category D, E or F is 400 pounds per linear foot (plf).

**Exception:** Other nominal unit shear capacities may be permitted if such values are substantiated by cyclic testing and approved by the building official.

3. Nails shall be placed not less than 1/2 inch in from the panel edges and not less than 3/8 inch from the edge of the connecting members for shear greater than 350 plf using ASD or 500 plf using LRFD. Nails shall be placed not less than 3/8 inch from panel edges and not less than 1/4 inch from the edge of the connecting members for shears of 350 plf or less using ASD or 500 plf or less using LRFD.

For structures assigned to Seismic Design Category D, E or F, application of Table 4.3B of ANSI/AWC SDPWS shall not be allowed.

For structures assigned to Seismic Design Category D, E or F, application of Table 4.3C of ANSI/AWC SDPWS shall not be used below the top level in a multi-level building.

Where panels are fastened to framing members with staples, requirements and limitations of AWC SDPWS shall be met and the allowable shear values set forth in Table 2306.3(1), 2306.3(2) or 2306.3(3) shall only be permitted for structures assigned to Seismic Design Category A, B, or C.

**Exception:** Allowable shear values where panels are fastened to framing members with staples may be used if such values are substantiated by cyclic testing and approved by the building official.

The allowable shear values in Tables 2306.3(1) and 2306.3(2) are permitted to be increased 40 percent for wind design. Panels complying with ANSI/APA PRP-210 shall be permitted to use design values for Plywood Siding in the ANSI/AWC SDPWS.

### RATIONALE:

The Structural Engineers Association of Southern California (SEAOSC) and the Los Angeles City Joint Task Force that investigated the damages to buildings and structures during the 1994 Northridge Earthquake recommended reducing allowable shear values in wood structural panel shear walls or diaphragms that were not substantiated by cyclic testing. That recommendation was consistent with a report to the Governor from the Seismic Safety Commission of the State of California recommending that code requirements be "more thoroughly substantiated with testing." The allowable shear values for wood structural panel shear walls or diaphragms fastened with stapled nails are based on monotonic testing and does not take into consideration that earthquake forces load shear wall or diaphragm in a repeating and fully reversible manner.

In September 2007, limited cyclic testing was conducted by a private engineering firm to determine if wood structural panels fastened with stapled nails would exhibit the same behavior as the wood structural panels fastened with common nails. The test result revealed that wood structural panel fastened with stapled nails appeared to be much lower in strength and stiffness than wood structural panels fastened with common nails. It was recommended that the use of stapled nail as fasteners for wood structural panel shear walls or diaphragms not be permitted to resist seismic forces in structures assigned to Seismic Design Category D, E and F unless it can be substantiated by cyclic testing.

Furthermore, the cities and county within the Los Angeles region has taken extra measures to maintain the structural integrity of the framing of shear walls and diaphragms designed for high levels of seismic forces by requiring wood sheathing be applied directly over the framing members and prohibiting the use of panels placed over gypsum sheathing. This proposed amendment is intended to prevent the undesirable performance of nails when gypsum board softens due to cyclic earthquake displacements and the nail ultimately does not have any engagement in a solid material within the thickness of the gypsum board.

This proposed amendment continues the previous amendment adopted during the 2010 code adoption cycle.

**FINDINGS:**

Local Geological Conditions – The greater Los Angeles region is a densely populated area having buildings and structures constructed over and near a vast array of fault systems capable of producing major earthquakes, including but not limited to the recent 1994 Northridge Earthquake. The proposed modification to place design and construction limits on stapled nail fasteners used in wood structural panel shear walls or diaphragms not substantiated with cyclic testing will help to maintain minimum quality of construction and performance standards of structures and therefore need to be incorporated into the code to assure that new buildings and structures and additions or alterations to existing buildings or structures are designed and constructed in accordance with the scope and objectives of the California Building Code.

## 2022 LARUCP 23-07

Section 2307.2 is added to the 2022 Edition of the California Building Code to read as follows:

**2307.2 Wood-frame shear walls.** Wood-frame shear walls shall be designed and constructed in accordance with Section 2306.3 as applicable.

### RATIONALE:

The Structural Engineers Association of Southern California (SEAOSC) and the Los Angeles City Joint Task Force that investigated the damages to buildings and structures during the 1994 Northridge Earthquake recommended reducing allowable shear values in wood structural panel shear walls or diaphragms that were not substantiated by cyclic testing. That recommendation was consistent with a report to the Governor from the Seismic Safety Commission of the State of California recommending that code requirements be "more thoroughly substantiated with testing." The allowable shear values for wood structural panel shear walls or diaphragms fastened with stapled nails are based on monotonic testing and does not take into consideration that earthquake forces load shear wall or diaphragm in a repeating and fully reversible manner.

In September 2007, limited cyclic testing was conducted by a private engineering firm to determine if wood structural panels fastened with stapled nails would exhibit the same behavior as the wood structural panels fastened with common nails. The test result revealed that wood structural panel fastened with stapled nails appeared to be much lower in strength and stiffness than wood structural panels fastened with common nails. It was recommended that the use of stapled nail as fasteners for wood structural panel shear walls or diaphragms not be permitted to resist seismic forces in structures assigned to Seismic Design Category D, E and F unless it can be substantiated by cyclic testing.

Furthermore, the cities and county within the Los Angeles region has taken extra measures to maintain the structural integrity of the framing of shear walls and diaphragms designed for high levels of seismic forces by requiring wood sheathing be applied directly over the framing members and prohibiting the use of panels placed over gypsum sheathing. This proposed amendment is intended to prevent the undesirable performance of nails when gypsum board softens due to cyclic earthquake displacements and the nail ultimately does not have any engagement in a solid material within the thickness of the gypsum board.

This proposed amendment continues the previous amendment adopted during the 2010 code adoption cycle.

### FINDINGS:

Local Geological Conditions – The greater Los Angeles region is a densely populated area having buildings and structures constructed over and near a vast array of fault systems capable of producing major earthquakes, including but not limited to the recent 1994 Northridge Earthquake. The proposed modification to place design and construction limits on stapled nail fasteners used in wood structural panel shear walls or diaphragms not substantiated with cyclic testing will help to maintain minimum quality of construction and performance standards of structures and therefore need to be incorporated into the code to assure that new buildings and structures and additions or alterations to existing buildings or structures are designed and constructed in accordance with the scope and objectives of the California Building Code.

### 2022 LARUCP 23-08

Table 2308.6.1 of the 2022 Edition of the California Building Code is amended to read as follows:

**TABLE 2308.6.1<sup>a</sup>  
WALL BRACING REQUIREMENTS**

SEISMIC DESIGN CATEGORY	STORY CONDITION (SEE SECTION 2308.2)	MAXIMUM SPACING OF BRACED WALL LINES	BRACED PANEL LOCATION, SPACING (O.C.) AND MINIMUM PERCENTAGE (X)			MAXIMUM DISTANCE OF BRACED WALL PANELS FROM EACH END OF BRACED WALL LINE
			Bracing method <sup>b</sup>			
			LIB	DWB, WSP	SFB, PBS, PCP, HPS, GB <sup>c,d</sup>	
A and B		35'- 0"	Each end and ≤ 25'- 0" o.c.	Each end and ≤ 25'- 0" o.c.	Each end and ≤ 25'- 0" o.c.	12'- 6"
		35'- 0"	Each end and ≤ 25'- 0" o.c.	Each end and ≤ 25'- 0" o.c.	Each end and ≤ 25'- 0" o.c.	12'- 6"
		35'- 0"	NP	Each end and ≤ 25'- 0" o.c.	Each end and ≤ 25'- 0" o.c.	12'- 6"
C		35'- 0"	NP	Each end and ≤ 25'- 0" o.c.	Each end and ≤ 25'- 0" o.c.	12'- 6"
		35'- 0"	NP	Each end and ≤ 25'- 0" o.c. (minimum 25% of wall length) <sup>e</sup>	Each end and ≤ 25'- 0" o.c. (minimum 25% of wall length) <sup>e</sup>	12'- 6"
D and E <b>f, g, h</b>		25'- 0"	NP	$S_{DS} < 0.50$ : Each end and ≤ 25'- 0" o.c. (minimum 21% of wall length) <sup>e</sup>	$S_{DS} < 0.50$ : Each end and ≤ 25'- 0" o.c. (minimum 43% of wall length) <sup>e</sup>	8'- 0"
				$0.5 \leq S_{DS} < 0.75$ : Each end and ≤ 25'- 0" o.c. (minimum 32% of wall length) <sup>e</sup>	$0.5 \leq S_{DS} < 0.75$ : Each end and ≤ 25'- 0" o.c. (minimum 59% of wall length) <sup>e</sup>	
				$0.75 \leq S_{DS} \leq 1.00$ : Each end and ≤ 25'- 0" o.c. (minimum 37% of wall length) <sup>e</sup>	$0.75 \leq S_{DS} \leq 1.00$ : Each end and ≤ 25'- 0" o.c. (minimum 75% of wall length)	
				$S_{DS} > 1.00$ : Each end and ≤ 25'- 0" o.c. (minimum 48% of wall length) <sup>e</sup>	$S_{DS} > 1.00$ : Each end and ≤ 25'- 0" o.c. (minimum 100% of wall length) <sup>e</sup>	

For SI: 1 inch = 25.4 mm, 1 foot = 304.8 mm.

NP = Not Permitted.

a. This table specifies minimum requirements for braced wall panels along interior or exterior braced wall lines.

b. See Section 2308.6.3 for full description of bracing methods.

c. For Method GB, gypsum wallboard applied to framing supports that are spaced at 16 inches on center.

d. The required lengths shall be doubled for gypsum board applied to only one face of a braced wall panel.

e. Percentage shown represents the minimum amount of bracing required along the building length (or wall length if the structure has an irregular shape).

f. DWB, SFB, PBS, and HPS wall braces are not permitted in Seismic Design Categories D or E.

g. Minimum length of panel bracing of one face of the wall for WSP sheathing shall be at least 4'-0" long or both faces of the wall for GB or PCP sheathing shall be at least 8'-0" long; h/w ratio shall not exceed 2:1. Wall framing to which sheathing used for bracing is applied shall be nominal 2 inch wide [actual 1 1/2 inch (38 mm) or larger members and spaced a maximum of 16 inches on center. Braced wall panel construction types shall not be mixed within a braced wall line.

h. WSP sheathing shall be a minimum of 15/32" thick nailed with 8d common placed 3/8 inches from panel edges and spaced not more than 6 inches on center and 12 inches on center along intermediate framing members.

**RATIONALE:**

This proposed amendment specifies minimum sheathing thickness and nail size and spacing so as to provide a uniform standard of construction for designers and buildings to follow. This is intended to improve the performance level of buildings and structures that are subject to the higher seismic demands placed on buildings or structure in this region. This proposed amendment reflects the recommendations by the Structural Engineers Association of Southern California (SEAOSC) and the Los Angeles City Joint Task Force that investigated the poor performance observed in 1994 Northridge Earthquake. This proposed amendment is a continuation of an amendment adopted during previous code adoption cycles.

**FINDINGS:**

Local Geological Conditions – The greater Los Angeles region is a densely populated area having buildings and structures constructed over and near a vast array of fault systems capable of producing major earthquakes, including but not limited to the recent 1994 Northridge Earthquake. Conventional framing does not address the need for a continuous load path, critical shear transfer mechanisms, connection-ties, irregular and flexible portions of complex shaped structures. The proposed modification to provide specific detailing requirements will improve the performance of buildings and structures and therefore needs to be incorporated into the code to assure that new buildings and additions to existing buildings are designed and constructed in accordance with the scope and objectives of the California Building Code.

## 2022 LARUCP 23-09

Sections 2308.6.5.1 and 2308.6.5.2 and Figures 2308.6.5.1 and 2308.6.5.2 of the 2022 Edition of the California Building Code are amended to read as follows:

**2308.6.5.1 Alternate braced wall (ABW).** An ABW shall be constructed in accordance with this section and Figure 2308.6.5.1. In one-story buildings, each panel shall have a length of not less than 2 feet 8 inches (813 mm) and a height of not more than 10 feet (3048 mm). Each panel shall be sheathed on one face with 3/8-inch (3.2 mm) minimum-thickness wood structural panel sheathing nailed with 8d common or galvanized box nails in accordance with Table 2304.10.1 and blocked at wood structural panel edges. For structures assigned to Seismic Design Category D or E, each panel shall be sheathed on one face with 15/32-inch-minimum-thickness (11.9 mm) wood structural panel sheathing nailed with 8d common nails spaced 3 inches on panel edges, 3 inches at intermediate supports. Two anchor bolts installed in accordance with Section 2308.3.1 shall be provided in each panel. Anchor bolts shall be placed at each panel outside quarter points. Each panel end stud shall have a hold-down device fastened to the foundation, capable of providing an approved uplift capacity of not less than 1,800 pounds (8006 N). The hold-down device shall be installed in accordance with the manufacturer's recommendations. The ABW shall be supported directly on a foundation or on floor framing supported directly on a foundation that is continuous across the entire length of the braced wall line. This foundation shall be reinforced with not less than one No. 4 bar top and bottom. Where the continuous foundation is required to have a depth greater than 12 inches (305 mm), a minimum 12-inch by 12-inch (305 mm by 305 mm) continuous footing or ~~turned-down slab edge~~ is permitted at door openings in the braced wall line. This continuous footing or ~~turned-down slab edge~~ shall be reinforced with not less than one No. 4 bar top and bottom. This reinforcement shall be lapped ~~45~~ 24 inches (384 610 mm) with the reinforcement required in the continuous foundation located directly under the braced wall line.

Where the ABW is installed at the first story of two-story buildings, the wood structural panel sheathing shall be provided on both faces, three anchor bolts shall be placed at one-quarter points and tie-down device uplift capacity shall be not less than 3,000 pounds (13 344 N).

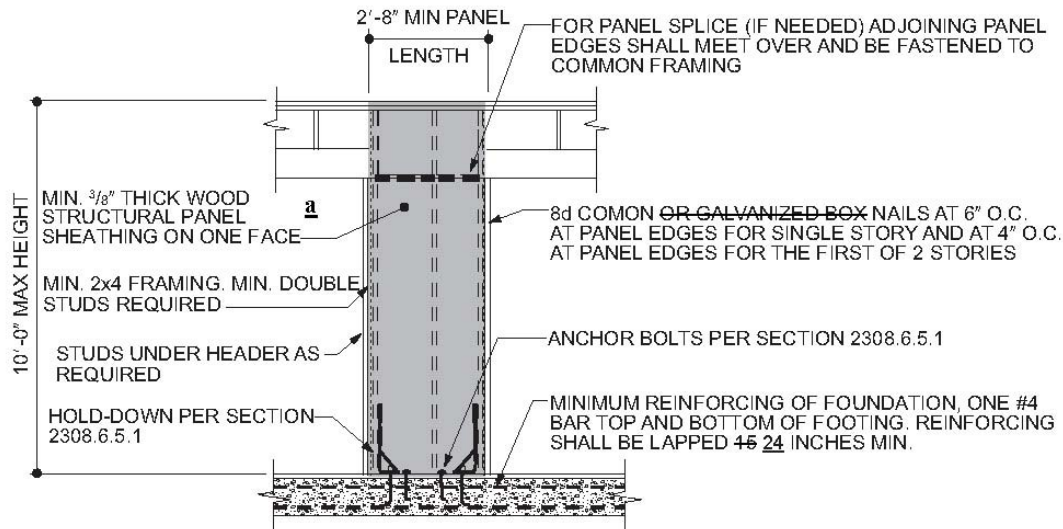

For SI: 1 inch = 25.4 mm, 1 foot = 304.8 mm.

a. For structures assigned to Seismic Design Category D or E, sheathed on one face with 15/32-inch-minimum-thickness (11.9 mm) wood structural panel sheathing.

**FIGURE 2308.6.5.1  
ALTERNATE BRACED WALL PANEL (ABW)**

**2308.6.5.2 Portal frame with hold-downs (PFH).** A PFH shall be constructed in accordance with this section and Figure 2308.6.5.2. The adjacent door or window opening shall have a full-length header.

In one-story buildings, each panel shall have a length of not less than 16 inches (406 mm) and a height of not more than 10 feet (3048 mm). Each panel shall be sheathed on one face with a single layer of 3/8-inch (9.5 mm) minimum-thickness wood structural panel sheathing nailed with 8d common or galvanized box nails in accordance with Figure 2308.6.5.2. For structures assigned to Seismic Design Category D or E, each panel shall be sheathed on one face with 15/32-inch-minimum-thickness (11.9 mm) wood structural panel sheathing nailed with 8d



common nails spaced 3 inches on panel edges, 3 inches at intermediate supports and in accordance with Figure 2308.6.5.2. The wood structural panel sheathing shall extend up over the solid sawn or glued-laminated header and shall be nailed in accordance with Figure 2308.6.5.2. A built-up header consisting of at least two 2-inch by 12-inch (51 mm by 305 mm) boards, fastened in accordance with Item 26 of Table 2304.10.2 shall be permitted to be used. A spacer, if used, shall be placed on the side of the built-up beam opposite the wood structural panel sheathing. The header shall extend between the inside faces of the first full-length outer studs of each panel. The clear span of the header between the inner studs of each panel shall be not less than 6 feet (1829 mm) and not more than 18 feet (5486 mm) in length. A strap with an uplift capacity of not less than 1,000 pounds (4,400 N) shall fasten the header to the inner studs opposite the sheathing. One anchor bolt not less than 5/8 inch (15.9 mm) diameter and installed in accordance with Section 2308.3.1 shall be provided in the center of each sill plate. The studs at each end of the panel shall have a hold-down device fastened to the foundation with an uplift capacity of not less than 3,500 pounds (15 570 N).

Where a panel is located on one side of the opening, the header shall extend between the inside face of the first full-length stud of the panel and the bearing studs at the other end of the opening. A strap with an uplift capacity of not less than 1,000 pounds (4400 N) shall fasten the header to the bearing studs. The bearing studs shall also have a hold-down device fastened to the foundation with an uplift capacity of not less than 1,000 pounds (4400 N). The hold-down devices shall be an embedded strap type, installed in accordance with the manufacturer's recommendations. The PFH panels shall be supported directly on a foundation that is continuous across the entire length of the braced wall line. This foundation shall be reinforced with not less than one No. 4 bar top and bottom. Where the continuous foundation is required to have a depth greater than 12 inches (305 mm), a minimum 12-inch by 12-inch (305 mm by 305 mm) continuous footing or turned-down slab edge is permitted at door openings in the braced wall line. This continuous footing or turned-down slab edge shall be reinforced with not less than one No. 4 bar top and bottom. This reinforcement shall be lapped not less than 15 24 inches (384 610 mm) with the reinforcement required in the continuous foundation located directly under the braced wall line.

Where a PFH is installed at the first story of two-story buildings, each panel shall have a length of not less than 24 inches (610 mm).

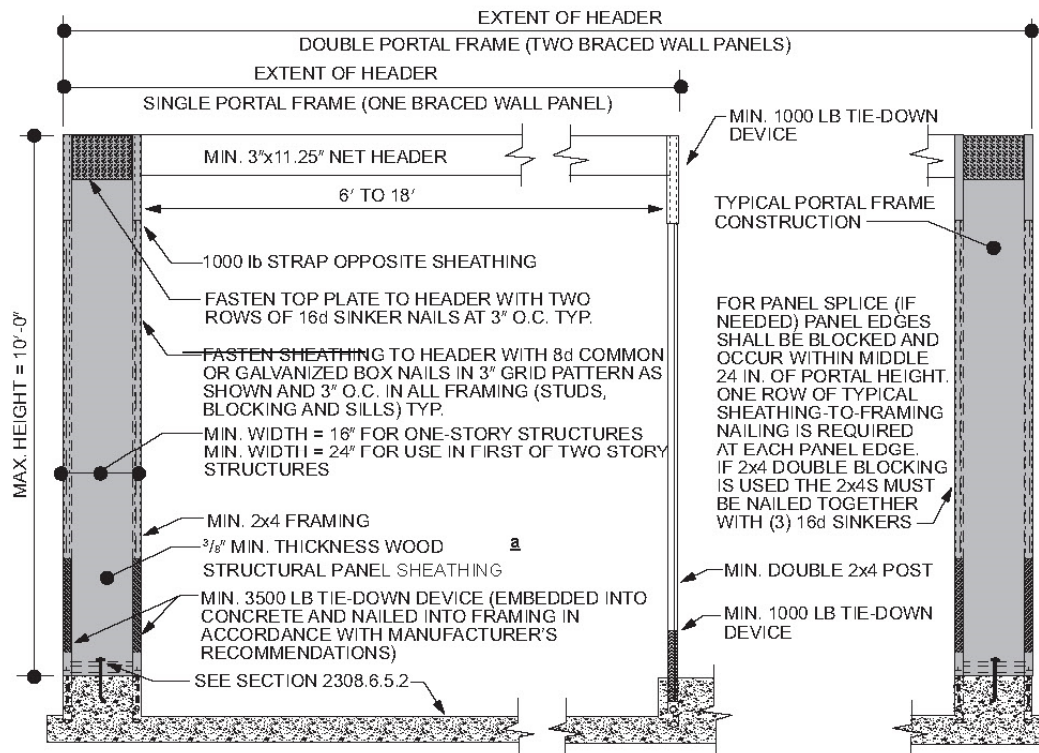

For SI: 1 inch = 25.4 mm, 1 foot = 304.8 mm, 1 pound = 4.448 N.

**a.** For structures assigned to Seismic Design Category D or E, sheathed on one face with 15/32-inch-minimum-thickness (11.9 mm) wood structural panel sheathing.

**FIGURE 2308.6.5.2**  
**PORTAL FRAME WITH HOLD-DOWNS (PFH)**

**RATIONALE:**

3/8" thick, 3 ply-plywood shear walls experienced many failures during the Northridge Earthquake. Box nails were observed to cause massive and multiple failures of the typical 3/8" thick 3-ply plywood during the Northridge Earthquake. This proposed amendment specifies minimum sheathing thickness, nail size and spacing so as to provide a uniform standard of construction for designers and buildings to follow. This is intended to improve the performance level of buildings and structures that are subject to the higher seismic demands and reduce and limit potential damages to property. This proposed amendment reflects the recommendations by the Structural Engineers Association of Southern California (SEAOSC) and the Los Angeles City Joint Task Force that investigated the poor performance observed in 1994 Northridge Earthquake.

**FINDINGS:**

Local Geological Conditions – The greater Los Angeles region is a densely populated area having buildings and structures constructed over and near a vast array of fault systems capable of producing major earthquakes, including but not limited to the recent 1994 Northridge Earthquake. The proposed modification requiring minimum sheathing thickness and nailing type and size will help to maintain minimum quality of construction and performance standards of structures and therefore needs to be incorporated into the code to assure that new buildings and additions to existing buildings are designed and constructed in accordance with the scope and objectives of the California Building Code.

## 2022 LARUCP 23-10

Section 2308.6.8.1 of the 2022 Edition of the California Building Code is amended to read as follows:

**2308.6.8.1 Foundation requirements.** Braced wall lines shall be supported by continuous foundations.

**Exception:** For structures with a maximum plan dimension not more than 50 feet (15240 mm), continuous foundations are required at exterior walls only for structures assigned to Seismic Design Category A, B, or C.

For structures in Seismic Design Categories D and E, exterior braced wall panels shall be in the same plane vertically with the foundation or the portion of the structure containing the offset shall be designed in accordance with accepted engineering practice and Section 2308.1.1.

### Exceptions:

- ~~1. Exterior braced wall panels shall be permitted to be located not more than 4 feet (1219 mm) from the foundation below where supported by a floor constructed in accordance with all of the following:
 
  - ~~1.1. Cantilevers or setbacks shall not exceed four times the nominal depth of the floor joists.~~
  - ~~1.2. Floor joists shall be 2 inches by 10 inches (51 mm by 254 mm) or larger and spaced not more than 16 inches (406 mm) on center.~~
  - ~~1.3. The ratio of the back span to the cantilever shall be not less than 2 to 1.~~
  - ~~1.4. Floor joists at ends of braced wall panels shall be doubled.~~
  - ~~1.5. A continuous rim joist shall be connected to the ends of cantilevered joists. The rim joist is permitted to be spliced using a metal tie not less than 0.058 inch (1.47 mm) (16 galvanized gage) and 1 1/2 inches (38 mm) in width fastened with six 16d common nails on each side. The metal tie shall have a yield stress not less than 33,000 psi (227 MPa).~~
  - ~~1.6. Joists at setbacks or the end of cantilevered joists shall not carry gravity loads from more than a single story having uniform wall and roof loads nor carry the reactions from headers having a span of 8 feet (2438 mm) or more.~~~~
- ~~2. The end of a required braced wall panel shall be allowed to extend not more than 1 foot (305 mm) over an opening in the wall below. This requirement is applicable to braced wall panels offset in plane and braced wall panels offset out of plane as permitted by Exception 1. Braced wall panels are permitted to extend over an opening not more than 8 feet (2438 mm) in width where the header is a 4-inch by 12-inch (102 mm by 305 mm) or larger member.~~

### RATIONALE:

With the higher seismic demand placed on buildings and structures in this region, interior walls can easily be called upon to resist over half of the seismic loading imposed on simple buildings or structures. Without a continuous foundation to support the braced wall line, seismic loads would be transferred through other elements such as non-structural concrete slab floors, wood floors, etc. The proposed change is to limit the use of the exception to structures assigned to Seismic Design Category A, B or C where lower seismic demands are expected. Requiring interior braced walls be supported by continuous foundations is intended to reduce or eliminate the poor performance of buildings or structures. This proposed amendment is a continuation of an amendment adopted during previous code adoption cycles.

### FINDINGS:

Local Geological Conditions – The greater Los Angeles region is a densely populated area having buildings and structures constructed over and near a vast array of fault systems capable of producing major earthquakes,

including but not limited to the recent 1994 Northridge Earthquake. Conventional framing does not address the need for a continuous load path, critical shear transfer mechanisms, connection-ties, irregular and flexible portions of complex shaped structures. The proposed modification to require continuous footings under braced wall lines will improve performance of buildings or structure during a seismic event and therefore need to be incorporated into the code to assure that new buildings and additions to existing buildings are designed and constructed in accordance with the scope and objectives of the California Building Code.

## 2022 LARUCP 23-11

Section 2308.6.9 of the 2022 Edition of the California Building Code is amended to read as follows:

**2308.6.9 Attachment of sheathing.** Fastening of braced wall panel sheathing shall not be less than that prescribed in Tables 2308.6.1 or 2304.10.2. Wall sheathing shall not be attached to framing members by adhesives. Staple fasteners in Table 2304.10.2 shall not be used to resist or transfer seismic forces in structures assigned to Seismic Design Category D, E or F.

**Exception:** Staples may be used to resist or transfer seismic forces when the allowable shear values are substantiated by cyclic testing and approved by the building official.

All braced wall panels shall extend to the roof sheathing and shall be attached to parallel roof rafters or blocking above with framing clips (18 gauge minimum) spaced at a maximum of 24 inches (6096 mm) on center with four 8d nails per leg (total eight 8d nails per clip, minimum). Braced wall panels shall be laterally braced at each top corner and at intervals not to exceed 24 inches (6096 mm) along the top plate of discontinuous vertical framing.

### RATIONALE:

This proposed amendment is intended to improve the performance level of buildings and structures that are subject to the higher seismic demands placed on buildings or structure in this region. This proposed amendment reflects the recommendations by the Structural Engineers Association of Southern California (SEAOSC) and the Los Angeles City Joint Task Force that investigated the poor performance observed in 1994 Northridge Earthquake. This proposed amendment is a continuation of an amendment adopted during previous code adoption cycles.

### FINDINGS:

Local Geological Conditions – The greater Los Angeles region is a densely populated area having buildings and structures constructed over and near a vast array of fault systems capable of producing major earthquakes, including but not limited to the recent 1994 Northridge Earthquake. Conventional framing does not address the need for a continuous load path, critical shear transfer mechanisms, connection-ties, irregular and flexible portions of complex shaped structures. The proposed modification to provide specific detailing requirements will improve the performance of buildings and structures and therefore needs to be incorporated into the code to assure that new buildings and additions to existing buildings are designed and constructed in accordance with the scope and objectives of the California Building Code.

## 2022 LARUCP 31-01

Section 3115 of the 2022 Edition of the California Building Code is amended to read as follows:

### SECTION 3115 INTERMODAL SHIPPING CONTAINERS

**3115.1 General.** The provisions of Section 3115 and other applicable sections of this code shall apply to intermodal shipping containers that are repurposed for use as buildings or structures or as a part of buildings or structures.

**Exceptions:**

1. Intermodal shipping containers previously approved as existing relocatable buildings complying with Chapter 14 of the California Existing Building Code.
2. Stationary battery storage arrays located in intermodal shipping containers complying with Chapter 12 of the California Fire Code.
3. Intermodal shipping containers that are listed as equipment complying with the standard for equipment, such as air chillers, engine generators, modular data centers, and other similar equipment.
4. Intermodal shipping containers housing or supporting experimental equipment are exempt from the requirements of Section 3115, provided they comply with all of the following:
  - 4.1. Such units will be single stand-alone units supported at grade level and used only for occupancies as specified under Risk Category I in Table 1604.5.
  - 4.2. Such units are located a minimum of 8 feet (2438 mm) from adjacent structures, and are not connected to a fuel gas system or fuel gas utility.
  - 4.3. In hurricane-prone regions and flood hazard areas, such units are designed in accordance with the applicable provisions of Chapter 16.
5. *[HCD] Shipping containers constructed or converted off-site that meet the definition of Factory-built Housing in Health and Safety Code Section 19971 or Commercial Modular(s) as defined in Health and Safety Code Section 18001.8 shall be approved by the Department of Housing and Community Development.*
6. Single-unit stand-alone intermodal shipping containers used as temporary storage or construction trailer on active construction sites. Construction support facilities for uses and activities not directly associated with the actual processes of construction, including but not limited to, offices, meeting rooms, plan rooms, other administrative or support functions shall not be exempt from Section 3115.

**3115.2 Construction documents.** The construction documents shall contain information to verify the dimensions and establish the physical properties of the steel components and wood floor components of the intermodal shipping container, in addition to the information required by Sections 107 and 1603.

**3115.3 Intermodal shipping container information.** Intermodal shipping containers shall bear an existing data plate containing the following information as required by ISO 6346 and verified by an approved agency. A report of the verification process and findings shall be provided to the building owner.

1. Manufacturer's name or identification number.
2. Date manufactured.
3. Safety approval number.

4. Identification number.
5. Maximum operating gross mass or weight (kg) (lbs).
6. Allowable stacking load for 1.8G (kg) (lbs).
7. Transverse racking test force (Newtons).
8. Valid maintenance examination date.

Where approved by the building official, the markings and existing data plate are permitted to be removed from the intermodal shipping containers before they are repurposed for use as buildings or structures or as part of buildings or structures.

**3115.4 Protection against decay and termites.** Wood structural floors of intermodal shipping containers shall be protected from decay and termites in accordance with the applicable provisions of Section 2304.12.1.1.

**3115.5 Under-floor ventilation.** The space between the bottom of the floor joists and the earth under any intermodal shipping container, except spaces occupied by basements and cellars, shall be provided with ventilation in accordance with Section 1202.4.

**3115.6 Roof assemblies.** Intermodal shipping container roof assemblies shall comply with the applicable requirements of Chapter 15.

**Exception:** Single-unit, stand-alone intermodal shipping containers not attached to, or stacked vertically over, other intermodal shipping containers, buildings or structures.

**3115.7 Joints and voids.** Joints and voids that create concealed spaces between intermodal shipping containers, that are connected or stacked, at fire-resistance-rated walls, floor or floor/ceiling assemblies and roofs or roof/ceiling assemblies shall be protected by an approved fire-resistant joint system in accordance with Section 715.

**3115.8 Structural.** Intermodal shipping containers that conform to ISO 1496-1 and are repurposed for use as buildings or structures, or as a part of buildings or structures, shall be designed in accordance with Chapter 16 and this section.

**3115.8.1 Foundations and supports.** Intermodal shipping containers repurposed for use as a permanent building or structure shall be supported on foundations or other supporting structures designed and constructed in accordance with Chapters 16 through 23.

**3115.8.1.1 Anchorage.** Intermodal shipping containers shall be anchored to foundations or other supporting structures as necessary to provide a continuous load path for all applicable design and environmental loads in accordance with Chapter 16.

**3115.8.1.2 Stacking.** Intermodal shipping containers used to support stacked units shall comply with Section 3115.8.4.

**3115.8.2 Welds.** ~~New welds and connections shall be equal to or greater than the original connections. The strength of new welds and connections shall be no less than the strength provided by the original connections. All new welds and connections shall be designed and constructed in accordance with Chapters 16, 17 and 22.~~

**3115.8.3 Structural design.** The structural design of the intermodal shipping containers repurposed for use as a building or structure, or as part of a building or structure, shall comply with Section 3115.8.4 or 3115.8.5.

**3115.8.4 Detailed structural design procedure.** A structural analysis meeting the requirements of this section shall be provided to the building official to demonstrate the structural adequacy of the intermodal shipping containers.



**Exception:** ~~Intermodal~~ Structures using an intermodal shipping containers designed in accordance with Section 3115.8.5.

**3115.8.4.1 Material properties.** Structural material properties for existing intermodal shipping container steel components shall be established by ~~material testing where the steel grade and composition cannot be identified by the manufacturer's designation as to manufacture and mill test~~ Section 2202.

**3115.8.4.2 Seismic design parameters.** The seismic force-resisting system shall be designed and detailed in accordance with ASCE 7 and one of the following:

1. Where all or portions of the ~~corrugated steel container sides~~ profiled steel panel elements are considered to be the seismic force-resisting system, design and detailing shall be in accordance with ~~the AISI S100 and ASCE 7, Table 12.2-1 requirements for light frame bearing wall systems with shear panels of all other materials~~ steel systems not specifically detailed for seismic resistance, excluding cantilevered column systems.
2. Where all or portions of the profiled steel panel elements are ~~retained, but are~~ not considered to be part of the seismic force-resisting system, an independent seismic force-resisting system shall be selected, ~~designed~~ and detailed in accordance with ASCE 7, Table 12.2-1, or
3. Where all or portions of the profiled steel panel elements are retained and integrated into a seismic force-resisting system other than as permitted by Section 3115.8.4.2 Item 1, seismic design parameters shall be developed from testing and analysis in accordance with Section 104.11 and ASCE 7, Section 12.2.1.1 or 12.2.1.2.

**3115.8.4.3 Allowable shear value.** The allowable shear values for the ~~intermodal shipping container~~ profiled steel panel side walls and end walls shall be ~~demonstrated by testing and analysis accordance with Section 104.11~~ determined in accordance with the design approach selected in Section 3115.8.4.2. Where penetrations are made in the side walls or end walls designated as part of the lateral force-resisting system, the penetrations shall be substantiated by rational analysis.

**3115.8.5 Simplified structural design procedure of single-unit containers.** Single-unit intermodal shipping containers conforming to the limitations of Section 3115.8.5.1 shall be permitted to be designed in accordance with Sections 3115.8.5.2 and 3115.8.5.3.

**3115.8.5.1 Limitations.** Use of Section 3115.8.5 is subject to all the following limitations:

1. The intermodal shipping container shall be a single-unit, stand-alone unit supported on a foundation and shall not be in contact with or supporting any other shipping container or other structure.
2. The intermodal shipping container's top and bottom rails, corner castings, and columns or any portion thereof shall not be notched, cut, or removed in any manner.
3. The intermodal shipping container shall be erected in a level and horizontal position with the floor located at the bottom.
4. The intermodal shipping container shall be located in Seismic Design Category A, B, C and D.

**3115.8.5.2 Simplified structural design assumptions.** Where permitted by Section 3115.8.5.1, single-unit stand-alone, intermodal shipping containers shall be designed using the following assumptions for the profiled steel panel side walls and end walls:

1. The appropriate detailing requirements contained in Chapters 16 through 23.
2. Response modification coefficient,  $R = 2$ .
3. Over strength factor,  $\Omega_o = 2.5$ .

4. Deflection amplification factor,  $C_d = 2$ .
5. Limits on structural height,  $h_n = 9.5$  feet (2900 mm).

**3115.8.5.3 Allowable shear value.** The allowable shear values for the ~~intermodal shipping container~~ profiled steel panel side walls (longitudinal) and end walls (transverse) for wind design and seismic design using the coefficients of Section 3115.8.5.2 shall be in accordance with Table 3115.8.5.3, provided that all of the following conditions are met:

1. The total linear length of all openings in any individual side walls or end walls shall be limited to not more than 50 percent of the length of that side walls or end walls, as shown in Figure 3115.8.5.3(1).
2. Any full height wall length, or portion thereof, less than 4 feet (305 mm) long shall not be considered as a portion of the lateral force-resisting system, as shown in Figure 3115.8.5.3(2).
3. All side walls or end walls used as part of the lateral force-resisting system shall have an existing or new boundary element on all sides to form a continuous load path, or paths, with adequate strength and stiffness to transfer all forces from the point of application to the final point of resistance, as shown in Figure 3115.8.5.3(3). The existing door interlocking mechanism shall not be considered as a component of the required load path.
4. Where openings are made in container walls, floors or roofs, for doors, windows and other openings:
  - 4.1 The opening shall be framed with steel elements that are designed in accordance with Chapters 16 and 22.
  - 4.2 The cross section and material grade of any new steel element shall be equal to or greater than the steel element removed.
5. A maximum of one penetration not greater than a 6-inch (152 mm) diameter hole for conduits, pipes, tubes or vents, or not greater than 16 square inches (10 322mm<sup>2</sup>) for electrical boxes, is permitted for each individual 8 feet (2438 mm) length of lateral force-resisting wall. Penetrations located in walls that are not part of the wall lateral force resisting system shall not be limited in size or quantity. Existing intermodal shipping container's vents shall not be considered a penetration, as shown in Figure 3115.8.5.3(4).
6. End wall door or doors designated as part of the lateral force-resisting system shall be intermittently welded closed around the full perimeters of the door panels.

**TABLE 3115.8.5.3**  
**ALLOWABLE SHEAR VALUES FOR INTERMODAL SHIPPING CONTAINER PROFILED STEEL PANEL**  
**SIDE WALLS AND END WALLS FOR WIND OR SEISMIC LOADING**

CONTAINER DESIGNATION <sup>b</sup>	CONTAINER DIMENSION (Nominal Length)	CONTAINER DIMENSION (Nominal Height)	ALLOWABLE SHEAR VALUES (PLF) <sup>a,c</sup>	
			Side Wall	End Wall
1EEE	45 feet (13.7 M)	9.5 feet (2896 mm)	75	843
1EE		8.6 feet (2591 mm)		
1AAA	40 feet (12.2 M)	9.5 feet (2896 mm)	84	
1AA		8.5 feet (2592 mm)		
1A		8.0 feet (2438 mm)		
1AX		<8.0 feet (2483 mm)		
1BBB	30 feet (9.1 M)	9.5 feet (2896 mm)	112	
1BB		8.5 feet (2591 mm)		
1B		8.0 feet (2438 mm)		
1BX		<8.0 feet (2438 mm)		
1CC	20 feet (9.1 M)	8.5 feet (2591 mm)	168	
1C		8.0 feet (2438 mm)		
1CX		<8.0 feet (2438 mm)		

- a. The allowable strength-shear values for the side walls and end walls of the intermodal shipping containers are derived from ISO 1496-1 and reduced by a factor of safety of 5.
- b. Container designation type is derived from ISO 668.
- c. Limitations of Sections 3115.8.5.1 and 3115.8.5.3 shall apply.

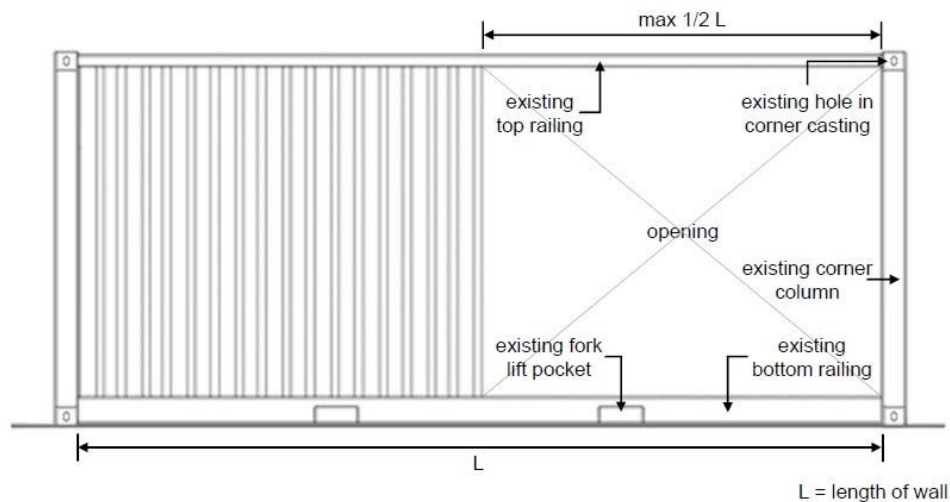

**FIGURE 3115.8.5.3(1)**  
**Bracing Unit Distribution – Maximum Linear Length**

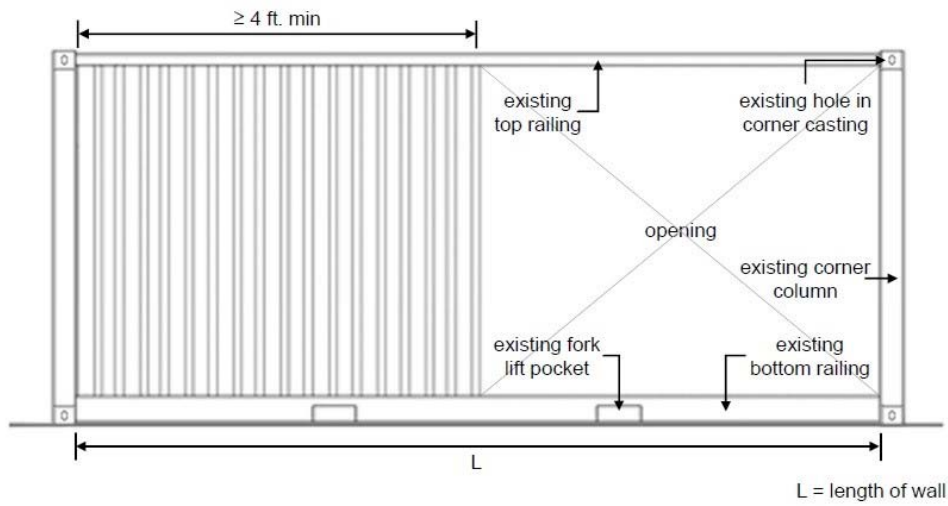

**FIGURE 3115.8.5.3(2)**  
**Bracing Unit Distribution – Minimum Linear Length**

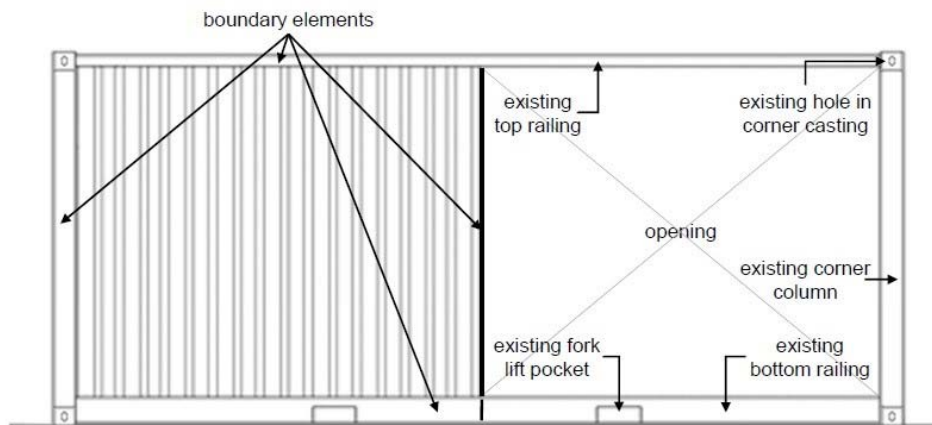

**FIGURE 3115.8.5.3(3)**  
**Bracing Unit Distribution – Boundary Elements**

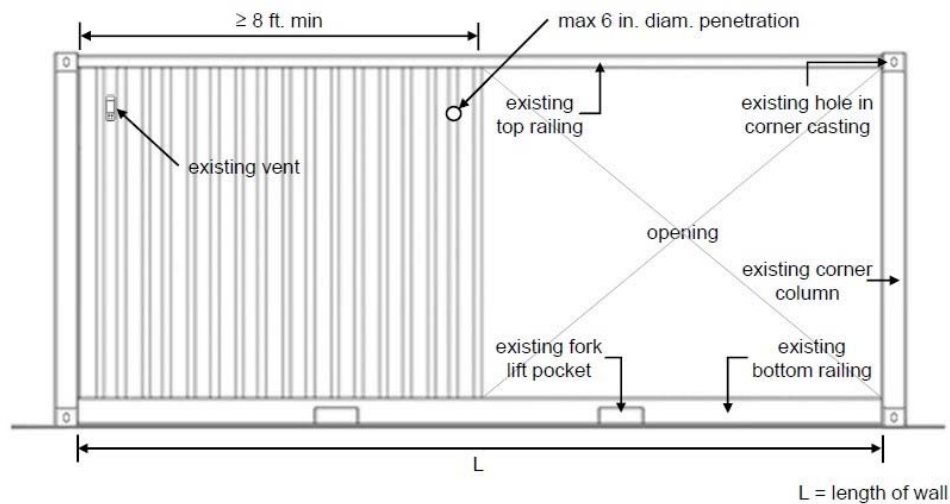

**FIGURE 3115.8.5.3(4)**  
**Bracing Unit Distribution – Penetrating Limitations**

#### **RATIONALE:**

Due to the US trade deficit with other countries, there is an abundant supply of unused intermodal shipping containers, particularly in jurisdictions that have ports, that have created negative impacts on the environment. This results in more materials that are not recycled and increases energy consumption required to melt down and recycle others that are. The repurposing of existing intermodal shipping containers will help to reduce the environmental impact and improve the sustainability of the community by being less reliant on traditional construction material.

This amendment is based on a similar code provision adopted into the 2024 Edition of the International Building Code. It is intended to assist code officials address the environmental impact of unused materials, reduce consumption of traditional raw materials, minimize non-industrial wastes, and ensure minimum design and safety standards associated with the repurposing of existing intermodal shipping containers as buildings or structures or component of buildings and structures are achieved.

#### **FINDINGS:**

Local Climatic and Geological Conditions – The greater Los Angeles region is a densely populated area having buildings and structures constructed over and near a vast array of fault systems capable of producing major earthquakes, including but not limited to the recent 1994 Northridge Earthquake. The region is further impacted by construction of buildings and structures utilizing tradition construction materials that impact the amount of energy, air quality, greenhouse gas emission and construction waste in the area. The proposed amendment addresses structural designs specific to intermodal shipping containers, reduce environmental impact of unused and unrecycled intermodal shipping containers, and increase sustainability by reducing consumption of traditional construction materials. The proposed modification needs to be incorporated into the code to assure that new buildings and additions to existing buildings utilizing intermodal shipping containers are designed and constructed in accordance with the scope and objectives of the California Building Code and California Green Building Standards Code.

## **PART II**

LARUCP RECOMMENDED CODE AMENDMENTS TO THE  
2022 EDITION OF THE CALIFORNIA RESIDENTIAL CODE

## SUMMARY OF RECOMMENDED LARUCP AMENDMENTS TO THE 2022 CRC

2022 LARUCP NO.	TITLE/DESCRIPTION	STATUS <sup>1</sup>
R3-01	Amend CRC Section R301.1.3.2 Woodframe Structures	E
R3-02	Add CRC Section R301.1.5 Seismic Design Provisions for Buildings on Slopes Steeper than 33%	E
R3-03	Amend CRC Items 1, 3, and 5 of Section R301.2.2.6 Irregular Buildings	E
R3-04	Add CRC Section R301.2.2.11 Anchorage of Mechanical, Electrical, or Plumbing Components and Equipment	E
R4-01	Amend CRC Section R401.1 Application	E
R4-02	Amend CRC Sections R403.1.2, R403.1.3.6, and R403.1.5 General Footings	E
R4-03	Amend CRC Section R404.2 Wood Foundation Walls	E
R5-01	Amend CRC Section R501.2 Requirements	E
R5-02	Add CRC Section R503.2.4 Openings in Horizontal Diaphragms	E
R6-01	Amend CRC Table R602.3(1) Fastening Schedule	E
R6-02	Amend CRC Table R602.3(2) Alternate Attachments to Table R602.3(1)	E
R6-03	Amend CRC Section R602.3.2 and Table R602.3.2 Top Plate	E
R6-04	Amend CRC Section R602.10.2.3 Minimum Number of Braced Wall Panels	E
R6-05	Amend CRC Table R602.10.3(3) Bracing Requirements Based on Seismic Design Category	E
R6-06	Amend CRC Table R602.10.4 Bracing Methods	E
R6-07	Amend CRC Table R602.10.5 Minimum Length of Braced Wall Panels	E
R6-08	Amend CRC Figure R602.10.6.1 Method ABW - Alternate Braced Wall Panel	E
R6-09	Amend CRC Figure R602.10.6.2 Method PFH - Portal Frame with Hold-downs at Detached Garage Door Openings	E
R6-10	Amend CRC Figure R602.10.6.4 Method CS-PF - Continuously Sheathed Portal Frame Panel Construction	E
R6-11	Amend CRC Section R606.4.4 Parapet Walls	E
R6-12	Amend CRC Section R606.12.2.2.3 Reinforcement Requirements for Masonry Elements	E
R8-01	Add CRC Section R803.2.4 Openings in Horizontal Diaphragms	E
R10-01	Amend CRC Section R1001.3.1 Vertical Reinforcing	E

**FOOTNOTE:**

1. N = New amendment proposed  
E = Existing amendment updated as necessary



## 2022 LARUCP R3-01

Section R301.1.3.2 of the 2022 Edition of the California Residential Code is amended to read as follows:

***R301.1.3.2 Woodframe structures ~~greater than two stories~~.*** *The building official shall require construction documents to be approved and stamped by a California licensed architect or engineer for all dwellings of woodframe construction more than two stories and basement in height located in Seismic Design Category A, B or C. Notwithstanding other sections of law; the law establishing these provisions is found in Business and Professions Code Sections 5537 and 6737.1.*

The building official shall require construction documents to be approved and stamped by a California licensed architect or engineer for all dwellings of woodframe construction more than one story in height or with a basement located in Seismic Design Category D<sub>0</sub>, D<sub>1</sub>, or D<sub>2</sub>.

### RATIONALE:

After the 1994 Northridge Earthquake, the Wood Frame Construction Joint Task Force recommended that the quality of wood frame construction need to be greatly improved. One such recommendation identified by the Task Force is to improve the quality and organization of structural plans prepared by the engineer or architect so that plan examiners, building inspectors, contractors and special inspectors may logically follow and construct the presentation of the seismic force-resisting systems in the construction documents. For buildings or structures located in Seismic Design Category D<sub>0</sub>, D<sub>1</sub>, or D<sub>2</sub> that are subject to a greater level of seismic forces, the requirement to have a California licensed architect or engineer prepare the construction documents is intended to minimize or reduce structural deficiencies that may cause excessive damage or injuries in wood frame buildings. Structural deficiencies such as plan and vertical irregularities, improper shear transfer of the seismic force-resisting system, missed details or connections important to the structural system, and the improper application of the prescriptive requirements of the California Residential Code can be readily addressed by a registered design professional.

### FINDINGS:

Local Geological Conditions – The greater Los Angeles region is a densely populated area having buildings and structures constructed over and near a vast array of fault systems capable of producing major earthquakes, including but not limited to the recent 1994 Northridge Earthquake. The proposed modification to require construction documents for wood frame construction greater than one story in height or with a basement to be approved and stamped by a California licensed architect or engineer is intended to assure that both the structural design and prescriptive requirement of the code are properly utilized and presented and therefore need to be incorporated into the code to assure that new buildings and structures, and additions or alterations to existing buildings or structures are designed and constructed in accordance with the scope and objectives of the California Residential Code.

## 2022 LARUCP R3-02

Section R301.1.5 is added to Chapter 3 of the 2022 Edition of the California Residential Code to read as follows:

**R301.1.5 Seismic design provisions for buildings constructed on or into slopes steeper than one unit vertical in three units horizontal (33.3 percent slope).** The design and construction of new buildings and additions to existing buildings when constructed on or into slopes steeper than one unit vertical in three units horizontal (33.3 percent slope) shall comply with Section 1613.6 of the California Building Code.

### RATIONALE:

Due to the difficulty of fire suppression vehicles accessing winding and narrow hillside properties and the probabilities for future earthquakes in the Los Angeles region, this technical amendment is required to address the special needs for buildings constructed on hillside locations. A joint Structural Engineers Association of Southern California (SEAOSC) and both the Los Angeles County and Los Angeles City Task Force investigated the performance of hillside building failures after the Northridge earthquake. Numerous hillside failures resulted in loss of life and millions of dollars in damage. These criteria were developed to minimize the damage to these structures and have been in use by both the City and County of Los Angeles for several years with much success. This proposed amendment is a continuation of an amendment adopted during previous code adoption cycles.

### FINDINGS:

Local Topographical and Geological Conditions – The greater Los Angeles region is a densely populated area having buildings and structures constructed over and near a vast array of fault systems capable of producing major earthquakes, including but not limited to the recent 1994 Northridge Earthquake. Additionally, the topography within the Los Angeles region includes significant hillsides with narrow and winding access that makes timely response by fire suppression vehicles challenging and difficult. The proposed modification establishes design parameters to better mitigate and limit property damage that are the results of increased seismic forces which are imparted upon hillside buildings and structures and therefore need to be incorporated into the code to assure that new buildings and structures and additions or alterations to existing buildings or structures are designed and constructed in accordance with the scope and objectives of the California Residential Code.

## 2022 LARUCP R3-03

Items 1, 3 and 5 of Section R301.2.2.6 of the 2022 Edition of the California Residential Code are amended to read as follows:

1. **Shear wall or braced wall offsets out of plane.** Conditions where exterior shear wall lines or braced wall panels are not in one plane vertically from the foundation to the uppermost story in which they are required.

**Exception:** ~~For wood light frame construction, floors with cantilevers or setbacks not exceeding four times the nominal depth of the wood floor joists are permitted to support braced wall panels that are out of plane with braced wall panels below provided that all of the following are satisfied:~~

- ~~1. Floor joists are nominal 2 inches by 10 inches (51 mm by 254 mm) or larger and spaced not more than 16 inches (406 mm) on center.~~
- ~~2. The ratio of the back span to the cantilever is not less than 2 to 1.~~
- ~~3. Floor joists at ends of braced wall panels are doubled.~~
- ~~4. For wood frame construction, a continuous rim joist is connected to ends of cantilever joists. When spliced, the rim joists shall be spliced using a galvanized metal tie not less than 0.058 inch (1.5 mm) (16 gage) and 1 1/2 inches (38 mm) wide fastened with six 16d nails on each side of the splice or a block of the same size as the rim joist of sufficient length to fit securely between the joist space at which the splice occurs fastened with eight 16d nails on each side of the splice; and~~
- ~~5. Gravity loads carried at the end of cantilevered joists are limited to uniform wall and roof loads and the reactions from headers having a span of 8 feet (2438 mm) or less.~~

3. **Shear wall or braced wall offsets in plane.** Conditions where the end of a braced wall panel occurs over an opening in the wall below, and extends more than 1 foot (305 mm) horizontally past the edge of the opening. This provision is applicable to shear walls and braced wall panels offset in plane and to braced wall panels offset out of plane as permitted by the exception to item 1.

**Exception:** ~~For wood light frame wall construction, one end of a braced wall panel shall be permitted to extend more than one foot (305 mm) over an opening not more than 8 feet (2438 mm) in width in the wall below provided that the opening includes a header in accordance with all of the following:~~

- ~~1. The building width, loading condition and framing member species limitations of Table R602.7(1) shall apply.~~
- ~~2. The header is composed of:
 
  - ~~2.1 Not less than one 2x12 or two 2x10 for an opening not more than 4 feet (1219 mm) wide.~~
  - ~~2.2 Not less than two 2x12 or three 2x10 for an opening not more than 6 feet (1829 mm) in width.~~
  - ~~2.3 Not less than three 2x12 or four 2x10 for an opening not more than 8 feet (2438 mm) in width.~~~~
- ~~3. The entire length of the braced wall panel does not occur over an opening in the wall below.~~

5. **Floor level offset.** Conditions where portions of a floor level are vertically offset.

**Exceptions:**

- ~~1. Framing supported directly by continuous foundations at the perimeter of the building.~~
- ~~2. For wood light frame construction, floors shall be permitted to be vertically offset where the floor framing is lapped or tied together as required by section R502.6.1.~~

**RATIONALE:**

With the higher seismic demand placed on buildings and structures in this region, precautionary steps are proposed to reduce or eliminate potential problems that may result by limiting the type of irregular conditions specified in the California Residential Code. Such limitations are intended to reduce the potential structural damage expected in the event of an earthquake. The cities and county of the Los Angeles region has taken extra measures to maintain the structural integrity of the framing of the shear walls and all associated elements when designed for high levels of seismic loads.

**FINDINGS:**

Local Geological Conditions – The greater Los Angeles region is a densely populated area having buildings and structures constructed over and near a vast array of fault systems capable of producing major earthquakes, including but not limited to the recent 1994 Northridge Earthquake. The proposed amendment limits the type of irregular conditions within buildings that may lead to higher structural damage during a seismic event and therefore needs to be incorporated into the code to assure that new buildings and structures and additions or alterations to existing buildings or structures are designed and constructed in accordance with the scope and objectives of the California Residential Code and consistent with the requirements in the ASCE 7-16.

## 2022 LARUCP R3-04

Section R301.2.2.11 is added to Chapter 3 of the 2022 Edition of the California Residential Code to read as follows:

**R301.2.2.11 Anchorage of mechanical, electrical, or plumbing components and equipment.** Mechanical, electrical, or plumbing components and equipment shall be anchored to the structure. Anchorage of the components and equipment shall be designed to resist loads in accordance with the California Building Code and ASCE 7, except where the component is positively attached to the structure and flexible connections are provided between the component and associated ductwork, piping, and conduit; and either

1. The component weighs 400 lb (1,780 N) or less and has a center of mass located 4 ft (1.22 m) or less above the supporting structure; or
2. The component weighs 20 lb (89N) or less or, in the case of a distributed system, 5 lb/ft (73 N/m) or less.

### RATIONALE:

There is no limitation for weight of mechanical and plumbing fixtures and equipment in the California Residential Code. Requirements from ASCE 7 and the California Building Code would permit equipment weighing up to 400 lbs. when mounted at 4 feet or less above the floor or attic level without engineering design. Where equipment exceeds this requirement, it is the intent of this proposed amendment that a registered design professional be required to analyze if the floor support is adequate and structurally sound.

### FINDINGS:

Local Geological Conditions – The greater Los Angeles region is a densely populated area having buildings and structures constructed over and near a vast array of fault systems capable of producing major earthquakes, including but not limited to the recent 1994 Northridge Earthquake. The proposed modification to limit the equipment weight is intended to reduce injuries, save lives, and minimize structural damages and therefore needs to be incorporated into the code to assure that new buildings and structures and additions or alterations to existing buildings or structures are designed and constructed in accordance with the scope and objectives of the California Residential Code.

## 2022 LARUCP R4-01

Section R401.1 of the 2022 Edition of the California Residential Code is amended to read as follows:

**R401.1 Application.** The provisions of this chapter shall control the design and construction of the foundation and foundation spaces for buildings. In addition to the provisions of this chapter, the design and construction of foundations in flood hazard areas as established by Table R301.2 shall meet the provisions of Section R322. Wood foundations shall be designed and installed in accordance with AWC PWF.

**Exception:** The provisions of this chapter shall be permitted to be used for wood foundations only in the following situations:

1. In buildings that have no more than two floors and a roof.
2. When interior basement and foundation walls are constructed at intervals not exceeding 50 feet (15 240 mm).

Wood foundations in Seismic Design Category D<sub>0</sub>, D<sub>1</sub>, or D<sub>2</sub> shall ~~be designed in accordance with accepted engineering practice~~ not be permitted.

**Exception:** In non-occupied, single-story, detached storage sheds and similar uses other than carport or garage, provided the gross floor area does not exceed 200 square feet, the plate height does not exceed 12 feet in height above the grade plane at any point, and the maximum roof projection does not exceed 24 inches.

### RATIONALE:

No substantiating data has been provided to show that wood foundation is effective in supporting buildings and structures during a seismic event while being subject to deterioration caused by the combined detrimental effect of constant moisture in the soil and wood-destroying organisms. Wood foundation, when they are not properly treated and protected against deterioration, have performed very poorly and have led to slope failures. Most contractors are typically accustomed to construction in dry and temperate weather in the Southern California region and are not generally familiar with the necessary precautions and treatment of wood that makes it suitable for both seismic event and wet applications. The proposed amendment takes the precautionary steps to reduce or eliminate potential problems that may result in using wood foundation that experience relatively rapid decay due to the fact that the region does not experience temperatures cold enough to destroy or retard the growth and proliferation of wood-destroying organisms. However, an exception is made for non-occupied, single-story storage structures that pose significantly less risk to human safety and may utilize the wood foundation guidelines specified in this Chapter. This proposed amendment is a continuation of an amendment adopted during previous code adoption cycles for the California Residential Code.

### FINDINGS:

Local Climatic and Geological Conditions – The greater Los Angeles region is a densely populated area having buildings and structures constructed over and near a vast array of fault systems capable of producing major earthquakes, including but not limited to the recent 1994 Northridge Earthquake. In addition, the region is within a climate system capable of producing major winds, fire and rain related disasters, including but not limited to those caused by the Santa Ana winds and El Nino (or La Nina) subtropical-like weather. This region is especially susceptible to more active termite and wood attacking insects and microorganisms. The proposed modification to prohibit the use of wood foundation systems as well as limit prescriptive design provisions in an effort to mitigate potential problems or deficiencies due to the proliferation of wood-destroying organisms and therefore need to be incorporated into the code to assure that new buildings and structures and additions or alterations to existing buildings or structures are designed and constructed in accordance with the scope and objectives of the California Residential Code.

## 2022 LARUCP R4-02

Sections R403.1.2, R403.1.3.6 and R403.1.5 of the 2022 Edition of the California Residential Code are amended to read as follows:

**R403.1.2 Continuous footing in Seismic Design Categories D<sub>0</sub>, D<sub>1</sub> and D<sub>2</sub>.** Exterior walls of buildings located in Seismic Design Categories D<sub>0</sub>, D<sub>1</sub> and D<sub>2</sub> shall be supported by continuous solid or fully grouted masonry or concrete footings. ~~Other footing materials or systems shall be designed in accordance with accepted engineering practice.~~ Required interior braced wall panels in buildings located in Seismic Design Categories D<sub>0</sub>, D<sub>1</sub> and D<sub>2</sub> ~~with plan dimensions greater than 50 feet (15 240 mm) shall be supported by continuous solid or fully grouted masonry or concrete footings in accordance with Section R403.1.3.4, except for two-story buildings in Seismic Design Category D<sub>2</sub>, in which all braced wall panels, interior and exterior, shall be supported on continuous foundations.~~

**Exception:** ~~Two-story buildings shall be permitted to have interior braced wall panels supported on continuous foundations at intervals not exceeding 50 feet (15 240 mm) provided that:~~

- ~~1. The height of cripple walls does not exceed 4 feet (1219 mm).~~
- ~~2. First floor braced wall panels are supported on doubled floor joists, continuous blocking or floor beams.~~
- ~~3. The distance between bracing lines does not exceed twice the building width measured parallel to the braced wall line.~~

**R403.1.3.6 Isolated concrete footings.** In detached one- and two-family dwellings located in Seismic Design Category A, B, or C, that are three stories or less in height, and constructed with stud bearing walls, isolated plain concrete footings supporting columns or pedestals are permitted.

**R403.1.5 Slope.** The top surface of footings shall be level. The bottom surface of footings shall not have a slope exceeding one unit vertical in 10 units horizontal (10-percent slope). Footings shall be stepped where it is necessary to change the elevation of the top surface of the footings or where the slope of the bottom surface of the footings will exceed one unit vertical in 10 units horizontal (10-percent slope).

For structures assigned to Seismic Design Categories D<sub>0</sub>, D<sub>1</sub> or D<sub>2</sub>, stepped footings shall be reinforced with four No. 4 rebar. Two bars shall be placed at the top and bottom of the footings as shown in Figure R403.1.5.

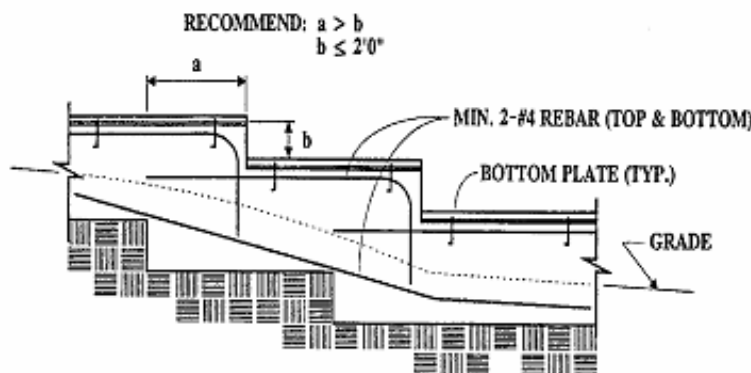

STEPPED FOUNDATIONS

**FIGURE R403.1.5  
STEPPED FOOTING**



**RATIONALE:**

With the higher seismic demand placed on buildings and structures in this region, precautionary steps are proposed to reduce or eliminate potential problems that may result for under-reinforced footings located on sloped surfaces. Requiring minimum reinforcement for stepped footings is intended to address the problem of poor performance of plain or under-reinforced footings during a seismic event. Furthermore, interior walls can easily be called upon to resist over half of the seismic loading imposed on simple buildings or structures. Without a continuous foundation to support the braced wall line, seismic loads would be transferred through other elements such as non-structural concrete slab floors, wood floors, etc. The proposed change is to limit the use of the exception to structures assigned to Seismic Design Category A, B or C where lower seismic demands are expected. Requiring interior braced walls be supported by continuous foundations is intended to reduce or eliminate the poor performance of buildings or structures. This proposed amendment is consistent with an amendment adopted during previous code adoption cycles for the California Residential Code.

**FINDINGS:**

Local Geological Conditions – The greater Los Angeles region is a densely populated area having buildings and structures constructed over and near a vast array of fault systems capable of producing major earthquakes, including but not limited to the recent 1994 Northridge Earthquake. The proposed modification to require continuous footings under braced wall lines, require reinforcement in one- and two-family dwelling, and minimum reinforcement in stepped footings will improve performance of buildings or structure during a seismic event and minimize potential problems or deficiencies and therefore need to be incorporated into the code to assure that new buildings and additions to existing buildings are designed and constructed in accordance with the scope and objectives of the California Residential Code.

## 2022 LARUCP R4-03

Section R404.2 of the 2022 Edition of the California Residential Code is amended to read as follows:

**R404.2 Wood foundation walls.** Wood foundation walls shall be constructed in accordance with the provisions of Sections R404.2.1 through R404.2.6 and with the details shown in Figures R403.1(2) and R403.1(3). Wood foundation walls shall not be used for structures located in Seismic Design Category D<sub>0</sub>, D<sub>1</sub> or D<sub>2</sub>.

### RATIONALE:

No substantiating data has been provided to show that wood foundation wall is effective in supporting buildings and structures during a seismic event while being subject to deterioration caused by the combined detrimental effect of constant moisture in the soil and wood-destroying organisms. Wood foundation walls, when they are not properly treated and protected against deterioration, have performed very poorly and have led to slope failures. Most contractors are typically accustomed to construction in dry and temperate weather in the Southern California region and are not generally familiar with the necessary precautions and treatment of wood that makes it suitable for both seismic event and wet applications. The proposed amendment takes the precautionary steps to reduce or eliminate potential problems that may result in using wood foundation walls that experience relatively rapid decay due to the fact that the region does not experience temperatures cold enough to destroy or retard the growth and proliferation of wood-destroying organisms. This proposed amendment is consistent with an amendment adopted during previous code adoption cycles for the California Residential Code.

### FINDINGS:

Local Climatic and Geological Conditions – The greater Los Angeles region is a densely populated area having buildings and structures constructed over and near a vast array of fault systems capable of producing major earthquakes, including but not limited to the recent 1994 Northridge Earthquake. In addition, the region is within a climate system capable of producing major winds, fire and rain related disasters, including but not limited to those caused by the Santa Ana winds and El Nino (or La Nina) subtropical-like weather. This region is especially susceptible to more active termite and wood attacking insects and microorganisms. The proposed modification to prohibit the use of wood foundation wall in an effort to mitigate potential problems or deficiencies due to the proliferation of wood-destroying organisms and therefore need to be incorporated into the code to assure that new buildings and structures and additions or alterations to existing buildings or structures are designed and constructed in accordance with the scope and objectives of the California Residential Code.

## 2022 LARUCP R5-01

Section R501.2 of the 2022 Edition of the California Residential Code is amended to read as follows:

**R501.2 Requirements.** Floor construction shall be capable of accommodating all loads in accordance with Section R301 and of transmitting the resulting loads to the supporting structural elements. Mechanical or plumbing fixtures and equipment shall be attached or anchored to the structure in accordance with Section R301.2.2.11.

### RATIONALE:

There is no limitation for weight of mechanical and plumbing fixtures and equipment in the California Residential Code. Requirements from ASCE 7 and the California Building Code would permit equipment weighing up to 400 lbs. when mounted at 4 feet or less above the floor or attic level without engineering design. Where equipment exceeds this requirement, it is the intent of this proposed amendment that a registered design professional is required to analyze if the floor support is adequate and structurally sound.

### FINDINGS:

Local Geological Conditions – The greater Los Angeles region is a densely populated area having buildings and structures constructed over and near a vast array of fault systems capable of producing major earthquakes, including but not limited to the recent 1994 Northridge Earthquake. The proposed modification to limit the equipment weight is intended to reduce injuries, save lives, and minimize structural damages and therefore needs to be incorporated into the code to assure that new buildings and structures and additions or alterations to existing buildings or structures are designed and constructed in accordance with the scope and objectives of the California Residential Code.

## 2022 LARUCP R5-02

Section R503.2.4 is added to Chapter 5 of the 2022 Edition of the California Residential Code to read as follows:

**R503.2.4 Openings in horizontal diaphragms.** Openings in horizontal diaphragms with a dimension perpendicular to the joist that is greater than 4 feet (1.2 m) shall be constructed in accordance with Figure R503.2.4.

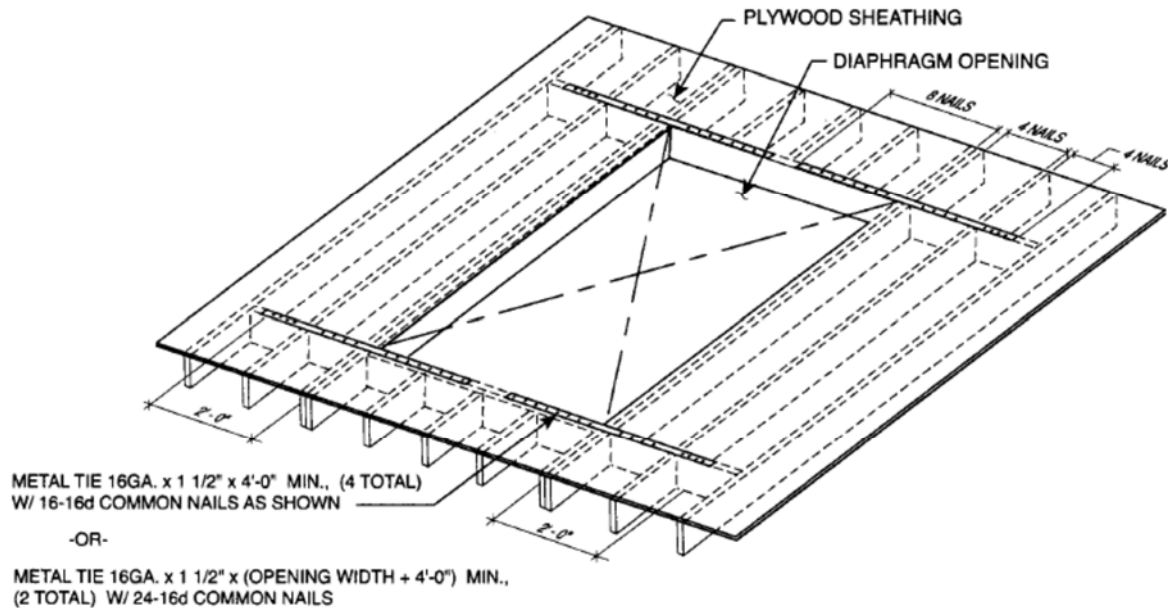

For SI: 1 inch = 25.4 mm, 1 foot = 304.8 mm.

- Blockings shall be provided beyond headers.
- Metal ties not less than 0.058 inch [1.47 mm (16 galvanized gage)] by 1.5 inches (38 mm) wide with eight 16d common nails on each side of the header-joist intersection. The metal ties shall have a minimum yield of 33,000 psi (227 MPa).
- Openings in diaphragms shall be further limited in accordance with Section R301.2.2.6.

**FIGURE R503.2.4**  
**OPENINGS IN HORIZONTAL DIAPHRAGMS**

### RATIONALE:

Section R502.10 of the Code does not provide any prescriptive criteria to limit the maximum floor opening size nor does Section R503 provide any details to address the issue of shear transfer near larger floor openings. With the higher seismic demand placed on buildings and structures in this region, it is important to ensure that a complete load path is provided to reduce or eliminate potential damages caused by seismic forces. Requiring blocking with metal ties around larger floor openings and limiting opening size is consistent with the requirements of Section R301.2.2.6.

### FINDINGS:

Local Geological Conditions – The greater Los Angeles region is a densely populated area having buildings and structures constructed over and near a vast array of fault systems capable of producing major earthquakes, including but not limited to the recent 1994 Northridge Earthquake. The proposed modification to require specific detailing at large floor openings is intended to address the poor performance of floor diaphragms with openings and limit or reduce property damages during a seismic event and therefore needs to be incorporated into the code to assure that new buildings and structures and additions or alterations to existing buildings or structures are designed and constructed in accordance with the scope and objectives of the California Residential Code.

## 2022 LARUCP R6-01

Lines 20, 21, 24, and 34 - 37 of Table R602.3(1) of the 2022 Edition of the California Residential Code are amended to read as follows:

**TABLE R602.3(1)—continued FASTENING SCHEDULE**

ITEM	DESCRIPTION OF BUILDING ELEMENTS	NUMBER AND TYPE OF FASTENER <sup>a, b, c</sup>	SPACING AND LOCATION	
20 <sup>k</sup>	1" × 6" sheathing to each bearing	3-8d box (2½" × 0.113"); or 2-8d common (2½" × 0.131"); or 2-10d box (3" × 0.128"); or 2 staples, 1" crown, 16 ga., 1¾" long	Face nail	
21 <sup>k</sup>	1" × 8" and wider sheathing to each bearing	3-8d box (2½" × 0.113"); or 3-8d common (2½" × 0.131"); or 3-10d box (3" × 0.128"); or 3 staples, 1" crown, 16 ga., 1¾" long	Face nail	
		Wider than 1" × 8" 4-8d box (2½" × 0.113"); or 3-8d common (2½" × 0.131"); or 3-10d box (3" × 0.128"); or 4 staples, 1" crown, 16 ga., 1¾" long		
<b>Floor</b>				
24 <sup>k</sup>	1" × 6" subfloor or less to each joist	3-8d box (2½" × 0.113"); or 2-8d common (2½" × 0.131"); or 3-10d box (3" × 0.128"); or 2 staples, 1" crown, 16 ga., 1¾" long	Face nail	
<b>Other wall sheathing<sup>g</sup></b>				
34 <sup>k</sup>	½" structural cellulosic fiberboard sheathing	1½" x 0.120" galvanized roofing nail, 7/16" head diameter, or 1¼" long 16 ga. staple with 7/16" or 1" crown	3	6
35 <sup>k</sup>	25/32" structural cellulosic fiberboard sheathing	1¾" x 0.120" galvanized roofing nail, 7/16" head diameter, or 1¼" long 16 ga. Staple with 7/16" or 1" crown	3	6
36 <sup>k</sup>	½" gypsum sheathing <sup>d</sup>	1½" x 0.120" galvanized roofing nail, 7/16" head diameter, or 1¼" long, 16 ga.; staple galvanized, 1½" long; 7/16" or 1" crown or 1¼" screws, Type W or S	7	7
37 <sup>k</sup>	5/8" gypsum sheathing <sup>d</sup>	1¾" galvanized roofing nail, 7/16" head diameter, or 1¼" long, 16 ga.; staple galvanized, 1½" long; 7/16" or 1" crown or 1¼" screws, Type W or S	7	7

**TABLE R602.3(1)—continued FASTENING SCHEDULE**

k. Use of staples in roof, floor, and braced wall panels shall be prohibited in Seismic Design Category D<sub>0</sub>, D<sub>1</sub>, or D<sub>2</sub>.

### RATIONALE:

The Structural Engineers Association of Southern California (SEAOSC) and the Los Angeles City Joint Task Force that investigated the damages to buildings and structures during the 1994 Northridge Earthquake recommended reducing allowable shear values in wood structural panel shear walls or diaphragms that were not substantiated by cyclic testing. That recommendation was consistent with a report to the Governor from the Seismic Safety Commission of the State of California recommending that code requirements be "more thoroughly substantiated with testing." The allowable shear values for wood structural panel shear walls or diaphragms fastened with staples are based on monotonic testing and does not take into consideration that earthquake forces load shear wall or diaphragm in a repeating and fully reversible manner.

In September 2007, limited cyclic testing was conducted by a private engineering firm to determine if wood structural panels fastened with staples would exhibit the same behavior as the wood structural panels fastened with common nails. The test result revealed that wood structural panel fastened with staples appeared to be much

lower in strength and stiffness than wood structural panels fastened with common nails. It was recommended that the use of staples as fasteners for wood structural panel shear walls or diaphragms – as well as other sheathing materials - not be permitted to resist seismic forces in structures assigned to Seismic Design Category D<sub>0</sub>, D<sub>1</sub>, or D<sub>2</sub> unless it can be substantiated by cyclic testing.

#### **FINDINGS:**

Local Geological Conditions – The greater Los Angeles region is a densely populated area having buildings and structures constructed over and near a vast array of fault systems capable of producing major earthquakes, including but not limited to the recent 1994 Northridge Earthquake. The proposed modification to place design and construction limits on staples as fasteners used in wood structural panel or diaphragms not substantiated with cyclic testing will help to maintain minimum quality of construction and performance standards of structures and therefore need to be incorporated into the code to assure that new buildings and structures and additions or alterations to existing buildings or structures are designed and constructed in accordance with the scope and objectives of the California Residential Code.

## 2022 LARUCP R6-02

Footnote "b" of Table R602.3(2) of the 2022 Edition of the California Residential Code is amended to read as follows:

- b. Staples shall have a minimum crown width of 7/16-inch on diameter except as noted. Use of staples in roof, floor, subfloor, and braced wall panels shall be prohibited in Seismic Design Category D<sub>0</sub>, D<sub>1</sub>, or D<sub>2</sub>.

### RATIONALE:

The Structural Engineers Association of Southern California (SEAOSC) and the Los Angeles City Joint Task Force that investigated the damages to buildings and structures during the 1994 Northridge Earthquake recommended reducing allowable shear values in wood structural panel shear walls or diaphragms that were not substantiated by cyclic testing. That recommendation was consistent with a report to the Governor from the Seismic Safety Commission of the State of California recommending that code requirements be "more thoroughly substantiated with testing." The allowable shear values for wood structural panel shear walls or diaphragms fastened with staples are based on monotonic testing and does not take into consideration that earthquake forces load shear wall or diaphragm in a repeating and fully reversible manner.

In September 2007, limited cyclic testing was conducted by a private engineering firm to determine if wood structural panels fastened with staples would exhibit the same behavior as the wood structural panels fastened with common nails. The test result revealed that wood structural panel fastened with staples appeared to be much lower in strength and stiffness than wood structural panels fastened with common nails. It was recommended that the use of staples as fasteners for wood structural panel shear walls or diaphragms – as well as other sheathing materials - not be permitted to resist seismic forces in structures assigned to Seismic Design Category D<sub>0</sub>, D<sub>1</sub> and D<sub>2</sub> unless it can be substantiated by cyclic testing.

### FINDINGS:

Local Geological Conditions – The greater Los Angeles region is a densely populated area having buildings and structures constructed over and near a vast array of fault systems capable of producing major earthquakes, including but not limited to the recent 1994 Northridge Earthquake. The proposed modification to place design and construction limits on staples as fasteners used in wood structural panel or diaphragms not substantiated with cyclic testing will help to maintain minimum quality of construction and performance standards of structures and therefore need to be incorporated into the code to assure that new buildings and structures and additions or alterations to existing buildings or structures are designed and constructed in accordance with the scope and objectives of the California Residential Code.



## 2022 LARUCP R6-03

Exception of Section R602.3.2 and Table R602.3.2 of the 2022 Edition of the California Residential Code is amended to read as follows:

**Exception:** A-In other than Seismic Design Category D<sub>0</sub>, D<sub>1</sub> or D<sub>2</sub>, a single top plate used as an alternative to a double top plate shall comply with the following:

1. The single top plate shall be tied at corners, intersecting walls, and at in-line splices in straight wall lines in accordance with Table R602.3.2.
2. The rafters or joists shall be centered over the studs with a tolerance of not more than 1 inch (25 mm).
3. Omission of the top plate is permitted over headers where the headers are adequately tied to adjacent wall sections in accordance with Table R602.3.2.

TABLE R602.3.2  
SINGLE TOP-PLATE SPLICE CONNECTION DETAILS

CONDITION	TOP-PLATE SPLICE LOCATION			
	Corners and intersecting walls		Butt joints in straight walls	
	Splice plate size	Minimum nails each side of joint	Splice plate size	Minimum nails each side of joint
Structures in SDC A-C; and in SDC D <sub>0</sub> , D <sub>1</sub> and D <sub>2</sub> with braced wall line spacing less than 25 feet	3" x 6" x 0.036" galvanized steel plate or equivalent	(6) 8d box (2 1/2" x 0.113") nails	3' x 12" x 0.036" galvanized steel plate or equivalent	(12) 8d box (2 1/2" x 0.113") nails
Structures in SDC D <sub>0</sub> , D <sub>1</sub> and D <sub>2</sub> , with braced wall line spacing greater than or equal to 25 feet	3" x 8" by 0.036" galvanized steel plate or equivalent	(9) 8d box (2 1/2" x 0.113") nails	3' x 16" x 0.036" galvanized steel plate or equivalent	(18) 8d box (2 1/2" x 0.113") nails

For SI: 1 inch = 25.4 mm, 1 foot = 304.8 mm.

### RATIONALE:

The cities and county of the Los Angeles region have taken extra measures to maintain the structural integrity of the framing of the shear wall system for buildings and structures subject to high seismic loads by eliminating single top plate construction. The performance of modern day braced wall panel construction is directly related to an adequate load path extending from the roof diaphragm to the foundation system. A single top plate is likely to be over nailed due to the nailing requirements at a rafter, stud, top plate splice, and braced wall panel edge in a single location. In addition, notching on a single top plate for plumbing, ventilation and electrical wiring may reduce the load transfer capacity of the plate without proper detailing. A majority of buildings and structures designed and built per the California Residential Code with a single top plate may not need structural observation and special inspections. The potential construction mistakes mentioned above could not be caught and corrected by knowledgeable engineers and inspectors and could jeopardize structural performance of buildings and structures located in high seismic areas.

### FINDINGS:

Local Geological Conditions – The greater Los Angeles region is a densely populated area having buildings and structures constructed over and near a vast array of fault systems capable of producing major earthquakes, including but not limited to the recent 1994 Northridge Earthquake. The proposed modification to eliminate the usage of a single top plate will help to maintain minimum quality of construction and performance standards of structures and therefore need to be incorporated into the code to assure that new buildings and structures and additions or alterations to existing buildings or structures are designed and constructed in accordance with the scope and objectives of the California Residential Code.

## 2022 LARUCP R6-04

Section R602.10.2.3 of the 2022 Edition of the California Residential Code is amended to read as follows:

**R602.10.2.3 Minimum number of braced wall panels.** Braced wall lines with a length of 16 feet (4877 mm) or less shall have not less than two braced wall panels of any length or one braced wall panel equal to 48 inches (1219 mm) or more. Braced wall lines greater than 16 feet (4877 mm) shall have not less than two braced wall panels. In Seismic Design Category D<sub>0</sub>, D<sub>1</sub>, or D<sub>2</sub>, no braced wall panel shall have a contributing length less than 48 inches in length or as required in Section R602.10.3, whichever is greater.

### RATIONALE:

Plywood shear walls with high aspect ratio experienced many failures during the Northridge Earthquake. This proposed amendment specifies a minimum braced wall length to meet an aspect ratio consistent with other sections of the California Residential Code as to provide a uniform standard of construction for designers and buildings to follow. This is intended to improve the performance level of buildings and structures that are subject to the higher seismic demands and reduce and limit potential damages to property. This proposed amendment reflects the recommendations by the Structural Engineers Association of Southern California (SEAOSC) and the Los Angeles City Joint Task Force that investigated the poor performance observed in 1994 Northridge Earthquake. This proposed amendment is consistent with an amendment adopted during previous code adoption cycles for the California Residential Code.

### FINDINGS:

Local Geological Conditions – The greater Los Angeles region is a densely populated area having buildings and structures constructed over and near a vast array of fault systems capable of producing major earthquakes, including but not limited to the recent 1994 Northridge Earthquake. The proposed modification reduces the aspect ratio help to maintain minimum quality of construction and performance standards of structures and therefore need to be incorporated into the code to assure that new buildings and additions to existing buildings are designed and constructed in accordance with the scope and objectives of the California Residential Code.

### 2022 LARUCP R6-05

Table R602.10.3(3) of the 2022 Edition of the California Residential Code is amended to read as follows:

TABLE R602.10.3(3)  
BRACING REQUIREMENTS BASED ON SEISMIC DESIGN CATEGORY

• WALL HEIGHT = 10 FEET • 10 PSF FLOOR DEAD LOAD • 15 PSF ROOF/CEILING DEAD LOAD • BRACED WALL LINE SPACING ≤ 25 FEET			MINIMUM TOTAL LENGTH (FEET) OF BRACED WALL PANELS REQUIRED ALONG EACH BRACED WALL LINE <sup>a,3</sup>				
Seismic Design Category <sup>b</sup>	Story Location	Braced Wall Line Length (feet) <sup>c</sup>	Method LIB <sup>d</sup>	Method GB <sup>e</sup>	Methods DWB, SFB, PBS, PCP, HPS, CS-SFB <sup>g</sup>	Methods WSP, ABW <sup>h</sup> , PFH <sup>i</sup> and PFG <sup>h,1</sup>	Methods CS-WSP, CS-G, CS-PF
C (townhouses only)		10	2.5	2.5	2.5	1.6	1.4
		20	5.0	5.0	5.0	3.2	2.7
		30	7.5	7.5	7.5	4.8	4.1
		40	10.0	10.0	10.0	6.4	5.4
		50	12.5	12.5	12.5	8.0	6.8
		10	NP	4.5	4.5	3.0	2.6
		20	NP	9.0	9.0	6.0	5.1
		30	NP	13.5	13.5	9.0	7.7
		40	NP	18.0	18.0	12.0	10.2
		50	NP	22.5	22.5	15.0	12.8
		10	NP	6.0	6.0	4.5	3.8
		20	NP	12.0	12.0	9.0	7.7
		30	NP	18.0	18.0	13.5	11.5
		40	NP	24.0	24.0	18.0	15.3
		50	NP	30.0	30.0	22.5	19.1
D <sub>0</sub>		10	NP	<del>2.8</del> 5.6	<del>2.8</del> 5.6	1.8	1.6
		20	NP	<del>5.5</del> 11.0	<del>5.5</del> 11.0	3.6	3.1
		30	NP	<del>8.3</del> 16.6	<del>8.3</del> 16.6	5.4	4.6
		40	NP	<del>11.0</del> 22.0	<del>11.0</del> 22.0	7.2	6.1
		50	NP	<del>13.8</del> 27.6	<del>13.8</del> 27.6	9.0	7.7
		10	NP	<del>5.3</del> NP	<del>5.3</del> NP	3.8	3.2
		20	NP	<del>10.5</del> NP	<del>10.5</del> NP	7.5	6.4
		30	NP	<del>15.8</del> NP	<del>15.8</del> NP	11.3	9.6
		40	NP	<del>21.0</del> NP	<del>21.0</del> NP	15.0	12.8
		50	NP	<del>26.3</del> NP	<del>26.3</del> NP	18.8	16.0
		10	NP	<del>7.3</del> NP	<del>7.3</del> NP	5.3	4.5
		20	NP	<del>14.5</del> NP	<del>14.5</del> NP	10.5	9.0
		30	NP	<del>21.8</del> NP	<del>21.8</del> NP	15.8	13.4
		40	NP	<del>29.0</del> NP	<del>29.0</del> NP	21.0	17.9
		50	NP	<del>36.3</del> NP	<del>36.3</del> NP	26.3	22.3

(continued)

TABLE R602.10.3(3)—continued  
BRACING REQUIREMENTS BASED ON SEISMIC DESIGN CATEGORY

• WALL HEIGHT = 10 FEET • 10 PSF FLOOR DEAD LOAD • 15 PSF ROOF/CEILING DEAD LOAD • BRACED WALL LINE SPACING ≤ 25 FEET		MINIMUM TOTAL LENGTH (FEET) OF BRACED WALL PANELS REQUIRED ALONG EACH BRACED WALL LINE <sup>a, b</sup>					
Seismic Design Category <sup>b</sup>	Story Location	Braced Wall Line Length (feet) <sup>c</sup>	Method LIB <sup>d</sup>	Method GB	Methods DWB, SFB, PBS, PCP, HPS, CS-SFB <sup>e</sup>	Methods WSP, ABW <sup>f</sup> , PFH <sup>f</sup> and PFG <sup>g, f</sup>	Methods CS-WSP, CS-G, CS-PF
D <sub>1</sub>		10	NP	<del>3.0</del> 6.0	<del>3.0</del> 6.0	2.0	1.7
		20	NP	<del>6.0</del> 12.0	<del>6.0</del> 12.0	4.0	3.4
		30	NP	<del>9.0</del> 18.0	<del>9.0</del> 18.0	6.0	5.1
		40	NP	<del>12.0</del> 24.0	<del>12.0</del> 24.0	8.0	6.8
		50	NP	<del>15.0</del> 30.0	<del>15.0</del> 30.0	10.0	8.5
		10	NP	<del>6.0</del> NP	<del>6.0</del> NP	4.5	3.8
		20	NP	<del>12.0</del> NP	<del>12.0</del> NP	9.0	7.7
		30	NP	<del>18.0</del> NP	<del>18.0</del> NP	13.5	11.5
		40	NP	<del>24.0</del> NP	<del>24.0</del> NP	18.0	15.3
		50	NP	<del>30.0</del> NP	<del>30.0</del> NP	22.5	19.1
		10	NP	<del>8.5</del> NP	<del>8.5</del> NP	6.0	5.1
		20	NP	<del>17.0</del> NP	<del>17.0</del> NP	12.0	10.2
		30	NP	<del>25.5</del> NP	<del>25.5</del> NP	18.0	15.3
		40	NP	<del>34.0</del> NP	<del>34.0</del> NP	24.0	20.4
		50	NP	<del>42.5</del> NP	<del>42.5</del> NP	30.0	25.5
D <sub>2</sub> <sup>b</sup>		10	NP	<del>4.0</del> 8.0	<del>4.0</del> 8.0	2.5	2.1
		20	NP	<del>8.0</del> 16.0	<del>8.0</del> 16.0	5.0	4.3
		30	NP	<del>12.0</del> 24.0	<del>12.0</del> 24.0	7.5	6.4
		40	NP	<del>16.0</del> 32.0	<del>16.0</del> 32.0	10.0	8.5
		50	NP	<del>20.0</del> 40.0	<del>20.0</del> 40.0	12.5	10.6
		10	NP	<del>7.5</del> NP	<del>7.5</del> NP	5.5	4.7
		20	NP	<del>15.0</del> NP	<del>15.0</del> NP	11.0	9.4
		30	NP	<del>22.5</del> NP	<del>22.5</del> NP	16.5	14.0
		40	NP	<del>30.0</del> NP	<del>30.0</del> NP	22.0	18.7
		50	NP	<del>37.5</del> NP	<del>37.5</del> NP	27.5	23.4
	Three-story dwelling	10	NP	NP	NP	NP	NP
		20	NP	NP	NP	NP	NP
		30	NP	NP	NP	NP	NP
		40	NP	NP	NP	NP	NP
		50	NP	NP	NP	NP	NP
	Cripple wall below one- or two-story dwelling	10	NP	NP	NP	7.5	6.4
		20	NP	NP	NP	15.0	12.8
		30	NP	NP	NP	22.5	19.1
		40	NP	NP	NP	30.0	25.5
		50	NP	NP	NP	37.5	31.9

(continued)

- Linear interpolation shall be permitted.
- Interpolation of bracing length between the  $S_{D5}$  values associated with the seismic design categories shall be permitted when a site-specific  $S_{D5}$  value is determined in accordance with Section 1613.2 of the *California Building Code*.
- Where the braced wall line length is greater than 50 feet, braced wall lines shall be permitted to be divided into shorter segments having lengths of 50 feet or less, and the amount of bracing within each segment shall be in accordance with this table.
- Method LIB shall have gypsum board fastened to not less than one side with nails or screws in accordance with Table R602.3(1) for exterior sheathing or Table R702.3.5 for interior gypsum board. Spacing of fasteners at panel edges shall not exceed 8 inches.



- e. Methods PFG and CS-SFB do not apply in Seismic Design Categories D<sub>0</sub>, D<sub>1</sub> and D<sub>2</sub>.
- f. Methods PFH, PFG and ABW are only permitted on a single story or a first of two stories.
- g. Where more than one bracing method is used, mixing methods shall be in accordance with Section R602.10.4.1.
- h. One- and two- family dwellings in Seismic Design Category D<sub>2</sub> exceeding two stories shall be designed in accordance with accepted engineering practice.
- i. Methods GB and PCP braced wall panel h/w ratio shall not exceed 1:1 in SDC D<sub>0</sub>, D<sub>1</sub> and D<sub>2</sub>. Methods DWB, SFB, PBS, HPS, and CS-SFB are not permitted in D<sub>0</sub>, D<sub>1</sub> and D<sub>2</sub>.

#### **RATIONALE:**

Due to the high geologic activities in the Southern California area and the expected higher level of performance on buildings and structures, this proposed local amendment increase the length and limits the location where shear walls sheathed with lath, plaster or gypsum board are used in multi-level buildings. In addition, shear walls sheathed with other materials are prohibited in Seismic Design Category D<sub>0</sub>, D<sub>1</sub> and D<sub>2</sub> to be consistent with the design limitation for similar shear walls found in the California Building Code. The poor performance of such shear walls in the 1994 Northridge Earthquake was investigated by the Structural Engineers Association of Southern California (SEAOSC) and the Los Angeles City Task Force and formed the basis for this proposed amendment. Considering that shear walls sheathed with lath, plaster or gypsum board are less ductile than steel moment frames or wood structural panel shear walls, the cities and county of the Los Angeles region has taken the necessary measures to limit the potential structural damage that may be caused by the use of such walls at the lower level of multi-level building that are subject to higher levels of seismic loads.









#### **FINDINGS:**

Local Geological Conditions – The greater Los Angeles region is a densely populated area having buildings and structures constructed over and near a vast array of fault systems capable of producing major earthquakes, including but not limited to the recent 1994 Northridge Earthquake. The proposed modification to increase the length and limit the location where shear walls sheathed with lath, plaster or gypsum board are used will help to ensure that multi-level building will reach its performance objective in resisting higher levels of seismic loads and therefore need to be incorporated into the code to assure that new buildings and structures and additions or alterations to existing buildings or structures are designed and constructed in accordance with the scope and objectives of the California Residential Code.

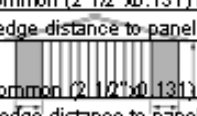
## 2022 LARUCP R6-06

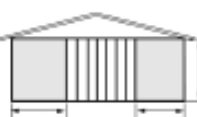
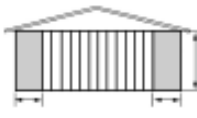
Table R602.10.4 of the 2022 Edition of the California Residential Code is amended to read as follows:

**TABLE R602.10.4  
BRACING METHODS**

METHODS, MATERIAL	MINIMUM THICKNESS	FIGURE	CONNECTION CRITERIA*	
			Fasteners	Spacing
<b>LIB</b> Let-in-bracing	1 × 4 wood or approved metal straps at 45° to 60° angles for maximum 16" stud spacing		Wood: 2-8d common nails or 3-8d (2½" long × 0.113" dia.) nails	Wood: per stud and top and bottom plates
			Metal strap: per manufacturer	Metal: per manufacturer
<b>DWB</b> Diagonal wood boards	¾" (1" nominal) for maximum 24" stud spacing		2-8d (2½" long × 0.113" dia.) nails or 2-1¾" long staples	Per stud
<b>WSP</b> Wood structural panel (See Section R604)	¾"		<del>8d common (2 1/2" x 0.131") nails</del> 3/8" edge distance to panel edge	<del>Exterior sheathing per Table R602.3(3)</del>
			<del>8d common (2 1/2" x 0.131") nails</del> 3/8" edge distance to panel edge	<del>Interior sheathing per Table R602.3(1) or R602.3(2)</del>
<b>BV-WSP*</b> Wood structural panels with stone or masonry veneer (See Section R602.10.6.5)	7/16"	See Figure R602.10.6.5.2	8d common (2½" × 0.131) nails	4" at panel edges 12" at intermediate supports 4" at braced wall panel end posts
<b>SFB</b> Structural fiberboard sheathing	½" or 5/32" for maximum 16" stud spacing		1½" long × 0.12" dia. (for ½" thick sheathing) 1¾" long × 0.12" dia. (for 5/32" thick sheathing) galvanized roofing nails	3" edges 6" field
<b>GB</b> Gypsum board	½"		Nails or screws per Table R602.3(1) for exterior locations	For all braced wall panel locations: 7" edges (including top and bottom plates) 7" field
			Nails or screws per Table R702.3.5 for interior locations	
<b>PBS</b> Particleboard sheathing (See Section R605)	¾" or ½" for maximum 16" stud spacing		For ¾", 6d common (2" long × 0.113" dia.) nails; For ½", 8d common (2½" long × 0.131" dia.) nails	3" edges 6" field
<b>PCP</b> Portland cement plaster	See Section R703.6 for maximum 16" stud spacing		1½" long, 11 gage, 0.120" dia., 7/16" dia. head nails or 7/8" long, 16 gage staples	6" o.c. on all framing members
<b>HPS</b> Hardboard panel siding	7/16" for maximum 16" stud spacing		0.092" dia., 0.225" dia. head nails with length to accommodate 1½" penetration into studs	4" edges 8" field
<b>ABW</b> Alternate braced wall	¾"		See Section R602.10.6.1	See Section R602.10.6.1

(continued)

TABLE R602.10.4—continued  
BRACING METHODS

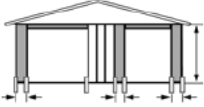
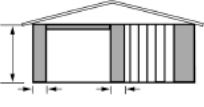
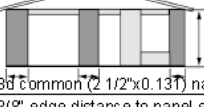
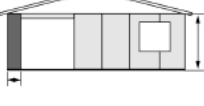
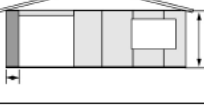
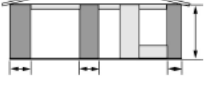
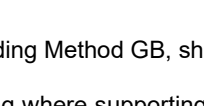
METHODS, MATERIAL	MINIMUM THICKNESS	FIGURE	CONNECTION CRITERIA*	
			Fasteners	Spacing
Intermittent Bracing Methods	PFH Portal frame with hold-downs		See Section R602.10.6.2	See Section R602.10.6.2
	PFG Portal frame at garage		See Section R602.10.6.3	See Section R602.10.6.3
Continuous Sheathing Methods	CS-WSP Continuously sheathed wood structural panel	 8d common (2 1/2"x0.131) nails 3/8" edge distance to panel edge	<del>Exterior sheathing per Table R602.3(3)</del>	6" edges 12" field
	CS-C <sup>b,c</sup> Continuously sheathed wood structural panel adjacent to garage openings	 8d common (2 1/2"x0.131) nails 3/8" edge distance to panel edge	<del>Interior sheathing per Table R602.3(1) or R602.3(2)</del>	Varies by fastener
	CS-G <sup>b,c</sup> Continuously sheathed wood structural panel adjacent to garage openings		See Method CS-WSP	See Method CS-WSP
	CS-PF Continuously sheathed portal frame		See Section R602.10.6.4	See Section R602.10.6.4
CS-SFB <sup>d</sup> Continuously sheathed structural fiberboard	 1/2" or 25/32" for maximum 16" stud spacing	1 1/2" long x 0.12" dia. (for 1/2" thick sheathing) 1 3/4" long x 0.12" dia. (for 25/32" thick sheathing) galvanized roofing nails	3" edges 6" field	

For SI: 1 inch = 25.4 mm, 1 foot = 304.8 mm, 1 degree = 0.0175 rad, 1 pound per square foot = 47.8 N/m<sup>2</sup>, 1 mile per hour = 0.447 m/s.

- Adhesive attachment of wall sheathing, including Method GB, shall not be permitted in Seismic Design Categories C, D<sub>0</sub>, D<sub>1</sub> and D<sub>2</sub>.
- Applies to panels next to garage door opening where supporting gable end wall or roof load only. Shall only be used on one wall of the garage. In Seismic Design Categories D<sub>0</sub>, D<sub>1</sub> and D<sub>2</sub>, roof covering dead load shall not exceed 3 psf.
- Garage openings adjacent to a Method CS-G panel shall be provided with a header in accordance with Table R602.7(1). A full-height clear opening shall not be permitted adjacent to a Method CS-G panel.
- Method CS-SFB does not apply in Seismic Design Categories D<sub>0</sub>, D<sub>1</sub> and D<sub>2</sub>.
- Method applies to detached one- and two- family dwellings in Seismic Design Categories D<sub>0</sub> through D<sub>2</sub> only.
- Methods GB and PCP braced wall panel h/w ratio shall not exceed 1:1 in SDC D<sub>0</sub>, D<sub>1</sub> and D<sub>2</sub>. Methods LIB, DWB, SFB, PBS, HPS, and PFG are not permitted in SDC D<sub>0</sub>, D<sub>1</sub> and D<sub>2</sub>.
- Use of staples in braced wall panels shall be prohibited in SDC D<sub>0</sub>, D<sub>1</sub> and D<sub>2</sub>.

#### RATIONALE:

3/8" thick 3 ply-plywood shear walls experienced many failures during the Northridge Earthquake. Box nails were observed to cause massive and multiple failures of the typical 3/8" thick 3-ply plywood during the Northridge Earthquake. This proposed amendment specifies minimum sheathing thickness, nail size and spacing so as to provide a uniform standard of construction for designers and buildings to follow. This is intended to improve the performance level of buildings and structures that are subject to the higher seismic demands and reduce and limit potential damages to property. This proposed amendment reflects the recommendations by the Structural Engineers Association of Southern California (SEAOSC) and the Los Angeles City Joint Task Force that investigated the poor performance observed in 1994 Northridge Earthquake.



In September 2007, limited cyclic testing was conducted by a private engineering firm to determine if wood structural panels fastened with staples would exhibit the same behavior as the wood structural panels fastened with common nails. The test result revealed that wood structural panel fastened with staples appeared to be much lower in strength and stiffness than wood structural panels fastened with common nails. It was recommended that the use of staples as fasteners for wood structural panel shear walls or diaphragms not be permitted to resist seismic forces in structures assigned to Seismic Design Category D<sub>0</sub>, D<sub>1</sub> and D<sub>2</sub> unless it can be substantiated by cyclic testing.

#### **FINDINGS:**

Local Geological Conditions – The greater Los Angeles region is a densely populated area having buildings and structures constructed over and near a vast array of fault systems capable of producing major earthquakes, including but not limited to the recent 1994 Northridge Earthquake. The proposed modification to place design and construction limits on stapled nail fasteners used in wood structural panel shear walls not substantiated with cyclic testing and requiring minimum sheathing thickness and nailing type and size will help to maintain minimum quality of construction and performance standards of structures and therefore need to be incorporated into the code to assure that new buildings and additions to existing buildings are designed and constructed in accordance with the scope and objectives of the California Residential Code.

## 2022 LARUCP R6-07

Table R602.10.5 of the 2022 Edition of the California Residential Code is amended to read as follows:

**TABLE R602.10.5  
MINIMUM LENGTH OF BRACED WALL PANELS**

METHOD (See Table R602.10.4)		MINIMUM LENGTH <sup>a</sup> (inches)					CONTRIBUTING LENGTH (inches)
		Wall Height					
		8 feet	9 feet	10 feet	11 feet	12 feet	
DWB, WSP, SFB, PBS, PCP, HPS, BV-WSP		48	48	48	53	58	Actual <sup>b</sup>
GB		48	48	48	53	58	Double sided = Actual Single sided = 0.5 × Actual
LIB		55	62	69	NP	NP	Actual <sup>b</sup>
ABW	SDC A, B and C, ultimate design wind speed < 140 mph	28	32	34	38	42	48
	SDC D <sub>0</sub> , D <sub>1</sub> and D <sub>2</sub> , ultimate design wind speed < 140 mph	32	32	34	NP	NP	
CS-G		24	27	30	33	36	Actual <sup>b</sup>
CS-WSP, CS-SFB	Adjacent clear opening height (inches)						Actual <sup>b</sup>
	≤ 64	24	27	30	33	36	
	68	26	27	30	33	36	
	72	27	27	30	33	36	
	76	30	29	30	33	36	
	80	32	30	30	33	36	
	84	35	32	32	33	36	
	88	38	35	33	33	36	
	92	43	37	35	35	36	
	96	48	41	38	36	36	
	100	—	44	40	38	38	
	104	—	49	43	40	39	
	108	—	54	46	43	41	
	112	—	—	50	45	43	
	116	—	—	55	48	45	
	120	—	—	60	52	48	
	124	—	—	—	56	51	
128	—	—	—	61	54		
132	—	—	—	66	58		
136	—	—	—	—	62		
140	—	—	—	—	66		
144	—	—	—	—	72		
METHOD (See Table R602.10.4)		Portal header height					
		8 feet	9 feet	10 feet	11 feet	12 feet	
PFH	Supporting roof only	<del>16</del> <u>24</u>	<del>16</del> <u>24</u>	<del>16</del> <u>24</u>	Note c	Note c	48
	Supporting one story and roof	24	24	24	Note c	Note c	
PFG		24	27	30	Note d	Note d	1.5 × Actual <sup>b</sup>
CS-PF	SDC A, B and C	16	18	20	Note e	Note e	1.5 × Actual <sup>b</sup>
	SDC D <sub>0</sub> , D <sub>1</sub> and D <sub>2</sub>	<del>16</del> <u>24</u>	<del>18</del> <u>24</u>	<del>20</del> <u>24</u>	Note e	Note e	Actual <sup>b</sup>

For SI: 1 inch = 25.4 mm, 1 foot = 304.8 mm, 1 mile per hour = 0.447 m/s.

NP = Not Permitted.

a. Linear interpolation shall be permitted.

- b. Use the actual length where it is greater than or equal to the minimum length.
- c. Maximum header height for PFH is 10 feet in accordance with Figure R602.10.6.2, but wall height shall be permitted to be increased to 12 feet with pony wall.
- d. Maximum header height for PFG is 10 feet in accordance with Figure R602.10.6.3, but wall height shall be permitted to be increased to 12 feet with pony wall.
- e. Maximum header height for CS-PF is 10 feet in accordance with Figure R602.10.6.4, but wall height shall be permitted to be increased to 12 feet with pony wall.

**RATIONALE:**

It was observed by the Structural Engineer Association of Southern California (SEAOSC) and the Los Angeles City Task Force that high aspect ratio shear walls experienced many failures during the 1994 Northridge Earthquake. This proposed amendment provides a uniform standard of construction for designers and buildings to follow. This is intended to improve the performance level of buildings and structures that are subject to the higher seismic demands and reduce and limit potential damages to property. This proposed amendment is consistent with an amendment adopted during the previous code adoption cycle for the California Residential Code.

**FINDINGS:**

Local Geological Conditions – The greater Los Angeles region is a densely populated area having buildings and structures constructed over and near a vast array of fault systems capable of producing major earthquakes, including but not limited to the recent 1994 Northridge Earthquake. The proposed modification ensures that the structural integrity with respect to “maximum shear wall aspect ratios” is maintained, therefore need to be incorporated into the code to assure that new buildings and additions to existing buildings are designed and constructed in accordance with the scope and objectives of the California Residential Code.

## 2022 LARUCP R6-08

Figure R602.10.6.1 of the 2022 Edition of the California Residential Code is amended to read as follows:

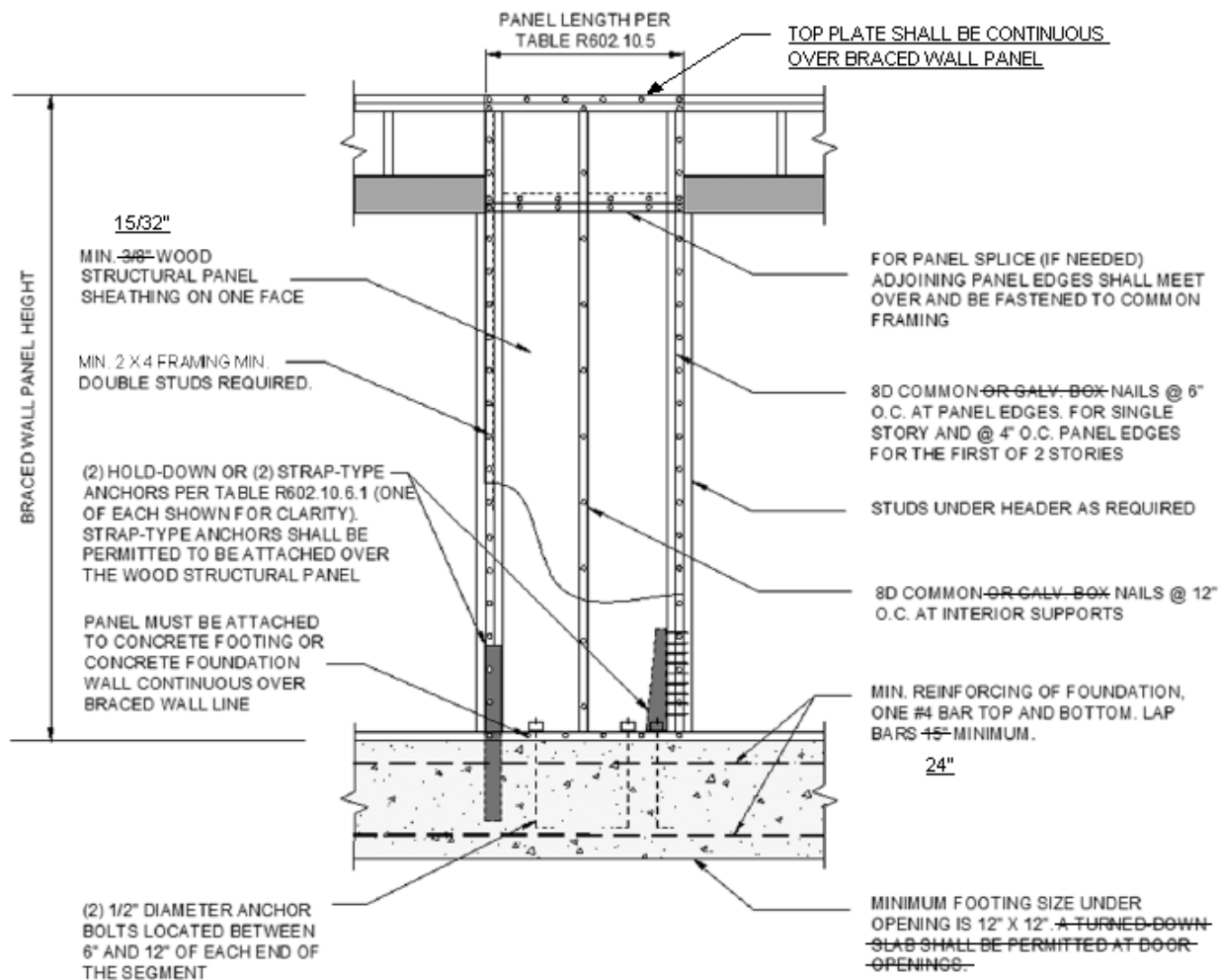

**FIGURE R602.10.6.1  
METHOD ABW—ALTERNATE BRACED WALL PANEL**

### RATIONALE:

3/8" thick 3 ply-plywood shear walls experienced many failures during the Northridge Earthquake. Box nails were observed to cause massive and multiple failures of the typical 3/8" thick 3-ply plywood during the Northridge Earthquake. This proposed amendment specifies minimum sheathing thickness, nail size and spacing so as to provide a uniform standard of construction for designers and buildings to follow. This is intended to improve the performance level of buildings and structures that are subject to the higher seismic demands and reduce and limit potential damages to property. This proposed amendment reflects the recommendations by the Structural Engineers Association of Southern California (SEAOSC) and the Los Angeles City Joint Task Force that investigated the poor performance observed in 1994 Northridge Earthquake.

**FINDINGS:**

Local Geological Conditions – The greater Los Angeles region is a densely populated area having buildings and structures constructed over and near a vast array of fault systems capable of producing major earthquakes, including but not limited to the recent 1994 Northridge Earthquake. The proposed modification requiring minimum sheathing thickness and nailing type and size will help to maintain minimum quality of construction and performance standards of structures and therefore need to be incorporated into the code to assure that new buildings and additions to existing buildings are designed and constructed in accordance with the scope and objectives of the California Residential Code.

## 2022 LARUCP R6-09

Figure R602.10.6.2 of the 2022 Edition of the California Residential Code is amended to read as follows:

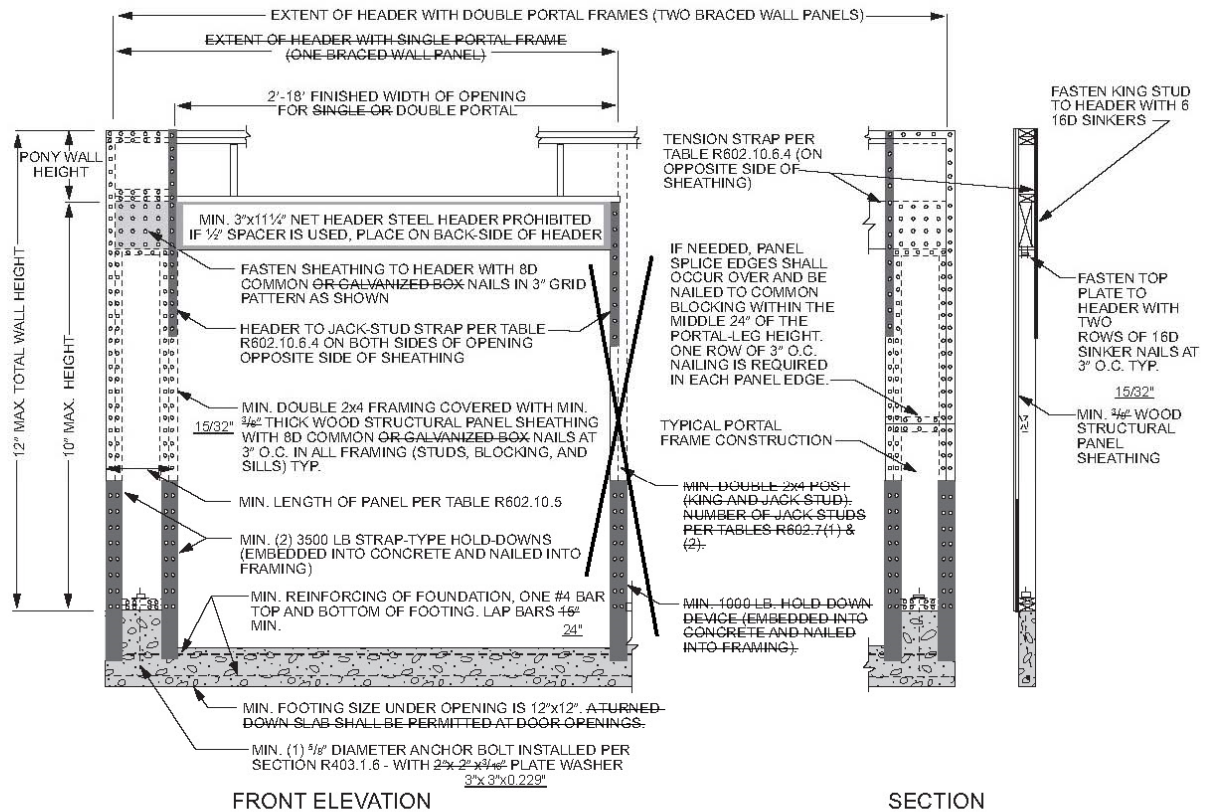

For SI: 1 inch = 25.4 mm, 1 foot = 304.8 mm.

**FIGURE R602.10.6.2**  
**METHOD PFH—PORTAL FRAME WITH HOLD-DOWNS**  
**AT DETACHED GARAGE DOOR OPENINGS**

### RATIONALE:

3/8" thick 3 ply-plywood shear walls experienced many failures during the Northridge Earthquake. Box nails were observed to cause massive and multiple failures of the typical 3/8" thick 3-ply plywood during the Northridge Earthquake. This proposed amendment specifies minimum sheathing thickness, nail size and spacing so as to provide a uniform standard of construction for designers and buildings to follow. This is intended to improve the performance level of buildings and structures that are subject to the higher seismic demands and reduce and limit potential damages to property. This proposed amendment reflects the recommendations by the Structural Engineers Association of Southern California (SEAOSC) and the Los Angeles City Joint Task Force that investigated the poor performance observed in 1994 Northridge Earthquake.

### FINDINGS:

Local Geological Conditions – The greater Los Angeles region is a densely populated area having buildings and structures constructed over and near a vast array of fault systems capable of producing major earthquakes, including but not limited to the recent 1994 Northridge Earthquake. The proposed modification requiring minimum sheathing thickness and nailing type and size will help to maintain minimum quality of construction and performance standards of structures and therefore need to be incorporated into the code to assure that new buildings and additions to existing buildings are designed and constructed in accordance with the scope and objectives of the California Residential Code.



## 2022 LARUCP R6-10

Figure R602.10.6.4 of the 2022 Edition of the California Residential Code is amended to read as follows:

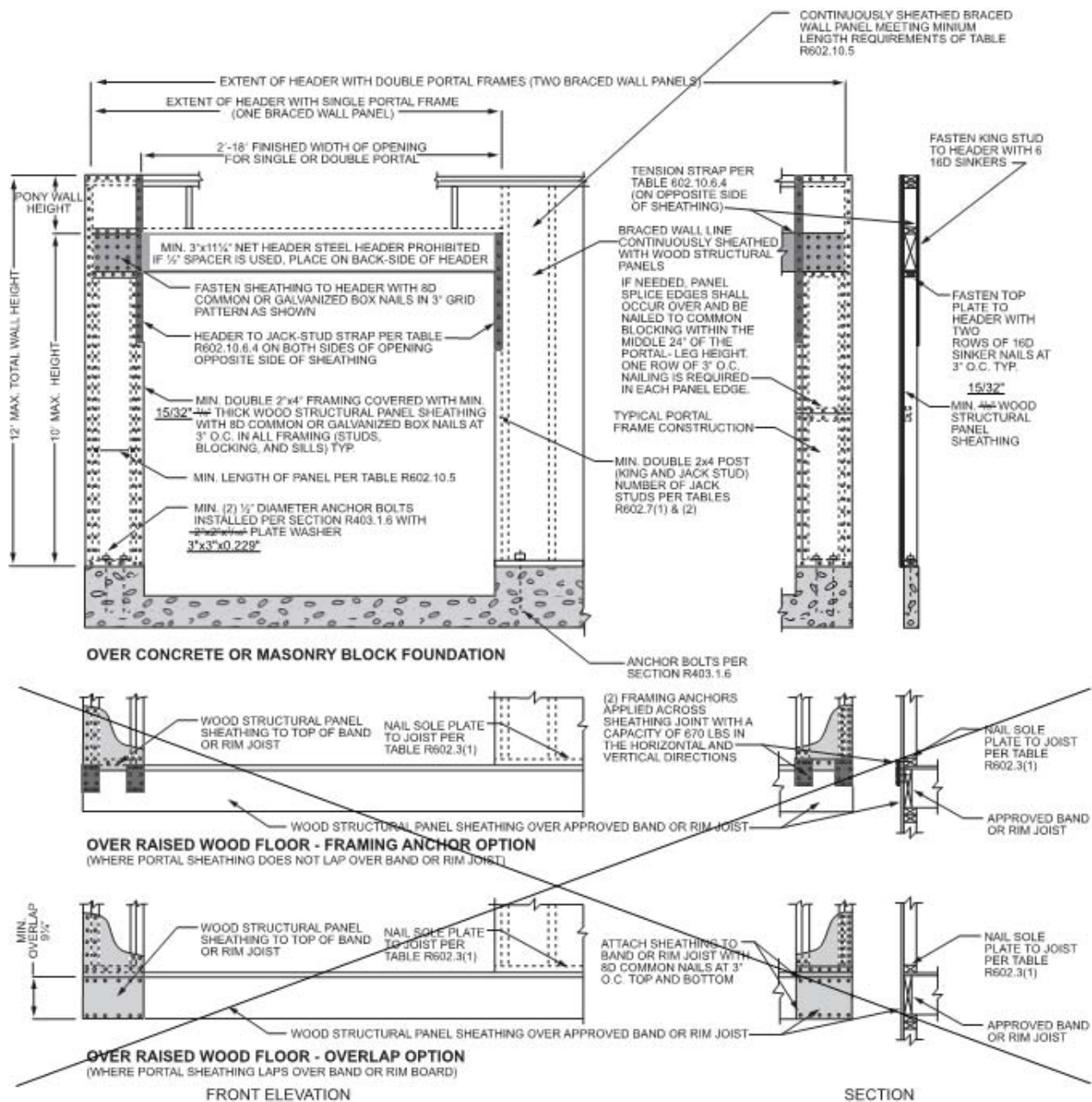

For SI: 1 inch = 25.4 mm, 1 foot = 304.8 mm.

**FIGURE R602.10.6.4**  
**METHOD CS-PF—CONTINUOUSLY SHEATHED PORTAL FRAME PANEL CONSTRUCTION**

### RATIONALE:

3/8" thick 3 ply-plywood shear walls experienced many failures during the Northridge Earthquake. Box nails were observed to cause massive and multiple failures of the typical 3/8" thick 3-ply plywood during the Northridge



Earthquake. This proposed amendment specifies minimum sheathing thickness, nail size and spacing to provide a uniform standard of construction for designers and buildings to follow. This is intended to improve the performance level of buildings and structures that are subject to the higher seismic demands and reduce and limit potential damages to property. This proposed amendment reflects the recommendations by the Structural Engineers Association of Southern California (SEAOSC) and the Los Angeles City Joint Task Force that investigated the poor performance observed in 1994 Northridge Earthquake.

#### **FINDINGS:**

Local Geological Conditions – The greater Los Angeles region is a densely populated area having buildings and structures constructed over and near a vast array of fault systems capable of producing major earthquakes, including but not limited to the recent 1994 Northridge Earthquake. The proposed modification requiring minimum sheathing thickness and nailing type and size will help to maintain minimum quality of construction and performance standards of structures and therefore need to be incorporated into the code to assure that new buildings and additions to existing buildings are designed and constructed in accordance with the scope and objectives of the California Residential Code.

## 2022 LARUCP R6-11

Section R606.4.4 of the 2022 Edition of the California Residential Code is amended to read as follows:

**R606.4.4 Parapet walls.** Unreinforced solid masonry parapet walls shall not be less than 8 inches (203 mm) thick and their height shall not exceed four times their thickness. Unreinforced hollow unit masonry parapet walls shall be not less than 8 inches (203 mm) thick, and their height shall not exceed three times their thickness. Masonry parapet walls in areas subject to wind loads of 30 pounds per square foot (1.44 kPa) or located in Seismic Design Category D<sub>0</sub>, D<sub>1</sub> or D<sub>2</sub>, or on townhouses in Seismic Design Category C shall be reinforced in accordance with Section R606.12.

### RATIONALE:

The addition of the word "or" will prevent the use of unreinforced parapets in Seismic Design Category D<sub>0</sub>, D<sub>1</sub> or D<sub>2</sub>, or on townhouses in Seismic Design Category C.

### FINDINGS:

Local Geological Conditions – The greater Los Angeles region is a densely populated area having buildings and structures constructed over and near a vast array of fault systems capable of producing major earthquakes, including but not limited to the recent 1994 Northridge Earthquake. The proposed modification to not allow the use of unreinforced masonry is intended to prevent non-ductile failures and sudden structural collapses and therefore needs to be incorporated into the code to assure that new buildings and structures and additions or alterations to existing buildings or structures are designed and constructed in accordance with the scope and objectives of the California Residential Code.

## 2022 LARUCP R6-12

Section R606.12.2.2.3 of the 2022 Edition of the California Residential Code is amended to read as follows:

**R606.12.2.2.3 Reinforcement requirements for masonry elements.** Masonry elements listed in Section R606.12.2.2.2 shall be reinforced in either the horizontal or vertical direction as shown in Figure ~~R606.11(2)~~ R606.11(2) and in accordance with the following:

1. Horizontal reinforcement. Horizontal joint reinforcement shall consist of ~~not less than two longitudinal W1.7 wires spaced not more than 16 inches (406 mm) for walls greater than 4 inches (102 mm) in width and at least one longitudinal W1.7 wire spaced not more than 16 inches (406 mm) for walls not exceeding 4 inches (102 mm) in width; or not less than one No. 4 bar spaced not more than 48 inches (1219 mm). Where two longitudinal wires of joint reinforcement are used, the space between these wires shall be the widest that the mortar joint will accommodate.~~ Horizontal reinforcement shall be provided within 16 inches (406 mm) of the top and bottom of these masonry elements.
2. Vertical reinforcement. Vertical reinforcement shall consist of not less than one No. 4 bar spaced not more than 48 inches (1219 mm). Vertical reinforcement shall be within ~~48~~ inches (~~406~~203 mm) of the ends of masonry walls.

### RATIONALE:

Reinforcement using longitudinal wires for buildings and structures located in high seismic areas are deficient and not as ductile as deformed rebar. Having vertical reinforcement closer to the ends of masonry walls help to improve the seismic performance of masonry buildings and structures.

### FINDINGS:

Local Geological Conditions – The greater Los Angeles region is a densely populated area having buildings and structures constructed over and near a vast array of fault systems capable of producing major earthquakes, including but not limited to the recent 1994 Northridge Earthquake. The proposed modification to increase reinforcements will ensure that the ductility requirements for buildings in high seismic region meet the intent of the code and limit potential property damages and therefore need to be incorporated into the code to assure that new buildings and structures and additions or alterations to existing buildings or structures are designed and constructed in accordance with the scope and objectives of the California Residential Code.

## 2022 LARUCP R8-01

Section R803.2.4 is added to Chapter 8 of the 2022 Edition of the California Residential Code to read as follows:

**R803.2.4 Openings in horizontal diaphragms.** Openings in horizontal diaphragms shall conform with Section R503.2.4.

### **RATIONALE:**

Section R802 of the Code does not provide any prescriptive criteria to limit the maximum roof opening size nor does Section R803 provide any details to address the issue of shear transfer near larger roof openings. With the higher seismic demand placed on buildings and structures in this region, it is important to ensure that a complete load path is provided to reduce or eliminate potential damages caused by seismic forces. Requiring blocking with metal ties around larger roof openings and limiting opening size is consistent with the requirements of Section R301.2.2.6.

### **FINDINGS:**

Local Geological Conditions – The greater Los Angeles region is a densely populated area having buildings and structures constructed over and near a vast array of fault systems capable of producing major earthquakes, including but not limited to the recent 1994 Northridge Earthquake. The proposed modification to require specific detailing at large roof openings is intended to address the poor performance of roof diaphragms with openings and limit or reduce property damages during a seismic event and therefore needs to be incorporated into the code to assure that new buildings and structures and additions or alterations to existing buildings or structures are designed and constructed in accordance with the scope and objectives of the California Residential Code.

## 2022 LARUCP R10-01

Section R1001.3.1 of the 2022 Edition of the California Residential Code is amended to read as follows:

**R1001.3.1 Vertical reinforcing.** For chimneys up to 40 inches (1016 mm) wide, four No. 4 continuous vertical bars adequately anchored into the concrete foundation shall be placed between wythes of solid masonry or within the cells of hollow unit masonry and grouted in accordance with Section R606. Grout shall be prevented from bonding with the flue liner so that the flue liner is free to move with thermal expansion. For chimneys more than 40 inches (1016 mm) wide, two additional No. 4 vertical bars adequately anchored into the concrete foundation shall be provided for each additional flue incorporated into the chimney or for each additional 40 inches (1016 mm) in width or fraction thereof.

### RATIONALE:

The performance of fireplace/chimney without anchorage to the foundation has been observed to be inadequate during major earthquakes. The lack of anchorage to the foundation can result in the overturning or displacement of the fireplace/chimney.

### FINDINGS:

Local Geological Conditions – The greater Los Angeles region is a densely populated area having buildings and structures constructed over and near a vast array of fault systems capable of producing major earthquakes, including but not limited to the recent 1994 Northridge Earthquake. The proposed modification to anchor masonry chimneys into concrete foundation will reduce injuries, save lives, and minimize structural damages and therefore needs to be incorporated into the code to assure that new buildings and structures and additions or alterations to existing buildings or structures are designed and constructed in accordance with the scope and objectives of the California Residential Code.

## **PART III**

LARUCP RECOMMENDED CODE AMENDMENTS TO THE  
2022 EDITION OF THE CALIFORNIA GREEN BUILDING  
STANDARDS CODE  
(MANDATORY REQUIREMENTS)

## SUMMARY OF RECOMMENDED LARUCP AMENDMENTS TO THE 2022 CALGREEN

2022 LARUCP NO.	TITLE/DESCRIPTION	STATUS <sup>1</sup>
G4-01	Amend CALGreen Section 4.106.4.2.1 EV for New Multifamily Development Projects	N
G4-02	Amend CALGreen Section 4.106.4.2.2 EV for New Multifamily Development Projects	N
G5-01	Amend CALGreen Exception 2 of Section 5.106.5.3 EV for New Nonresidential Development Projects	N

**FOOTNOTE:**

1. N = New amendment proposed  
E = Existing amendment updated as necessary



## 2022 LARUCP G4-01

Section 4.106.4.2.1 of the 2022 Edition of the California Green Building Standards Code is amended to read as follows:

**4.106.4.2.1 Multifamily development projects with less than 20 dwelling units; and hotels and motels with less than 20 sleeping units or guest rooms.** The number of dwelling units, sleeping units or guest rooms shall be based on all buildings on a project site subject to this section.

1. **EV Capable.** Ten (10) percent of the total number of parking spaces on a building site, provided for all types of parking facilities, shall be electric vehicle charging spaces (EV spaces) capable of supporting future Level 2 EVSE. Electrical load calculations shall demonstrate that the electrical panel service capacity and electrical system, including any on-site distribution transformer(s), have sufficient capacity to simultaneously charge all EVs at all required EV spaces at a minimum of 40 amperes.

The service panel or subpanel circuit directory shall identify the overcurrent protective device space(s) reserved for future EV charging purposes as "EV CAPABLE" in accordance with the California Electrical Code.

### Exceptions:

1. When EV chargers (Level 2 EVSE) are installed in a number equal to or greater than the required number of EV capable spaces.
2. When EV chargers (Level 2 EVSE) are installed in a number less than the required number of EV capable spaces, the number of EV capable spaces required may be reduced by a number equal to the number of EV chargers installed.
3. Areas of parking facilities served by parking lifts or parking spaces accessible only by automated mechanical car parking systems.

### Notes:

- a. Construction documents are intended to demonstrate the project's capability and capacity for facilitating future EV charging.
  - b. There is no requirement for EV spaces to be constructed or available until receptacles for EV charging or EV chargers are installed for use.
2. **EV Ready.** Twenty-five (25) percent of the total number of parking spaces shall be equipped with low power Level 2 EV charging receptacles. For multifamily parking facilities, no more than one receptacle is required per dwelling unit when more than one parking space is provided for use by a single dwelling unit.

**Exception:** Areas of parking facilities served by parking lifts or parking spaces accessible only by automated mechanical car parking systems.

### RATIONALE:

This proposed amendment clarifies that the exception for parking lift is applicable to automated mechanical car parking system as both serve a similar function for the parking of cars.

### FINDINGS:

Local Administrative Clarification – The proposed modification is necessary for local administrative clarification, does not modify a Building Standards as defined in Section 18909(c) of the California Health and Safety Code, and does not require the express findings and determination required by Sections 17958, 17958.5 and 17958.7 of the California Health and Safety Code. The proposed modification to clarify that the exception that apply to

parking lifts should apply to automated mechanical car parking system as both serve a similar function for parking cars and therefore need to be incorporated into the code to assure that new buildings and structures and additions or alterations to existing buildings or structures are designed and constructed in accordance with the scope and objectives of the California Green Building Standards Code.

## 2022 LARUCP G4-02

Section 4.106.4.2.2 of the 2022 Edition of the California Green Building Standards Code is amended to read as follows:

**4.106.4.2.2 Multifamily development projects with 20 or more dwelling units, hotels and motels with 20 or more sleeping units or guest rooms.** The number of dwelling units, sleeping units or guest rooms shall be based on all buildings on a project site subject to this section.

1. **EV Capable.** Ten (10) percent of the total number of parking spaces on a building site, provided for all types of parking facilities, shall be electric vehicle charging spaces (EV spaces) capable of supporting future Level 2 EVSE. Electrical load calculations shall demonstrate that the electrical panel service capacity and electrical system, including any on-site distribution transformer(s), have sufficient capacity to simultaneously charge all EVs at all required EV spaces at a minimum of 40 amperes.

The service panel or subpanel circuit directory shall identify the overcurrent protective device space(s) reserved for future EV charging purposes as "EV CAPABLE" in accordance with the California Electrical Code.

**Exceptions:**

1. When EV chargers (Level 2 EVSE) are installed in a number greater than five (5) percent of parking spaces required by Section 4.106.4.2.2, Item 3, the number of EV capable spaces required may be reduced by a number equal to the number of EV chargers installed over the five (5) percent required.
2. Areas of parking facilities served by parking lifts or parking spaces accessible only by automated mechanical car parking systems.

**Notes:**

- a. Construction documents shall show locations of future EV spaces.
  - b. There is no requirement for EV spaces to be constructed or available until receptacles for EV charging or EV chargers are installed for use.
2. **EV Ready.** Twenty-five (25) percent of the total number of parking spaces shall be equipped with low power Level 2 EV charging receptacles. For multifamily parking facilities, no more than one receptacle is required per dwelling unit when more than one parking space is provided for use by a single dwelling unit.

**Exception:** Areas of parking facilities served by parking lifts or parking spaces accessible only by automated mechanical car parking systems.

3. **EV Chargers.** Five (5) percent of the total number of parking spaces shall be equipped with Level 2 EVSE. Where common use parking is provided, at least one EV charger shall be located in the common use parking area and shall be available for use by all residents or guests.

When low power Level 2 EV charging receptacles or Level 2 EVSE are installed beyond the minimum required, an automatic load management system (ALMS) may be used to reduce the maximum required electrical capacity to each space served by the ALMS. The electrical system and any on-site distribution transformers shall have sufficient capacity to deliver at least 3.3 kW simultaneously to each EV charging station (EVCS) served by the ALMS. The branch circuit shall have a minimum capacity of 40 amperes and installed EVSE shall have a capacity of not less than 30 amperes. ALMS shall not be used to reduce the minimum required electrical capacity to the required EV capable spaces.

**Exception:** Areas of parking facilities served by parking lifts or parking spaces accessible only by automated mechanical car parking systems.

**RATIONALE:**

This proposed amendment clarifies that the exception for parking lift is applicable to automated mechanical car parking system as both serve a similar function for the parking of cars.

**FINDINGS:**

Local Administrative Clarification – The proposed modification is necessary for local administrative clarification, does not modify a Building Standards as defined in Section 18909(c) of the California Health and Safety Code, and does not require the express findings and determination required by Sections 17958, 17958.5 and 17958.7 of the California Health and Safety Code. The proposed modification to clarify that the exception that apply to parking lifts should apply to automated mechanical car parking system as both serve a similar function for parking cars and therefore need to be incorporated into the code to assure that new buildings and structures and additions or alterations to existing buildings or structures are designed and constructed in accordance with the scope and objectives of the California Green Building Standards Code.

## 2022 LARUCP G5-01

Exception 2 of Section 5.106.5.3 of the 2022 Edition of the California Green Building Standards Code is amended to read as follows:

**5.106.5.3 Electric vehicle (EV) charging.** [N] Construction to provide electric vehicle infrastructure and facilitate electric vehicle charging shall comply with Section 5.106.5.3 and shall be provided in accordance with regulations in the California Building Code and the California Electrical Code.

### Exceptions:

1. On a case by case basis where the local enforcing agency has determined compliance with this section is not feasible based upon one of the following conditions:
  - a. Where there is no local utility power.
  - b. Where the local utility is unable to supply adequate power.
  - c. Where there is evidence suitable to the local enforcement agency substantiating that additional local utility infrastructure design requirements, directly related to the implementation of Section 5.106.5.3, may adversely impact the construction cost of the project.
2. Areas of parking facilities served by parking lifts or Pparking spaces accessible only by automated mechanical car parking systems are not required to comply with this code section.

### RATIONALE:

This proposed amendment clarifies that the exception for parking lift is applicable to automated mechanical car parking system as both serve a similar function for the parking of cars.

### FINDINGS:

Local Administrative Clarification – The proposed modification is necessary for local administrative clarification, does not modify a Building Standards as defined in Section 18909(c) of the California Health and Safety Code, and does not require the express findings and determination required by Sections 17958, 17958.5 and 17958.7 of the California Health and Safety Code. The proposed modification to clarify that the exception that apply to parking lifts should apply to automated mechanical car parking system as both serve a similar function for parking cars and therefore need to be incorporated into the code to assure that new buildings and structures and additions or alterations to existing buildings or structures are designed and constructed in accordance with the scope and objectives of the California Green Building Standards Code.



Copyright © 2021 ICC Los Angeles Basin Chapter - All Rights Reserved.  
P.O. Box 1099, Alhambra, CA 91802