

2018 IBC Significant Changes

Based on the
2015 and 2018 editions of the
International Building Code[®], (IBC[®])

LEARNING
center



Identify changes between
the 2015 and 2018 IBC

Apply code requirements to design, plan
submittals and/or inspection.



2018 IBC Significant Changes

OBJECTIVES

- Identify the differences between 2015 IBC and 2018 codes.
- Determine if the change is an addition, deletion, modification or clarification.
- Identify changes in format and technical requirements.
- Explain the intent and application of the changes.

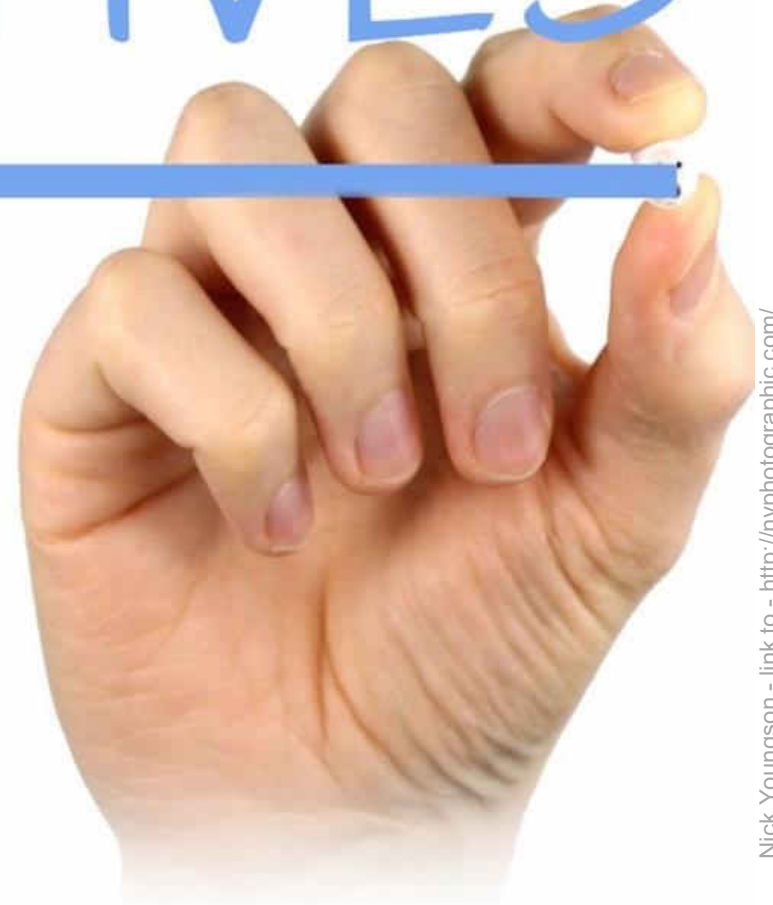

Nick Youngson - link to - <http://nyphotographic.com/>



← 2018 IBC Significant Changes



Tips

Guide to a successful class:

- Slides contain some text and iconic images to help you learn.
- Text and commentary is in the handout.
- Follow along in the course handout.
- Ask Questions, ask questions, **ASK QUESTIONS!!!!**



Course Icons



Addition



Deletion



Modification



Clarification



2018 IBC Significant Changes



Chapter 2

Definitions



202 Definition of Greenhouse

- Structure of thermally-isolated area of building that maintains a specialized sunlit environment
- Focus is on the cultivation, protection and maintenance of plants rather than the structure itself or the presence of plants





202 Definition of Repair Garage

- Motor vehicle:
 - Servicing, or
 - Repair



2018 IBC Significant Changes



202 Definition of Sleeping Unit

- Clarifies bedrooms within residential unit not to be considered as sleeping units
- Consistent with dwelling unit provisions

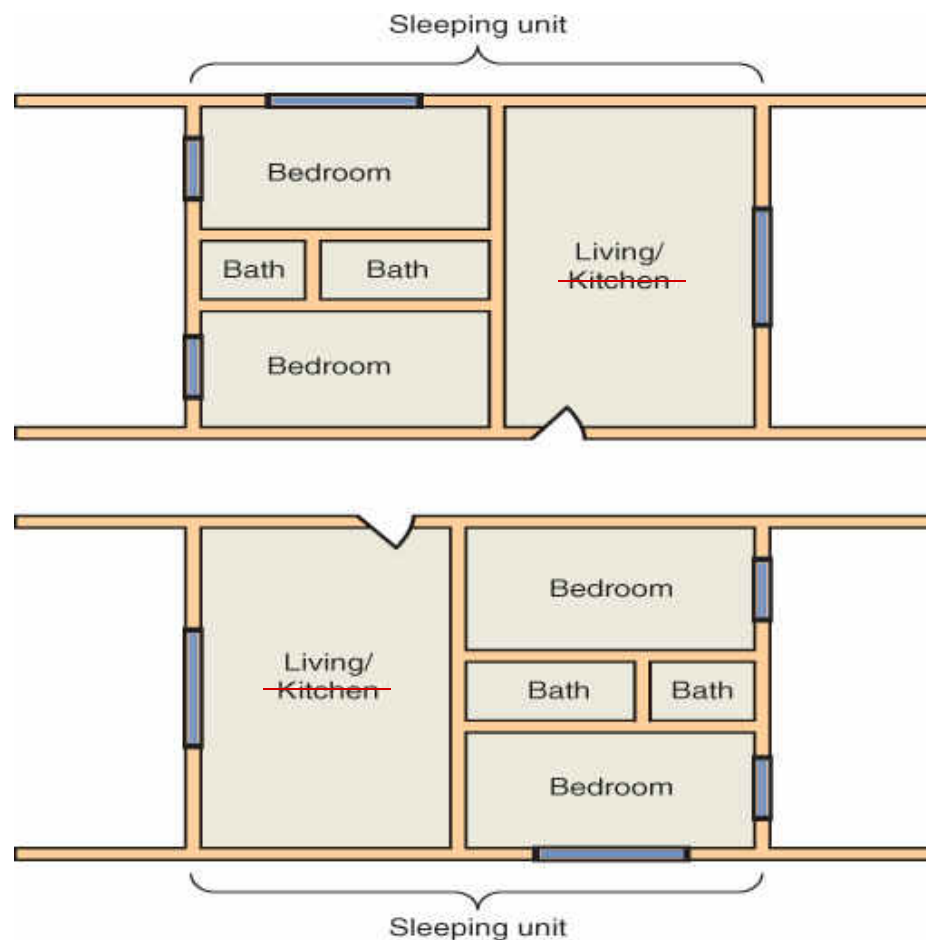

Chapter 2 Removal of Definition References



- References throughout code to Chapter 2 for specific definitions have been removed

~~502.1 Definitions.~~ The following terms are defined in Chapter 2:

~~AREA, BUILDING.~~

~~BASEMENT.~~

~~EQUIPMENT PLATFORM.~~

~~HEIGHT, BUILDING.~~

~~MEZZANINE.~~





Chapter 3

Use and Occupancy

302.1 Classification of Outdoor Areas



303.4 Assembly Use of Greenhouses Classification

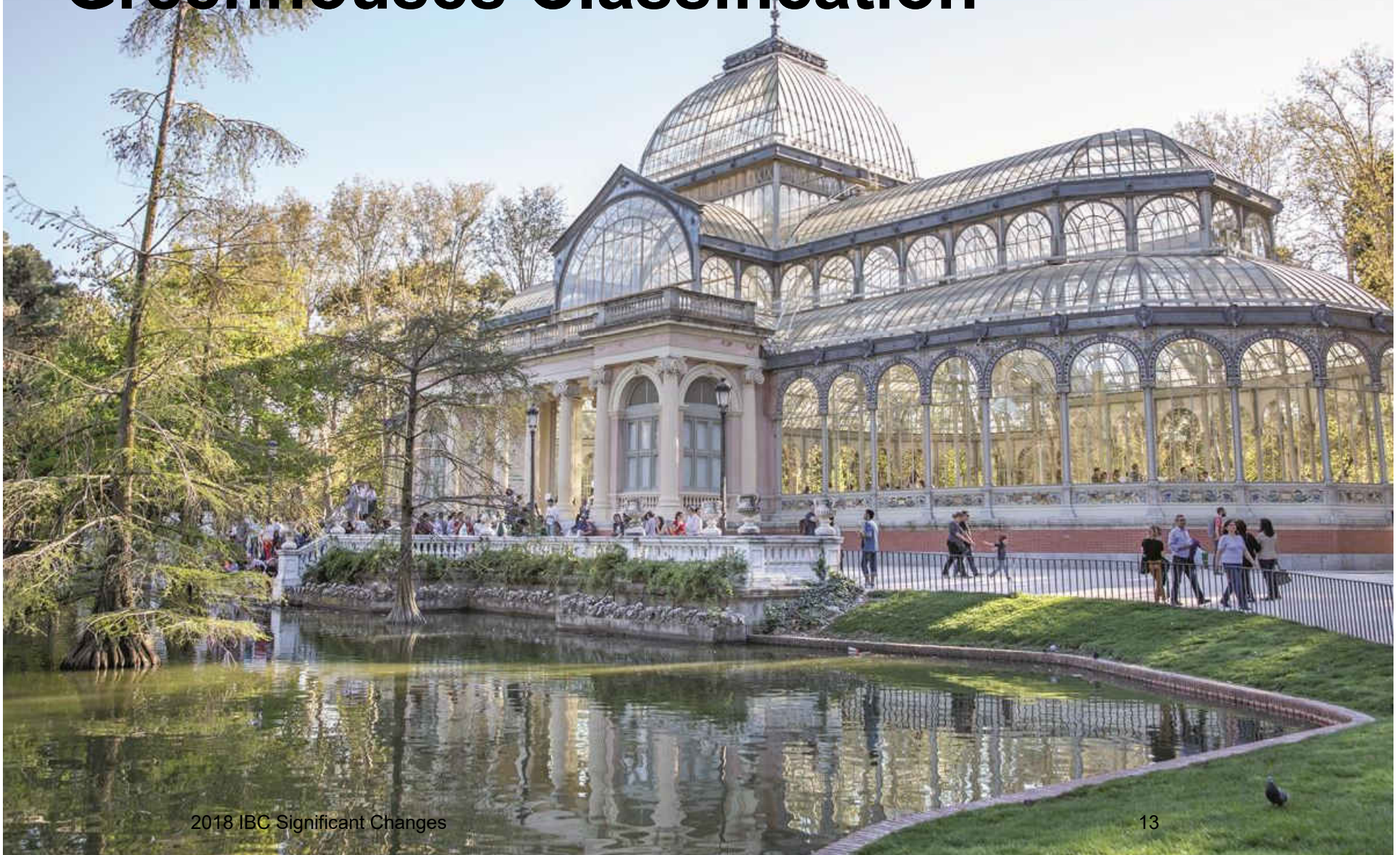

309.1 Mercantile Use of Greenhouses Classification





310.3, 310.4 Classification of Congregate Living Facilities

- All nontransient congregate living facilities with 16 or fewer occupants to be classified as Group R-3, including:
 - Dormitories
 - Fraternity and sorority houses
 - Convents
- Group R-3 lodging houses to now have 10 or fewer occupants



310.4.4 Owner-Occupied Lodging Houses



- Owner-occupied lodging houses permitted to comply with IRC where:
 - 5 or fewer guest rooms, and
 - 10 or fewer total occupants



311.1.1 Classification of Accessory Storage Rooms



- Room or space used for storage accessory to another occupancy to be classified as part of that occupancy



311.2 Classification of Self-Service Storage Facilities



Group S-1 Occupancy

312.1 Classification of Communication Equipment Structures



- Group U classification applies where floor area less than 1,500 sf

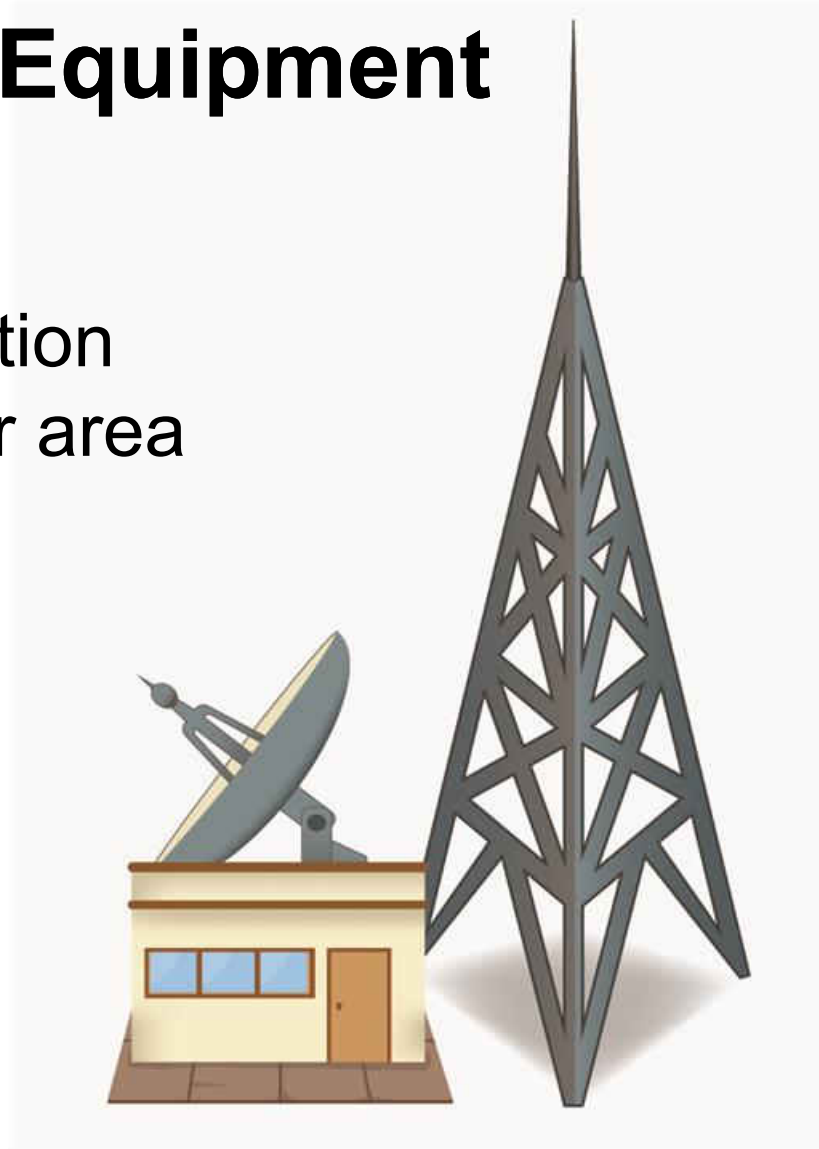



312.1.1 Classification of Agricultural Greenhouses

- Group U classification applies where greenhouse not classified as another occupancy



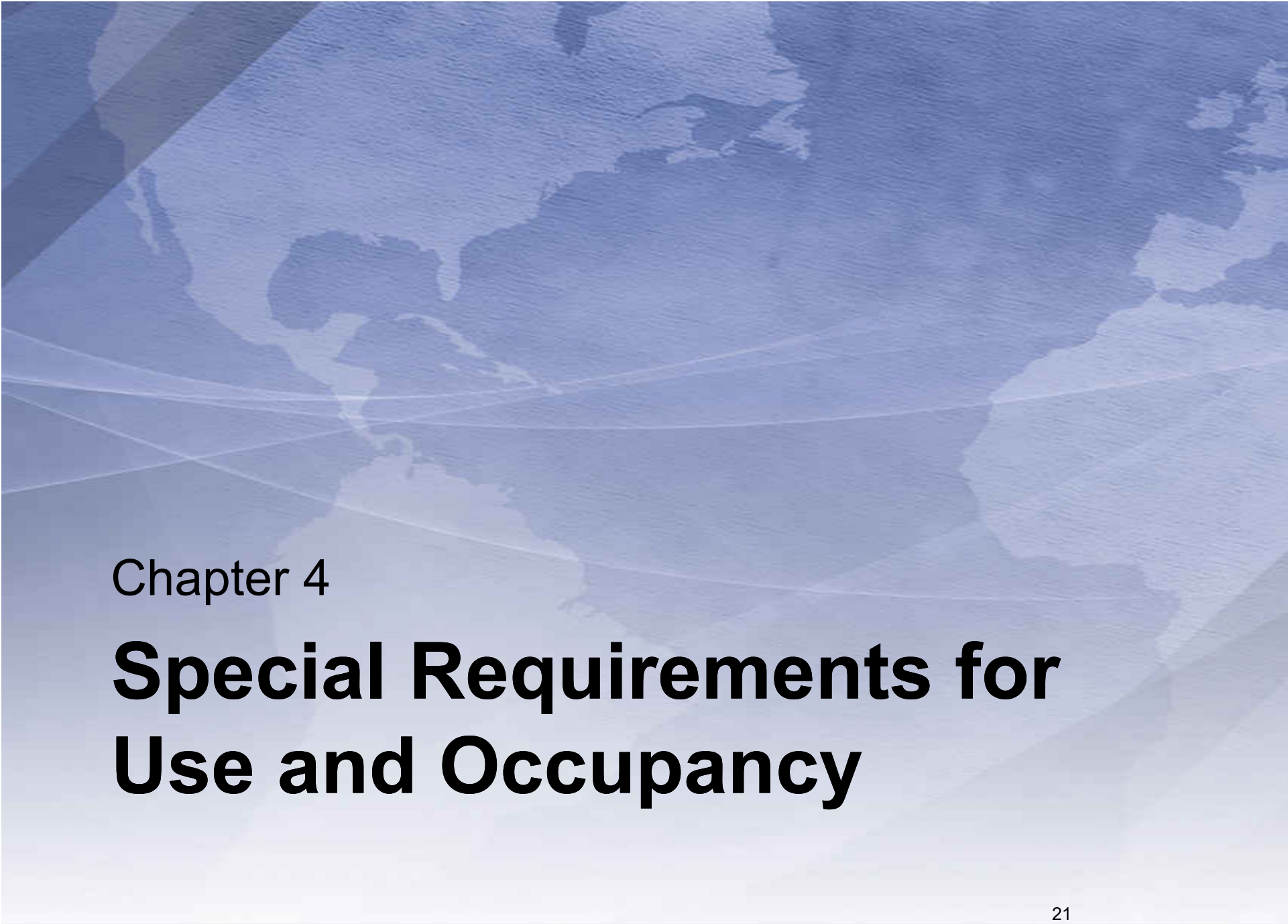

Chapter 4

Special Requirements for Use and Occupancy

403.2.1.1 Type of Construction in High-Rise Buildings



- Type IB high-rise buildings containing Group H-2, H-3 or H-5 occupancy not permitted to be regulated as Type IIA for fire-resistance ratings





404.6 Enclosure of Atriums

- Separation between atrium and adjoining spaces not required where smoke control system not required





406.1 Motor Vehicle-Related Occupancies

- Reorganization includes grouping of requirements that apply to all motor-vehicle-related uses





406.3 Regulation of Private Garages

- Private garages now permitted to comply with public parking garage provisions





406.6.2 Ventilation of Enclosed Parking Garages

- Chapters 4 and 5 of IMC now specifically addressed for ventilation and exhaust requirements
- Although limited in application, exception for one- and two-family dwellings has also been established

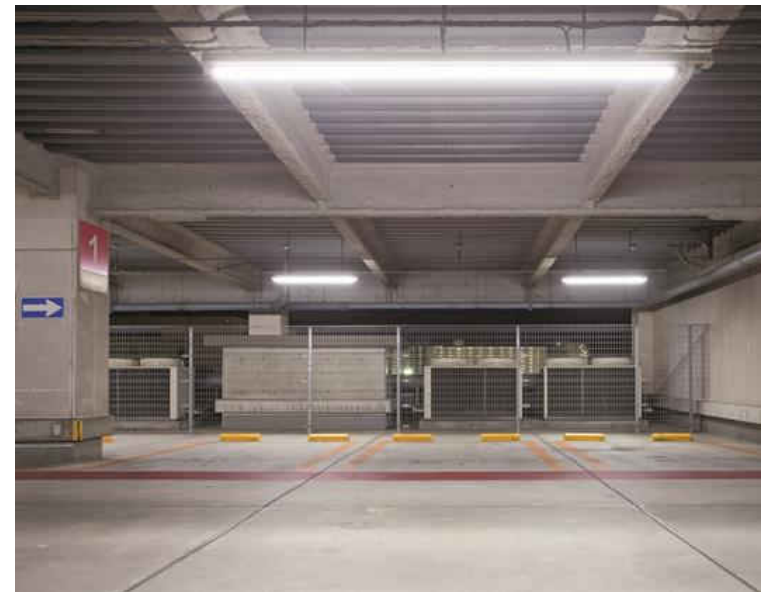



407.5 Maximum Smoke Compartment Size

- Applicable to Group I-2, Condition 2 occupancies

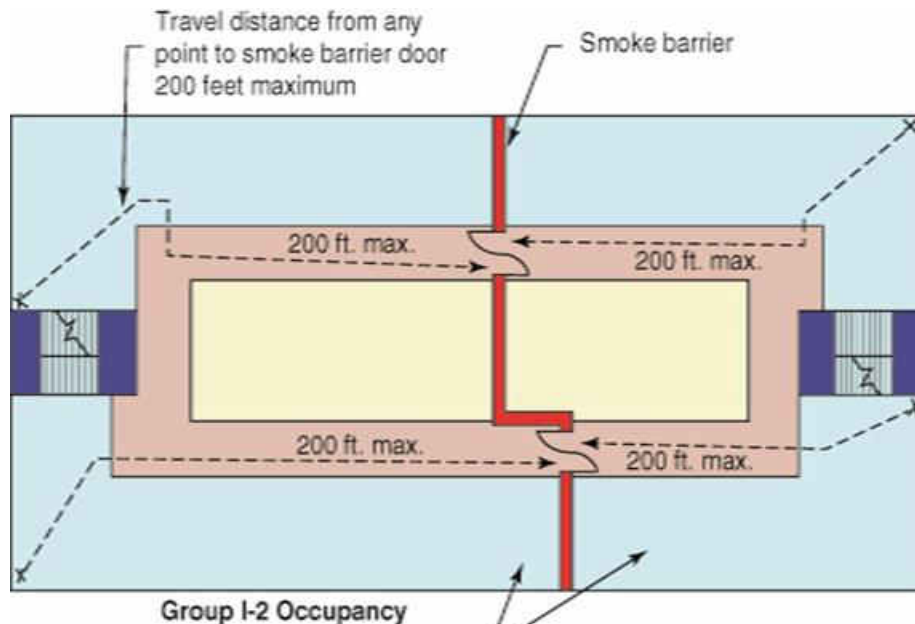

Maximum smoke compartment size permitted to be increased to 40,000 sq. ft. where:

- All patient sleeping rooms within compartment configured for single patient occupancy, or
- Compartment contains no patient sleeping rooms

Minimum of 2 smoke compartments
Maximum size of compartment
22,500 sq. ft.





407.5.4 Required Egress from Smoke Compartments

NONCOMPLIANT EXAMPLES

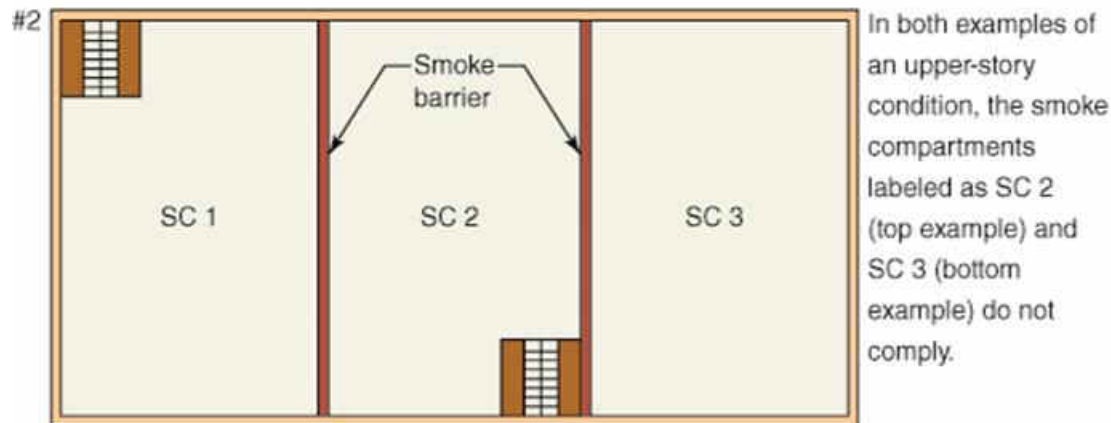
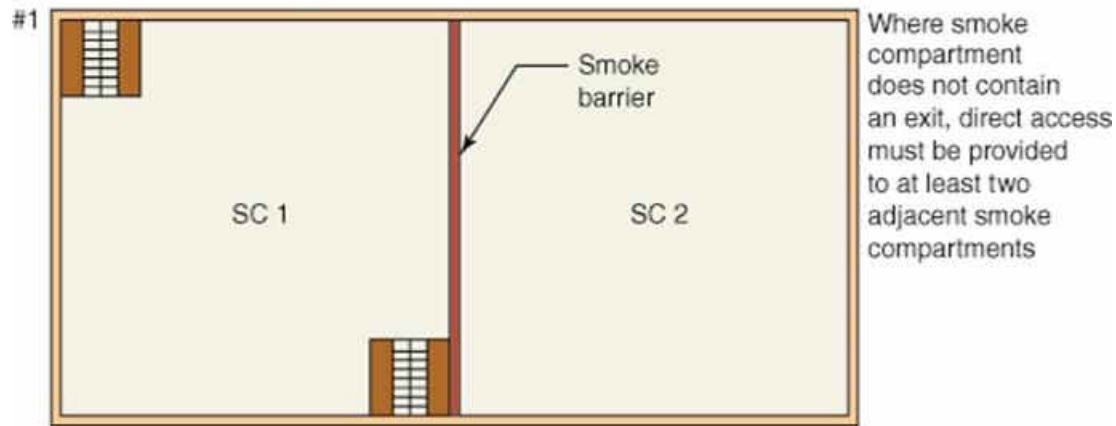



420.7 Corridor Protection in Assisted Living Units

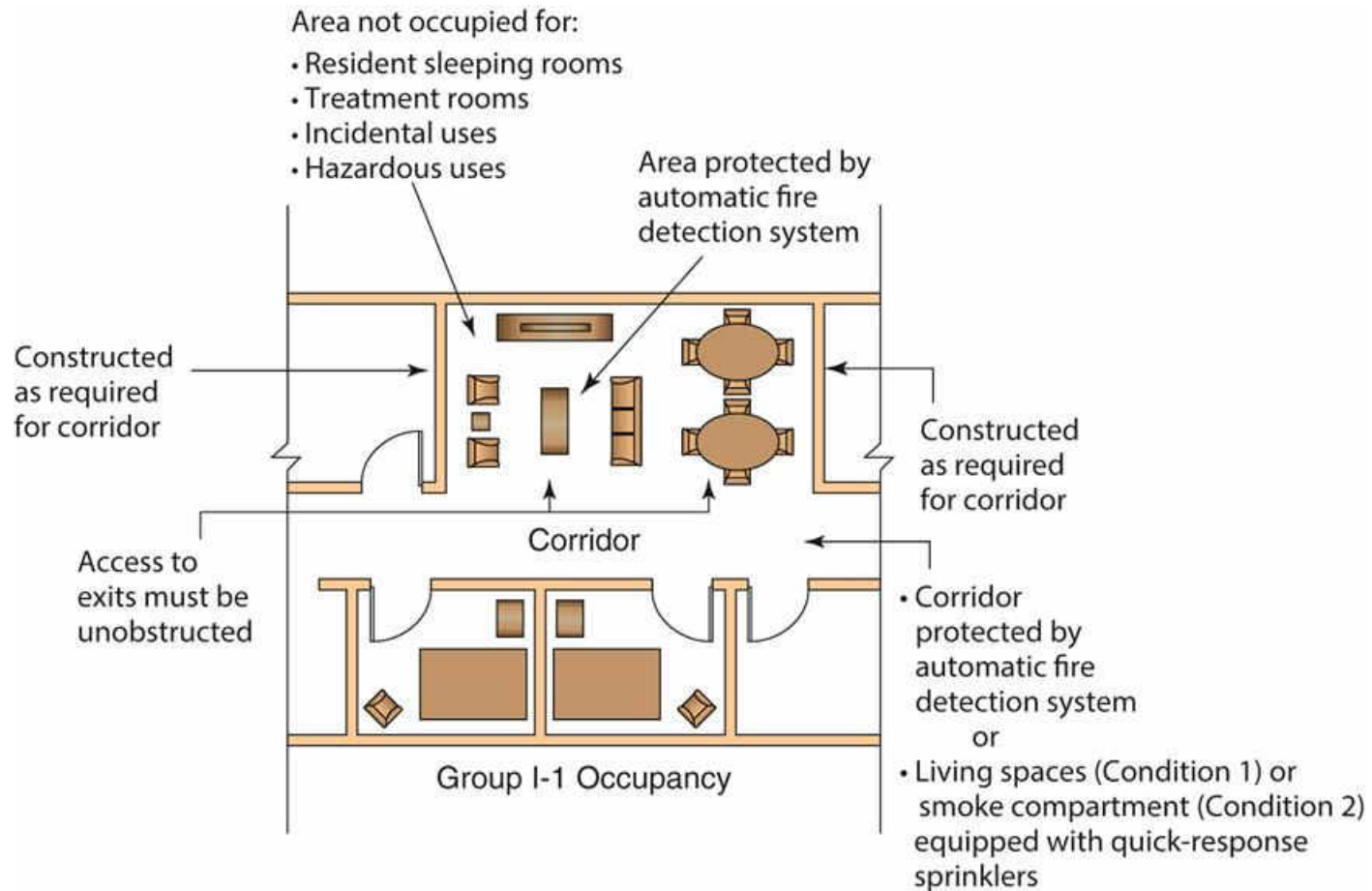



420.8 Group I-1 Cooking Facilities

- Appliances limited to ovens, cooktops, ranges, warmers and microwaves
- Fuel and electrical supply to cooking equipment be provided with shut-off accessible only to staff
- Timer to deactivate cooking appliances within 2 hours

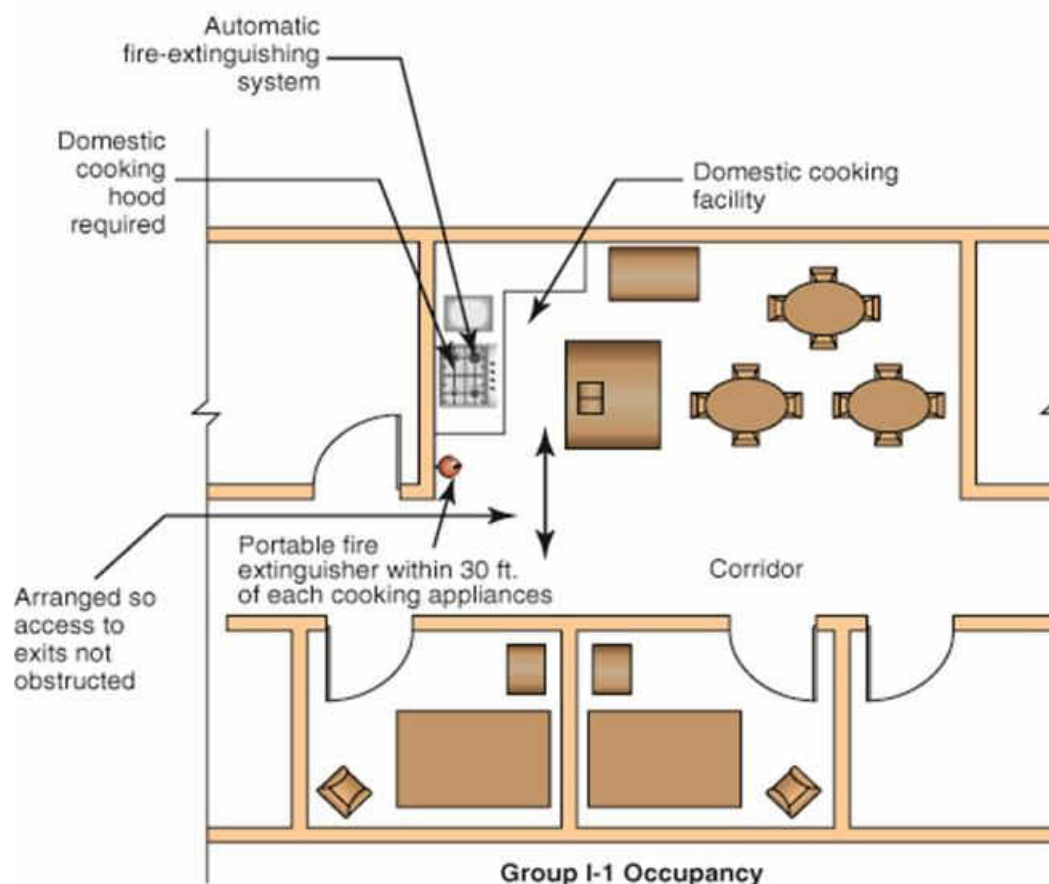



420.10 Dormitory Cooking Facilities

- Domestic cooking appliances for resident use now regulated
- Cooktops, ranges and ovens not permitted in sleeping rooms





422.6 Electrical Systems in Ambulatory Care Facilities

- New references identified for essential electrical systems in ambulatory care facilities:
 - IBC Section 2702: Emergency and Standby Power Systems
 - NFPA 99: *Health Care Facilities Code*

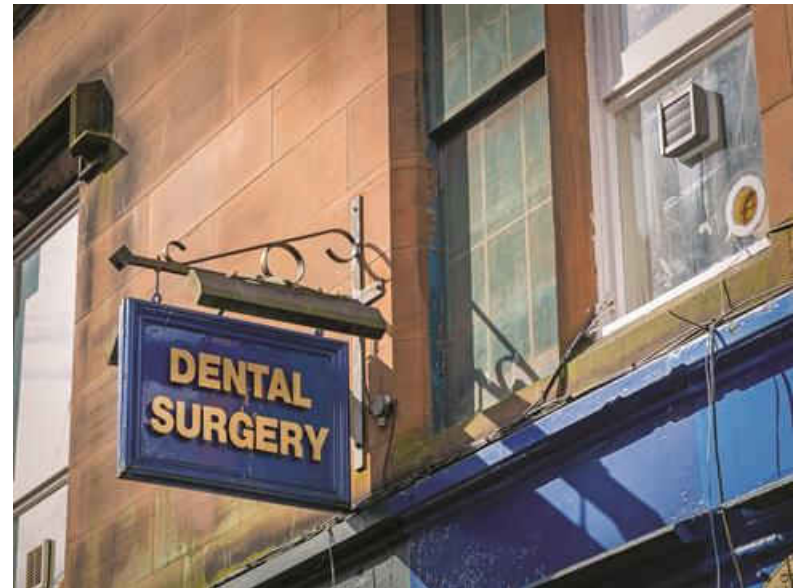



424.1 Children's Play Structures

- Play structures regulated where:
 - Over 10 feet in height, or
 - 150 sf in area





427 Medical Gas Systems

- IFC construction-related provisions for medical gas systems now replicated in IBC



427 Medical Gas Systems

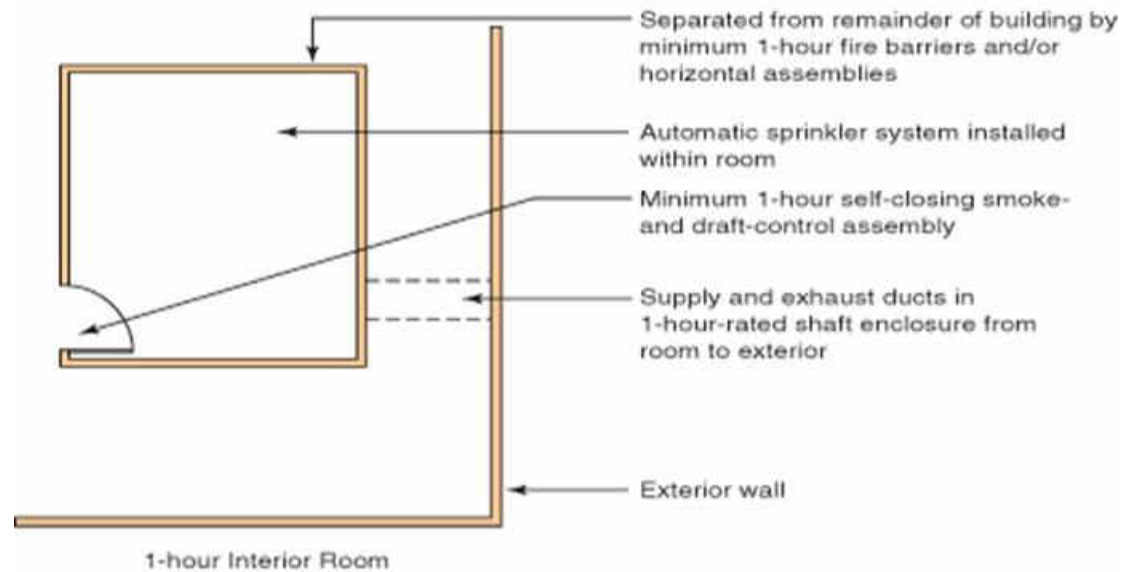
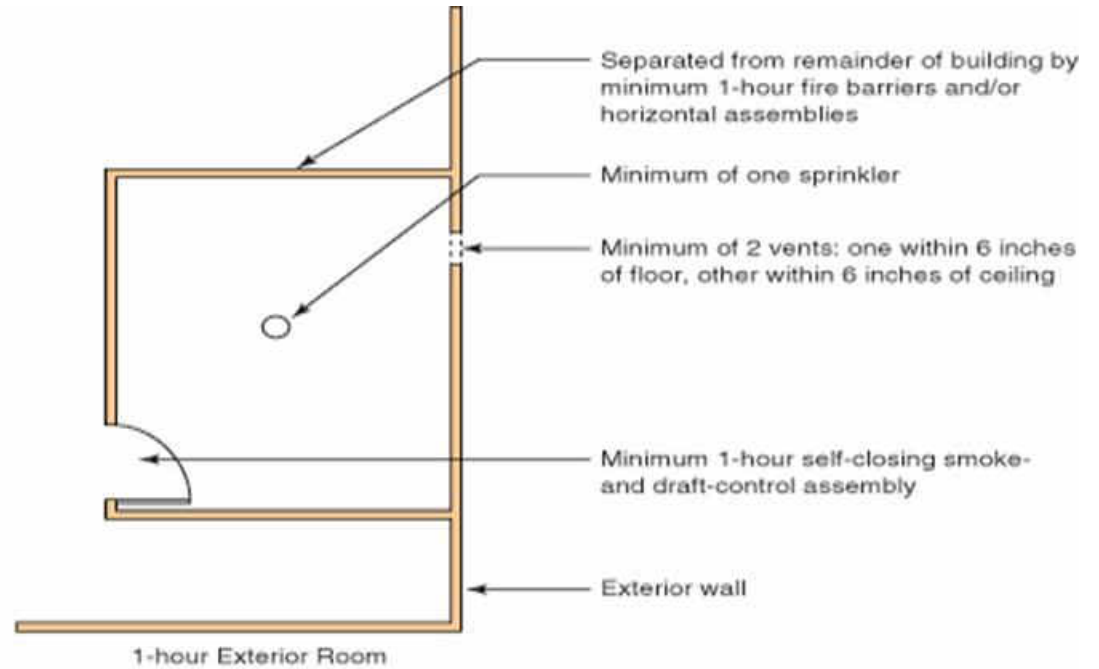



428 Higher Education Laboratories

- Special allowances and provisions for Group B laboratories in college and university buildings
- Similar to 'control area' concept



428 Higher Education Laboratories

TABLE 428.3 Design and Number of Laboratory Suites Per Floor

Floor Level		Percentage of the Maximum Allowable Quantity Per Lab Suite ^a	Number of Lab Suites Per Floor	Fire-Resistance Rating for Fire Barriers in Hours ^b
Above Grade Plane	211	Not allowed	Not Permitted	Not Permitted
	16-20	25	1	2 ^c
	11-15	50	1	2 ^c
	7-10	50	2	2 ^c
	4-6	75	4	1
	3	100	4	1
	1-2	100	6	1
Below Grade Plane	1	75	4	1
	2	50	2	1
	Lower than 2	Not Allowed	Not Allowed	Not Allowed

- a. Percentages shall be of the maximum allowable quantity per control area shown in Tables 307.1(1) and 307.1(2), with all increases allowed in the footnotes to those tables.
- b. Fire barriers shall include walls, floors and ceilings necessary to provide separation from other portions of the building.
- c. Vertical fire barriers separating laboratory suites from other spaces on the same floor shall be permitted to be 1-hour fire-resistance rated.





Chapter 5

Allowable Building Heights and Areas



503.1, 706.1 Scope of Fire Wall Use

- Use of fire wall to create separate buildings now limited to only the determination of permissible types of construction, based upon allowable building height and area
- Fire walls to continue to be used for horizontal exits, fire area separations, fire-flow calculations, etc.

Fire wall provided for creating separate buildings now solely for determination of allowable height and area (type of construction)

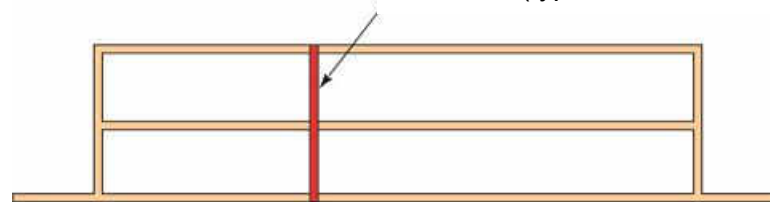



503.1.4 Allowable Height and Area of Occupied Roofs

- Allowable area and height of occupied roofs now addressed
 - Area not to be included in building area
 - Height (in stories) regulated based on uppermost story (unless exception applied)
- Enclosures of occupied roofs limited to 48 inches in height above roof deck, except for:
 - Penthouses, towers, spires, etc.



503.1.4 Allowable Height and Area of Occupied Roofs

Example:

If building of Type VA construction,

Group B: 4 stories max. (S)

Group A-3: 3 stories max. (S)

Notification appliances shall be provided per Section 907.5

A-3 on roof



Sprinkler system required throughout per Section 903.3.1.1



505.2.1.1 Mezzanine and Equipment Platform Area Limitations



Example:

Assume both an equipment platform and a mezzanine are located in the same 24,000 sq. ft. room.

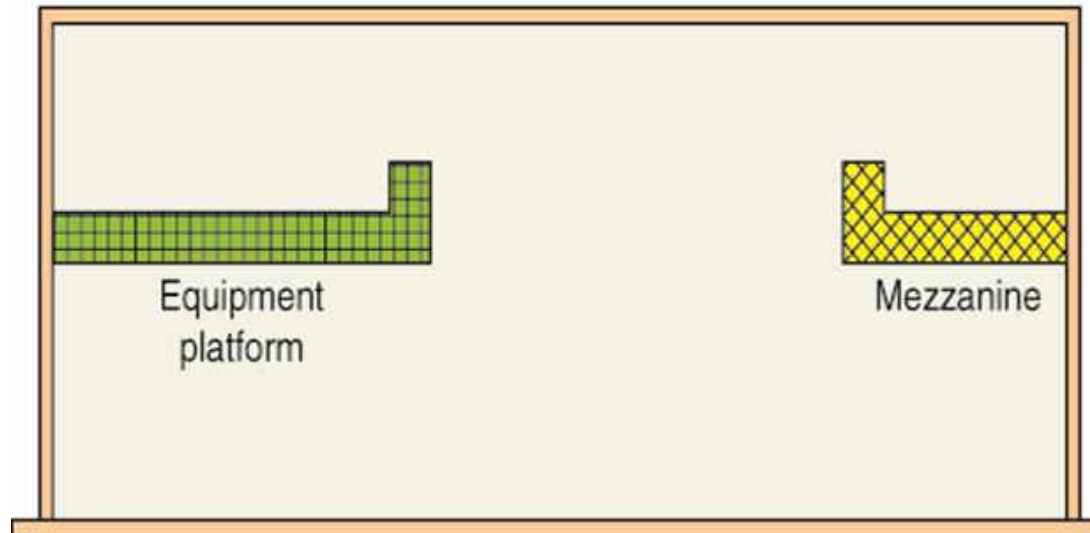

Permitted aggregate size of equipment platform and mezzanine limited to 16,000 sq. ft. (based on $\frac{2}{3}$ limitation)

Permitted size of mezzanine limited to 8,000 sq. ft. (based on $\frac{1}{3}$ limitation)



Table 506.2, Note i Allowable Area of Type VB Greenhouses



TABLE 506.2 Allowable Area Factor

Occupancy Classification	See Footnotes	Type I		Type II		Type III		Type IV	Type V	
		A	B	A	B	A	B	HT	A	B
U	NS ⁱ	UL	35,500	19,000	8,500	14,000	8,500	18,000	9,000	5,500
	S1	UL	142,000	76,000	34,000	56,000	34,000	72,000	36,000	22,000
	SM	UL	106,500	57,000	25,500	42,000	25,500	54,000	27,000	16,500

Note:

- i. The maximum allowable area for a single-story nonsprinklered Group U greenhouse is permitted to be 9,000 square feet, or the allowable area shall be permitted to comply with Table C102.1 of Appendix C.

(No changes to other portions of table and notes.)

Maximum allowable area increased to 9,000 sq. ft. (from 5,500 sq. ft.)

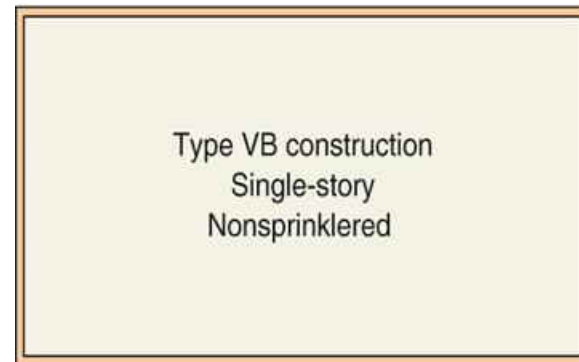

Group U Greenhouse





507.4 Sprinklers in Unlimited Area Group A-4 Buildings

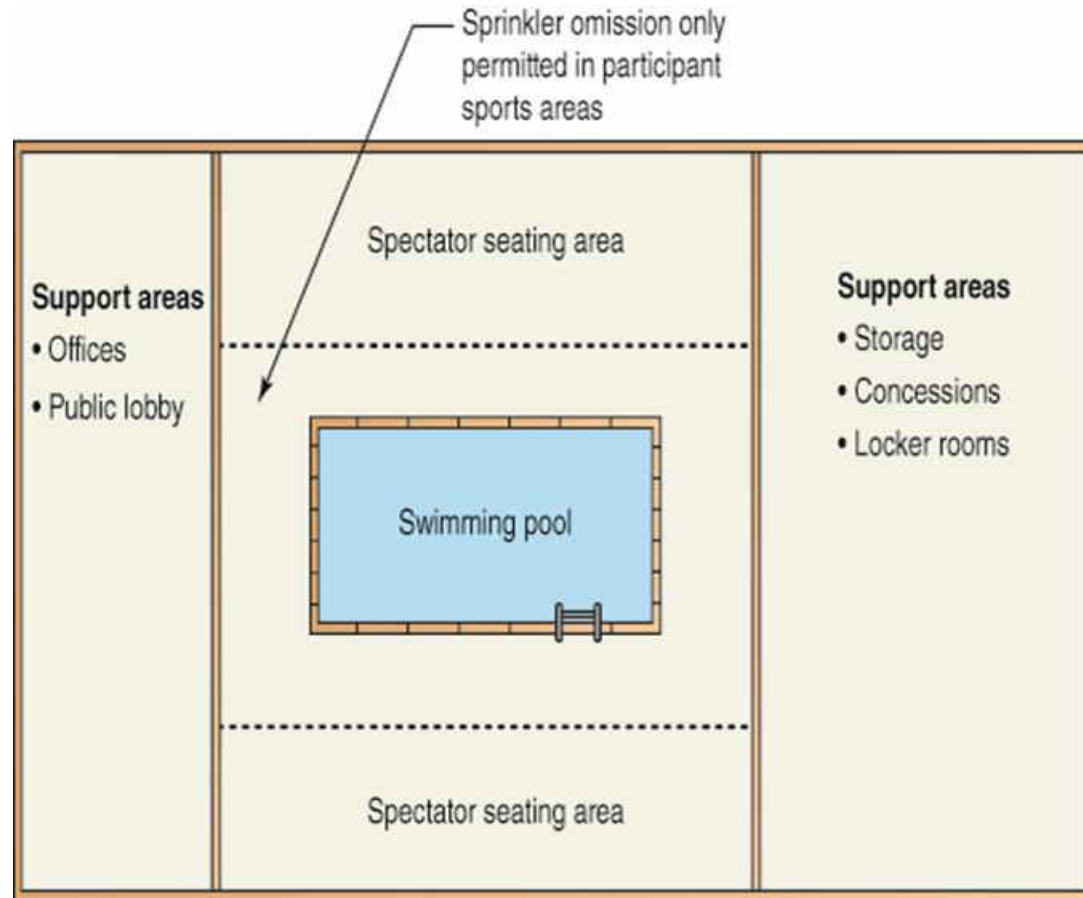

Unlimited Area Group A-4 Occupancy





508.3.1.2 Group I-2, Condition 2 Nonseparated Occupancies

- Where nonseparated occupancies method used in mixed-occupancy condition, applicable within fire area to most restrictive provisions of:
 - Sec. 407 Group I-2
 - Sec. 509 Incidental uses
 - Sec. 712 Vertical openings
- Most restrictive means of egress provisions to apply



508.3.1.2 Group I-2, Condition 2 Nonseparated Occupancies

Storage room >100 sq. ft. required to be separated minimum 1-hour per Table 509 if located in same fire area as Group I-2, Condition 2

Two-story opening per Section 712.9 *not* permitted in Group B if located in same fire area as Group I-2, Condition 2

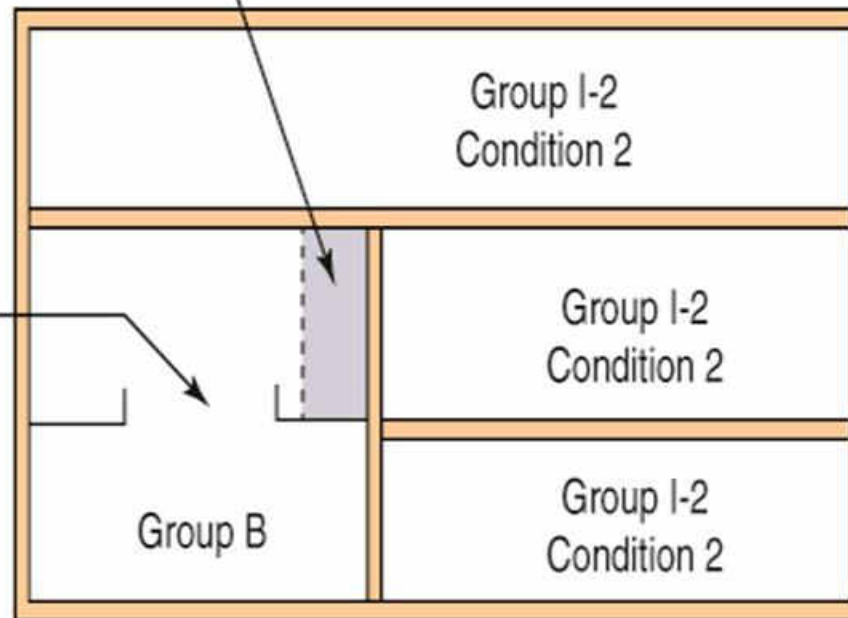

Regulated as Nonseparated Occupancies





508.4.1, Table 508.4 Separated Occupancies vs. Fire Area Separations

Examples: Nonsprinklered mixed occupancy buildings regulated under separated occupancy provisions of Section 508.4

No sprinkler system

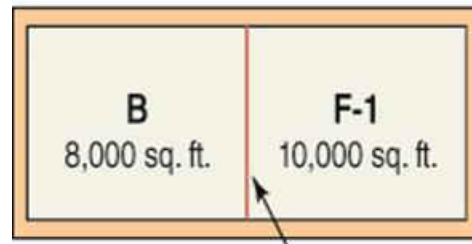

Minimum 3-hour fire barrier required

- Occupancy separation not required per separated occupancies and Table 508.4.
- Fire area separation of 3 hours required by Section 903.2.4 and Table 707.3.10.

No sprinkler system

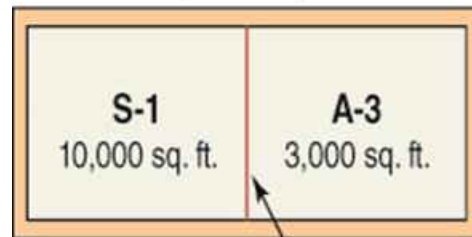

Minimum 3-hour fire barrier required

- Occupancy separation of 2 hours required per separated occupancies and Table 508.4.
- Fire area separation of 3 hours required by Sections 903.2.1.3 and 903.2.9 and Table 707.3.10.





Table 509 Incidental Uses

- Limits of stationary storage battery systems now based on energy capacities set forth in IFC
- Reference now made to specific sections in NEC for protection and separation of electrical installations and transformers



Table 509 Incidental Uses

TABLE 509 Incidental Uses

Room or Area	Separation and/or Protection
<p>Stationary storage battery systems having a liquid electrolyte capacity of more than 50 gallons for flooded lead-acid, nickel cadmium or VRLA, or more than 1,000 pounds for lithium-ion and lithium metal polymer <u>an energy capacity greater than the threshold quantity specified in Table 1206.2 of the <i>International Fire Code</i></u></p>	<p>1 hour in Group B, F, M, S and U occupancies; 2 hours in Group A, E, I and R occupancies</p>
<p><u>Electrical installations and transformers</u></p>	<p><u>See Sections 110.26 through 110.34 and Sections 450.8 through 450.48 of NFPA 70 for protection and separation requirements</u></p>

(No changes to other portions of Table 509.)





510.2 Horizontal Building Separation

- Vertical offsets permitted where offset and supporting structure rated at least 3 hours

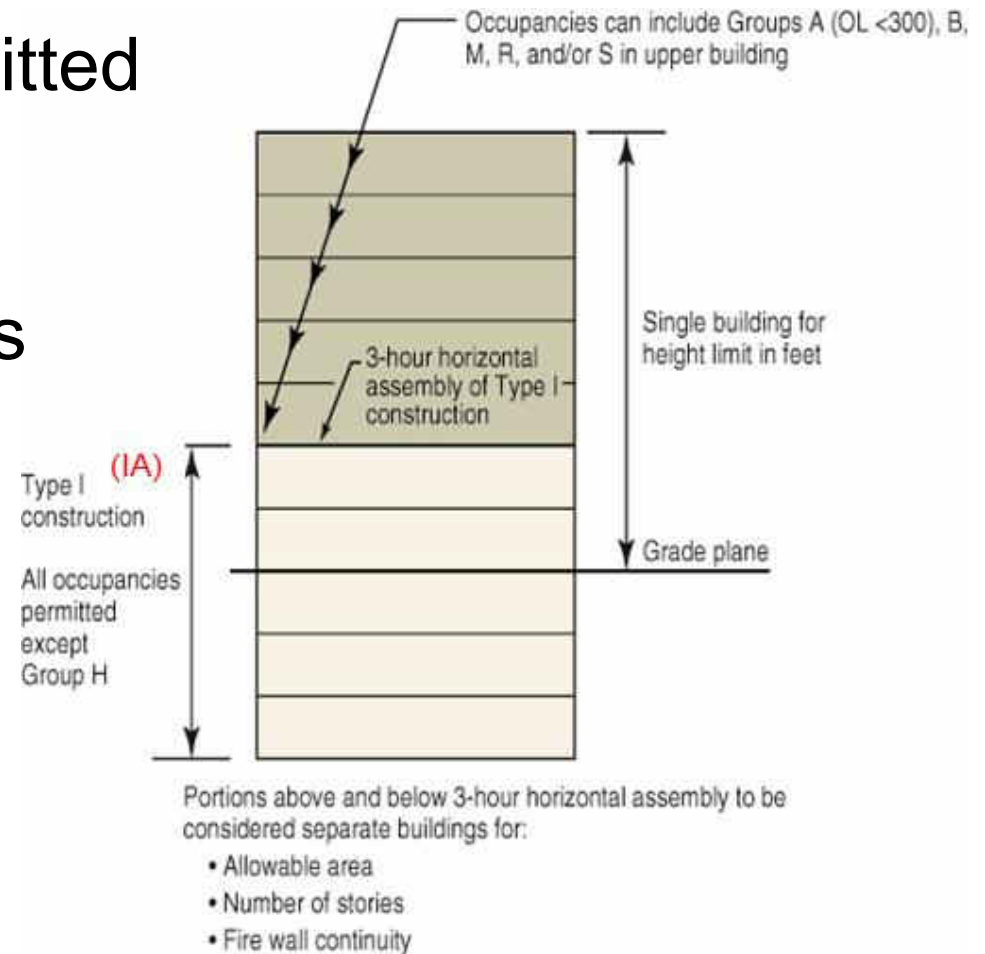



Chapter 6

Types of Construction



Table 601 Fire Protection of Structural Roof Members

TABLE 601 Fire-Resistance Rating Requirements for Building Elements

Building Element	Type I		Type II		Type III		Type IV	Type V	
	A	B	A	B	A	B	HT	A	B
Primary structural frame ^f	3 ^{a,b}	2 ^{a,b}	1 ^b	0	1 ^b	0	HT	1 ^b	0
Roof construction and associated secondary members	1½ ^b	1 ^{b,c}	1 ^{b,c}	0 ^c	1 ^{b,c}	0	HT	1 ^{b,c}	0

b. Except in Group F-1, H, M and S-1 occupancies, fire protection of structural members in roof construction shall not be required, including protection of primary structural frame members, roof framing and decking where every part of the roof construction is 20 feet or more above any floor immediately below. Fire-retardant-treated wood members shall be allowed to be used for such unprotected members.

(No changes to other portions of Table 601 and notes.)



Table 601 Fire Protection of Structural Roof Members

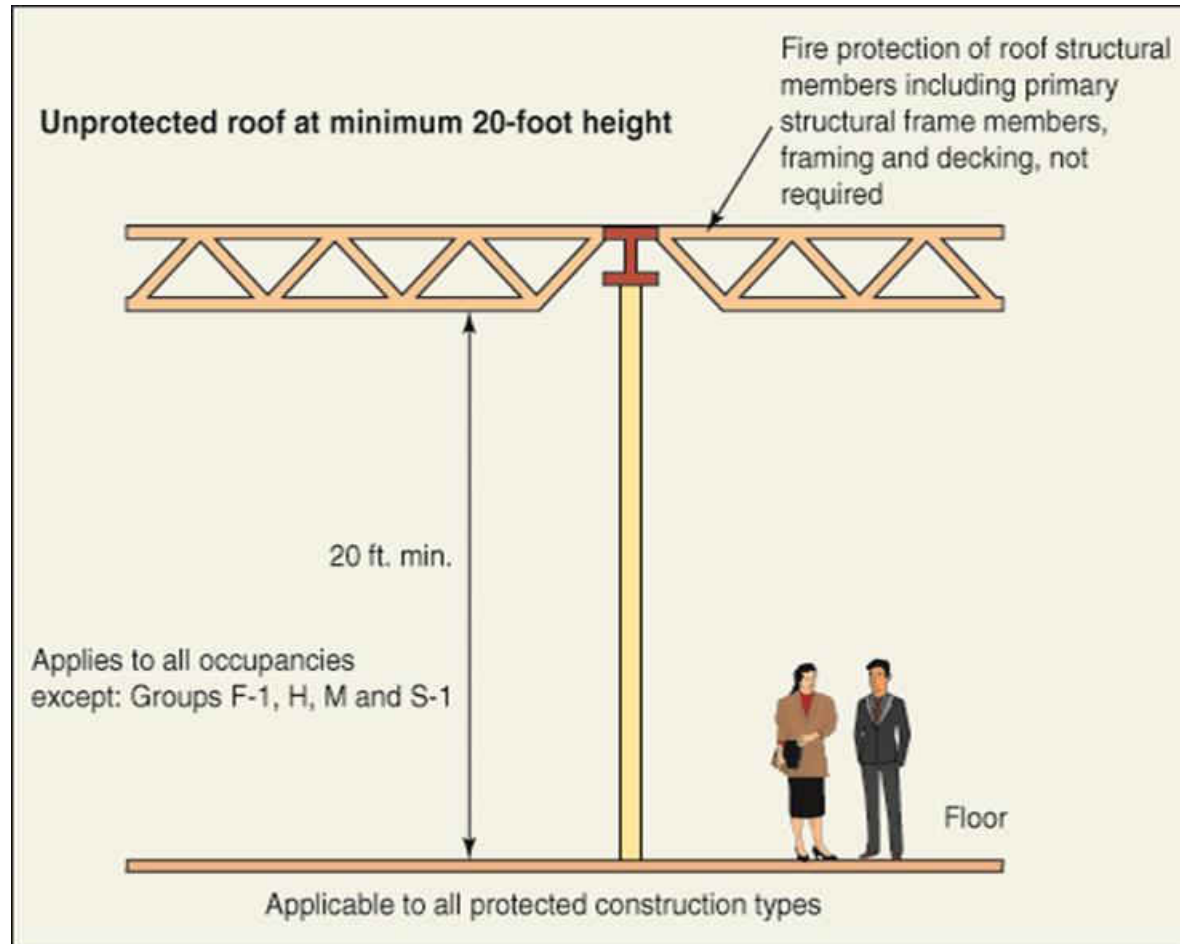



Table 602, Note i Group R-3 Fire Separation Distance

TABLE 602 Fire-Resistance Rating Requirements for Exterior Walls Based on Fire Separation Distance

Fire Separation Distance	Type of Construction	Occupancy Group H	Occupancy Group F-1, M, S-1	Occupancy Group A, B, E, F-2, I, R ⁱ , S-2, U
$X < 5$	All	3	2	1
$5 \leq X < 10$	IA	3	2	1
	Others	2	1	1
$10 \leq X < 30$	IA, IB	2	1	1
	IIB, VB	1	0	0
	Others	1	1	1
$X \geq 30$	All	0	0	0

i. For a Group R-3 building of Type IIB or Type VB construction, the exterior wall shall not be required to have a fire-resistance rating where the fire separation distance is 5 feet (1523 mm) or greater.

(No changes to other portions of Table 602 and notes.)



Table 602, Note i Group R-3 Fire Separation Distance

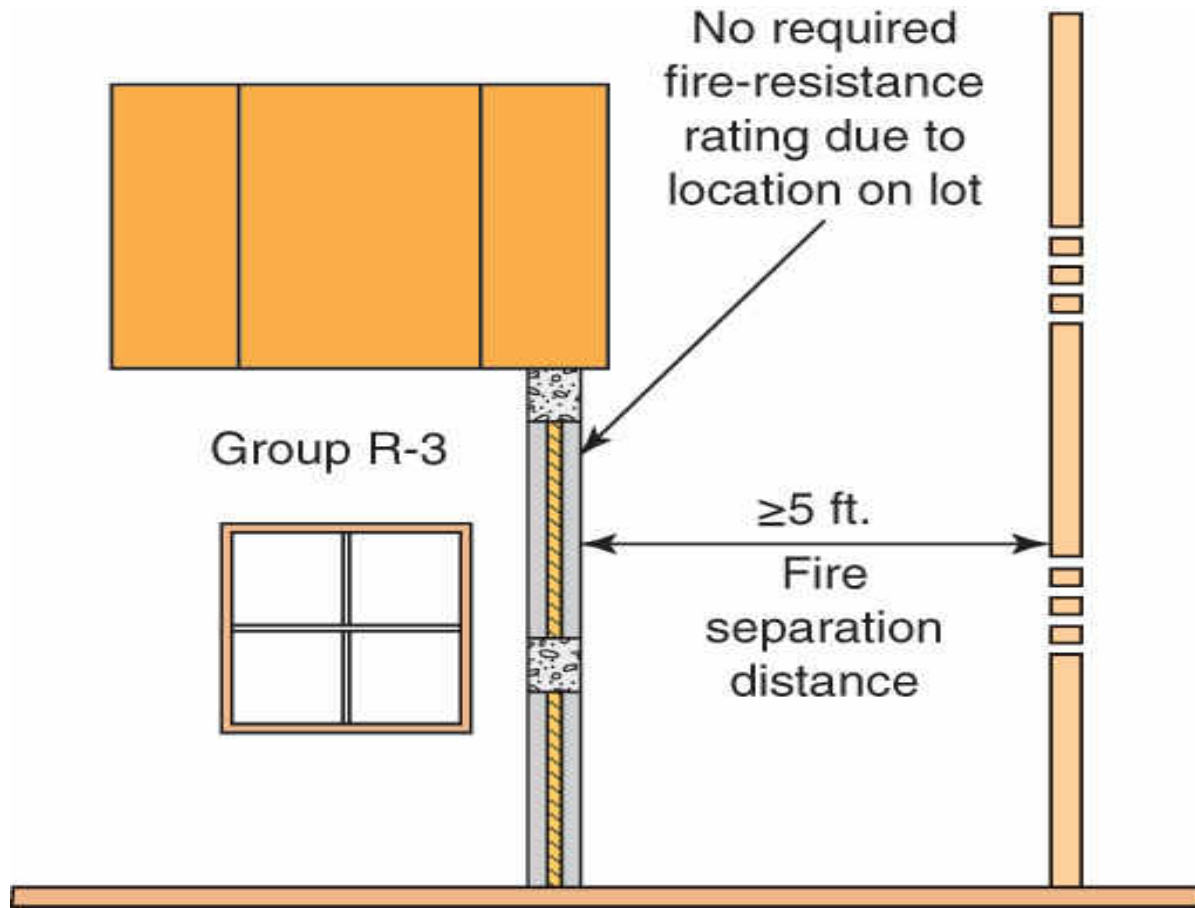

602.3, 602.4.1 FRT Wood Sheathing in Exterior Wall Assemblies



- Fire-retardant-treated wood framing and sheathing permitted within exterior walls of Type III and IV construction
 - Minimum of 6 inches in thickness
 - 2-hour rating or less





Chapter 7

Fire and Smoke Protection Features



704.2, 704.4.1 Column Protection in Light-Frame Construction

- Required fire-resistance rating permitted to be provided with membrane protection

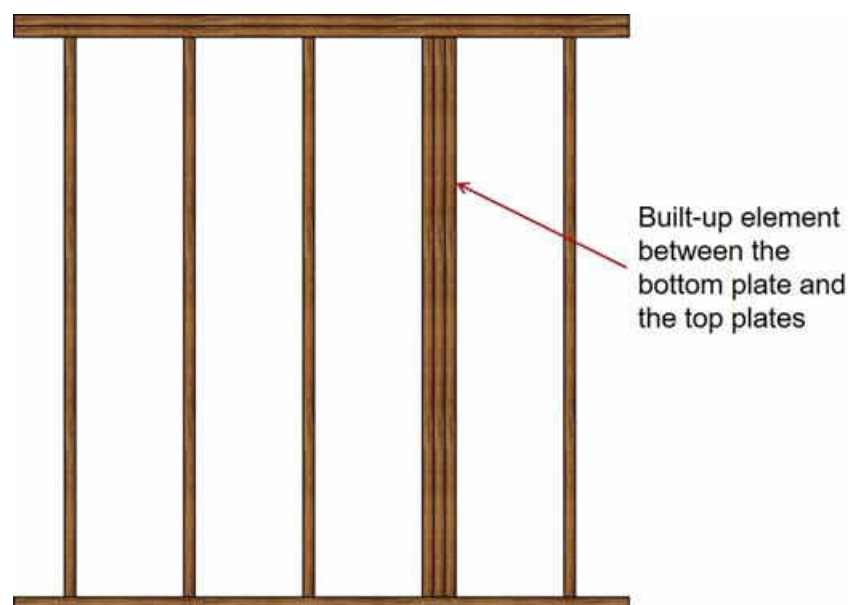



Table 705.2 Extent of Projections

- Minimum clearance measured to line used to determine fire separation distance has been revised to be consistent with 2012 IBC

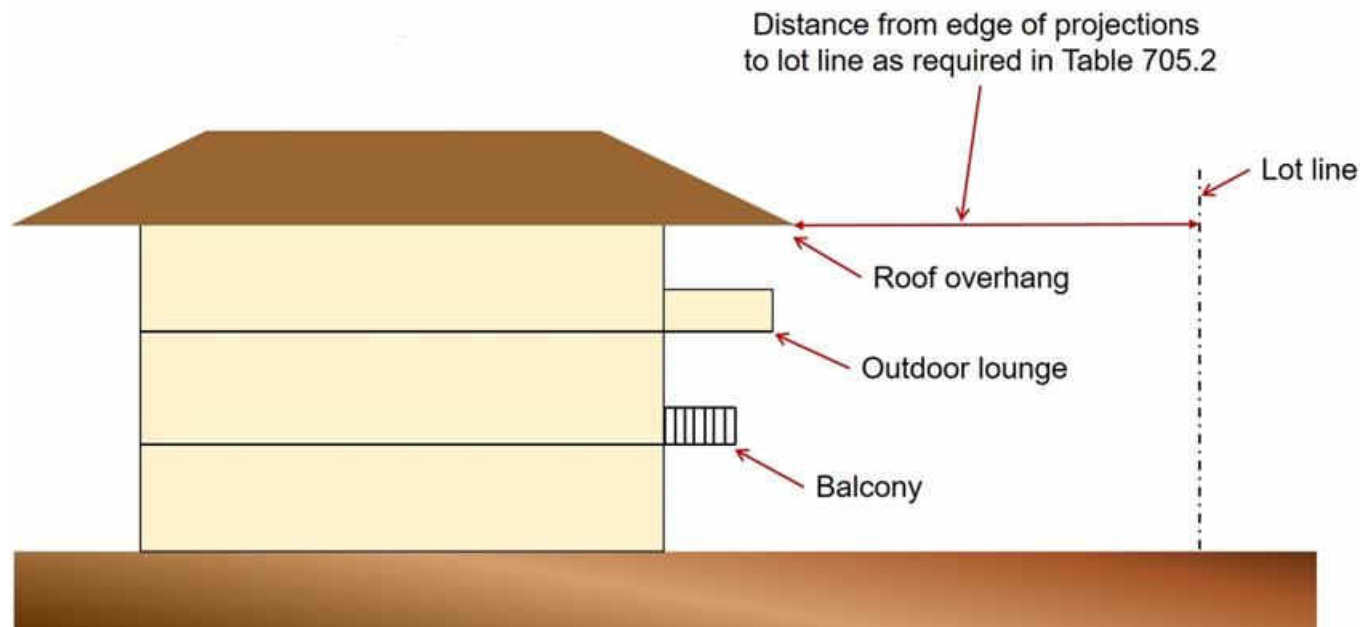

Table 705.2 Extent of Projections

TABLE 705.2 Minimum Distance of Projection

Fire Separation Distance – <u>FSD</u> (feet)	Minimum Distance from Line Used to Determine FSD
0 feet to <u>less than</u> 2 feet	Projections not permitted
Greater than 2 feet to <u>less than</u> 3 feet	24 inches
Greater than 3 feet to less than <u>5</u> feet	24 inches plus 8 inches for every foot of FSD beyond 3 feet or fraction thereof
30 feet <u>5</u> or greater	20 feet <u>40 inches</u>

For SI: 1 foot = 304.8 mm; 1 inch = 25.4 mm.



705.2.3, 705.2.3.1, 705.2.4 Combustible Balconies, Projections, and Bay Windows



- Provisions relocated from Section 1406 (Combustible Materials on the Exterior Side of Exterior Walls)
- Plastic composites now permitted to be installed in guard components where untreated wood allowed





705.8.1 Measurement of Fire Separation Distance for Opening Protection

- Where addressing allowable area of exterior openings, fire separation distance to be measured in same manner as when determining exterior wall rating
- Fire separation distance is measured on a story-by-story basis

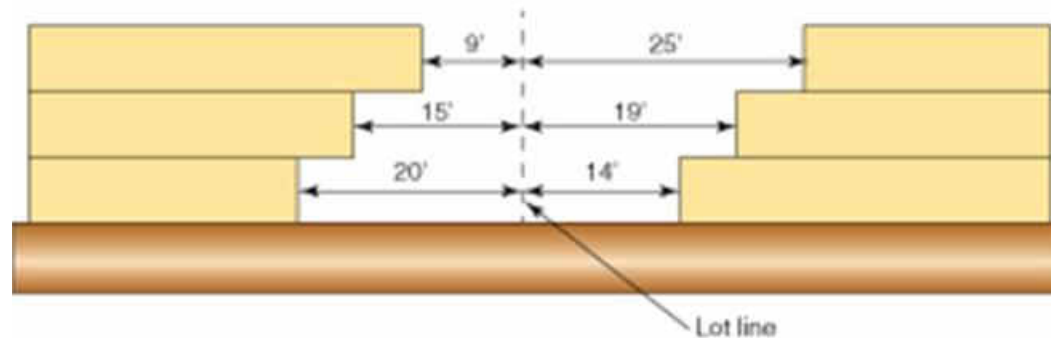



706.1.1 Party Walls Not Constructed as Fire Walls

- Fire walls not required on lot lines dividing a building for ownership purposes where:
 - Aggregate height and area do not exceed maximum requirements
 - Dedicated access easements and contractual agreements are provide to allow access for purposes of maintaining fire and life safety systems necessary for building operation
 - Subject to review and approval by building official



706.1.1 Party Walls Not Constructed as Fire Walls

Example:

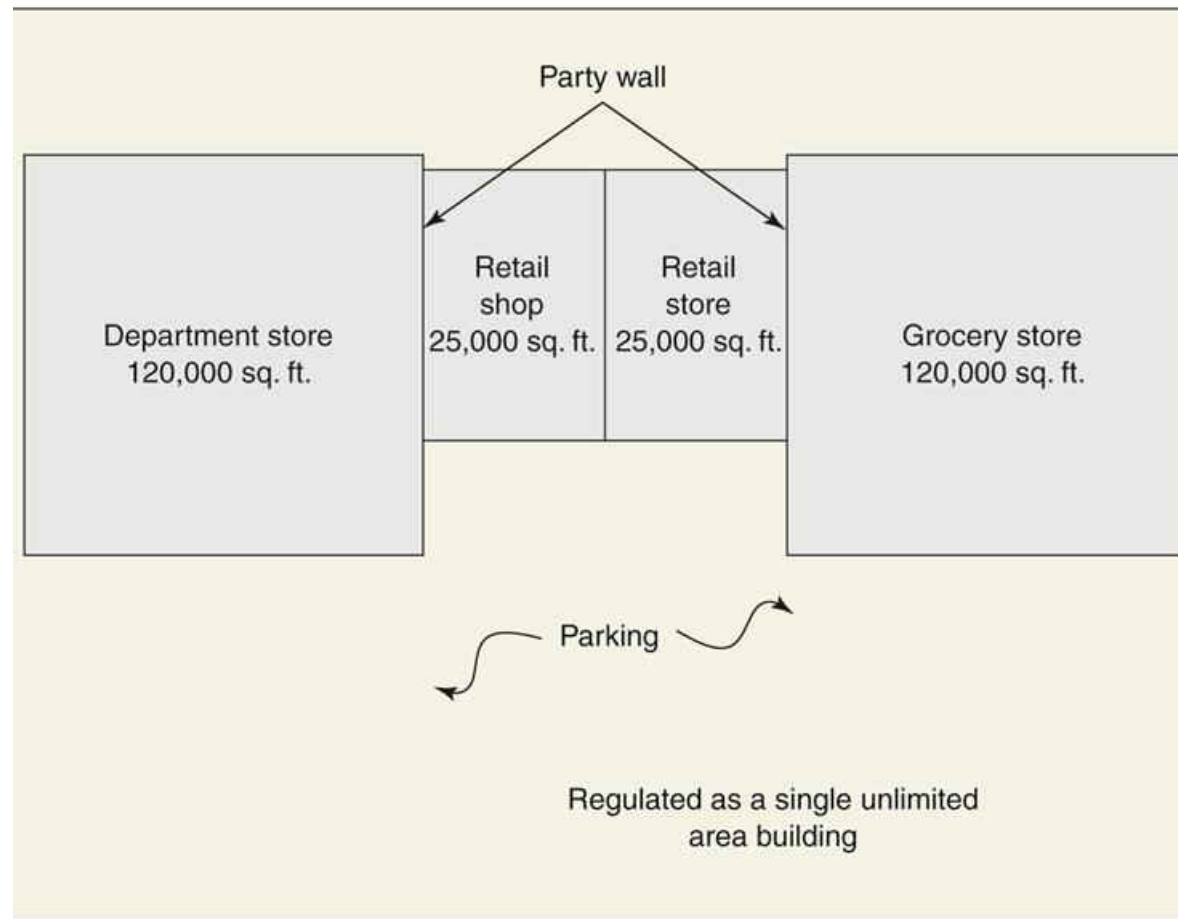



706.2 Structural Continuity of Double Fire Walls

- Applicable only in SDCs D, E and F
- Allows for continuous diaphragm for floor and/or roof assembly
- Also stabilizes double fire walls to resist impact during seismic event

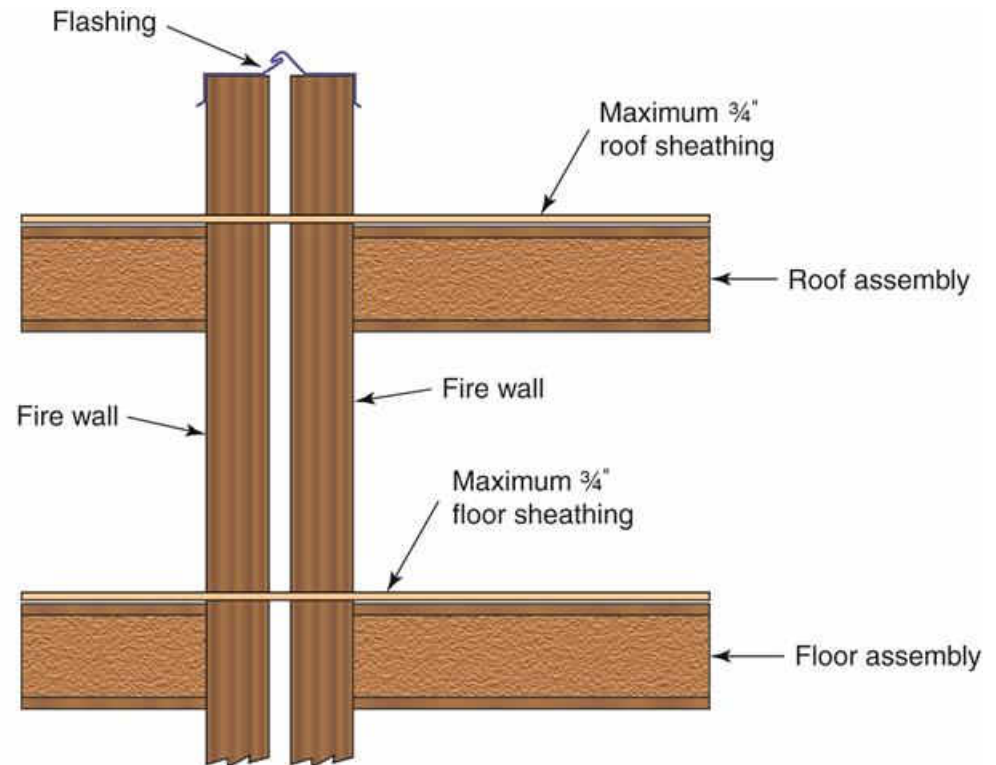



708.4 Continuity of Fire Partitions

- Reformatted into 3 distinct areas:
 - Continuity in regard to enclosure limits
 - Supporting construction components
 - Fireblocking and draftstopping

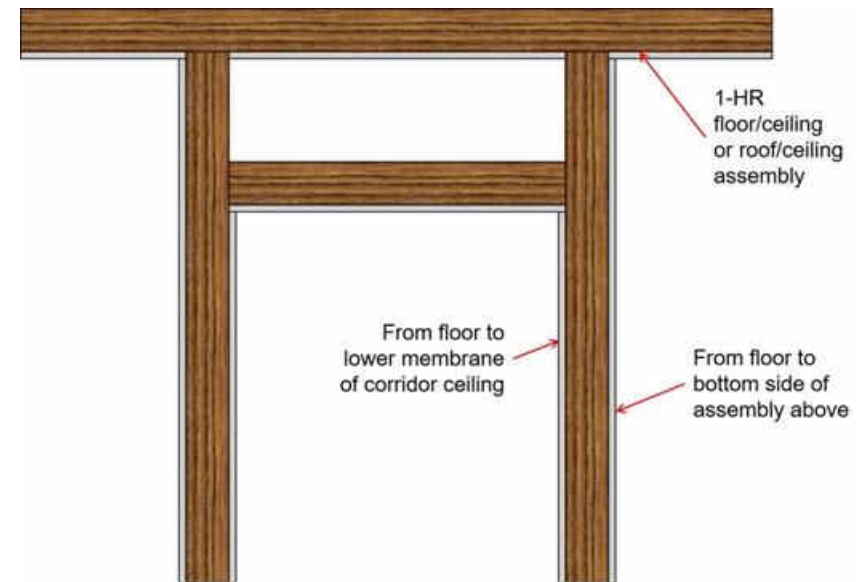

708.4 Continuity of Fire Partitions

- Additional enclosure continuity method for corridor walls that do not extend above lower membrane of corridor ceiling:
 - Applicable to sprinklered buildings where sprinklers installed in concealed space

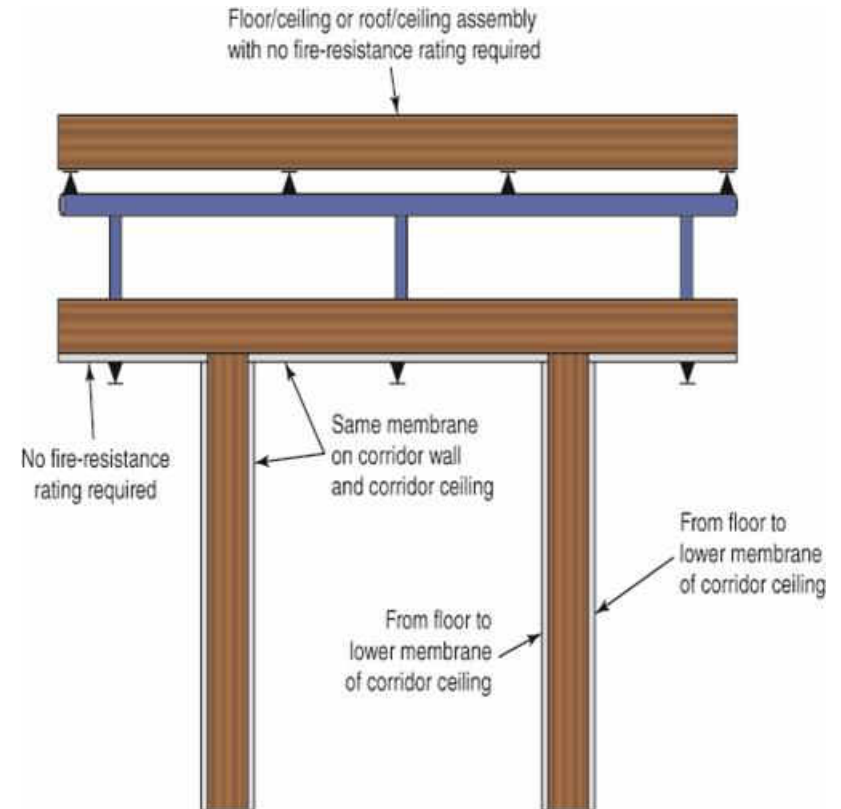



708.4.2 Fireblocking and Draftstopping at Fire Partitions

- General reorganization and consolidation effort
- Now only applicable in Group R-2 with four or more dwelling units and Group R-3 with more than two dwelling units

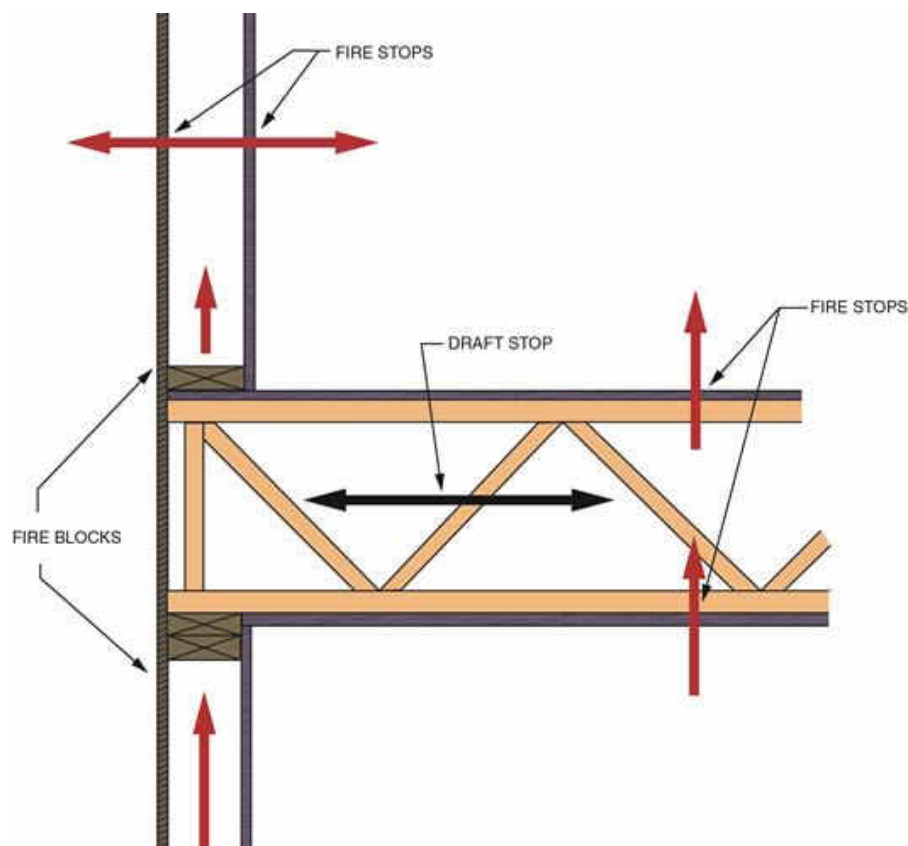



708.4.2 Fireblocking and Draftstopping at Fire Partitions

- Clarifies that where building has NFPA 13R sprinkler system, attic protection to be based on NFPA 13 system in order to eliminate required fireblocking/draftstopping

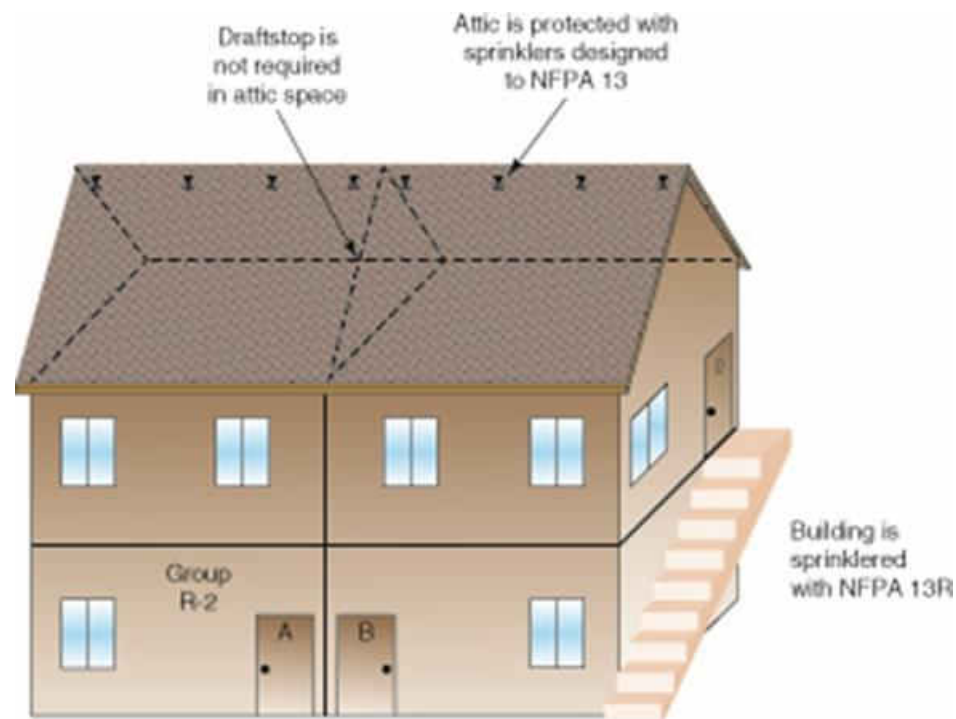

713.8.1 Membrane Penetrations of Shaft Enclosures



- Consistent with allowance for interior exit stairway membrane penetrations when protected per Section 714.4.2

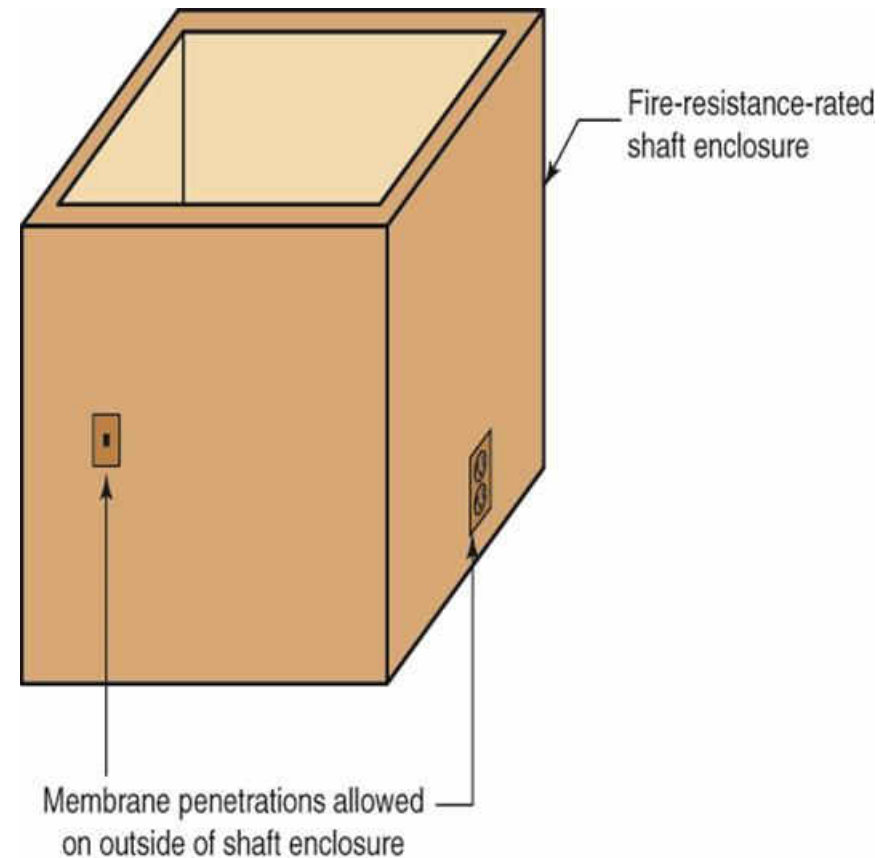



716.2.6.5 Delayed-Action Self-Closing Doors

- Delay-action closers permitted where automatic-closing not required
- Defined as mechanical devices with an adjustable delay
- Time delay not specifically addressed

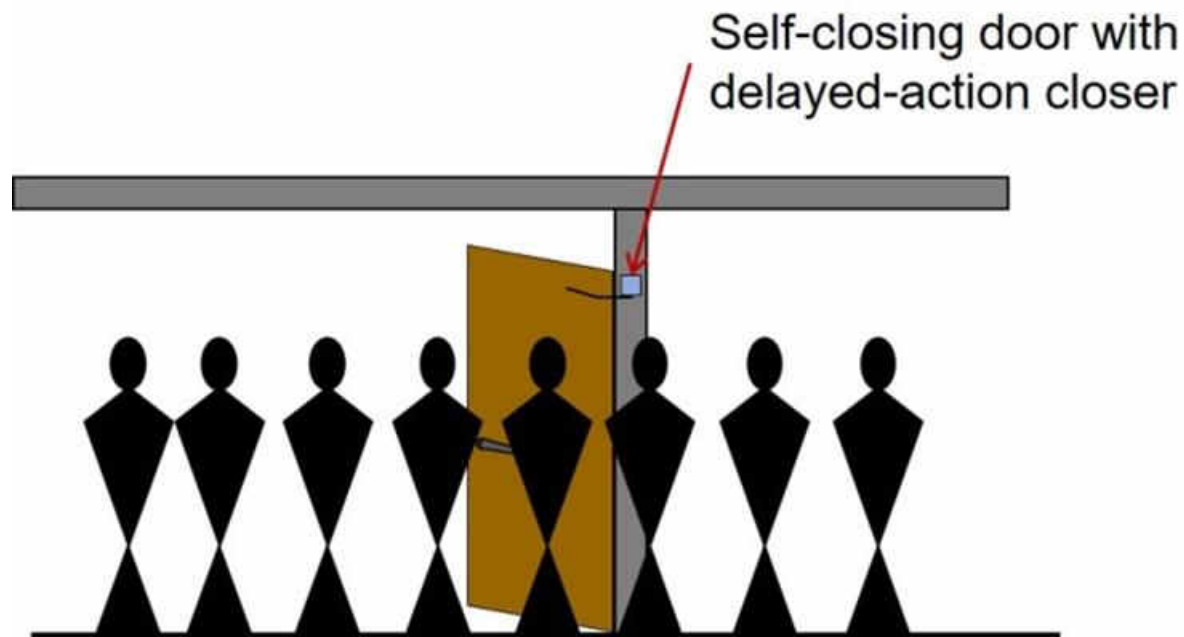



Chapter 8

Interior Finishes



803.1.1, 803.1.2 Interior Wall and Ceiling Finish Testing

- Criteria reorganized by:
 - Initially addressing allowance for compliance with NFPA 286 for all applications
 - Followed by testing under ASTM E84 and UL 723
 - Then other methods identified for special conditions such as textile coverings



803.3 Interior Finish Requirements for Heavy Timber Members



- Now applicable to interior exit stairways, interior exit ramps and exit passageways

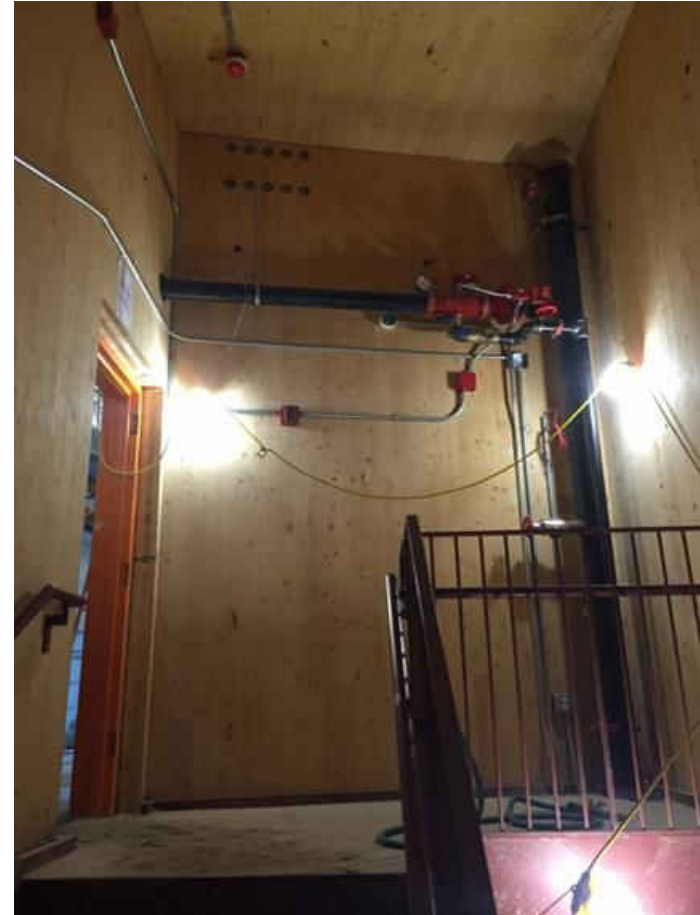



803.12 Flame Spread Testing of Laminates and Veneers

- Addresses flame spread testing for:
 - Factory-produced laminated products over a wood substrate
 - Facings and wood veneers applied over a wood substrate on site





Chapter 9

Fire Protection Systems



901.6.2 Integrated Fire Protection System Testing

- Where two or more fire protection or life safety systems are interconnected, the acceptance process and testing must evaluate all systems as a whole
- Reference is made to NFPA 4
- Integrated testing required for:
 - High-rise buildings
 - Smoke control systems

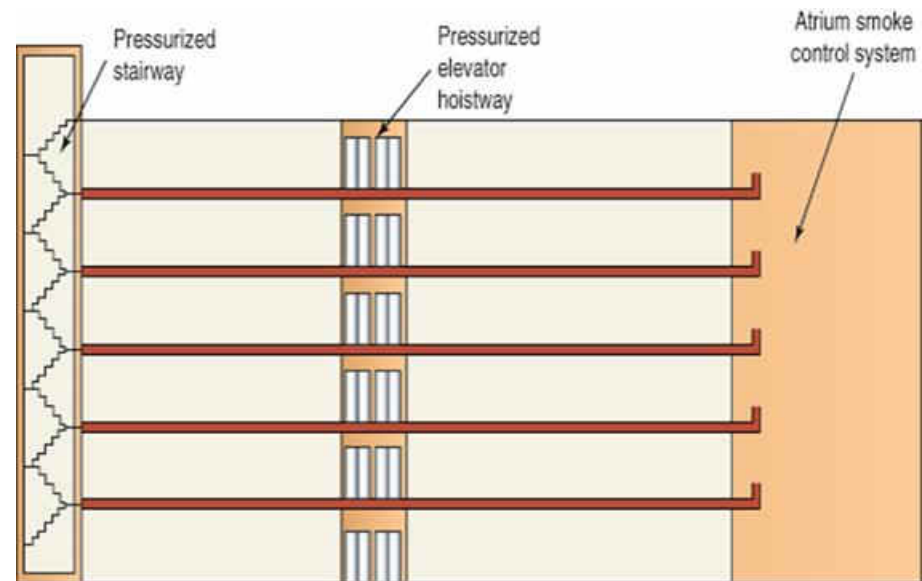

902.8 Fire Pump and Fire Sprinkler Riser Rooms



- Prescriptive provisions added for:
 - Access
 - Marking on access doors
 - Environment
 - Lighting





903.2.1 Sprinklers Required in Group A Occupancies

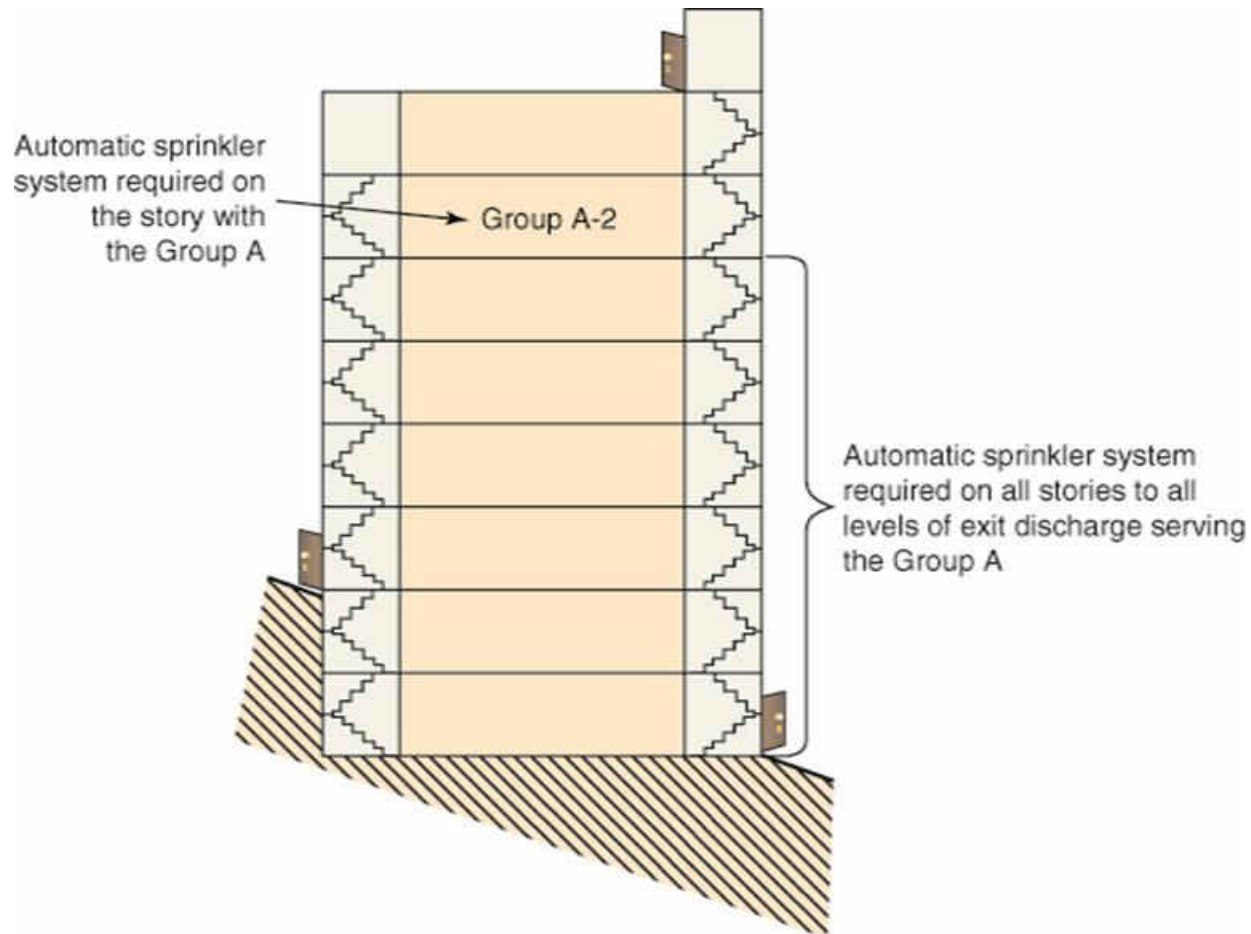



903.2.3 Sprinklers in Group E Occupancies

- Sprinkler protection now also required for Group E fire areas where fire area:
 - Located on a floor other than the level of exit discharge, or
 - Has an occupant load of 300 or more



903.3.1.1.2 Omission of Sprinklers in Group R-4 Bathrooms



- Group R-4 now included with other residential occupancies where sprinkler protection not required in small bathrooms

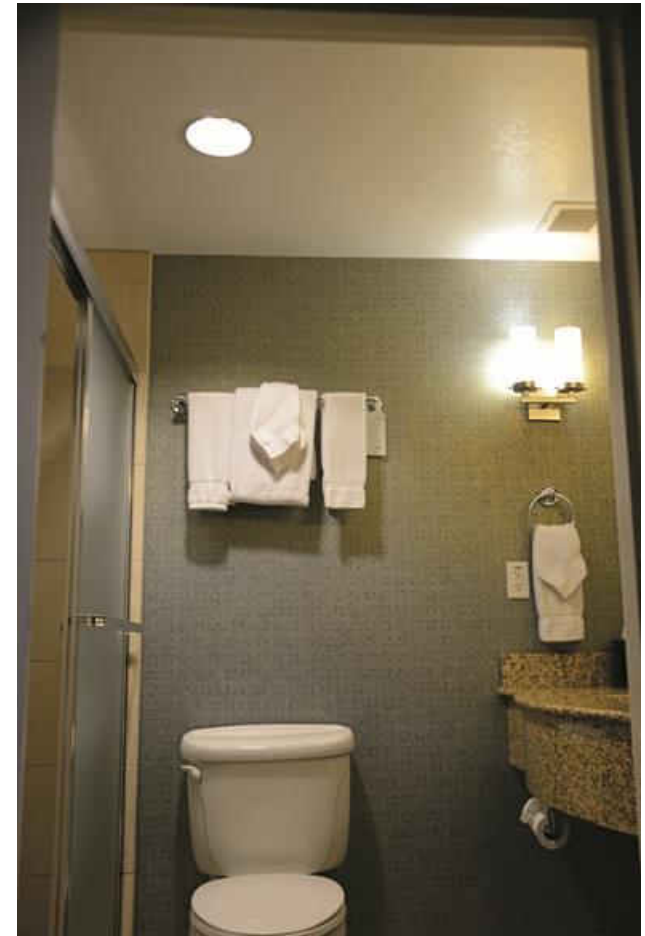



903.3.1.2.1 Sprinkler Protection at Balconies and Decks

- Allowance previously in Section 1406.3 for extension of sprinkler protection to exterior balconies in order to be of nonrated Type V construction has been relocated

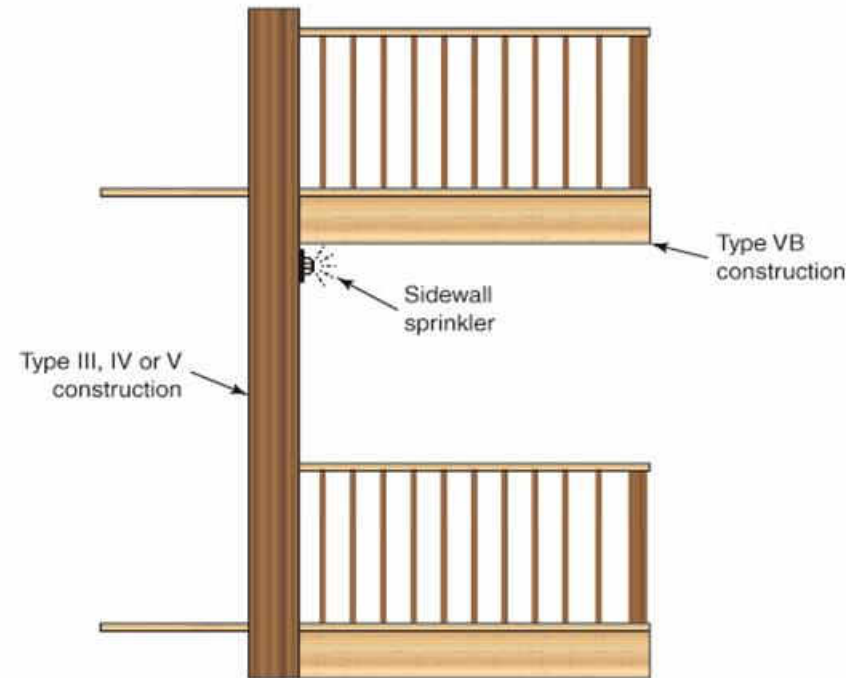



903.3.1.2.3 Protection of Attics in Group R Occupancies

- Additional sprinkler protection or acceptable alternative methods now required for attics in multi-family occupancies equipped with an NFPA 13R system
- Applicable where roof assembly more than 55 feet above LLFDA
- Method of determining height of roof assembly established as greatest of:
 - Eave of highest pitched roof
 - Intersection of highest roof to exterior wall
 - Top of highest parapet



903.3.1.2.3 Protection of Attics in Group R Occupancies

- Methods of protection include:
 - Provide sprinkler protection
 - Construct attic of noncombustible materials
 - Construct attic of FRT wood
 - Fill attic with noncombustible insulation





904.12 Commercial Cooking Operations

- Automatic fire-extinguishing system for commercial cooking systems to now be installed in accordance with NFPA 96
- Where automatic water mist systems are used, they shall comply with NFPA 750



904.13 Domestic Cooking Protection in Institutional and Residential Occupancies



- Automatic fire-extinguishing system now required at required hood over any domestic cooktop or range in:
 - Group I-1 occupancies
 - Group R-2 college dormitories
- Previously only required in Group I-2, Condition 1 occupancies



904.14 Aerosol Fire Extinguishing Systems



- IFC and NFPA 2010 now referenced for installation, inspection, testing and maintenance of aerosol fire-extinguishing systems
- Previously recognized in ICC-ES Acceptance Criteria and resulting evaluation report





905.3.1 Class III Standpipes

- Class III standpipe system required where four or more stories above or below grade plane
- Class I standpipes now allowed:
 - In Group B occupancies
 - In Group E occupancies
 - Where occupant-use hose lines will not be utilized by trained personnel or fire department



905.4 Class I Standpipe Connection Locations



- Single hose connection permitted in open corridor or open breezeway between open stairs

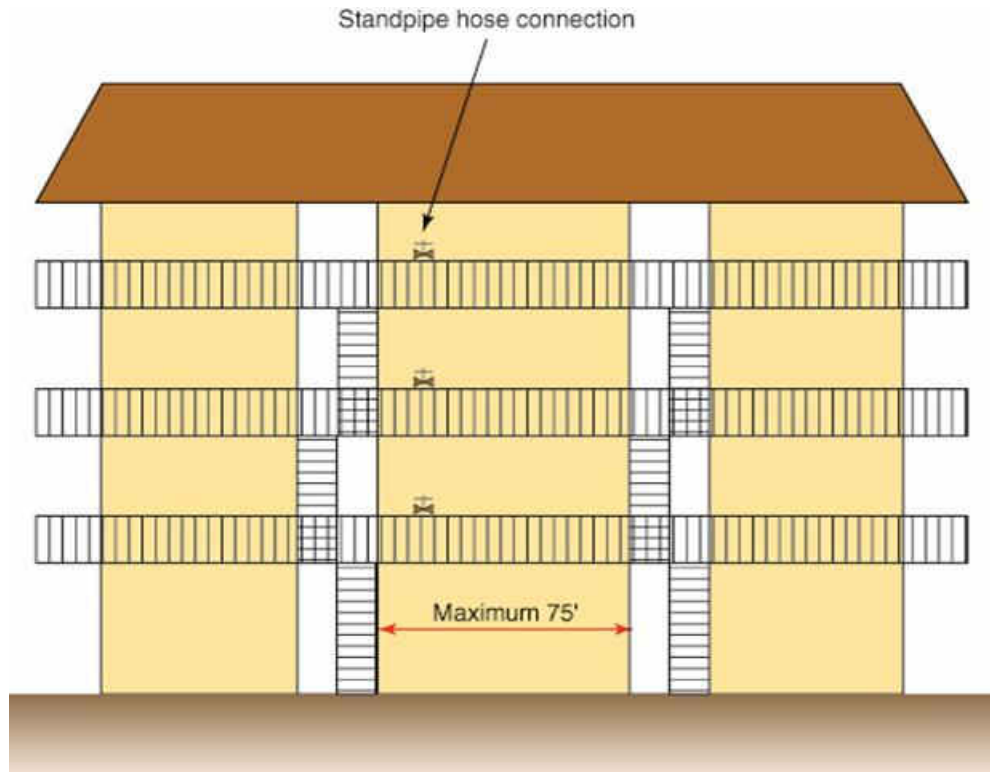



907.2.1 Fire Alarms in Group A Occupancies

- Manual fire alarm system required where Group A occupant load exceeds 100 above or below the lowest level of exit discharge

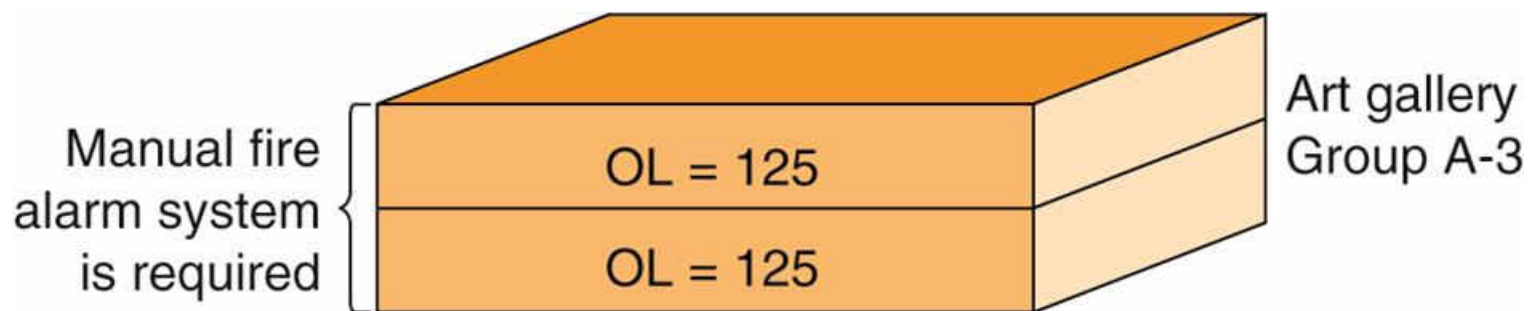

907.2.10 Group R-4 Fire Alarm Systems



- Installation of manual fire alarm system and automatic smoke detection system no longer required in Group R-4 occupancies





Chapter 10

Means of Egress

Table 1004.5, 1004.8 Occupant Load Calculation in Business Use Areas

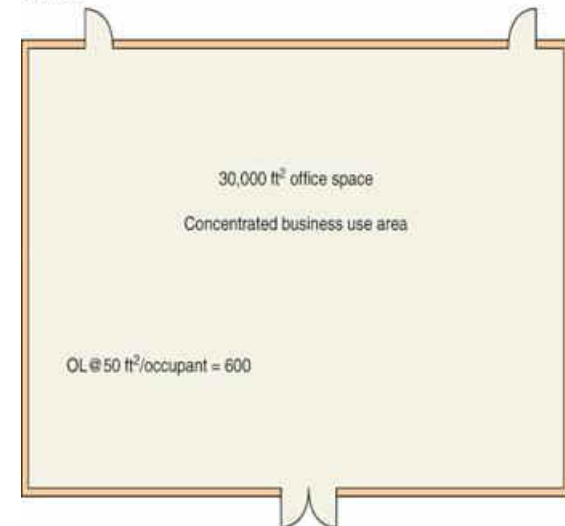

TABLE 1004.1.2 1004.5 Maximum Floor Area Allowances
Per Occupant

Function of Space	Occupant Load Factor ^a
Business areas	100/150 gross
<u>Concentrated business use areas</u>	<u>See Section 1004.8</u>

(No changes to other portions of table.)

Example:





1006.2.1, Table 1006.2.1 Group R Spaces with One Exit or Exit Access Doorway

- Single exit Group R-4 spaces now allow for a maximum occupant load of 20

TABLE 1006.2.1 Spaces With One Exit or Exit Access Doorway

Occupancy	Maximum Occupant Load of Space	Maximum Common Path of Egress Travel Distance (feet)		
		Without Sprinkler System (feet)		With Sprinkler System (feet)
		Occupant Load		
		OL ≤ 30	OL > 30	
R-2	10 <u>20</u>	NP	NP	125 ^a
R-3 ^e	10 <u>20</u>	NP	NP	125 ^{a,d}
R-4 ^e	10 <u>20</u>	75 <u>NP</u>	75 <u>NP</u>	125 ^{a,d}

(Portions of table not shown are unchanged.)

a. No change

b. No change

c. No change

d. No change

e. The length of common path of egress travel distance shall only apply in a Group R-3 occupancy located in a mixed occupancy building.

f. No change

g. For the travel distance limitations in Groups R-3 and R-4 equipped throughout with an automatic sprinkler system in accordance with Section 903.3.1.3, see Section 1006.2.2.6.



1006.2.1, Table 1006.2.1 Group R Spaces with One Exit or Exit Access Doorway

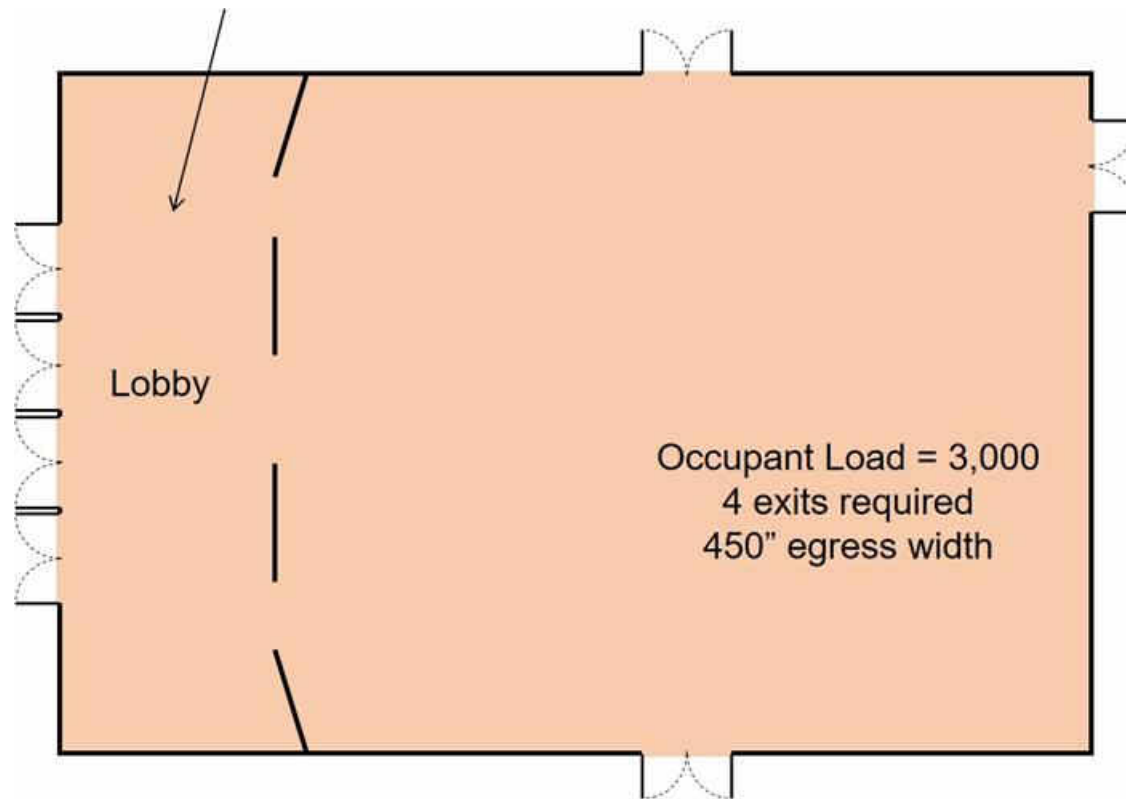



1006.3 Egress Through Adjacent Stories

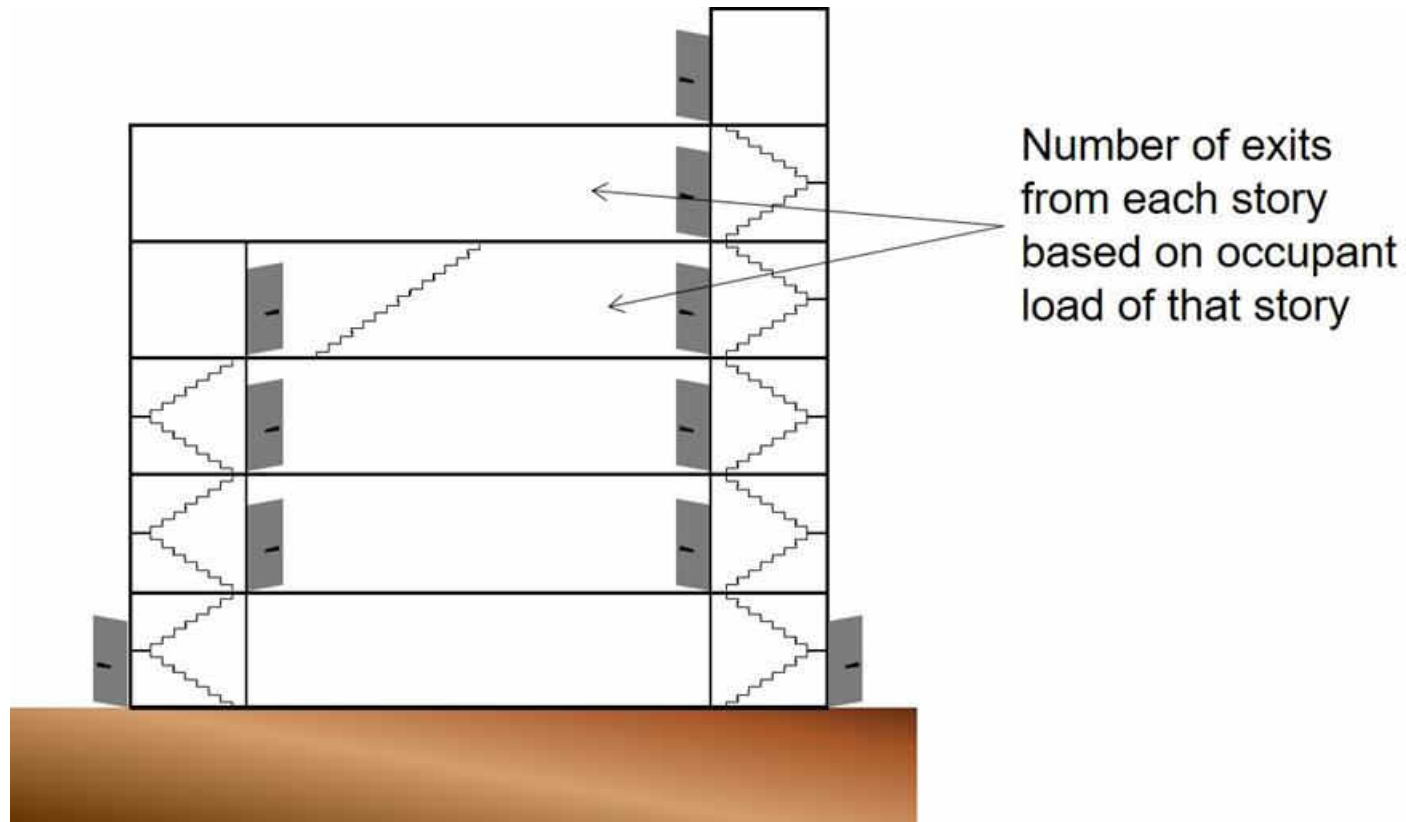



1008.2.3 Illumination of the Exit Discharge

- Where safe dispersal area is utilized, illumination required along exit discharge path as well as in dispersal area

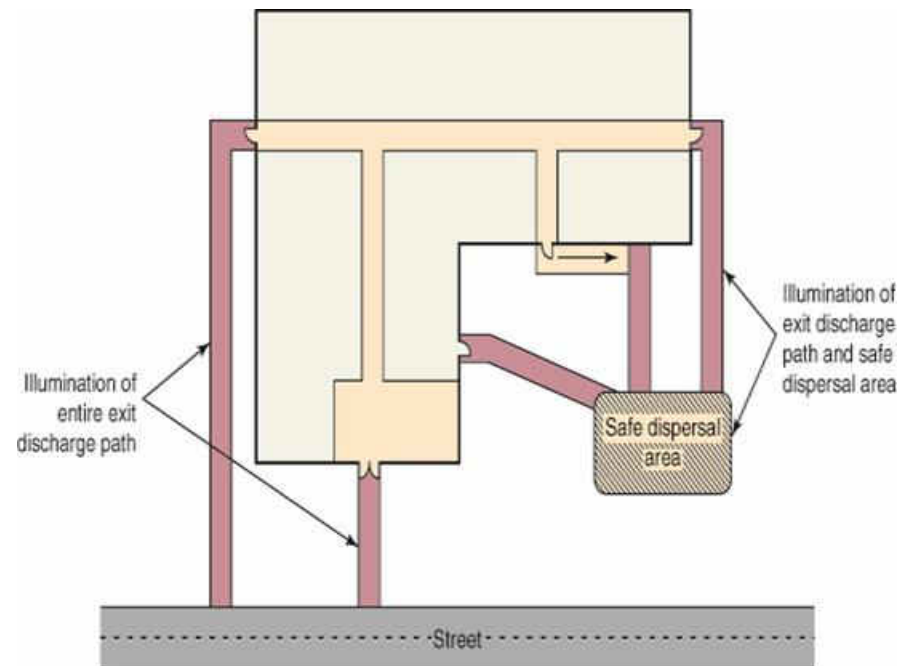



1008.3.5, 1008.2.2 Emergency Illumination in Group I-2

- Emergency lighting required in Group I-2 occupancies such that failure of single lamp in a luminaire maintains minimum 1 foot-candle illumination level
- Previously based on failure of single lighting unit



1009.7.2 Protection of Exterior Area of Assisted Rescue



- Wall rating and opening protectives not required where building fully sprinklered

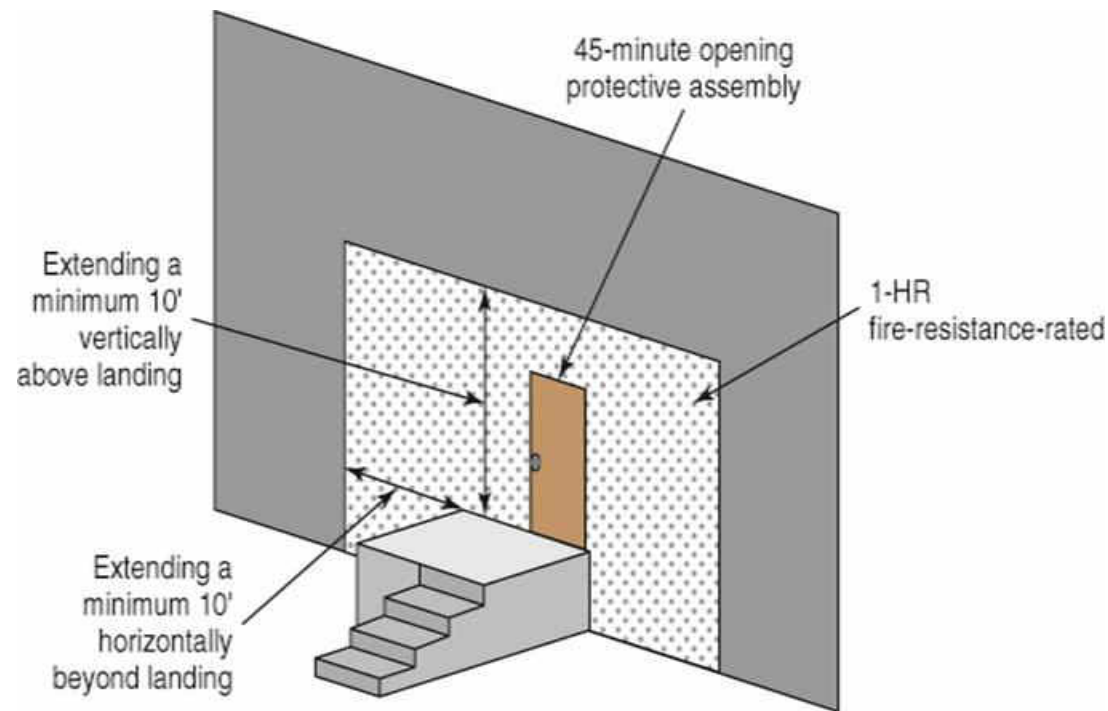



1010.1.1 Size of Doors

- Door width provisions reorganized and revised to correlate with technical requirements of ICC A117.1, ADA, IFC and IPC

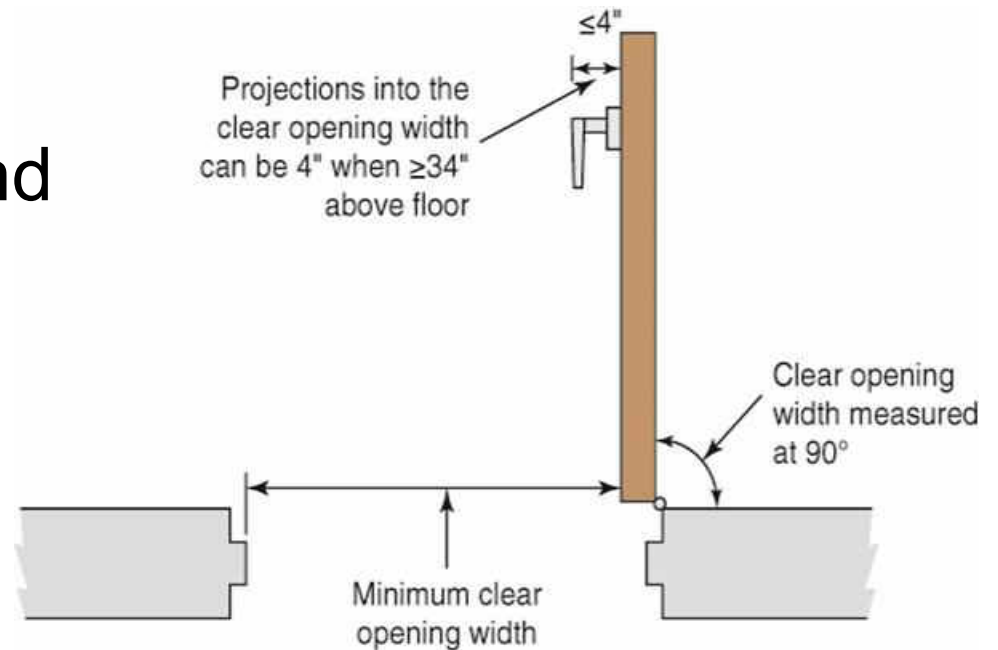



1010.1.4.4 Locking Arrangements in Educational Occupancies

- Applicable to both Groups E and B
- Addresses locking devices designed to keep intruders from entering room
- Conditions include:
 - Allows for outside unlocking
 - Openable from within room
 - Modifications to door hardware or closers not permitted



1010.1.9.8 Use of Delayed Egress Locking Systems in Group E Classrooms



- Delayed egress locking devices now permitted on Group E classrooms with an occupant load < 50
- Also permitted on courtroom means of egress doors other than main door(s) where building is sprinklered

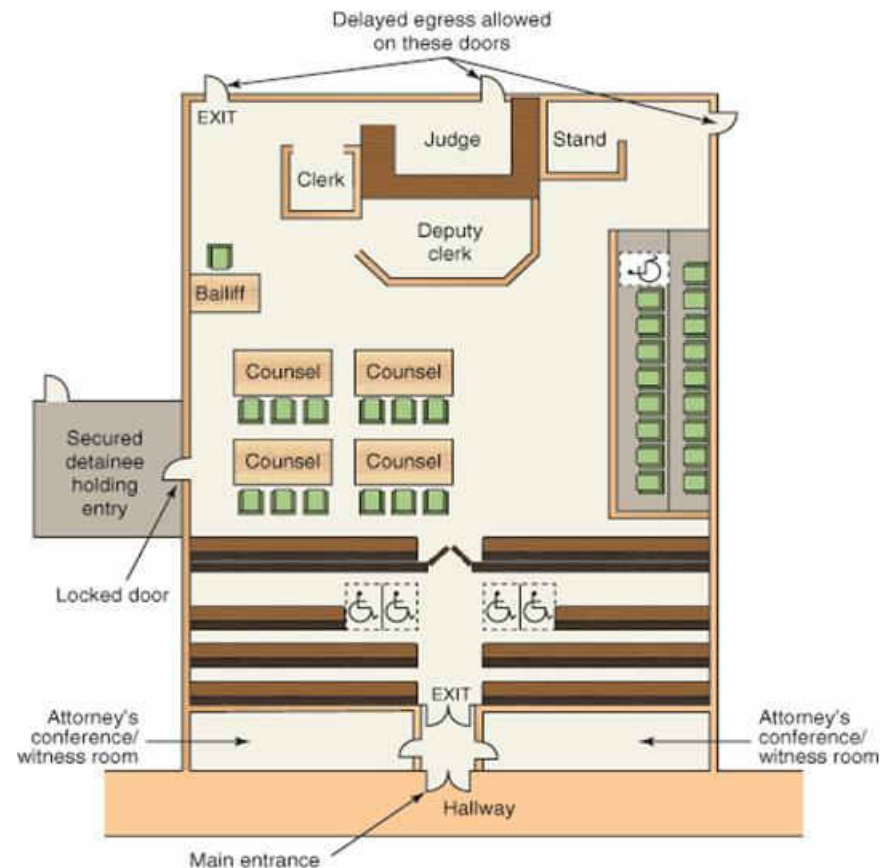



1010.1.9.12 Locks on Stairway Doors

- Allowance for locking of stairway doors no longer limited to stairways serving four stories or less

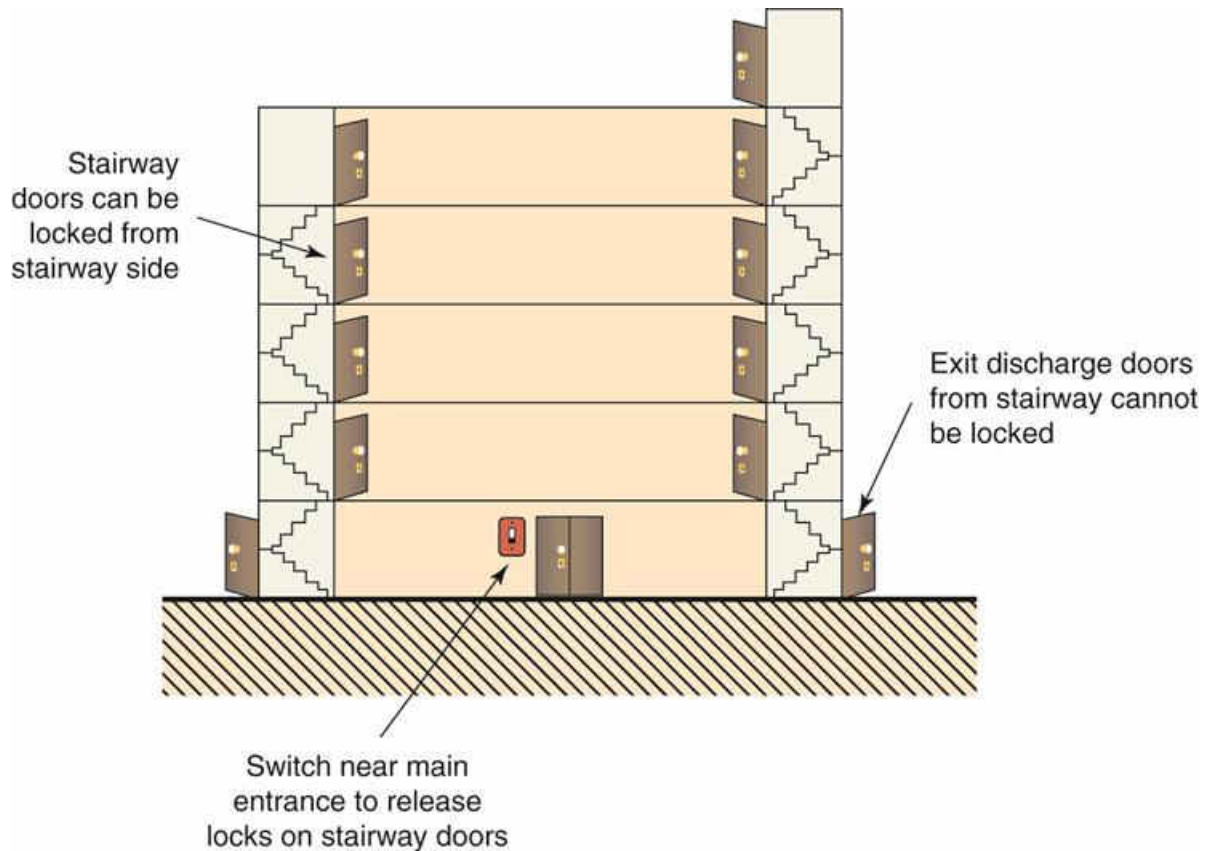



1010.3.2 Security Access Turnstiles

- Allows for use as component of means of egress system where:
 - Building fully sprinklered
 - Minimum clear passage of 22 inches
 - Barrier automatically retracts to open position under each of 5 conditions
- Egress capacity limit to 50 persons where < 32 inches clear

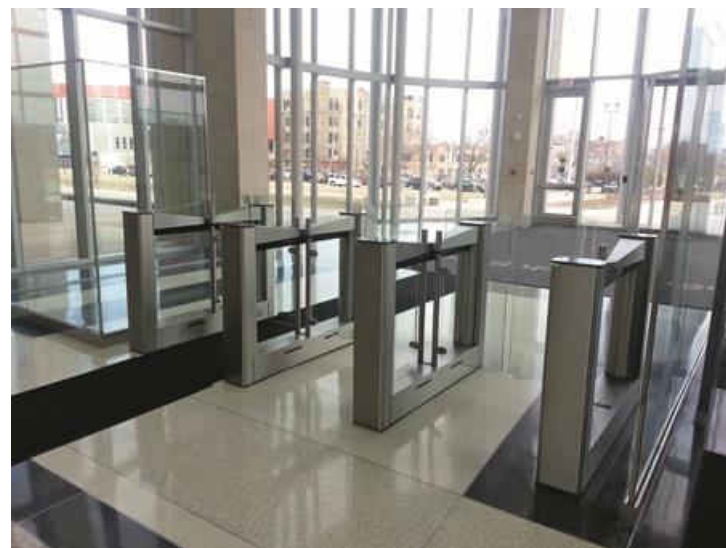



1013.2 Floor Level Exit Sign Location

- Bottom of 'low-level' exit signs now limited to maximum 18 inches above floor level





1015.6, 1015.7 Fall Arrest for Rooftop Equipment

- Prescriptive provisions for placement of personal fall arrest/restraint anchorage connector devices deleted with reference to ANSI/ASSE Z 359.1
- Now standard provides guidance on actual roof system and equipment location



1017.3, 202 Measurement of Egress Travel



- Common path measurement applicable to every room, area or space

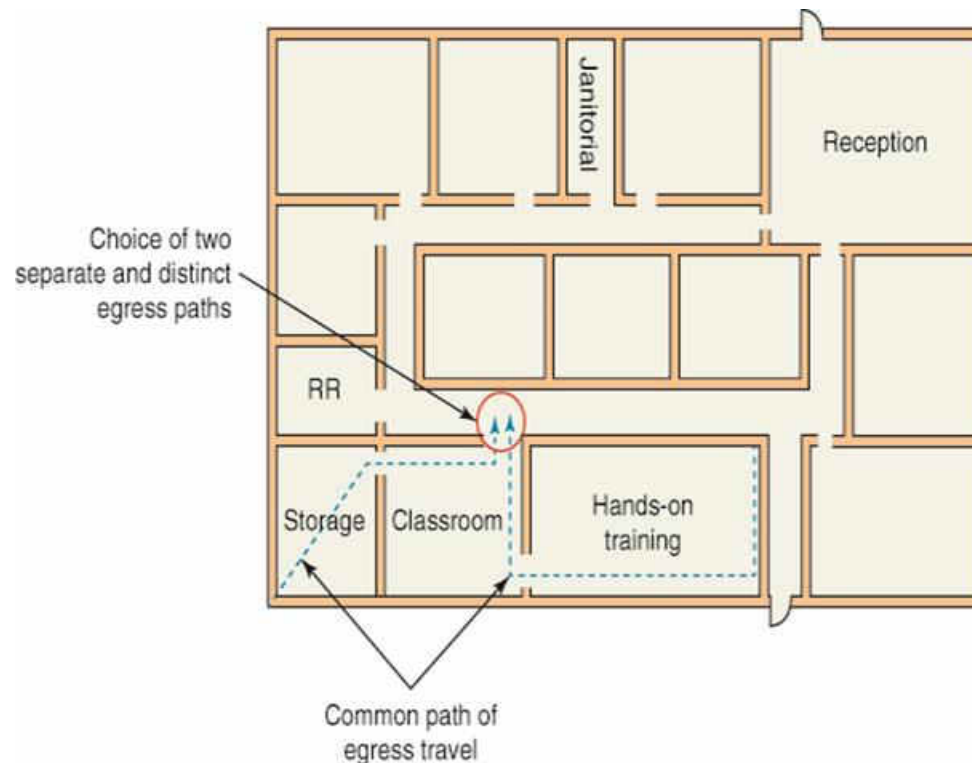



1023.3.1 Stairway Extensions

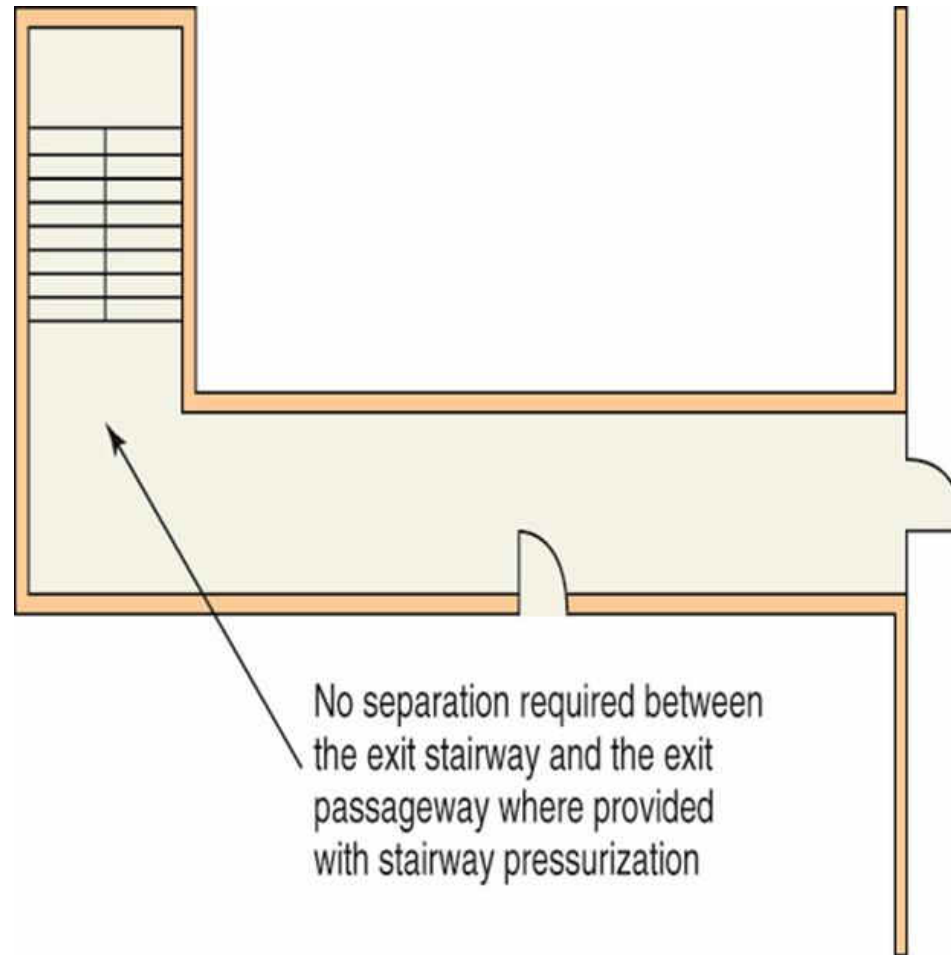



1023.5, 1024.6 Exit Stairway and Exit Passageway Penetrations

- Allowable penetrations into or through interior exit stairways/ramps and exit passageways now include:
 - Security systems
 - Two-way communication systems





1025.1 Luminous Egress Path Marking in Group I-1 Occupancies

- Luminous egress path markings no longer required in high-rise buildings classified as Group I-2, I-3 or I-4 occupancies

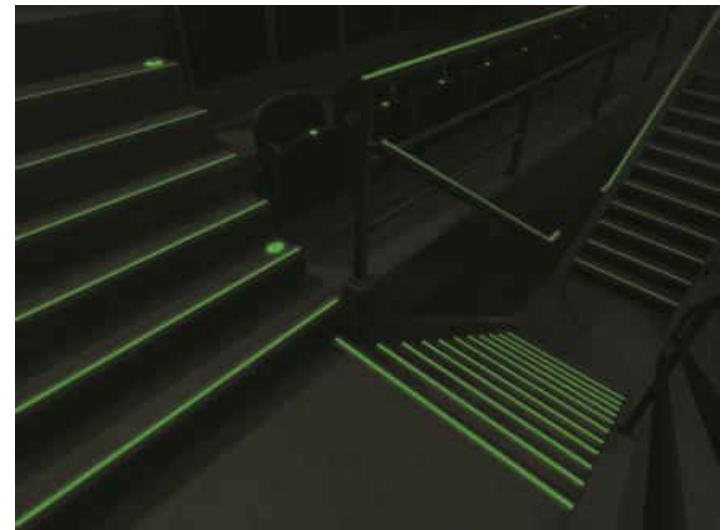

1026.4 Refuge Areas for Horizontal Exits



- Refuge area to accommodate:
 - Original occupant load of refuge area, plus
 - Occupant load anticipated from adjoining compartment
- Anticipated occupant load to be based on:
 - Capacity of horizontal exit doors entering the refuge area, or
 - Total occupant load of adjoining compartment, whichever is less
- Floor area/occupant now references Chapter 4



1026.4 Refuge Areas for Horizontal Exits

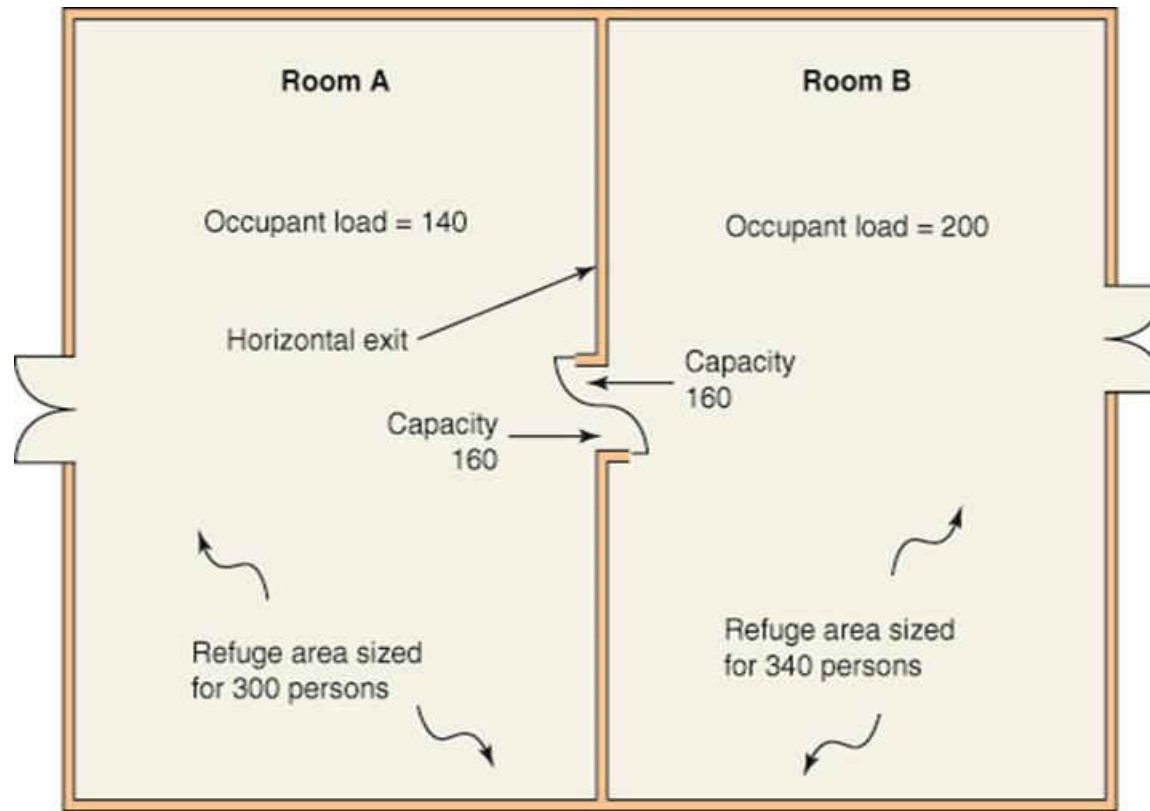

$$\frac{140 \text{ initial occupant load of Room A} + 160 \text{ door capacity from Room B}}{300}$$

$$\frac{200 \text{ initial occupant load of Room B} + 140 \text{ total OL from Room A}}{340}$$





1029.6, 1029.6.3, 202 Open-Air Assembly Seating

- Outdoor smoke-protected assembly seating now referred to as “open-air assembly seating”
- New definition recognizing seating served by means of egress not subject to smoke accumulation within or under a structure and open to atmosphere





1030.1 Required Emergency Escape and Rescue Openings

- Clarified scope of provisions regarding single-exit stories
- Group R-4 now specifically addressed
- In sprinklered buildings, basement sleeping rooms not required to have EEROs where:
 - One MOE and one EERO, or
 - Two MOEs

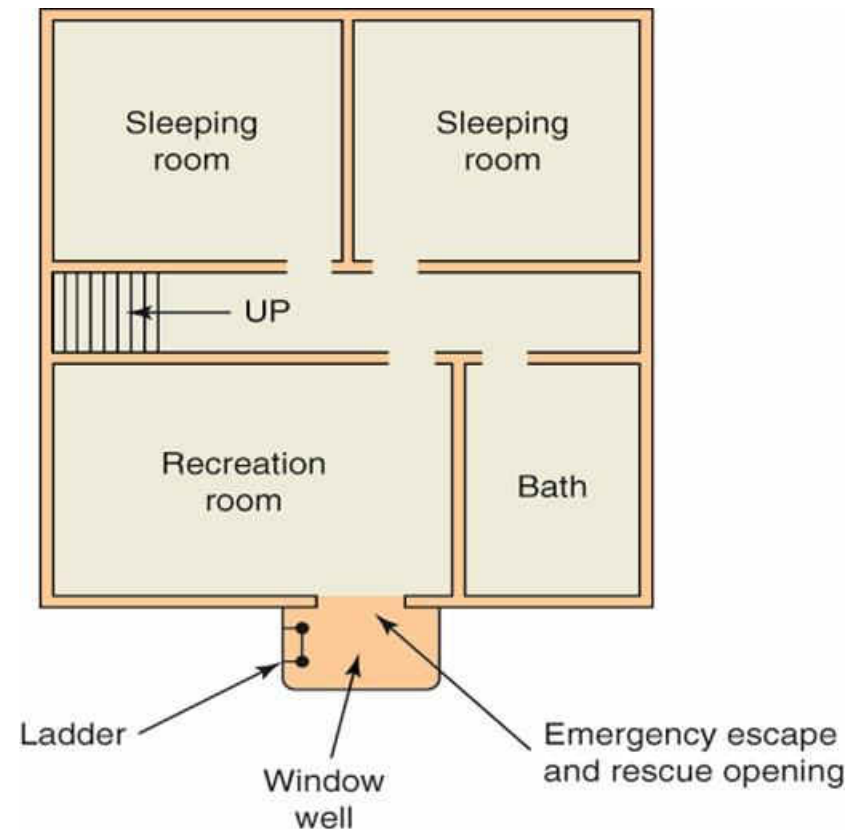



Chapter 11

Accessibility



1103.2.14 Access to Walk-In Coolers and Freezers

- Walk-in cooler and freezer equipment exempted from accessibility provisions where accessed only from work areas





1109.2.1.2 Fixtures in Family or Assisted-Use Toilet Rooms

- Additional fixtures permitted in a family or assist-use toilet room now include:
 - Child-height water closet
 - Child-height lavatory
- Provides additional accommodation on an optional basis





1109.15 Access to Gaming Machines and Gaming Tables

- Access to gaming areas in casinos and similar facilities now regulated separately for:
 - Gaming machine type
 - Gaming table type
- Requirement for front approach at gaming machines deleted





1110.4.13 Access to Play Areas for Children

- Play areas containing children's play components to be located on accessible route





Chapter 12

Interior Environment



1206.2, 1207.3 Engineering Analysis of Sound Transmission

- Performance-based approach to sound transmission compliance
- Based on a comparison with designs tested to ASTM E90
- Applies to both:
 - Air-borne sound
 - Structural-borne sound

1 layer $\frac{5}{8}$ " Type 'X' gypsum board each side

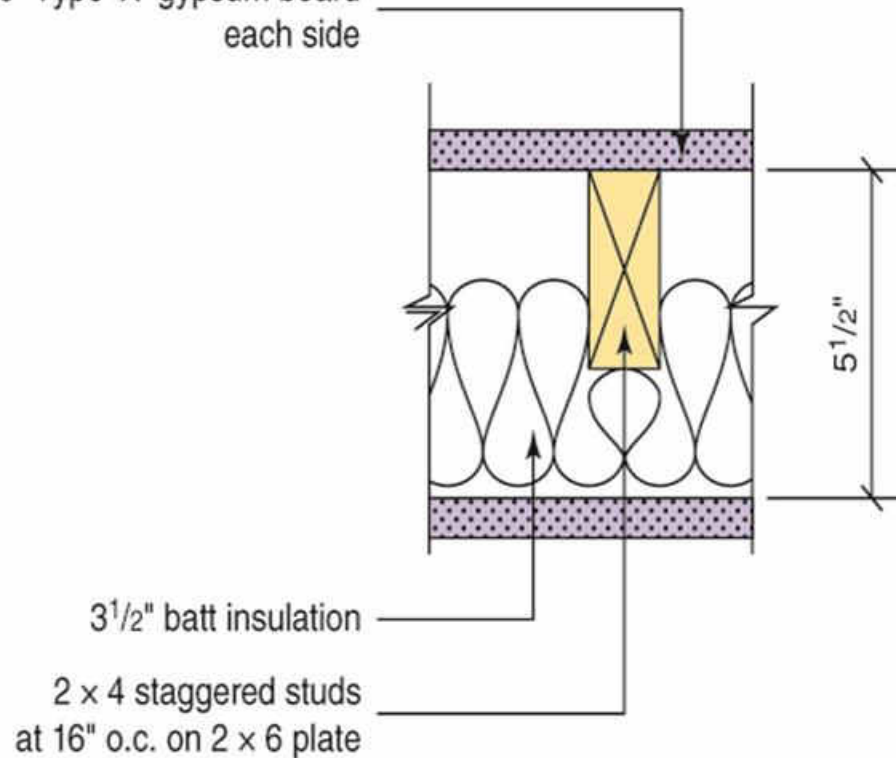

STC Rating of 53





Chapter 14

Exterior Walls



Table 1404.2 Weather Covering Minimum Thickness

TABLE 1405.2 1404.2 Minimum Thickness of Weather Coverings

Covering Type	Minimum Thickness (inches)
Adhered masonry veneer	0.25
• <u>Architectural cast stone</u>	<u>0.75</u>
• <u>Other</u>	<u>0.25</u>
Anchored masonry veneer	2.625
• <u>Stone (natural)</u>	<u>2.0</u>
• <u>Architectural cast stone</u>	<u>1.25</u>
• <u>Other</u>	<u>2.625</u>
Stone (cast artificial, anchored)	1.5
Stone (natural)	2.0

(Portions of table and footnotes not shown remain unchanged.)





1404.18 Polypropylene Siding

- Polypropylene siding now permitted for use on exterior walls of all types of construction
- Previously limited to Type VB construction





Chapter 15

Roof Assemblies and Rooftop Structures



1504.3.3 Metal Roof Shingles

- Metal roof shingles now addressed independent from other metal panel roof systems
- Reference made to applicable standards for:
 - Labeling
 - Testing for wind resistance





1507.1 Underlayment

- Underlayment and ice barrier requirements relocated to a single location in code to address:
 - Type
 - Attachment
 - Application

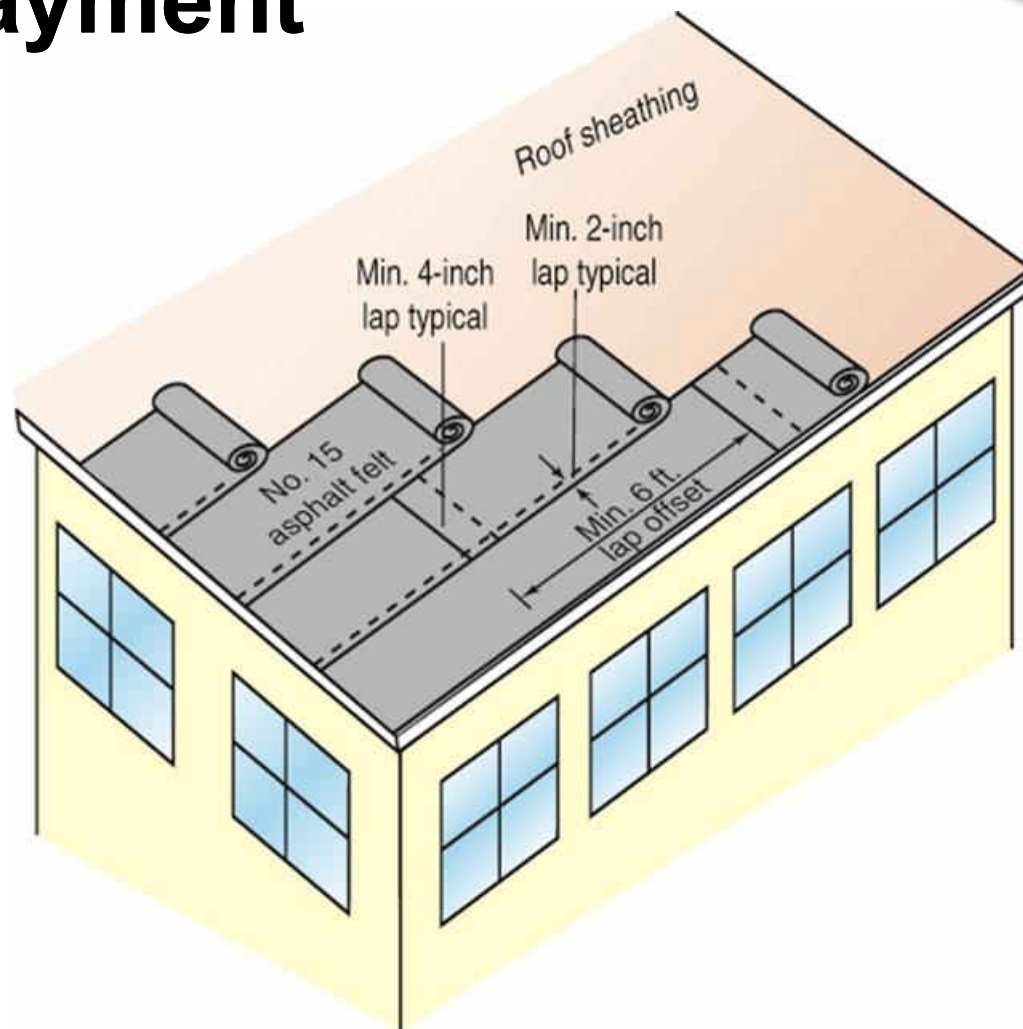

1507.1 Underlayment

TABLE 1507.1.1(2) Underlayment Application

<u>Roof Covering</u>	<u>Section</u>	<u>Maximum Basic Design Wind Speed, V < 140 mph</u>	<u>Maximum Basic Design Wind Speed, V ≥ 140 mph</u>
<u>Asphalt shingles</u>	<u>1507.2</u>	<p><u>For roof slopes from two units vertical in 12 units horizontal (2:12), up to four units vertical in 12 units horizontal (4:12), underlayment shall be two layers applied as follows: Apply a 19-inch (483 mm) strip of underlayment felt parallel to and starting at the eaves. Starting at the eave, apply 36-inch-wide (914 mm) sheets of underlayment, overlapping successive sheets 19 inches (483 mm). End laps shall be 4 inches (102 mm) and shall be offset by 6 feet (1829 mm). Distortions in the underlayment shall not interfere with the ability of the shingles to seal.</u></p> <p><u>For roof slopes of four units vertical in 12 units horizontal (4:12) or greater, underlayment shall be one layer applied as follows: Underlayment shall be applied shingle fashion, parallel to and starting from the eave and lapped 2 inches (51 mm). Distortions in the underlayment shall not interfere with the ability of the shingles to seal. End laps shall be 4 inches (102 mm) and shall be offset by 6 feet (1829 mm).</u></p>	<p><u>Same as Maximum Basic Design Wind Speed, V < 140 mph except all laps shall be not less than 4 inches (102 mm).</u></p>





1507.18 Building Integrated Photovoltaic Panels

- Roof covering requirements established for BIPV panel systems
 - Deck requirements
 - Deck slope
 - Underlayment
 - Material standards
 - Attachment
 - Wind resistance





Chapter 16

Structural Design



1603.1 Construction Documents

- Additional loads to be identified for conventional light-frame construction:
 - Floor and roof dead loads
 - Rain load data
- Slope factor to now be included in roof snow load data
- Rain intensity to be shown regardless of whether rain loads govern the design





1604.3.7 Deflection of Glass Framing

- Deflection of framing members supporting glass now addressed based on length of member span
- When subjected to 0.6 times the component and cladding wind loads, deflection limited to:
 - $1/175$ of span length not more than 13 feet 6 inches
 - $1/240 + 1/4$ inch for members with greater lengths

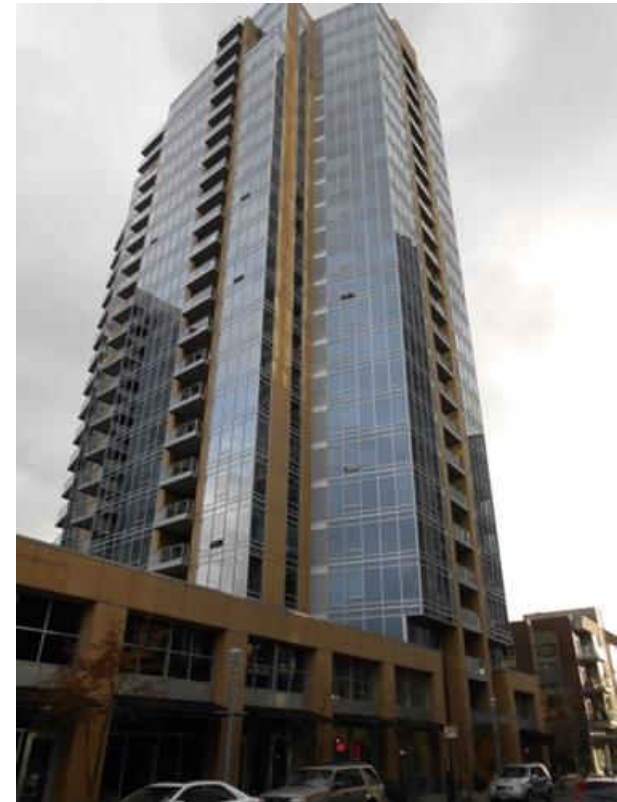



1604.5.1 Multiple Occupancies

- Where assigning a risk category to a building with a storm shelter, the normal occupancy of building shall apply





1604.10 Storm Shelters

- ICC 500 standard now referenced for load determinations of storm shelters
 - Provides wind speeds for tornado and hurricane shelter design using ASCE 7 load combinations





Table 1607.1 Deck Live Load

TABLE 1607.1 Minimum Uniformly Distributed Live Loads, L_0 , and Minimum Concentrated Live Loads

Occupancy or Use	Uniform (psf)	Concentrated (pounds)
5. Balconies and decks ^h	<u>1.5 times the live load for the area served, not required to exceed 100</u> Same as occupancy served	—

h. See Section 1604.8.3 for decks attached to exterior walls.





Table 1607.1 Live Load Reduction

- Table 1607.1 now clarified as to where heavy live loads of 100 psf or greater may be reduced
- Three conditions addressed by footnotes:
 - “m” Not permitted
 - “n” Only per Section 1607.11.1.2 or Item 1 of Section 1607.11.2
 - “o” Only per Section 1607.11.1.3 or Item 2 of Section 1607.11.2





Table 1607.1 Live Load Reduction

Occupancy or Use	Uniform (psf)	Concentrated (pounds)
26. Roofs		
Occupiable roofs:		
Roof gardens	100	
Assembly areas	100 ^m	
All other similar areas	Note l	Note l
29. Sidewalks, vehicular driveways and yards, subject to trucking	250 ^{d, mn}	8,000 ^o

(Footnotes a-k not included for brevity.)

- l. Areas of occupiable roofs, other than roof gardens and assembly areas, shall be designed for appropriate loads as approved by the building official. Unoccupied landscaped areas of roofs shall be designed in accordance with Section ~~1607.12.3~~ 1607.13.3.
- m. Live load reduction is not permitted ~~unless specific exceptions of Section 1607.10 apply.~~
- n. Live load reduction is only permitted in accordance with Section 1607.11.1.2 or Item 1 of Section 1607.11.2.
- o. Live load reduction is only permitted in accordance with Section 1607.11.1.3 or Item 2 of Section 1607.11.2.





1607.14.2 Minimum Fire Load for Fire Walls

- Minimum lateral loading required for fire walls now established at 5 psf
- Based on assumption that structure on one side of wall has collapsed
- Consistent with fire walls designed in accordance with NFPA 221





1609 Wind Loads

- Updated wind speed maps
- Terminology changed from “ultimate design” to “basic design”

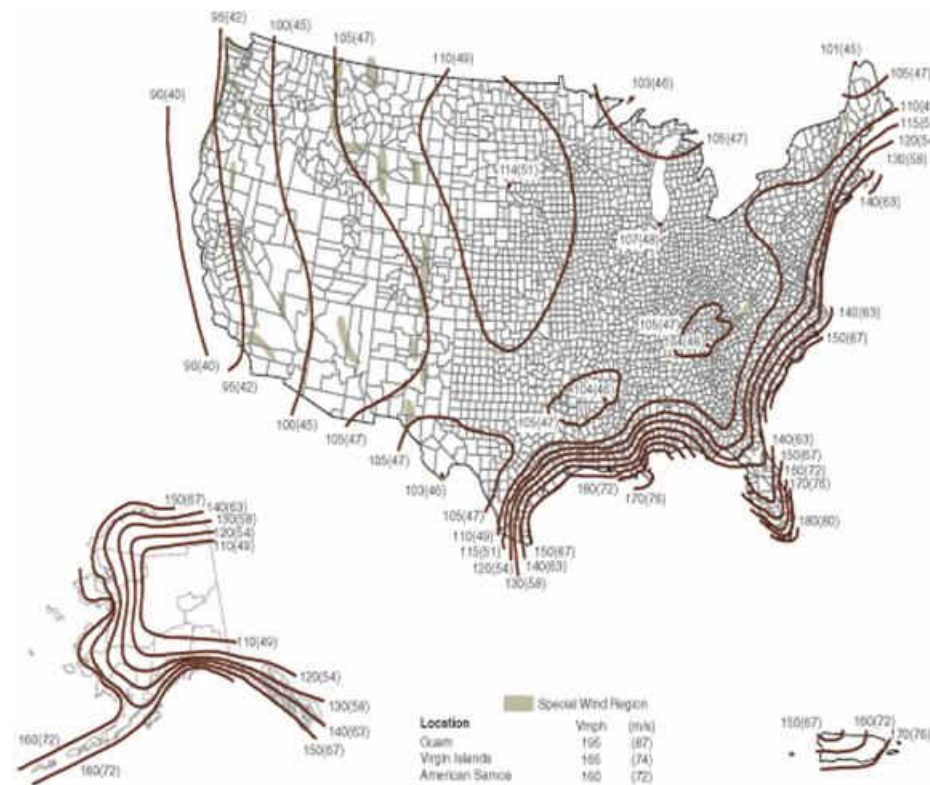

Notes:

1. Values are nominal design 3-second gust wind speeds in miles per hour (mph) at 33 ft (10 m) above ground for Exposure C category.
2. Linear interpolation is permitted between contours. Point values are provided to aid with interpolation.
3. Islands, coastal areas, and land boundaries outside the last contour shall use the last wind speed contour.
4. Mountainous terrain, gorges, ocean promontories, and special wind regions shall be examined for unusual wind conditions.
5. Wind speeds correspond to approximately a 7% probability of exceedence in 50 years (Annual Exceedence Probability = 0.00143, MRF = 700 Years).
6. Location-specific basic wind speeds shall be permitted to be determined using www.asouncil.org/windspeed.





1613 Earthquake Loads

- Values of site coefficients now in alignment with newest generation of ground motion attenuation equations
- Modifications made for both short period and 1-second period parameters
- Previous coefficients based on soil studies performed in early 1990s





1613 Earthquake Loads

TABLE 1613.3.3(1) 1613.2.3(1) Values of Site Coefficient F_a^a

Site Class	Mapped Risk Targeted Maximum Considered Earthquake (MCE _R) Spectral Response Acceleration Parameter at short period					
	$S_s \leq 0.25$	$S_s = 0.50$	$S_s = 0.75$	$S_s = 1.00$	$S_s \geq 1.25$	$S_s \geq 1.5$
A	0.8	0.8	0.8	0.8	0.8	0.8
B	0.91-0	0.91-0	0.91-0	0.91-0	0.91-0	0.9
C	1.3-1.2	1.31-2	1.21-1	1.21-0	1.21-0	1.2
D	1.6	1.4	1.2	1.1	1.0	1.0
E	2.4-2.5	1.7	1.31-2	Note b-9	Note b-9	Note b
F	Note b	Note b	Note b	Note b	Note b	Note b

- a. Use straight-line interpolation for intermediate values of mapped spectral response acceleration at short period, S_s .
 b. Values shall be determined in accordance with Section 11.4.7 11.4.8 of ASCE 7.

TABLE 1613.3.3(2) 1613.2.3(2) Values of Site Coefficient F_v^a

Site Class	Mapped Risk Targeted Maximum Considered Earthquake (MCE _R) Spectral Response Acceleration Parameter at 1-second period					
	$S_1 \leq 0.1$	$S_1 = 0.2$	$S_1 = 0.3$	$S_1 = 0.4$	$S_1 \geq 0.5$	$S_1 \geq 0.6$
A	0.8	0.8	0.8	0.8	0.8	0.8
B	0.8-1.0	0.8-1.0	0.8-1.0	0.8-1.0	0.8-1.0	0.8
C	1.5-1.7	1.5-1.6	1.5	1.5-1.4	1.5-1.3	1.4
D	2.4	2.2°-2.0	2.0°-1.8	1.9°-1.6	1.8°-1.5	1.7°
E	4.2-3.5	3.3°-3.2	2.8°	2.4°	2.2°-2.4	2.0°
F	Note b	Note b	Note b	Note b	Note b	Note b

- a. Use straight-line interpolation for intermediate values of mapped spectral response acceleration at 1-second period, S_1 .
 b. Values shall be determined in accordance with Section 11.4.7 11.4.8 of ASCE 7.
 c. See requirements for site-specific ground motions in Section 11.4.7 11.4.8 of ASCE 7.





1613.2.1 Seismic Maps

- Seismic maps updated to match new maps in
 - 2015 NEHRP
 - 2016 ASCE 7





1615 Tsunami Loads

- New section and definitions address tsunami-resistant design of critical infrastructure and essential facilities
- Applicable to Risk Category III and IV structures located in Tsunami Design Zones





Chapter 17

Special Inspections and Tests



1704.6 Structural Observation

- Structural observation now required in all buildings classified as:
 - High-rise
 - Risk Category IV





1705.5.2 Metal-plate-connected Wood Trusses

- Special inspection of wood trusses required where:
 - Clear span exceeds 60 feet, or
 - Overall height is 60 inches or greater





1705.12.1, 1705.13.1 Seismic Force-Resisting Systems

- Exceptions for special inspection of structural steel in seismic force-resisting systems have been clarified for structures in moderate and high-seismic regions
 - Applicable to all SDCs except A





1705.12.6 Fire Sprinkler Clearance

- Provisions added for periodic special inspection of minimum clearance of fire sprinkler components to mechanical, electrical and plumbing systems
 - Not required where flexible sprinkler hose fittings are used





Chapter 18

Soils and Foundations



1804.4 Site Grading

- Impervious surfaces now permitted to slope less than 2% where surface is a door landing or ramp required to comply with egress provisions
- General provisions require minimum 2% slope to allow for water drainage away from building





1807.2 Retaining Walls

- Presence of a keyway in a retaining wall no longer recognized in the sliding analysis of the wall
- Keyway may still be used when designed using the principles of soil mechanics and accepted engineering practice





1810.3.8.3 Precast Prestressed Piles

- Equations addressing precast prestressed piles have been updated





Chapter 19

Concrete



1901.2 Seismic Loads for Precast Concrete Diaphragms

- In the design of precast concrete diaphragms used in buildings located in high seismic regions, applicable provisions of ASCE 7 to be used

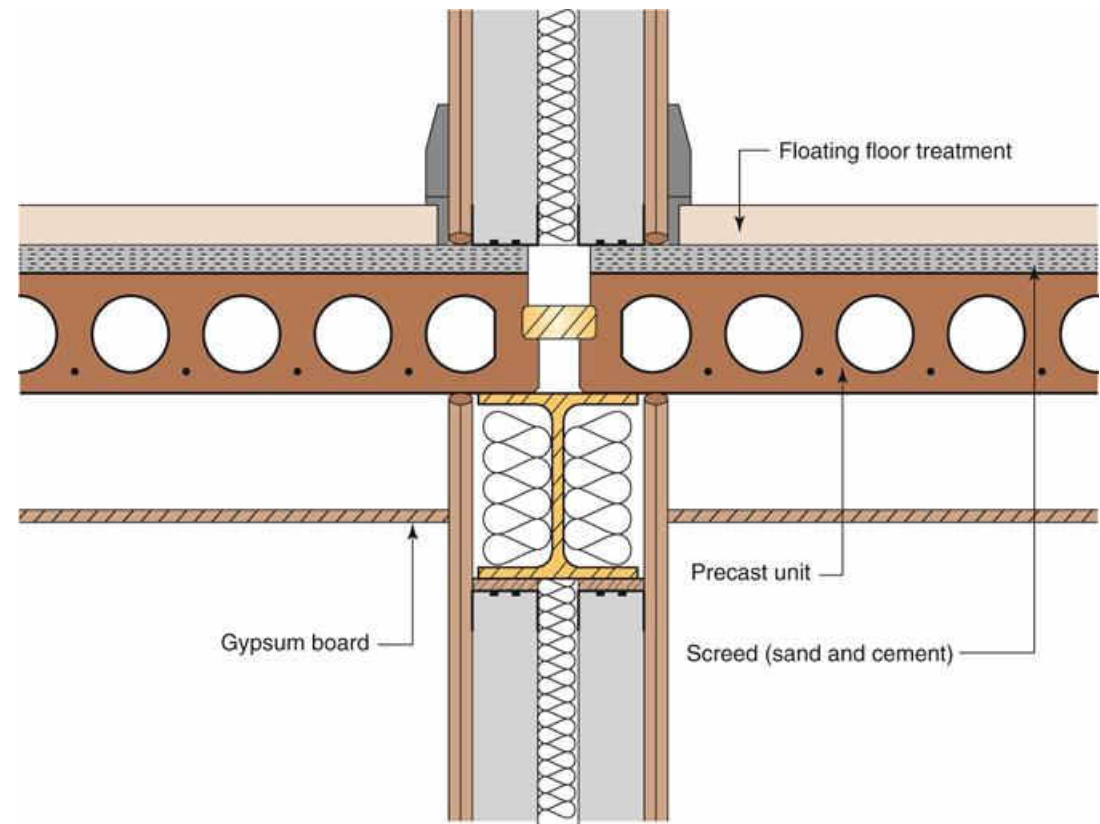



Chapter 22

Steel



2207.1 SJI Standard

- 2015 edition of combined SJI1-100 standard now referenced for steel joists

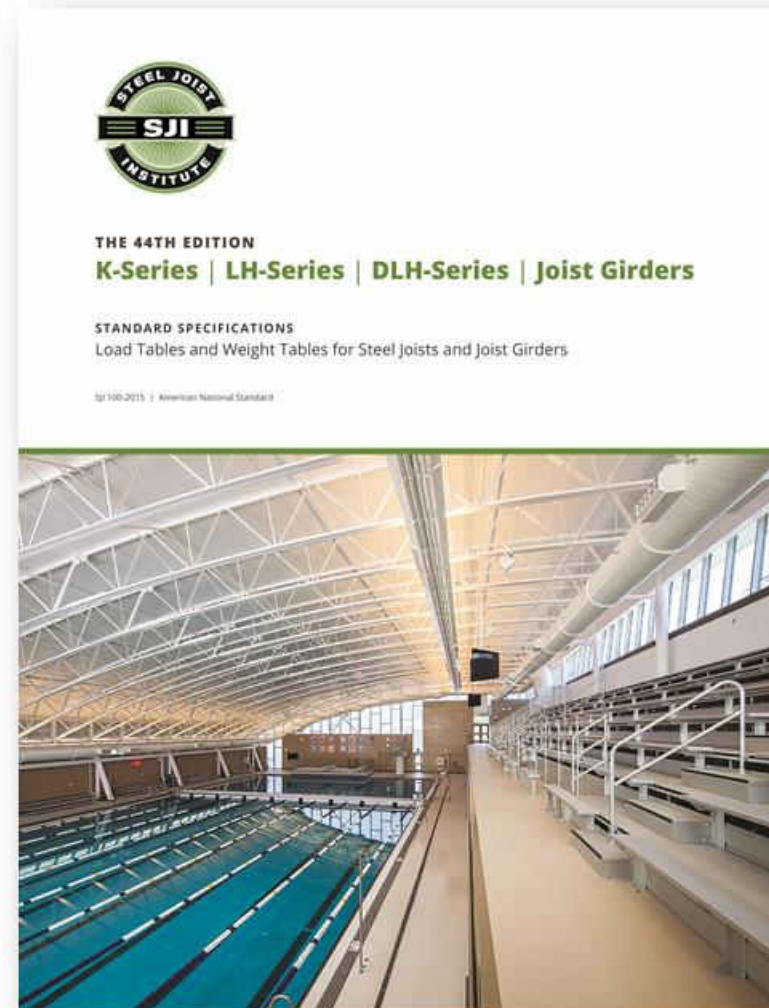

2209.2 Cantilevered Steel Storage Racks



- Reference is now made to RMI standard for cantilevered steel storage racks

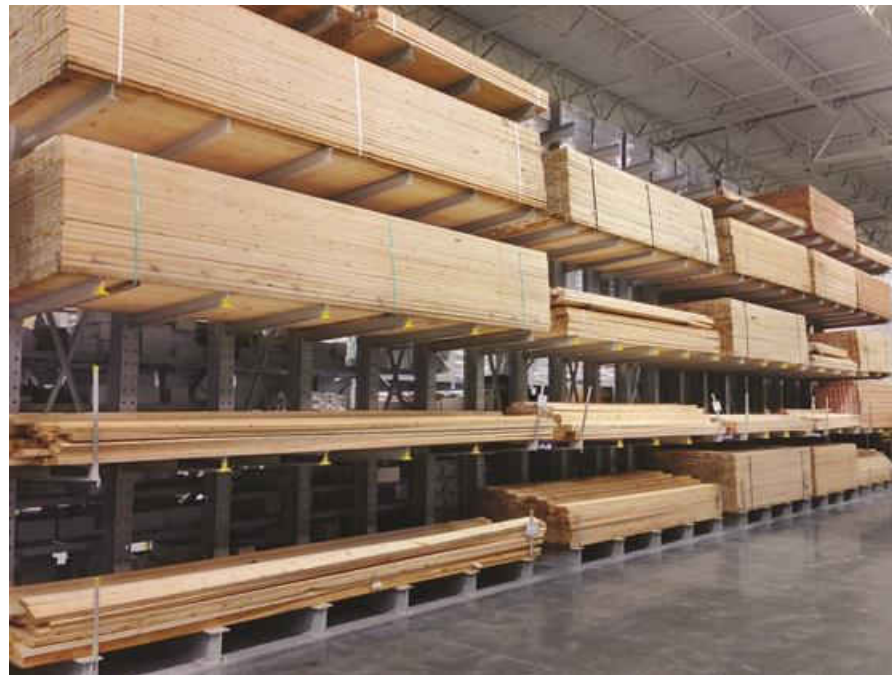



2211 Cold-Formed Light-Frame Construction

- 2015 editions of AISI standards for cold-formed steel now referenced

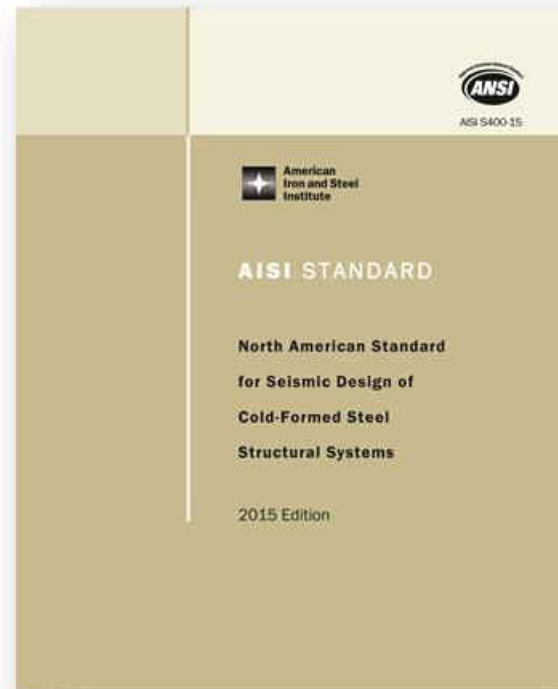
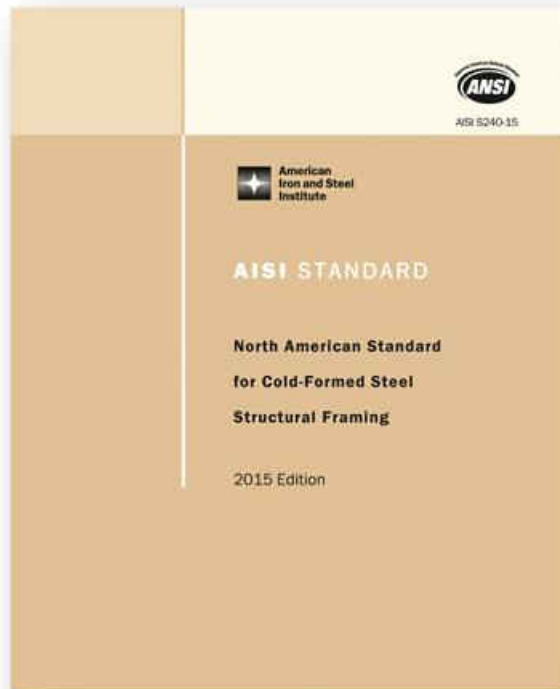

← 2018 IBC Significant Changes

→ 158



Chapter 23

Wood



2303.2.2 Fire-Retardant-Treated Wood

- Engineered lumber of FRT wood to be impregnated with chemicals
- Paints, coating, stains and other surface treatments not an approved method





2303.6 Nails and Staples

- Nails and staples to also comply with Supplement 1 of ASTM F 1667
- Minimum average bending moment values have been added for staples





Table 2304.9.3.2 Mechanically Laminated Decking

- New alternative fastener schedule for construction of mechanically laminated decking
- Provides for equivalency where power-driven fasteners are used instead of 30 penny nails





Table 2304.9.3.2 Mechanically Laminated Decking

TABLE 2304.9.3.2 Fastening Schedule for Mechanically Laminated Decking Using Laminations of 2-inch Nominal Thickness

Minimum Nail Size (Length × Diameter) (inches)	Maximum Spacing Between Face Nails ^{a,b} (inches)		Number of Toenails into Supports ^c
	Decking Supports ≤ 48 inches o.c.	Decking Supports > 48 inches o.c.	
4 × 0.192	30	18	1
4 × 0.162	24	14	2
4 × 0.148	22	13	2
3½ × 0.162	20	12	2
3½ × 0.148	19	11	2
3½ × 0.135	17	10	2
3 × 0.148	11	7	2
3 × 0.128	9	5	2
2¾ × 0.148	10	6	2
2¾ × 0.131	9	6	3
2¾ × 0.120	8	5	3

For SI: 1 inch = 25.4 mm

- Nails shall be driven perpendicular to the lamination face, alternating between top and bottom edges.
- Where nails penetrate through two laminations and into the third, they shall be staggered one-third of the spacing in adjacent laminations. Otherwise, nails shall be staggered one-half of the spacing in adjacent laminations.
- Where supports are 48 inches (1219 mm) on center or less, alternate laminations shall be toenailed to alternate supports; where supports are spaced more than 48 inches (1219 mm) on center, alternate laminations shall be toenailed to every support.





Table 2304.10.1 Ring Shank Nails

- 8-penny common or ring shank nails now addressed for fastening of roof sheathing when nailing 6 inches or 12 inches on center
- Provides for alignment of 2018 IBC and IRC





Table 2304.10.1 Ring Shank Nails

TABLE 2304.10.1 Fastening Schedule, roof requirements

Wood structural panels (WSP), subfloor, roof and interior wall sheathing to framing and particleboard wall sheathing to framing			
Building Element	Number and Type of Fastener	Spacing and Location	
		Edges (inches)	Intermediate supports (inches)
31-30. 3/8" - 1/2"	8d box common or deformed (2 1/2" x 0.1130.131") (roof), or RSRS-01 (2 3/8" x 0.113") nail (roof) ^d	6	12
	2 3/8" x 0.113" nail (roof)	4	8
	1-3/4" 16 gage staple, 7/16" crown (roof)	3	6
32-31. 1 9/32" - 3/4"	8d common or deformed (2 1/2" x 0.131") (roof), or RSRS-01 (2 3/8" x 0.113") nail (roof) ^d	<u>6</u>	<u>12</u>
	2 3/8" x 0.113" nail; or	4	8
	2" 16 gage staple, 7/16" crown	4	8
33-32. 7/8" - 1 1/4"	10d common (3" x 0.148"); or 8d deformed (2 1/2" x 0.131")	6	12

For SI: 1 inch = 25.4 mm.

d. RSRS-01 is a Roof Sheathing Ring Shank nail meeting the specifications in ASTM F 1667.

(No changes to footnotes a-c.)





2304.10.5 Fasteners in Treated Wood

- Staples used in preservative-treated wood and fire-retardant-treated wood now required to be made of stainless steel



2304.11 Heavy-Timber Construction



- Heavy timber provisions of Chapter 23 have been reorganized
- Table on engineered lumber dimensional equivalencies relocated from Section 602.4



2304.11 Heavy-Timber Construction

TABLE 602.4TABLE 2304.11 Wood-Member-Size Equivalencies Minimum Dimensions of Heavy Timber Structural Members

<u>Supporting</u>	<u>Heavy Timber Structural Elements</u>	<u>Minimum Nominal Solid Sawn Size</u>		<u>Minimum Glued-laminated Net Size</u>		<u>Minimum Structural Composite Lumber Net Size</u>	
		<u>Width, inch</u>	<u>Depth, inch</u>	<u>Width, inch</u>	<u>Depth, inch</u>	<u>Width, inch</u>	<u>Depth, inch</u>
<u>Floor loads only or combined floor and roof loads</u>	• <u>Columns;</u>						
	• <u>Framed sawn or glue-laminated timber arches which spring from the floor line</u>	8	8	6¼	8¼	7	7½
	• <u>Framed timber trusses</u>						
<u>Roof loads only</u>	• <u>Wood beams and girders</u>	6	10	5	10½	5¼	9½
	• <u>Columns (roof and ceiling loads)</u>						
	• <u>Lower half of wood-frame or glue-laminated arches which spring from the floor line or from grade</u>	6	8	5	8¼	5¼	7½
	• <u>Upper half of wood-frame or glue-laminated arches which spring from the floor line or from grade</u>	6	6	5	6	5¼	5½
	• <u>Framed timber trusses and other roof framing^a</u>						
	• <u>Framed or glue-laminated arches that spring from the top of walls or wall abutments</u>	4 ^b	6	3 ^b	6¾	3½ ^b	5½

For SI: 1 inch = 25.4 mm.

a. Spaced members shall be permitted to be composed of two or more pieces not less than 3 inches (76 mm) nominal in thickness where blocked solidly throughout their intervening spaces or where spaces are tightly closed by a continuous wood cover plate of not less than 2 inches (51 mm) nominal in thickness secured to the underside of the members. Splice plates shall be not less than 3 inches (76 mm) nominal in thickness.

b. Where protected by approved automatic sprinklers under the roof deck, framing members shall be not less than 3 inches (76 mm) nominal in width.



2304.12.2.5, 2304.12.2.6 Supporting Members for Permeable Floors and Roofs



- Where an impervious moisture barrier system is used to protect the wood structure supporting floors, positive drainage shall be provided for water that infiltrates the moisture-permeable floor topping

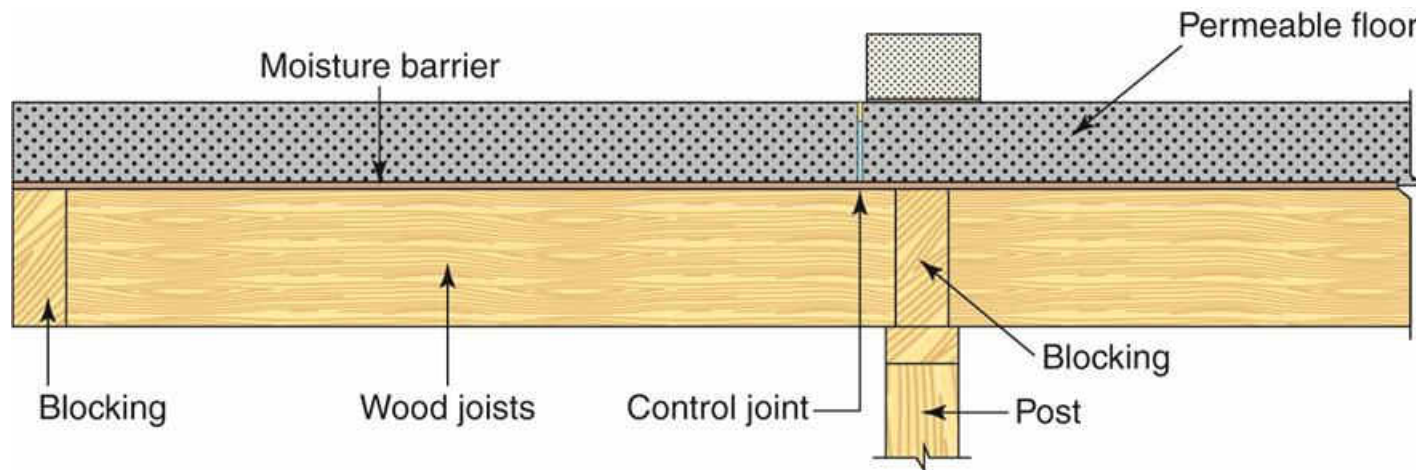



Table 2308.4.1.1 (1) Header and Girder Spans – Exterior Walls

TABLE 2308.4.1.1(1) Header and Girder Spans^{a,b} for Exterior Bearing Walls

Headers and Girders Supporting		Ground Snow Load (psf) ^e							
		30				50			
		Building Width ^c (feet)							
		12		24		36		12	
Size	Span ^f	NJ ^d	Span ^f	NJ ^d	Span ^f	NJ ^d	Span ^f	NJ ^d	
Roof and Ceiling	1-2 × 6	4 - 0	1	3 - 1	2	2 - 7	2	3 - 5	1
	1-2 × 8	5 - 1	2	3 - 11	2	3 - 3	2	4 - 4	2
	1-2 × 10	6 - 0	2	4 - 8	2	3 - 11	2	5 - 2	2
	1-2 × 12	7 - 1	2	5 - 5	2	4 - 7	3	6 - 1	2
	2-2 × 4	4 - 0	1	3 - 1	1	2 - 7	1	3 - 5	1
	2-2 × 6	6 - 0	1	4 - 7	1	3 - 10	1	5 - 1	1
	2-2 × 8	7 - 7	1	5 - 9	1	4 - 10	2	6 - 5	1
	2-2 × 10	9 - 0	1	6 - 10	2	5 - 9	2	7 - 8	2
	2-2 × 12	10 - 7	2	8 - 1	2	6 - 10	2	9 - 0	2
	3-2 × 8	9 - 5	1	7 - 3	1	6 - 1	1	8 - 1	1
	3-2 × 10	11 - 3	1	8 - 7	1	7 - 3	2	9 - 7	1
	3-2 × 12	13 - 2	1	10 - 1	2	8 - 6	2	11 - 3	2
	4-2 × 8	10 - 11	1	8 - 4	1	7 - 0	1	9 - 4	1
	4-2 × 10	12 - 11	1	9 - 11	1	8 - 4	1	11 - 1	1
	4-2 × 12	15 - 3	1	11 - 8	1	9 - 10	2	13 - 0	1
Roof, ceiling and one center-bearing floor	1-2 × 6	3 - 3	1	2 - 7	2	2 - 2	2	3 - 0	2
	1-2 × 8	4 - 1	2	3 - 3	2	2 - 9	2	3 - 9	2
	1-2 × 10	4 - 11	2	3 - 10	2	3 - 3	3	4 - 6	2

For SI: 1 inch = 25.4 mm, 1 pound per square foot = 0.0479 kPa.

- Spans are given in feet and inches.
- Spans are based on minimum design properties for No. 2 grade lumber of Douglas fir-larch, hem-fir, Southern pine and spruce-pine-fir. No. 1 or better grade lumber shall be used for Southern Pine.
- Building width is measured perpendicular to the ridge. For widths between those shown, spans are permitted to be interpolated.
- NJ - Number of jack studs required to support each end. Where the number of required jack studs equals one, the header is permitted to be supported by an approved framing anchor attached to the full-height wall stud and to the header.
- Use 30 psf ground snow load for cases in which ground snow load is less than 30 psf and the roof live load is equal to or less than 20 psf.
- Spans are calculated assuming the top of the header or girder is laterally braced by perpendicular framing. Where the top of the header or girder is not laterally braced (for example, cripple studs bearing on the header), tabulated spans for headers consisting of 2x8, 2x10, or 2x12 sizes shall be multiplied by 0.70 or the header or girder shall be designed.





Table 2308.4.1.1 (2) Header and Girder Spans – Interior Walls

TABLE 2308.4.1.1(2) Header and Girder Spans^{a,b} for Interior Bearing Walls

Headers and Girders Supporting	Size	Building Width ^c (feet)					
		12		24		36	
		Span ^e	NJ ^d	Span ^e	NJ ^d	Span ^e	NJ ^d
One floor only	2-2 × 4	4-1	1	2-10	1	2-4	1
	2-2 × 6	6-1	1	4-4	1	3-6	1
	2-2 × 8	7-9	1	5-5	1	4-5	2
	2-2 × 10	9-2	1	6-6	2	5-3	2
	2-2 × 12	10-9	1	7-7	2	6-3	2
	3-2 × 8	9-8	1	6-10	1	5-7	1
	3-2 × 10	11-5	1	8-1	1	6-7	2
	3-2 × 12	13-6	1	9-6	2	7-9	2
	4-2 × 8	11-2	1	7-11	1	6-5	1
	4-2 × 10	13-3	1	9-4	1	7-8	1
Two floors	4-2 × 12	15-7	1	11-0	1	9-0	2
	2-2 × 4	2-7	1	1-11	1	1-7	1
	2-2 × 6	3-11	1	2-11	2	2-5	2
	2-2 × 8	5-0	1	3-8	2	3-1	2
	2-2 × 10	5-11	2	4-4	2	3-7	2
	2-2 × 12	6-11	2	5-2	2	4-3	3
	3-2 × 8	6-3	1	4-7	2	3-10	2
	3-2 × 10	7-5	1	5-6	2	4-6	2
	3-2 × 12	8-8	2	6-5	2	5-4	2
	4-2 × 8	7-2	1	5-4	1	4-5	2
4-2 × 10	8-6	1	6-4	2	5-3	2	
4-2 × 12	10-1	1	7-5	2	6-2	2	

For SI: 1 inch = 25.4 mm, 1 pound per square foot = 0.0479 kPa.

- a. Spans are given in feet and inches.
- b. Spans are based on minimum design properties for No. 2 grade lumber of Douglas fir-larch, hem-fir, Southern pine and spruce-pine-fir. No. 1 or better grade lumber shall be used for Southern Pine.
- c. Building width is measured perpendicular to the ridge. For widths between those shown, spans are permitted to be interpolated.
- d. NJ - Number of jack studs required to support each end. Where the number of required jack studs equals one, the header is permitted to be supported by an approved framing anchor attached to the full-height wall stud and to the header.
- e. Spans are calculated assuming the top of the header or girder is laterally braced by perpendicular framing. Where the top of the header or girder is not laterally braced (for example, cripple studs bearing on the header), tabulated spans for headers consisting of 2x8, 2x10, or 2x12 sizes shall be multiplied by 0.70 or the header or girder shall be designed.



2308.5.5.1 Openings in Exterior Bearing Walls



- Single member headers now permitted under conventional light-frame construction provisions of Section 2308
- Typically limited to spans of two to four feet as set forth in Table 2308.4.1.1(1)
- Increases energy efficiency by allowing for a greater thickness of cavity insulation



2308.5.5.1 Openings in Exterior Bearing Walls

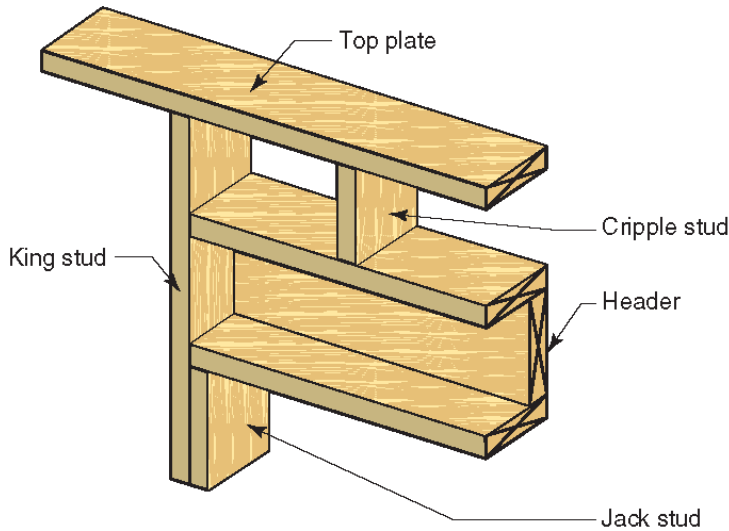

Components of a single member header

© International Code Council

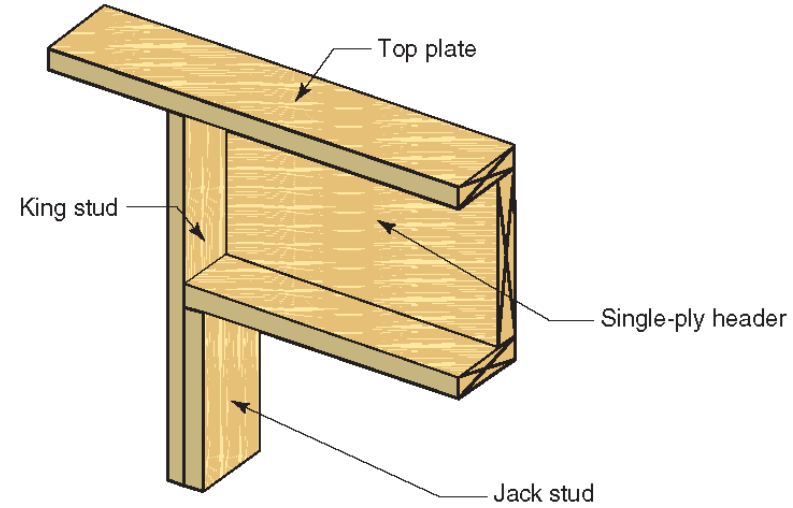

Components of an alternative single member header

© International Code Council





Chapter 24

Glass and Glazing

2407.1 Structural Glass Baluster Panels



- Guards with structural glass baluster panels to be installed with an attached top rail or handrail





Chapter 25

Gypsum Board, Gypsum Panel Products and Plaster



2510.6 Water-Resistive Barrier

- Where a water-resistive barrier is applied over wood based sheathing, a ventilated air space shall be provided between the stucco and water-resistive barrier
 - Applicable in Climate Zones 1A, 2A or 3A
- Provides a means to mitigate the potential for moisture migration into the wall assembly





2510.6 Water-Resistive Barrier

Two-Layer System

- Each layer of water-resistive barrier is individually installed in a ship lapped fashion
- Interior layer forms continuous drainage plane and is integrated with flashing

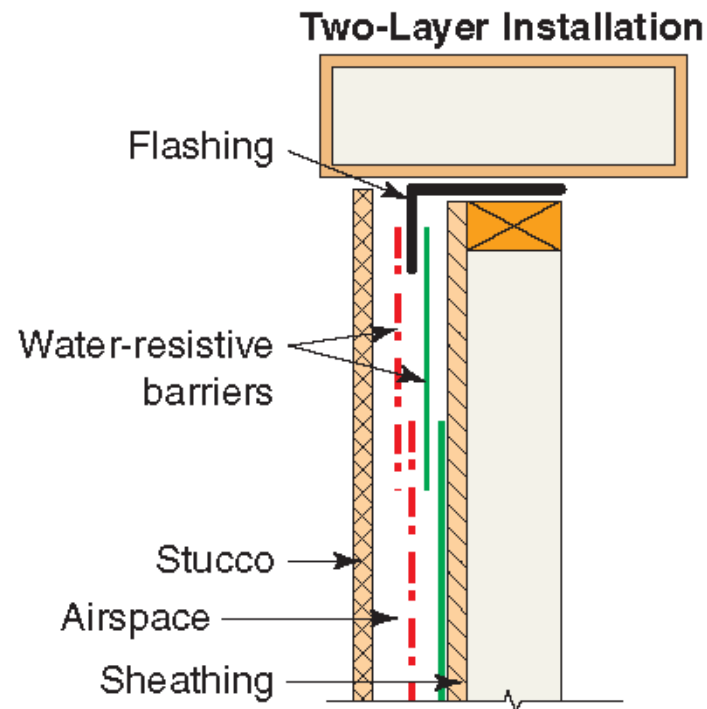

Water-resistive barrier





Chapter 26

Plastic



2603.13 Cladding Attachment over Foam Sheathing to Wood Framing

- IBC now consistent with IRC regarding cladding over foam sheathing and wood framing
- New provisions added addressing both direct attachment and furred cladding attachment

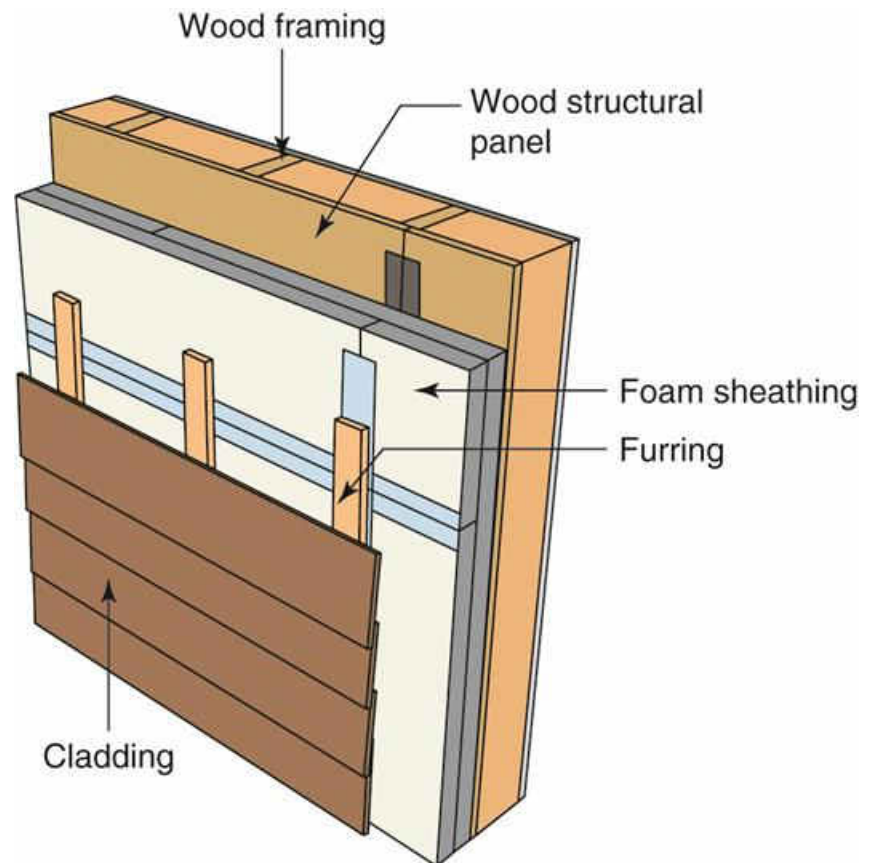



2603.13 Cladding Attachment over Foam Sheathing to Wood Framing

TABLE 2603.13.1 Cladding Minimum Fastening Requirements for Direct Attachment over Foam Plastic Sheathing to Support Cladding Weight^a

Cladding Fastener Through Foam Sheathing into:	Cladding Fastener - Type and Minimum Size ^b	Cladding Fastener Vertical Spacing (inches)	Maximum Thickness of Foam Sheathing ^c (inches)							
			16" o.c. Fastener Horizontal Spacing				24" o.c. Fastener Horizontal Spacing			
			Cladding Weight:				Cladding Weight:			
			3 psf	11 psf	18 psf	25 psf	3 psf	11 psf	18 psf	25 psf
Wood Framing (minimum 1¼ - inch penetration)	0.113" diameter nail	6	2.00	1.45	0.75	DR	2.00	0.85	DR	DR
		8	2.00	1.00	DR	DR	2.00	0.55	DR	DR
		12	2.00	0.55	DR	DR	1.85	DR	DR	DR
	0.120" diameter nail	6	3.00	1.70	0.90	0.55	3.00	1.05	0.50	DR
		8	3.00	1.20	0.60	DR	3.00	0.70	DR	DR
		12	3.00	0.70	DR	DR	2.15	DR	DR	DR
	0.131" diameter nail	6	4.00	2.15	1.20	0.75	4.00	1.35	0.70	DR
		8	4.00	1.55	0.80	DR	4.00	0.90	DR	DR
		12	4.00	0.90	DR	DR	2.70	0.50	DR	DR
	0.162" diameter nail	6	4.00	3.55	2.05	1.40	4.00	2.25	1.25	0.80
		8	4.00	2.55	1.45	0.95	4.00	1.60	0.85	0.50
		12	4.00	1.60	0.85	0.50	4.00	0.95	DR	DR

For SI: 1 inch = 25.4 mm; 1 pound per square foot (psf) = 0.0479 kPa

DR = design required

o.c. = on center

a. Wood framing shall be spruce-pine-fir or any wood species with a specific gravity of 0.42 or greater in accordance with ANSI/AWC NDS.

b. Nail fasteners shall comply with ASTM F 1667, except nail length shall be permitted to exceed ASTM F 1667 standard lengths.

c. Foam sheathing shall have a minimum compressive strength of 15 psi in accordance with ASTM C 578 or ASTM C 1289.





2603.13 Cladding Attachment over Foam Sheathing

TABLE 2603.13.2 Furring Minimum Fastening Requirements for Application over Foam Plastic Sheathing to Support Cladding Weight^{a,b}

Furring Material	Framing Member	Fastener Type and Minimum Size	Minimum Penetration into Wall Framing (inches)	Fastener Spacing in Furring (inches)	Maximum Thickness of Foam Sheathing ^d (inches)								
					16" o.c. Furring ^e				24" o.c. Furring ^e				
					Siding Weight:				Siding Weight:				
3 psf	11 psf	18 psf	25 psf	3 psf	11 psf	18 psf	25 psf						
Minimum 1x Wood Furring ^c	Minimum 2x Wood Stud	0.131" diameter nail	1 1/4	8	4.00	2.45	1.45	0.95	4.00	1.60	0.85	DR	
				12	4.00	1.60	0.85	DR	4.00	0.95	DR	DR	
		0.162" diameter nail	1 1/4	8	4.00	4.00	2.45	1.60	4.00	2.75	1.45	0.85	DR
				12	4.00	2.75	1.45	0.95	4.00	1.65	0.75	DR	DR
		No. 10 wood screw	1	12	4.00	2.80	1.20	0.70	4.00	1.40	0.60	DR	DR
				16	4.00	1.65	0.75	DR	4.00	0.90	DR	DR	
	1/4" lag screw	1 1/2	12	4.00	2.65	1.50	0.90	4.00	1.65	0.80	DR	DR	
			16	4.00	1.95	0.95	0.50	4.00	1.10	DR	DR		
					24	4.00	1.10	DR	DR	3.25	0.50	DR	DR

¹ or ²: 1 inch = 25.4 mm; 1 pound per square foot (psf) = 0.0479 kPa

DR = design required

o.c. = on center

a. Wood framing and furring shall be spruce-pine-fir or any wood species with a specific gravity of 0.42 or greater in accordance with ANSI/APA NDS.

b. Nail fasteners shall comply with ASTM F 1667, except nail length shall be permitted to exceed ASTM F 1667 standard lengths.

c. Where the required cladding fastener penetration into wood material exceeds 3/8 inch (9.5 mm) and is not more than 1 1/4 inches (32 mm), a minimum 2x wood furring or an approved design shall be used.

d. Foam sheathing shall have a minimum compressive strength of 15 psf in accordance with ASTM C 578 or ASTM C 1289.

e. Furring shall be spaced not greater than 24 inches (610 mm) on center in a vertical or horizontal orientation. In a vertical orientation, furring shall be located over wall studs and attached with the required fastener spacing. In a horizontal orientation, the indicated 8-inch (203 mm) and 12-inch (305 mm) fastener spacing in furring shall be achieved by use of two fasteners into studs at 16 inches (406 mm) and 24 inches (610 mm) on center, respectively.





Chapter 30

Elevators and Conveying Systems



3001.2 Emergency Elevator Communication Systems

- Two-way communication system to be visual text-based, video-based and live interactive
- Accessible to individuals who are deaf, hard of hearing and speech impaired





3006.2.1 Corridors Adjacent to Elevator Hoistway Openings

- Hoistway openings to be protected where corridors to be fire-resistance-rated per Section 1020.1

Opening protection to be:

- Enclosed elevator lobby, or
- Additional door(s), or
- Pressurization of hoistway

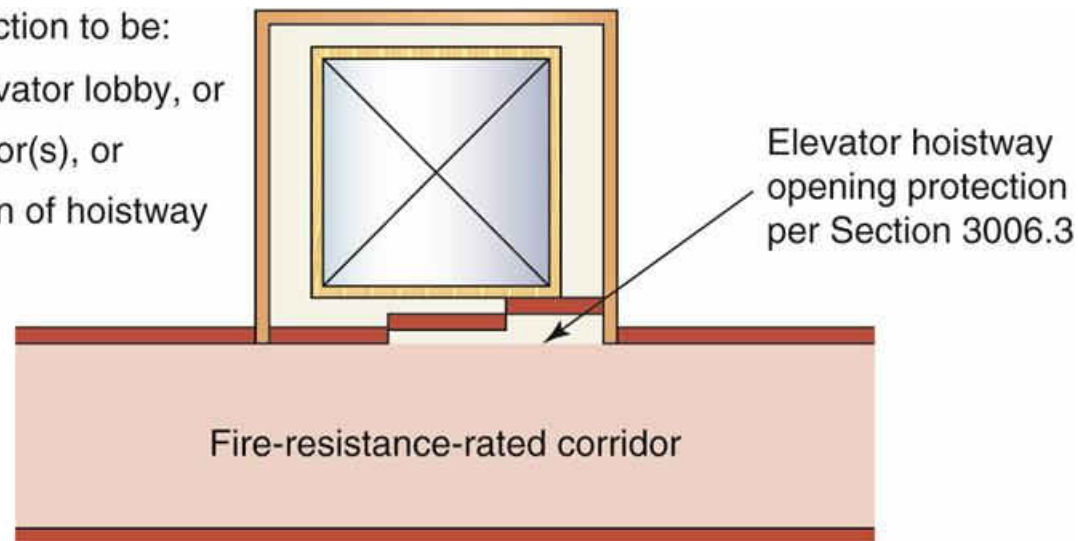



3007.1 Extent of Fire Service Access Elevator Travel

- Only floors at and above lowest level of fire department vehicle access need to be served by fire service access elevators
- Not required for elevators that only serve parking garage and lobby levels

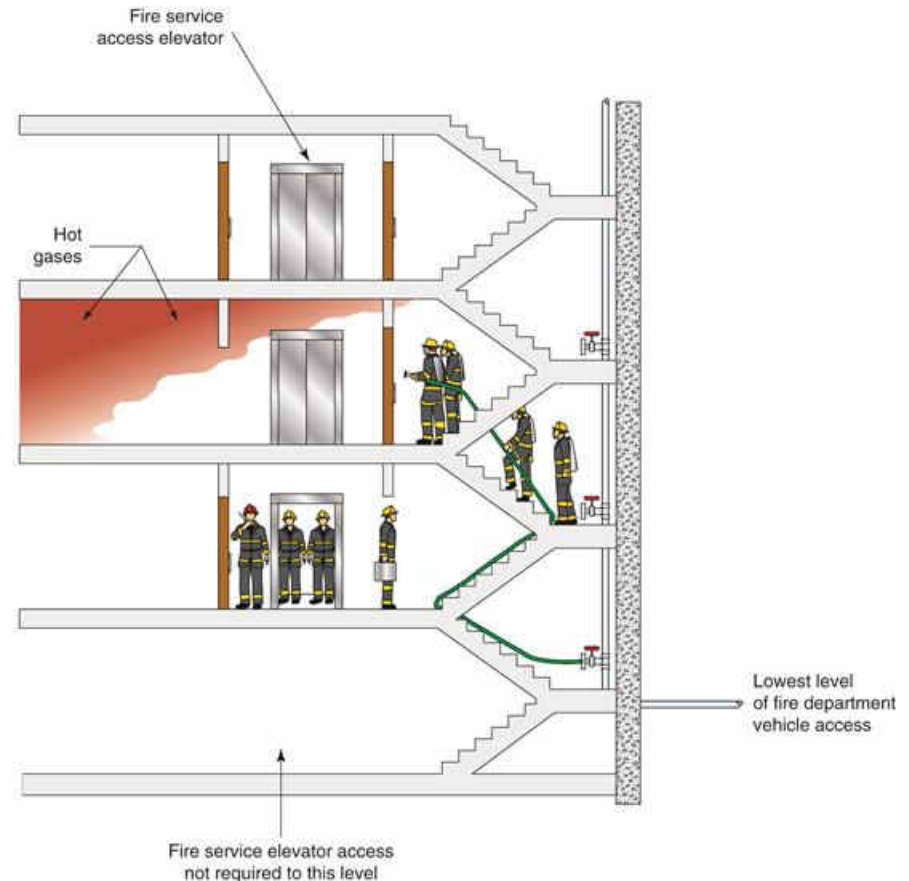



3008.1.1 Required Number of Occupant Evacuation Elevators

- Minimum number of required occupant evacuation elevators based on one of two egress scenarios
 - Full building evacuation in less than 1 hour, or
 - Evacuation of 5 consecutive floors with highest accumulated occupant load in less than 15 minutes



3008.1.1 Required Number of Occupant Evacuation Elevators

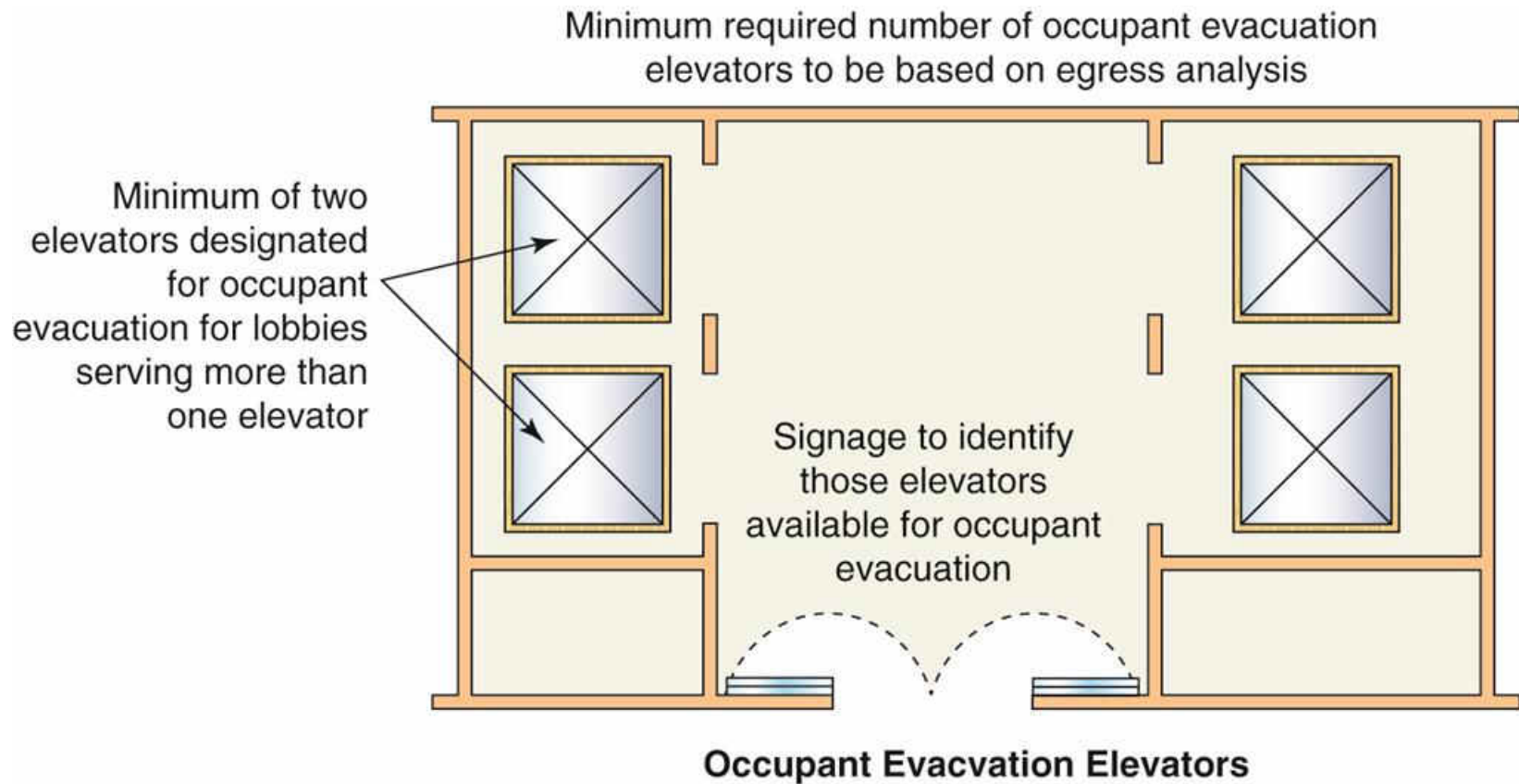



Chapter 31

Special Construction



3112 Relocatable Buildings

- Compliance required as for new construction
- Provisions address:
 - Supplemental information
 - Manufacturer's data plate
 - Inspection agencies





Chapter 33

Safeguards During Construction



Fire Safety During Construction and Demolition

Section 3310 – Means of Egress

Section 3311 – Standpipes

Section 3312 - Automatic Sprinkler System

Section 3314 – Fire Watch



3310.1 Stairways in Buildings under Construction

- Stairway to be provided where building construction exceeds 40 feet above lowest level of fire department vehicle access
- As construction progresses, stairway to extend within one floor of highest point with secured decking/flooring



Means of Egress – Section 3310

- **Stairway Required [3310.1]**
- Building construction exceeds 40-feet in height above the lowest level of fire department vehicle access(LLFDVA).
- Temporary or permanent stairway to be provided.
- As construction progresses stairway to be extended to within one floor of the highest point of construction having secured decking or flooring.



Means of Egress – Section 3310

- **Maintenance of Means of Egress [3310.2]**
- Means of egress and required accessible means of egress to be maintained at all times during construction, demolition, remodeling or alterations and additions to any building.
- Exception: Existing means of egress need not be maintained where approved temporary means of egress systems and facilities are provided.



Standpipes – Section 3311

- **Where Required [3311.1]**
- Buildings required to have standpipes by Section 905.3.1
- Not less than one standpipe shall be provided for use during construction.
- Standpipes shall be installed prior to construction exceeding 40 feet in height above the lowest level of fire department vehicle access.



Standpipes

- Standpipe shall be provided with fire department hose connections at accessible locations adjacent to usable stairways.
- Standpipe shall be extended as construction progresses to within one floor of the highest point of construction having secured decking or flooring.



Standpipes

- **Buildings Being Demolished [3311.2]**
- Building being demolished and a standpipe is existing within such a building.
- Standpipe shall be maintained in an operable condition so as to be available for use by the fire department.
- Standpipe shall be demolished with the building but shall not be demolished more than one floor below the floor being demolished.



Standpipes

- **Detailed Requirements [3311.3]**
- Standpipes shall be installed in accordance with the provisions of Section 905.
- Exception: Standpipes shall be:
 - Either temporary or permanent in nature
 - With or without a water supply
 - Provided standpipes comply with the requirements of Section 905 as to capacity, outlets and materials.



Automatic Sprinkler System

- **Completion Before Occupancy [3312.1]**
- Buildings where an automatic sprinkler system is required by IFC or IBC, it shall be unlawful to occupy any portion of a building or structure until the automatic sprinkler system installation has been tested and approved, except as provided in Section IBC 11.3 or IFC 105.3.4.



Automatic Sprinkler System

- **Operation of Valves [3312.2]**
- Operation of sprinkler control valves shall be allowed only by properly authorized personnel.
- Shall be accompanied by notification of duly designated parties.
- Where the sprinkler protection is being regularly turned off and on to facilitate connection of newly completed segments, the sprinkler control valves shall be checked at the end of each work period to ascertain that protection is in service.





3314 Fire Watch During Construction

- Fire watch can be required by fire code official
 - Provided during non-business hours
 - Applicable where construction exceeds 40 feet above lowest adjacent grade



Video – Fire Safety During Construction - Dramatic Rescue





Appendix G

Flood-Resistant Construction



G103.6 Watercourse Alteration

- Applicant to notify all “adjacent” government jurisdictions rather than just those ‘affected’
- Now consistent with NFIP regulations



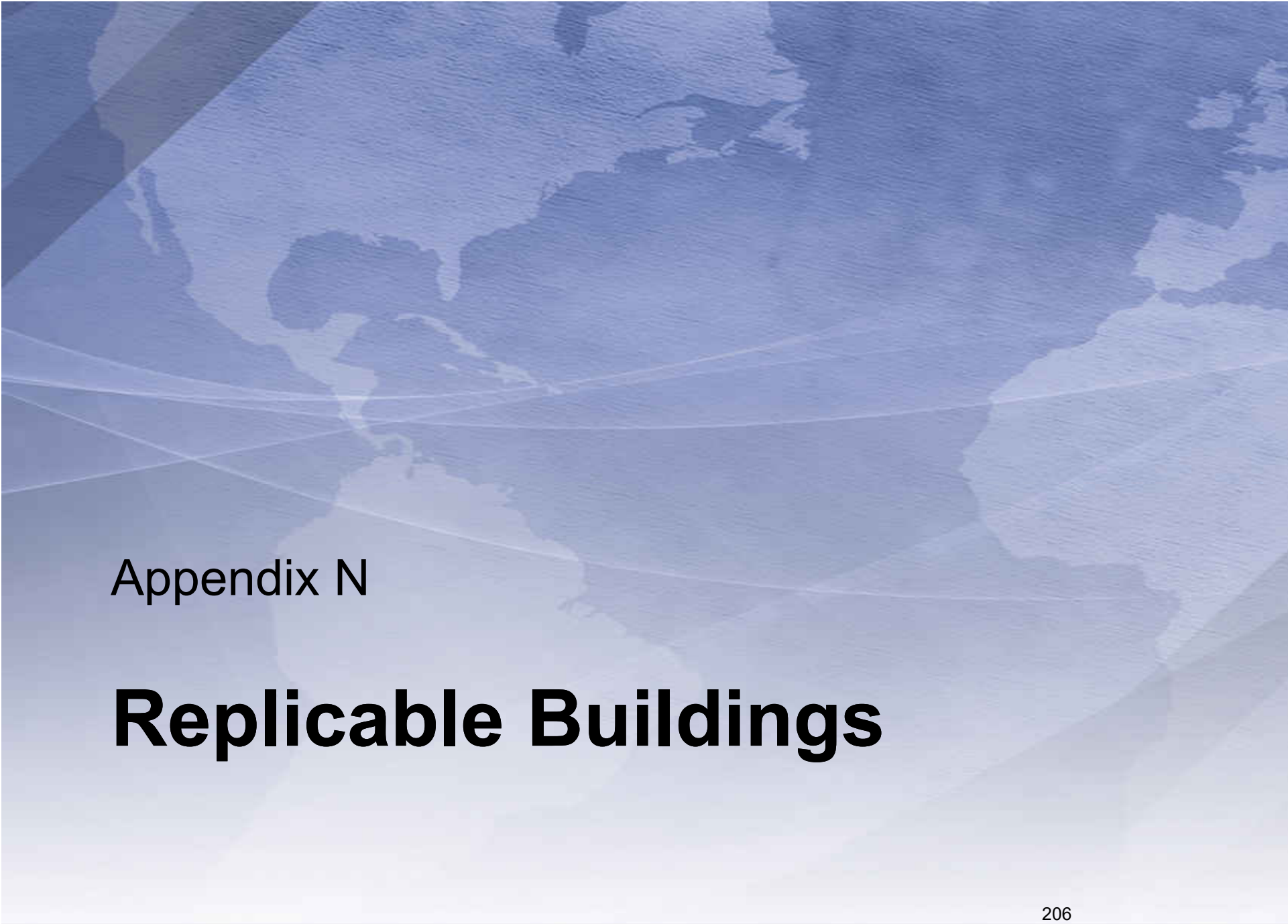

Appendix N

Replicable Buildings



Appendix N Guidelines for Replicable Buildings

- Based on ICC Guideline G1
- Benefits include:
 - More uniform review process
 - Elimination of repetitive reviews
 - Reduces time between permit submittal and construction mobilization



Discussion Activity





Use and Occupancy Classification

- Directions:
 1. You will be divided into groups.
 2. Within your groups classify the following occupants.
 3. Discussion.





1. Cell Phone Tower





2. Insurance Office



2015 IBC Fire and Life Safety Principles

211

LEARNING
center



3. Steel Fabrication Plant





4. Local Grade School





5. Hospital





6. Bank





7. Juvenile Detention Center





8. Oil and Lube Shop





9. Convenience Store





10. Multiplex Theater





11. Canopy Over Pump Island





12. Bleachers at Football Field





13. Auto Body Shop





14. Open Parking Garage



2015 IBC Fire and Life Safety Principles

223



What information is required to properly classify the following?

15. Kitchen Serving a Restaurant





What information is required to properly classify the following?





What information is required to properly classify the following?

17. Facility Used to Care for Children





What information is required to properly classify the following?

18. Dance Studio for Children





What information is required to properly classify the following?

19. Private Garages for Condominiums





What information is required to properly classify the following?

20. Self-storage Facility





What information is required to properly classify the following?

21. Dental Office





What information is required to properly classify the following?





What information is required to properly classify the following?

23. Fast Food Carry-out





What information is required to properly classify the following?

24. Assisted Living Facility





Final Reflection

This slide will help the learner to reflect on the day and what they will take back to the job and apply.

- **What?** What happened and what was observed in the training?
- **So what?** What did you learn? What difference did this training make?
- **Now what?** How will you do things differently back on the job as a result of this training?



International Code Council is a Registered Provider with The American Institute of Architects Continuing Education Systems. Credit earned on completion of this program will be reported to CES Records for AIA members. Certificates of Completion for non-AIA members are available on request.

This program is registered with the AIA/CES for continuing professional education. As such, it does not include content that may be deemed or construed to be an approval or endorsement by the AIA of any material of construction or any method or manner of handling, using, distributing, or dealing in any material or product. Questions related to specific materials, methods, and services will be addressed at the conclusion of this presentation.



Copyright Materials

This presentation is protected by US and International Copyright laws. Reproduction, distribution, display and use of the presentation without written permission of the speaker is prohibited.

© International Code Council 2017



Thank you for participating

To schedule a seminar, contact:

The ICC Training & Education Department
1-888-ICC-SAFE (422-7233) Ext. 33818

or

E-mail: Learn@iccafe.org



← 2018 IBC Significant Changes

→ 237

LEARNING
center