

Los Angeles Basin Chapter 2019 Inspection Training Matrix Inspection of Trusses

Jay Elbettar, PE, CBO, LEED-AP, CASp

June 5th 2019



Trusses' Review and Inspection



- This class is intended to provide insight to one of the most commonly used products in our market: roof and floor trusses.
- Products included in this presentation are for educational purposes only. Effort was made to not show preference for one product or brand over another. Each product is a registered trade mark of each respective organization.
- Products, design and installation is always subject to the approval by the Authority Having Jurisdiction.
- Some of the details in this class may be new even for the most seasoned inspectors and contractors.
- This information is presented for educational purposes in hope for proper installation and more consistent application of the building code.

Outline



- Load Basics
- Roof Trusses
- Truss Drawings
- Roof Truss Bracing Standards
- Connections: Hangers, Braced Wall, Ply-To-Ply
- Framing Details
- Floor Trusses
- Deck Connections to Trusses
- Sill Plate Overhang
- Tips for Inspection Efficiency



Prescriptive Design



- The 2016 California Residential Code is based on the 2015 International Residential Code (IRC)
- The IRC is a prescriptive design, or like a cookbook. It tells you the required load, and how to address it.
- Designs beyond the scope of IRC should be examined by a registered design professional.

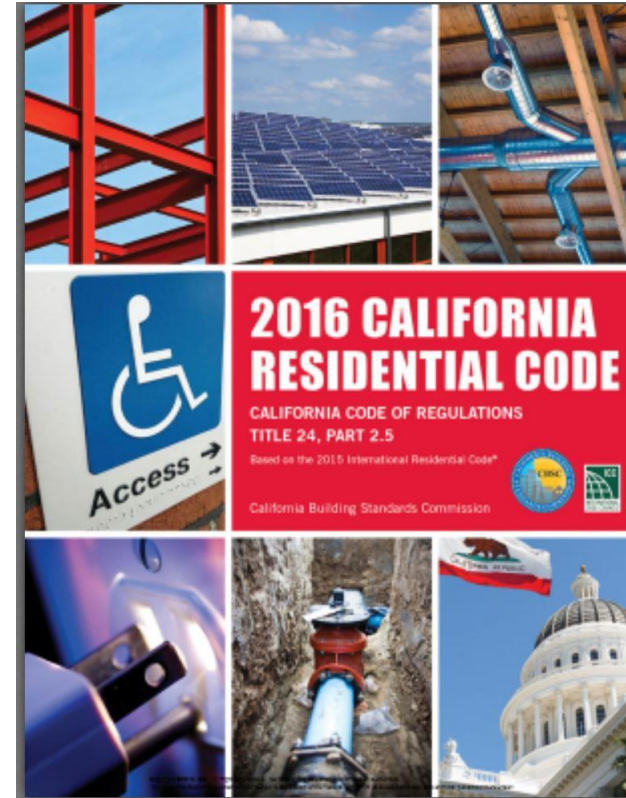

Why a class on trusses?



- To ensure proper design and installation of trusses to prevent “failure.”
- Failure does not always mean the house falls down.
- Failure can be if floors have excessive bounce, drywall cracks occur, or any number of related issues.
- For contractors preventing failure mean less callbacks and happier consumers.



Summary of Responsibilities



- ANSI/TPI “Truss Plate Institute”, is the referenced document for trusses and it identifies responsibilities for owner, building designer, contractor, manufacture, and the truss designer and other.
- **Owner** shall engage a Building Designer and Contractor. In some cases the Building Designer is a Registered Design Professional. If a RDP is not required in that jurisdiction, the owner assumes the responsibilities of the RDP.
- **Building Designer** is to prepare construction documents and show in detail that the building code has been met. This includes specifying all loads, anchorage, connections, and other details.

Summary of Responsibilities



- **Contractor** is the intermediary between the Truss Manufacturer and Building Designer. Contractor is responsible to review and forward truss submittal packages over to building designer, or owner for review and approval.
- Contractor is also to install the trusses, install temporary and permanent bracing, confirm trusses are built per drawings, and report any truss damage to get engineered repairs.

Summary of Responsibilities



- Lastly the **Truss Designer** is responsible to create truss drawings based off the construction documents.
- Truss Drawings shall show information such as building code, design loads, pitch, span, and additional information.
- Engineered “Sealed” Drawings represent acceptance of responsibility of a **single truss** if it is built and installed correctly.



The Basics: Loads

- R301.1 Application
- Buildings and structures, all parts thereof, shall be constructed to safely support all loads, including dead loads, live loads, roof loads, flood loads, snow loads, wind loads and seismic loads as prescribed by this code. The construction of buildings and structures in accordance with the provisions of this code shall result in a system that provides a complete load path that meets all requirements for the transfer of all loads from their point of origin through the load-resisting elements to the foundation. Buildings and structures constructed as prescribed by this code are deemed to comply with the requirements of this section.



The Basics: Dead Loads



- Dead Load: Loads that are part of the building. This is the self-weight of the building material with no other loads applied. Weight of framing, plywood, gypsum, shingles, and other finish materials.

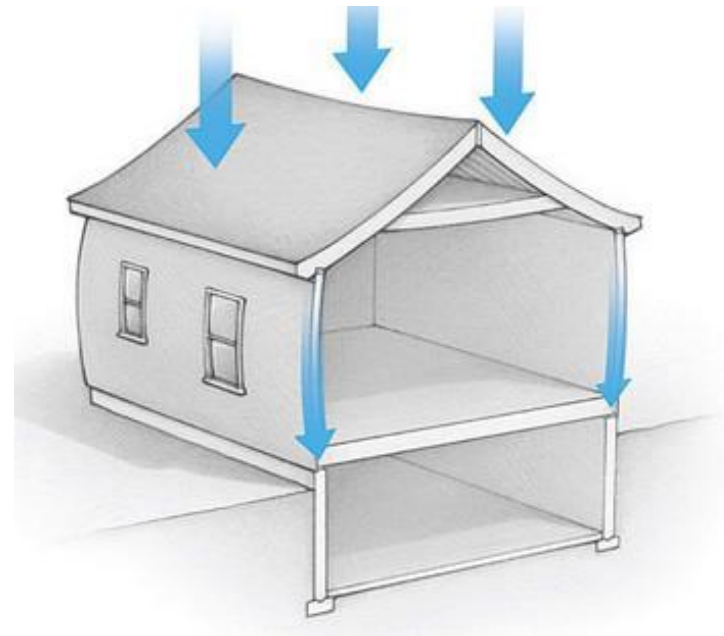

The Basics: Live Loads



- Live Load: This is the weight of people, furniture, appliances, etc. It has been described as such: If you could pick up a house and shake it upside down, the live load items would fall out.
- Top chord live load is controlling case of live vs snow per R301.6.

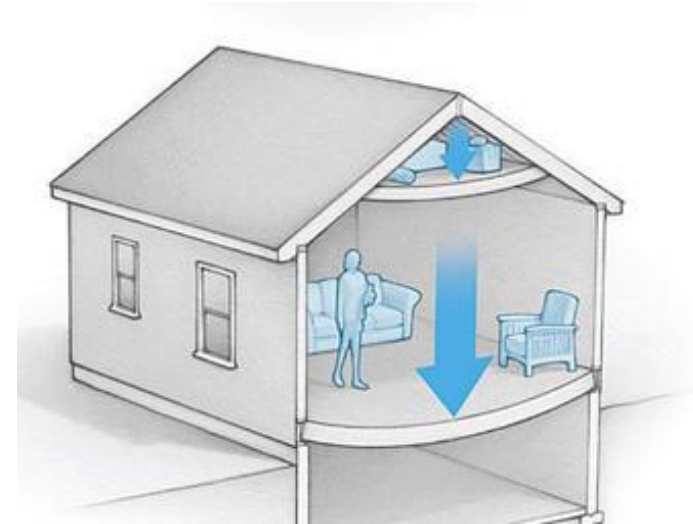



The Basics: Lateral Loads

- Lateral loads are loads that come from the side.
- Three two types of lateral load:
 - Wind loads
 - Soil pressure (acting on foundation walls)
 - Seismic loads
- Lateral loads are addressed by wall bracing in Chapter 6 and foundation wall reinforcement in Chapter 4 of the code.
- Seismic and flood loading are beyond the scope of this course.

The Basics: Putting it Together



- A typical structure is being pushed, pulled, twisted in many more ways than just down.
- If the design follows IRC, we have prescriptive methods to account for these loads.

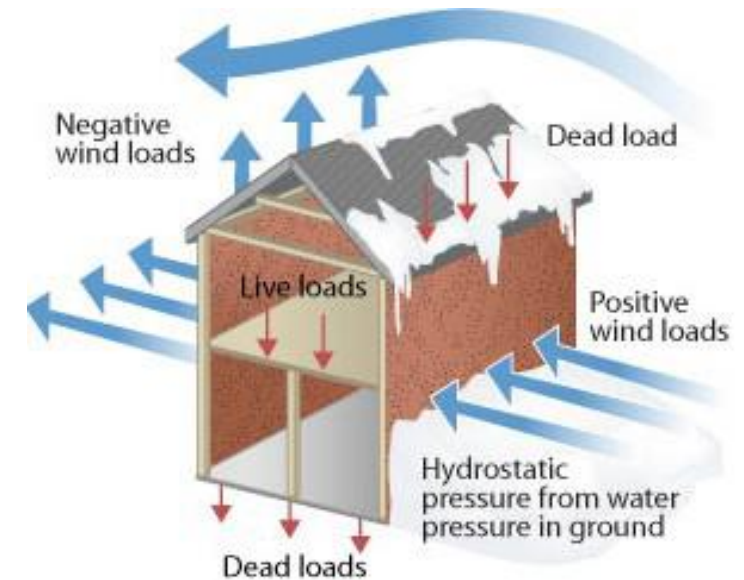



The Basics: Prescriptive Loads

- Table R301.5. will provide the minimum design loads for floors, garages, stairs and more.
- Weights are provided in PSF or Pounds per Square Foot.

Use	Live Load
Sleeping Rooms	30 psf
Rooms other than sleeping rooms	40 psf
Balconies/Decks	40 psf

The Basics: Pounds Per Square Foot



- What is PSF? It is the load spread out over a 1' x 1' area. Picture blocks that are 1' x 1' packed on a floor, each weighing 40#. That is the minimum live load for rooms other than sleeping rooms.

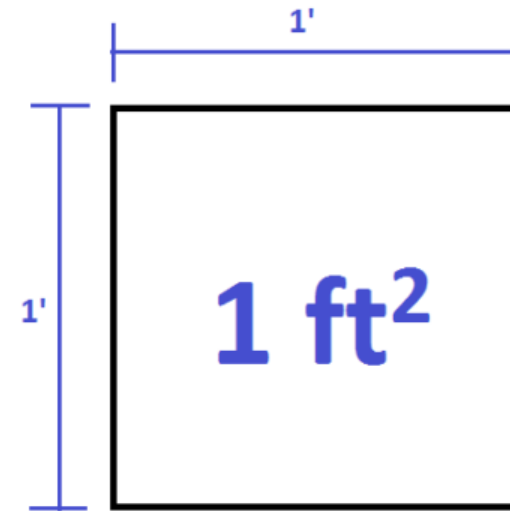

The Basics: PLF Loads



- You will often hear of PLF or Pounds per Linear Foot when it comes to beams, or girders. In this example the beam here is supporting 400plf live and 150plf dead.
- Combined total load of 550plf.

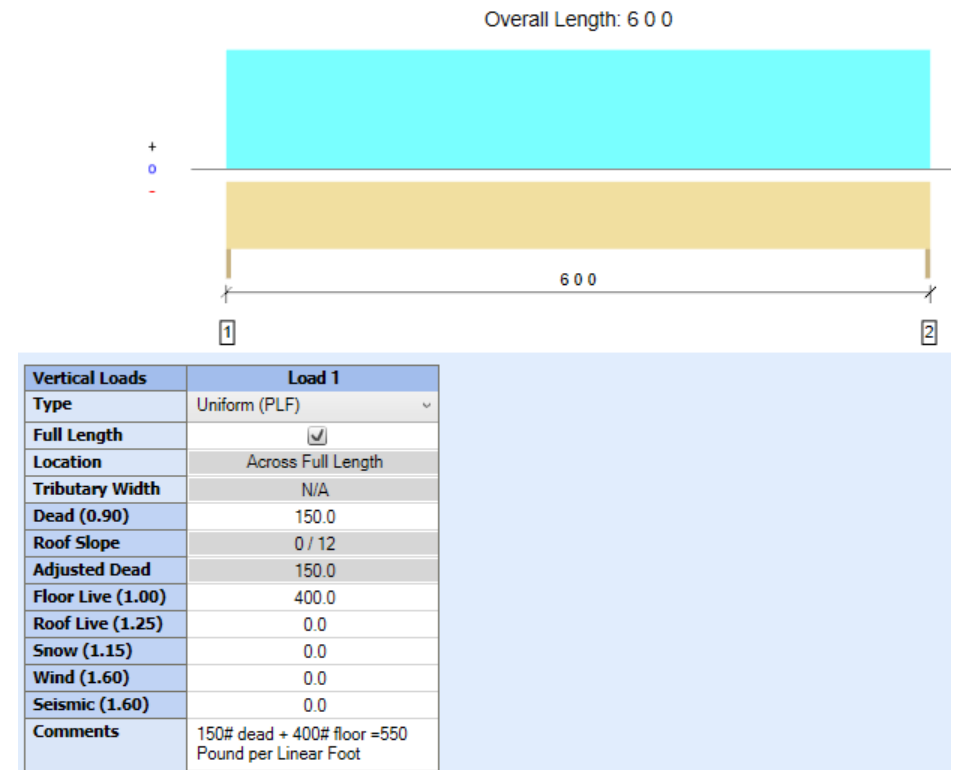

The Basics: Tributary Load



- Tributary load is “area of responsibility” for a structural member.
- We can find the tributary load based on location of supports like bearing walls or beams.

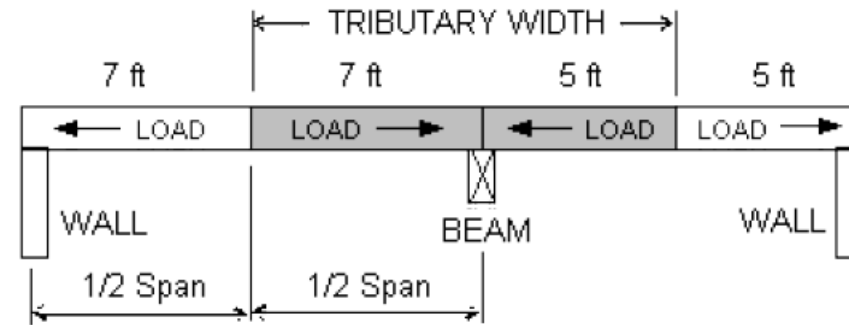

The Basics: Tributary Load



- This example the center beam is 14' from one wall and 10' on the other. If we split each span by two bearing points, and add them up the result is the trib.
- $7' + 5' = 12'$ tributary load supported by center beam.

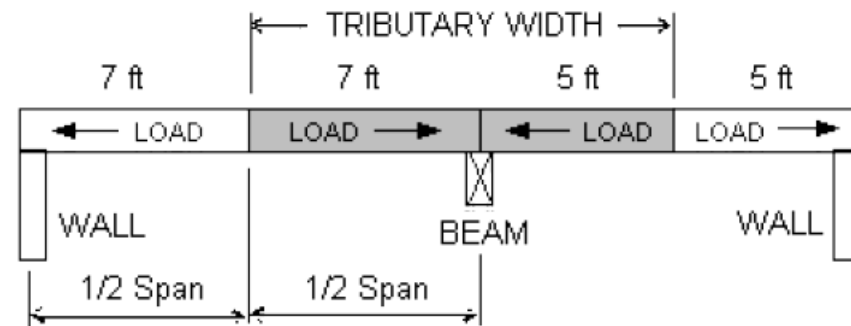



The Basics: PSF to PLF

- How we convert PSF to PLF is pretty simple. This beam supports 4' trib. We multiply 4 by the 100PSF load.
- Beam A supports $(4 \times 100) = 400\text{plf}$.

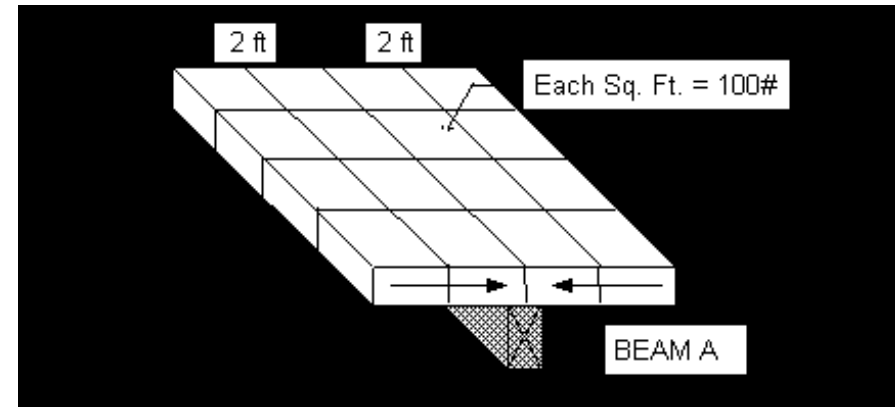

The Basics: Uniform Load - load equally applied across the length of structural member



Uniform Load Equation

Uniformly Distributed Load

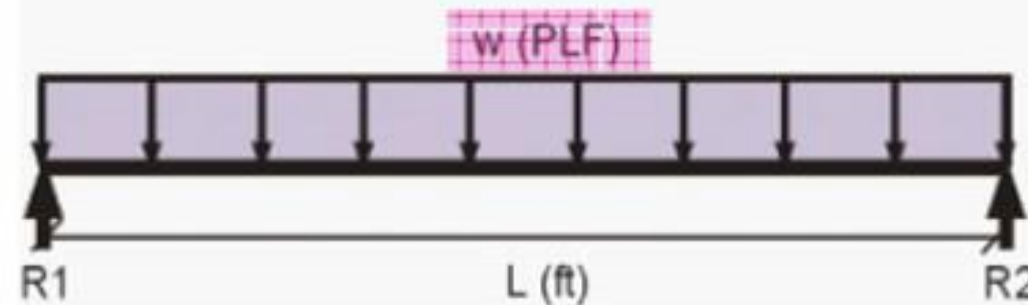

$$R_1 = R_2 = \frac{w \times L}{2}$$

$$\text{Total Load} = w \times L$$

The Basics: Reaction/Point Load



- When we hear of the term “reaction” it is the resulting load at the bearing point of a beam or girder. Back to our 550plf beam. It is 6' long and bearing at 2 points resulting in 1650# reaction.
- $550\text{plf} \times 6' = 3300\#$
- $3300\# / 2 \text{ bearing points} = 1650\#$

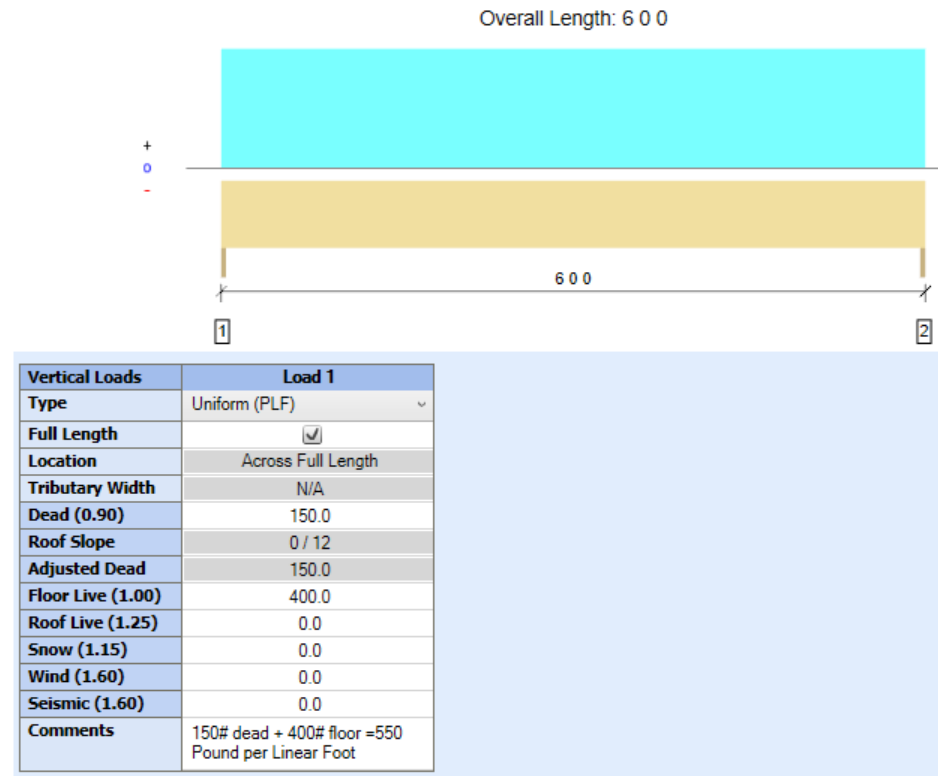



The Basics: Load Path

- The reaction is also called a point load, or concentrated load.
- We need to verify that the material supporting the reaction is strong enough to transfer the load down to the footing.



The Basics: Load Path



- Remember responsibilities:
 - The Building Designer would specify what supports a girder reaction.
 - In absence of a designer, it is the owners responsibility.
 - As building officials it is up to us make sure all loads are addressed.
 - Truss designers generally do not design columns, ledgers, or other details.



Continuous Span for Increased Performance



MEMBER REPORT *Level, Floor: Joist*

1 piece(s) 11 7/8" TJI® 210 @ 12" OC

Overall Length: 30 0 0

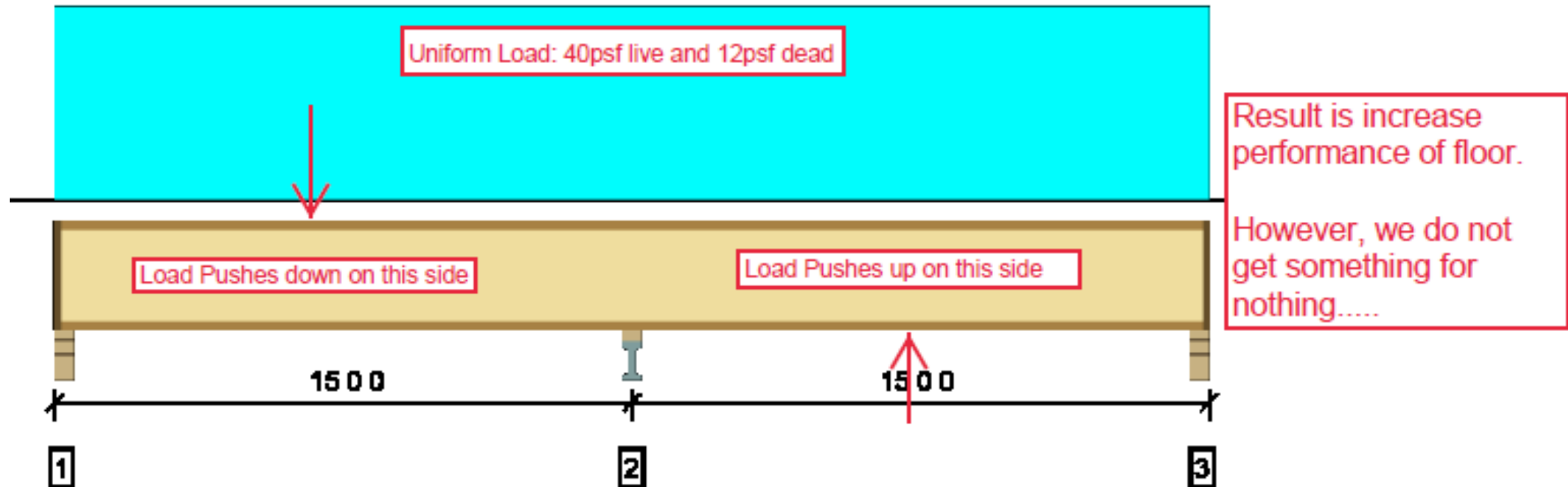



Continuous Span Load Increase

1 piece(s) 11 7/8" TJI® 210 @ 12" OC

Overall Length: 30 0 0

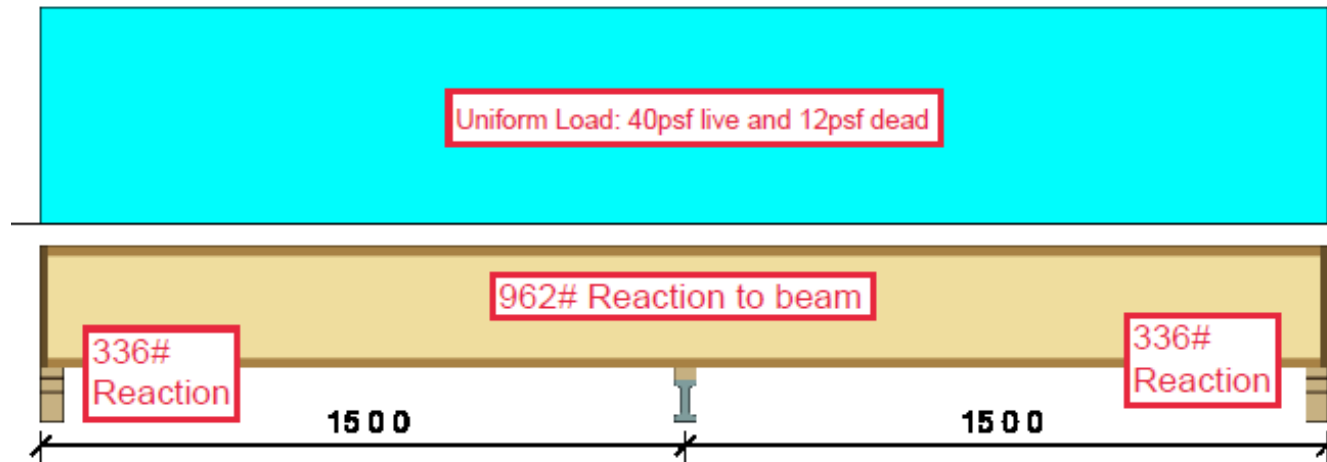

- In the example above we do not get to take half the distance from each bearing point (7.5 trib + 7.5 trib = 15' x 52psf = 780plf to center beam).
- In reality the center beam will carry approximately 25% more load. $780\text{Plf} + 25\% = 975\text{plf} \pm$ (Actual was 962plf)



Continuous Span Load Increase

1 piece(s) 11 7/8" TJI® 210 @ 12" OC

Overall Length: 30 0 0

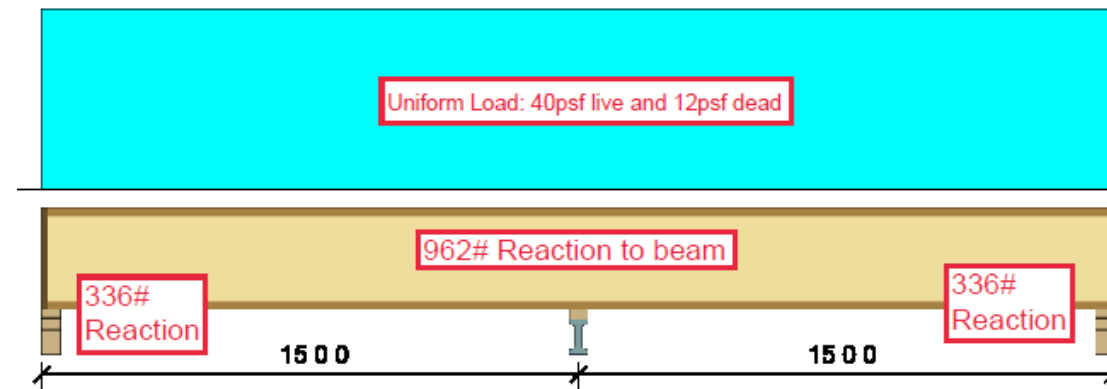

- This load increase may not have a big impact on short headers. However, the reactions of a long span beam can change everything under it.
- This all depends on if the floor designer splits the framing on the center beam or runs the framing continuous over the top of the beam. We do not know until we verify with the truss layouts.



Load Duration Factor: Overview

- Wood can hold different amounts of load for different amounts of time.
- Generally floor load, 100% load duration factor is a starting point and can be modified as needed.
- Dead is most restrictive as it is always applied, while wind and seismic are least restrictive as they are applied for the shortest amount of time.
- Important for connections.

Dead (0.90)
Roof Slope
Adjusted Dead
Floor Live (1.00)
Roof Live (1.25)
Snow (1.15)
Wind (1.60)
Seismic (1.60)



Load Duration Factor: Overview

- This is why Roof Live and Snow loads are different. The Roof Live is a construction load. Because construction occurs for a short term over the life of the truss it can hold 25% more than if it was a floor load that was always supporting people.
- Snow Load is on a roof longer than construction materials and is more restrictive than the roof live construction loading.

Dead (0.90)
Roof Slope
Adjusted Dead
Floor Live (1.00)
Roof Live (1.25)
Snow (1.15)
Wind (1.60)
Seismic (1.60)

Roof Trusses



Gravity: no matter what, it always wants to pull objects down toward the Earth. Loads come from the top of a house and fall down to what is below.

For that reason, we will start at the top of the house with roof trusses.

Here we will cover how to verify loads, review truss drawings, bracing methods, truss connections and other details.



Roof Truss Types

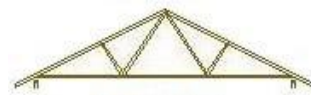

COMMON

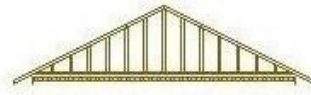

REGULAR GABLE

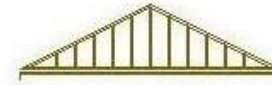

DROP GABLE

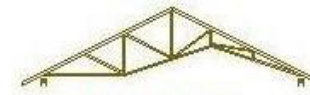

CATHEDRAL

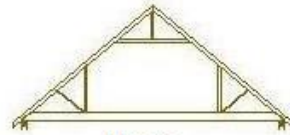

ATTIC

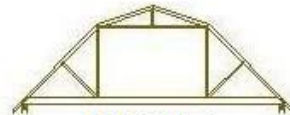

GAMBREL

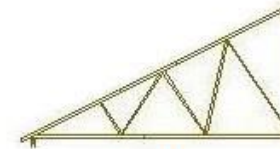

MONO

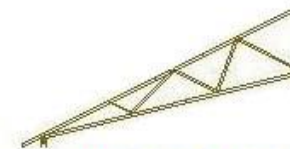

MONO SCISSOR

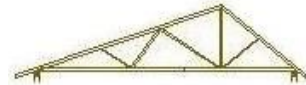

DUAL PITCH

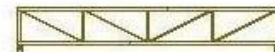

FLAT

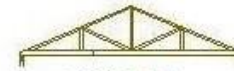

GIRDER

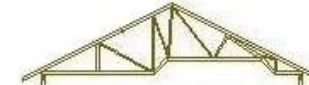

TRAY

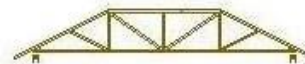

HIP

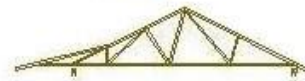

PORCH



SCISSOR



PITCH TOP CHORD FLAT

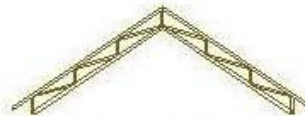

PARALLEL CHORD

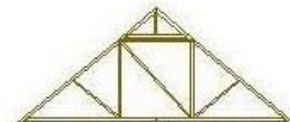

CAPPED TRUSS



HIP FRAME



VAULT

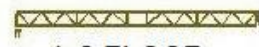

4x2 FLOOR

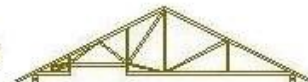

COFFER

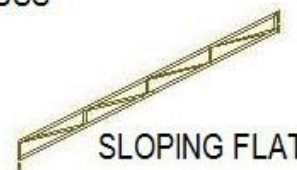

SLOPING FLAT

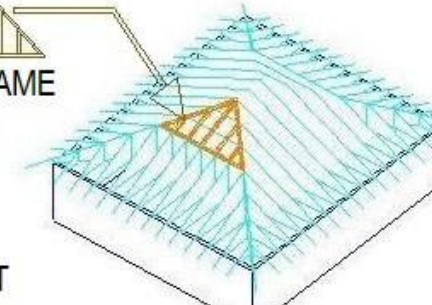

STRUCTURAL END

Roof Truss Engineering



- Trusses have stamped engineering, why do I need to worry about them?
- Recall responsibilities: The Engineered stamp is for acceptance of a **Single Truss**.
- Yes, the design may have been reviewed by an engineer, but that engineer will only verify if the truss will support the loads as provided to them by the truss designer. The engineer **does not** check to see the information provided to them is correct.

Roof Trusses



- For example lets say that a girder truss is to support 26' long roof trusses. $26' / 2$ bearing points = 13' trib. Assuming 55psf total load the result would be $(13' \times 55) = 715\text{plf}$. If the truss designer accidentally types 71plf the truss will only be designed for the 71plf. The engineer will stamp the truss saying “yes, it can indeed support 71plf”, even though it is severely undersized for how it is to be used.
- **The engineer does NOT look at the plan, layout, or trusses as a “system”, but only one component (truss drawing) at a time.**

Roof Trusses



- For this reason, on complicated structures, It is critical for truss drawings and layouts to be submitted prior to issuance of the building permit.
- Drawings should be reviewed by the Plans Examiner for girder point loads, and verify if any deviation from the plan occurred. If so, do we have a complete load path of headers and columns to get loads to foundation?
- The same plan can be given to two different designers in the same office and you can get two vastly different designs. Perhaps it was due to something on the plan not working, or perhaps the designer found a more profitable design than what was planned for.

Roof Trusses: Plan Review



- Items to look for in plan review:
- Missing loads on load bearing cantilevers
- Hangers that are undersized for the load
- Hangers that require particular lumber size to work, but was not included in the design
- Allowable deflection exceeds that of finish material (cracked tile)
- Girder/point loads in different locations than shown on the plan
- Rake overhangs greater than allowable

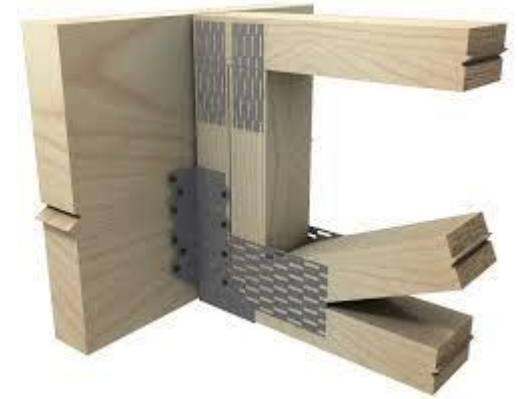

Plan Review



- Plan review is the time to catch these bigger items if possible.
- Cheaper for builder/truss supplier to identify deficiencies on paper prior to construction of the trusses than after being installed.
- It avoids delays while waiting for new trusses or engineered repairs.
- Avoids “well, you approved the plan” conversations in the field.

Parts of a Truss

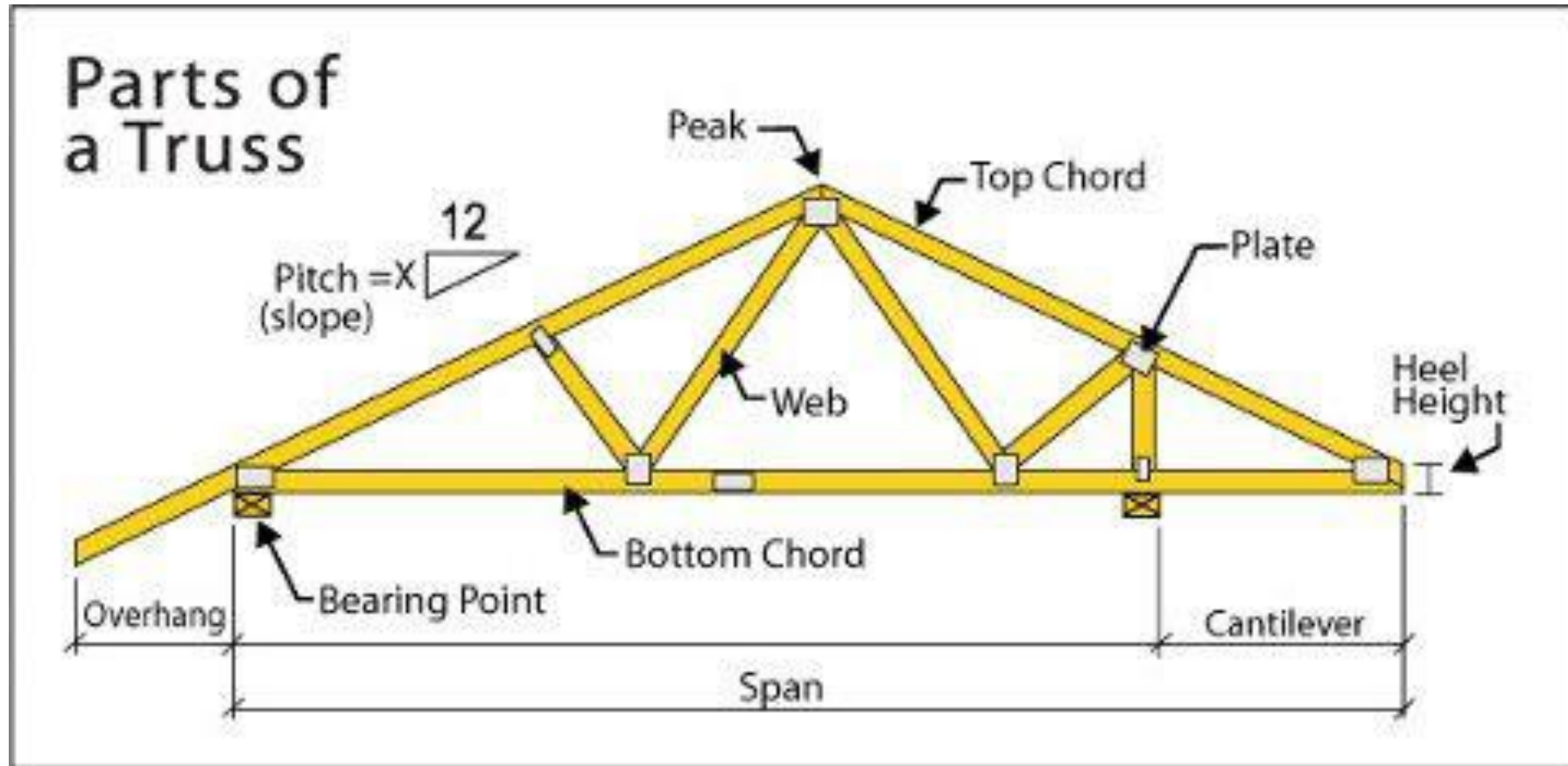

Truss Drawings



- Truss notation is in Feet-Inches-Sixteenths 7- 11-4 = 7' 11-1/4"
- Joint locations are numbered clockwise starting at left heel.
- Bearing points are noted by joint location for some drawings, but not by all. You will see the make up of the plates, or a reaction at a bearing point.

Roof Truss Drawing



Scale = 1:77.5

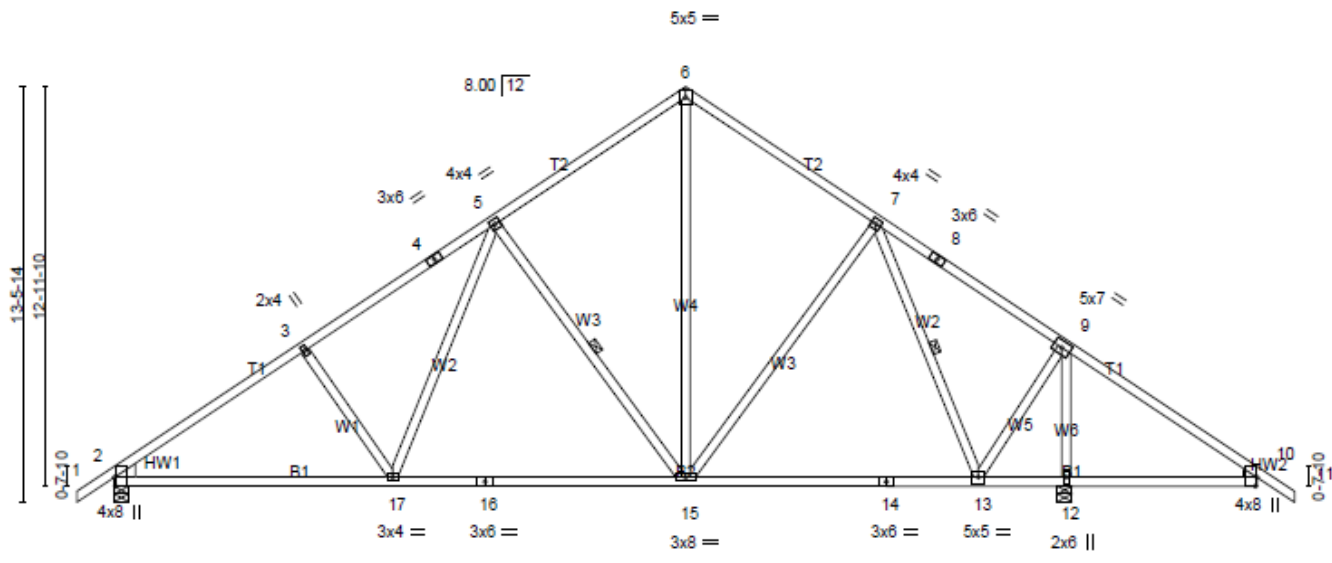

Plate Offsets (X,Y)-- [2:0-3-8,Edge], [10:0-3-8,Edge]	
9'-0-4	9'-0-4
18'-6-0	9'-5-12
27'-11-12	9'-5-12
31'-0-0	3'-0-4
37'-0-0	6'-0-0

LOADING (psf)	SPACING-	2-0-0	CSI.	DEFL.	in (loc)	l/defl	L/d	PLATES	GRIP	
TCLL 35.0	Plate Grip DOL	1.15	TC 0.71	Vert(LL)	-0.15	13-15	>999	240	MT20	197/144
TCDL 7.0	Lumber DOL	1.15	BC 0.69	Vert(TL)	-0.41	13-15	>906	180		
BCLL 0.0	Rep Stress Incr	YES	WB 1.00	Horz(TL)	0.06	12	n/a	n/a		
BCDL 10.0	Code MNSRC2015/TPI2007		(Matrix)							
										Weight: 172 lb FT = 20%

LUMBER-
 TOP CHORD 2x4 SPF No.2
 BOT CHORD 2x4 SPF No.2
 WEBS 2x4 SPF No.2 *Except*
 W1,W5,W6: 2x4 SPF Stud
WEDGE
 Left: 2x6 SPF No.2, Right: 2x4 SPF Stud

BRACING-
 TOP CHORD Structural wood sheathing directly applied or 3-3-4 oc purlins.
 BOT CHORD Rigid ceiling directly applied or 6-0-0 oc bracing.
 WEBS 1 Row at midpt 5-15, 7-13

MiTek recommends that Stabilizers and required cross bracing be installed during truss erection, in accordance with Stabilizer Installation guide.

REACTIONS. (lb/size) 2=1627/0-5-8 (min. 0-2-9), 12=2419/0-5-8 (min. 0-3-13)
 Max Horz 2=-203(LC 6)

Roof Bracing and Design Standards

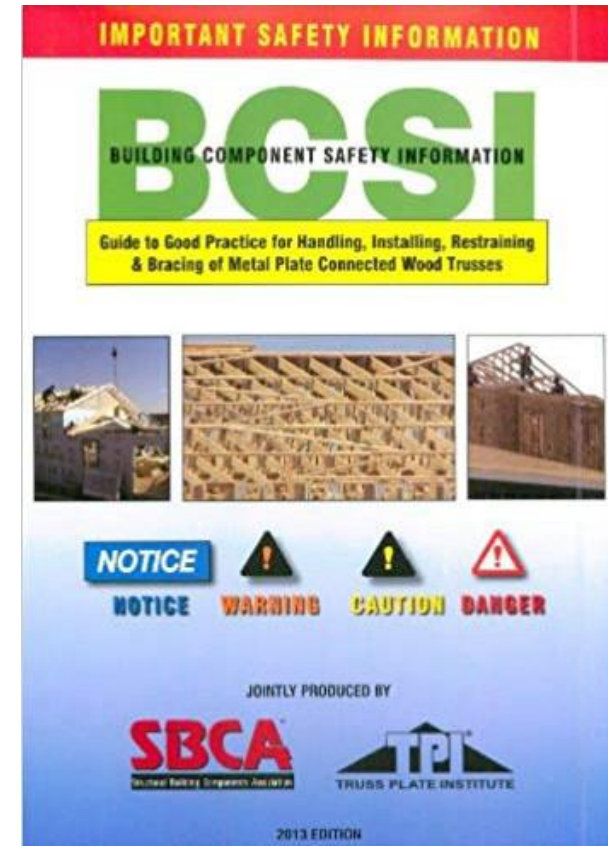
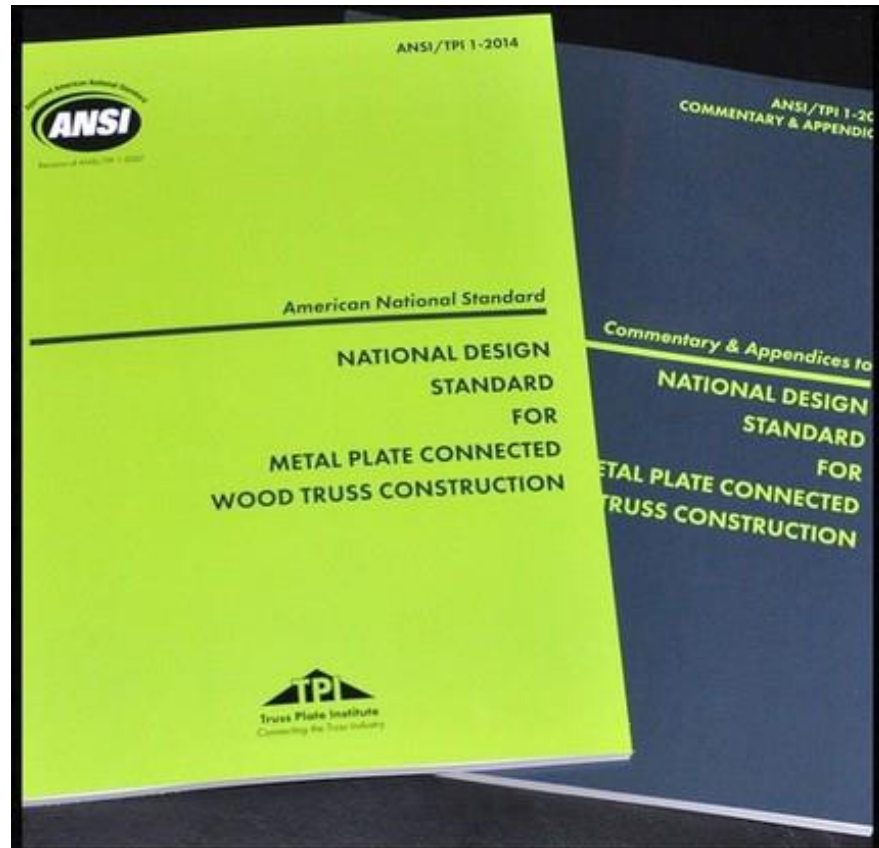

Truss Bracing applicability in the CRC



- **R802.10.2 Design.** Wood trusses shall be designed in accordance with accepted engineering practice. The design and manufacture of metal-plate-connected wood trusses shall comply with ANSI/TPI 1. The truss design drawings shall be prepared by a registered *design* professional.
- **R802.10.3 Bracing.** Trusses shall be braced to prevent rotation and provide lateral stability in accordance with the requirements specified in the construction documents for the building and on the individual truss design drawings. In the absence of specific bracing requirements, trusses shall be braced in accordance with accepted industry practice such as the SBCA *Building Component Safety Information (BCSI) Guide to Good Practice for Handling, Installing & Bracing of Metal Plate Connected Wood Trusses*.

Roof Bracing and Design Standards



- There is a free read only versions of the BCSI and ANSI TPI online.
- **Installation and Bracing Standard BCSI**
http://support.sbcindustry.com/docs/06_bcsi_booklet_final.pdf
- **TPI Design Standard**
<https://www.tpinst.org/news/2016/3/1/now-available-free-read-only-version-of-theansitpi-1-2014-standard>

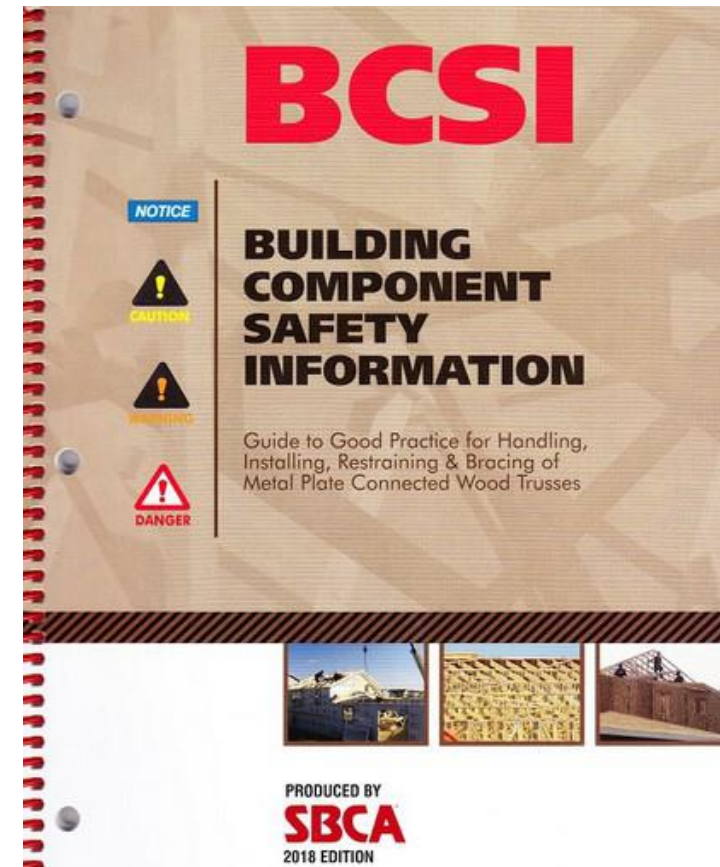

Roof Bracing and Design Standards



- Because this class is aimed at building inspectors we are going to focus on Permanent Truss Bracing.
- Contractors should also be familiar with Temporary Truss Bracing, the bracing to keep trusses from collapsing during installation.

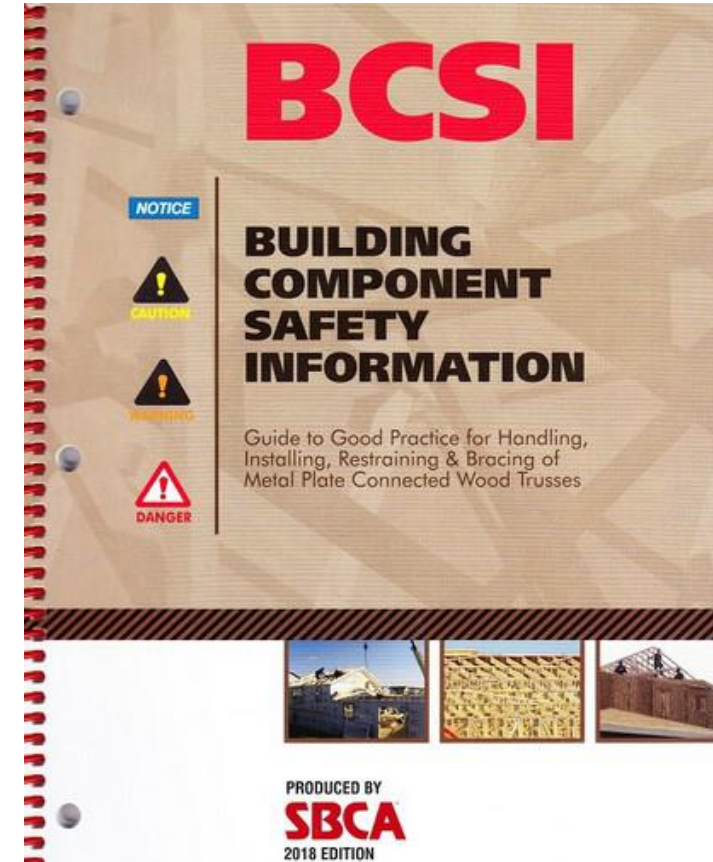

Roof Truss: Bracing



- Each truss is unique and has different requirements. Review each drawing carefully.
- Truss Design Drawing (TDD) provides critical information on bracing of chords and webs.
- Recall: R802.10.2 states truss design shall comply with ANSI/TPI 1
- Recall: R802.10.3 states SBCA's BCSI is the referenced standard for truss bracing for prescriptive (non-engineered) means.
- Not all bracing is noted graphically on the drawings.

Web Bracing



- When bracing is required it is often shown on the drawing in the form an X with a box around it similar to what is shown to the right. Some webs may require two braces.

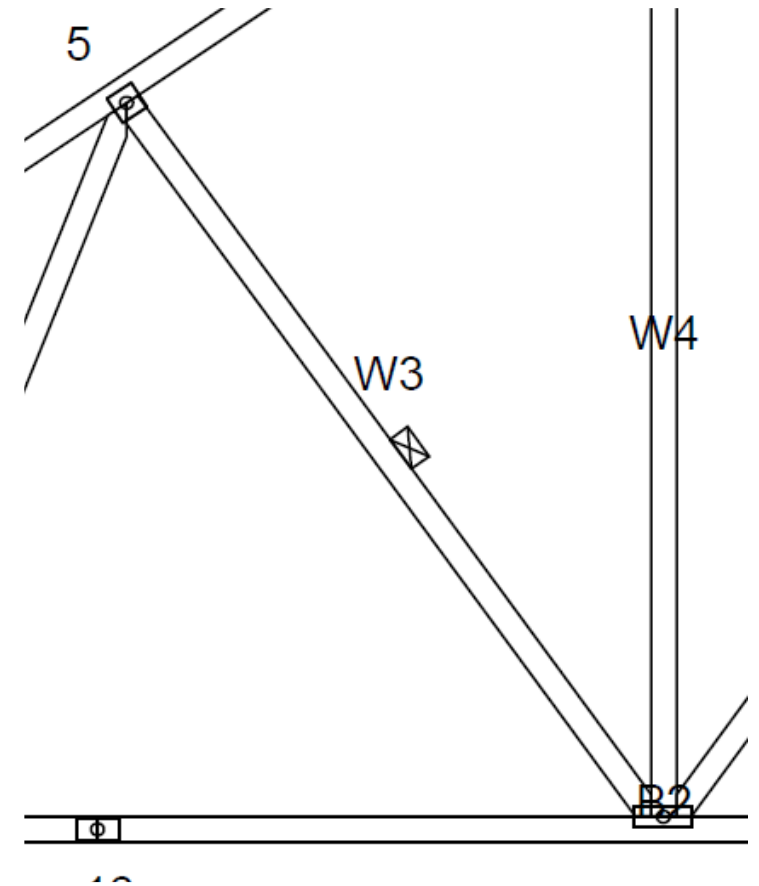

Web Bracing



- ☒ Web bracing required at each location shown.
Refer to BCSI for proper required lateral restraint. For alternative web bracing, see ITWBCG's standard details.
- ↳ Designed per ANSI/TPI 1-2007

The bracing notes on this truss drawing also specifies the use of the BCSI.

Chord Bracing



- Truss chords can be braced with sheathing or purlins. Notice the bottom chord of this truss needs purlins 6' o.c. (Purlins being a form of lateral restraint such as a catwalk/ratrun) if no gypsum is applied to underside.

BRACING-
TOP CHORD
BOT CHORD
WEBS

Structural wood sheathing directly applied or 3-3-4 oc purlins.

Rigid ceiling directly applied or 6-0-0 oc bracing.

1 Row at midpt 5-15, 7-13

Chord Bracing



- A contractor may dispute the bottom chord bracing requirements on a commercial job because “it is not shown in the picture”. At inspection cross reference the diagram with written bracing requirements noted on the drawing. I will often note this on reviewed plans for inspectors to verify bottom chord bracing in unfinished garages that are not getting gypsum.

BRACING-

TOP CHORD

Structural wood sheathing directly applied or 3-3-4 oc purlins.

BOT CHORD

Rigid ceiling directly applied or 6-0-0 oc bracing.

WEBS

1 Row at midpt

5-15, 7-13

Top Chord Bracing



- The purlin spacing will be noted on the truss drawing and sometimes shown on the illustration as well. What is the purlin spacing below between joints 5-8? 2-0-0. The 3-5-6 is max temporary bracing.

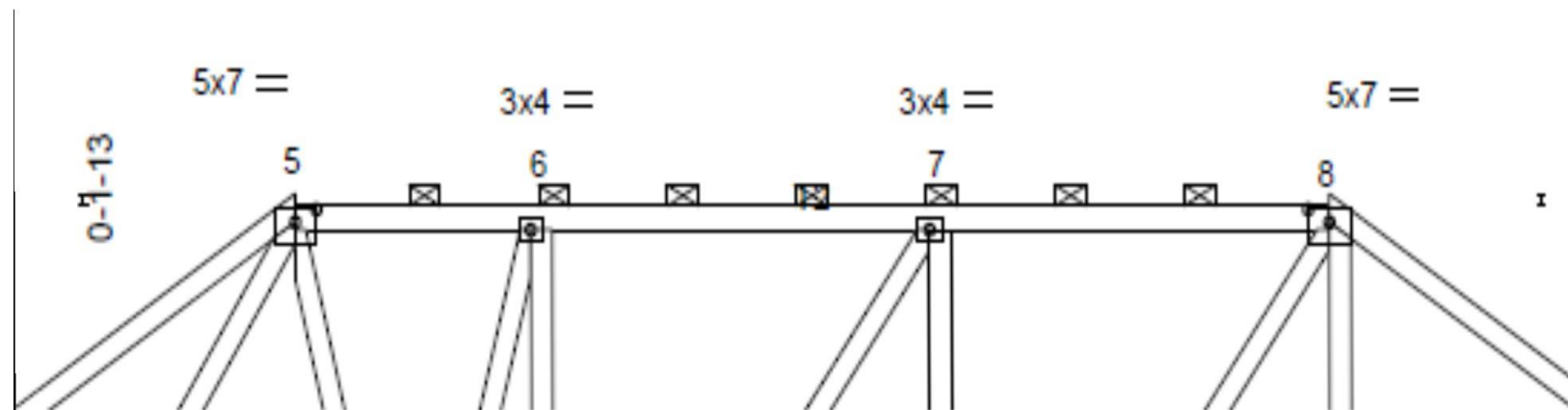

BRACING- TOP CHORD

Structural wood sheathing directly applied or 2-10-5 oc purlins, except 2-0-0 oc purlins (3-5-6 max.): 5-8.

Top Chord Bracing



- Most truss top chords are braced by the roof sheathing.
- Step-down hipsets, piggyback trusses may provide challenges.
- Note that the top chord lateral brace in green also includes an angle brace in red.

Certain sizes or shapes of Trusses require some assembly at the jobsite. Refer to the Truss Design Drawings (TDD) for specific instructions on assembly methods, unless the Construction Documents indicate otherwise. The Contractor is responsible for proper field assembly.

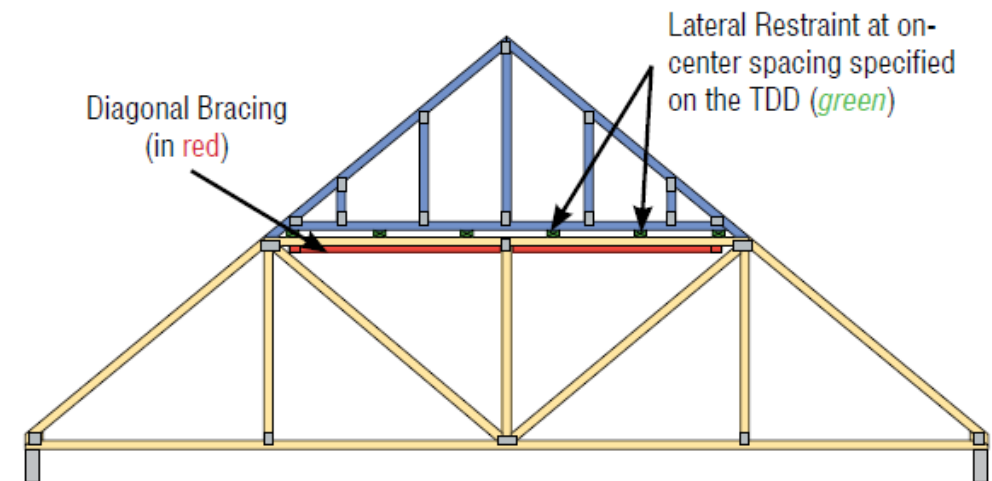
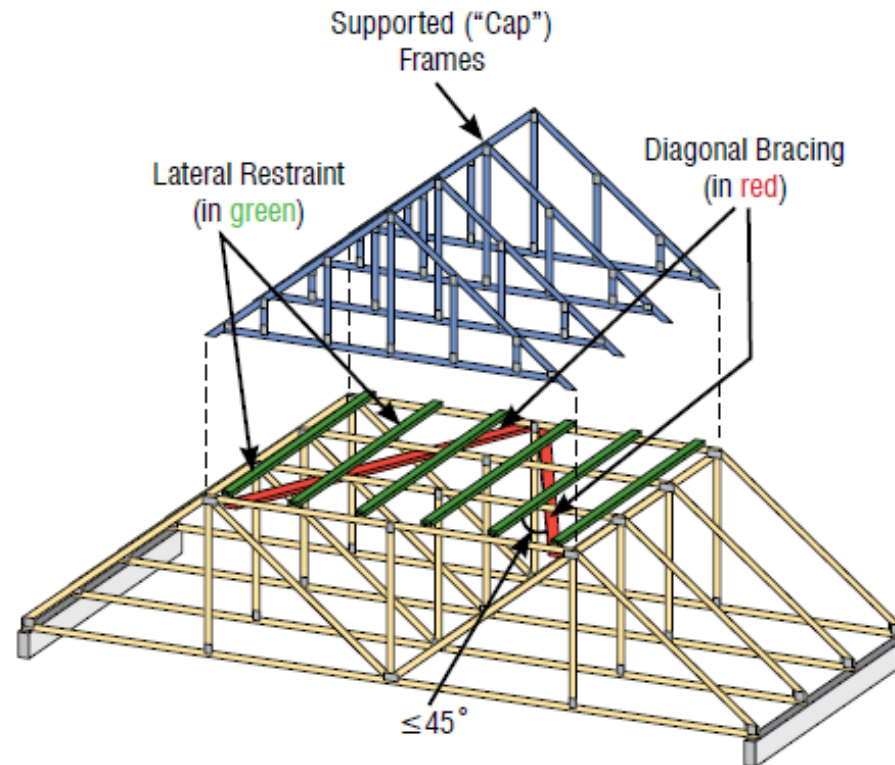

FIGURE B2-51



Piggyback Details



Note: Some Lateral Restraint and Diagonal Bracing not shown for clarity.

FIGURE B2-52

Chord Bracing per BCSI



- At right we see in the BCSI the max spacing of bottom chord bracing is 10' o.c. OR direct attached ceiling.
- As truss spans increase so do the bracing requirements.
- Remember: requirements of BCSI are code requirements per R802.10.3 unless specified by an engineer.

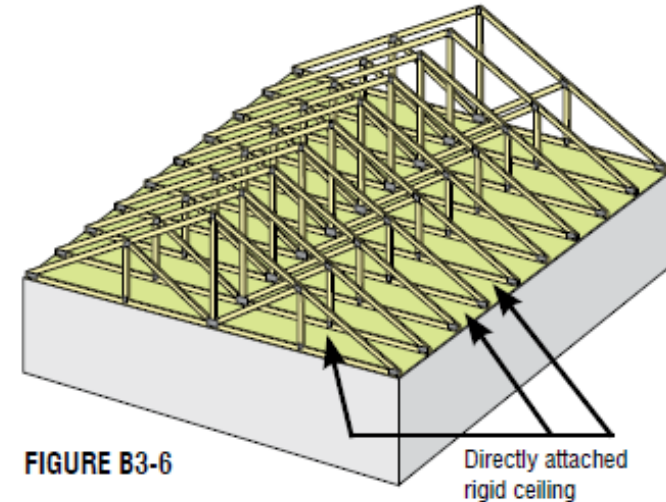

FIGURE B3-6

- ✓ Lumber used as Lateral Restraint and/or Diagonal Bracing shall be stress rated.
- ✓ Bottom Chord Permanent Lateral Restraint shall be installed at the spacing indicated on the TDD and/or by the Building Designer with a maximum of 10' on-center.

Improper Chord Brace





Improper Chord Brace



- This truss had an engineer stamp.
- Stamped drawing was accepted **with the required** bracing. But bracing was not provided and impossible to install due to design depth.
- Had the flat truss top matched the floor depth, it could have been easily braced by subfloor.





Improper Chord Brace

- This same bracing principal applies to beams. Here the manufacture states the max unbraced length should be checked. Top, or compression edge of beams and trusses need to be braced.

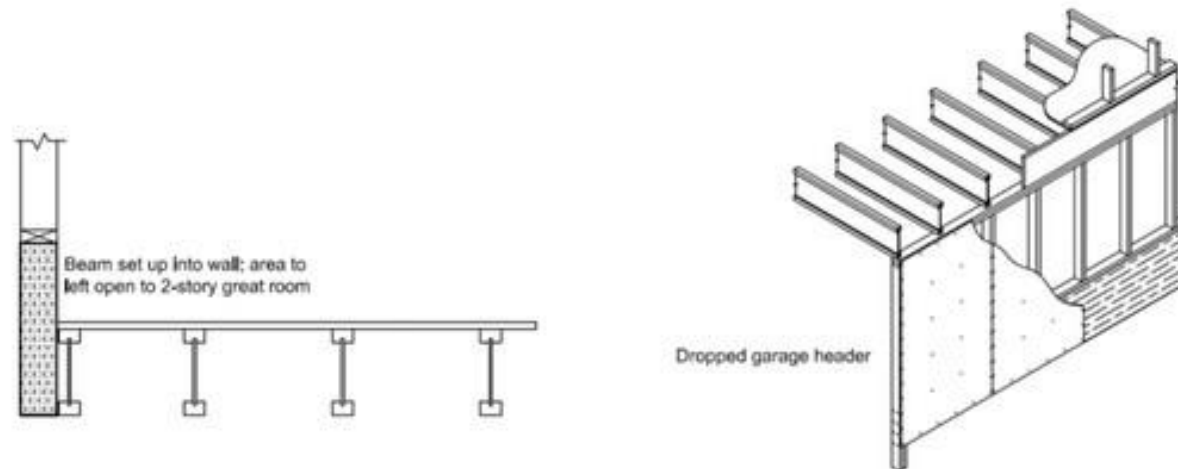

The maximum unbraced length (L_u) must be checked when framing conditions do not continually brace a beam.

Continuous Lateral Restraint



- The lateral brace should be 2x4 at chords. Span over all alike trusses. Ideally at least 12' long lumber.
- CLR should cross over 2 or more trusses at a splice, or if spliced on a single truss a 24" splice block should be installed.

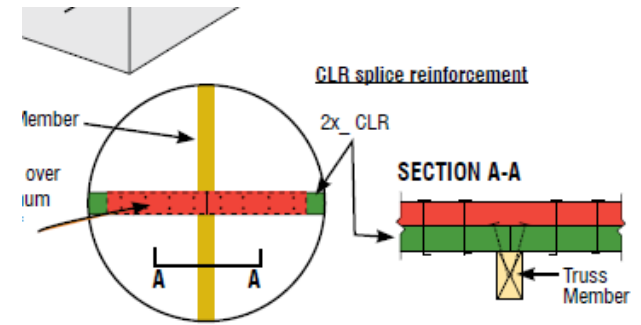
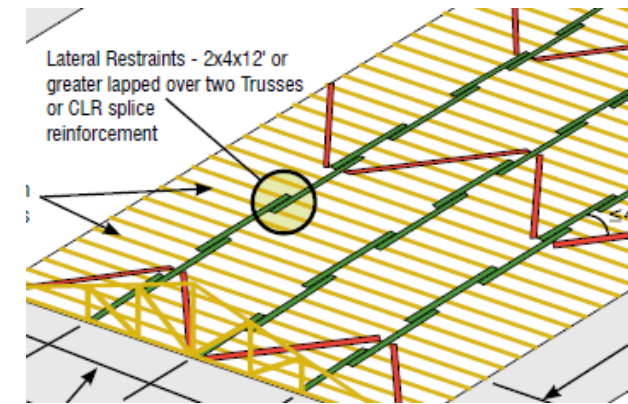

Continuous Lateral Restraint



- The angle brace needs to occur every 10 truss spaces or 20' max: this applies to both chord, and web restraints.

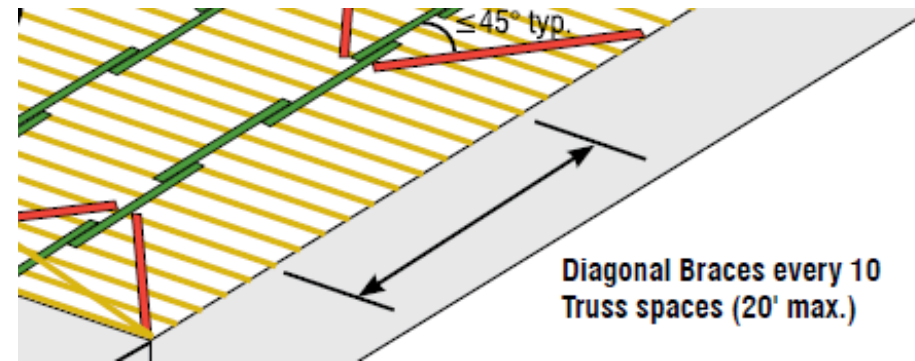

Lateral Restraint lapped over two Trusses or CLR splice reinforcement. Refer to Figure B3-7 for more information.

FIGURE B3-11

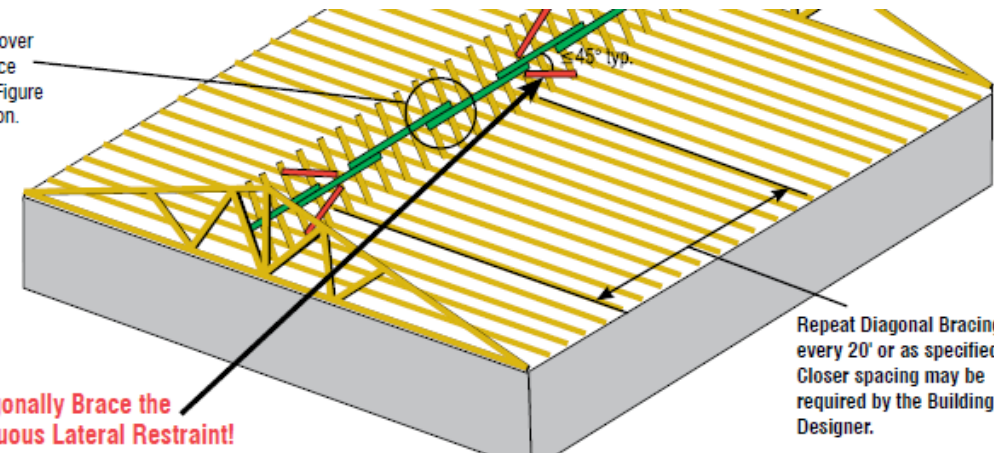

Always Diagonally Brace the Permanent Continuous Lateral Restraint!

Repeat Diagonal Bracing every 20' or as specified. Closer spacing may be required by the Building Designer.

Diagonal bracing is also required for temporary lateral restraint as well to prevent buckle of all members at simultaneously as shown below



Thank you!

