



**Alumil**  
Building excellence every day

**Alumil**  **SUPREME**  
**S650 PH0S**



# CONTENTS

## **SUPREME S650 PHOS**

DESIGN PHILOSOPHY & CHARACTERISTICS	4
TECHNICAL CHARACTERISTICS	6
SENSE OF FREEDOM	8
ATTENTION TO DETAIL	10
THE ABSOLUTE MINIMAL DESIGN	12
FOCUS ON SAFETY	14
SECTIONS	16
STIFFENERS	34
GLAZING TYPES	35
INSTALLATION	36
APPLICATIONS	46
TABLE OF PERFORMANCE	47
REFERENCE PROJECTS	48



**SUPREME S650 PHOS**  
is the ideal choice for sliding  
windows with wide glazing surfaces  
mounted in aluminium frames  
that are totally flush  
to the ceiling and the floor.

**PHOS** means **LIGHT**

*"Architecture is the learned game, correct and magnificent,  
of forms assembled in the light."*

Bring Freedom

Inside

**Alumil** SUPREME  
S650 PHOS

Alumil's sliding  
thermal insulating system  
SUPREME S650 PHOS...

Is the ideal solution for projects  
requiring wide spans with **minimal  
aluminium site lines.**

## DESIGN PHILOSOPHY

## CHARACTERISTICS

### Massive yet elegant glazing surfaces

- All the aluminum profiles are totally concealed in wall so as to maximize natural light.
- Only 25 mm visible aluminium face width at the interlocking profile.
- Extra concealed profiles available for water drainage.
- Stainless steel rollers for smooth sliding & maximum functionality with high resistance to corrosion.
- Availability of 3 alternative solutions for the on-floor, in-floor or totally concealed in-floor installation, covered with the floor finish (version **SUPREME S650 Eclipse**).
- Alternative version for automated sliding sashes (**SUPREME S650 e-motion**).

**Alumil** SUPREME  
S650 PHOS

## TECHNICAL

## CHARACTERISTICS

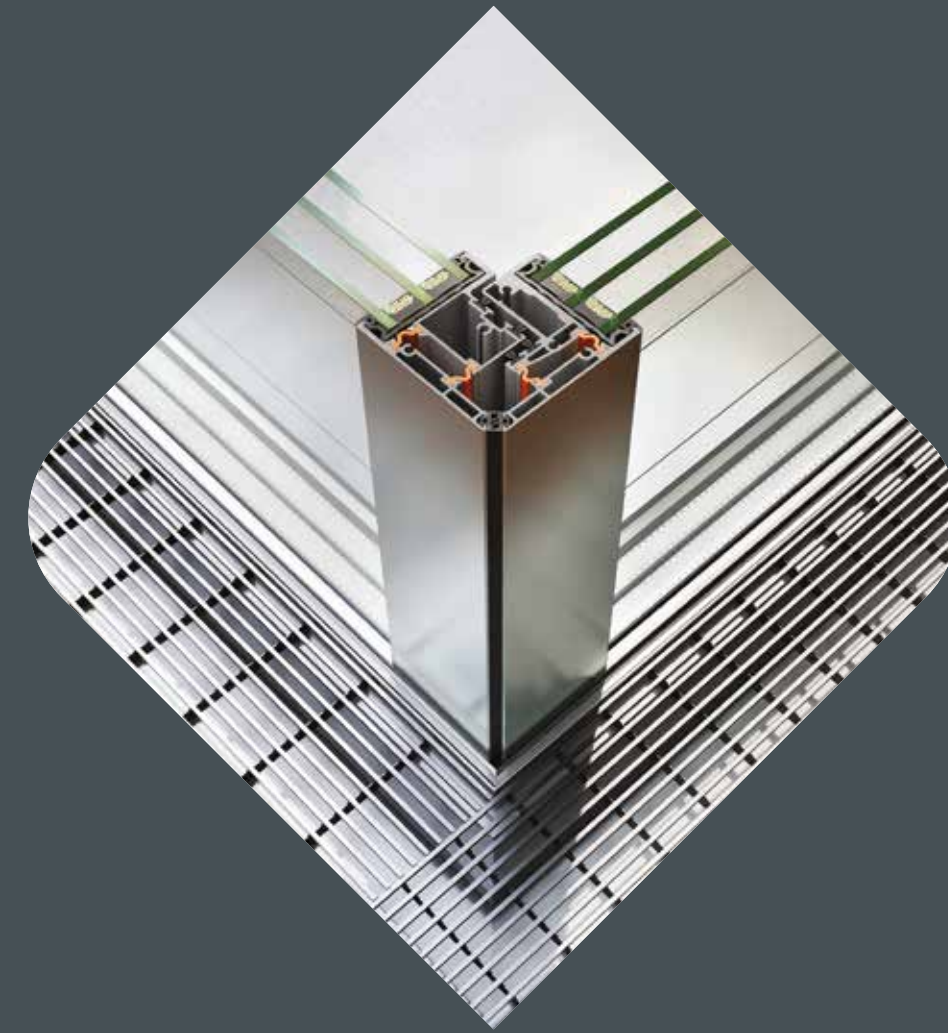

VISIBLE ALUMINIUM FACE WIDTH

**CONCEALED PROFILES**

FRAME HEIGHT

35 / 59 mm

FRAME WIDTH

164 mm

SASH HEIGHT

22 / 32 mm

SASH WIDTH

62 mm

INTERLOCKING PROFILE WIDTH

25 mm

SASH WEIGHT

1000 Kg

GLAZING

36 / 46 mm

INSULATION

POLYAMIDES, PVC

**Alumil** > SUPREME  
S650 PHOS

The limits between interior and exterior  
**are eliminated** as the only aluminium width is

**SENSE**

**OF FREEDOM**

The system's main advantage is the improvement of living conditions by **maximizing the natural lighting and minimizing the visible aluminum face width**, which makes the residents feel closer to the external environment and increases their sense of freedom.

**25mm** at the interlocking profile.



**Alumil** SUPREME  
S650 PHOS

SUPREME S650 PHOS offers a unique combination of **elegance** and **functionality**, satisfying even the most demanding requirements.

ATTENTION

ITS MINIMAL DESIGN ALONG WITH THE WIDE GLAZING SURFACES ENHANCE **MAXIMUM VISIBILITY** AND **NATURAL LIGHT** BY USING TOTALLY CONCEALED PROFILES INTO THE WALLS, THE FLOOR AND THE CEILING.

TO DETAIL

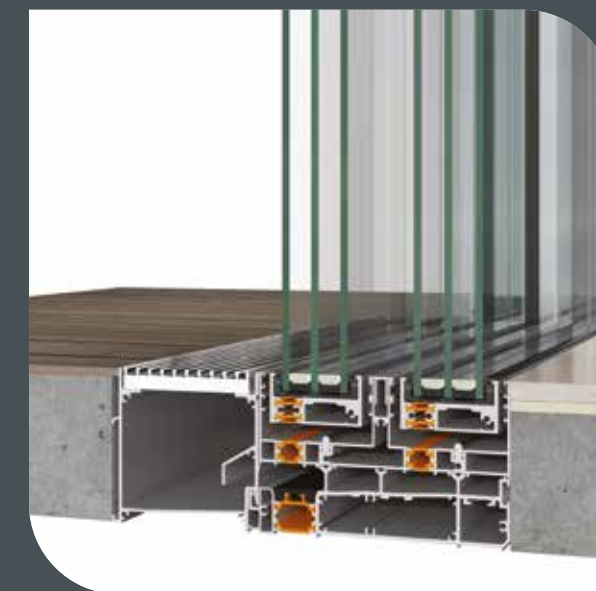

**ALTERNATIVE VERSION FOR TOP-MOUNTED INSTALLATION WITH A LOW THRESHOLD,** a flat track that is addressing safety issues for easy and safe access to children, elders and people with disabilities. A more flexible solution ideal for renovations with innovative water drainage.



**Alumil** > SUPREME  
S650 ECLIPSE

The innovative invisible track is totally integrated into the floor and covered with the floor finish offering a **flat surface** and creating continuity between the interior and the exterior environment.

## THE ABSOLUT

DESIGNED TO MEET THE ARCHITECTURAL DEMANDS OF MINIMAL THERMALLY INSULATED SLIDING SYSTEMS WITH MINIMUM ALUMINUM SIGHT LINES.

## MINIMAL DESIGN



- Invisible bottom frame totally flush to the floor
- Profiles totally concealed in-wall for maximum natural light.
- Only 25 mm visible aluminium face width at the interlocking profile.
- Concealed water drainage with high performance.
- Stainless steel rollers easily replaced for maintenance.
- New inox philosophy for flawless sash gliding & durability overtime.



**Alumil** SUPREME  
S650 PHOS

## FOCUS

## ON SAFETY

### ROLLERS

Stainless steel rollers ideal for seaside projects. For heavy duty constructions up to **1000 Kg** per sash, offering high functionality & smooth gliding of the sashes.

**CERTIFIED PERFORMANCES TESTED ACCORDING EN 13126-1 AND EN 1670 FOR:**

- CORROSION RESISTANCE
- DURABILITY
- STATIC LOAD
- HARDNESS

### LOCKING SYSTEM

**CERTIFIED PERFORMANCES TESTED ACCORDING EN 13126-1 AND EN 1670 FOR:**

- MULTIPLE LOCKING POINTS.
- TOP - BOTTOM AND/OR AT THE LOCKING SIDE OF THE SASH.
- WRONG OPERATION SAFETY DEVICE TO PROTECT THE SASH FROM MISUSE.

### HANDLES

Branded handles with **ALUMIL** unique design offer high security as they are lockable with key placed on the handle level. In addition, they are very easy to install after transportation on site and can be easily removed for maintenance.

- STANDARD HANDLE
- MINIMAL HANDLE
- FULL HEIGHT HANDLE



### 2 Sashes / 2 Track

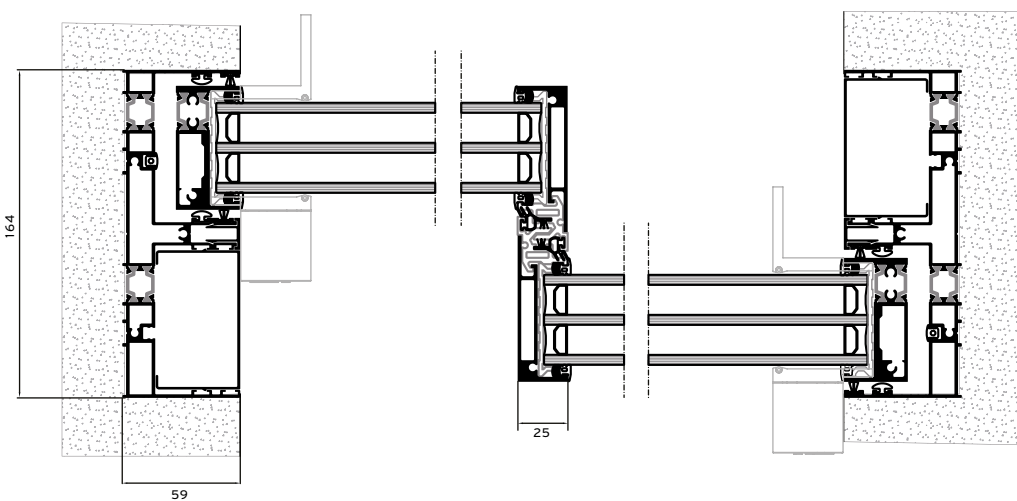
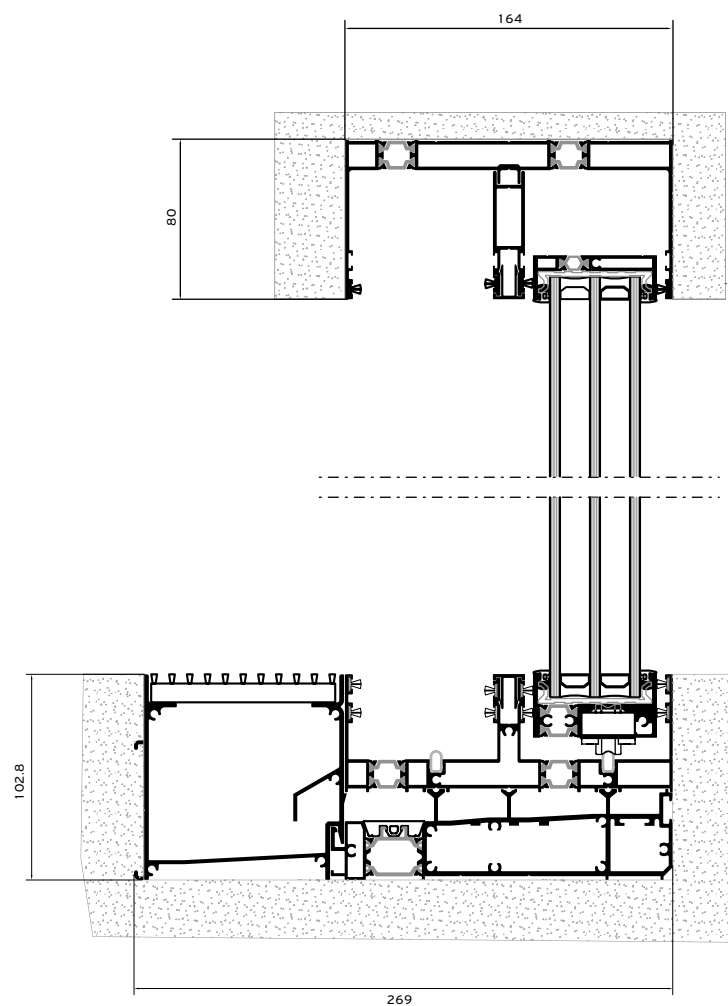
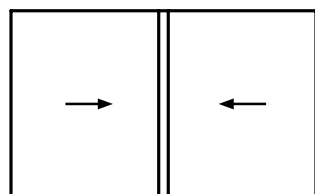

### 2 Sashes / 2 Track Low Threshold

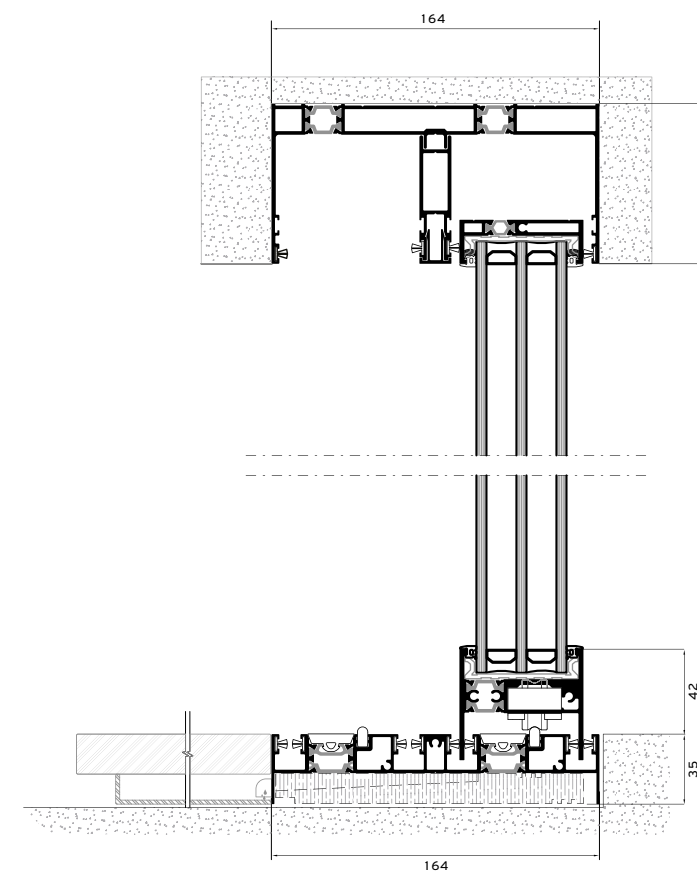
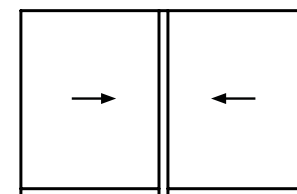

**3 Sashes / 3 Track**

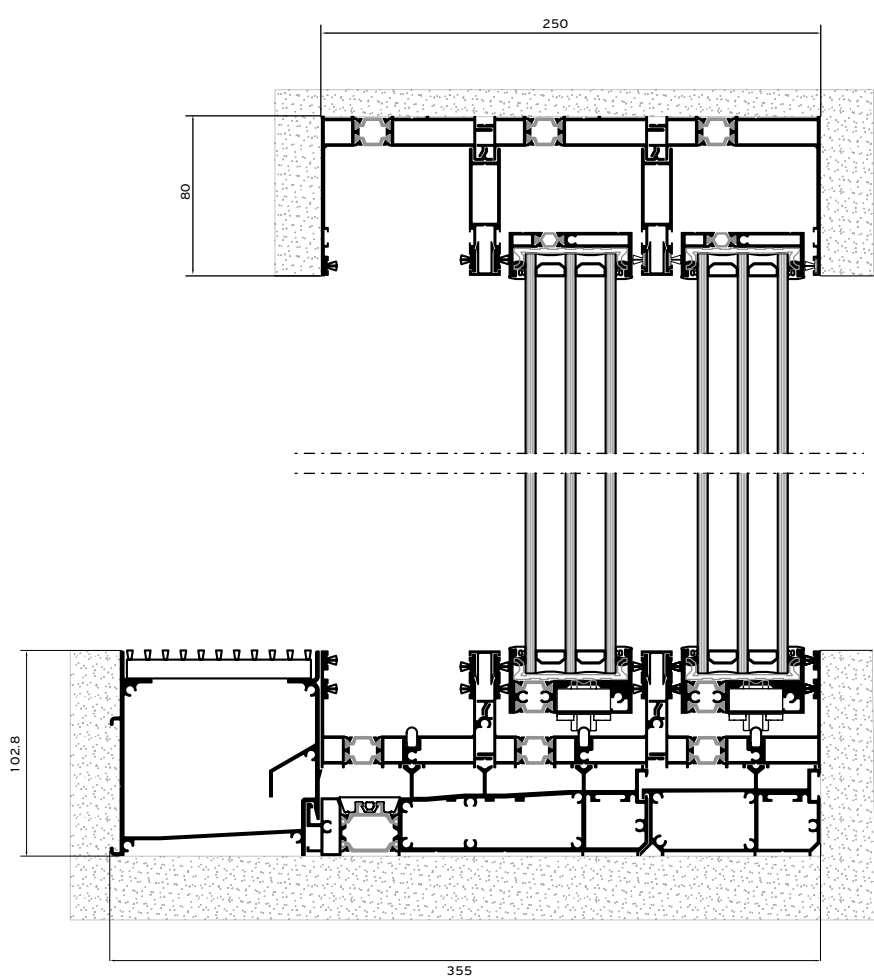
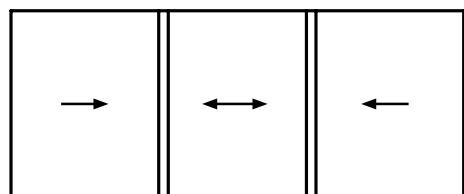

**3 Sashes / 3 Track**  
Low Threshold

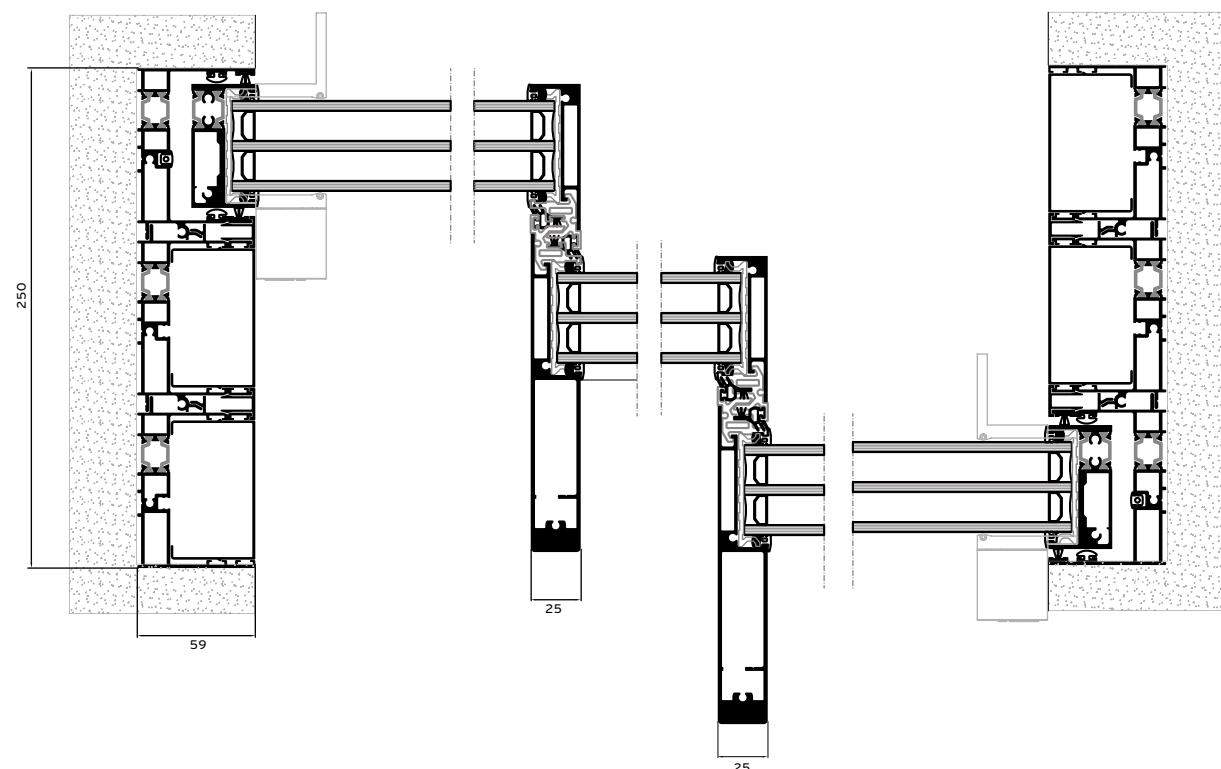
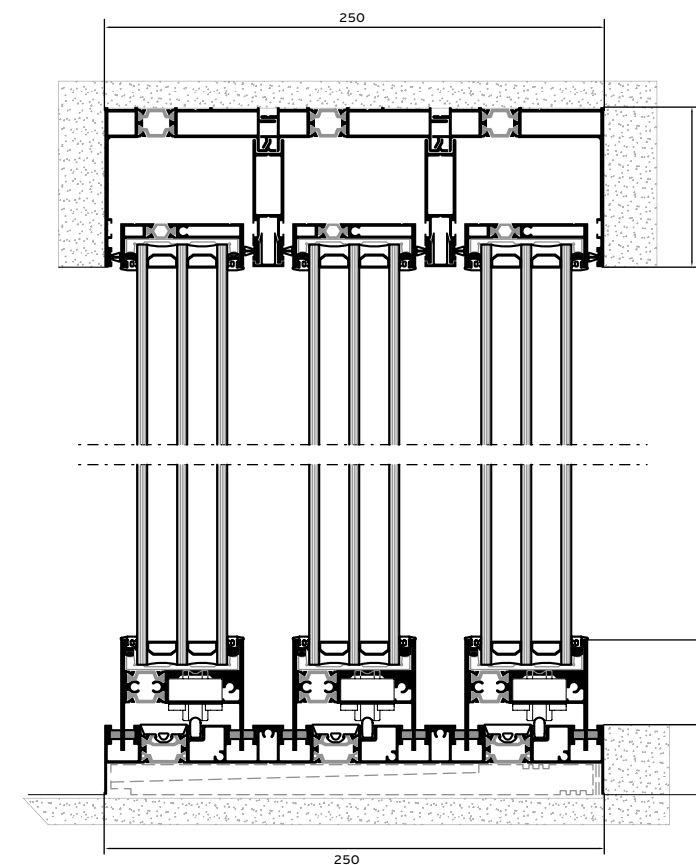
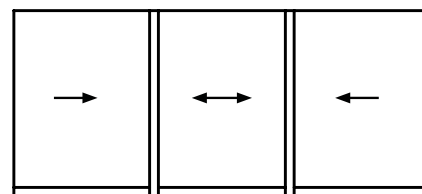

### 2 Sashes / 3 Track / Flyscreen

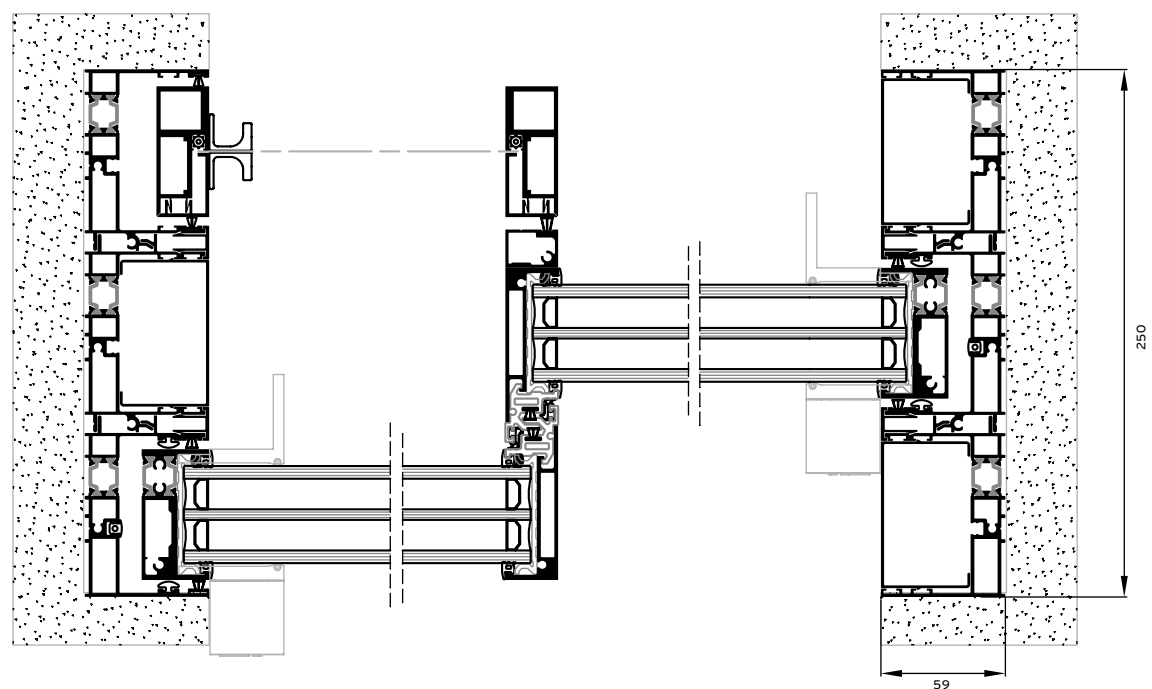
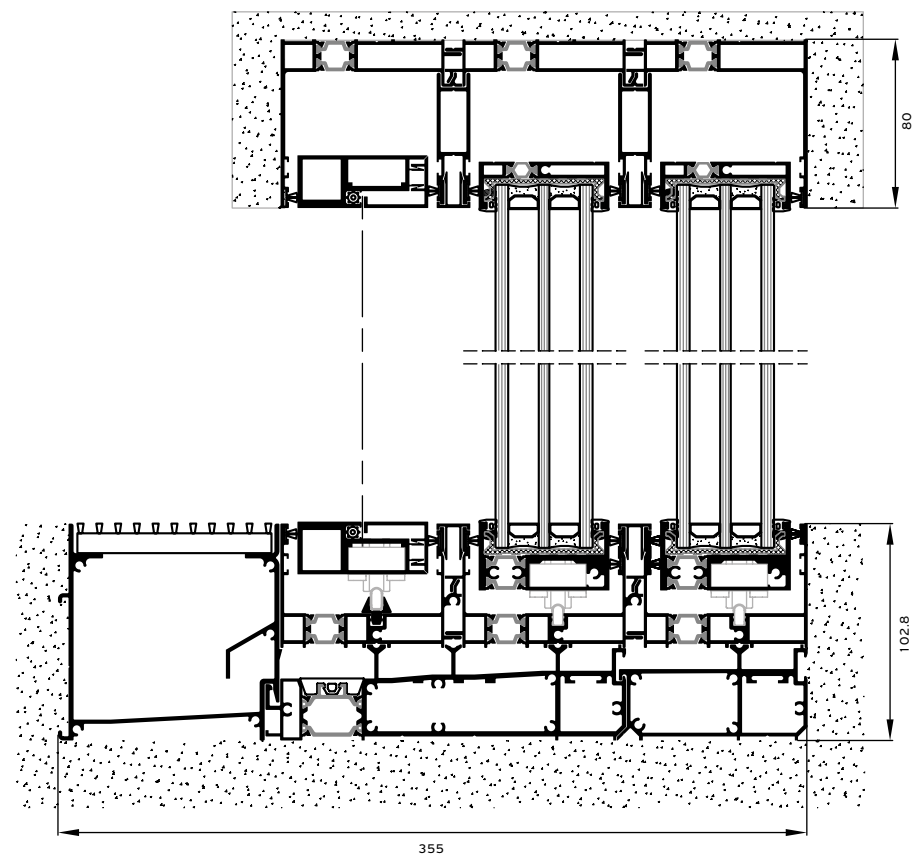
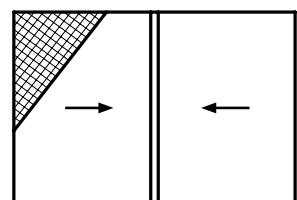

### 2 Sashes / 3 Track / Flyscreen

Low Threshold

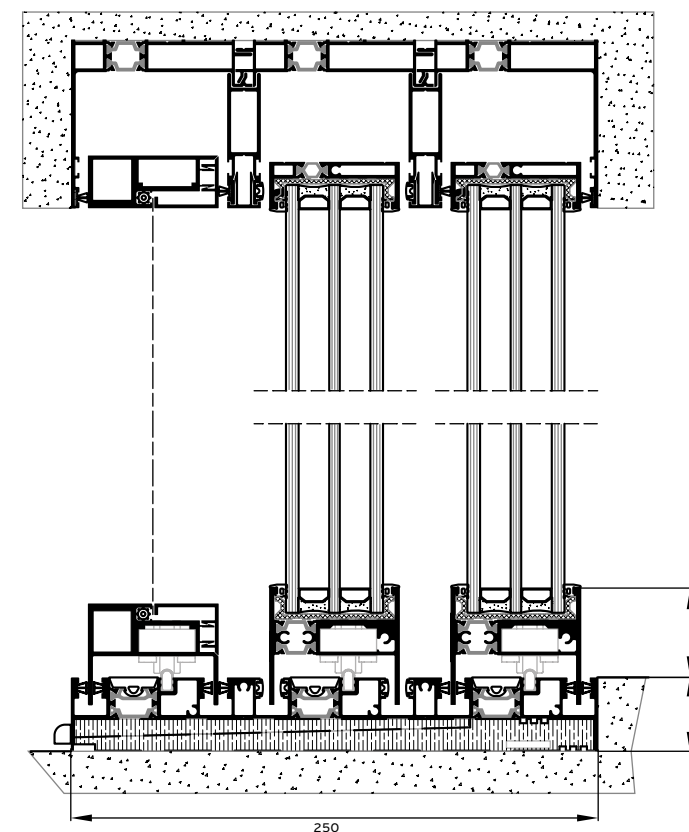
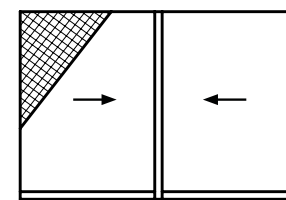

### 2 Sashes / 2 Track

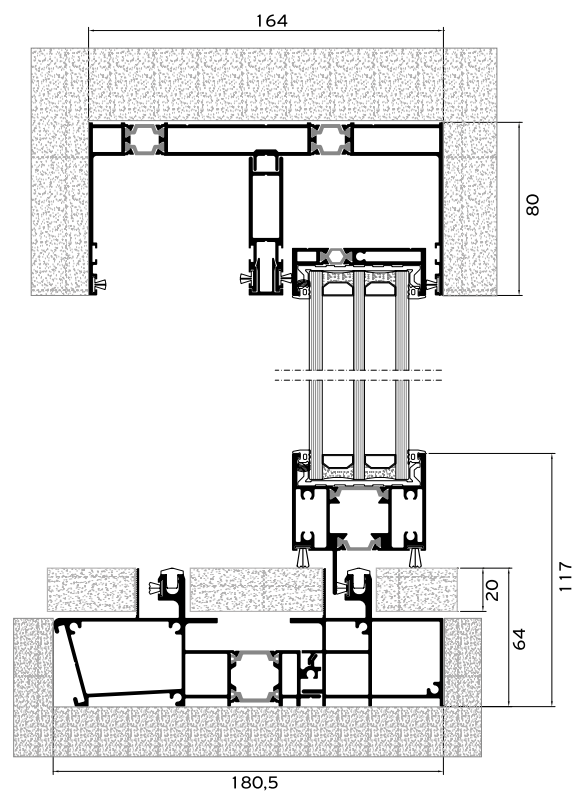
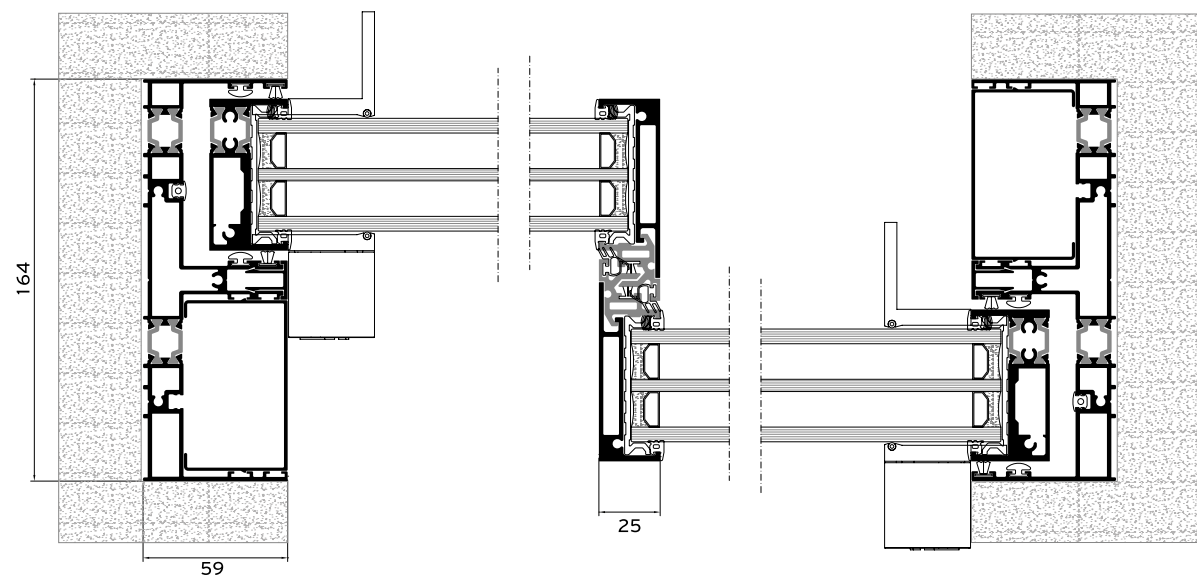
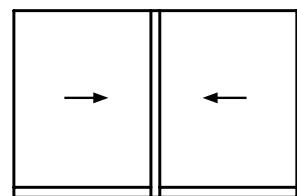

### 3 Sashes / 3 Track

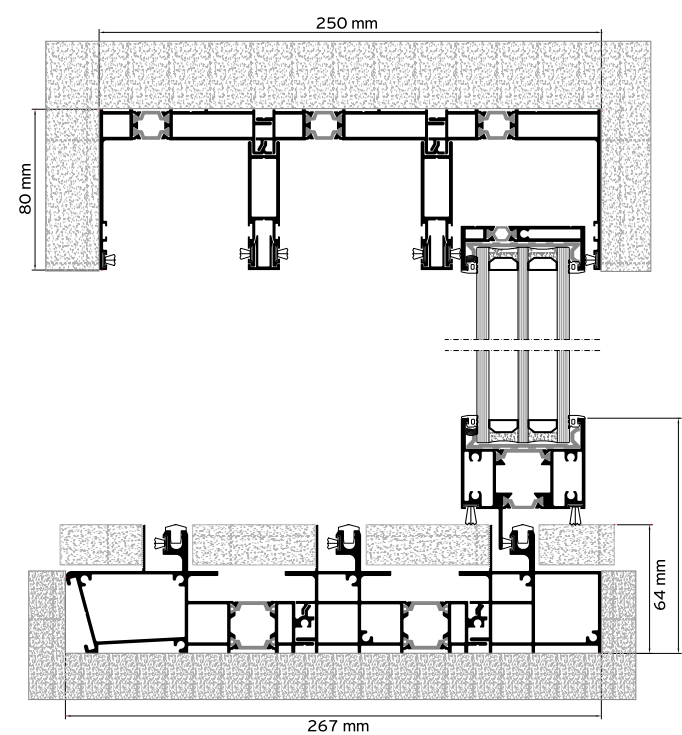
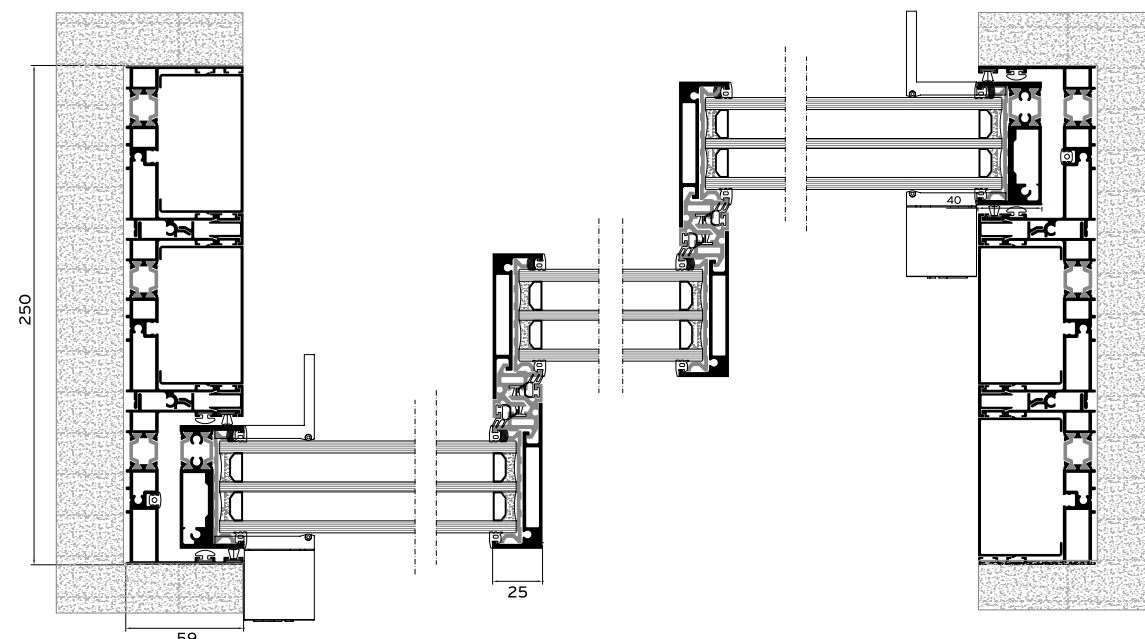
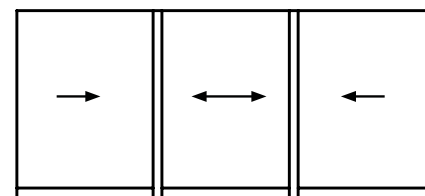

**Alumil** SUPREME  
S650 ECLIPSE

**2 Sashes / 2 Track / Flyscreen**

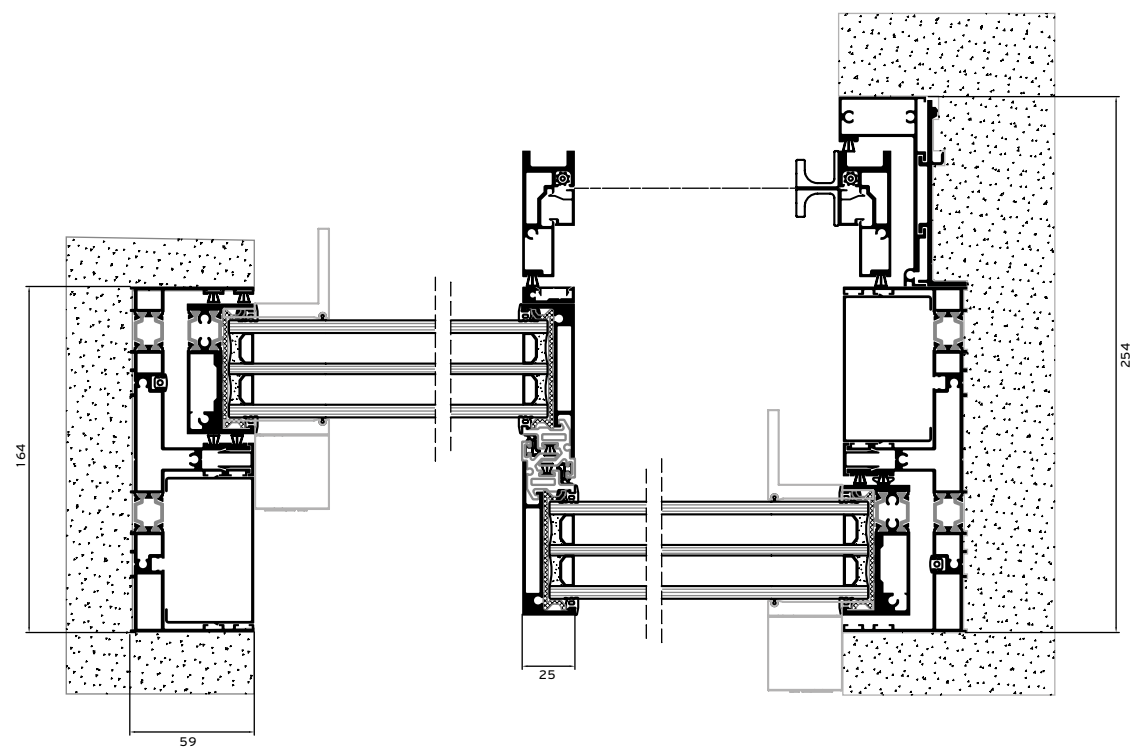
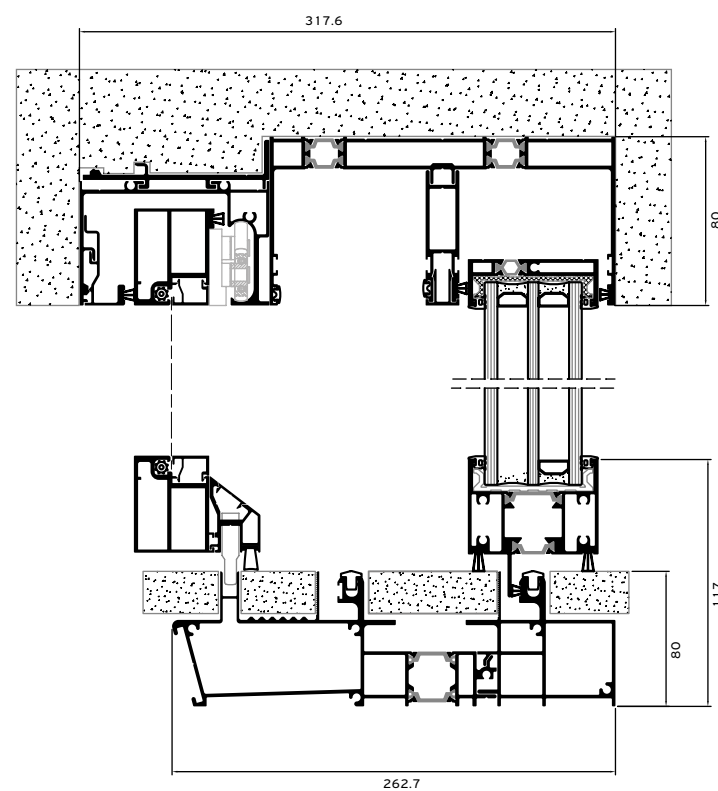
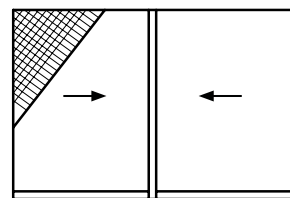

**Alumil** SUPREME  
S650 PHOS

**4 Sashes / 2 Track**

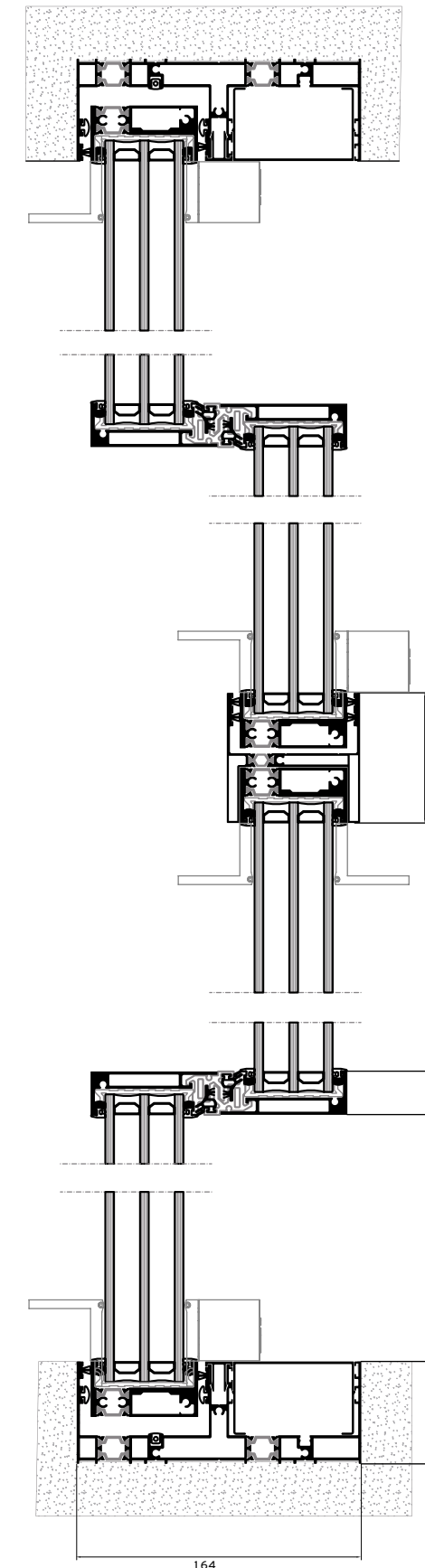
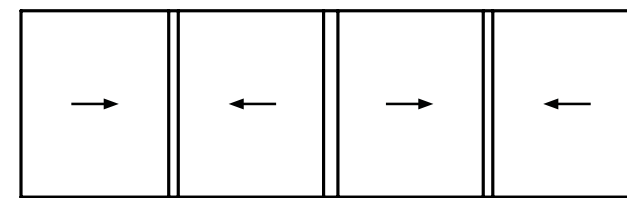

90° Rotate the technical drawing 90° CLOCKWISE IN ORDER TO READ IT PROPERLY

### 1 Sash / 2 Fixed lights

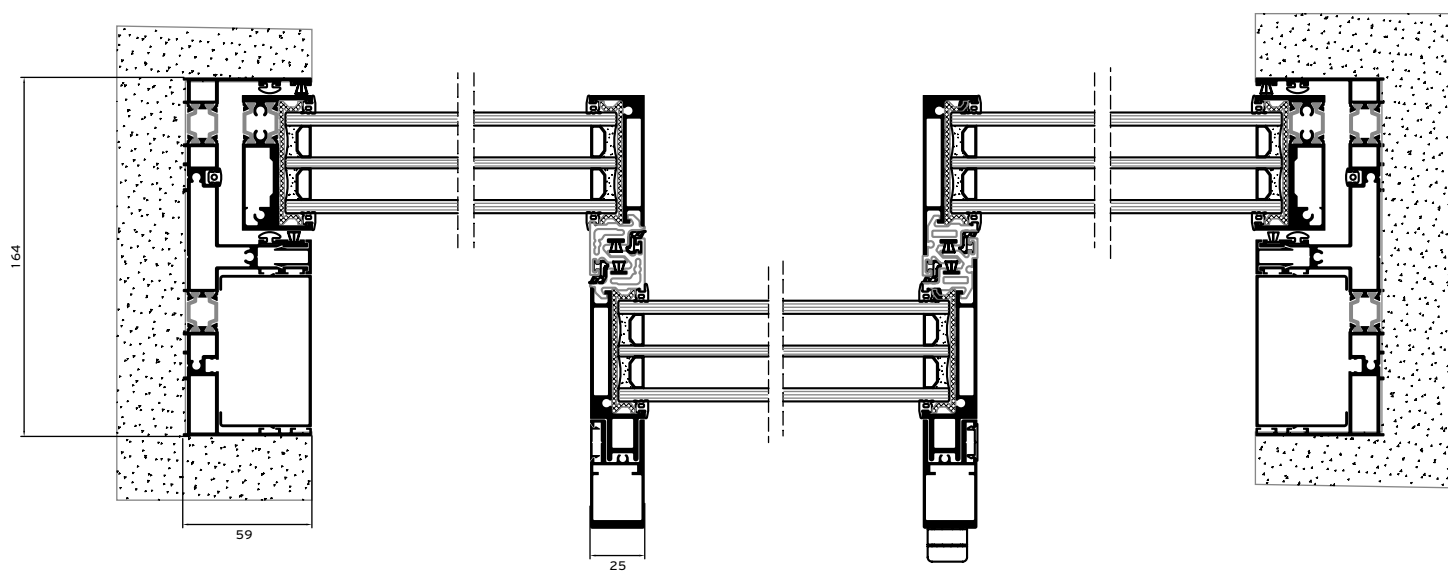
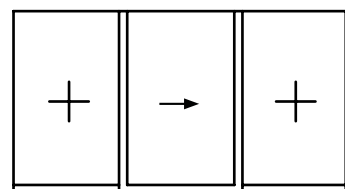

### 2 Sashes / 2 Fixed lights

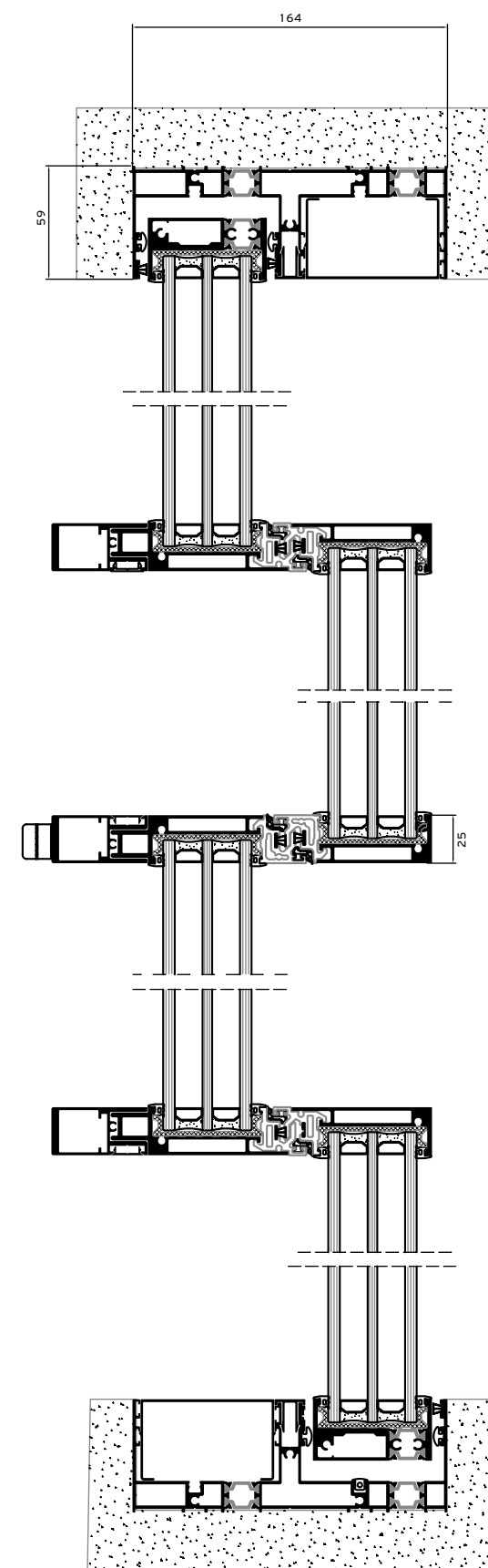
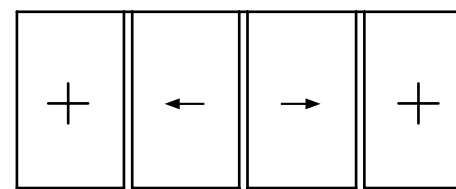

90° Rotate the technical drawing 90° CLOCKWISE IN ORDER TO READ IT PROPERLY

### External Corner

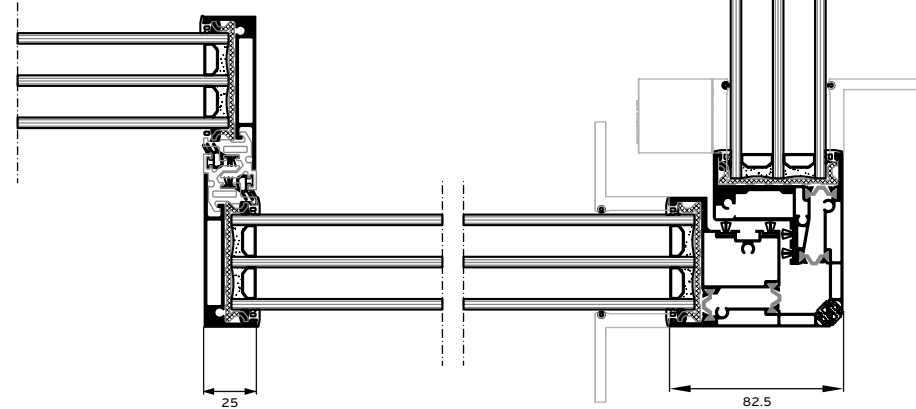
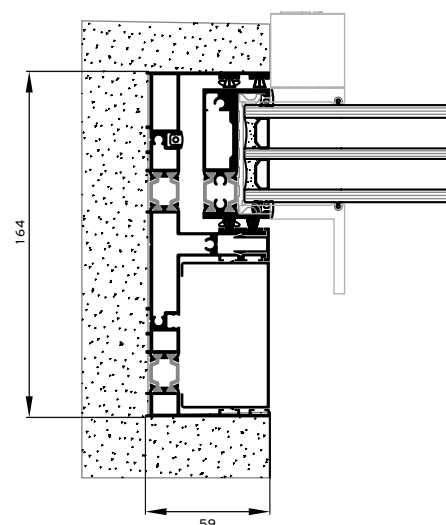
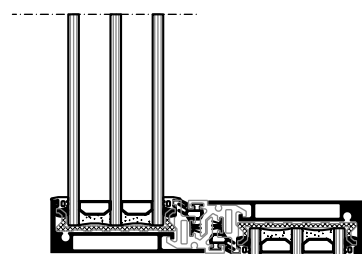
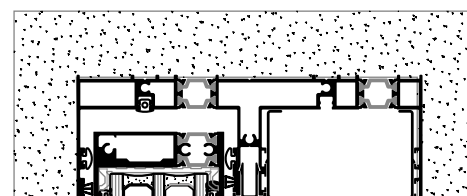
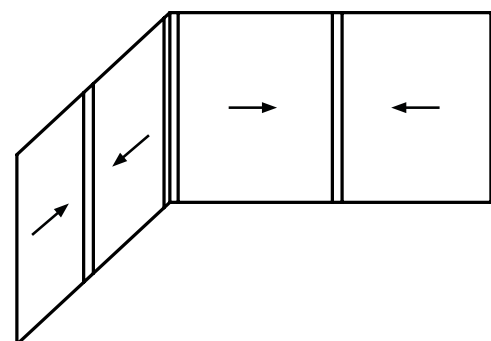

### Pocket Window

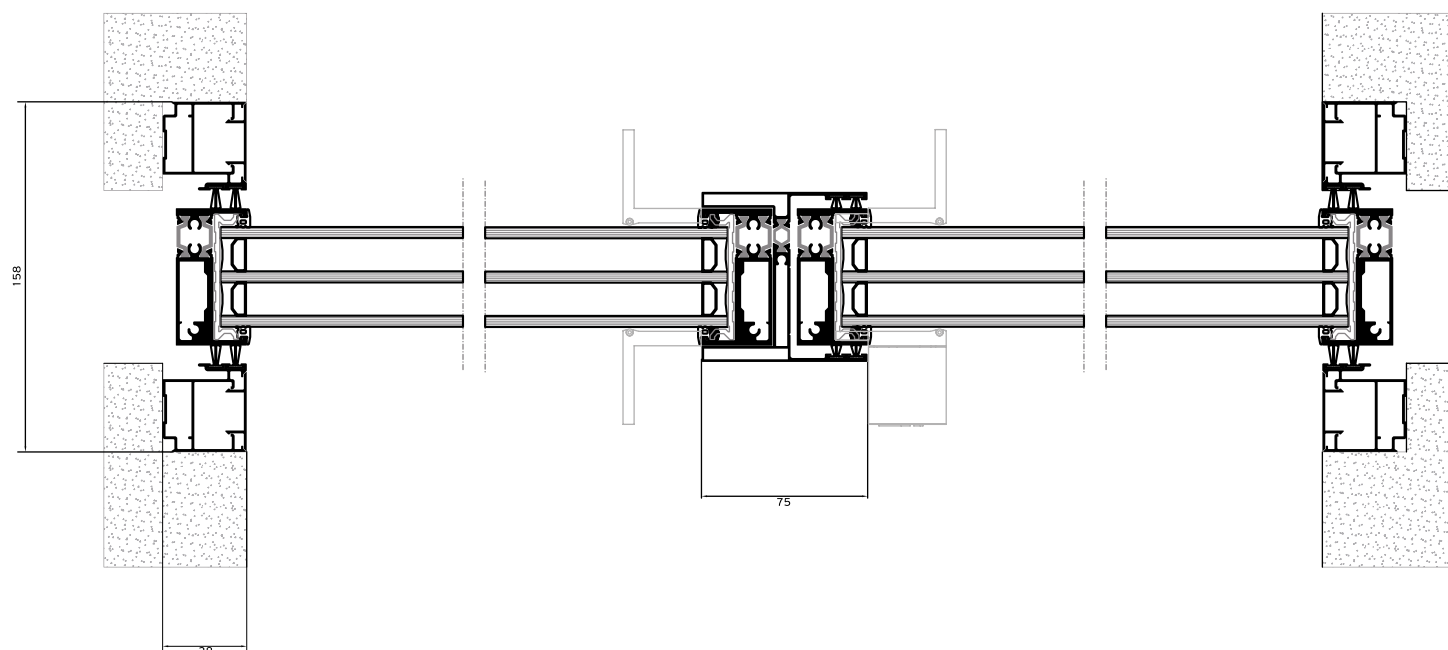
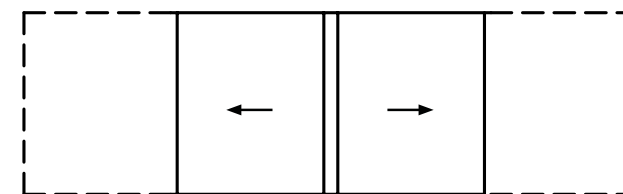

### 2 Sashes / 1 Track

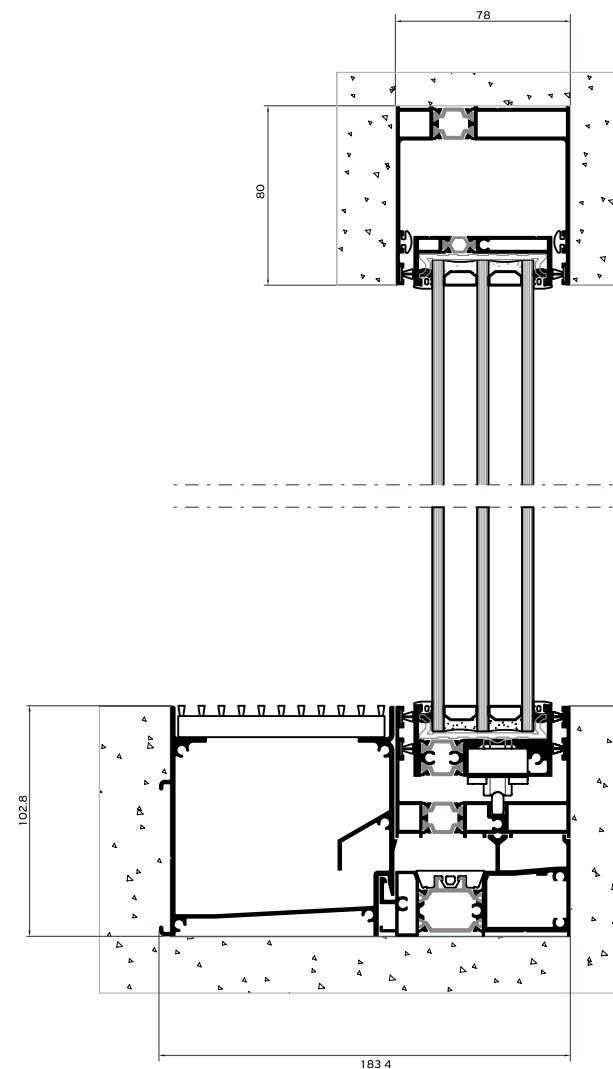



### Multi Track

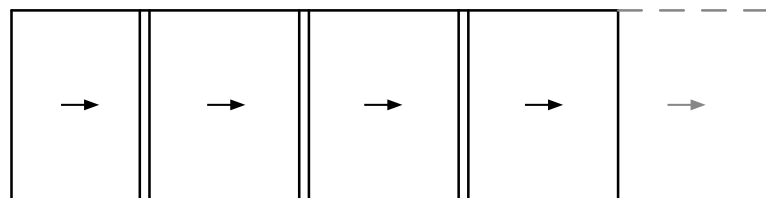

"No limits at the number of the horizontal sashes with the multi track typologies"

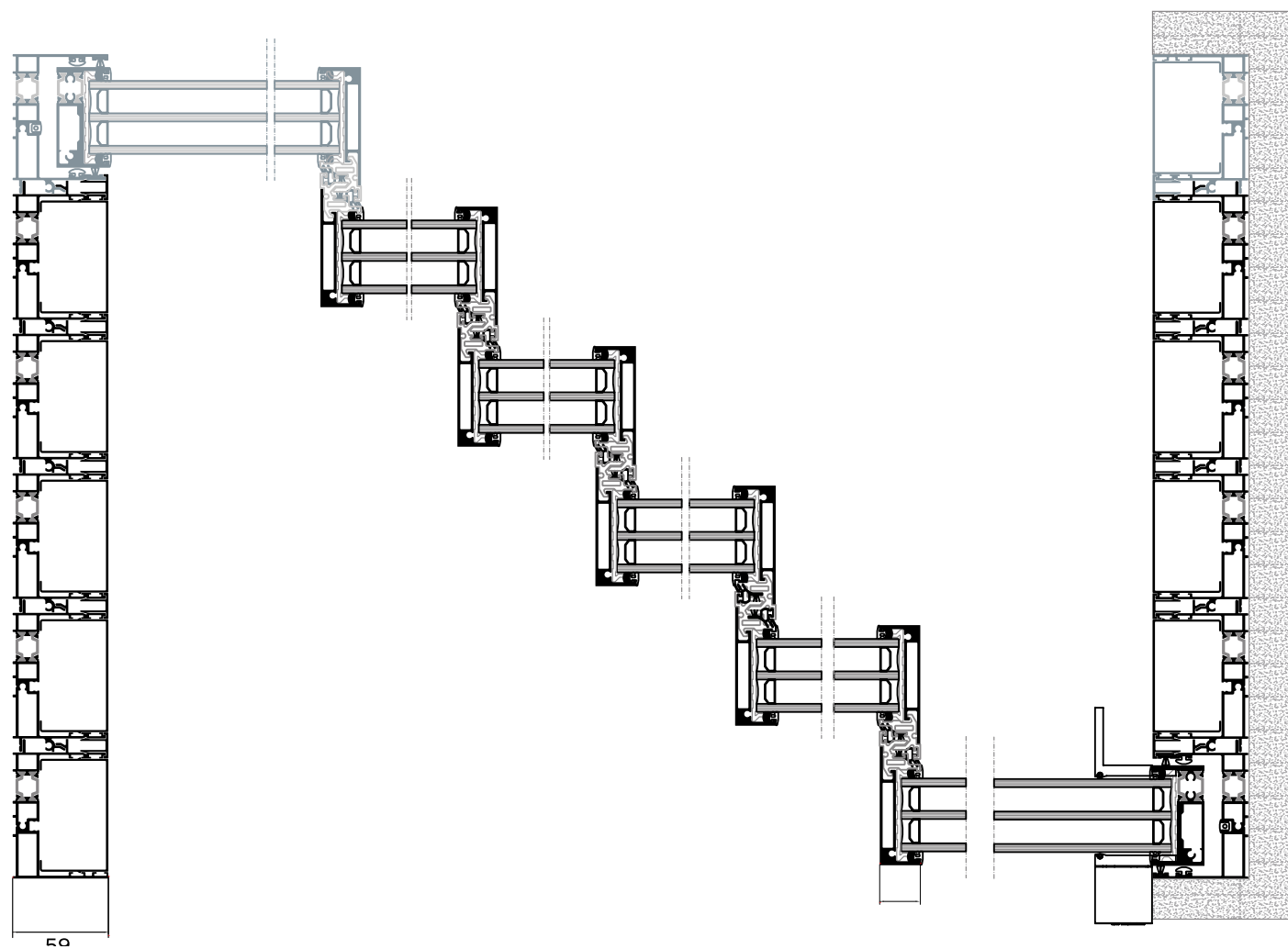
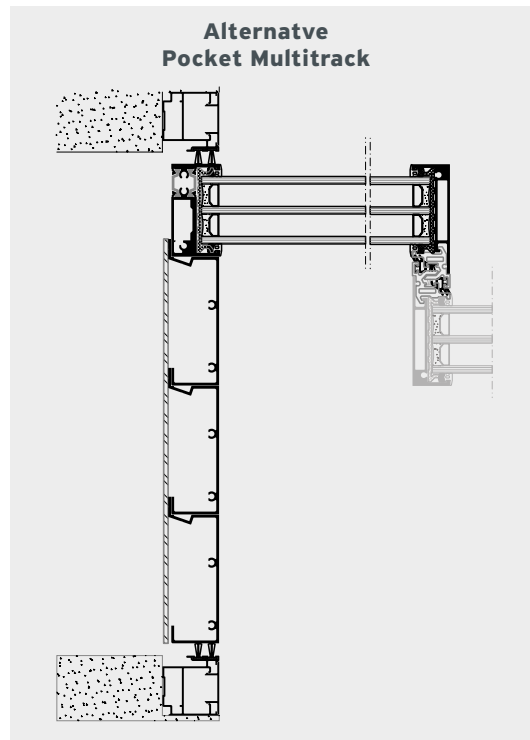

### 2 Sashes / 2 Track / ZIP Screen

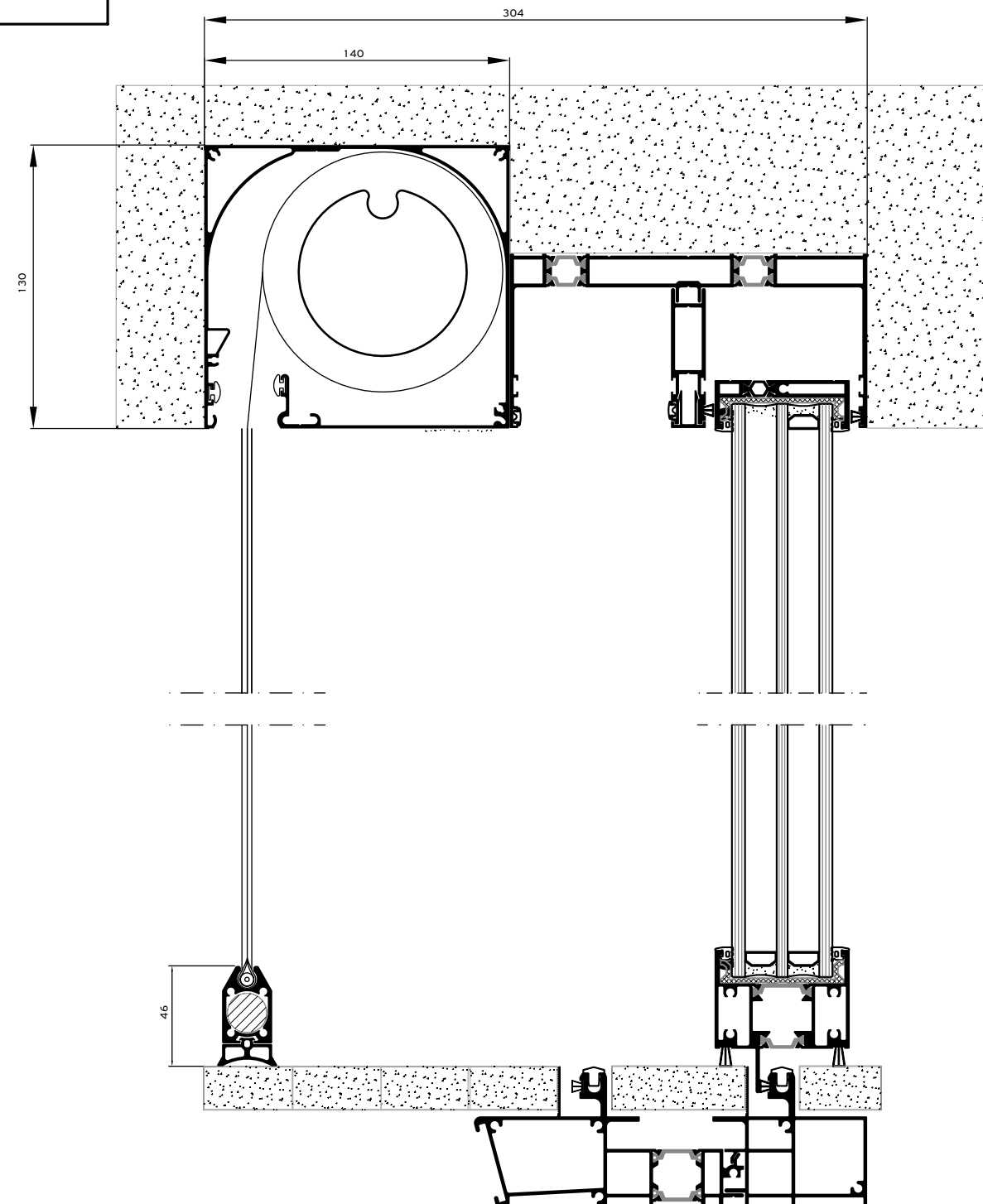
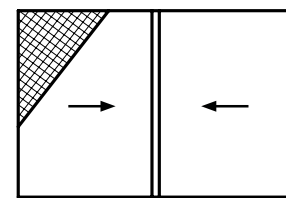

**Alumil** SUPREME  
S650 ECLIPSE

### 2 Sashes / 2 Track / Integrated Flyscreen IFS

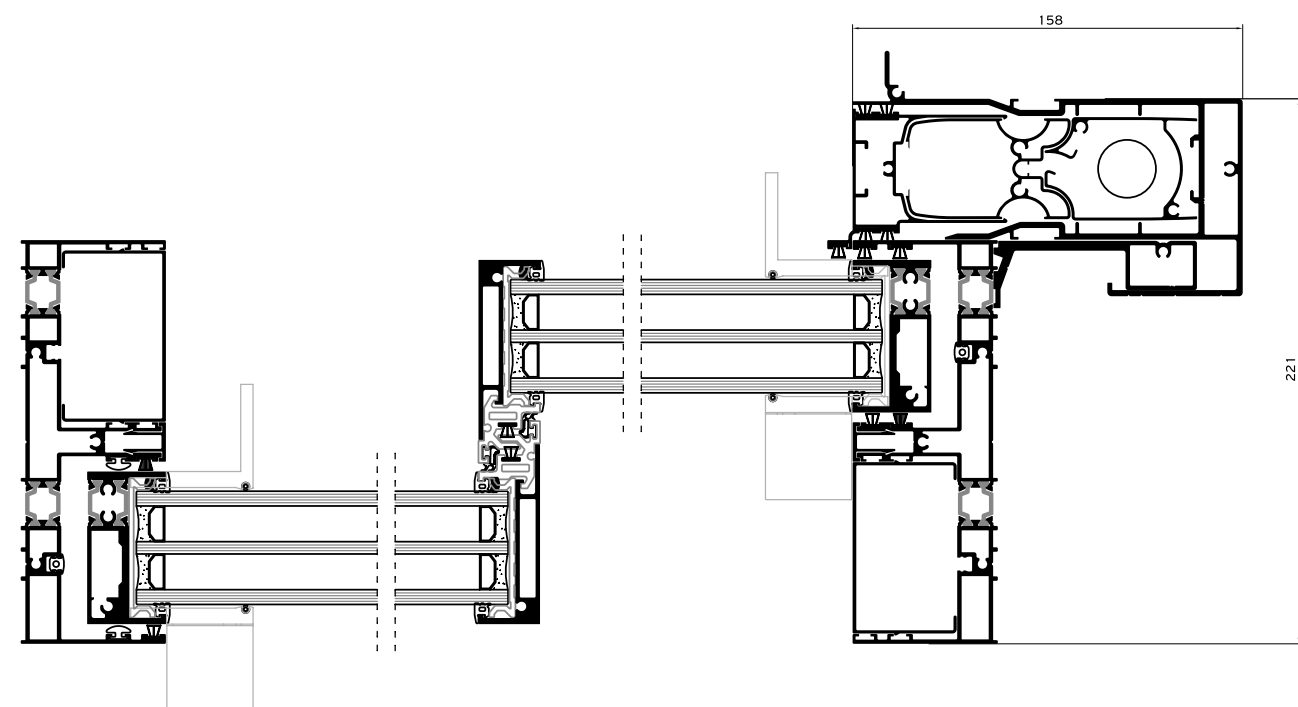
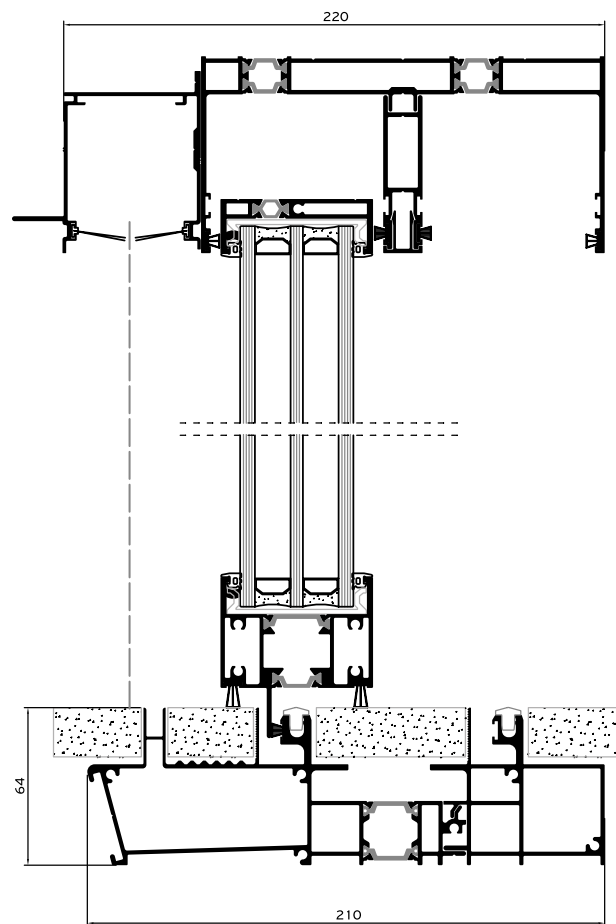
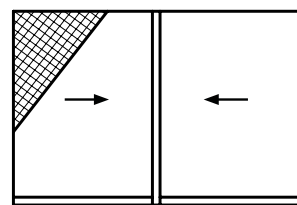

**Alumil** SUPREME  
S650 PHOS

### 2 Sashes / 2 Track / Integrated Flyscreen IFS Low Threshold

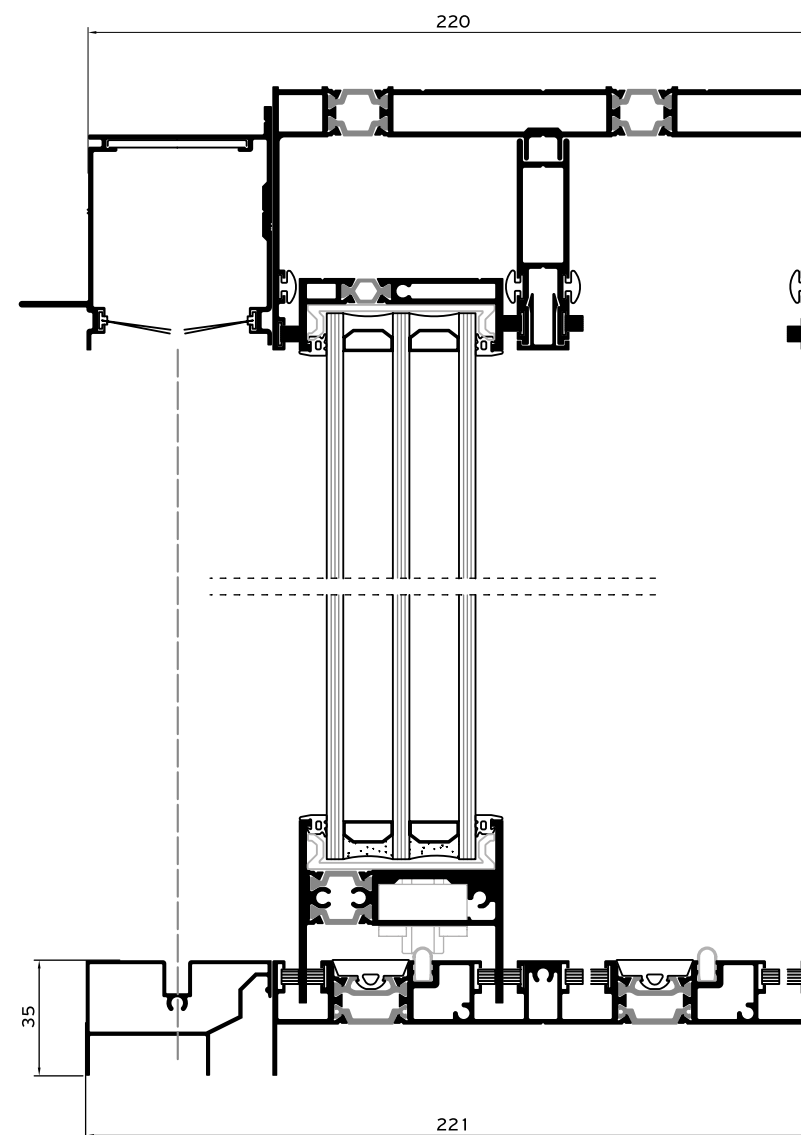
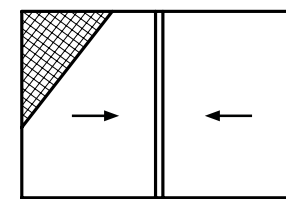

## STIFFENERS

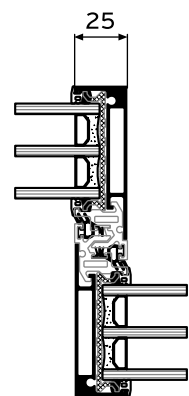

$I_x = 34,8 \text{ cm}^4$

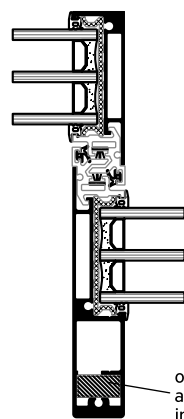

$I_x = 101,4 \text{ cm}^4$   
with insert:  
 $I_x = 114,1 \text{ cm}^4$

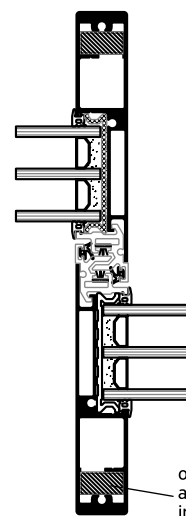

$I_x = 168 \text{ cm}^4$   
with insert:  
 $I_x = 193,4 \text{ cm}^4$

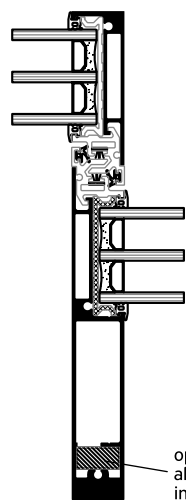

$I_x = 245,4 \text{ cm}^4$   
with insert:  
 $I_x = 267,4 \text{ cm}^4$

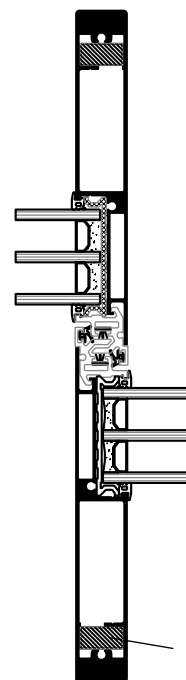

$I_x = 456 \text{ cm}^4$   
with insert:  
 $I_x = 500 \text{ cm}^4$

## GLAZING TYPES

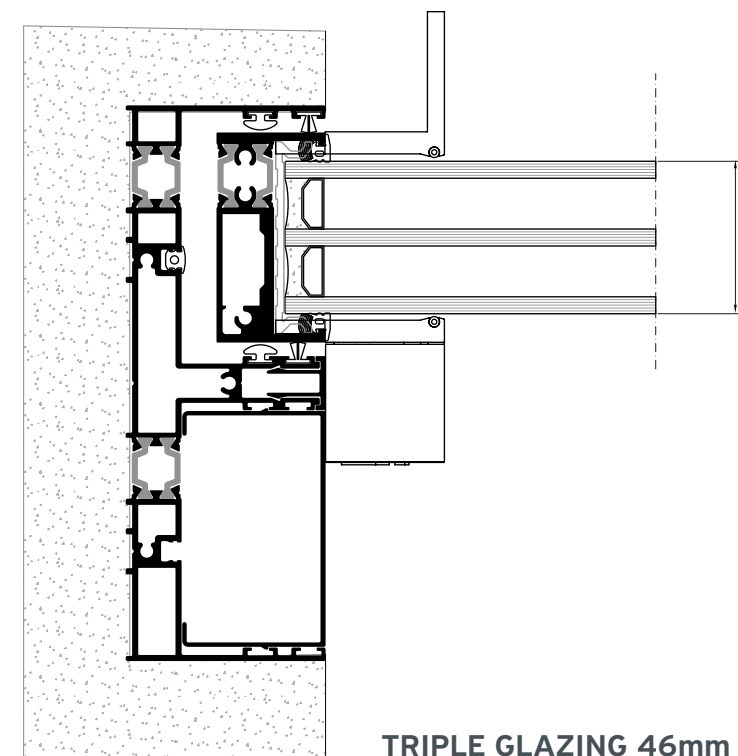



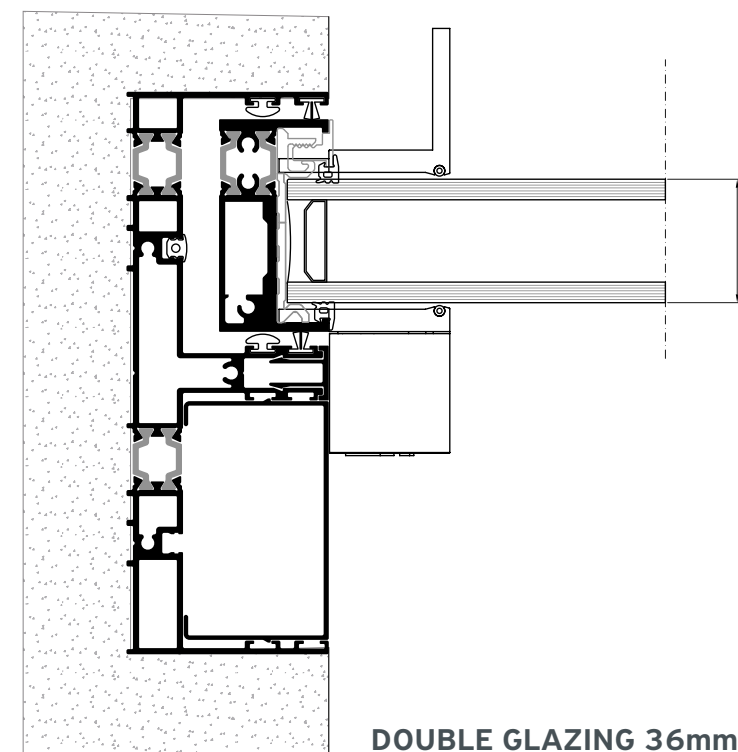







TRIPLE GLAZING 46mm



DOUBLE GLAZING 36mm

# Installation

SIDE SECTION

-  PRECOMPRESSED MULTI-FUNCTION SEALING TAPE
-  BACKER ROD
-  HYBRID SEALANT OR NEUTRAL SILICONE
-  STYRODUR HIGH DENSITY BOARD
-  MARBLE
-  POLYURETHANE FOAM
-  POLYSTYRENE
-  WALL CONSTRUCTION
-  WALL FINISH
-  REINFORCED CONCRETE
-  AIR WATER VAPOR BARRIER TAPE

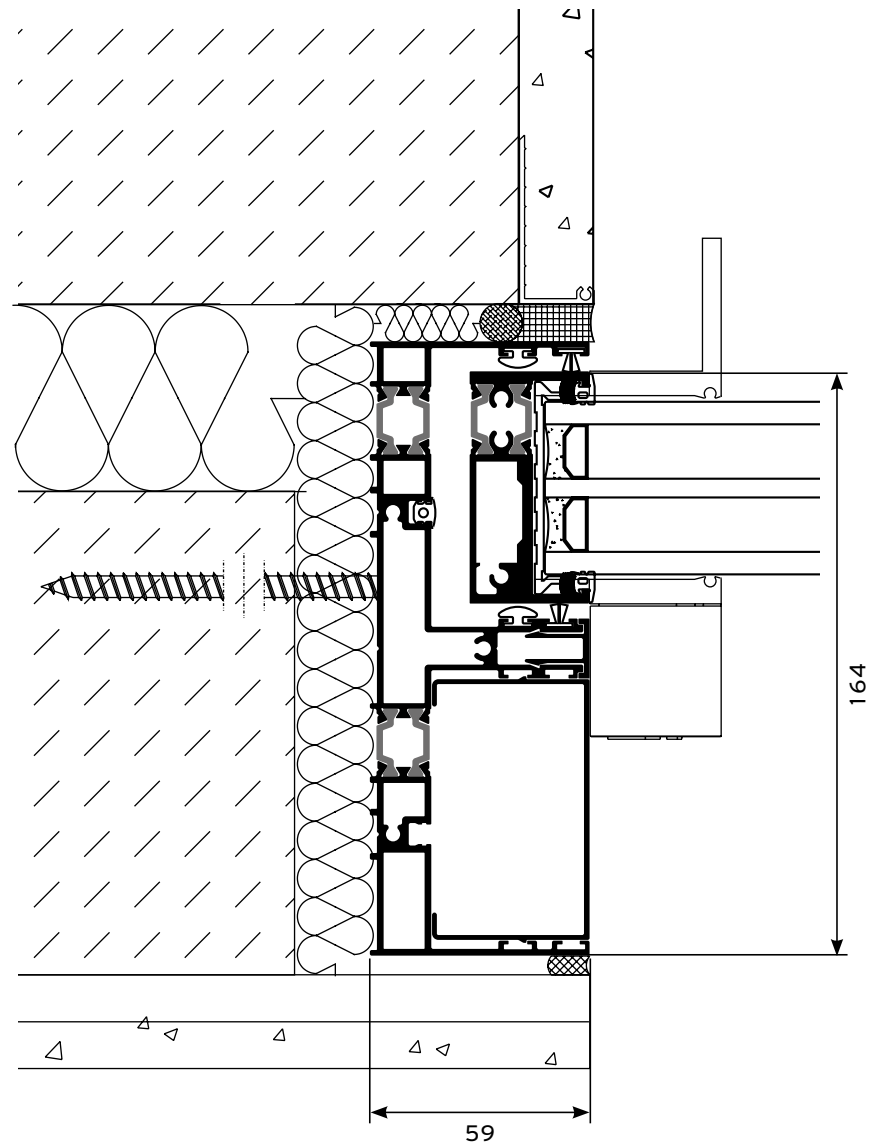

TOP SECTION

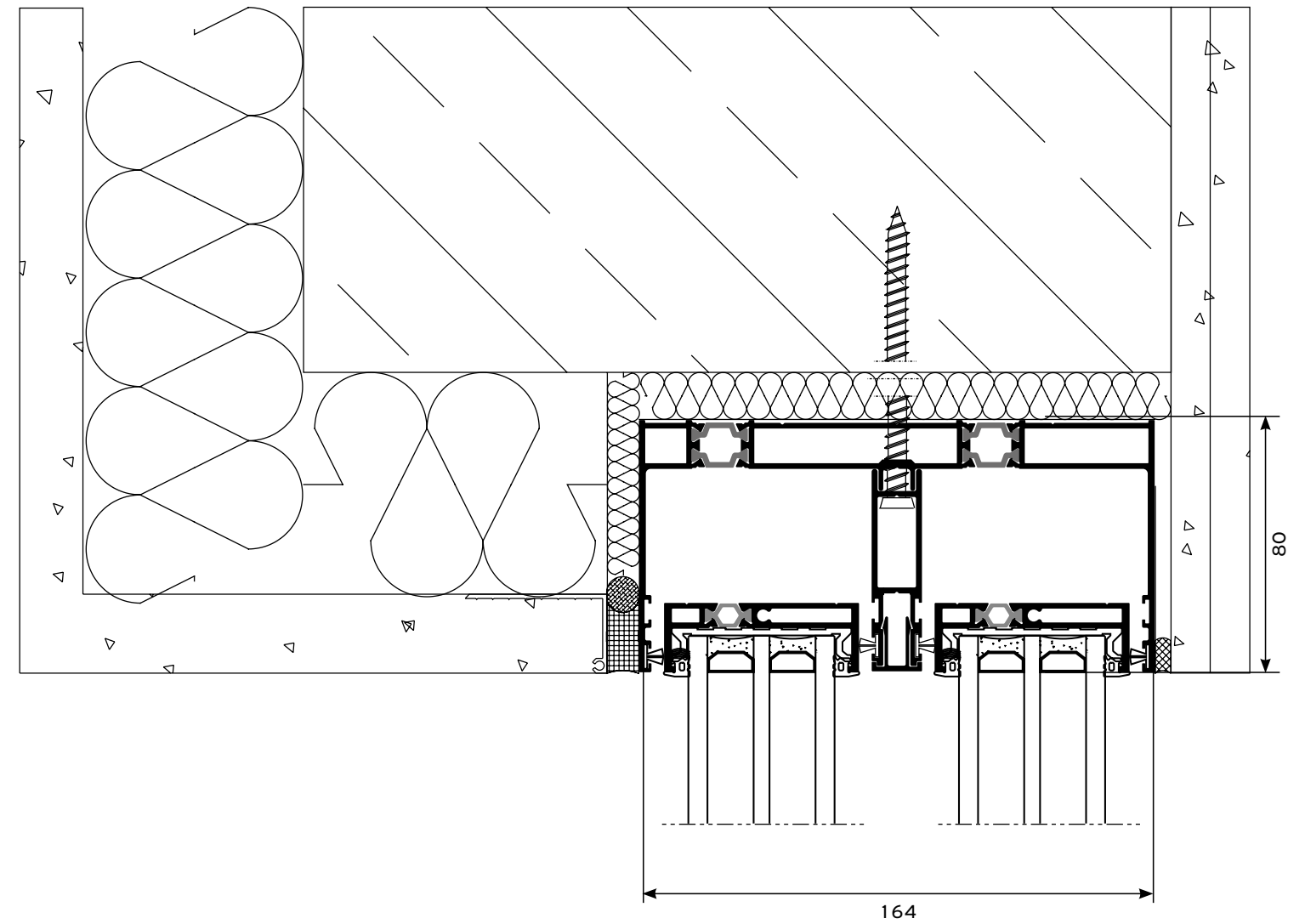

# Installation

BOTTOM SECTION WITH GUTTER

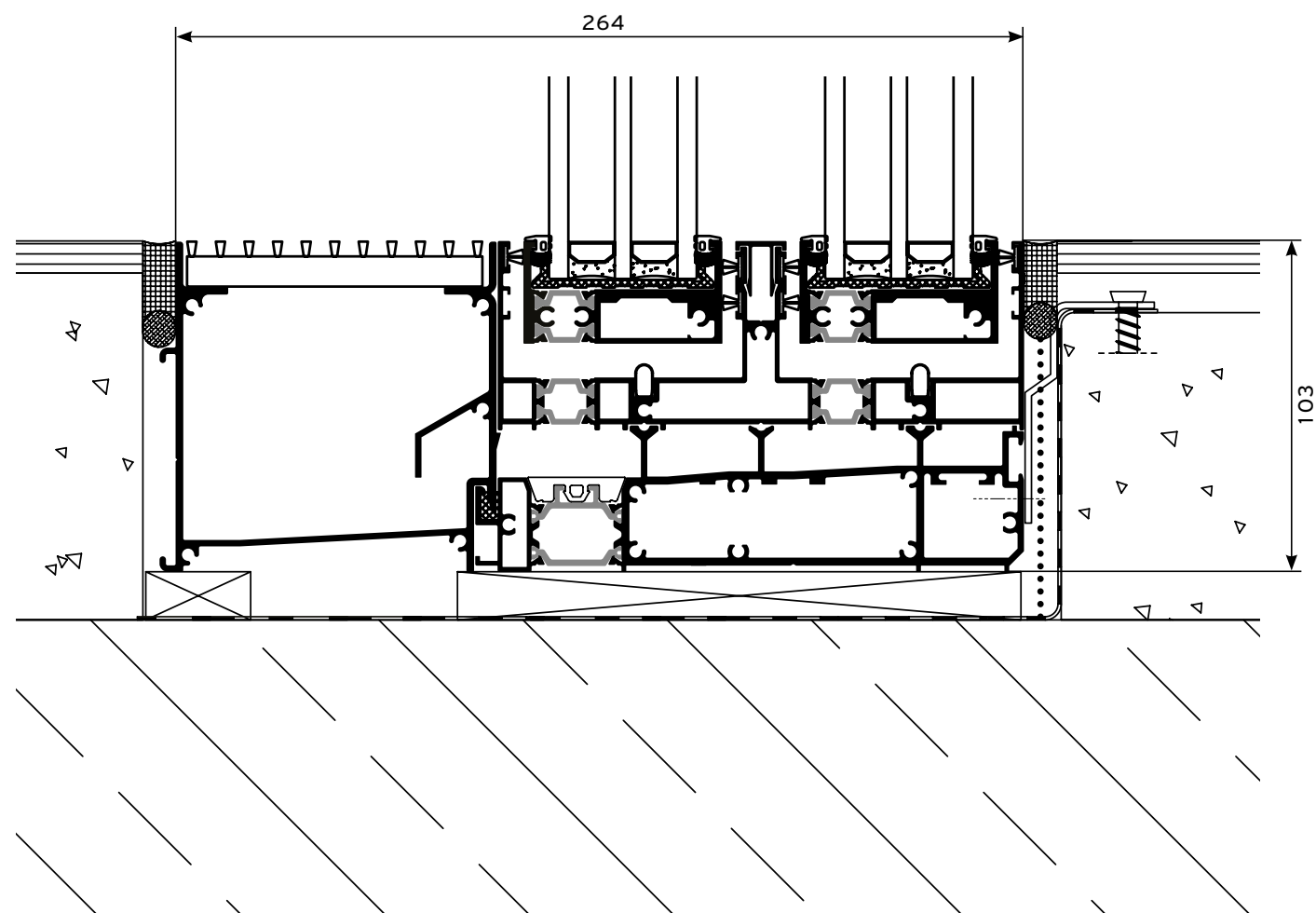

BOTTOM SECTION ECLIPSE

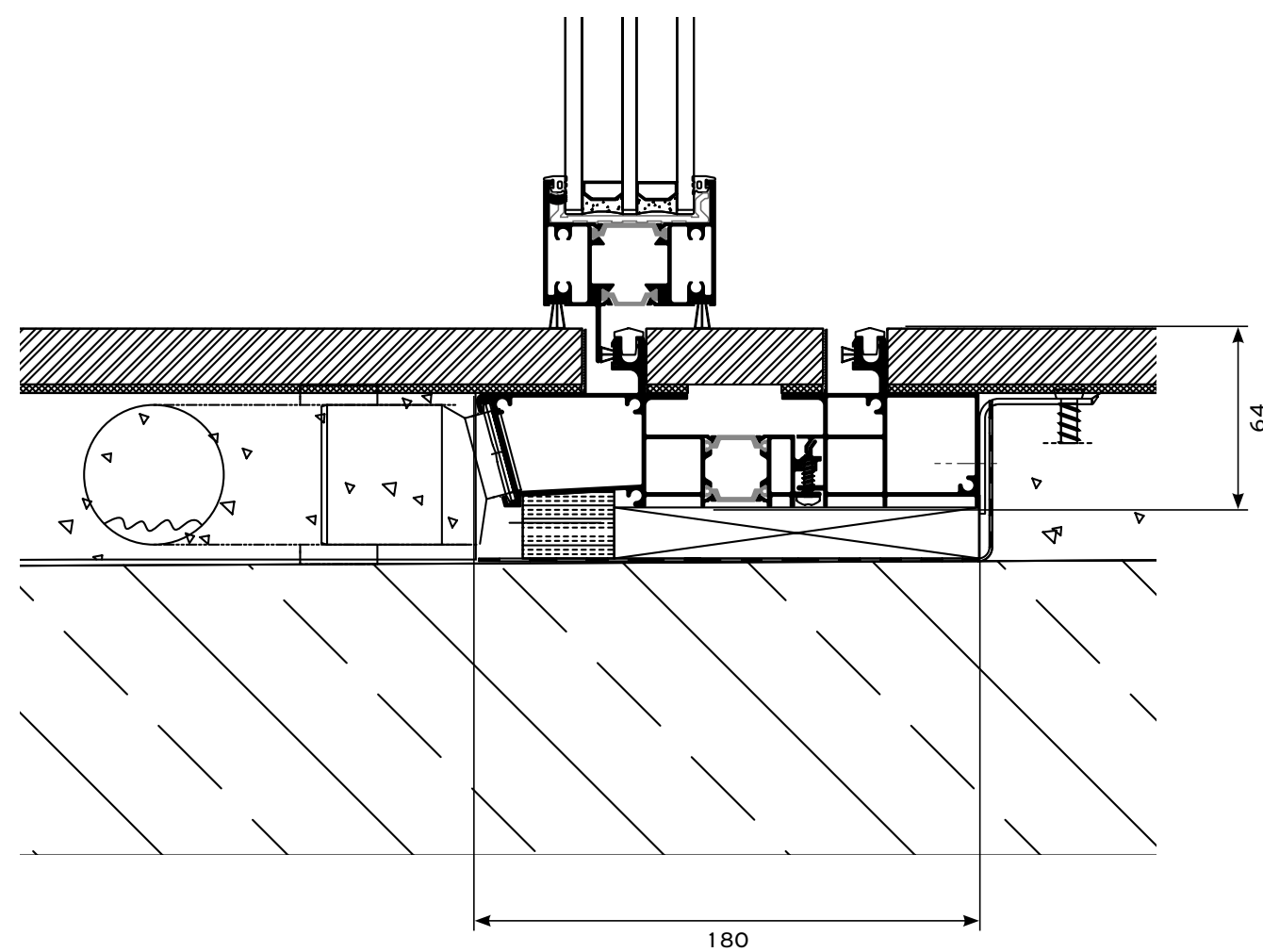

# Installation

BOTTOM SECTION WITH LOW TRACK A

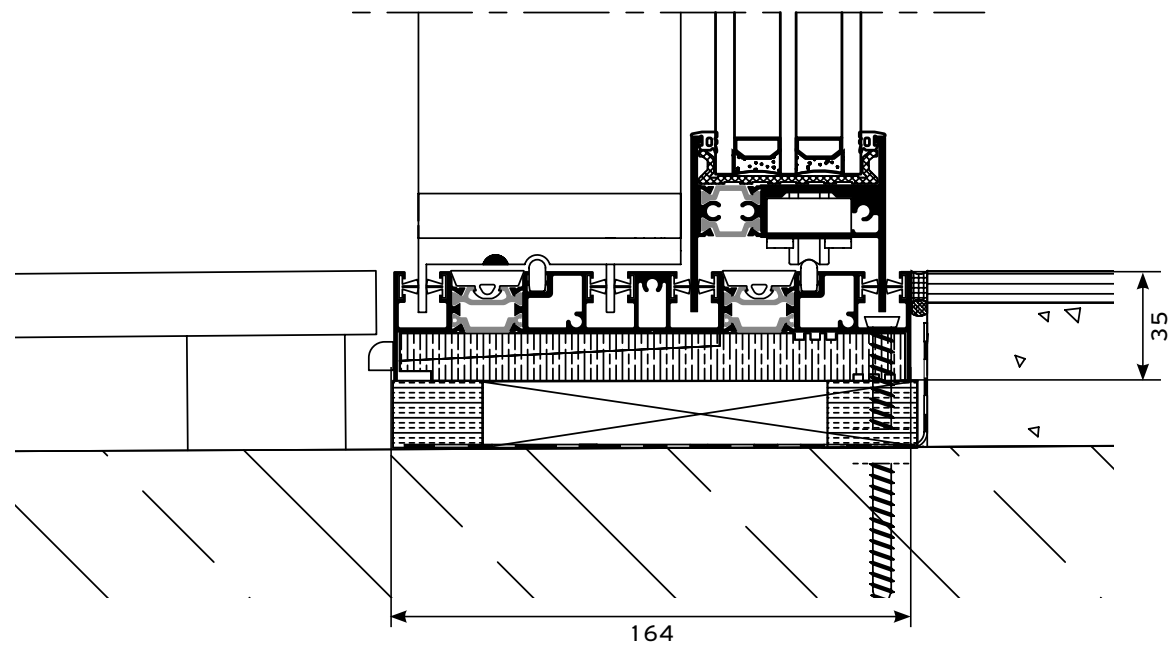

BOTTOM SECTION WITH LOW TRACK C

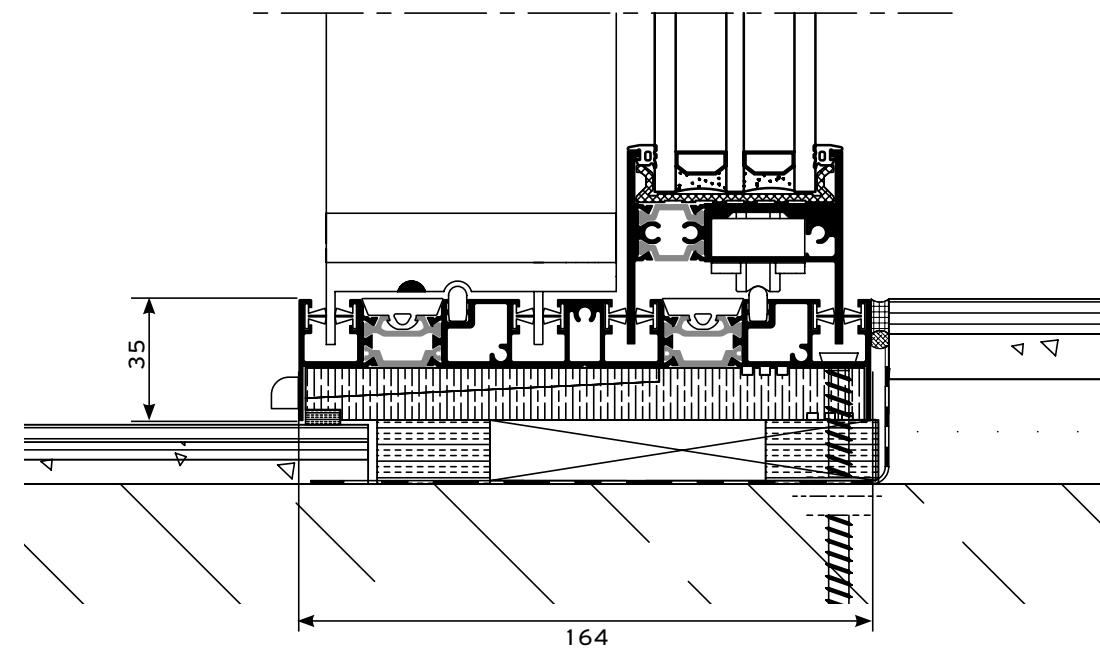

BOTTOM SECTION WITH LOW TRACK B

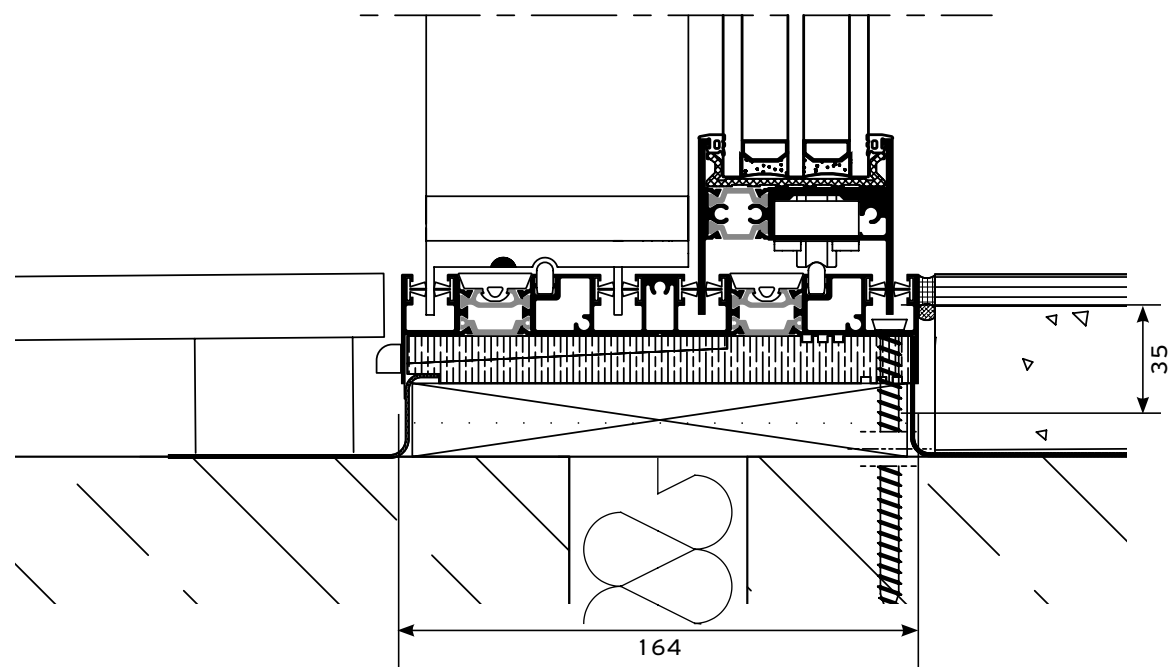

BOTTOM SECTION WITH LOW TRACK D

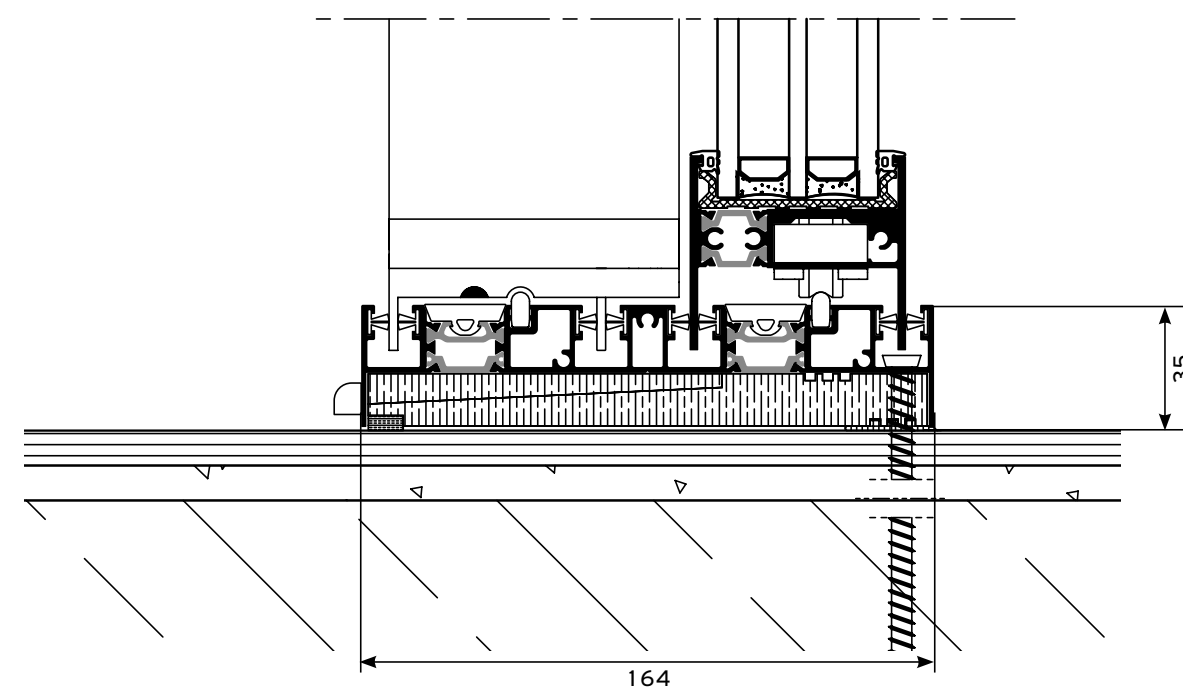

# Installation

BOTTOM SECTION WITH INTEGRATED FLYSCREEN IFS

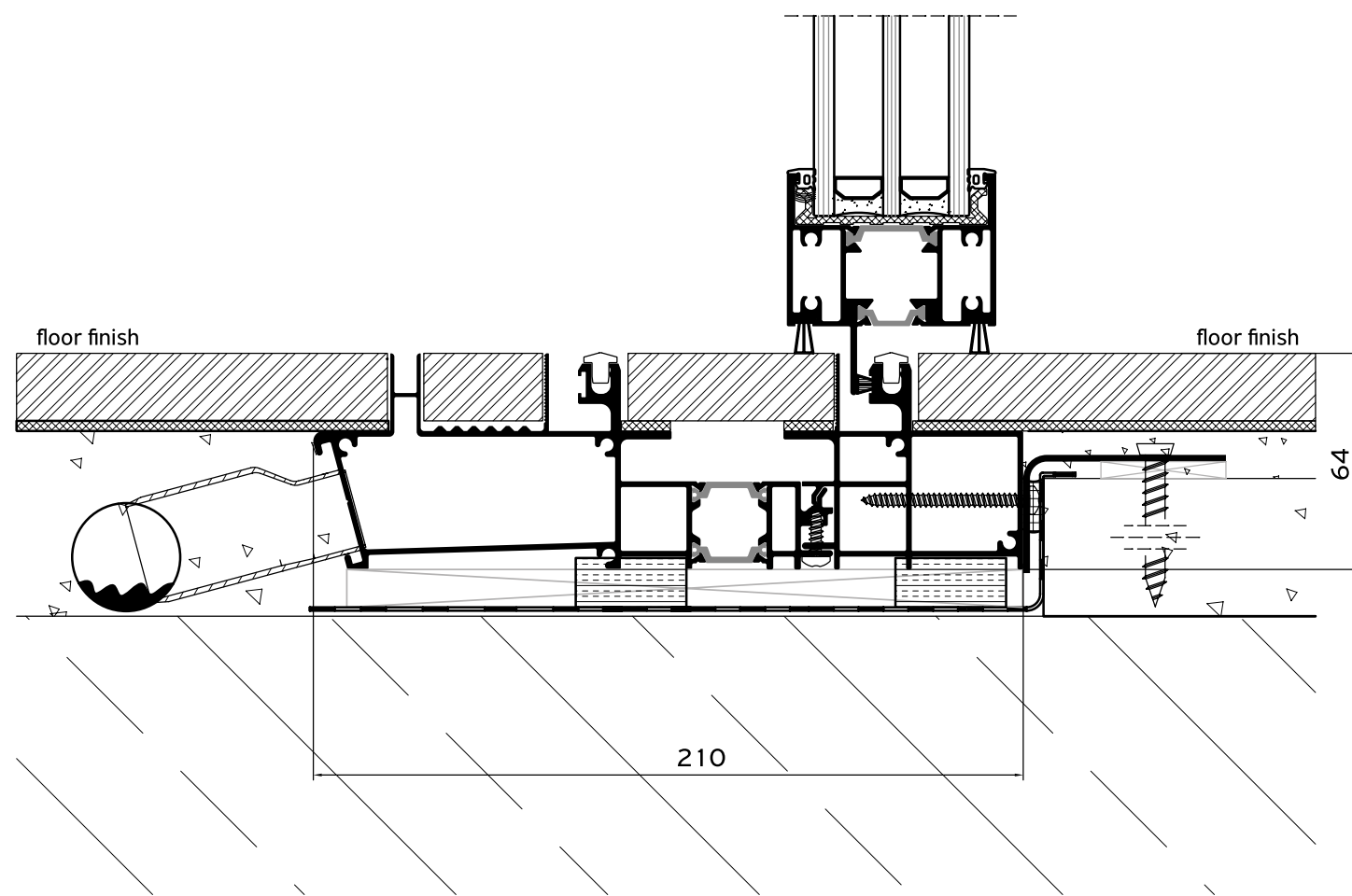

BOTTOM SECTION WITH INTEGRATED FLYSCREEN IFS  
LOW THRESHOLD

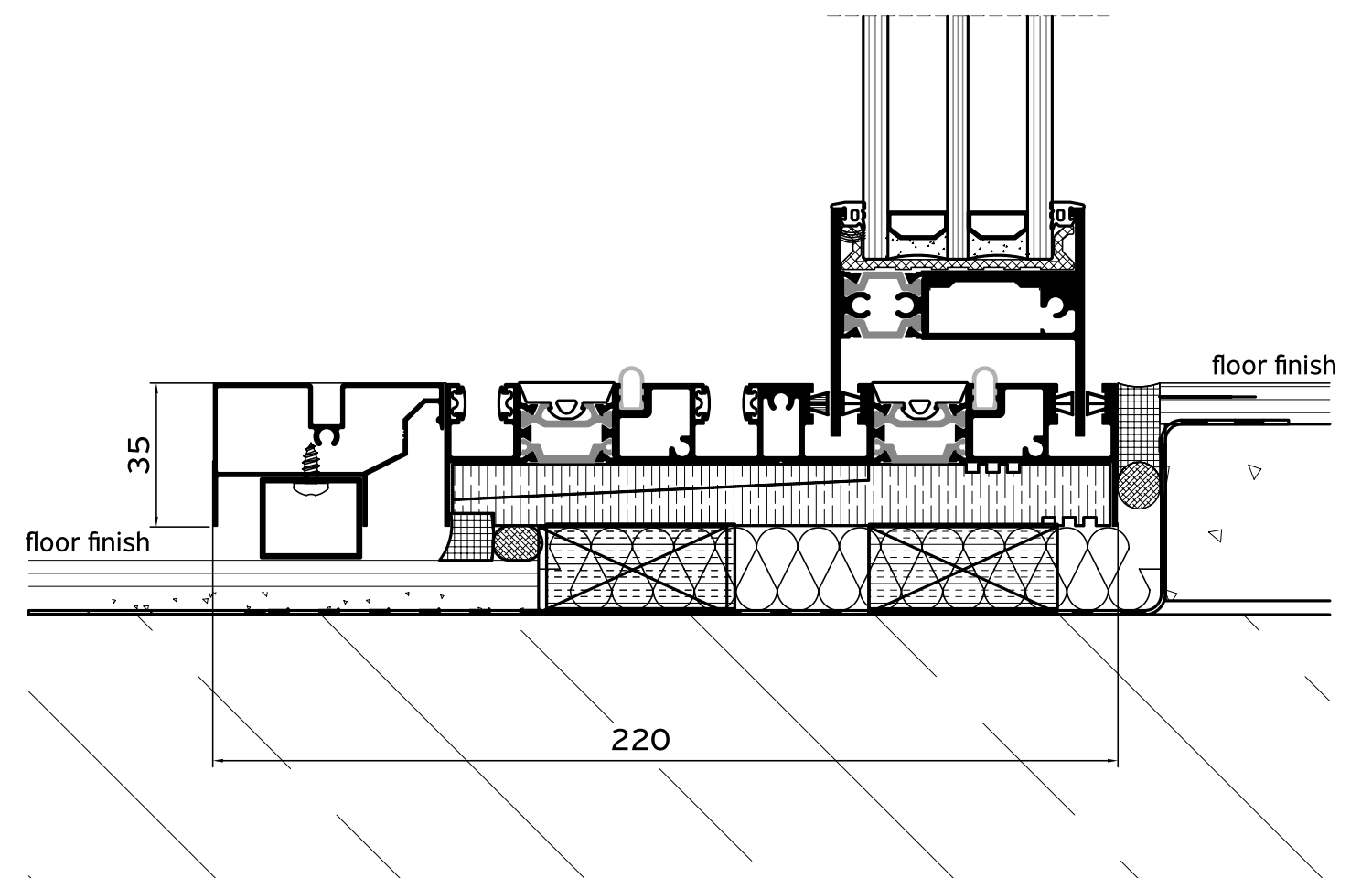

# Installation

TOP SECTION WITH INTEGRATED FLYSCREEN IFS

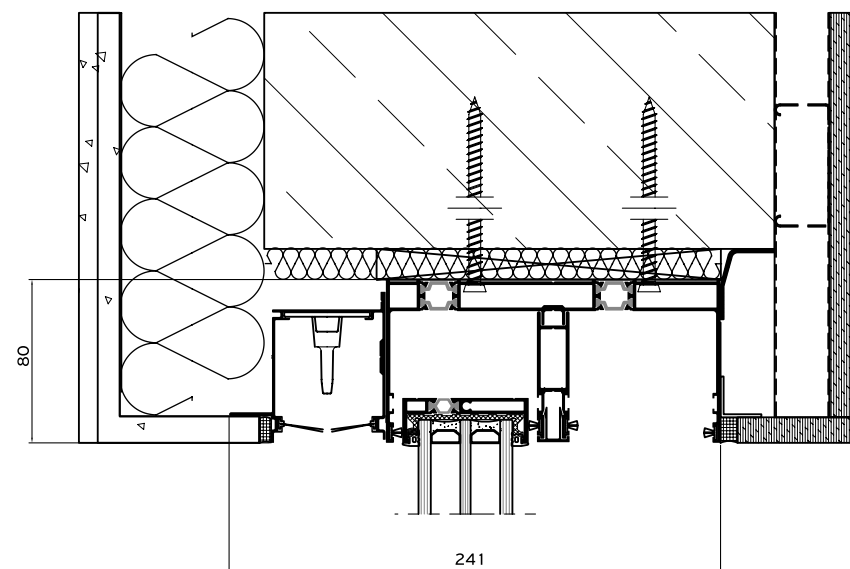

SIDE SECTION A WITH INTEGRATED FLYSCREEN IFS

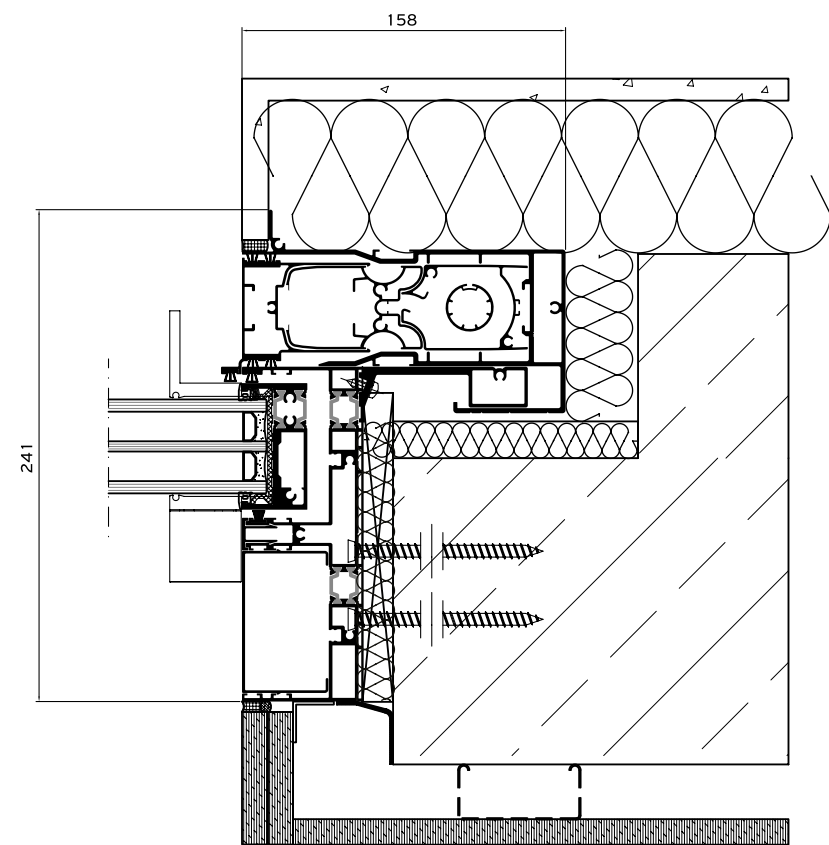

SIDE SECTION B WITH INTEGRATED FLYSCREEN IFS

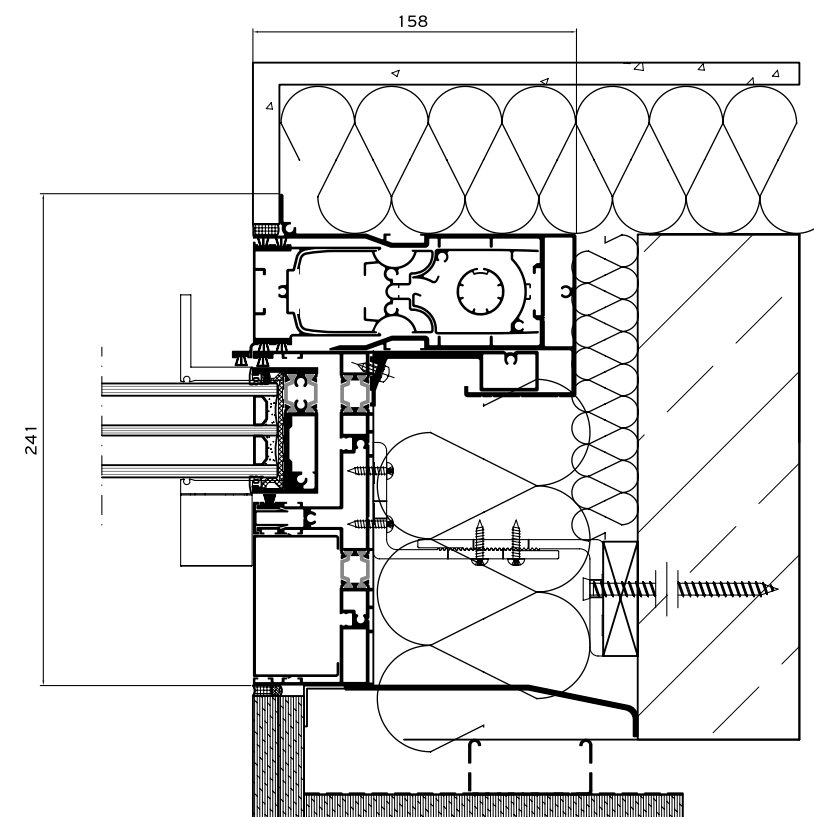

SIDE SECTION C WITH INTEGRATED FLYSCREEN IFS

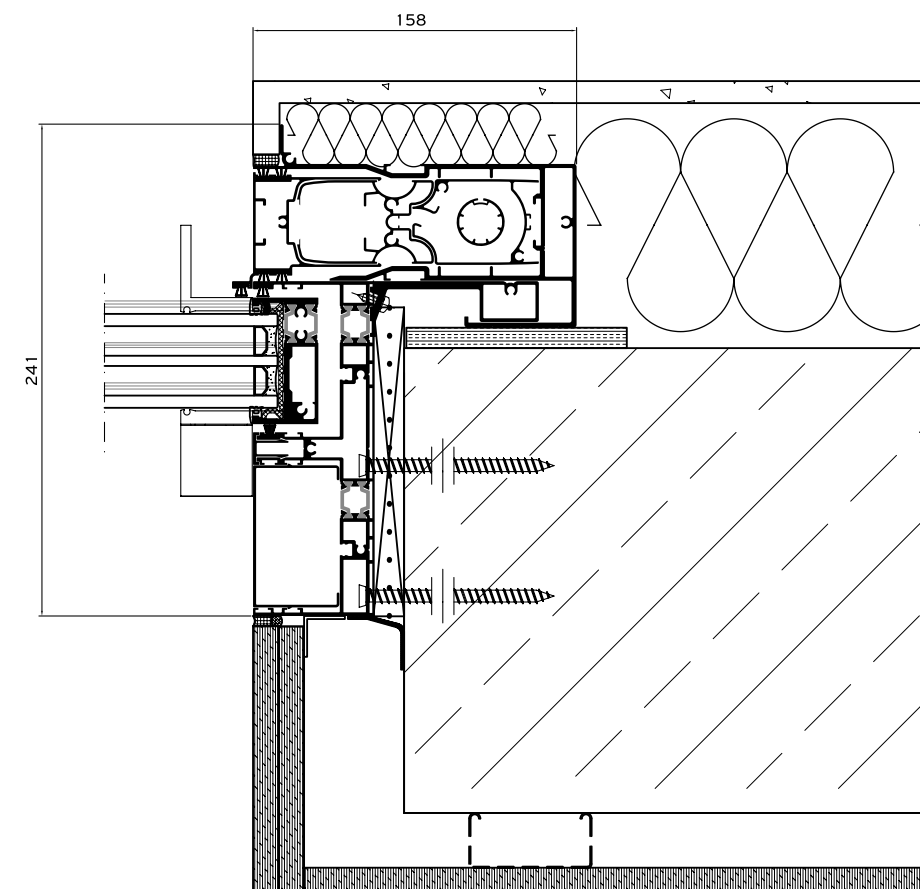



# Applications

**Alumil** SUPREME S650 PHOS SUPREME S650 ECLIPSE

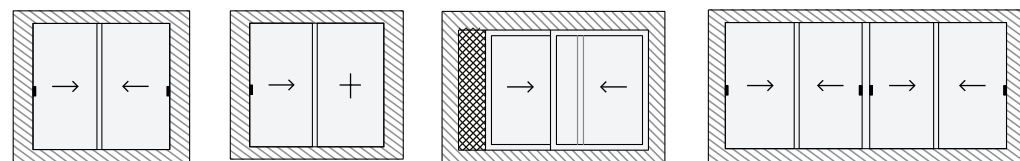

2 SASHES / 2 TRACK    1 SASH / FIXED    2 SASHES / 2 TRACK INTEGRATED FLYSCREEN IFS    4 SASHES / 2 TRACK

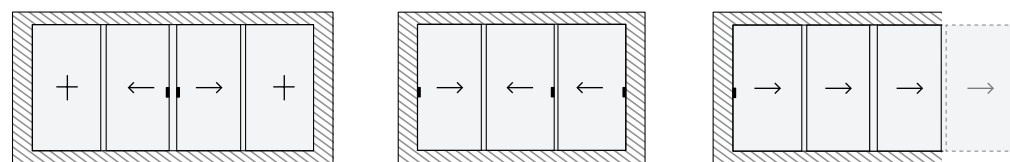

FIXED / 2 SASHES / FIXED    3 SASHES / 3 TRACK    MULTI TRACK

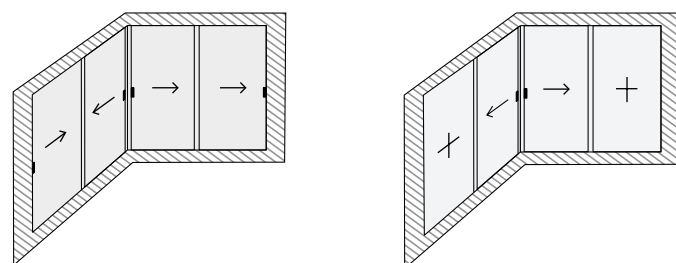

INTERNAL / EXTERNAL CORNER 2 SASHES / 2 TRACK    INTERNAL / EXTERNAL CORNER 1 SASH / FIXED

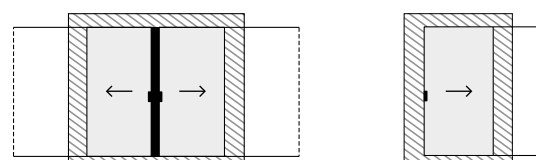

2 SASHES / 1 TRACK    1 SASH / 1 TRACK

# Table of performance

**SUPREME S650 PHOS**

**CERTIFICATION**

-  **WATER TIGHTNESS**  
EN 12208
-  **AIR PERMEABILITY**  
EN 12207
-  **WIND RESISTANCE**  
MAX TEST PRESSURE  
EN 12210
-  **WIND LOAD RESISTANCE**  
TO FRONTAL DEFLECTION  
EN 12210
-  **SOUND REDUCTION**  
EN14351
-  **BURGLAR RESISTANCE**  
EN 1627 - 1630

**CLASSIFICATION**

1A (0 Pa)	2A (50 Pa)	3A (100 Pa)	4A (150 Pa)	5A (200 Pa)	6A (250 Pa)	7A (300 Pa)	8A (450 Pa)	<b>9A (600 Pa)</b>
	1	2		3		4		
1 (400 Pa)	2 (800 Pa)		3 (1200 Pa)		4 (1600 Pa)		5 (2000 Pa)	
A (≤ 1/150)			B (≤ 1/200)		C (≤ 1/300)			
				41dB				
RC 1			RC 2			RC 3		

Alumil has also certified the systems SUPREME S650 according to AAMA & AS standards which are available upon request.

**SUPREME S650 ECLIPSE**

**CERTIFICATION**

-  **WATER TIGHTNESS**  
EN 12208
-  **AIR PERMEABILITY**  
EN 12207
-  **WIND RESISTANCE**  
MAX TEST PRESSURE  
EN 12210
-  **WIND LOAD RESISTANCE**  
TO FRONTAL DEFLECTION  
EN 12210
-  **SOUND REDUCTION**  
EN14351

**CLASSIFICATION**

1A (0 Pa)	2A (50 Pa)	3A (100 Pa)	4A (150 Pa)	5A (200 Pa)	6A (250 Pa)	7A (300 Pa)	8A (450 Pa)	<b>9A (600 Pa)</b>
	1	2		3		4		
1 (400 Pa)	2 (800 Pa)		<b>3 (1200 Pa)</b>		4 (1600 Pa)		5 (2000 Pa)	
A (≤ 1/150)			B (≤ 1/200)		C (≤ 1/300)			
				46 dB				

**THERMAL**

**DIMENSIONS IN MM (w x h)**

**U<sub>w</sub> in W/m<sup>2</sup> K (U<sub>g</sub> = 0,6)**

**U<sub>w</sub> in W/m<sup>2</sup> K (U<sub>g</sub> = 0,8)**

**U<sub>w</sub> in W/m<sup>2</sup> K (U<sub>g</sub> = 1,1)**

2 SASHES / 2 TRACK	2600 x 2400	1,14	1,32	1,59
2 SASHES / 2 TRACK LOW THRESHOLD	2600 x 2400	1,15	1,32	1,59
4 SASHES / 2 TRACK	5200 x 2400	1,12	1,30	1,57

Thermal performance for non-installed frames certified according to EN ISO 10077-2

# REFERENCE PROJECTS

- 1. PRIVATE RESIDENCE / KOS, GREECE
- 2. PRIVATE RESIDENCE / THESSALONIKI, GREECE
- 3. PRIVATE RESIDENCE / ATHENS, GREECE
- 4. SKA VILLA LAGOS / NIGERIA, AFRICA
- 5. PRIVATE RESIDENCE / AEGINA, GREECE
- 6. MAYIA EXCLUSIVE RESORT & SPA / RHODES, GREECE



1

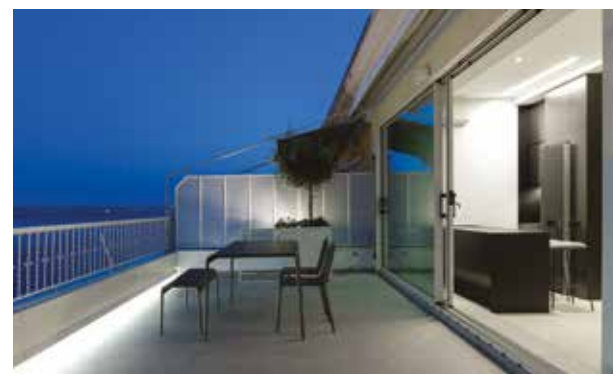

2



4



3



5



6

# REFERENCE PROJECTS

- 7. EL HOUSE / CYPRUS
- 8. H 34 / VOULA, ATHENS
- 9. ALKYONIDES VILLAS / ZANTE, GREECE

- 10. THE LAP POOL HOUSE / TINOS, GREECE
- 11. HAESLEY CONDOMINIUM / SOUTH KOREA
- 12. ARISTOTELOUS RESIDENCE / THESSALONIKI, GREECE



7



10



11



8



9



12

www.alumil.com

DISCOVER MORE:



**ALUMIL  
HEAD OFFICES  
& SHOWROOM - THESSALONIKI**

GOGOUSI 8, EFKARPIA  
THESSALONIKI - GR 56429  
TEL.: +30 2313011000  
E-MAIL.: info@alumil.com

**ALUMIL  
HEADQUARTERS**

KILKIS INDUSTRIAL AREA  
KILKIS - GR 61100  
TEL.: +30 23410 79300  
E-MAIL.: info@alumil.com



**ALUMIL  
HEAD OFFICES  
& SHOWROOM - THESSALONIKI**

GOGOUSI 8, EFKARPIA  
THESSALONIKI - GR 56429

TEL.: +30 2313 011000  
EMAIL.: info@alumil.com

**ALUMIL  
HEADQUARTERS**

KILKIS INDUSTRIAL AREA  
KILKIS - GR 61100

TEL.: +30 23410 79300  
EMAIL.: info@alumil.com

**[www.alumil.com](http://www.alumil.com)**

EN MAR 2024

The logo for ALUMIL, featuring the word 'alumil' in a bold, lowercase, sans-serif font. The letter 'l' is stylized with a diagonal slash through it. A small yellow square is positioned above the 'i'. The logo is set against a dark blue background that transitions into a large yellow diagonal shape in the bottom right corner of the page.