

CERTIFICATIONS



SPECIFICATIONS

Voltage	120V
Power Factor	>0.95
Dimmable	Triac-Dimming 100%-10%
CRI	80+ or 90+
Solution	Driver On Board

PHYSICAL

Operating Temperature	-20°C to 45°C (-4°F to 113°F)
Material	Steel
Mounting	Surface Mounted
Lens	PS Diffuser
Finish	Brush Nickel/White/Black
LED	SMD2835

PERFORMANCE

Warranty	5 years
LED Lifetime	50,000 hours
Certifications	ETL, CETL File No.5017812
IP Rating	Damp Location

LED Flush Mount



MODEL LIST

Model No.	Size	Power	Efficacy lm/W	CCT	Dimmable
CL11-N15-3C	11inch	15W	70	30/40/5000K	Yes
CL14-N15-3C	14inch	25W	70	30/40/5000K	Yes
CL16-N15-3C	16inch	25W	70	30/40/5000K	Yes
CL20-N15-3C	20inch	35W	70	30/40/5000K	Yes

DIMENSIONS / PACKING

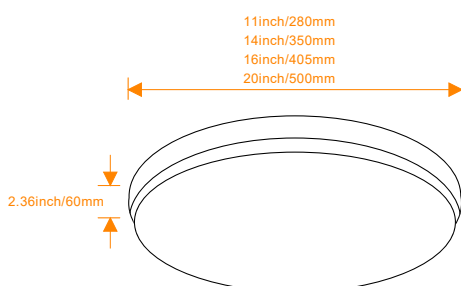

CERTIFICATIONS



SPECIFICATIONS

Voltage	120V
Power Factor	>0.95
Dimmable	Triac-Dimming 100%-10%
CRI	80+ or 90+
Solution	Driver On Board

PHYSICAL

Operating Temperature	-20°C to 45°C (-4°F to 113°F)
Material	Steel
Mounting	Surface Mounted
Lens	PMMA Diffuser
Finish	Brush Nickel/White/Black
LED	SMD2835

PERFORMANCE

Warranty	5 years
LED Lifetime	50,000 hours
Certifications	ETL, CETL File No.5017812
IP Rating	Damp Location

DIMENSIONS / PACKING

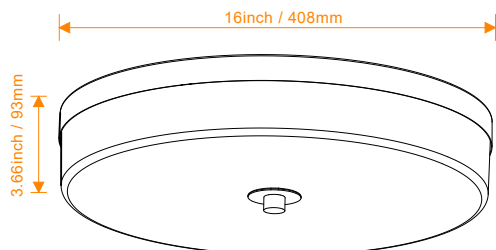

LED Flush Mount



MODEL LIST

Model No.	Size	Power	Efficacy lm/W	CCT	Dimmable
DR16	16inch	25W	70	2700K-6500K	Yes
DR16-3C	16inch	25W	70	30/40/5000K	Yes
DR16-5C	16inch	25W	70	27/30/35/40/5000K	Yes

CERTIFICATIONS



SPECIFICATIONS

Voltage	120V
Power Factor	>0.95
Dimmable	Triac-Dimming 100%-10%
CRI	80+ or 90+
Solution	Driver On Board

PHYSICAL

Operating Temperature	-20°C to 45°C (-4°F to 113°F)
Material	Steel
Mounting	Surface Mounted
Lens	PS Diffuser
Finish	Brush Nickel/White/Black
LED	SMD2835

PERFORMANCE

Warranty	5 years
LED Lifetime	50,000 hours
Certifications	ETL, CETL File No.5017812
IP Rating	Damp Location

LED Flush Mount



MODEL LIST

Model No.	Size	Power	Efficacy lm/W	CCT	Dimmable
CL13-3C	13inch	25W	70	30/40/5000K	Yes
CL13-5C	13inch	25W	70	27/30/35/40/5000K	Yes
CLF12-3C	12inch	15W	70	30/40/5000K	Yes
CLF12-5C	12inch	15W	70	27/30/35/40/5000K	Yes

DIMENSIONS / PACKING

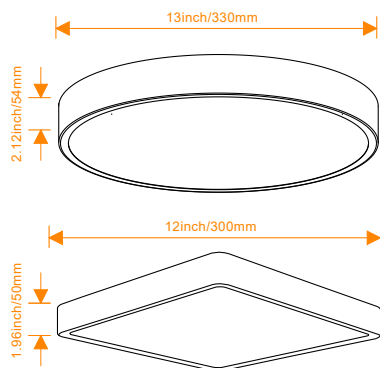

CERTIFICATIONS



SPECIFICATIONS

Voltage	120V
Power Factor	>0.95
Dimmable	Triac-Dimming 100%-10%
CRI	80+ or 90+
Solution	Driver On Board

PHYSICAL

Operating Temperature	-20°C to 45°C (-4°F to 113°F)
Material	Steel
Mounting	Surface Mounted
Lens	PS Diffuser
Finish	Brush Nickel/White/Black
LED	SMD2835

PERFORMANCE

Warranty	5 years
LED Lifetime	50,000 hours
Certifications	ETL, CETL File No.5017812
IP Rating	Damp Location

LED Slim Double Ring



2.3inch

Option 1
Internal CCT Switch



Option 2
External CCT Switch



MODEL LIST

Model No.	Size	Power	Efficacy lm/W	CCT	Dimmable
SDC10-3C	10inch	15W	70	30/40/5000K	Yes
SDC10-5C		15W	70	27/30/35/40/5000K	Yes
SDC10-3CW		5W/10W/15W (Adjustable)	70	30/40/5000K	Yes
SDC12-3C	12inch	15W	70	30/40/5000K	Yes
SDC12-5C		15W	70	27/30/35/40/5000K	Yes
SDC12-3CW		5W/10W/15W (Adjustable)	70	30/40/5000K	Yes
SDC14-3C	14inch	25W	70	30/40/5000K	Yes
SDC14-5C		25W	70	27/30/35/40/5000K	Yes
SDC14-3CW		14W/18W/25W (Adjustable)	70	30/40/5000K	Yes
SDC16-3C	16inch	25W	70	30/40/5000K	Yes
SDC16-5C		25W	70	27/30/35/40/5000K	Yes
SDC16-3CW		14W/18W/25W (Adjustable)	70	30/40/5000K	No

DIMENSIONS / PACKING

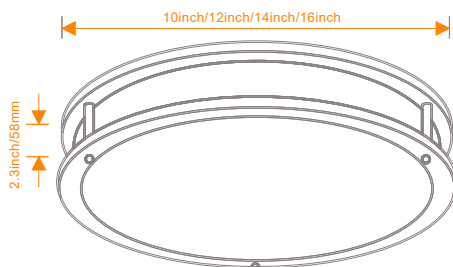

CERTIFICATIONS



SPECIFICATIONS

Voltage	120V
Power Factor	>0.95
Dimmable	Triac-Dimming 100%-10%
CRI	80+ or 90+
Solution	Driver On Board

PHYSICAL

Operating Temperature	-20°C to 45°C (-4°F to 113°F)
Material	Steel
Mounting	Surface Mounted
Lens	PS Diffuser
Finish	Brush Nickel/White/Black
LED	SMD2835

PERFORMANCE

Warranty	5 years
LED Lifetime	50,000 hours
Certifications	ETL, CETL File No.5017812
IP Rating	Damp Location

LED Slim Single Ring Flush Mount



MODEL LIST

Model No.	Size	Power	Efficacy lm/W	CCT	Dimmable
SCL12-JBY-3C	12inch	15W	70	30/40/5000K	Yes
SCL12-JBY-5C	12inch	15W	70	27/30/35/40/5000K	Yes
SCL14-JBY-3C	14inch	25W	70	30/40/5000K	Yes
SCL14-JBY-5C	14inch	25W	70	27/30/35/40/5000K	Yes
SCL16-JBY-3C	16inch	25W	70	30/40/5000K	Yes
SCL16-JBY-5C	16inch	25W	70	27/30/35/40/5000K	Yes

DIMENSIONS / PACKING

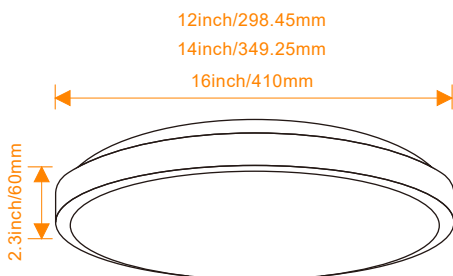

CERTIFICATIONS



SPECIFICATIONS

Voltage	120V
Power Factor	>0.95
Dimmable	Triac-Dimming 100%-10%
CRI	80+ or 90+
Solution	Driver Built In

PHYSICAL

Operating Temperature	-20°C to 45°C (-4°F to 113°F)
Material	Plastic
Mounting	Surface Mounted
Lens	PS Diffuser
Finish	White/Black
LED	SMD2835

PERFORMANCE

Warranty	5 years
LED Lifetime	50,000 hours
Certifications	ETL, CETL File No.5017812
IP Rating	Damp Location

DIMENSIONS / PACKING LIST

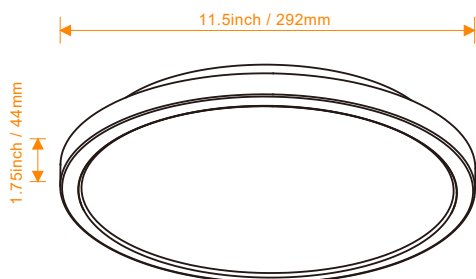

LED Flush Mount With Night Light



MODEL LIST

Model No.	Size	Power	Efficacy lm/W	CCT	Dimmable
PL12P-NL	12inch	20W+5W	70	(2700K-6500K)+NL	Yes
PL12P-3C-NL	12inch	20W+5W	70	30/40/5000K+NL	Yes
PL12P-5C-NL	12inch	20W+5W	70	27/30/35/40/5000K+NL	Yes

CERTIFICATIONS



SPECIFICATIONS

Voltage	120V
Power Factor	>0.95
Dimmable	0-10V 100%-10%
CRI	80+ or 90+
Solution	Driver Built In

PHYSICAL

Operating Temperature	-20°C to 45°C (-4°F to 113°F)
Material	Steel
Mounting	Surface Mounted
Lens	PMMA Diffuser
Finish	White/Black
LED	SMD2835

PERFORMANCE

Warranty	5 years
LED Lifetime	50,000 hours
Certifications	ETL, CETL File No.5017812
IP Rating	Damp Location

Sensor Pluggable Smart PANEL

Sensor Pluggable design
Make products smarter

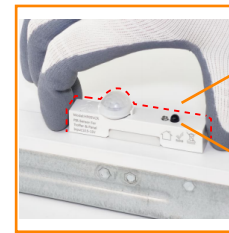

MODEL LIST

Model No.	Size	3 CCT	3 Power	Efficacy lm/W	Smart module pluggable
SMPL-22	2X2FT	30/40/5000K	30W/25W/20W	120	+
SMPL-24	2X4FT	30/40/5000K	30W/25W/20W	120	
SMPL-14	1X4FT	30/40/5000K	30W/25W/20W	120	

DIMENSIONS

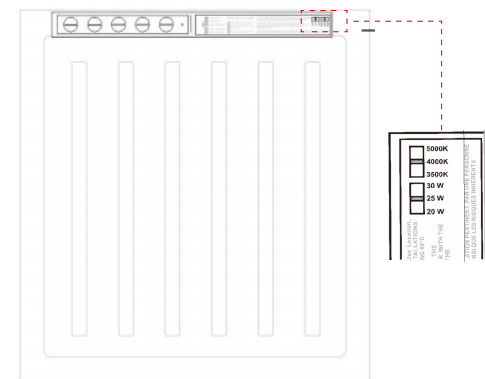
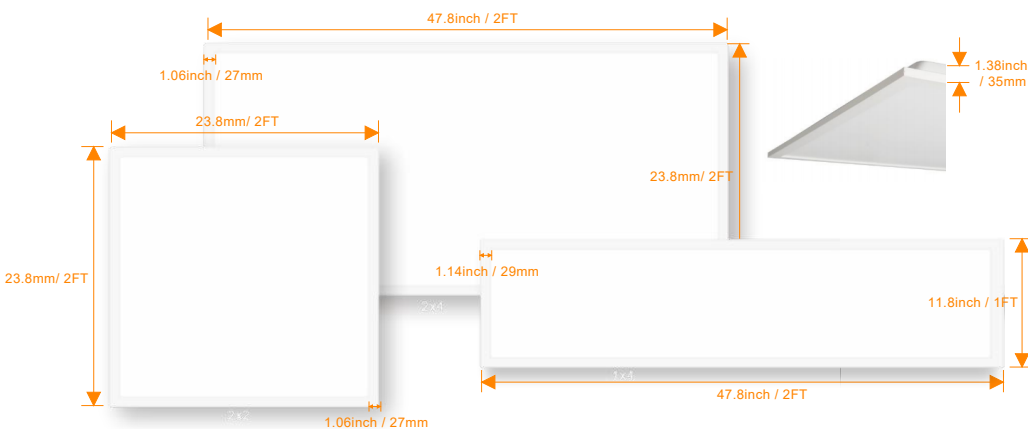

CERTIFICATIONS



SPECIFICATIONS

Voltage	120V
Power Factor	>0.95
Dimmable	Triac-Dimming 100%-10%
CRI	80+ or 90+
Solution	Driver Built In

PHYSICAL

Operating Temperature	-20°C to 45°C (-4°F to 113°F)
Material	Steel
Mounting	Surface Mounted
Lens	PS Diffuser
Finish	White/Black
LED	SMD2835

PERFORMANCE

Warranty	5 years
LED Lifetime	50,000 hours
Certifications	ETL, CETL File No.5017812
IP Rating	Damp Location

INSTALLATION / PACKING



Square Ultra Slim Panel Light

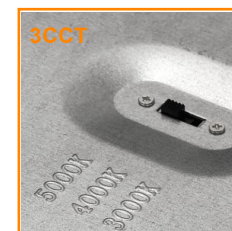
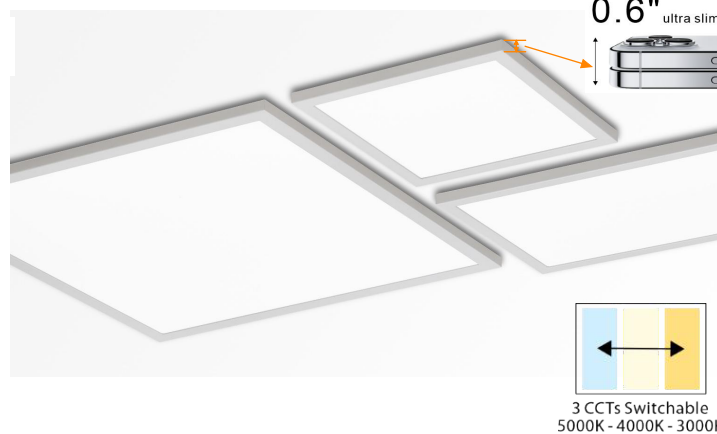

MODEL LIST

Model No.	Size	Power	Efficacy lm/W	CCT	Dimmable
USPL-11	1X1FT	24W	100	30/40/5000K	Yes
USPL-12	1X2FT	24W	100	30/40/5000K	Yes
USPL-14	1X4FT	40W	100	30/40/5000K	Yes
USPL-22	2X2FT	40W	100	30/40/5000K	Yes

CERTIFICATIONS



SPECIFICATIONS

Voltage	120V
Power Factor	>0.95
Dimmable	Triac-Dimming 100%-10%
CRI	80+ or 90+
Solution	Driver On Board

PHYSICAL

Operating Temperature	-20°C to 45°C (-4°F to 113°F)
Material	Steel
Mounting	Surface Mounted
Lens	PS Diffuser
Finish	White/Black
LED	SMD2835

PERFORMANCE

Warranty	5 years
LED Lifetime	50,000 hours
Certifications	ETL, CETL File No.5017812
IP Rating	Damp Location

LED Flush Mount (Frameless)

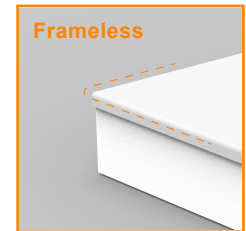
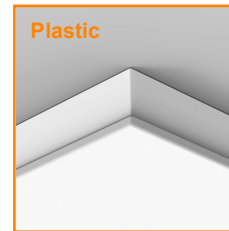
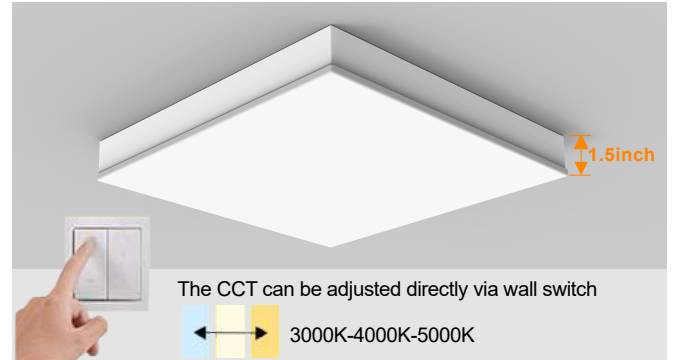

MODEL LIST

Model No.	Size	Power	Efficacy lm/W	CCT	Dimmable
FLPL-1212	12inch*12inch	20W	80	30/40/5000K	Yes
FLPL-1214	12inch*24inch	24W	80	30/40/5000K	Yes
FLPL-1248	12inch*48inch	40W	80	30/40/5000K	Yes
FLPL-1818	18inch*18inch	40W	80	30/40/5000K	Yes
FLPL-2424	24inch*24inch	45W	80	30/40/5000K	Yes

INSTALLATION / PACKING



CERTIFICATIONS



SPECIFICATIONS

Voltage	120V
Power Factor	>0.95
Dimmable	Triac-Dimming 100%-10%
CRI	80+ or 90+
Solution	Driver On Board

PHYSICAL

Operating Temperature	-20°C to 45°C (-4°F to 113°F)
Material	Stainless Steel
Mounting	Wall Mounted
Lens	PMMA Diffuser
Finish	Brush Nickel/White/Black
LED	SMD2835

PERFORMANCE

Warranty	5 years
LED Lifetime	50,000 hours
Certifications	ETL, CETL File No.5017812
IP Rating	Damp Location

DIMENSIONS / PACKING LIST

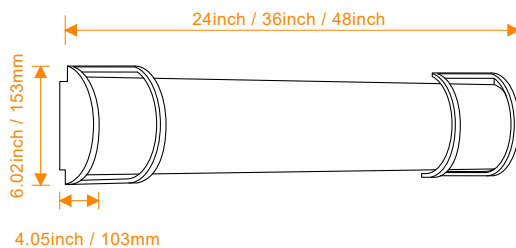

LED Vanity Light

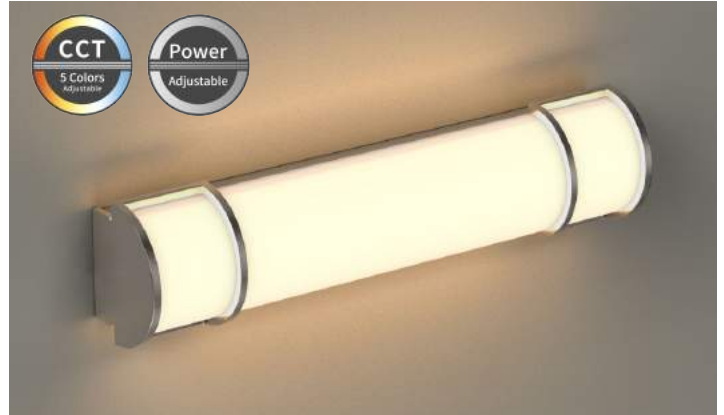

MODEL LIST

Model No.	Size	Power	Efficacy lm/W	CCT	Dimmable
V2A	2FT	25W	70	2700K-6500K	Yes
V2A-3C		25W	70	3000K/4000K/5000K	Yes
V2A-3CW		14W/18W/25W (Adjustable)	70	3000K/4000K/5000K	Yes
V3A	3FT	30W	70	2700K-6500K	Yes
V3A-3C		30W	70	3000K/4000K/5000K	Yes
V3A-3CW		20W/25W/30W (Adjustable)	70	3000K/4000K/5000K	Yes
V4A	4FT	35W	70	2700K-6500K	Yes
V4A-3C		35W	70	3000K/4000K/5000K	Yes
V4A-3CW		25W/30W/35W (Adjustable)	70	3000K/4000K/5000K	Yes

CERTIFICATIONS



SPECIFICATIONS

Voltage	120V
Power Factor	>0.95
Dimmable	Triac-Dimming 100%-10%
CRI	80+ or 90+
Solution	Driver On Board

PHYSICAL

Operating Temperature	-20°C to 45°C (-4°F to 113°F)
Material	Stainless Steel
Mounting	Wall Mounted
Lens	PMMA Diffuser
Finish	Brush Nickel/White/Black
LED	SMD2835

PERFORMANCE

Warranty	5 years
LED Lifetime	50,000 hours
Certifications	ETL, CETL File No.5017812
IP Rating	Damp Location

DIMENSIONS / PACKING LIST

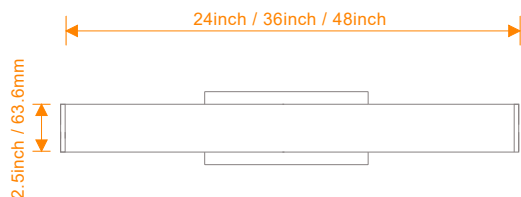

LED Vanity Light

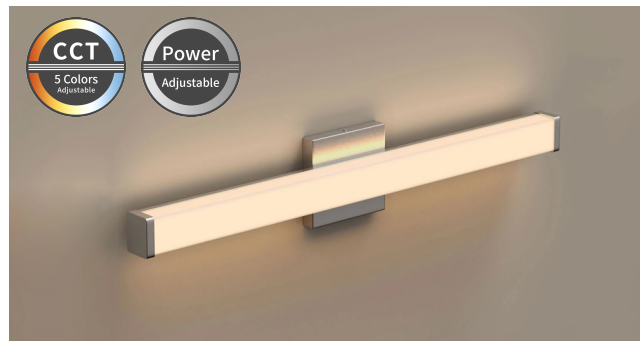

MODEL LIST

Model No.	Size	Power	Efficacy lm/W	CCT	Dimmable
V2A-03	2FT	25W	70	2700K-6500K	Yes
V2A-03-3C		25W	70	3000K/4000K/5000K	Yes
V2A-03-3CW		14W/18W/25W (Adjustable)	70	3000K/4000K/5000K	Yes
V3A-03	3FT	30W	70	2700K-6500K	Yes
V3A-03-3C		30W	70	3000K/4000K/5000K	Yes
V3A-03-3CW		20W/25W/30W (Adjustable)	70	3000K/4000K/5000K	Yes
V4A-03	4FT	35W	70	2700K-6500K	Yes
V4A-03-3C		35W	70	3000K/4000K/5000K	Yes
V4A-03-3CW		25W/30W/35W (Adjustable)	70	3000K/4000K/5000K	Yes

CERTIFICATIONS



SPECIFICATIONS

Voltage	120V
Power Factor	>0.95
Dimmable	Triac-Dimming 100%-10%
CRI	80+ or 90+
Solution	Driver On Board

PHYSICAL

Operating Temperature	-20°C to 45°C (-4°F to 113°F)
Material	Stainless Steel
Mounting	Wall Mounted
Lens	PMMA Diffuser
Finish	Brush Nickel/White/Black
LED	SMD2835

PERFORMANCE

Warranty	5 years
LED Lifetime	50,000 hours
Certifications	ETL, CETL File No.5017812
IP Rating	Damp Location

DIMENSIONS / PACKING LIST

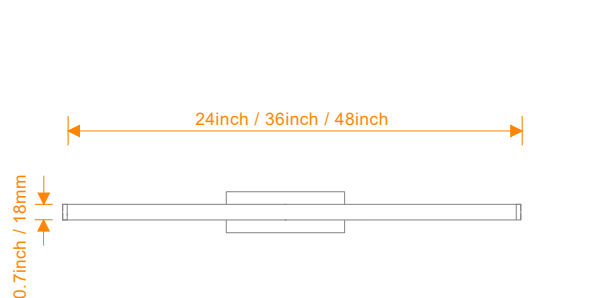

LED Vanity Light

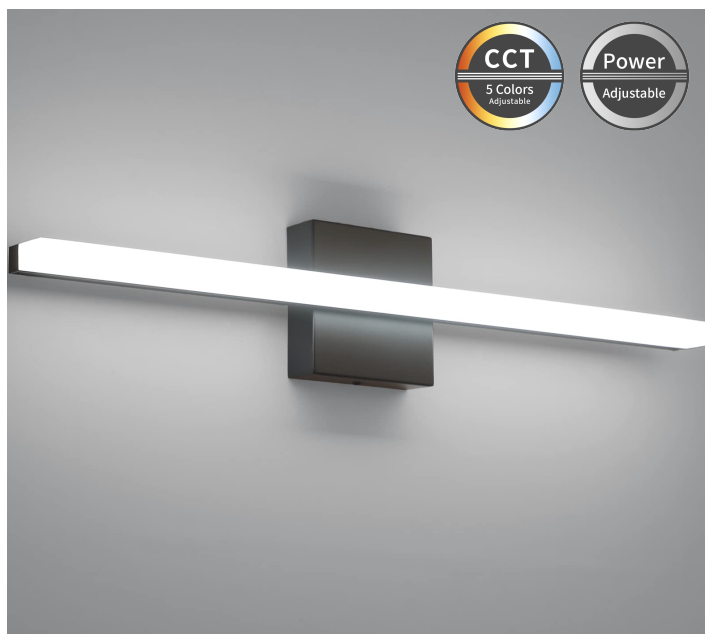

MODEL LIST

Model No.	Size	Power	Efficacy lm/W	CCT	Dimmable
V2A-04	2FT	25W	70	2700K-6500K	Yes
V2A-04-3C		25W	70	3000K/4000K/5000K	Yes
V2A-04-3CW		14W/18W/25W (Adjustable)	70	3000K/4000K/5000K	Yes
V3A-04	3FT	30W	70	2700K-6500K	Yes
V3A-04-3C		30W	70	3000K/4000K/5000K	Yes
V3A-04-3CW		20W/25W/30W (Adjustable)	70	3000K/4000K/5000K	Yes
V4A-04	4FT	35W	70	2700K-6500K	Yes
V4A-04-3C		35W	70	3000K/4000K/5000K	Yes
V4A-04-3CW		25W/30W/35W (Adjustable)	70	3000K/4000K/5000K	Yes

CERTIFICATIONS



SPECIFICATIONS

Voltage	120V
Power Factor	>0.95
Dimmable	Triac-Dimming 100%-10%
CRI	80+ or 90+
Solution	Driver Built In

PHYSICAL

Operating Temperature	-20°C to 45°C (-4°F to 113°F)
Material	Steel
Mounting	Surface Mounted
Lens	PS Diffuser
Finish	White/Black
LED	SMD2835

PERFORMANCE

Warranty	5 years
LED Lifetime	50,000 hours
Certifications	ETL, CETL File No.5017812
IP Rating	Damp Location

Over Size LED Slim Panel Light



MODEL LIST

Model No.	Size	Power	Efficacy lm/W	CCT	Dimmable
PL16-3C	16inch	24W	70	30/40/5000K	Yes
PL16-3C	16inch	24W	70	30/40/5000K	Yes

DIMENSIONS / PACKING

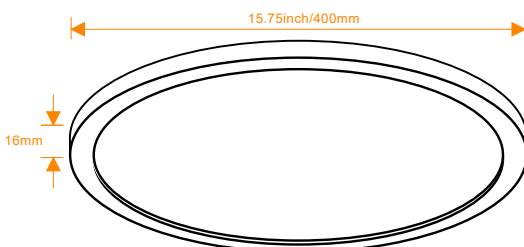

CERTIFICATIONS



SPECIFICATIONS

Voltage	120V
Power Factor	>0.95
Dimmable	Triac-Dimming 100%-10%
CRI	80+ or 90+
Solution	Driver Built In

PHYSICAL

Operating Temperature	-20°C to 45°C (-4°F to 113°F)
Material	Steel
Mounting	Surface Mounted
Lens	PS Diffuser
Finish	White/Black
LED	SMD2835

PERFORMANCE

Warranty	5 years
LED Lifetime	50,000 hours
Certifications	ETL, CETL File No.5017812
IP Rating	Damp Location

LED 3CCT Slim Panel Light



MODEL LIST

Model No.	Size	Power	Efficacy lm/W	CCT	Dimmable
PL05-3C	5inch	6W	70	30/40/5000K	Yes
PL07-3C	7inch	12W	70	30/40/5000K	Yes
PL09-3C	9inch	18W	70	30/40/5000K	Yes
PL12-3C	12inch	24W	70	30/40/5000K	Yes
PL05-5C	5inch	6W	70	27/30/35/40/5000K	Yes
PL07-5C	7inch	12W	70	27/30/35/40/5000K	Yes
PL09-5C	9inch	18W	70	27/30/35/40/5000K	Yes
PL12-5C	12inch	24W	70	27/30/35/40/5000K	Yes

DIMENSIONS / PACKING

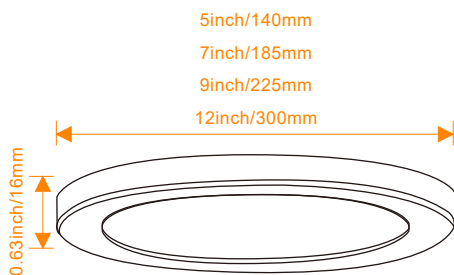

CERTIFICATIONS



SPECIFICATIONS

Voltage	120V
Power Factor	>0.95
Dimmable	Non-Dimming
CRI	80+ or 90+
Solution	Driver Built In

PHYSICAL

Operating Temperature	-20°C to 45°C (-4°F to 113°F)
Material	Steel
Mounting	Surface Mounted
Lens	PS Diffuser
Finish	White/Black
LED	SMD2835

PERFORMANCE

Warranty	5 years
LED Lifetime	50,000 hours
Certifications	ETL, CETL File No.5017812
IP Rating	Damp Location

LED 3CCT + PIR Slim Panel Light



MODEL LIST

Model No.	Size	Power	Efficacy lm/W	CCT	Dimmable
PL05-3C	5inch	6W	70	30/40/5000K + PIR	No
PL07-3C	7inch	12W	70	30/40/5000K + PIR	No
PL09-3C	9inch	18W	70	30/40/5000K + PIR	No
PL12-3C	12inch	24W	70	30/40/5000K + PIR	No

Function

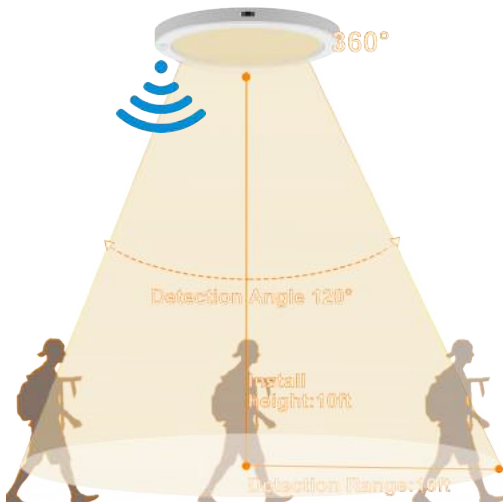

PIR Sensor Mode

- Option 1
Only ON/OFF
- Option 2
The light brightness gradually increases to 100% (20S) when turn on and gradually decreases to 0% when turn off.
- Option 3
The light keeps at 30% or 20% or 10% brightness when people walk out of detective area.

Detection Pattern

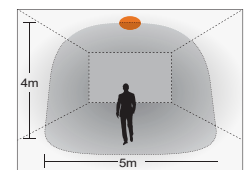

ceiling mounting pattern (m)

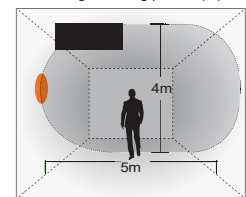

wall mounting pattern (m)

CERTIFICATIONS



SPECIFICATIONS

Voltage	120V
Power Factor	>0.95
Dimmable	Triac-Dimming 100%-10%
CRI	80+ or 90+
Solution	Driver On Board

PHYSICAL

Operating Temperature	-20°C to 45°C (-4°F to 113°F)
Material	Aluminum
Mounting	Pendent
Lens	PS Diffuser
Finish	White/Black
LED	SMD2835

PERFORMANCE

Warranty	5 years
LED Lifetime	50,000 hours
Certifications	ETL, CETL File No.5017812
IP Rating	Damp Location

DIMENSIONS / PACKING

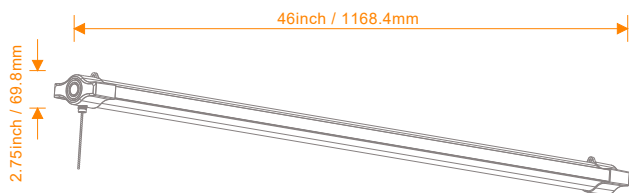

LED Shop Light



MODEL LIST

Model No.	Size	Power	Efficacy lm/W	CCT	Dimmable
SL4AV	46inch	48W / 60W	80	2700K-6500K	Yes
SL4AV-3C	46inch	48W / 60W	80	30/40/5000K	Yes
SL4AV-5C	46inch	48W / 60W	80	27/30/35/40/5000K	Yes
SL4AV-PIR (Sensor)	46inch	48W / 60W	80	2700K-6500K	No