



**MADE IN
GERMANY!**

HEICO-LOCK® WEDGE LOCKING SYSTEMS

HEICO-LOCK® Wedge Locking Systems – high quality anti-vibration security for the most demanding of bolted joint applications!

HEICO-LOCK®
WEDGE LOCK WASHERS

The proven locking system for the most demanding of bolted joint applications.

> Page 06

HEICO-LOCK®
RING LOCK WASHERS

The innovative system with added security.

> Page 06

HEICO-LOCK®
WEDGE LOCK NUTS

Combined. Efficient. Safe!

> Page 10

HEICO-LOCK®
COMBI-WASHERS

Flexible. Fast. Innovative.

> Page 12

HEICO-LOCK®
HLK-WASHERS FOR STEEL CONSTRUCTION

The anti-vibration bolt securing system for HV sets.

> Page 14

HEICO-LOCK®
PLUS

The easy-to-assemble combination of nut and washer.

> Page 16

HEICO-LOCK®
SPECIAL PRODUCTS

The individual bolt securing system.

> Page 18

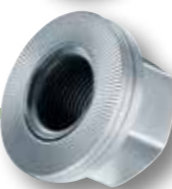
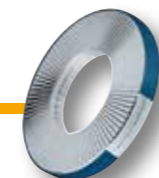
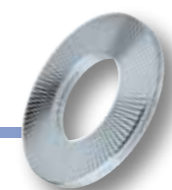

THE TASK: TO SECURE!

Bolted connections tend to work themselves loose under certain operating conditions. Vibrations cause particular problems as they can overpower the “self-locking effect” of bolted connections. This can lead to functional failure or even to the connection coming apart. As it’s not always possible to know what forces are acting on the structure, and as constructional measures cannot be implemented everywhere, securing elements are often used.

However, certain securing elements no longer comply with state-of-the-art technology and are ineffective in modern,

weight and cost-optimised structures using high-tensile bolts and nuts. The corresponding standards have been withdrawn by the German Institute for Standardisation (DIN). A few others have been downgraded to the rank of bolt retainers as they do not prevent self-loosening but do stop the connection from falling apart.

Effective securing elements maintain a high pre-load force, reliably supporting the function even under extreme operating conditions.

One of the few effective securing technologies available is the HEICO-LOCK® Wedge Locking Systems, the effectiveness of which has been demonstrated by the latest experimental standards (including DIN 65151, DIN 25201-4, NASM 1312-7).

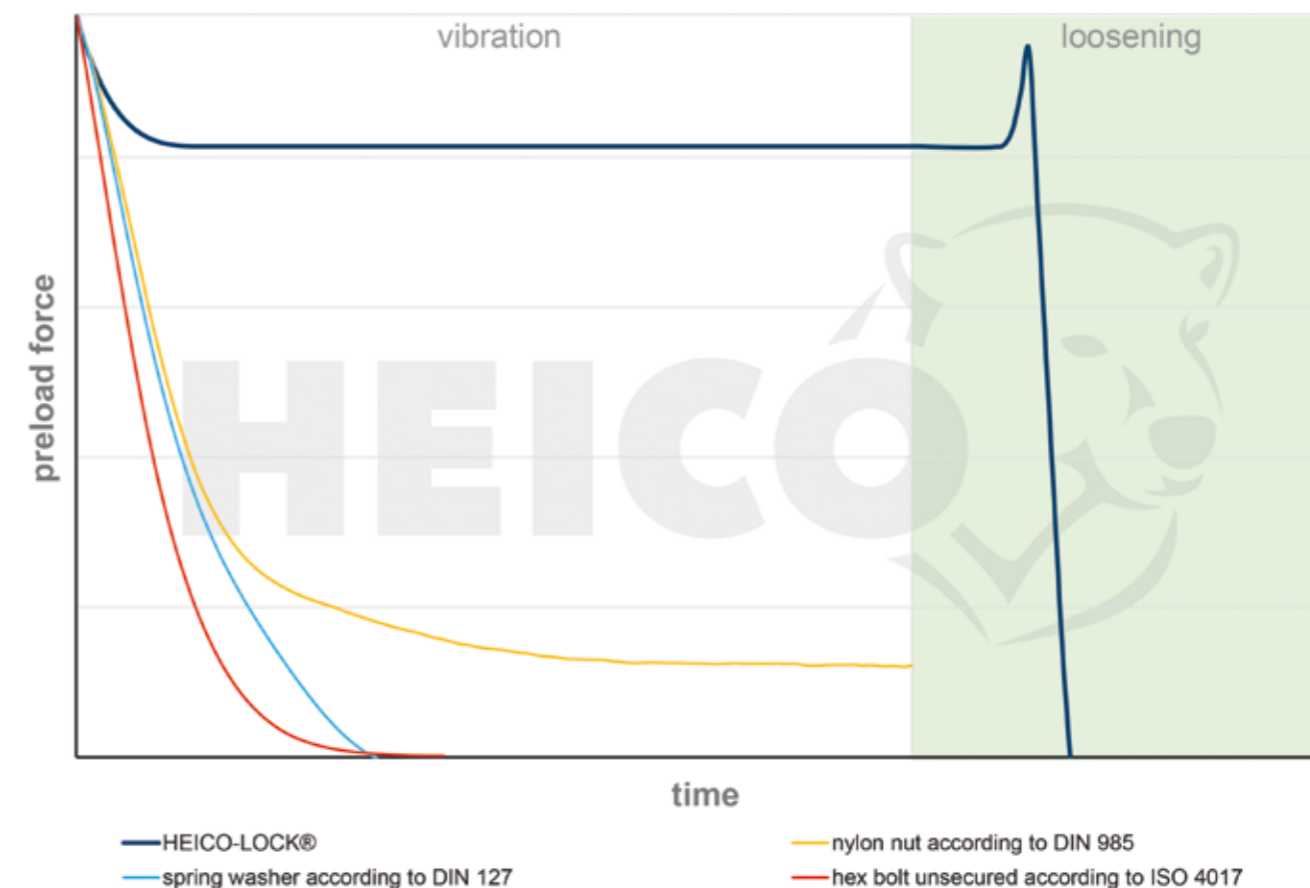

Chart: The process of preload force loss as demonstrated by vibration testing to DIN 65151 / DIN 25201-4

HEICO-LOCK® WEDGE LOCKING SYSTEM

THE HEICO-LOCK® WEDGE LOCKING SYSTEM

Even under extremes of vibration or dynamic loads, the HEICO-LOCK® Wedge Locking System provides maximum reliability. When the bolt is tightened, the external radial teeth of the HEICO-LOCK® Wedge Locking System embed themselves in an interlocking fashion with the respective mating surface.

If the securing system is subject to dynamic stress, movement is only possible between the internal washer surfaces. This results in an increase in the clamping force.

FUNCTIONAL PRINCIPLE

An important feature of HEICO-LOCK® Wedge Locking System, setting it apart from other systems that are available, is the securing of the bolt fastening using preload force rather than friction

- Wedge-shaped cams on the inside of the lock washers, radial teeth on the outside
- Interlocking embedding of the radial teeth with the respective mating surface (when tightening the bolted joint)
- System movement only possible between the inner wedge shaped cams. Movement across these wedge shaped surfaces effectively self locks the bolt.
- Increase in clamping force



TECHNICAL DATA



1. Difference in hardness: $H_{HEICO} > H_{Material}$

- The surface hardness of HEICO-LOCK® Wedge Lock Washers is greater than that of structural grade and high tensile bolts (e.g. strength classes: 8.8, 10.9, 12.9)
Steel (through-hardened, zinc flake coated) 485 ±25 HV0.3
Stainless steel (surface-hardened) > 520 HV0.05



2. Difference in angles: $\alpha > \beta$

- The wedge angle (α) between the HEICO-LOCK® Wedge Lock Washers is greater than the pitch (β) of the bolt thread
- This angle means the expansion in thickness of the HEICO-LOCK® Wedge Lock Washers is greater than the possible longitudinal movement of the bolt along the thread

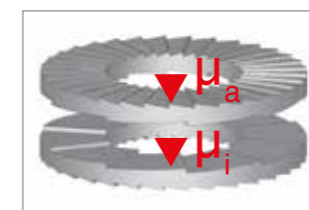

3. Difference in friction: $\mu_a > \mu_i$

- The wedge-shaped surfaces have a considerably lower friction coefficient μ_i than the toothed outside of the washers (friction coefficient μ_a)
- Loosening caused by dynamic stresses causes movement between the two washers in the region of the wedged surfaces

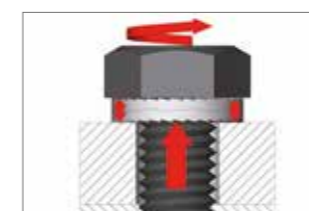

4. Difference in preload: $F_{dyn} > F_{stat}$

- An expansion in thickness of the HEICO-LOCK® Wedge Lock Washers as a result of loosening leads to an increase in the clamping force
- This causes an increase in the preload compared to when in a static state and thus causes the bolt to self-lock

INSTALLATION EXAMPLES

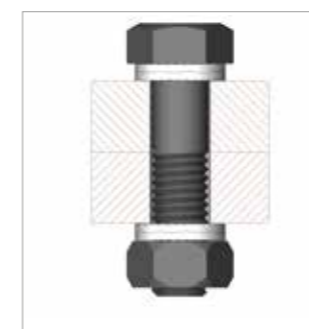

Hexagon bolt in a through-hole, secured on both sides



Hexagon bolt secured in a blind hole



Countersunk socket head bolt secured in position



No locking function when combined with flat and freely rotating washers



HEICO-LOCK® WEDGE LOCK WASHERS

THE PROVEN LOCKING SYSTEM FOR THE MOST DEMANDING OF BOLTED JOINT APPLICATIONS.

The self-loosening of bolted joints is one of the most commonly occurring failure modes in the operation of machines and systems. HEICO-LOCK® Wedge Lock Washers prevent loosening of the bolted joint by providing a safe and reliable bolt securing system - even for extremes of vibration or dynamic loads.

- Certified system for securing bolts, working at low and high preload levels
- Particularly suitable for dynamic loads – including when using lubricants
- Can be re-used
- Very easy to install and remove (Wedge Lock Washers are supplied as a pre-assembled pair)
- Also suitable for high-tensile bolts of 8.8, 10.9 and 12.9 and their respective nuts
- Available in steel or stainless steel with narrow or wide bearing surfaces – other materials are available upon request
- Available from M3 – M76 and ¼" – 3" - custom sizes upon request

SPECIAL MATERIALS

In addition to our HEICO-LOCK® Wedge Lock Washers made from steel [1.1191 / C45E] and stainless steel [1.4404 / 316L] we also produce our products from other special materials like 254 SMO® [1.4547] and INCONEL® / Alloy 718 [2.4668]. These special materials are resistant in highly corrosive environments (i.e. seawater or acids) with a high temperature stability. This leads to a wide variety of applications, especially within the offshore industry, energy sector, chemical industry and many more.

FIELDS OF APPLICATION



MECHANICAL ENGINEERING



OFFSHORE



AGRICULTURAL TECHNOLOGY

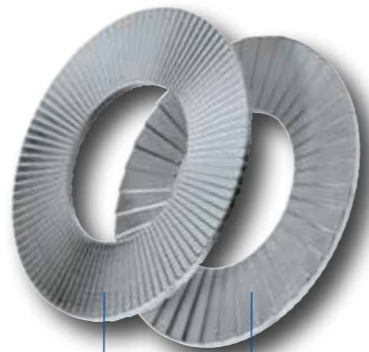
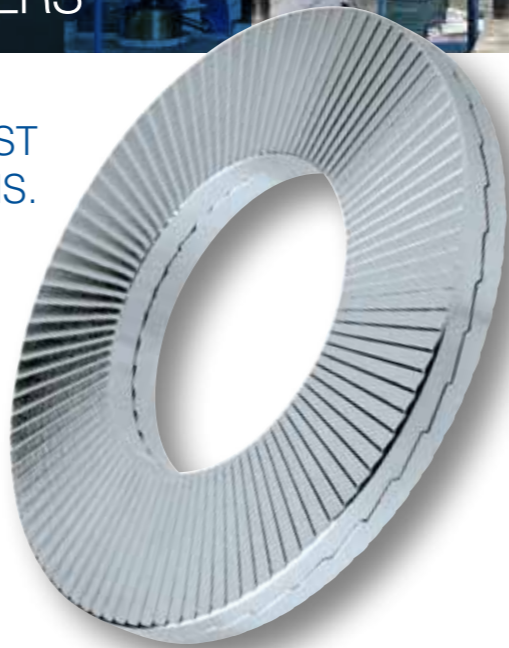

radial teeth wedge shaped cams

PRODUCT OVERVIEW

M	UNC	STEEL* ITEM NO.	STAINLESS STEEL* ITEM NO.	INTERNAL-Ø [MM]	EXTERNAL-Ø [MM]	BOX QTY [PAIR]
3	#5	HLS-3	HLS-3S	3,4	7,0	200
3,5	#6	HLS-3,5	HLS-3,5S	3,9	7,6	200
3,5	#6	HLB-3,5	HLB-3,5S	3,9	9,0	200
4	#8	HLS-4	HLS-4S	4,4	7,6	200
4	#8	HLB-4	HLB-4S	4,4	9,0	200
5	#10	HLS-5	HLS-5S	5,4	9,0	200
5	#10	HLB-5	HLB-5S	5,4	10,8	200
6		HLS-6	HLS-6S	6,5	10,8	200
6		HLB-6	HLB-6S	6,5	13,5	200
	1/4"	HLS-1/4"	HLS-1/4"S	7,2	11,5	200
	1/4"	HLB-1/4"	HLB-1/4"S	7,2	13,5	200
8	5/16"	HLS-8	HLS-8S	8,6	13,5	200
8	5/16"	HLB-8	HLB-8S	8,6	16,6	200
	3/8"	HLS-3/8"	HLS-3/8"S	10,3	16,0	200
	3/8"	HLB-3/8"	HLB-3/8"S	10,3	21,0	200
10		HLS-10	HLS-10S	10,7	16,6	200
10		HLB-10	HLB-10S	10,7	21,0	200
11	7/16"	HLS-11	HLS-11S	11,4	18,5	200
12		HLS-12	HLS-12S	13,0	19,5	200
12		HLB-12	HLB-12S	13,0	25,4	100
	1/2"	HLS-1/2"	HLS-1/2"S	13,5	19,5	200
	1/2"	HLB-1/2"	HLB-1/2"S	13,5	25,4	100
14	9/16"	HLS-14	HLS-14S	15,2	23,0	100
14	9/16"	HLB-14	HLB-14S	15,2	30,7	100
16	5/8"	HLS-16	HLS-16S	17,0	25,4	100
16	5/8"	HLB-16	HLB-16S	17,0	30,7	100
18		HLS-18	HLS-18S	19,5	29,0	100
18		HLB-18	HLB-18S	19,5	34,5	100
	3/4"	HLS-3/4"	HLS-3/4"S	20,0	30,7	100
	3/4"	HLB-3/4"	HLB-3/4"S	20,0	39,0	100
20		HLS-20	HLS-20S	21,4	30,7	100
20		HLB-20	HLB-20S	21,4	39,0	100
22	7/8"	HLS-22	HLS-22S	23,4	34,5	100
22	7/8"	HLB-22	HLB-22S	23,4	42,0	50
24		HLS-24	HLS-24S	25,3	39,0	100
24		HLB-24	HLB-24S	25,3	48,5	50
	1"	HLS-1"	HLS-1"S	27,9	39,0	100
	1"	HLB-1"	HLB-1"S	27,9	48,5	50
27		HLS-27	HLS-27S	28,4	42,0	50
27		HLB-27	HLB-27S	28,4	48,5	25
30	1 1/8"	HLS-30	HLS-30S	31,4	47,0	50
30	1 1/8"	HLB-30	HLB-30S	31,4	58,5	25
33	1 1/4"	HLS-33	HLS-33S	34,4	48,5	25
33	1 1/4"	HLB-33	HLB-33S	34,4	58,5	25
36	1 3/8"	HLS-36	HLS-36S	37,4	55,0	25
36	1 3/8"	HLB-36	HLB-36S	37,4	63,0	25
39	1 1/2"	HLS-39	HLS-39S	40,4	58,5	25
39	1 1/2"	HLB-39	HLB-39S	40,4	75,5	25
42		HLS-42	HLS-42S	43,2	63,0	25
45	1 3/4"	HLS-45	HLS-45S	46,2	70,0	25
48		HLS-48	HLS-48S	49,6	75,0	25
52	2"	HLS-52	HLS-52S	53,6	80,0	1
56	2 1/4"	HLS-56	HLS-56S	59,1	85,0	1
60		HLS-60	HLS-60S	63,1	90,0	1
64	2 1/2"	HLS-64	HLS-64S	67,1	95,0	1
68		HLS-68	HLS-68S	71,1	100,0	1
72		HLS-72	HLS-72S	75,1	105,0	1
76	3"	HLS-76	HLS-76S	79,1	110,0	1

* Carbon Steel, Stainless Steel A4

Non-standard sizes and special materials upon request





HEICO-LOCK® RING LOCK WASHERS

THE INNOVATIVE SYSTEM WITH ADDED SECURITY.

HEICO-LOCK® Ring Lock Washers provide high-quality, user-friendly bolt securing for the most demanding of applications and are ideal for repeated use.

The ring locking system guarantees that the two wedge lock washers are always fastened in the correct position with the wedge shaped cams on the inside and the radial teeth on the outside. This means that the bolt locking system is always easy, safe and quick to install, even for non-specialist users.

- Very easy to install and remove (ring locking system is supplied pre-assembled)
- Whereas the HEICO-LOCK® Wedge Lock Washers secure the bolted connections reliably, the ring holds the two individual washers together in the correct position permanently
- Particularly suitable for dynamic loads – including when lubricants are used
- Also suitable for use with high-tensile bolts of 8.8, 10.9 and 12.9 and their respective nuts
- Available in steel or stainless steel with a narrow or wide bearing surface
- Available from M4 – M24 - custom sizes upon request



DESIGN OF THE RING LOCKING SYSTEM

HEICO-LOCK® Ring Lock Washers are supplied pre-assembled.

The ring locking system consists of a polyamide ring (PA) and the already familiar HEICO-LOCK® Wedge Lock Washers.

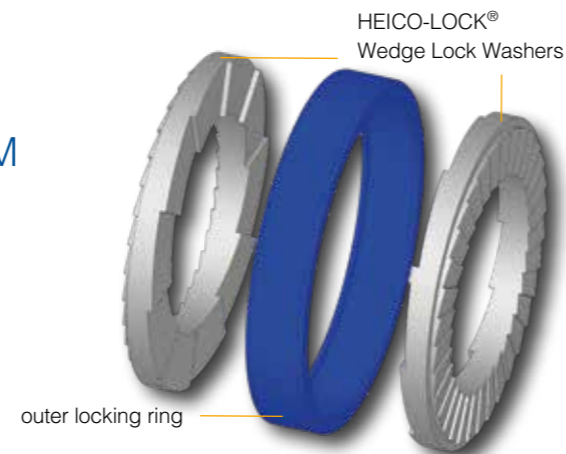

FIELDS OF APPLICATION



MAINTENANCE



MOTOR SPORTS



HEAVY INDUSTRY

PRODUCT OVERVIEW

M	UNC	STEEL* ITEM NO.	STAINLESS STEEL* ITEM NO.	INTERNAL-Ø [MM]	EXTERNAL-Ø [MM]	BOX QTY [PAIR]
M4	#8	HLRB-4	HLRB-4S	4,4	9,0	200
M5	#10	HLRS-5	HLRS-5S	5,4	9,0	200
M5	#10	HLRB-5	HLRB-5S	5,4	10,8	200
M6	-	HLRS-6	HLRS-6S	6,5	10,8	200
M6	-	HLRB-6	HLRB-6S	6,5	13,5	200
-	1/4"	HLRB-1/4"	HLRB-1/4"S	7,2	13,5	200
M8	5/16"	HLRS-8	HLRS-8S	8,6	13,5	200
M8	5/16"	HLRB-8	HLRB-8S	8,6	16,6	200
M10	-	HLRS-10	HLRS-10S	10,7	16,6	200
M10	-	HLRB-10	HLRB-10S	10,7	19,5	200
M12	-	HLRS-12	HLRS-12S	13,0	19,5	200
M12	-	HLRB-12	HLRB-12S	13,0	25,4	100
-	1/2"	HLRS-1/2"	HLRS-1/2"S	13,5	19,5	200
M14	9/16"	HLRB-14	HLRB-14S	15,2	30,7	100
M16	5/8"	HLRS-16	HLRS-16S	17,0	25,4	100
M16	5/8"	HLRB-16	HLRB-16S	17,0	30,7	100
-	3/4"	HLRS-3/4"	HLRS-3/4"S	20,0	30,7	100
-	3/4"	HLRB-3/4"	HLRB-3/4"S	20,0	39,0	100
M20	-	HLRS-20	HLRS-20S	21,4	30,7	100
M20	-	HLRB-20	HLRB-20S	21,4	39,0	100
M24	-	HLRS-24	HLRS-24S	25,3	39,0	100
-	1"	HLRS-1"	HLRS-1"S	27,9	39,0	100

* Carbon Steel, Stainless Steel A4

Non-standard sizes and special materials upon request



HEICO-LOCK® WEDGE LOCK NUTS

COMBINED. EFFICIENT. SAFE!

The HEICO-LOCK® Wedge Lock Nut is a re-usable one piece design that delivers high quality, user friendly bolt security without the need for separate fasteners.

The captive and rotary combination of the nut and the original HEICO-LOCK® Wedge Lock Washers makes securing your bolted joints more efficient, effective and easier even under the most extreme vibrations and dynamic loads

- The one piece design eliminates the risk of misuse
- Minimized risk of operating and production breakdowns caused by faulty bolted connections
- Easy handling especially in hard to reach locations
- Fixed permanently in the correct position
- Reduction of assembly time and effort
- Reduced complexity of the component due to less individual parts
- Easy, safe and fast installation even for non-specialist users
- Can be re-used
- Available from M6 – M27 in strength class 10
- Available with fine thread: M20x1.5 and M22x1.5

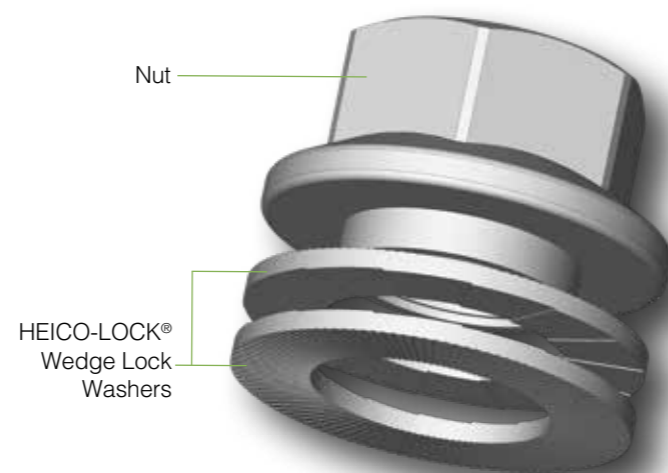

PRODUCT OVERVIEW

M	STEEL ITEM NO.	EXTERNAL- Ø [MM]	BOX QTY [PIECE]
6	HLM-6	14,2	100
8	HLM-8	17,9	100
10	HLM-10	21,8	50
12	HLM-12	26,0	50
14	HLM-14	29,9	30
16	HLM-16	34,5	25
18	HLM-18	38,0	20
20	HLM-20	42,8	10
22	HLM-22	46,0	10
24	HLM-24	51,0	5
27	HLM-27	56,0	5

FINE THREAD	STEEL ITEM NO.	EXTERNAL- Ø [MM]	BOX QTY [PIECE]
20 x 1.5	HLM-20x1.5	42,8	1 / 10
22 x 1.5	HLM-22x1.5	46,5	1 / 10

i HEICO-LOCK® WHEEL NUT



The HEICO-LOCK® Wheel Nut, a version of the wedge lock nut supplied in fine thread, is the reliable solution for the problem of self-loosening of wheel nuts on both roads and rough terrain. The captive and rotary combination of the nut and the established HEICO-LOCK® Wedge Lock Washers provides ideal protection for securing your wheels.



MORE INFORMATION: WWW.HEICO-LOCK.COM

FIELDS OF APPLICATION



HEICO-LOCK® COMBI-WASHERS

FLEXIBLE. FAST. INNOVATIVE.

The efficient combined securing system for highly loaded bolted connections.

HEICO-LOCK® Combi-Washers enable quick and easy assembly, especially in difficult installation situations. Combine the simple to use HEICO-LOCK® Combi-Washers with all commercially available bolts provided by your suppliers, quickly and easily.

- Easy mounting and permanent connection thanks to the inset tabs
- Can be combined with all commercially available bolts
- Also available in small purchase quantities
- Flexible use for various different types of bolts
- Permanent securing and correct positioning of HEICO-LOCK® Wedge Lock Washers
- Can be re-used several times
- Cost savings through increased productivity
- Available in steel or stainless steel with narrower and wider contact areas
- Available from M8 to M16
- Can be supplied completely pre-assembled on request



PRODUCT OVERVIEW

M	STEEL* ITEM NO.	STAINLESS STEEL* ITEM NO.	EXTERNAL-Ø [MM]	BOX QTY [PAIR]
8	HKS-8	HKS-8S	14,0	200
8	HKB-8	HKB-8S	16,6	200
10	HKS-10	HKS-10S	16,9	200
10	HKB-10	HKB-10S	21,0	200
12	HKS-12	HKS-12S	19,5	200
12	HKB-12	HKB-12S	25,4	100
16	HKS-16	HKS-16S	25,4	100
16	HKB-16	HKB-16S	30,7	100

* Carbon Steel, Stainless Steel A4

Non-standard sizes and special materials upon request

TAILORED PRECISELY TO YOUR REQUIREMENTS

We supply HEICO-LOCK® Combi-Washers to meet your requirements. Fit HEICO-LOCK® Combi-Washers to your own existing bolts, quickly and easily. You can choose to carry out this step yourself or we can supply you with pre-assembled bolts ready to use.

HEICO-LOCK® Combi-Washers fit all commercially available bolts, giving you a decisive advantage as the combi product enables you to optimise your purchases through space-saving storage. Benefit from our short delivery times and attractive small purchase quantities too.



FIELDS OF APPLICATION



HEICO-LOCK® HLK-WASHERS

HLK-WASHERS FOR STEEL CONSTRUCTION

The HEICO-LOCK® HLK-Washers deliver high quality anti-vibration security for HV sets according to DIN EN 14399-4 and DIN EN 14399-8.

Even under extremes of vibration or severe dynamic loads in steel construction the HEICO-LOCK® HLK-Washers, which are approved by the German Institute for Structural Engineering (DIBt), provide maximum reliability. Due to the increased under head radius of HV bolts, the HEICO-LOCK® HLK-Washers are chamfered on the internal diameter to ensure optimal surface contact while tightening.

- Designed to secure HV sets according to DIN EN 14399-4 and DIN EN 14399-8
- Replacing washers according to DIN EN 14399-6
- Approved and certified construction product (certificate of conformity)
- Approved for use by General Building Supervisory Authority (DIBt) Approval No Z-14.4-702
- Very easy to install and remove (HLK-washers are supplied as a pre-assembled pair)
- The double chamfer also ensures that the HEICO-LOCK® HLK-Washers cannot be applied incorrectly, so avoiding operator error
- High corrosion resistance provided by use of a zinc flake coating
- Available for HV sets from M12 up to M36
- Can be used for bolted connections of cat. A to E according to DIN EN 1993-1-8, a. o. suitable for slip-resistant connections

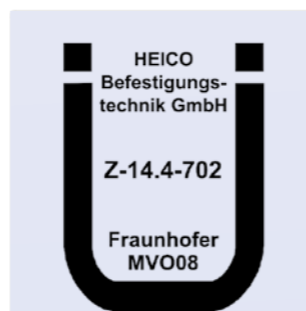
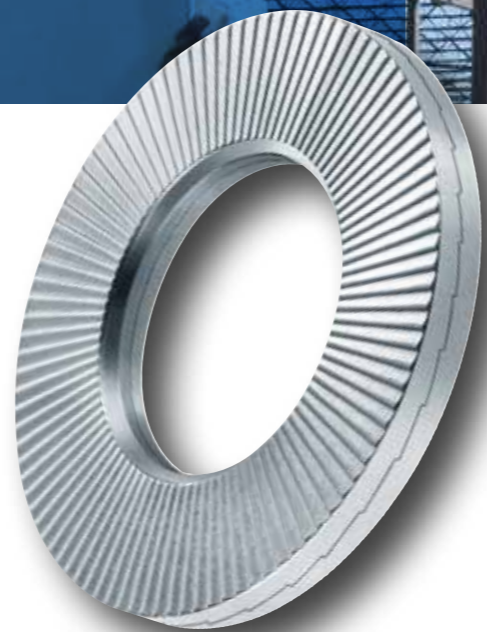

For detailed information regarding the General Building Supervisory (DIBt) Approval No. Z-14.4-702 visit www.heico-lock.com or www.dibt.de

FIELDS OF APPLICATION



STEEL CONSTRUCTION



BRIDGE CONSTRUCTION



SPECIAL STEEL CONSTRUCTION

PRODUCT OVERVIEW

M	STEEL* ITEM NO.	INTERNAL-Ø [MM]	EXTERNAL- Ø [MM]	BOX QTY [PAIR]
12	HLK-12	13	24	200
16	HLK-16	17	30	100
20	HLK-20	21	37	100
22	HLK-22	23	39	50
24	HLK-24	25	44	50
27	HLK-27	28	50	25
30	HLK-30	31	56	25
36	HLK-36	37	66	25

* Carbon Steel

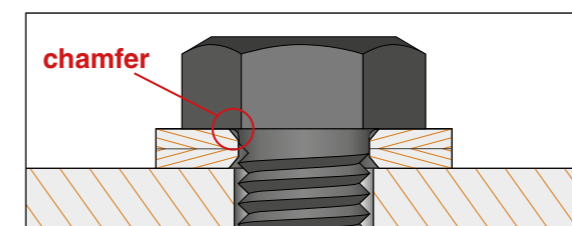

Geometry adaptation of the HEICO-LOCK® HLK washers

The chamfer on the through hole of the HLK washers is adapted to the larger underhead radius of HV sets, so that the HLK washers can reliably impress themselves into the bolt head without getting in contact with the underhead radius.

TORQUE GUIDELINES

STEEL* ITEM NO.	TORQUE CONTROLLED METHOD		COMBINED METHOD	
	Tightening torque **) M _{A, HLK} [Nm]	Preload **) F _{p, HLK} [kN]	Initial torque ****) M _{A, KV, HLK} [Nm]	Preload *****) F _{p, C} [kN]
HLK-12	150 (170***)	45 (50***)	150	59
HLK-16	360 (400***)	90 (100***)	300	110
HLK-20	760	145	550	172
HLK-22	1.050	170	800	212
HLK-24	1.250	200	950	247
HLK-27	1.550	260	1.200	321
HLK-30	2.600	315	1.800	393
HLK-36	3.500	460	2.600	572

* unalloyed steel

** Pre-tensioning parameters for reduced preload $F_{p,HLK} = 0,9 \times F_{p,C}$ according to DIN EN 1993-1-8/NA

*** Pre-tensioning parameters for reduced preload $F_{p,HLK} = 1,0 \times F_{p,C}$ according to DIN EN 1993-1-8/NA

**** For the required rotation angle θ DIN EN 1090-2, table 21 is valid

***** Preload $F_{p,C}$ according to DIN EN 1090-2



HEICO-LOCK® PLUS

THE EASY-TO-ASSEMBLE COMBINATION OF NUT AND WASHER

HEICO-LOCK® PLUS offers an easy to assemble and economically advantageous bolt securing system due to the flexible, glued connection of nut and Wedge Lock Washer.

Standard hexagon nuts according to ISO 4032 are combined with our proven HEICO-LOCK® Wedge Lock Washers. This system secures your bolt connection, saves time and reduces costs.



- Reduction of parts due to combination of wedge lock washer and nut
- Easy, safe and fast installation in both serial production and in the field
- Reduction of assembly time and effort
- Flexible combination of the HEICO-LOCK® wedge lock washer and nut
- Available in sizes M6 - M24, steel and stainless steel – additional dimensions and materials upon request
- Hexagon nuts according to ISO 4032



Flexible combination of washer and nut



FIELDS OF APPLICATION



MECHANICAL ENGINEERING



PRODUCT ASSEMBLY



AUTOMATION

PRODUCT OVERVIEW STEEL

M	PROPERTY CLASS	STEEL ITEM NO.	EXTERNAL-Ø [MM]	TOTAL HEIGHT [MM]	WIDTH ACROSS FLAT	BOX QTY
6	10	HLMG-6/10	10,8	8,2	10	100
8	10	HLMG-8/10	13,5	9,8	13	100
10	10	HLMG-10/10	16,6	11,4	16	50
12	10	HLMG-12/10	19,5	13,8	18	50
14	10	HLMG-14/10	23,0	16,8	21	30
16	10	HLMG-16/10	25,4	18,8	24	25
18	10	HLMG-18/10	29,0	19,8	27	20
20	10	HLMG-20/10	30,7	22,0	30	10
22	10	HLMG-22/10	34,5	23,4	34	10
24	10	HLMG-24/10	39,0	25,5	36	5

PRODUCT OVERVIEW STAINLESS STEEL

M	PROPERTY CLASS	STAINLESS STEEL ITEM NO.	EXTERNAL-Ø [MM]	TOTAL HEIGHT [MM]	WIDTH ACROSS FLAT	BOX QTY
6	A4-80	HLMG-6S/A4-80	10,8	8,2	10	100
8	A4-80	HLMG-8S/A4-80	13,5	9,8	13	100
10	A4-80	HLMG-10S/A4-80	16,6	11,4	16	50
12	A4-80	HLMG-12S/A4-80	19,5	13,8	18	50
14	A4-80	HLMG-14S/A4-80	23,0	16,8	21	30
16	A4-80	HLMG-16S/A4-80	25,4	18,8	24	25
18	A4-80	HLMG-18S/A4-80	29,0	19,8	27	20
20	A4-80	HLMG-20S/A4-80	30,7	22,0	30	10
22	A4-80	HLMG-22S/A4-80	34,5	23,4	34	10
24	A4-80	HLMG-24S/A4-80	39,0	25,5	36	5

HEICO-LOCK® PLUS BOLTS

Bolts can also be combined with HEICO-LOCK® Wedge Lock Washers upon request. Don't hesitate to contact us!



HEICO 3D-Models in the CADENAS PARTcommunity

All HEICO-LOCK® product 3D CAD data can be downloaded directly from the HEICO profile within the CADENAS PARTcommunity platform. After a free pre-registration with CADENAS, all product data is available to you at heico.partcommunity.com





HEICO-LOCK® SPECIAL PRODUCTS



TECHNICAL SUPPORT

SPECIAL PRODUCTS FOR NON-STANDARD APPLICATIONS



In addition to the standard products, we also offer you special custom solutions - such as the HEICO-LOCK® Combi Bolt or HEICO-LOCK® Special Washers. In order to be able to respond quickly and flexibly to your wishes, we have modern machinery at our disposal. On high-performance multi-stage presses, such as the SACMA SP 470, we are able to produce cold forged parts according to customers' drawings using cold forming or warm forming methods.

In our production, we process wire (steel, stainless steel, non-ferrous metals and special alloys) with a diameter of 2 mm to 20 mm into solid, semi-hollow or hollow parts. These special parts can have a length of up to 180 mm and a head or collar diameter of up to 34 mm, which can then be combined with our HEICO-LOCK® products if required.

All operations and processes are subject to the highest quality standards. The HEICO Group professionally ensures that customer orders are processed quickly, flexibly and smoothly – from on-site technical customer advice to feasibility studies, from tool development to the production process and individual packaging of the goods. Quality and continuous compliance with process specifications are top priorities at HEICO. In addition to the highly qualified employees, a comprehensive range of state-of-the-art testing devices and data monitoring systems ensure the optimum quality of the cold forged products.



- Combination of HEICO-LOCK® products and cold forged parts possible
- Products specially adapted to the customer application
- Easy, safe and fast installation also for non-professional users
- Reusable several times
- Reduction of assembly time and effort



FIELDS OF APPLICATION



CONSTRUCTION & FORESTRY MACHINES



ENERGY



MAINTENANCE

The HEICO group's in-house testing lab provides support in the development of new and innovative products for bolted connections. Existing products are constantly tested according to current guidelines (e.g. 25201-4, DIN EN ISO 16047), both in-house and also by independent test institutes (e.g. IMA Dresden, Fraunhofer IGP, DIBt). The test lab also offers various test options to check the use of HEICO products for customer-specific installations. By providing technical support and conducting experimental tests directly in the presence of the user, optimum safety can be ensured in individual customer applications.

TEST BENCHES AND MEASUREMENT TECHNOLOGY

- Vibration test benches according to DIN 65151 / DIN 25201-4 / ISO 16130 (M6 to M64 / ¼" – 2,5")
- Vibration test bench according to NASM 1312-7
- Torque/clamp force test bench according to DIN EN ISO 16047 (M6 to M64 / #5 – 2,5")
- Testing device for clamp forces up to 5.000 kN
- Salt spray test chamber according to ISO 9227
- Vickers hardness testers according to ISO 6507-1
- Rockwell hardness tester according to ISO 6508-1
- Devices for measuring preload loss due to embedding
- Sample preparation devices (e.g. hardness grindings)
- Laboratory press 300 kN
- Application of strain gauges
- Digital microscope with x2000 magnification
- Modern software for measurement data acquisition and evaluation
- Material identification and validation by arc spark OES
- Laboratory freezer down to -60°C



SERVICE OVERVIEW

- Experimental testing of locking characteristics according to DIN 25201-4 annex B, DIN 65151 and ISO 16130
- Calculation of friction coefficients e.g. according to DIN EN ISO 16047
- Load and torque tests
- Research and development
- Quality control
- Customer-specific tests and test reports
- Technical support in the dimensioning of bolts according to VDI 2230 sheet 1
- Training and in-house seminars
- Lectures within the framework of expert forums (e.g. VDI Knowledge Forum, DVM)



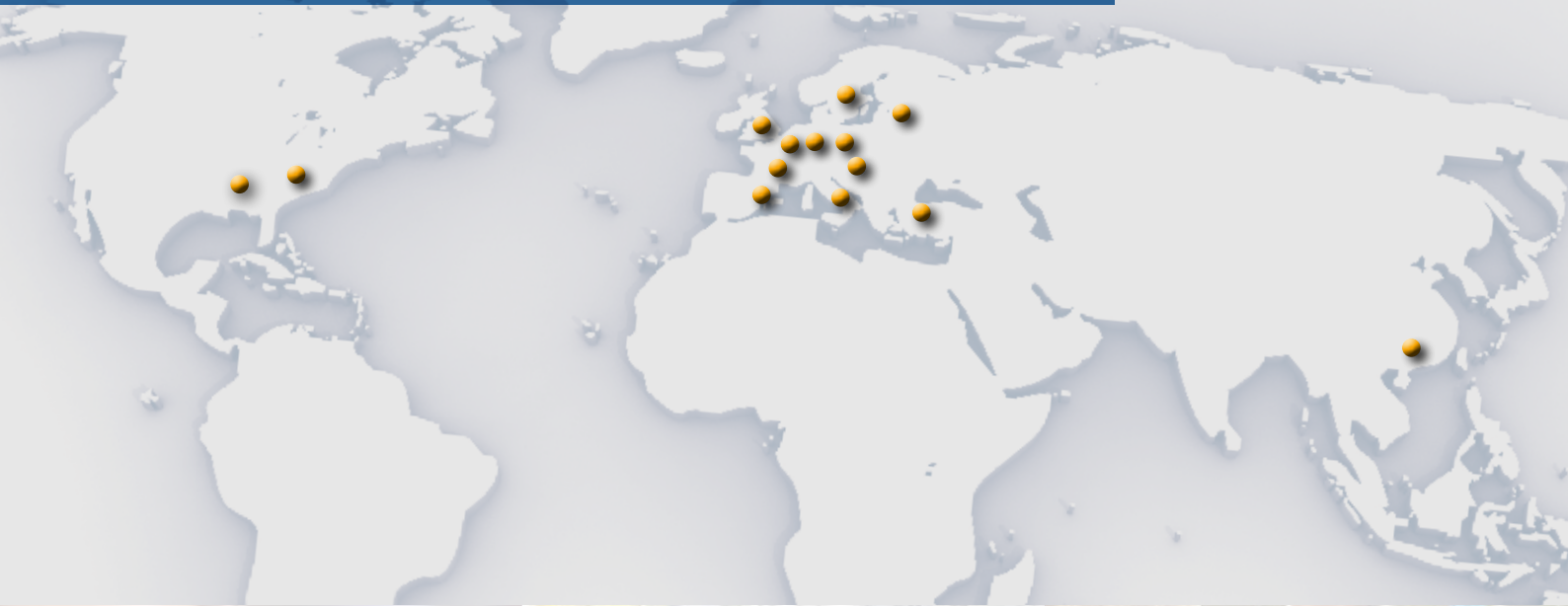

A STRONG GROUP BEHIND STRONG PRODUCTS

The HEICO group, based in the town of Ense in Westphalia, Germany, is a family-owned business with a long tradition. The company has been working passionately in the field of fastening technology since 1900. HEICO operates internationally with multiple company sites strategically located throughout the world. The group offers the highest degree of technical support and individual testing options.

Find out more about us: www.heico-group.com



HEICO-TEC® TENSIONING SYSTEMS

In addition to the HEICO-LOCK® Wedge Locking Systems, the HEICO-TEC® Tensioning Systems complement the portfolio of the HEICO Group. With these products, large bolted joints can be easily pretensioned by hand. A unique feature of the HEICO-TEC® Tensioning Systems is the distribution of the pretensioning force of a large main thread to many smaller pressure bolts. These are tightened one after the other, for example with a standard torque wrench, and thus achieve the maximum pretensioning force that can be generated in total.

For further information about the HEICO-TEC® Tensioning Systems, visit www.heico-tec.com



KANTILAL & BROTHERS

Manibhuvan, Golwadnaka,
LN Road, Vadodara-390001

(M) - 8460616032
9429690385

(E) - info@kbfasteners.in
(W) - www.kbfasteners.in

