



BIMFORUM

BIM FORUM

BIM FORUM

2005

2019

2022 →

2023

LEVEL OF DEVELOPMENT (LOD) SPECIFICATION PART I

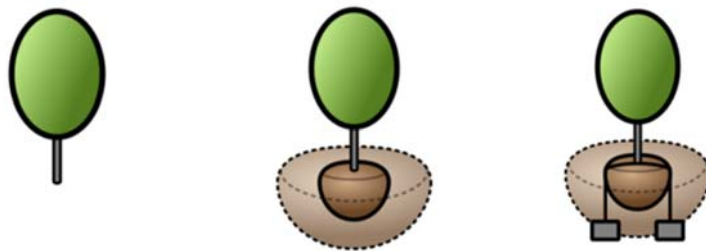

Major update to landscape section (image source ASLA)



Milestones/Deliverables

		SD		DD		CD	Constr. Coord.	Fabrication
Building Systems	Model Elements							

COLLABORATING ORGANIZATIONS



2023

Level of Development (LOD)

Specification

Nothing contained in this work shall be considered the rendering of legal advice. Readers are responsible for obtaining such advice from their own legal counsel. This work and any forms herein are intended solely for educational and informational purposes.

All images are intended to illustrate building conditions in compliance with common building codes. However, the images do not take into account site specific conditions, regional building codes and other important information that may require a material change for specific projects. These illustrations do not make representation for fitness for a particular project nor for code or design compliance.

Copyright © 2023 by BIMForum. All rights reserved.

The LOD Specification Part I and Part II as well as the LOD Specification Guide are made available to the public without charge. In order to maintain the integrity and usefulness of these documents as a reference standard, certain restrictions apply to their use. These documents are licensed to the public under Creative Commons licenses as follows:

Part I of this work is licensed under the Creative Commons Attribution-NonCommercial-NoDerivatives 4.0 International License (<http://creativecommons.org/licenses/by-nc-nd/4.0/>).

Part II of this work is licensed under the Creative Commons Attribution-NonCommercial 4.0 International License (<http://creativecommons.org/licenses/by-nc/4.0/>).

Licensing questions should be directed to LOD@BIMForum.org.

Underwriters

This important document was made possible by the generous support of these organizations:



American Institute of Steel Construction

PREFACE TO THE 2023 EDITION

In order to incorporate lessons learned from 10 years of extensive use on real-world projects, the BIMForum LOD Working Group undertook a major review and update of this Specification. The major thrust of the update is to resolve conflicts and improve consistency and readability in the logic and format of the text and graphics. Very few changes were made in the actual requirements in the Specification's LOD interpretations, and in most cases where changes were made requirements were relaxed somewhat. Several improvements have been made globally:

- **Elimination of nebulous terms.** E.g., use of the term "major openings" has been replaced by a defined size. This size can be modified through the use of the Notes function in Part II.
- **Simplification.** An example of this is the Interior Finishes section. In looking at the section as a whole it was realized that the modeling needs were dictated by the thickness of the finish rather than the material. Thus requirements based on thickness are defined for "C20 Interior Finishes", and these requirements apply to all children of that heading.
- **Defined Terms.** This section has been added to succinctly define terms that have specialized meaning in this Spec. The defined terms are in boldface where they appear in the LOD narrative descriptions.
- **LOD Requirements.** In the narrative descriptions of LOD requirements only items required to be included are listed. No reference is made to items that are not required and no items have been listed as prohibited.
- **Narrative Descriptions.** These have been organized into lists of specific required items to facilitate use of the Spec as a checklist.
- **Non-geometric information.** On the principle that any number of non-geometric attributes can be attached to a model element of any LOD, non-geometric information is not addressed in Part I.
- **Duplicated Content.** The Spec was scrubbed for duplicated content – where found it was deleted or replaced with cross-references

Evolution of the Level of Development (LOD) Definitions

AIA Effort

In 2008, the AIA published the first set of Level of Development definitions for *AIA Document E202™-2008 Building Information Modeling Protocol*. Due to the rapidly evolving nature of the use of BIM, the AIA updated the LOD definitions for its *G202-2013 Project BIM Protocol Form* and again, in collaboration with other industry organizations, for its *E201-2022 BIM Exhibit for Sharing Models with Project Participants*,

BIMForum Effort

In 2011 BIMForum initiated the development of the *LOD Specification* and formed a working group comprising contributors from both the design and construction sides of the major disciplines. To help further the standardization and consistent use of the LOD schema, and to increase its usefulness as a foundation for collaboration, the AIA licensed BIMForum to utilize its latest LOD definitions in this Specification. The BIMForum working group interpreted the AIA's basic LOD definitions for each building system, and then compiled examples to illustrate the interpretations. Because BIM is being put to an ever-increasing number of uses, the group decided that it was beyond the initial scope to address all of them. Instead, the definitions were developed to address model element geometry, with three of the most common uses in mind – quantity take-off, 3D coordination, and 3D control and planning. The group felt that in taking this approach the interpretations would be complete enough to support other uses.

In working with the AIA definitions the working group identified the need for an LOD that would define model elements sufficiently developed to enable detailed coordination between disciplines – e.g. clash avoidance/detection, layout, etc. The requirements for this level are higher than those for 300, but not as high as those for 400, thus it was designated LOD 350. The 2022 AIA Digital Practice documents include LOD 350.

The working group also decided that since the AIA's definition of LOD 500 related only to field verification and thus had no impact on modeling of elements the Specification would not develop interpretations for LOD 500.

In developing the system- and component-specific interpretations of the LODs the working group found it useful to define some fundamental interpretations, adding some color and shade to the AIA's definitions in order to guide the development of the specific interpretations.

The LOD definitions included in the LOD Specification versions 2013 through 2021 are the definitions from the AIA 2013 suite of Digital Practice documents plus the BIMForum's definition of LOD 350 and minus the definition of LOD 500, along with the BIMForum's fundamental interpretations.

2022 LOD Definition Update

In December of 2021 a collaborative effort was convened to incorporate lessons learned from almost a decade of practical application of the LOD framework into an updated set of LOD definitions. The following organizations were represented:

- AIA Contract Documents (ACD)
- American Association of State Highway Officials (AASHTO)
- American Institute of Architects (AIA)
- Canada's Integrated Project Delivery Alliance (IPDA)
- National BIM Standard (NBIMS)
- National Institute of Building Sciences (NIBS)

Basically, the group ratified the BIMForum interpretations and folded them into the new definitions, also simplifying and clarifying the language. As a result of this outcome the existing narrative and graphic interpretations of specific systems and components included in the 2013-2021 versions of the *LOD Spec* remain valid.

Some notable tweaks:

1. The sentence "Non-graphic information may also be attached to the Model Element" has been removed from all definitions. Since non-graphic information in any quantity and degree of accuracy can be attached to a model element of any LOD, the issue is addressed with a single over-arching statement in *AIA E201-2022*. This approach will be followed in future versions of the *LOD Spec*.
2. While the BIMForum 2013 interpretations assigned space-reservation volumes to LOD 200, the 2022 LOD 200 definition requires the element to show recognizable geometry. Thus space-reservation volumes are assigned to LOD 100.
3. The group developed a more succinct definition of LOD 500, making it clear that this LOD applies to existing or "as-constructed" elements rather than the "as-designed" elements addressed by LODs 100-400. The definition also requires that the accuracy of an LOD 500 element must be specified by some means other than LOD 100-400. The BIMForum will be collaborating with other industry organizations to develop a schema to specify this accuracy.

ACKNOWLEDGEMENTS

Many thanks to all the individuals and organizations who reviewed and contributed to this work, and to the following industry association representatives and co-chairs of the major discipline subgroups who made this document possible:

LOD SPEC WORKING GROUP

The widespread industry adoption of the *BIMForum LOD Spec* is primarily due to the broad range of built-environment industry knowledge, perspectives, and expertise that generates and maintains it. The component-specific interpretations of the fundamental LOD definitions contained in the Spec are not developed solely by experts in that system, but through a collaborative, consensus-based approach bringing to bear design, construction, and operations expertise from all disciplines.

Chair and Editor: Jim Bedrick, FAIA, AEC Process Engineering

Vice Chair: Jan Reinhardt, Adept Project Delivery

Domain Group Co-Chairs

	Design	Construction
Structures	Jan Reinhardt Adept Project Delivery	
Exterior Skin	Michael F. Czap, AIA The Beck Group	
Interior Construction	Brian Skripac, DBIA DBIA	Brian Filkins The Beck Group South Cole Texas Steel Tech LLC
Conveying	Michael F. Czap, AIA The Beck Group	Ken Flannigan, LEED AP Tech Frontiers LLC
Building Services		David Francis Dome Construction
Civil/Landscape	Lauren Schmidt Parallax Team Radu Dicher SWA Group	Jake Fears, PE JHF Engineering
Estimating with BIM	Brent pilgrim Beck Group	Ryan Short Rudick Construction Nicholas Grinnan Rudick Construction
Legal	Carl G. Roberts, Law Offices of Carl G. Roberts LLC	

Graphics

Annotated graphics were provided by the following organizations. Graphics not annotated were provided by BIMForum

- 1 Kone US
- 2 American Society of Landscape Architects (ASLA)

INDUSTRY AND ASSOCIATION REPRESENTATIVES

AIA Contract Documents	Jim Bedrick, FAIA
American Institute of Steel Construction	Luke Falkner
Associated General Contractors	Benjamin Crosby
Design-Build Institute of America	Brian Skripac, DBIA, Assoc. AIA
Integrated Project Delivery Alliance (Canada)	Markku Allison
NBS (UK)	Tina Pringle

Current and Previous Contributors

In addition, we'd like to thank the many contributors from all sectors of the industry who helped make this specification possible, including:

Andy Jizba, US CAD
Benjamin Crosby, Yates Construction
Bill Klorman, Klorman Construction & ACI 131 BIM Committee Member (Concrete)
Brenda Ikerd, Ikerd Consulting, (Structures, Civil)
Chuck Eastman, Ph.D, Georgia Institute of Technology
David Merrifield, National Institute of Steel Detailers
Jamie L. Davis, PE, LEED AP, Ryan Biggs | Clark Davis Engineering & Surveying (Masonry)
Jason P. Lien, PE, Precast Concrete Institute (PCI) BIM Committee, EnCon United (Precast)
Jonathan Koller, Ikerd Consulting, (Graphics Editing, Structures, and Anchors)
Joe Cipra, Vulcraft/Verco Group (Structural Steel Open Web Joists and Metal Deck)
Joe Powell, EIT, Ikerd Consulting, (MEP)
Kirk Capristo, Astorino (Cover)
Lee Garduno, Southland Industries (MEP)
Luke Faulkner, LEED AP, AISC (Structural Steel)
Matthew J. Gomez PE, SE, Trimble (Structural Steel)
Michael Bolduc, PE (MA), Simpson Gumpertz & Heger (Structural)
Michael Gustafson, PE, Autodesk (Structural)
Michael Mulder, Southland Industries (MEP)
Michael Perdue, Ikerd Consulting, (LOD Part II Data Tables)
Murat Karakas, Arup (MEP)
Paul J. Hause, PE, Structural Consultants Inc. (Structural)
Peter J. Carrato, Ph.D., PE, SE, Bechtel & ACI 131 BIM Committee Chair (Concrete)
R. Wayne Muir, P.E., Structural Consultants Inc. & SEI-CASE BIM Committee Co-Chair (Structures)
Roger Becker, PE, SE, Precast Concrete Institute (PCI) Managing Director of Research and Development (Precast)
Ron Dellaria, AIA, CSI, Collaborative Construction Consultants

Send feedback to communications@bimforum.org



Copyright © 2023 BIMForum. All rights reserved
This document is copyrighted under a [Creative Commons Attribution-NonCommercial-NoDerivatives 4.0 International License](https://creativecommons.org/licenses/by-nc-nd/4.0/).

Scott Babin, ITW Building Components Group (Wood)

Soheil Seiqali, Klorman Construction (Concrete)

Steven Bumbalough (Wood)

Will Ikerd PE, PhD, Ikerd Consulting

William Northcutt, Ikerd Consulting, (Graphics Editing, Structures, and Anchors)

Contents

TABLE OF CONTENTS STRUCTURE:

UNIFORMAT # / OMNICLASS # / UNICLASS # SECTION TITLE

EXECUTIVE SUMMARY	13
DEFINITIONS AND NOTES	15
Level of Development vs. Level of Detail	15
Fundamental LOD Definitions	15
Defined Terms	15
General Notes	16
REVISION HISTORY	17
Specific Changes to 2023 Edition	17
Part I	17
PART I – ELEMENT GEOMETRY	19
A / 21-01 / SS 20 05 SUBSTRUCTURE	19
A10 / 21-01 10 / Ss 20 05 15 Foundations	19
A1010 / 21-01 10 10 / Ss 20 05 Standard Foundations	19
A1010.10 / 21-01 10 10 10 / Ss 20 05 15 Wall Foundations	19
A1020 / 21-01 10 20 / Ss 20 05 Special Foundations	22
A20 / 21-01 20 / Ss 20 05 15 Subgrade Enclosures	25
A2010 / 21-01 20 10 / Ss 20 60 Walls for Subgrade Enclosures	25
A40 / 21-01 40 / Pr 20 85 14 16 Slabs-on-Grade	25
A4010 / 21-01 40 10 / Pr 20 85 14 16 Standard Slabs-on-Grade	26
A4020 / 21-01 40 20 / Pr 20 85 14 16 Structural Slabs-on-Grade	27
A4030 / 21-01 40 30 / -- Slab Trenches TBD	27
A4040 / 21-01 40 40 / Ss 37 16 90 63 Pits and Bases TBD	27
A4090 / 21-01 40 90 / -- Slab-On-Grade Supplementary Components.....	27
A60 / 21-01 60 / -- Water and Gas Mitigation TBD	27
A6010 / 21-01 60 10 / Ss 50 35 8 85 Building Subdrainage TBD	27
A6020 / 21-01 60 20 / Ss 15 10 33 34 Off-Gassing Mitigation TBD	27
A90 / 21-01 90 / -- Substructure Related Activities TBD	27
A9010 / 21-01 90 10 / Ss 15 10 30 25 Substructure Excavation TBD	27
A9020 / 21-01 90 20 / Ss 15 10 76 21 Construction Dewatering TBD	27
A9030 / 21-01 90 30 / TE 20 50 65 Excavation Support TBD	28
A9040 / 21-01 90 40 / Ss 15 10 35 Soil Treatment TBD	28
B / 21-02 / -- SHELL	29
B10 / 21-02 10 / -- Superstructure	29

B1010 / 21-02 10 10 / Ss 30 12	Floor Construction	29
B1020 / 21-02 10 20 / Ss 30 10	Roof Construction	43
B1080 / 21-02 10 80 / Ss 35	Stairs	45
B20 / 21-02 20 / EF 25 10	Exterior Vertical Enclosures.....	52
B2010 / 21-02 20 10 / EF 25 10	Exterior Walls	52
B2020	Exterior Windows.....	64
B2050 / 21-02 20 50 / Ss 25 30 20	Exterior Doors and Grilles	66
B2070 / 21-02 20 70 / Ss 25 50 45 45	Exterior Louvers and Vents	68
B2080 / 21-02 20 80 / --	Exterior Wall Appurtenances.....	69
B2090 / 21-02 20 90 / Ss 25 60	Exterior Wall Specialties.....	70
B30 / 21-02 30 / --	Exterior Horizontal Enclosures	70
B3010 / 21-02 30 10 / Ss 30 10	Roofing	71
B3020 / 21-02 30 20 / --	Roof Appurtenances	72
B3040 / 21-02 30 40 / Ss 30 12 20	Traffic Bearing Horizontal Enclosures	73
B3060 / 21-02 30 60 / --	Horizontal Openings.....	74
B3080 / 21-02 30 80 / --	Overhead Exterior Enclosures	75
C / 21-03 / --	INTERIORS.....	76
C10 / 21-03 10 / --	Interior Construction.....	76
C1010 / 21-03 10 10 / Ss 25 10 30	Interior Partitions	76
C1020 / 21-03 10 20 / Ss 25 30 95 41	Interior Windows.....	83
C1030 / 21-03 10 30 / Ss 25 30 20 25	Interior Doors	84
C1040 / 21-03 10 40 / --	Interior Grilles and Gates	86
C1060 / 21-03 10 60 / Ss 30 20 70	Raised Floor Construction.....	87
C1090 / 21-03 10 90 / --	Interior Specialties	89
C20 / 21-03 20 / Ss 25 45	Interior Finishes.....	91
C2010 / 21-03 20 10 / Ss 25 45	Wall Finishes.....	92
C2020 / 21-03 20 20 / Ss 25 25 45	Interior Fabrications.....	93
C2030 / 21-03 20 30 / Ss 30 42	Flooring	94
C2050 / 21-03 20 50 / Ss 30 47	Ceiling Finishes	97
D / 21-04 00 00 / --	SERVICES	98
D10 / 21-04 10 / Ss 80 20	Conveying	98
D1010 / 21-04 10 10 / Ss 80 50	Vertical Conveying Systems.....	98
D1010.20 / 21-04 10 10 20 / Ss 80 50 60	Lifts.....	101
D1030 / 21-04 10 30 / Ss 80 20 62	Horizontal Conveying	102
D1050 / 21-04 10 50 / Ss 80 20 10	Material Handling	103
D1080 / 21-04 10 80 / Ss 80 30 25	Operable Access Systems	106
D20 / 21-04 20 / --	Plumbing	107
D2010 / 21-04 20 10 / Ss 55 70 38	Domestic Water Distribution	107
D2020 / 21-04 20 20 / Ss 50 30 4	Sanitary Drainage	112
D2030 / 21-04 20 30 / --	Building Support Plumbing Systems	115
D2050 / 21-04 20 50 / Ss 55 20 15	General Service Compressed-Air.....	119
D2060 / 21-04 20 60 / Ss 55 60	Process Support Plumbing Systems	119
D30 / 21-04 30 / Ss 60	Heating, Ventilation, and Air Conditioning (HVAC).....	121
D3010 / 21-04 30 10 / Ss 55 50	Facility Fuel Systems	122
D3020 / 21-04 30 20 / Ss 60 40 37	Heating Systems	125
D3030 / 21-04 30 30 / Ss 60 40 17	Cooling Systems	127
D3050 / 21-04 30 50 / Ss 60 40 84	Facility HVAC Distribution Systems.....	129
D3060 / 21-04 30 60 / Ss 65 40 0 0	Ventilation	132
D3070 / 21-04 30 70 / Ss 60	Special Purpose HVAC Systems	135

D40 / 21-04 40 / Ss 55 30 Fire Protection	136
D4010 / 21-04 40 10 / Ss 55 30 Fire Suppression	136
D4030 / 21-04 40 30 / Ss 55 30 Fire Protection Specialties	138
D50 / 21-04 50 / -- Electrical	139
D5010 / 21-04 50 10 / -- Facility Power Generation	139
D5020 / 21-04 50 20 / Ss 70 30 Electrical Service and Distribution	142
D5030 / 21-04 50 30 / Ss 70 30 45 45 General Purpose Electrical Power	148
D5040 / 21-04 50 40 / Ss 70 80 Lighting	151
D5080 / 21-04 50 80 / Ss 70 Miscellaneous Electrical Systems	153
D60 / 21-04 60 / Ss 75 10 Communications	154
D6010 / 21-04 60 10 / Ss 75 10 21 21 Data Communications	155
D6020 / 21-04 60 20 / Ss 75 10 21 88 Voice Communications	156
D6030 / 21-04 60 30 / -- Audio-Video Communication	157
D6060 / 21-04 60 60 / Ss 75 70 54 15 Distributed Communications and Monitoring	157
D6090 / 21-04 60 90 / Ss 75 10 Communications Supplementary Components	157
D70 / 21-04 70 / Ss 75 40 Electronic Safety and Security	157
D7010 / 21-04 70 10 / Ss 75 40 Access Control and Intrusion Detection	157
D7030 / 21-04 70 30 / Ss 75 40 53 Electronic Surveillance	157
D7050 / 21-04 70 50 / Ss 75 50 Detection and Alarm	158
D7070 / 21-04 70 70 / Ss 75 70 54 15 Electronic Monitoring and Control	158
D7090 / 21-04 70 90 / Ss 75 50 Electronic Safety and Security Supplementary Components	158
D80 / 21-04 80 / Ss 75 70 Integrated Automation	158
D8010 / 21-04 80 10 / Ss 75 70 Integrated Automation Facility Controls	158
E / 21-05 00 00 / -- EQUIPMENT & FURNISHINGS	159
E10 / 21-05 10 00 / -- Equipment	159
E1010 / 21-05 10 10 / -- Vehicle and Pedestrian Equipment	159
E1030 / 21-05 10 30 / Ss 40 20 15 Commercial Equipment	160
E1060 / 21-05 10 60 / Ss 40 45 70 Residential Equipment	164
E1070 / 21-05 10 70 / Ss 40 70 Entertainment and Recreational Equipment	165
E1090 / 21-05 10 90 / Ss 40 15 35 35 Other Equipment	165
E20 / 21-05 20 / Ss 40 45 Furnishings	166
E2010 / 21-05 20 10 / Ss 40 45 Fixed Furnishings	166
E2050 / 21-05 20 50 / Pr 40 50 Movable Furnishings	168
F / 21-06 00 00 / -- SPECIAL CONSTRUCTION & DEMOLITION	170
F10 / 21-06 10 / -- Special Construction	170
F1010 / 21-06 10 10 / Ss 20 10 60 Integrated Construction	170
F1020 / 21-06 10 20 / -- Special Structures	170
F1030 / 21-06 10 30 / -- Special Function Construction	170
F1050 / 21-06 10 50 / -- Special Facility Components	171
F1060 / 21-06 10 60 / Ss 40 70 75 Athletic and Recreational Special Construction	171
F1080 / 21-06 10 80 / -- Special Instrumentation	171
F20 / 21-06 20 00 / Ss 15 30 Facility Remediation	171
F2010 / 21-06 20 10 / Ss 15 30 Hazardous Materials Remediation	171
F30 / 21-06 30 00 / Ac 10 10 25 Demolition	171
F3010 / 21-06 30 10 / Ac 10 10 25 Structure Demolition	172
F3030 / 21-06 30 30 / Ac 10 10 25 Selective Demolition	172
F3050 / 21-06 30 50 / Ac 10 80 Structure Moving	172

G / 21-07 00 00 / -- SITEWORK	173
G10 / 21-07 10 00 / Ac 10 Site Preparation	173
G1010 / 21-07 10 10 / Ac 10 30 Site Clearing	173
G1020 / 21-07 10 20 / Ac 10 10 25 Site Elements Demolition	173
G1030 / 21-07 10 30 / -- Site Element Relocations.....	173
G1050 / 21-07 10 50 / Ac 10 75 65 Site Remediation.....	173
G1070 / 21-07 10 70 / -- Site Earthwork	173
G20 / 21-07 20 / -- Site Improvements	174
G2010 / 21-07 20 10 / Ss 30 14 05 Roadways	174
G2020 / 21-07 20 20 / Ss 40 85 72 11 Parking Lots	176
G2030 / 21-07 20 30 / Ss 30 14 Pedestrian Plazas and Walkways	177
G2050 / 21-07 20 50 / Ss 30 14 Athletic, Recreational, and Playfield Areas	179
G2060 / 21-07 20 60 / -- Site Development	179
G2080 / 21-07 20 80 / -- Landscaping	180
G30 / 21-07 30 / Ss 55 20 Liquid and Gas Site Utilities	185
G3010 / 21-07 30 10 / Ss 55 70 Water Utilities	185
G3020 / 21-07 30 20 / -- Sanitary Sewerage Utilities	186
G3030 / 21-07 30 30 / Ss 50 35 80 Storm Drainage Utilities	187
G3050 / 21-07 30 50 / Ss 70 30 Site Energy Distribution.....	187
G3060 / 21-07 30 60 / -- Site Fuel Distribution.....	187
G3090 / 21-07 30 90 / -- Liquid and Gas Site Utilities Supplementary Components.....	187
G40 / 21-07 40 / -- Electrical Site Improvements	187
G4010 / 21-07 40 10 / -- Site Electric Distribution Systems	188
G4050 / 21-07 40 50 / Ss 70 80 25 Site Lighting	188
G50 / 21-07 50 / Ss 75 10 Site Communications	189
G5010 / 21-07 50 10 / Ss 75 10 Site Communications Systems	189
G90 / 21-07 90 / -- Miscellaneous Site Construction	189
G9010 / 21-07 90 10 / Ss 37 50 92 Tunnels	189
USER GUIDE	190
0 OVERVIEW	190
0.1 Description	190
BIM as a Communication Tool.....	190
0.1.1 LODs and Design Phase	190
0.1.2 LODs and Model Definition.....	191
0.2 Intent	191
0.2.1 Not a Set of Requirements	191
0.2.2 Complements a BIM Execution Plan (BEP).....	191
0.3 Background	191
0.3.1 AIA Effort	191
0.3.2 BIMForum Effort	191
1 USING THE SPECIFICATION	192
1.1 Details	192
1.1.1 Order of Precedence	192
1.1.2 LOD Definitions as Minimum Requirements	192
1.1.3 LOD Definitions are Cumulative	192

Send feedback to communications@bimforum.org



1.1.4	Model Element Author	192
1.1.5	2D Supplementary Drawings	192
1.2	Project-Specific Information	192
1.2.1	Size Thresholds	192
1.3	Using the Specification with a BEP	193
1.3.1	Reliance	193
1.3.2	Multiple uses	193
1.3.3	Efficient sequencing	193
1.3.4	Avoidance of over-modeling	193
1.4	Implementation of the Specification	193
1.4.1	Rely on the Model Element Table	193
1.4.2	Include LOD Designations as Attributes of Individual Model Elements	193
2	ORGANIZATION OF THE SPECIFICATION	194
2.1	Geometric and Attribute Information	194
2.1.1	Part I: Element Geometry	194
2.1.2	Part II: Associated Attribute Information	194
2.1.3	Model Element Table	194
2.1.4	Building Systems	194
2.1.5	Milestones/Deliverables	194
2.1.6	Attribute Tables	195
2.1.7	Attribute Table Anatomy	195
2.1.8	MEPF Attribute Tables	196
2.1.9	Using the Attribute Tables	197

EXECUTIVE SUMMARY

For a detailed guide on the use of this Specification see *User Guide* below.

The *Level of Development (LOD) Specification* is a reference tool intended to improve the quality of communication among users of Building Information Models (BIMs) about the characteristics of elements in models. The *LOD Specification* expands upon the LOD schema developed by AIA Contract Documents for its *E201 2022 BIM Exhibit for Sharing Models with Project Participants*¹ by providing definitions and illustrations of BIM elements of different building systems at different stages of their development and use in the design and construction process.

Building Information Modeling presents information about a construction project or structure in the form of three-dimensional graphical representations of elements (e.g., doors, beams, etc.), which can be further associated with information about other characteristics of those elements. It is possible for the graphical representation of an element, taken alone, to suggest that greater accuracy or intention can be attributed to the element than is in fact the case. The AIA's LOD Schema was developed to provide a more systematic way of conveying the extent of reliance that may be placed on an element. Many participants in the design and construction process felt, however, that the industry would benefit from a more detailed treatment of the AIA's brief narrative definitions.

Discussions within the BIMForum led to the creation of a multi-disciplinary task force to develop and maintain the *LOD Specification*. The *LOD Specification* is an organized collection of interpretations of the AIA's LOD definitions describing input and information requirements and providing graphical examples of the different levels of development of a broad variety of building element classes.

Users of the *LOD Specification* are cautioned that it does not prescribe the necessary levels of development for different steps in the construction process. That determination is left to each project team. It is believed, however, that the availability of more precise definitions will reduce the risks of miscommunication among members of project teams when the expectations for different stages in the design and construction process are established, through easier identification of what each member of the team is expected to deliver and greater predictability of the level of effort that is required to create each member's deliverables.

The *LOD Specification* is organized by CSI Uniformat 2010 and Omniclass², with the subclasses expanded to Level 4 (and in a few cases to Level 5) to provide detail and clarity to the element definitions. Breakdown indices are also provided per Uniclass 2015³, a UK initiative that is gaining international acceptance. See BIMForum LOD Spec Part II, tab 3, for a Uniclass-to-Omniclass/Uniformat cross-reference table.

The *LOD Specification* does not prescribe who the author of a particular component at a given LOD should be, as that will vary from one project or firm to another. However, the document does provide a concise schematic means through the spreadsheet in Part II for a project team to identify model element authors, again in the interest of improving communication among model users. In addition, the *LOD Specification* Working Group has been working with software developers to provide a means within the software of tagging individual elements within a model with their current LOD level.

The *LOD Specification* is intended as a reference standard, but is also intended to evolve as the use of BIM develops. The Specification is updated annually, and previous versions are maintained on the BIMForum website (www.bimforum.org/loa). Users are invited to provide comments and recommendations for consideration in future editions. These should be sent by email to LOD@BIMForum.org.

¹ AIA Contract Document *E201 2022 BIM Exhibit for Sharing Models with Project Participants where Model Versions may be enumerated as a Contract Document* is part of a series of digital practice documents AIA Contract Documents published in July 2022. Additional documents in the series include *E201 2022 BIM Exhibit for Sharing Models with Project Participants (does not support use as a contract)*, *E401-2022 BIM Exhibit for Sharing Models Solely Within the Design Team*, *E402-2022 BIM Exhibit for Sharing Models Solely Within the Construction Team*, *G203-2022 BIM Execution Plan*, *G204-2022 Model Element Table*, and *G205-2022 Abbreviated Model Element Table*. For general information on the documents and executable versions visit <https://www.aiacontracts.com>.

² UniFormat™ and Omniclass Numbers and Titles used in this publication are from UniFormat™, published by CSI and Construction Specifications Canada (CSC), and are used with permission from CSI. For a more in-depth explanation of UniFormat™ and its use in the construction industry visit <http://www.csinet.org> or contact CSI, 110 South Union Street, Suite 100, Alexandria, VA 22314. (800) 689-2900.

³ Uniclass 2015 © NBS Enterprises Ltd



DEFINITIONS AND NOTES

Level of Development vs. Level of Detail

LOD is sometimes interpreted as Level of *Detail* rather than Level of *Development*. This Specification uses the concept of Level of *Development*. There are important differences.

Level of *Detail* is essentially how *much* detail is included in the model element. Level of *Development* is the *degree to which the element's geometry has been thought through* – the degree to which project team members may rely on the information when using the model.

In essence, Level of Detail can be thought of as input to the element, while Level of Development is reliable output.

It is important to note that the international terminology regarding Level of Development and Level of Detail varies. Some countries refer to the Level of Development concept defined within this specification as the Level of Detail and use different numbering systems.

Fundamental LOD Definitions⁴

LOD 100 The Model Element may be graphically represented in the Model with a symbol or other generic representation, but does not satisfy the requirements for LOD 200. Information related to the Model Element (e.g., cost per square foot, tonnage of HVAC, etc.) can be derived from other Model Elements.

LOD 200 The Model Element is generically and graphically represented within the Model with approximate quantity, size, shape, location, and orientation.

LOD 300 The Model Element, as designed, is graphically represented within the Model such that its quantity, size, shape, location, and orientation can be measured.

LOD 350 The Model Element, as designed, is graphically represented within the Model such that its quantity, size, shape, location, orientation, and interfaces with adjacent or dependent Model Elements can be measured.

LOD 400 The Model Element is graphically represented within the Model with detail sufficient for fabrication, assembly, and installation.

LOD 500 The Model Element is a graphic representation of an existing or as-constructed condition developed through a combination of observation, field verification, or interpolation. The level of accuracy shall be noted or attached to the Model Element.

LOD Requirements are Cumulative. For a given element requirements for each LOD include the requirements for all lower LODs.

Defined Terms

Actual. The dimension needed for construction-level coordination. E.g., in defining an opening in a precast wall the precast plant must know the real dimensions of the rough opening.

Nominal. The dimension that is available at the design phase. E.g., the dimensions of the opening that is automatically generated by the model authoring tool when a door is placed in a wall. Note that these dimensions will usually differ from the rough opening dimensions.

⁴ The definitions for LOD 100, 200, 300, 400, and 500 included in this Specification represent the updated language that appears in AIA Contract Document *E201-2022, BIM Exhibit for Sharing Models with Project Participants, Where Model Versions May be Enumerated as a Contract Document*. The LOD 100, 200, 300, 400 and 500 definitions are used by permission. Copyright © 2022. ACD Operations, LLC. All rights reserved.

Element envelope. The exterior surfaces of the element. This term is used at both LOD 200 and 300 – at 200 the surfaces may be approximate but must encompass the extents of the element, at 300 they must be accurate.

Penetration Elements. Elements that are used to reinforce or otherwise augment a point where one element passes through another, e.g., a pipe sleeve in a concrete wall. Penetration elements are addressed under the penetrating element – e.g., pipe sleeves are addressed in the sections on piping.

General Notes

Appurtenances. This heading is used by Uniformat to indicate items that may or may not be attached to other elements under the same parent heading (e.g., waterproofing, insulation) – as such each Supplementary Components section will include a wide range of elements. In most cases these elements are not modeled. If it is deemed necessary to model any of the elements this can be addressed in the Part II template by either adding one or more child lines or using the notes function.

Supplementary Components. Similar to Appurtenances.

REVISION HISTORY

December 2023	Level Of Development Specification 2023 Draft for Public Comment	
December 2022	Supplement to 2021 LOD Specification	
12/29/2021	Level Of Development Specification 2021	
10/24/2021	Level Of Development Specification 2021 Draft for Public Comment	
12/31/2020	Level Of Development Specification 2020	
11/23/2020	Level Of Development Specification 2020 Draft for Public Comment	
01/18/2019	Level Of Development Specification 2019	
09/25/2018	Level Of Development Specification 2019 Draft for Public Comment	
09/04/2018	Level Of Development Specification 2018	
07/16/2018	Level Of Development Specification 2018 Draft for Public Comment	
11/07/2017	Level Of Development Specification 2017	
08/25/2017	Level Of Development Specification 2017 Draft for Public Comment	
10/17/2016	Level Of Development Specification 2016	
08/25/2016	Level Of Development Specification 2016 Draft for Public Comment	Definitions have not been changed except for minor grammatical corrections and formatting. Engineered metal building structures, precast concrete, highway and rail road bridge content moved from Appendix to main body.
10/30/2015	Level Of Development Specification 2015	Definitions have not been changed except for minor grammatical corrections and formatting. New content released as an Appendix to Part A for engineered metal building structures, precast concrete, highway bridge content and rail road bridge content.
4/30/2015	Level Of Development Specification 2015 Draft For Public Comment	Definitions have not been changed except for minor grammatical corrections and formatting. Part B, Model Element Table, and Attribute Tables were added.
12/30/2014	Level Of Development Specification 2014	Definitions have not been changed except for minor grammatical corrections and formatting. Images and image notes have been added in <i>blue italics font</i> .
8/22/2013	Level Of Development Specification 2013	
4/24/2013	Initial Draft for Public Review	

Specific Changes to 2023 Edition

Part I

In addition to the overall updates described in the *Preface to the 2023 Edition* above the content of these sections has been updated

Unifomat	Omniclass	Uniclass		
F1020.40	21-06 10 20 40	Ss 40 5	Special Structures: Metal Building Systems	Requirements simplified to align with design-team needs. Removed inconsistencies with other sections.

G20	21-07 20	—	Site Improvements	Substantial update to landscape-related items per ASLA
-----	----------	---	-------------------	--



Uniformat / Omniclass / Uniclass

PART I – ELEMENT GEOMETRY

A / 21-01 / Ss 20 05 SUBSTRUCTURE

Associated Masterformat Sections: 01 82 00

A10 / 21-01 10 / Ss 20 05 15 Foundations

Associated Masterformat Sections: 01 82 13

100	See Fundamental LOD Definitions	
200	Inclusions <ul style="list-style-type: none">• Element envelope	

A1010 / 21-01 10 10 / Ss 20 05 Standard Foundations

Includes: Formwork, concrete, unit masonry and reinforcement. Includes Standard Foundation Supplementary Components as appropriate. May Include: Related Activities: Excavation, dewatering, excavation support systems, backfill and compaction, and soil treatment.

Associated Masterformat Sections: 01 82 13

100	See A10	
200	See A10	
300	Inclusions <ul style="list-style-type: none">• Openings with any dimension greater than 6" (15 cm) or as noted• Surface slopes	

A1010.10 / 21-01 10 10 10 / Ss 20 05 15 Wall Foundations

Associated Masterformat Sections: 03 30 00 / 03 40 00 / 04 20 00 / 06 14 00

100	See A10	
-----	---------	--

Send feedback to communications@bimforum.org



Copyright © 2023 BIMForum. All rights reserved.
This document is copyrighted under a [Creative Commons Attribution-NonCommercial-NoDerivatives 4.0 International License](#).

Unifomat / Omniclass / Uniclass

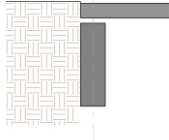
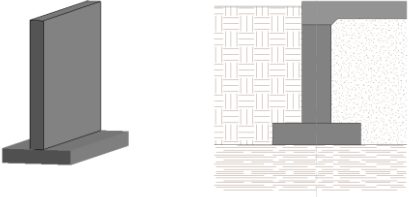
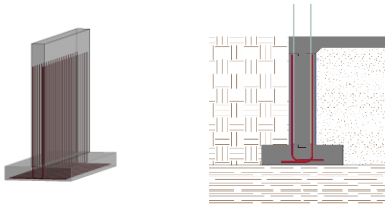
200	See A10.	
300	<p>Inclusions</p> <ul style="list-style-type: none"> • Openings with any dimension greater than 6" (15 cm) or as noted • Surface slopes 	
350	<p>Inclusions</p> <ul style="list-style-type: none"> • All penetrations, modeled at rough opening dimensions • Expansion joints • Chamfer • Dowels • Embeds • Lintels • Keyways 	
400	<p>Inclusions</p> <ul style="list-style-type: none"> • Rebar including hooks and lap splices • Post-tensioning tendons • Coursing for unit masonry • Pour Joints 	

A1010.30 / 21-01 10 10 30 / Ss 20 05 15 Column Foundations

Associated Masterformat Sections: 03 30 00

100	See A10	
200	See A10	

Send feedback to communications@bimforum.org



Copyright © 2023 BIMForum. All rights reserved
This document is copyrighted under a [Creative Commons Attribution-NonCommercial-NoDerivatives 4.0 International License](https://creativecommons.org/licenses/by-nc-nd/4.0/).

Unifomat / Omniclass / Uniclass

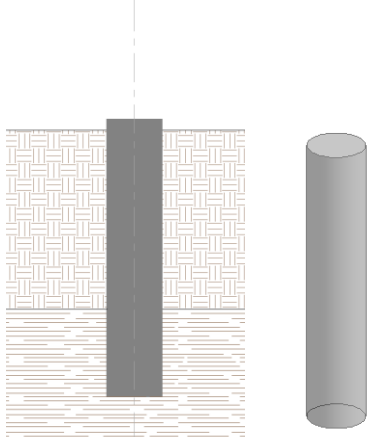
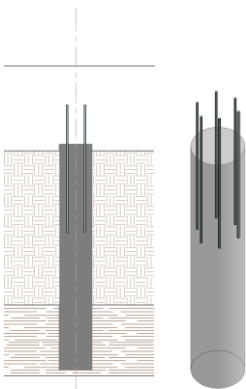
300	<p>Inclusions</p> <ul style="list-style-type: none">• Design specified bearing depth• Top of Pier• Size of pier	 <p>The diagram for LOD 300 consists of two parts. On the left, a vertical cross-section shows a dark grey rectangular pier extending downwards into a hatched area representing soil. A dashed vertical line indicates the pier's centerline. On the right, a 3D perspective view shows a solid grey cylinder representing the pier.</p>
350	<p>Inclusions</p> <ul style="list-style-type: none">• Dowels	 <p>The diagram for LOD 350 consists of two parts. On the left, a vertical cross-section shows a dark grey rectangular pier extending downwards into a hatched area representing soil. Several vertical lines, representing dowels, extend from the top of the pier through the soil. A dashed vertical line indicates the pier's centerline. On the right, a 3D perspective view shows a solid grey cylinder representing the pier, with several vertical lines extending from its top surface, representing the dowels.</p>

Uniformat / Omniclass / Uniclass

<p>400</p>	<p>Inclusions</p> <ul style="list-style-type: none"> • Depth to bearing stratum • Penetration into bearing stratum • Rebar including hooks and lap splices • Pier sled or Pier wheel for side clear cover • Pier bolster for bottom clear cover 	
------------	--	--

A1010.90 / 21-01 10 10 90 / Ss 20 05 15
Standard Foundation Supplementary Components TBD

See [General Notes](#): Supplementary Components

A1020 / 21-01 10 20 / Ss 20 05
Special Foundations

Includes: Drilling, casing, bell bottom, excavation, dewatering, removal of excavated, materials, reinforcing, and concrete. Drilled Piers, Driven Piles, Mat Foundation, elevator pits.

Associated Masterformat Sections: 31 60 00

100	See A10	
200	See A10	
300	See A1010	
350	See A1010.10	
400	See A1010.10	

Send feedback to communications@bimforum.org



Copyright © 2023 BIMForum. All rights reserved
This document is copyrighted under a [Creative Commons Attribution-NonCommercial-NoDerivatives 4.0 International License](#).





Unifomat / Omniclass / Uniclass

A1020.10 / 21-01 10 20 10 / Ss 20 05 65 24
Driven Piles TBD

Includes: Piles, pile driving, pile cut off, pile testing.

A1020.10.10 / 21-01 10 20 10 10 / --
Helical Piles, Helical Piers

Associated Masterformat Sections: N/A

100	See A10	
200		
300	Inclusions <ul style="list-style-type: none"> • Length Largest outside diameter	
350	Inclusions <ul style="list-style-type: none"> • Connection detail at top of pier 	
400	Inclusions: <ul style="list-style-type: none"> • True shape of pier 	

A1020.20 / 21-01 10 20 20 / Ss 37 50 80
Caissons TBD

A1020.30 / 21-01 10 20 30 / ss 20 05 15
Special Foundation Walls TBD

Send feedback to communications@bimforum.org



Copyright © 2023 BIMForum. All rights reserved
This document is copyrighted under a [Creative Commons Attribution-NonCommercial-NoDerivatives 4.0 International License](https://creativecommons.org/licenses/by-nc-nd/4.0/).

Unifomat / Omniclass / Uniclass

A1020.40 / 21-01 10 20 40 / Pr 20 29 03
Foundation Anchors TBD

A1020.50 / 21-01 10 20 50 / Ss 20 05 90
Underpinning TBD

A1020.60 / 21-01 10 20 60 / Ss 20 05 15 72
Raft Foundations TBD

A1020.70 / 21-01 10 20 70 / Ss 20 05 65
Pile Caps TBD

A1020.80 / 21-01 10 20 80 / Ss 20 05 15 71
Grade Beams

Includes: Formwork, reinforcement, and concrete.

Associated Masterformat Sections: 03 30 00

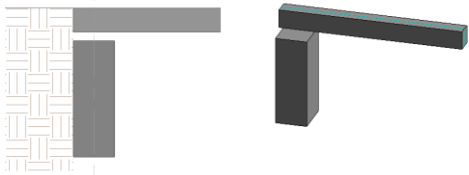
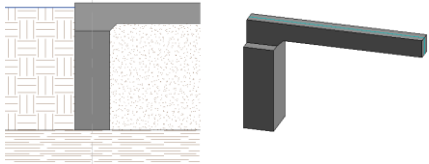
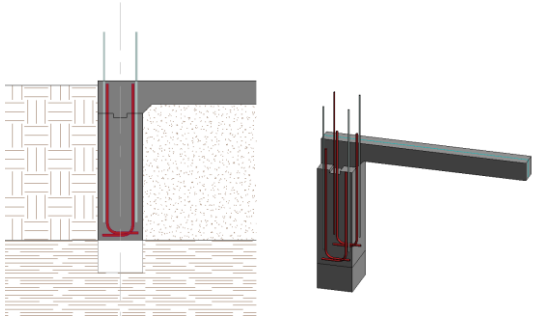
100	See A10	
200	See A10	
300	See A1010	
350	Inclusions: <ul style="list-style-type: none"> • All penetrations, modeled at rough opening dimensions • Expansion joints • Chamfer • Dowels • Embeds • Keyway • Void boxes 	
400	See A1010.10	

Send feedback to communications@bimforum.org



Copyright © 2023 BIMForum. All rights reserved
This document is copyrighted under a [Creative Commons Attribution-NonCommercial-NoDerivatives 4.0 International License](https://creativecommons.org/licenses/by-nc-nd/4.0/).

Unifomat / Omniclass / Uniclass

A20 / 21-01 20 / Ss 20 05 15 Subgrade Enclosures

Associated Masterformat Sections: 01 82 16

100	Inclusions <ul style="list-style-type: none">Solid mass model representing overall subgrade volume or schematic wall elements that are not distinguishable by type or material.	
-----	---	--

A2010 / 21-01 20 10 / Ss 20 60 Walls for Subgrade Enclosures

Includes: Perimeter walls enclosing building space below grade. Includes formwork, reinforcing, concrete and unit masonry. Includes Subgrade Enclosure Wall Supplementary Components as appropriate. May Include: Related Activities: Excavation, dewatering, excavation support systems, backfill and compaction, and soil treatment.

Associated Masterformat Sections: 01 82 16

100	See B20	
200	See B2010.20	
300	See B2010.20	
350	See B2010.20.50	
400	See B2010.20.50	

A2010.10 / 21-01 20 10 10 / Ss 20 60 Subgrade Enclosure Wall Construction TBD

A2010.20 / 21-01 20 10 20 / Ss 20 60 Subgrade Enclosure Wall Interior Skin TBD

A2010.90 / 21-01 20 10 90 / Ss 20 60 Subgrade Enclosure Wall Supplementary Components

See [General Notes](#): Supplementary Components

A40 / 21-01 40 / Pr 20 85 14 16 Slabs-on-Grade

Associated Masterformat Sections: 01 82 00

100	N/A	
200	Inclusions <ul style="list-style-type: none">Generic slab with approximate thickness.	

Send feedback to communications@bimforum.org





Copyright © 2023 BIMForum. All rights reserved
This document is copyrighted under a [Creative Commons Attribution-NonCommercial-NoDerivatives 4.0 International License](#).

Uniformat / Omniclass / Uniclass

A4010 / 21-01 40 10 / Pr 20 85 14 16 Standard Slabs-on-Grade

Includes: Slab construction supported continuously by earth or compacted fill. Includes fine grading, subbase layer, mud slab, insulation, vapor retarder, waterproofing, formwork, expansion joints, control joints, reinforcement, concrete, and finishing includes: Slabs-On-Grade Supplementary Components as appropriate. May Include: Related Activities: Excavation, dewatering, excavation support systems, backfill and compaction, and soil treatment.

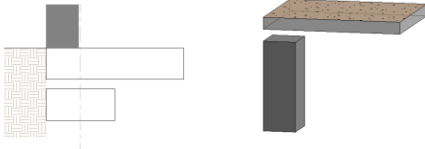
Associated Masterformat Sections: 03 30 00

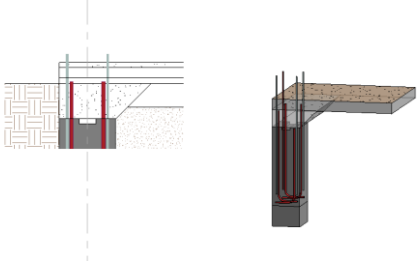
100	See A40	
200	See A40	
300	<p>Inclusions:</p> <ul style="list-style-type: none"> • Overall size, thickness, and geometry of the slab • Openings with any dimension greater than 6" (15 cm) or as noted • Slab depressions • Edge turn downs • Surface slopes 	
350	<p>Element modeling to include:</p> <ul style="list-style-type: none"> • All penetrations, modeled to rough opening dimensions. • Pour joints • Control joints • Expansion joints • Void boxes • Anchor elements • Dowels • Post-tension anchor points. 	
400	<p>Inclusions:</p> <ul style="list-style-type: none"> • Rebar • Post tensioning components 	

Uniformat / Omniclass / Uniclass

A4020 / 21-01 40 20 / Pr 20 85 14 16

Structural Slabs-on-Grade

Includes: Self-supporting slab construction not supported continuously by earth or compacted fill. Includes formwork, accessories, reinforcement, concrete, and finishing. Includes Slabs-On-Grade Supplementary Components as appropriate. May Include: Related Activities: Excavation, dewatering, excavation support systems, backfill and compaction, and soil treatment.

Associated Masterformat Sections: 03 30 00

All	See A4010	
-----	-----------	--

A4030 / 21-01 40 30 / --

Slab Trenches TBD

A4040 / 21-01 40 40 / Ss 37 16 90 63

Pits and Bases TBD

A4090 / 21-01 40 90 / --

Slab-On-Grade Supplementary Components

See [General Notes](#): Supplementary Components

A60 / 21-01 60 / --

Water and Gas Mitigation TBD

A6010 / 21-01 60 10 / Ss 50 35 8 85

Building Subdrainage TBD

A6020 / 21-01 60 20 / Ss 15 10 33 34

Off-Gassing Mitigation TBD

A90 / 21-01 90 / --

Substructure Related Activities TBD

A9010 / 21-01 90 10 / Ss 15 10 30 25

Substructure Excavation TBD

A9020 / 21-01 90 20 / Ss 15 10 76 21

Construction Dewatering TBD

Send feedback to communications@bimforum.org



Copyright © 2023 BIMForum. All rights reserved.
This document is copyrighted under a [Creative Commons Attribution-NonCommercial-NoDerivatives 4.0 International License](#).

Unifomat / Omniclass / Uniclass

A9030 / 21-01 90 30 / TE 20 50 65
Excavation Support TBD

A9040 / 21-01 90 40 / Ss 15 10 35
Soil Treatment TBD

Unifomat / Omniclass / Uniclass

B / 21-02 / -- SHELL

Associated Masterformat Sections: 01 83 00

B10 / 21-02 10 / -- Superstructure

Associated Masterformat Sections: 01 83 13

B1010 / 21-02 10 10 / Ss 30 12 Floor Construction

Associated Masterformat Sections: 01 83 13

100	Inclusions <ul style="list-style-type: none"> Level defined (elevation approximate) 	
200	Inclusions <ul style="list-style-type: none"> Element envelope 	

B1010.10 / 21-02 10 10 10 / Ss 30 12 33 Floor Structural Frame

Includes: Structural elements required for support of floor construction within basements and above grade. Includes columns, girders, beams, trusses, joists. Includes cast-in-place concrete, precast concrete, unit masonry, metal framed, and wood framed systems. Includes framed and sleeved openings for services. Includes Floor Construction Supplementary Components as appropriate.

Specific structural systems within this section are listed as follows:

<i>Concrete</i>	<i>B1010.10.10</i>
<i>Precast Structural Inverted T Beam</i>	<i>B1010.10.11</i>
<i>Concrete Structural Column</i>	<i>B1010.10.12</i>
<i>Masonry</i>	<i>B1010.10.20</i>
<i>Steel Framing Columns</i>	<i>B1010.10.30</i>
<i>Steel Framing Beams</i>	<i>B1010.10.40</i>
<i>Steel Framing Bracing Rods</i>	<i>B1010.10.50</i>
<i>Steel Joists</i>	<i>B1010.10.60</i>
<i>Cold-Formed Metal Framing</i>	<i>B1010.10.70</i>
<i>Wood Floor Trusses</i>	<i>B1010.10.80</i>

Associated Masterformat Sections: 03 30 00 / 03 40 00 / 04 20 00 / 05 10 00 / 05 20 00
05 21 23 / 05 42 00 / 05 44 00 / 06 11 00 / 06 13 00 / 06 13 26 / 06 17 33 / 06 17 36
06 17 53 / 06 18 13 / 06 18 16 / 06 50 00

B1010.10.10 / 21-02 10 10 10 10 / Ss 30 12 85 18 Floor Structural Frame (Concrete)

Associated Masterformat Sections: 03 30 00 / 03 40 00

100	See B1010	
-----	-----------	--

Send feedback to communications@bimforum.org



Copyright © 2023 BIMForum. All rights reserved
This document is copyrighted under a [Creative Commons Attribution-NonCommercial-NoDerivatives 4.0 International License](https://creativecommons.org/licenses/by-nc-nd/4.0/).

Unifomat / Omniclass / Uniclass

200	See B1010	
300	<p>Inclusions:</p> <ul style="list-style-type: none"> • Overall size, thickness, and geometry of elements • Openings with any dimension greater than 6" (15 cm) or as noted • Slab depressions • Surface slopes 	
350	<p>Inclusions</p> <ul style="list-style-type: none"> • All penetrations, modeled to rough opening dimensions. • Pour joints • Control joints • Expansion joints • Anchor elements • Embeds • Dowels • Post-tension anchor points. 	
400	<p>Inclusions:</p> <ul style="list-style-type: none"> • Shear reinforcing and stud rails • All reinforcement • Chamfer • Camber 	

B1010.10.11 / 21-02 10 10 10 11 / Ss 20 20 75 15
Structural Beam, Concrete, Precast or Cast-in-Place

Includes: Structural elements required for support of floor construction within basements and above grade. Includes columns, girders, beams, trusses, joists. Includes cast-in-place concrete, precast concrete, unit masonry, metal framed, and wood framed systems. Includes framed and sleeved openings for services. Includes Floor Construction Supplementary Components as appropriate.

Associated Masterformat Sections: 03 30 00 / 03 40 00 / 04 20 00 / 05 10 00 / 05 20 00
05 21 23 / 05 42 00 / 05 44 00 / 06 11 00 / 06 13 00 / 06 13 26 / 06 17 33 / 06 17 36
06 17 53 / 06 18 13 / 06 18 16 / 06 50 00

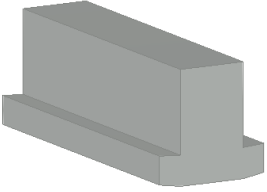
100	See B1010	
200	See B1010	

Send feedback to communications@bimforum.org



Copyright © 2023 BIMForum. All rights reserved
This document is copyrighted under a [Creative Commons Attribution-NonCommercial-NoDerivatives 4.0 International License](https://creativecommons.org/licenses/by-nc-nd/4.0/).

Uniformat / Omniclass / Uniclass

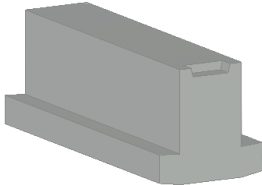
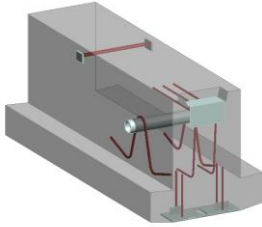
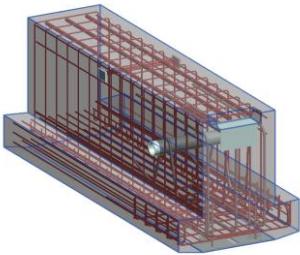
300	<p>Inclusions:</p> <ul style="list-style-type: none"> • Overall Geometry • Openings with any dimension greater than 6" (15 cm) or as noted 	
350	<p>Inclusions</p> <ul style="list-style-type: none"> • All penetrations, modeled to rough opening dimensions. • Anchor elements • Embeds • Dowels • Post-tension anchor points. • Critical structural zones such as zones that cannot be penetrated or cut • Lifting points 	
400	<p>Inclusions:</p> <ul style="list-style-type: none"> • All reinforcement • Chamfer • Camber 	



B1010.10.12 / 21-02 10 10 10 12 / Ss 20 30 75 15
Structural Column, Concrete, Precast or Cast-inPlace

Includes: Structural elements required for support of floor construction within basements and above grade. Includes columns, girders, beams, trusses, joists. Includes cast-in-place concrete, precast concrete, unit masonry, metal framed, and wood framed systems. Includes framed and sleeved openings for services. Includes Floor Construction Supplementary Components as appropriate.

Associated Masterformat Sections: 03 30 00 / 03 40 00 / 04 20 00 / 05 10 00 / 05 20 00
05 21 23 / 05 42 00 / 05 44 00 / 06 11 00 / 06 13 00 / 06 13 26 / 06 17 33 / 06 17 36
06 17 53 / 06 18 13 / 06 18 16 / 06 50 00

100	See B1010	
-----	-----------	--

Unifomat / Omniclass / Uniclass

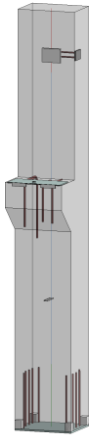
200	See B1010	
300	Inclusions: <ul style="list-style-type: none">• Overall Geometry• Openings with any dimension greater than 6" (15 cm) or as noted	
350	Inclusions <ul style="list-style-type: none">• All penetrations, modeled to rough opening dimensions.• Anchor elements• Embeds• Dowels• Post-tension anchor points.• Critical structural zones such as zones that cannot be penetrated or cut• Lifting points	

Unifomat / Omniclass / Uniclass

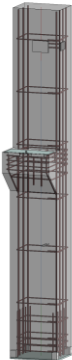
400	<p>Inclusions:</p> <ul style="list-style-type: none"> • All reinforcement • Chamfer • Camber 	
-----	---	---

B1010.10.20 / 21-02 10 10 10 20 / Ss 25 13 50

Floor Structural Frame, Masonry

Associated Masterformat Sections: 04 20 00

100	See B10	
200	Se B1010	
300	<p>Inclusions:</p> <ul style="list-style-type: none"> • Overall Geometry • Openings with any dimension greater than 6" (15 cm) or as noted 	
350	<p>Inclusions</p> <ul style="list-style-type: none"> • All penetrations, modeled to rough opening dimensions. • Anchor elements • Exposed embeds • Lintels • Dowels • Post-tension anchor points. • Critical structural zones such as zones that cannot be penetrated or cut • Expansion joints • Lifting points • Bond beams 	
400	<p>Inclusions:</p> <ul style="list-style-type: none"> • Waterproofing • Coursing • Reinforcements 	

B1010.10.30 21-02 10 10 10 30

Floor Structural Frame, Steel Framing Columns

Associated Masterformat Sections: 05 10 00



100	<p>Inclusions:</p> <ul style="list-style-type: none"> • Abstraction of columns as box 	
-----	--	--

Send feedback to communications@bimforum.org

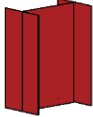

Copyright © 2023 BIMForum. All rights reserved.
This document is copyrighted under a [Creative Commons Attribution-NonCommercial-NoDerivatives 4.0 International License](https://creativecommons.org/licenses/by-nc-nd/4.0/).

Unifomat / Omniclass / Uniclass

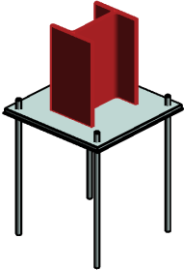
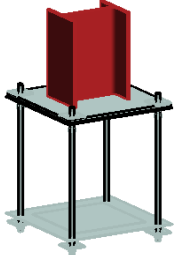
200	<p>Inclusions:</p> <ul style="list-style-type: none"> • General shape • 	
300	<p>Inclusions:</p> <ul style="list-style-type: none"> • Specific section type and size 	
350	<p>Inclusions:</p> <ul style="list-style-type: none"> • Member connections such as, base plates and gusset plates, anchor rods • Connection details with correct and reliable dimensions • Steel structure reinforcements and stiffeners (e.g. for penetrations) • Cap plates 	
400	<p>Inclusions:</p> <ul style="list-style-type: none"> • Welds • Coping of members • Washers, nuts, etc. 	

B1010.10.40 / 21-02 10 10 10 40 / Ss 20 20 75 80
Floor Structural Frame, Steel Framing Beams

Associated Masterformat Sections: 05 10 00 / 05 20 00 / 05 21 23

100	<p>Inclusions:</p> <ul style="list-style-type: none"> • Abstraction of beam as box 	
200	<p>Inclusions:</p> <ul style="list-style-type: none"> • General shape 	

Send feedback to communications@bimforum.org



Copyright © 2023 BIMForum. All rights reserved
This document is copyrighted under a [Creative Commons Attribution-NonCommercial-NoDerivatives 4.0 International License](https://creativecommons.org/licenses/by-nc-nd/4.0/).

Uniformat / Omniclass / Uniclass

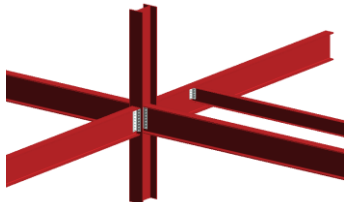
300	<p>Inclusions:</p> <ul style="list-style-type: none"> • Specific section type and size • Nominal size and shape of penetrations of any size 	
350	<p>Inclusions:</p> <ul style="list-style-type: none"> • Member connections such as, base plates and gusset plates, anchor rods • Actual size of penetrations • Reinforcement of penetrations • Stiffeners • Connection details • Cap plates 	
400	<p>Inclusions</p> <ul style="list-style-type: none"> • Welds • Coping of members • Bent plates, cap plates, etc. • Bolts, washers, nuts, etc. • All assembly elements 	

B1010.10.50 / 21-02 10 10 10 50 / Pr 20 85 84 88 Floor Structural Frame, Steel Framing Bracing

Associated Masterformat Sections: 05 10 00

100	See B10	
200	See B1010	
300	<p>Inclusions</p> <ul style="list-style-type: none"> • Type of brace (e.g., cable, rod, section, etc.) 	

Send feedback to communications@bimforum.org



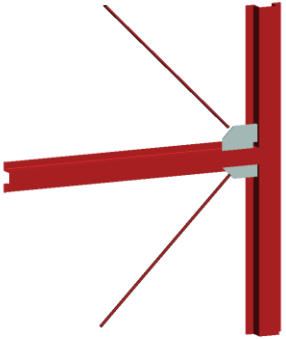
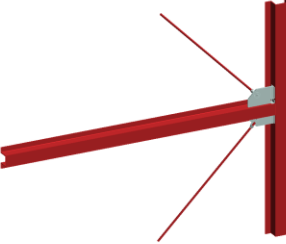

Copyright © 2023 BIMForum. All rights reserved
This document is copyrighted under a [Creative Commons Attribution-NonCommercial-NoDerivatives 4.0 International License](https://creativecommons.org/licenses/by-nc-nd/4.0/).

Uniformat / Omniclass / Uniclass

350	<p>Inclusions</p> <ul style="list-style-type: none"> • Connection details • Actual elevations and location of member connections • Main elements of typical connections applied to all structural steel connections such as base plates, gusset plates, anchor rods, etc. • Any miscellaneous steel members with correct size, shape, orientation and material 	
400	<p>Inclusions</p> <ul style="list-style-type: none"> • Welds • Clevis • Bolts, washers, nuts, etc. • All assembly elements 	

B1010.10.60 / 21-02 10 10 10 60 / Pr 20 85 90 11
Floor Structural Frame, Steel Joists

Associated Masterformat Sections: 05 10 00 / 05 20 00 / 05 21 23

100	See B10	
200	<p>Inclusions:</p> <ul style="list-style-type: none"> • Element envelope 	
300	<p>Inclusions</p> <ul style="list-style-type: none"> • Joist size, depth, slope, and material • Spacing and end elevations • Joist seat depth 	

Send feedback to communications@bimforum.org



Copyright © 2023 BIMForum. All rights reserved
This document is copyrighted under a [Creative Commons Attribution-NonCommercial-NoDerivatives 4.0 International License](https://creativecommons.org/licenses/by-nc-nd/4.0/).

Uniformat / Omniclass / Uniclass

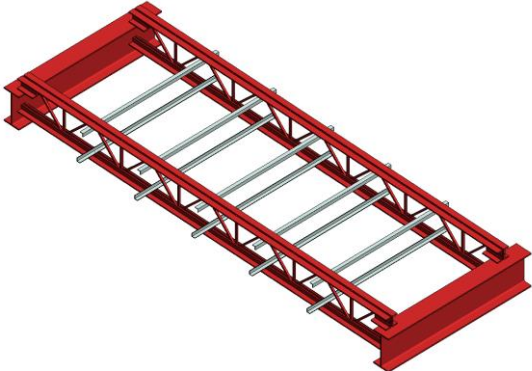
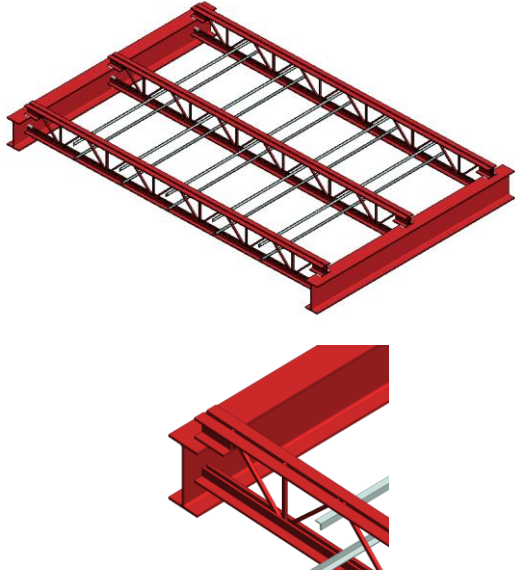
350	<p>Inclusions</p> <ul style="list-style-type: none"> • Actual final joist profile locations with accurate panel points • Joist bridging and lateral braces. • Any miscellaneous steel pertaining to the joist • Joist seat width • Erection details for installation • Chord and web member section profiles • Joist layout in coordination with metal deck fasteners • Non-standard joist seat depths and/or sloping joist seat 	
400	<p>Inclusions</p> <ul style="list-style-type: none"> • Welds • Connection plates • Anchorage • Material required for proper installation • Mark identification that correlates with bill of material 	

B1010.10.70 / 21-02 10 10 10 70 / Ss 20 10 75 45

Floor Structural Framing (Cold Formed Metal Framing)

Associated Masterformat Sections: 05 10 00 / 05 42 00 / 05 44 00

100	<p>Inclusions:</p> <ul style="list-style-type: none"> • Abstraction of beam as box 	
200	<p>Inclusions:</p> <ul style="list-style-type: none"> • General shape 	
300	<p>Inclusions:</p> <ul style="list-style-type: none"> • Specific section type and size • Nominal size and shape of penetrations of any size 	

Send feedback to communications@bimforum.org



Copyright © 2023 BIMForum. All rights reserved
This document is copyrighted under a [Creative Commons Attribution-NonCommercial-NoDerivatives 4.0 International License](https://creativecommons.org/licenses/by-nc-nd/4.0/).

Unifomat / Omniclass / Uniclass

350	Inclusions <ul style="list-style-type: none"> Members at any interface with wall edges (top, bottom, sides) or opening through wall Bridging or straps 	
400	Inclusions <ul style="list-style-type: none"> Welds Connections Any part required for complete installation 	

B1010.10.80 / 21-02 10 10 10 80 / Pr 20 85 90 81
Floor Structural Frame (Wood Floor Trusses)

Associated Masterformat Sections: 06 11 00 / 06 13 26 / 06 17 53

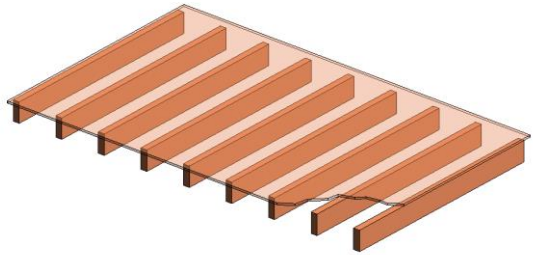
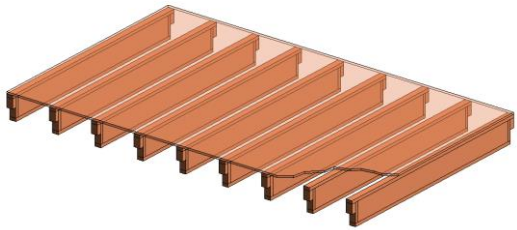
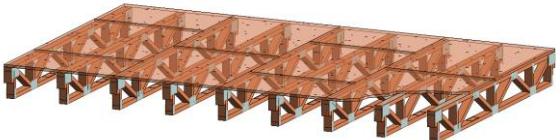
100	See B10	
200	Inclusions: <ul style="list-style-type: none"> Element envelope 	
300	Inclusions <ul style="list-style-type: none"> Joist size, depth, slope Spacing and end elevations Joist seat depth 	
350	Inclusions <ul style="list-style-type: none"> Actual final joist profile locations with accurate panel points Joist bridging and lateral braces. Joist seat width Erection details for installation Chord and web member section profiles Non-standard joist seat depths and/or sloping joist seat 	

Send feedback to communications@bimforum.org



Copyright © 2023 BIMForum. All rights reserved.
This document is copyrighted under a [Creative Commons Attribution-NonCommercial-NoDerivatives 4.0 International License](https://creativecommons.org/licenses/by-nc-nd/4.0/).

Uniformat / Omniclass / Uniclass

400	<p>Inclusions</p> <ul style="list-style-type: none"> • Connection plates • Anchorage • Elements required for proper installation 	
-----	---	--

B1010.20 / 21-02 10 10 20 / Ss 30 12 Floor Decks, Slabs, and Toppings

Includes: Structural slab, deck, and sheathing floor construction at intermediate floors of basement construction and above grade. Includes cast-in-place concrete, precast concrete, cementitious decks and toppings, metal decking, wood sheathing, and wood decking. Includes framed and sleeved penetrations for services and housekeeping pads for equipment. Includes Floor Construction Supplementary Components as appropriate.

Specific structural systems within this section are listed as follows:

Wood Floor Deck	B1010.20.10
Metal Floor Deck	B1010.20.20
Composite Floor Deck	B1010.20.30
Concrete	B1010.20.40

Associated Masterformat Sections: 03 30 00 / 03 40 00 / 03 50 00 / 05 30 00 / 05 34 00
05 35 00 / 06 12 00 / 06 15 00 / 06 16 00 / 06 18 00 / 06 53 00 / 06 73 00

B1010.20.10 / 21-02 10 10 20 10 / Ss 30 12 85 90 Floor Decks, Slabs, and Toppings (Wood Floor Deck)

Associated Masterformat Sections: 06 12 00 / 06 15 00 / 06 16 00 / 06 18 00

100	See B1010	
200	See B1010	
300	<p>Inclusions:</p> <ul style="list-style-type: none"> • Slopes and elevation changes (e.g., depressions) • Openings with any dimension greater than 6" (15 cm) or as noted • changes of material • Edge location defined • Framing members 	
350	<p>Inclusions:</p> <ul style="list-style-type: none"> • All framing members including braces, kickers, etc. • Openings at rough opening dimensions 	
400	<p>Inclusions:</p> <ul style="list-style-type: none"> • Fasteners 	

Unifomat / Omniclass / Uniclass

B1010.20.20 / 21-02 10 10 20 20 / Ss 30 12 85 40
Floor Decks, Slabs, and Toppings (Metal Floor Deck)

Associated Masterformat Sections: 05 30 00 / 05 34 00 / 05 35 00

100	See B1010	
200	See B1010	
300	<p>Inclusions:</p> <ul style="list-style-type: none"> • Slopes and elevation changes (e.g., depressions) • Drainage low points • Openings with any dimension greater than 6" (15 cm) or as noted • changes of material • Edge location defined • Framing members 	
350	<p>Inclusions:</p> <ul style="list-style-type: none"> • Splices and end laps • Embeds and structural connection points • Actual deck profile and flute locations per manufacturer • All miscellaneous framing including braces, kickers, etc. • Openings at rough opening dimensions 	
400	<p>Element modeling to include:</p> <ul style="list-style-type: none"> • Framing accessories and fasteners • Welds 	

B1010.20.30 / 21-02 10 10 20 30 / Ss 30 12 85 16
Floor Decks, Slabs, and Toppings (Composite Floor Deck)

Associated Masterformat Sections: 06 73 00

100	See B1010	
200	See B1010	
300	<p>Inclusions:</p> <ul style="list-style-type: none"> • Slopes and elevation changes (e.g., depressions) • Drainage low points • Openings with any dimension greater than 6" (15 cm) or as noted • changes of material • Edge location defined • Framing members 	

Send feedback to communications@bimforum.org



Copyright © 2023 BIMForum. All rights reserved
This document is copyrighted under a [Creative Commons Attribution-NonCommercial-NoDerivatives 4.0 International License](https://creativecommons.org/licenses/by-nc-nd/4.0/).

Unifomat / Omniclass / Uniclass

350	Inclusions: <ul style="list-style-type: none"> • Splices and end laps • Embeds and structural connection points • Actual deck profile and flute locations per manufacturer • All miscellaneous framing including braces, kickers, etc. • Openings at rough opening dimensions 	
400	Inclusions: <ul style="list-style-type: none"> • Framing accessories and fasteners • Welds 	

B1010.20.40 / 21-02 10 10 20 40 / Ss 30 12 85 18
Floor Decks, Slabs, and Toppings (Concrete)

Associated Masterformat Sections: 03 30 00 / 03 40 00 / 03 50 00

100	See B1010	
200	See B1010	
300	Inclusions: <ul style="list-style-type: none"> • Slopes and elevation changes (e.g., depressions) • Drainage low points • Openings with any dimension greater than 6" (15 cm) or as noted • Changes of material • Edge locations • Framing members 	
350	Inclusions <ul style="list-style-type: none"> • Chamfer • Expansion Joints • Embeds and anchor rods • Locations of post-tension tendons • Openings with any dimension greater than 6" (15 cm) or as noted • Shear reinforcing and stud rails 	
400	Inclusions <ul style="list-style-type: none"> • Reinforcement 	

Uniformat / Omniclass / Uniclass

B1010.20.41 / 21-02 10 10 20 50 / Pr 20 85 08 66

Precast Structural Double Tee (Concrete)

Includes: Structural elements required for support of floor construction within basements and above grade. Includes columns, girders, beams, trusses, joists. Includes cast-in-place concrete, precast concrete, unit masonry, metal framed, and wood framed systems. Includes framed and sleeved openings for services. Includes Floor Construction Supplementary Components as appropriate

Associated Masterformat Sections: 03 30 00 / 03 40 00 / 04 20 00 / 05 10 00 / 05 20 00
05 21 23 / 05 42 00 / 05 44 00 / 06 11 00 / 06 13 00 / 06 13 26 / 06 17 33 / 06 17 36
06 17 53 / 06 18 13 / 06 18 16 / 06 50 00

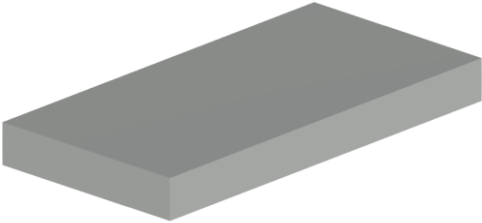
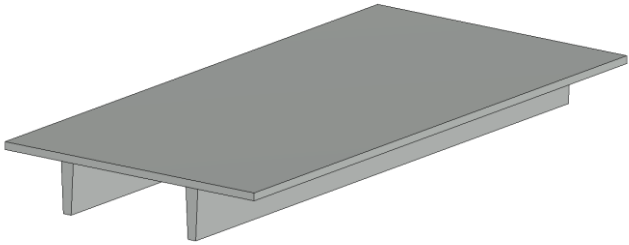
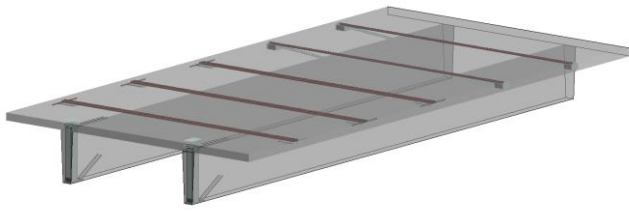
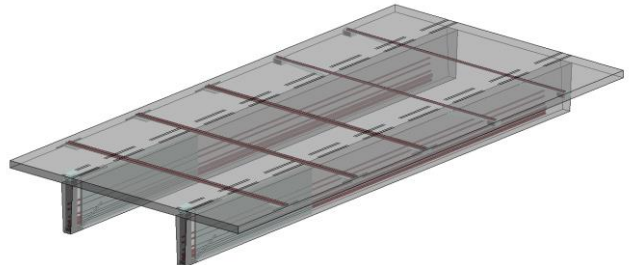
100	<p>Inclusions</p> <ul style="list-style-type: none"> • Conceptual depth 	
200	<p>Inclusions</p> <ul style="list-style-type: none"> • Element envelope 	
300	<p>Inclusions</p> <ul style="list-style-type: none"> • Main concrete structural members • Surface slopes 	
350	<p>Inclusions</p> <ul style="list-style-type: none"> • Lifting points • Expansion Joints • Embeds and anchor rods • Locations of post-tension tendons • Openings with any dimension greater than 6" (15 cm) or as noted • Shear reinforcing and stud rails 	
400	<p>Inclusions</p> <ul style="list-style-type: none"> • Chamfer • Reinforcement 	

Send feedback to communications@bimforum.org



Copyright © 2023 BIMForum. All rights reserved
This document is copyrighted under a [Creative Commons Attribution-NonCommercial-NoDerivatives 4.0 International License](https://creativecommons.org/licenses/by-nc-nd/4.0/).

Uniformat / Omniclass / Uniclass

B1010.30 / 21-02 10 10 30 / Ss 30 12 85
Balcony Floor Construction TBD

B1010.40 / 21-02 10 10 40 / Ss 30 12 85
Mezzanine Floor Construction TBD

B1010.50 / 21-02 10 10 50 / Ss 35 10 85
Ramps

100	Inclusions <ul style="list-style-type: none">• None required	
200	Inclusions <ul style="list-style-type: none">• Element envelope	
300	Inclusions <ul style="list-style-type: none">• Major ramp support elements• Changes of materials• Handrails	
350	Inclusions <ul style="list-style-type: none">• Secondary support elements• Connection points etc.).• Elements needed for installation	
400	Inclusions <ul style="list-style-type: none">• Elements needed for fabrication	

B1010.90 / 21-02 10 10 90 / Ss 30 12
Floor Construction Supplementary Components
See [General Notes](#): Supplementary Components

B1020 / 21-02 10 20 / Ss 30 10 Roof Construction

Associated Masterformat Sections: 01 81 13

Note: This classification refers to roofs modeled as single composite objects (excluding structural frame). If individual layers are to be modeled see:

B1020.10	21-02 10 20 10	Roof Structural Frame
B1020.20	21-02 10 20 20	Roof Decks, Slabs, and Sheathing
B3010	21-02 30 10	Roofing

Uniformat / Omniclass / Uniclass

B1020.10 / 21-02 10 20 10 / Ss 30 10 30

Roof Structural Frame

Description: Structural elements required for support of floor construction within basements and above grade. Includes columns, girders, beams, trusses, joists. Includes cast-in-place concrete, precast concrete, unit masonry, metal framed, and wood framed systems. Includes framed and sleeved openings for services. Includes Floor Construction Supplementary Components as appropriate.

Associated Masterformat Sections: 03 30 00 / 03 40 00 / 04 20 00 / 05 10 00 / 05 20 00 / 05 21 23 / 05 42 00 / 05 44 00 / 06 11 00 / 06 13 00 / 06 13 26 / 06 17 33 / 06 17 36 / 06 17 53 / 06 18 13 / 06 18 16 / 06 50 00

See B1010.10

B1020.20 / 21-02 10 20 20 / Ss 30 12 85

Roof Decks, Slabs, and Sheathing

Includes: Structural roof deck, slab, and sheathing construction. Includes cast-in-place concrete, precast concrete, cementitious decks and toppings, metal decking, wood sheathing, wood decking, timber decking and expansion control. Includes framed and sleeved penetrations for services and housekeeping pads for equipment. Includes Roof Construction Supplementary Components as appropriate.

Associated Masterformat Sections: 03 30 00 / 03 40 00 / 03 50 00 / 03 52 00 / 05 30 00 / 05 34 00 / 05 35 00 / 06 12 00 / 06 15 00 / 06 16 00 / 06 18 00 / 06 53 00 / 06 73 00

100	Inclusions <ul style="list-style-type: none">• Conceptual depth	
200	Inclusions: <ul style="list-style-type: none">• Element envelope	
300	Inclusions <ul style="list-style-type: none">• Main structural members• Surface slopes• Openings with any dimension greater than 6" (15 cm) or as noted	
350	Inclusions <ul style="list-style-type: none">• Framing members at openings	

B1020.30 / 21-02 10 20 30 / Ss 25 50 45 10

Canopy Construction

Includes: Structural frame and decks, slabs, and sheathing for canopy construction.

Associated Masterformat Sections: 03 30 00 / 03 40 00 / 05 10 00 / 05 19 19 / 05 20 00 / 06 11 00 / 06 12 00 / 06 13 00 / 06 15 00 / 06 16 00 / 06 17 00 / 06 18 00 / 06 50 00 / 06 73 00

See B1010.20

Unifomat / Omniclass / Uniclass

B1020.90 / 21-02 10 20 90 / Ss 30 10

Roof Construction Supplementary Components

Includes: Vapor retarders, air barriers, insulation, fireproofing, firestopping, and expansion control to be included with roof construction elements above as appropriate

See [General Notes](#): Supplementary Components

B1080 / 21-02 10 80 / Ss 35

Stairs

Includes: Stairs, fire escapes, metal walkways, and ladders.

Associated Masterformat Sections: 01 84 16

100	Inclusions: <ul style="list-style-type: none">• Approximate location	
-----	--	--

B1080.10 / 21-02 10 80 10 / Ss 35 10

Stair Construction

Includes: Structural framing for exterior and interior stairs including treads, risers, and landings. Includes fire escapes and ladders.

Associated Masterformat Sections: 03 11 23 / 03 30 00 / 03 41 23 / 03 48 19 / 05 51 00

05 55 00 / 05 71 00 / 06 43 00

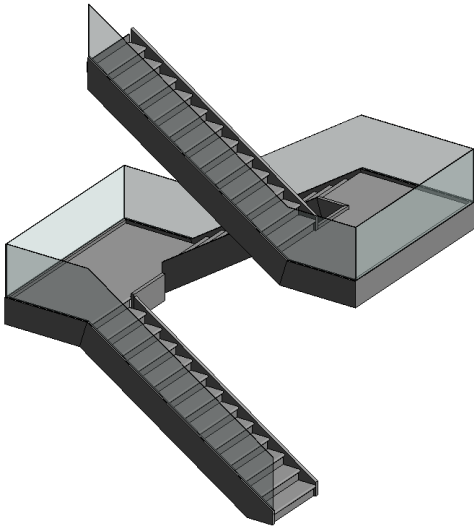
100	See B1080	
200	Inclusions: <ul style="list-style-type: none">• Reliable number and arrangement of landings and flights	

Unifomat / Omniclass / Uniclass

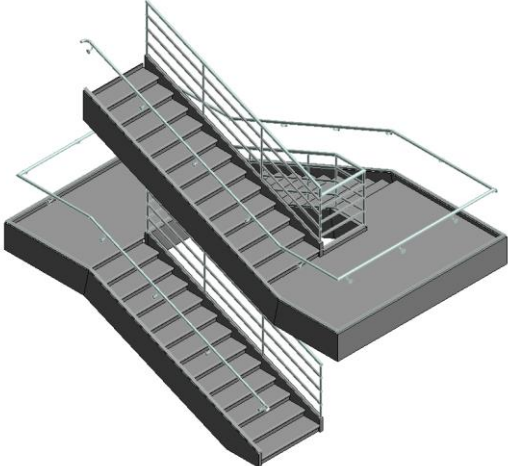
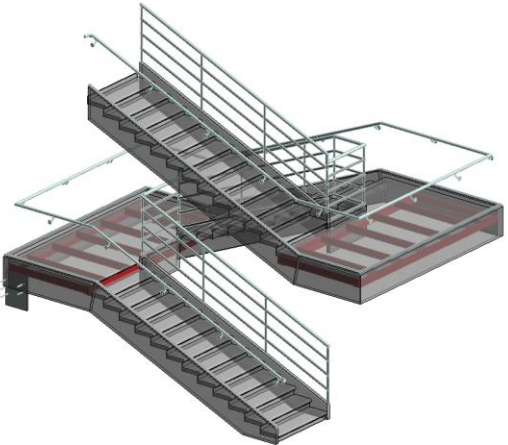
300	<p>Inclusions:</p> <ul style="list-style-type: none">• Overall geometry of landings and flights• Number of risers and treads• Tread width• Riser height• Stringers• Railing• Nosing geometry	
350	<p>Inclusions:</p> <ul style="list-style-type: none">• Railing support locations• Openings in structural elements• Secondary support elements (hangers, brackets, etc.).	

Send feedback to communications@bimforum.org



Copyright © 2023 BIMForum. All rights reserved
This document is copyrighted under a [Creative Commons Attribution-NonCommercial-NoDerivatives 4.0 International License](https://creativecommons.org/licenses/by-nc-nd/4.0/).

Unifomat / Omniclass / Uniclass

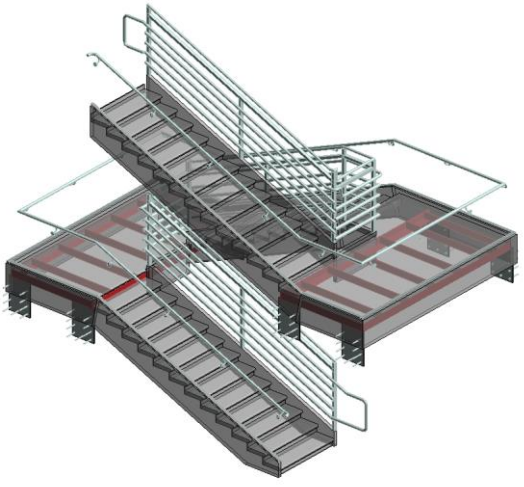
400	<p>Inclusions:</p> <ul style="list-style-type: none"> • Elements necessary for fabrication and installation 	
-----	--	--

B1080.20 / 21-02 10 80 10 / Ss 35 10 Precast Structural Stairs (Concrete)

Includes: Structural framing for exterior and interior stairs including treads, risers, and landings. Includes fire escapes and ladders.

Associated Masterformat Sections: 03 11 23 / 03 30 00 / 03 41 23 / 03 48 19 / 05 51 00
05 55 00 / 05 71 00 / 06 43 00

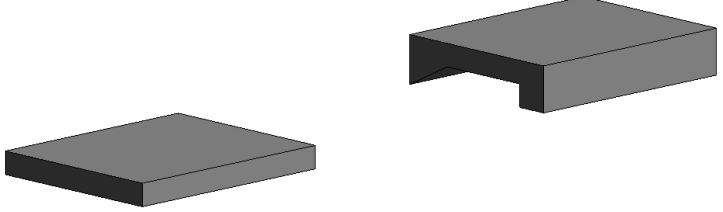
100	See B1080	
200	<p>Inclusions:</p> <ul style="list-style-type: none"> • Reliable number and arrangement of landings and flights 	

Unifomat / Omniclass / Uniclass

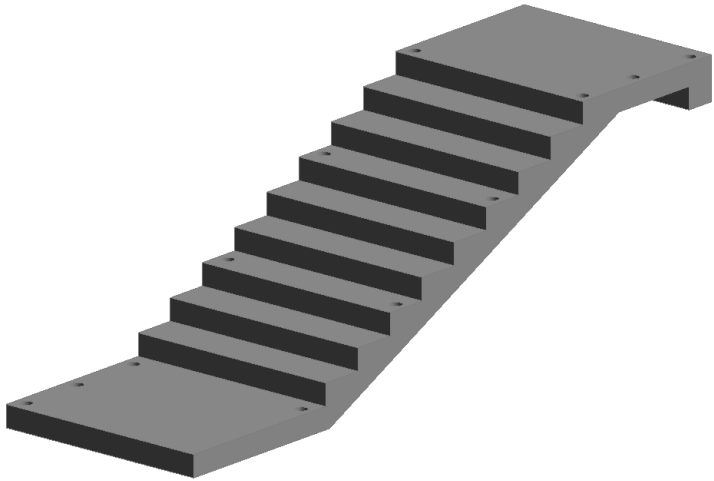
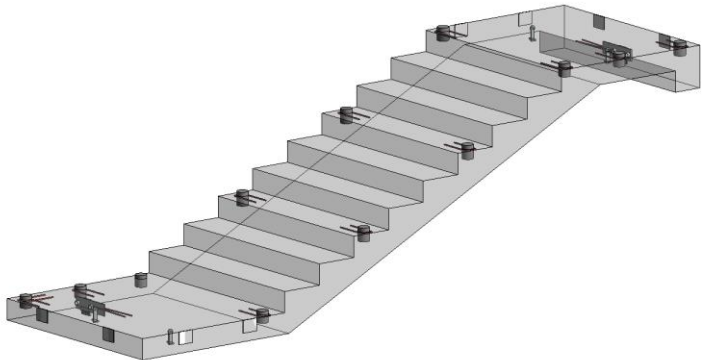
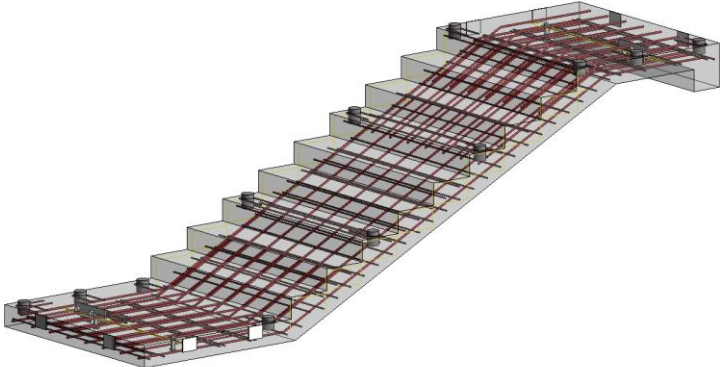
300	<p>Inclusions:</p> <ul style="list-style-type: none">• Overall geometry of landings and flights• Number of risers and treads• Tread width• Riser height• Stringers• Railing• Nosing geometry	
350	<p>Inclusions:</p> <ul style="list-style-type: none">• Railing support locations• Openings in structural elements• Embeds• Secondary support elements (hangers, brackets, etc.).• Reinforcing Post-tension profiles and tendon locations• Joint locations• Attachment points for Lifting devices• All penetrations modeled to rough opening dimensions.• Any permanent forming or shoring components	
400	<p>Inclusions:</p> <ul style="list-style-type: none">• Elements necessary for fabrication and installation• Chamfer	

Send feedback to communications@bimforum.org



Copyright © 2023 BIMForum. All rights reserved
This document is copyrighted under a [Creative Commons Attribution-NonCommercial-NoDerivatives 4.0 International License](https://creativecommons.org/licenses/by-nc-nd/4.0/).

Unifomat / Omniclass / Uniclass

B1080.30 / 21-02 10 80 30 / Ss 30 25 10 35
Stair Soffits TBD

B1080.50 / 21-02 10 80 50 / Ss 25 15 60 35
Stair Railings

Associated Masterformat Sections: 05 15 00 / 05 52 00 / 05 73 00 / 06 43 16 / 06 63 00
06 81 00

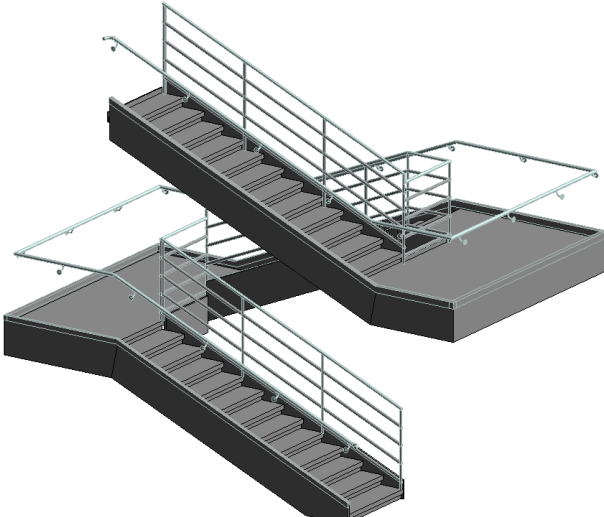
100	N/A	
200	Inclusions: <ul style="list-style-type: none">• Element envelope	
300	Inclusions <ul style="list-style-type: none">• Individual members (e.g., uprights and longitudinal)	

Unifomat / Omniclass / Uniclass

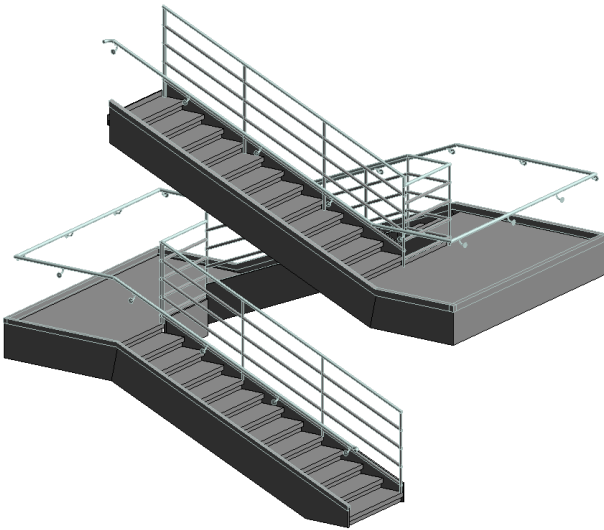
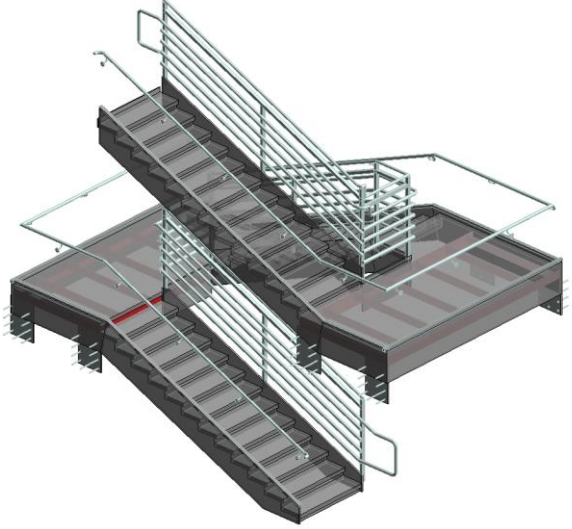
350	<p>Inclusions</p> <ul style="list-style-type: none">• Attachment points	
400	<p>Inclusions</p> <ul style="list-style-type: none">• Attachment points	

B1080.60 / 21-02 10 80 60 / Ss 35 10 30 40
Fire Escapes

Associated Masterformat Sections: 05 51 23
See B1080.10

Send feedback to communications@bimforum.org



Copyright © 2023 BIMForum. All rights reserved
This document is copyrighted under a [Creative Commons Attribution-NonCommercial-NoDerivatives 4.0 International License](https://creativecommons.org/licenses/by-nc-nd/4.0/).

Unifomat / Omniclass / Uniclass

B1080.70 / 21-02 10 80 70 / Ss 35 10 30 95

Metal Walkways

Includes: Catwalks and gratings over horizontal openings

Associated Masterformat Sections: 05 51 36 / 05 51 36.13 / 05 53 00

See B1080.10 and B1080.50

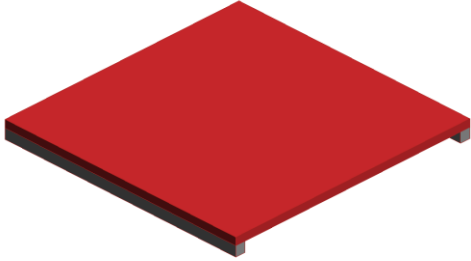
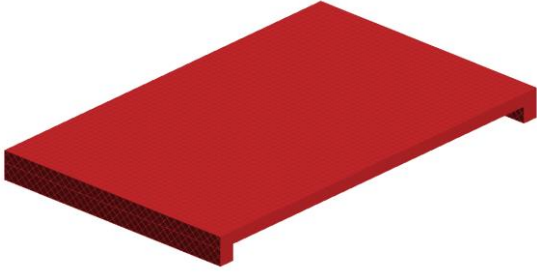
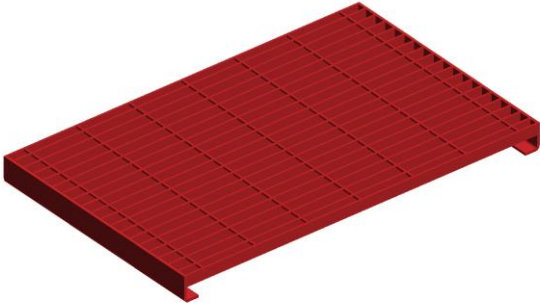
100	See B1080	
200	<p>Inclusions:</p> <ul style="list-style-type: none"> • Element envelope 	
300	<p>Element modeling to include:</p> <ul style="list-style-type: none"> • Overall geometry. • Thickness 	
350	<p>Inclusions</p> <ul style="list-style-type: none"> • Panel layout and grating deck edges. • Openings with any dimension greater than 6" (15 cm) or as noted • Indication of span direction • Configuration of grating elements 	

Uniformat / Omniclass / Uniclass

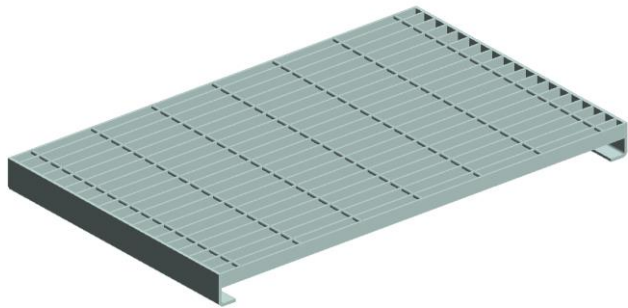
400	<p>Inclusions:</p> <ul style="list-style-type: none"> • Elements necessary for fabrication and installation 	
-----	--	--

B1080.80 / 21-02 10 80 80 / Ss 35 10 30

Ladders

Associated Masterformat Sections: 05 51 33 / 05 51 33.13 / 05 51 33.16 / 05 51 33.23
See B1080.10 and B1080.50

B20 / 21-02 20 / EF 25 10 Exterior Vertical Enclosures

Associated Masterformat Sections: 01 83 16

100	<p>Inclusions:</p> <ul style="list-style-type: none"> • Solid mass model representing overall building volume; or, schematic wall elements that are not distinguishable by type or material. 	
-----	---	--

B2010 / 21-02 20 10 / EF 25 10 Exterior Walls

Includes: Exterior Wall Supplementary Components as appropriate. Includes Exterior Wall Opening Supplementary Components as appropriate. Includes: Solid wall construction that is composite in nature; in other words, multiple layers of materials to form an overall assembly.

Associated Masterformat Sections: 01 83 16

Note: This classification refers to walls modeled as single composite objects. If individual layers are to be modeled refer to:

B2010.10	21-02 20 10 10	Exterior Wall Veneer
B2010.20	21-02 20 10 20	Exterior Wall Construction
B2010.30	21-02 20 10 30	Exterior Wall Interior Skin

100	See B20	
-----	---------	--

Uniformat / Omniclass / Uniclass

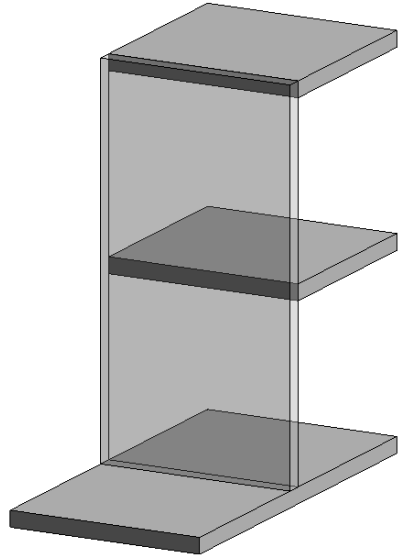
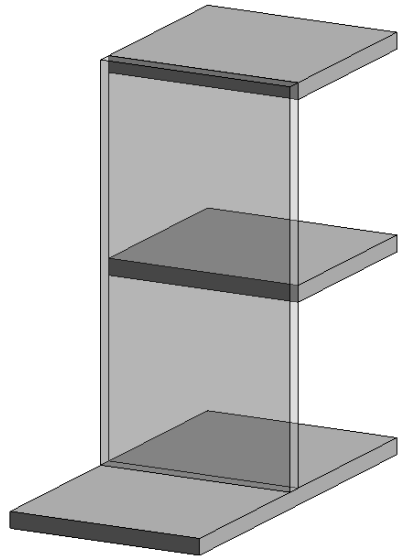
200	<p>Inclusions:</p> <ul style="list-style-type: none">• Approximate overall wall thickness represented by a single assembly.	
300	<p>Inclusions:</p> <ul style="list-style-type: none">• Single model element separated by type of material with accurate overall thickness and shape• Openings with any dimension greater than 6" (15 cm) or as noted• Window and door openings at nominal dimensions	

Send feedback to communications@bimforum.org

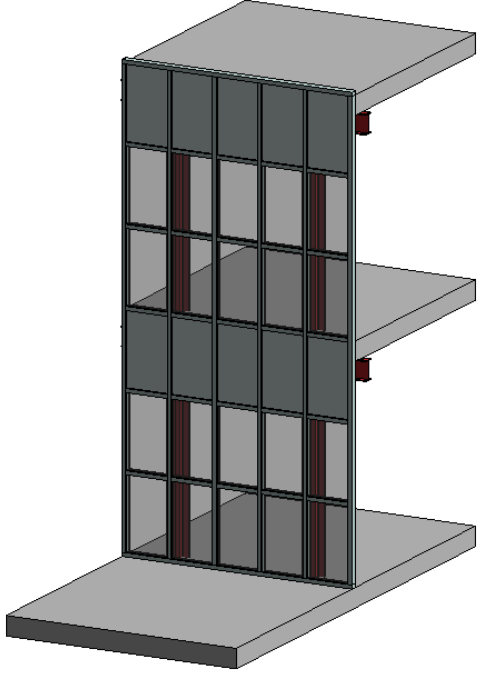

Unifomat / Omniclass / Uniclass

350	<p>Inclusions:</p> <ul style="list-style-type: none"> • Single element showing all layers such that they can be measured • All penetrations modeled to rough opening dimensions. 	
-----	--	---

B2010.10 / 21-02 20 10 10 / EF 25 10 Exterior Wall Veneer

Includes: Nonstructural outside face elements of exterior walls. Includes precast concrete, unit masonry, EIFS, manufactured siding, and stucco Includes water repellents, coatings, and painting.

Associated Masterformat Sections: 03 40 00 / 04 20 00 / 04 26 13 / 04 42 00 / 04 43 13
04 70 00 / 05 19 13 / 06 20 13 / 06 61 00 / 07 19 00 / 07 24 00 / 07 42 00 / 07 44 00
07 46 00 / 09 24 00 / 09 24 23 / 09 90 00

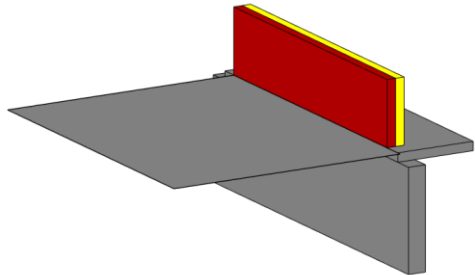
100	N/A	
200	<p>Inclusions:</p> <ul style="list-style-type: none"> • Approximate overall wall thickness represented by a single assembly. 	

Send feedback to communications@bimforum.org



Copyright © 2023 BIMForum. All rights reserved
This document is copyrighted under a [Creative Commons Attribution-NonCommercial-NoDerivatives 4.0 International License](https://creativecommons.org/licenses/by-nc-nd/4.0/).

Uniformat / Omniclass / Uniclass

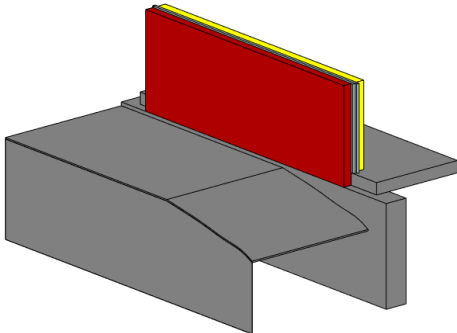
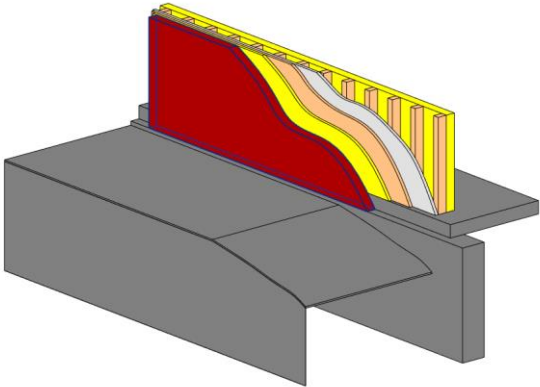
300	<p>Inclusions:</p> <ul style="list-style-type: none"> • Model elements separated by type of material • Openings with any dimension greater than 6" (15 cm) or as noted • Window and door openings at nominal dimensions 	
350	<p>Inclusions:</p> <ul style="list-style-type: none"> • Single element showing all layers such that they can be measured • All penetrations modeled to rough opening dimensions. • Precast concrete panels are individually modeled. Connection points are specified. • Connection to interfacing systems 	

B2010.20 / 21-02 20 10 20 / EF 25 10

Exterior Wall Construction

Includes: Exterior wall construction including backup systems for wall veneer. May be vertical load bearing. Includes cast-in-place concrete walls, precast concrete walls, unit masonry walls, metal framed wall systems, and wood framed wall systems.

Associated Masterformat Sections: 03 30 00 / 03 40 00 / 04 20 00 / 05 41 00 / 06 11 00
06 12 00 / 06 16 00

100	N/A	
200	<p>Inclusions</p> <ul style="list-style-type: none"> • Generic wall objects separated by type of material (e.g. masonry, concrete). • Approximate thickness of layer represented by a single object. 	
300	<p>Inclusions:</p> <ul style="list-style-type: none"> • Single model element with accurate thickness and shape • Openings with any dimension greater than 6" (15 cm) or as noted • Window and door openings at nominal dimensions 	

Send feedback to communications@bimforum.org



Copyright © 2023 BIMForum. All rights reserved
This document is copyrighted under a [Creative Commons Attribution-NonCommercial-NoDerivatives 4.0 International License](https://creativecommons.org/licenses/by-nc-nd/4.0/).

Unifomat / Omniclass / Uniclass

B2010.20.10 / 21-02 20 10 20 10 / Ss 25 11 90

Exterior Wall Construction (Wood)

Includes: Exterior Wall Supplementary Components as appropriate. Includes Exterior Wall Opening Supplementary Components as appropriate. Includes: Solid wall construction that is composite in nature; in other words, multiple layers of materials to form an overall assembly.

Associated Masterformat Sections: 01 83 16

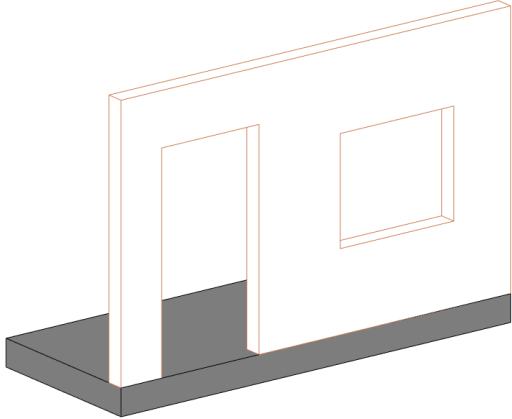
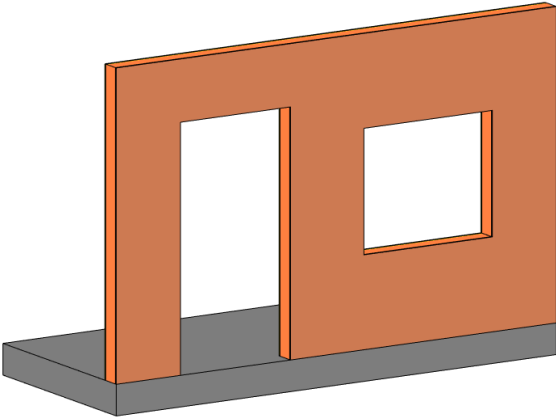
100	N/A	
200	See B2010.20	
300	See B2010.20	

Send feedback to communications@bimforum.org



Copyright © 2023 BIMForum. All rights reserved
This document is copyrighted under a [Creative Commons Attribution-NonCommercial-NoDerivatives 4.0 International License](https://creativecommons.org/licenses/by-nc-nd/4.0/).

Unifomat / Omniclass / Uniclass

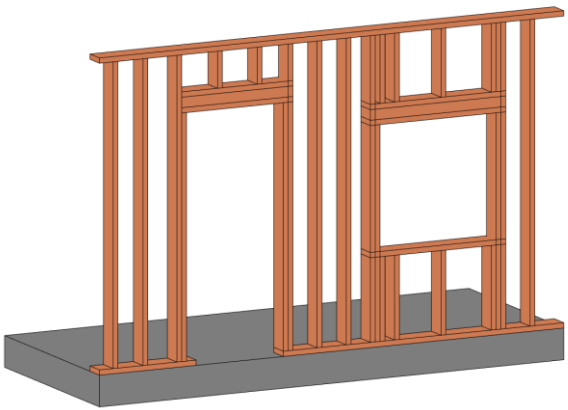
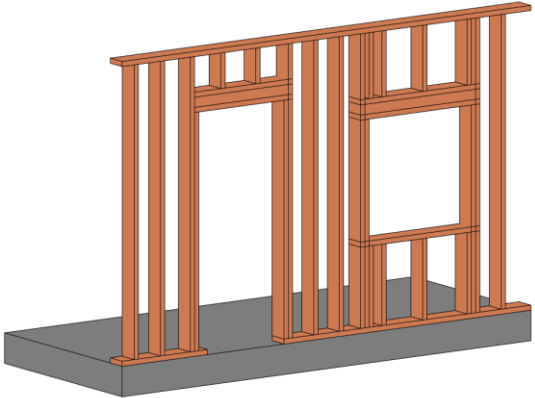
350	<p>Inclusions:</p> <ul style="list-style-type: none"> • King studs and headers • Backing and blocking • Shear panels • All penetrations modeled at rough-opening dimensions. • Cladding and sheathing 	
400	<p>Inclusions:</p> <ul style="list-style-type: none"> • Individual studs 	

B2010.20.20 / 21-02 20 10 20 20 / Ss 25 10 32 45
Exterior Wall Construction (Cold-Form Metal Framing)
See B2010.20.10

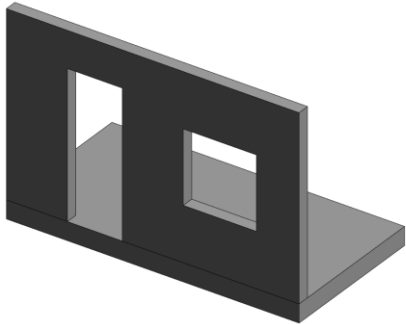
100	N/A	
200	See B2010.20	

Send feedback to communications@bimforum.org



Copyright © 2023 BIMForum. All rights reserved
This document is copyrighted under a [Creative Commons Attribution-NonCommercial-NoDerivatives 4.0 International License](https://creativecommons.org/licenses/by-nc-nd/4.0/).

Unifomat / Omniclass / Uniclass

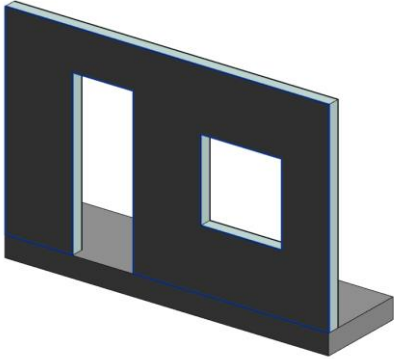
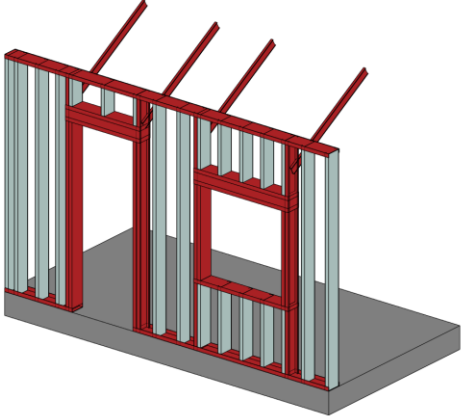
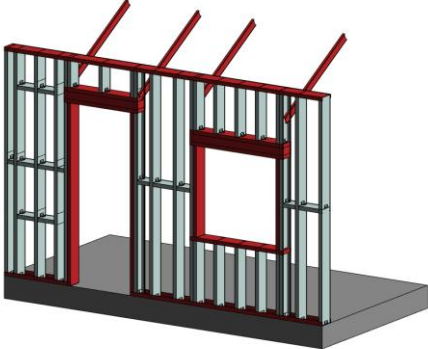
300	See B2010.20	
350	Inclusions: <ul style="list-style-type: none">• King studs and headers• Backing and blocking• Shear panels• All penetrations modeled at rough-opening dimensions.• Cladding and sheathing	
400	Inclusions: <ul style="list-style-type: none">• Individual studs	

Send feedback to communications@bimforum.org



Copyright © 2023 BIMForum. All rights reserved
This document is copyrighted under a [Creative Commons Attribution-NonCommercial-NoDerivatives 4.0 International License](https://creativecommons.org/licenses/by-nc-nd/4.0/).

Unifomat / Omniclass / Uniclass

B2010.20.30 / 21-02 20 10 20 30 / Ss 25 13 50

Exterior Wall Construction (Masonry)

Includes: Exterior Wall Supplementary Components as appropriate. Includes Exterior Wall Opening Supplementary Components as appropriate. Includes: Solid wall construction that is composite in nature; in other words, multiple layers of materials to form an overall assembly.

Associated Masterformat Sections: 01 83 16

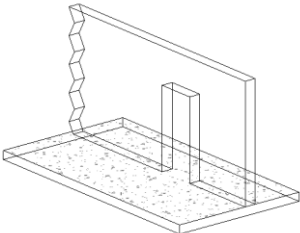
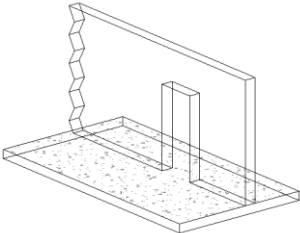
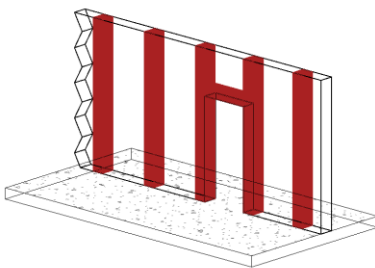
100	N/A	
200	See B2010.20	
300	See B2010.20	
350	<p>Inclusions</p> <ul style="list-style-type: none"> • All penetrations, modeled to rough opening dimensions. • Anchor elements • Exposed embeds • Lintels • Dowels • Post-tension anchor points. • Critical structural zones such as zones that cannot be penetrated or cut • Expansion joints • Lifting points • Bond beams 	

Unifomat / Omniclass / Uniclass

400	<p>Inclusions:</p> <ul style="list-style-type: none"> • Waterproofing • Coursing • Reinforcements 	
-----	--	--

B2010.20.40 / 21-02 20 10 20 40 / Ss 25 16 65

Precast Wall Construction (Concrete)

Includes: Exterior wall construction including backup systems for wall veneer. May be vertical load bearing. Includes cast-in-place concrete walls, precast concrete walls, unit masonry walls, metal framed wall systems, and wood framed wall systems.

Associated Masterformat Sections: 03 30 00 / 03 40 00 / 04 20 00 / 05 41 00 / 06 11 00
06 12 00 / 06 16 00

100	N/A	
200	See B2010.20	
300	See B2010.20	

Send feedback to communications@bimforum.org



Copyright © 2023 BIMForum. All rights reserved
This document is copyrighted under a [Creative Commons Attribution-NonCommercial-NoDerivatives 4.0 International License](https://creativecommons.org/licenses/by-nc-nd/4.0/).

Uniformat / Omniclass / Uniclass

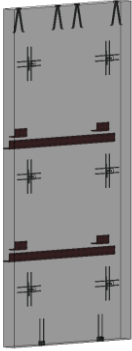
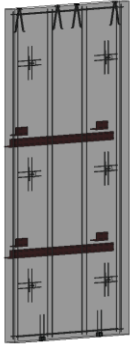
350	<p>Inclusions:</p> <ul style="list-style-type: none"> • Reinforcing Post-tension profiles and strand locations • Pour joints • Expansion Joints • Control joints • Lifting devices • Embeds • All penetrations are modeled at actual rough-opening dimensions. • Any permanent forming or shoring components • Dowels 	
400	<p>Inclusions:</p> <ul style="list-style-type: none"> • Rebar including hooks and lap splices • Post-tensioning tendons • Pour Joints 	

B2010.20.50 / 21-02 20 10 20 50 / Exterior Wall Construction (Cast-in Place Concrete)

Includes: Exterior Wall Supplementary Components as appropriate. Includes Exterior Wall Opening Supplementary Components as appropriate. Includes: Solid wall construction that is composite in nature; in other words, multiple layers of materials to form an overall assembly.

Associated Masterformat Sections:

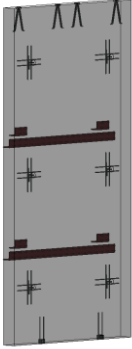
100	N/A	
200	See B2010.20	
300	See B2010.20	
350	<p>Inclusions:</p> <ul style="list-style-type: none"> • Penetrations at rough opening dimensions. • Pour joints • Control joints • Expansion joints • Anchor elements • Embeds • Embeds • Dowels • Post tension anchor points 	

Send feedback to communications@bimforum.org



Copyright © 2023 BIMForum. All rights reserved
This document is copyrighted under a [Creative Commons Attribution-NonCommercial-NoDerivatives 4.0 International License](https://creativecommons.org/licenses/by-nc-nd/4.0/).

Unifomat / Omniclass / Uniclass

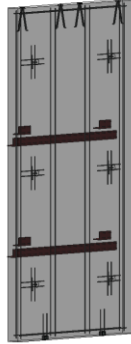
400	<p>Inclusions:</p> <ul style="list-style-type: none"> • Rebar including hooks and lap splices • Post-tensioning tendons • Pour Joints 	
-----	--	---

B2010.30 / 21-02 20 10 30 / Ss 25 45 Exterior Wall Interior Skin

Includes: Materials to provide finish or protective covering on inside of face of exterior walls. May include insulation and vapor retarder.
Associated Masterformat Sections: 09 20 00

100	N/A	
200	<p>Inclusions:</p> <ul style="list-style-type: none"> • approximate thickness of layer 	
300	<p>Inclusions:</p> <ul style="list-style-type: none"> • Single model element separated by type of material with accurate overall thickness and shape • Openings with any dimension greater than 6" (15 cm) or as noted • Window and door openings at nominal dimensions 	
350	<p>Inclusions:</p> <ul style="list-style-type: none"> • Single element showing all layers such that they can be measured • All penetrations modeled to rough opening dimensions. • Connection to interfacing systems 	
400	<p>Inclusions:</p> <ul style="list-style-type: none"> • Studs and tracks • Individual masonry units • Reinforcing • Wall board • Insulation 	

Send feedback to communications@bimforum.org



Copyright © 2023 BIMForum. All rights reserved
This document is copyrighted under a [Creative Commons Attribution-NonCommercial-NoDerivatives 4.0 International License](https://creativecommons.org/licenses/by-nc-nd/4.0/).

Unifomat / Omniclass / Uniclass

B2010.40 / 21-02 20 10 40 / Ss 25 12 Fabricated Exterior Wall Assemblies TBD

Includes: Manufactured or fabricated assemblies that include exterior veneer and wall construction within one fabricated assembly and may also include interior skin. Includes Exterior Wall Supplementary Components as appropriate.

Associated Masterformat Sections: 04 25 00 / 07 42 63 / 07 44 63 / 08 44 00 / 08 45 00

B2020.30 / 21-02 20 20 30 / -- Exterior Window Wall

B2010.50 / 21-02 20 10 50 / Ss 25 15 60 5 Parapets

Includes: Exterior wall construction above plane of roof.

Associated Masterformat Sections: 03 30 00 / 03 40 00 / 04 20 00 / 05 41 00 / 06 11 00
06 12 00 / 06 16 00

See B2010, B2010.10, B2010.20, and B2010.30

B2010.60 / 21-02 20 10 60 / EF 25 10 Equipment Screens

Includes: Exterior wall construction to screen equipment from public view.

Associated Masterformat Sections: 03 40 00 / 04 20 00 / 08 92 00

100	N/A	
200	Inclusions <ul style="list-style-type: none">• Location of face	
300	Inclusions <ul style="list-style-type: none">• Support structure elements• Doors• ladders	
350	Inclusions <ul style="list-style-type: none">• connections	

B2010.80 / 21-02 20 10 80 / Ss 25 60 Exterior Wall Supplementary Components

See [General Notes](#): Supplementary Components

B2010.90 / 21-02 20 10 90 / Ss 25 38 Exterior Wall Opening Supplementary Components

See [General Notes](#): Supplementary Components

Send feedback to communications@bimforum.org



Copyright © 2023 BIMForum. All rights reserved.
This document is copyrighted under a [Creative Commons Attribution-NonCommercial-NoDerivatives 4.0 International License](#).

Uniformat / Omniclass / Uniclass

B2020 / 21-02 20 20 / Ss 25 30 95 26

Exterior Windows

Includes: Fixed or operable windows used singly and in multiples located in the exterior vertical enclosure. Includes Exterior Window Supplementary Components as appropriate. Includes windows units with louver blinds integrally set between glass panels. Includes metal, wood, plastic, and composite window units. May Include: Wall Opening Supplementary Components as appropriate.

Associated Masterformat Sections: 01 83 16 / 08 50 00

100	N/A	
200	Inclusions: <ul style="list-style-type: none">• Generic window object	

B2020

Exterior Windows

Includes: Fixed or operable windows used singly and in multiples located in the exterior vertical enclosure. Includes Exterior Window Supplementary Components as appropriate. Includes windows units with louver blinds integrally set between glass panels. Includes metal, wood, plastic, and composite window units. May Include: Wall Opening Supplementary Components as appropriate.

Associated Masterformat Sections:

B2020.10 / 21-02 20 20 10 / Ss 25 30 95 26

Exterior Operating Windows

Includes: Window screens and storm windows.

Associated Masterformat Sections: 08 50 00 / 08 51 66 / 08 52 66 / 08 53 66 / 08 54 66
08 51 69 / 08 52 69 / 08 53 69 / 08 54 69

100	N/A	
200	See B2020	
300	Inclusions: <ul style="list-style-type: none">• specific type and size• Direction of opening	
350	Inclusions: <ul style="list-style-type: none">• Attachment elements of window to structure	
400	Inclusions: <ul style="list-style-type: none">• Detailed frame extrusion profiles• Fasteners	

B2020.20 / 21-02 20 20 20 / Ss 25 30 95 26

Exterior Fixed Windows

Associated Masterformat Sections: 08 50 00

See B2020.10

Send feedback to communications@bimforum.org



Copyright © 2023 BIMForum. All rights reserved.
This document is copyrighted under a [Creative Commons Attribution-NonCommercial-NoDerivatives 4.0 International License](https://creativecommons.org/licenses/by-nc-nd/4.0/).

Unifomat / Omniclass / Uniclass

B2020.30 / 21-02 20 20 30 / Ss 25 30 95 96

Exterior Window Wall

Associated Masterformat Sections: 08 43 00

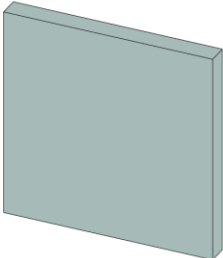
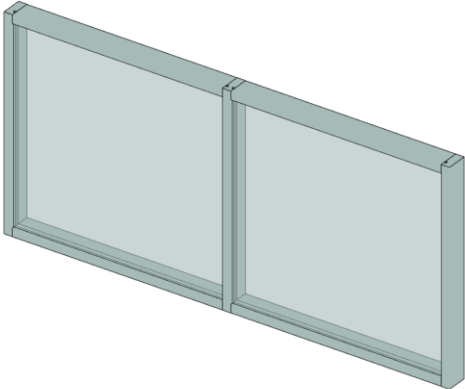
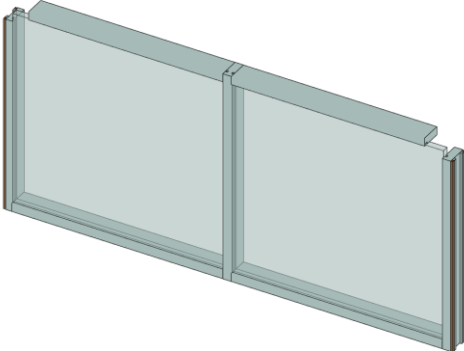
100	See B20	
200	<p>Inclusions</p> <ul style="list-style-type: none">• Area of wall• Thickness of wall	
300	<p>Inclusions</p> <ul style="list-style-type: none">• Mullions• Glazing elements• Operable components	
350	<p>Inclusions</p> <ul style="list-style-type: none">• Anchorage points	

Send feedback to communications@bimforum.org



Copyright © 2023 BIMForum. All rights reserved
This document is copyrighted under a [Creative Commons Attribution-NonCommercial-NoDerivatives 4.0 International License](https://creativecommons.org/licenses/by-nc-nd/4.0/).

Uniformat / Omniclass / Uniclass

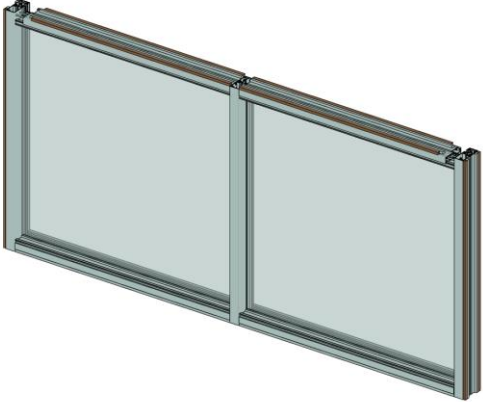
400	<p>Inclusions</p> <ul style="list-style-type: none"> • mullion extrusion profiles. • sealants, • end dams, • flashings • membranes. 	
-----	--	--

B2020.50 / 21-02 20 20 50 / Ss 25 30 95 26 Exterior Special Function Windows

Includes: Exterior windows with special characteristics for a special function.

Associated Masterformat Sections: 08 56 00 / 08 55 00 / 08 88 39 / 08 56 19 / 08 56 46
08 56 49 / 08 88 49 / 08 56 53 / 08 88 53 / 08 88 56 / 08 56 63 / 08 56 73 / 08 75 00
08 80 00

See B2020.10

B2050 / 21-02 20 50 / Ss 25 30 20 Exterior Doors and Grilles

Includes: Doors, grilles, and gates located in the exterior vertical enclosure. Includes screen and storm door assemblies. Includes Exterior Door Supplementary Components as appropriate. May Include: Wall Opening Supplementary Components as appropriate.

Associated Masterformat Sections: 01 83 16

100	N/A	
200	<p>Inclusions</p> <ul style="list-style-type: none"> • Generic object 	

B2050.10 / 21-02 20 50 10 / Ss 25 30 20 25 Exterior Entrance Doors

Includes: Exterior personnel door assemblies at main entrances. Includes automatic, revolving, balanced, and other special operating entrance doors, and sliding storefront wall systems.

Associated Masterformat Sections: 08 32 00 / 08 42 00 / 08 42 26 / 08 42 29 / 08 42 33
08 42 36 / 08 43 29

100	N/A	
200	See B2050	

Send feedback to communications@bimforum.org



Copyright © 2023 BIMForum. All rights reserved
This document is copyrighted under a [Creative Commons Attribution-NonCommercial-NoDerivatives 4.0 International License](https://creativecommons.org/licenses/by-nc-nd/4.0/).

Uniformat / Omniclass / Uniclass

300	Inclusions <ul style="list-style-type: none"> • Specific door panels and frames (if applicable). • Operation • If clearances are to be modeled indicate in a note • Panic bars if applicable 	
350	Inclusions <ul style="list-style-type: none"> • Grillwork if applicable • jambs • Thresholds • Operation and mechanism element envelopes • Connections and interfaces • hardware 	
400	Inclusions TBD	

B2050.20 / 21-02 20 50 20 / Ss 25 30 20 25

Exterior Utility Doors

Includes: Exterior personnel door assemblies other than at main entrances.

Associated Masterformat Sections: 08 10 00

See B2050.10

B2050.30 / 21-02 20 50 30 / Ss 25 30 20 25

Exterior Oversize Doors

Includes: Large exterior door assemblies to allow for passage of large objects involving various operating methods. Includes Exterior Door Supplementary Components as appropriate including operators and drive mechanisms.

Associated Masterformat Sections: 08 33 00 / 08 36 00 / 08 36 13 / 08 36 16 / 08 36 19

08 36 23 / 08 34 16

100	N/A	
200	See B2050	
300	Inclusions <ul style="list-style-type: none"> • Specific door panels and frames (if applicable). • Operation • If clearances are to be modeled indicate in a note • Indication of hardware set 	
350	Inclusions <ul style="list-style-type: none"> • jambs • Thresholds • Operation and mechanism element envelopes • Connections and interfaces 	
400	Inclusions TBD	

Send feedback to communications@bimforum.org



Copyright © 2023 BIMForum. All rights reserved.
This document is copyrighted under a [Creative Commons Attribution-NonCommercial-NoDerivatives 4.0 International License](https://creativecommons.org/licenses/by-nc-nd/4.0/).

Uniformat / Omniclass / Uniclass

B2050.40 / 21-02 20 50 40 / Ss 25 30 20 25

Exterior Special Function Doors

Includes: Exterior door assemblies for a variety of special functions and applications involving a variety of operating methods. Includes Exterior Door Supplementary Components as appropriate including controls and operators.

Associated Masterformat Sections: 08 30 00 / 08 34 13 / 08 34 19 / 08 34 46 / 08 34 49
08 34 53 / 08 34 63 / 08 34 73 / 08 38 00 / 08 39 00 / 08 88 49 / 08 88 53 / 08 88 56

See B2050.10

B2050.60 / 21-02 20 50 60 / Ss 25 50 35

Exterior Grilles

Includes: Exterior devices of open construction to provide moveable barrier to provide access through wall or other divider.

Associated Masterformat Sections: 08 33 00 / 08 35 16

See B2050.10

B2050.70 / 21-02 20 50 70 / Ss 25 32 35

Exterior Gates

Includes: Exterior devices of solid or open construction to provide moveable barrier to provide access through wall or other divider.

Associated Masterformat Sections: 08 34 56

See B2050.10

B2050.90 / 21-02 20 50 90 / Ss 25 38 20

Exterior Door Supplementary Components

Includes frames, hardware, glazing and louvers that are part of door to be included with exterior door elements above as appropriate.

Associated Masterformat Sections: 08 10 00 / 08 30 00 / 08 71 00 / 08 80 00 / 08 91 26

See [General Notes](#): Supplementary Components

B2070 / 21-02 20 70 / Ss 25 50 45 45

Exterior Louvers and Vents

Includes: Exterior louvers which are not an integral part of mechanical equipment, including louvers connected to ducts.

Associated Masterformat Sections: 08 90 00

100	Inclusions <ul style="list-style-type: none">• symbol	
200	Inclusions <ul style="list-style-type: none">• Generic model element	
300	Inclusions <ul style="list-style-type: none">• element envelope	
350	Inclusions <ul style="list-style-type: none">• vanes	

Uniformat / Omniclass / Uniclass

B2070.10 / 21-02 20 70 10 / Ss 25 50 45 45

Exterior Louvers

Associated Masterformat Sections: 01 83 16 / 08 91 00

See B2070

B2070.50 / 21-02 20 70 50 / Ss 30 30 73

Exterior Vents

Associated Masterformat Sections: 08 95 00

See B2070

B2080 / 21-02 20 80 / --

Exterior Wall Appurtenances

Includes: Exterior enclosures, grilles and screens of wood, metal, plastic, and other materials for a variety of purposes including screening of equipment.

Associated Masterformat Sections:

See [General Notes](#): Appurtenances

B2080.10 / 21-02 20 80 10 / Ss 25 50 75

Exterior Fixed Grilles and Screens

Includes: Exterior enclosures, grilles and screens of wood, metal, plastic, and other materials for a variety of purposes including screening of equipment.

Associated Masterformat Sections: 05 70 00 / 06 49 00 / 06 60 00 / 06 80 00 / 10 82 13

See B2080

B2080.30 / 21-02 20 80 30 / Ss 25 50

Exterior Opening Protection Devices

Includes: Manufactured items such as louvers, fins, shutters, demountable panels, awnings, and sun screens to provide sun control, privacy, security, insulation, and storm protection on exterior of windows, skylights, and entrances. Includes fixed and moveable, manually and electrically operated, and automatically controlled devices.

Associated Masterformat Sections: 10 71 00 / 10 71 13 / 10 71 16 / 10 73 13

See B2080

Uniformat / Omniclass / Uniclass

B2080.50 / 21-02 20 80 50 / Ss 25 15 60 35

Exterior Balcony Walls and Railings

Includes: Complete balcony wall and railing assemblies. Includes cast-in-place concrete,

Associated Masterformat Sections: 03 30 00 / 03 40 00 / 04 20 00 / 05 41 00 / 06 11 00
06 16 00 / 05 52 00 / 05 73 00 / 06 43 16 / 06 63 00 / 06 81 00

Walls: See B2010

Railings: See B1080.50

B2080.70 / 21-02 20 80 70 / Pr 25 71 14 16

Exterior Fabrications

Includes: Exterior fabrications of a variety of materials formed to various profiles for a variety of purposes including column covers, decorative metal, ornamental woodwork, and plaster fabrications.

Associated Masterformat Sections: 03 49 00 / 05 50 00 / 05 58 13 / 05 70 00 / 06 44 00
06 60 00 / 06 61 00 / 06 80 00 / 09 27 00

See [Fundamental LOD Definitions](#)

B2080.80 / 21-02 20 80 80 / Ss 45 10 10 10

Bird Control Devices

Includes: Mechanical, electrical, physical, and chemical repellent systems, and protective devices.

Associated Masterformat Sections: 10 81 13

See [Fundamental LOD Definitions](#)

B2090 / 21-02 20 90 / Ss 25 60

Exterior Wall Specialties

Includes: Complete fabrication of metal, wood, and fiberglass, including accessories and appurtenances. For example, clocks, below-grade egress assemblies, and window wells.

Associated Masterformat Sections: 07 77 00 / 10 74 00 / 10 74 13 / 10 74 43 / 10 74 46

See [Fundamental LOD Definitions](#)

B30 / 21-02 30 / --

Exterior Horizontal Enclosures

Associated Masterformat Sections: 01 83 16

100	Inclusions: <ul style="list-style-type: none">• Solid mass model representing overall building volume; or, schematic wall elements that are not distinguishable by type or material.	
-----	--	--

Unifomat / Omniclass / Uniclass

B3010 / 21-02 30 10 / Ss 30 10

Roofing

Associated Masterformat Sections: 01 83 19

100	See B30	
200	Inclusions <ul style="list-style-type: none">• Element envelope at average thickness	
300	Inclusions <ul style="list-style-type: none">• Surface slopes• Intended location of roof drains• Openings with any dimension greater than 6" (15 cm) or as noted	
350	Inclusions <ul style="list-style-type: none">• All penetrations at actual rough-opening dimensions.• Flashing	

B3010.10 / 21-02 30 10 10 / Ss 30 10

Steep Slope Roofing

Includes: Lapped roofing shingles, shakes and roofing tiles, including fastening and flashing products and methods. Includes Roofing Supplementary Components as appropriate.

Associated Masterformat Sections: 01 83 19 / 07 30 00 / 07 31 00 / 07 32 00 / 07 41 00
07 61 00 / 07 63 00

See B3010

B3010.50 / 21-02 30 10 50 / Ss 30 10

Low-Slope Roofing

Includes: Membrane roofing of various types and protected membrane roofing, including fastening and flashing products. Includes Roofing Supplementary Components as appropriate.

Associated Masterformat Sections: 01 83 19 / 07 50 00 / 07 55 00 / 07 55 63 / 07 76 00

See B3010

B3010.70 / 21-02 30 10 70 / Ss 30 10

Canopy Roofing

Includes: Roofing of various types over canopies. Includes Roofing Supplementary Components as appropriate.

Associated Masterformat Sections:

See B3010

Send feedback to communications@bimforum.org



Copyright © 2023 BIMForum. All rights reserved.
This document is copyrighted under a [Creative Commons Attribution-NonCommercial-NoDerivatives 4.0 International License](https://creativecommons.org/licenses/by-nc-nd/4.0/).

Uniformat / Omniclass / Uniclass

B3010.90 / 21-02 30 10 90 / --

Roofing Supplementary Components

Includes: substrate boards, vapor retarder, air barriers, deck insulation, flashing and sheet metal, and expansion joints to be included with roofing elements above as appropriate.

Associated Masterformat Sections: 07 22 00 / 07 26 00 / 07 27 00 / 07 62 00 / 07 65 00
07 71 13 / 07 71 16 / 07 71 19 / 07 71 29 / 09 28 00

See [General Notes](#): Supplementary Components

B3020 / 21-02 30 20 / --

Roof Appurtenances

Includes: Roof specialties and accessories installed on or in roofing or traffic bearing horizontal enclosure systems. Includes components for the management of rainwater, but excludes mechanical and structural items.

Associated Masterformat Sections:

See [General Notes](#): Appurtenances

B3020.10 / 21-02 30 20 10 / --

Roof Accessories

Includes: Ladders, curbs, vents, walkways, and snow guards.

Associated Masterformat Sections: 05 51 33 / 07 72 00 / 07 72 13 / 07 72 23 / 07 72 26
07 72 46 / 07 72 53

100	See Fundamental LOD Definitions	
200	See Fundamental LOD Definitions	
300	See Fundamental LOD Definitions	
350	Inclusions <ul style="list-style-type: none">• Attachment points	
400	See Fundamental LOD Definitions	

B3020.30 / 21-02 30 20 30 / --

Roof Specialties

Includes: Cupolas, spires, steeples, and weathervanes.

Associated Masterformat Sections: 10 74 00 / 10 74 23 / 10 74 26 / 10 74 29 / 10 74 33

See [Fundamental LOD Definitions](#)

Uniformat / Omniclass / Uniclass

B3020.70 / 21-02 30 20 70 / Ss 50 30 02

Rainwater Management

Includes: Components to manage rain water from roofing and traffic bearing horizontal enclosures. Includes: Conductor heads, gutters, downspouts, scuppers, and splash blocks.

Associated Masterformat Sections: 07 71 23 / 07 71 33 / 03 48 16

See [Fundamental LOD Definitions](#)

B3040 / 21-02 30 40 / Ss 30 12 20

Traffic Bearing Horizontal Enclosures

Includes: Horizontal enclosures that are also traffic bearing. Includes Horizontal Enclosure Supplementary Components as appropriate.

Associated Masterformat Sections: 01 83 16

See [Fundamental LOD Definitions](#)

B3040.10 / 21-02 30 40 10 / Ss 30 42 30 30

Traffic Bearing Coatings

Includes: Surface applied waterproofing exposed to weather and suitable for pedestrian or vehicular traffic.

Associated Masterformat Sections: 07 18 00

B3040.30 / 21-02 30 40 30 / Ss 32 80 79

Horizontal Waterproofing Membrane

Includes: Substrate board, deck insulation, vapor retarder, sheet metal flashing and trim, flexible flashing, and expansion joints.

Associated Masterformat Sections: 07 10 00

See membrane note

B3040.50 / 21-02 30 40 50 / Ss 30 14

Wear Surfaces

Includes: Wearing surfaces on top of horizontal waterproofing membrane that are suitable for pedestrian or vehicular traffic.

Associated Masterformat Sections: 07 76 00 / 32 13 00 / 32 14 00

See membrane note

Uniformat / Omniclass / Uniclass

B3040.90 / 21-02 30 40 90 / --

Horizontal Enclosure Supplementary Components

Includes: Substrate board, deck insulation, vapor retarder, sheet metal flashing and trim, flexible flashing, and expansion joints to be included with horizontal enclosure elements above as appropriate.

Associated Masterformat Sections: 07 20 00 / 07 26 00 / 07 62 00 / 07 65 00 / 07 71 13
07 71 16 / 07 71 19 / 07 71 29 / 09 28 00

See [Fundamental LOD Definitions](#)

B3060 / 21-02 30 60 / --

Horizontal Openings

Includes: Openings in horizontal enclosures including roofing and traffic bearing horizontal enclosures. Includes Horizontal Opening Supplementary Components as appropriate.

B3060.10 / 21-02 30 60 10 / Ss 30 30 72

Roof Windows and Skylights

Includes: Operable and non-operable roof windows. Includes: Skylights without framing with plastic and glass glazing. Includes: Skylights with framing.

Associated Masterformat Sections: 01 83 16 / 08 60 00 / 08 61 00 / 08 62 00 / 08 63 00
08 64 00 / 08 67 00

See B2020.10

B3060.50 / 21-02 30 60 50 / Ss 30 30

Vents and Hatches

Includes: Other roof openings such as roof hatches, smoke vents, and gravity roof ventilators.

Associated Masterformat Sections: 07 72 33 / 07 72 36

See B2070

B3060.90 / 21-02 30 60 90 / --

Horizontal Opening Supplementary Components

Includes: Frames, hardware, glazing, flashing, and joint sealants to be included with horizontal opening elements above as appropriate.

Associated Masterformat Sections: 08 75 00 / 08 80 00 / 07 60 00 / 07 92 00

See [General Notes](#): Supplementary Components

Unifomat / Omniclass / Uniclass

B3080 / 21-02 30 80 / --

Overhead Exterior Enclosures

Includes: Exposed to weather construction under horizontal enclosure construction. Includes suspension and support systems, insulation, vapor retarders, and air barriers.

Associated Masterformat Sections: 01 83 16

100	N/A	
200	Inclusions: <ul style="list-style-type: none">• Overall scope• thickness/depth of system.	

B3080.10 / 21-02 30 80 10 / Ss 30 25 10 26

Exterior Ceilings

Associated Masterformat Sections: 07 42 00 / 07 44 00 / 09 20 00 / 09 54 00 / 09 56 00
09 90 00

100	N/A	
200	See B3080	
300	Inclusions: <ul style="list-style-type: none">• Overall assembly• Structural backing.• Location of expansion or control joints indicated, but not modeled.	
350	Inclusions: <ul style="list-style-type: none">• Face material.• Structural backing members including bracing/lateral framing/kickers.• Expansion or control joints at accurate width.	
400	Inclusions <ul style="list-style-type: none">• Connections	

B3080.20 / 21-02 30 80 20 / Ss 30 25 10 28

Exterior Soffits

Associated Masterformat Sections: 07 42 93 / 07 44 00 / 08 95 13 / 09 20 00 / 09 54 00
09 56 00 / 09 90 00

See B3080.10

B3080.30 / 21-02 30 80 30 / --

Exterior Bulkheads

Associated Masterformat Sections: 07 42 00 / 07 44 00 / 09 20 00 / 09 54 00 / 09 56 00
09 90 00

See B3080.10

Send feedback to communications@bimforum.org



Copyright © 2023 BIMForum. All rights reserved
This document is copyrighted under a [Creative Commons Attribution-NonCommercial-NoDerivatives 4.0 International License](https://creativecommons.org/licenses/by-nc-nd/4.0/).

Unifomat / Omniclass / Uniclass

C / 21-03 / -- INTERIORS

C10 / 21-03 10 / -- Interior Construction

Associated Masterformat Sections: 01 84 13

C1010 / 21-03 10 10 / Ss 25 10 30 Interior Partitions

Includes: Enclosures and partitions which are fixed and secured in place. Includes walls of concrete; and unit masonry; and wood and metal stud partitions with associated wall surfaces. Includes partitions of an open nature, such as wire mesh partitions. Partitions may be load bearing or non-load bearing. Includes Interior Partition Supplementary Components as appropriate.

Associated Masterformat Sections: 10 22 00 / 01 84 13

100	N/A	
200	Inclusions <ul style="list-style-type: none"> • Generic wall objects • Approximate overall wall thickness represented by a single assembly. • full vs. partial height not differentiated 	

C1010.10 / 21-03 10 10 10 / Ss 25 10 30 Interior Fixed Partitions

Associated Masterformat Sections: 03 30 00 / 03 40 00 / 04 20 00 / 05 41 00 / 06 11 00 / 09 20 00 / 10 22 13

100	N/A	
200	See C1010	
300	Inclusions <ul style="list-style-type: none"> • Composite model assembly by wall type • overall thickness that accounts for framing and finish • locations, heights (full vs. partial height), • Openings with any dimension greater than 6" (15 cm) or as noted, at nominal dimensions 	

C1010.10.10 / 21-03 10 10 10 10 / Ss 25 13 50 56 Interior Wall (Masonry)

100	N/A	
-----	-----	--

Send feedback to communications@bimforum.org



Copyright © 2023 BIMForum. All rights reserved
This document is copyrighted under a [Creative Commons Attribution-NonCommercial-NoDerivatives 4.0 International License](https://creativecommons.org/licenses/by-nc-nd/4.0/).

Unifomat / Omniclass / Uniclass

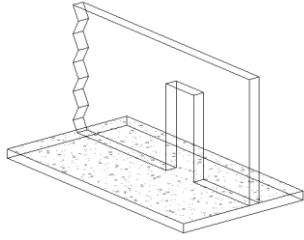
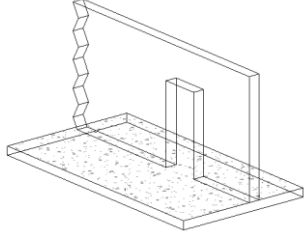
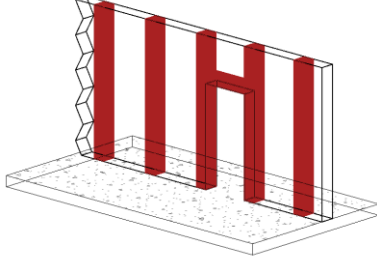
200	See C1010	
300	See C1010.10	
350	<p>Inclusions</p> <ul style="list-style-type: none">• All penetrations at actual rough-opening dimensions.• Any regions that would impact coordination with other systems such as:• Bond Beams & Lintels• Jams	

Unifomat / Omniclass / Uniclass

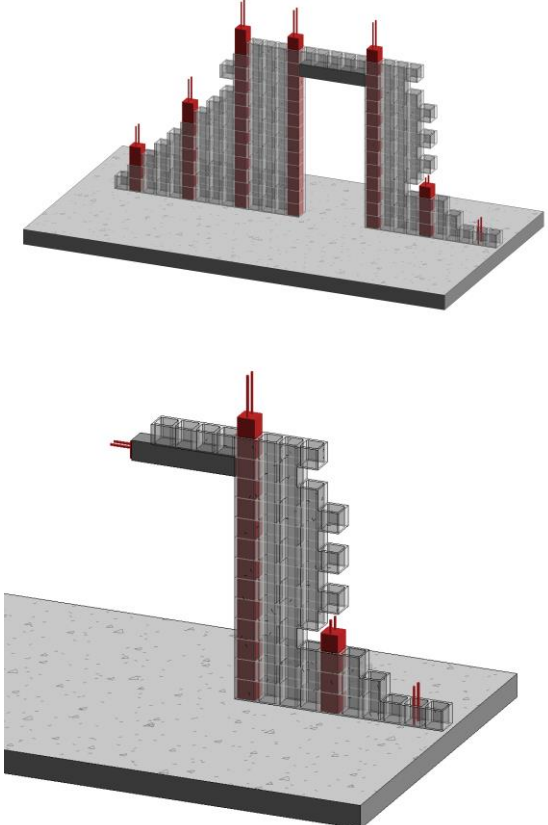
400	<p>Inclusions</p> <ul style="list-style-type: none"> • Individual masonry units • Reinforcing • dowels • Grouting 	
-----	---	---

C1010.10.20 / 21-03 10 10 10 20 / Ss 25 10 32 45
Interior Wall (Cold-Form Metal Framing)

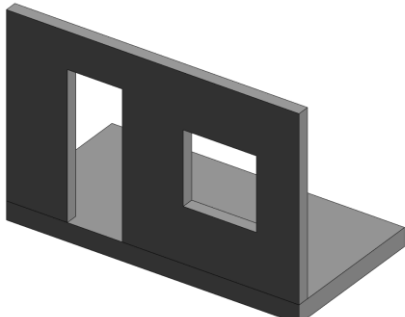
100	N/A	
200	See C1010.10	

Send feedback to communications@bimforum.org



Copyright © 2023 BIMForum. All rights reserved
This document is copyrighted under a [Creative Commons Attribution-NonCommercial-NoDerivatives 4.0 International License](https://creativecommons.org/licenses/by-nc-nd/4.0/).

Unifomat / Omniclass / Uniclass

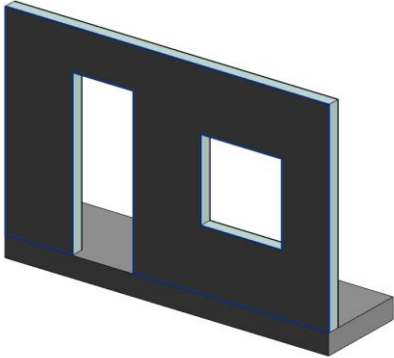
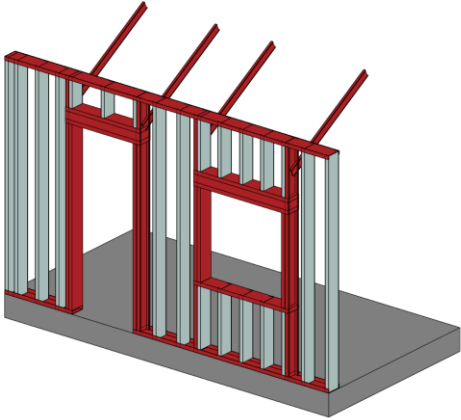
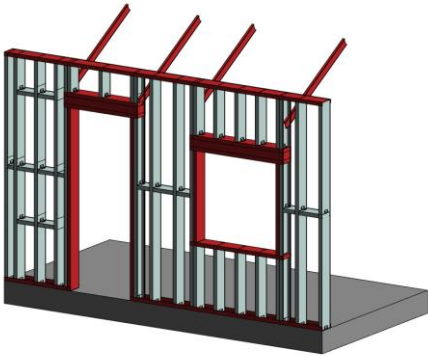
300	See C1010.10	
350	<p>Inclusions</p> <ul style="list-style-type: none"> • Blocking • Elements necessary for detailed interface coordination with other systems. • All penetrations at actual rough-opening dimensions. • Diagonal bracing 	
400	<p>Inclusions</p> <ul style="list-style-type: none"> • Connections 	

C1010.10.30 / 21-03 10 10 10 30 / Ss 25 10 32 90
Interior Wall (Wood)

100	N/A	
-----	-----	--

Send feedback to communications@bimforum.org



Copyright © 2023 BIMForum. All rights reserved.
This document is copyrighted under a [Creative Commons Attribution-NonCommercial-NoDerivatives 4.0 International License](https://creativecommons.org/licenses/by-nc-nd/4.0/).

Unifomat / Omniclass / Uniclass

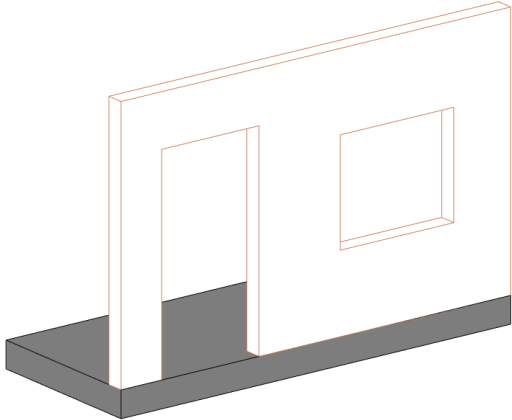
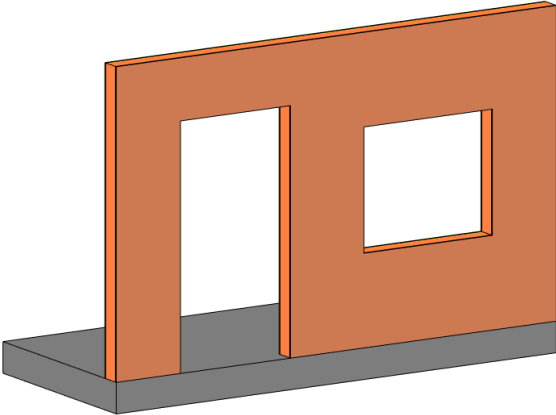
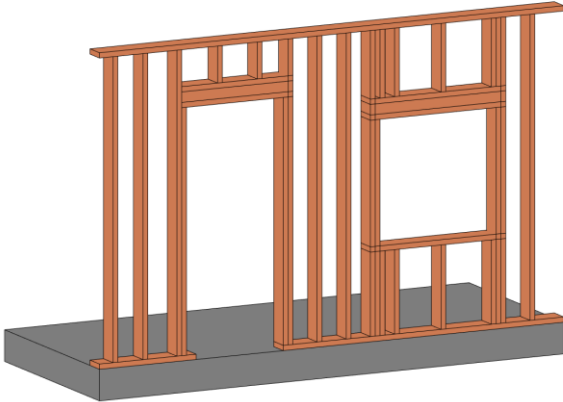
200	See C1010.10	
300	See C1010.10	
350	<p>Inclusions</p> <ul style="list-style-type: none">• Blocking• Elements necessary for detailed interface coordination with other systems.• All penetrations at actual rough-opening dimensions.• Diagonal bracing	

Send feedback to communications@bimforum.org



Copyright © 2023 BIMForum. All rights reserved
This document is copyrighted under a [Creative Commons Attribution-NonCommercial-NoDerivatives 4.0 International License](https://creativecommons.org/licenses/by-nc-nd/4.0/).

Uniformat / Omniclass / Uniclass

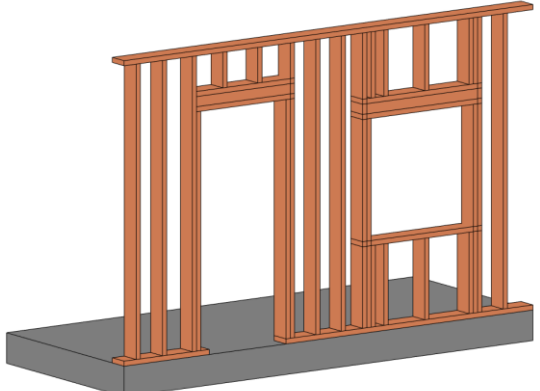
400	<p>Inclusions</p> <ul style="list-style-type: none"> • sufficient detail to support prefabrication • Openings and penetrations through studs • Connections 	
-----	---	--

C1010.20 / 21-03 10 10 20 / Ss 25 10 30

Interior Glazed Partitions

Includes: Partitions primarily composed of glazed elements that may be fabricated or field constructed. Includes Interior Partition Supplementary Components as appropriate.

Associated Masterformat Sections: 08 43 00

100	N/A	
200	See C1010.10	
300	<p>Inclusions</p> <ul style="list-style-type: none"> • Specified location and orientation of face of glass. • Nominal face dimensions and thickness of glazing. • Structural support systems. • Spacing, location, size and orientation of mullions. • Operable components 	
350	<p>Inclusions</p> <ul style="list-style-type: none"> • Actual anchorage layouts and types. • Connection points between glass and supporting structure • Actual panel dimensions (including seating). 	
400	<p>Inclusions</p> <ul style="list-style-type: none"> • mullion extrusion profiles. 	

C1010.40 / 21-03 10 10 40 / Ss 25 12 65 75

Interior Demountable Partitions

Associated Masterformat Sections: 10 22 19 / 01 84 13 / 10 22 19.13 / 10 22 19.23 / 10 22 19.33
10 22 19.43 / 10 22 19.53

100	See C10	
200	<p>Inclusions</p> <ul style="list-style-type: none"> • Generic wall objects • Approximate overall wall thickness represented by a single assembly. • Indication that it is a demountable partition (Uniformat number, name, etc.) 	

Send feedback to communications@bimforum.org



Copyright © 2023 BIMForum. All rights reserved
This document is copyrighted under a [Creative Commons Attribution-NonCommercial-NoDerivatives 4.0 International License](https://creativecommons.org/licenses/by-nc-nd/4.0/).

Uniformat / Omniclass / Uniclass

300	Inclusions <ul style="list-style-type: none"> • Element envelopes of individual panels • Space reservation for support system 	
350	Inclusions: <ul style="list-style-type: none"> • Attachment points to support system 	
400	Inclusions <ul style="list-style-type: none"> • See Fundamental LOD Definitions 	

C1010.50 / 21-03 10 10 50 / Ss 25 12 70 Interior Operable Partitions

Includes: Track-supported, operable panels and partitions, top hung and floor supported, and manually and power operated. Includes auditorium partitions and dividers. Includes overhead supports.

Associated Masterformat Sections: 01 84 13 / 01 84 13 / 10 22 33 / 10 22 36 / 10 22 39
10 22 43

100	See C10	
200	Inclusions <ul style="list-style-type: none"> • Generic wall objects • Approximate overall wall thickness represented by a single assembly. • Indication that it is an operable partition (Uniformat number, name, etc.) 	
300	Inclusions <ul style="list-style-type: none"> • Element envelopes of individual panels • Space reservation for support system, storage pocket, operating mechanisms • Clearances for swing radii 	
350	Inclusions: <ul style="list-style-type: none"> • Attachment points to support system 	
400	Inclusions <ul style="list-style-type: none"> • See Fundamental LOD Definitions 	

C1010.70 / 21-03 10 10 70 / Ss 25 50 75 Interior Screens

Portable and open dividers.

Associated Masterformat Sections: 10 22 23 / 10 82 23
See C1010.40

C1010.90 / 21-03 10 10 90 / -- Interior Partitions Supplementary Components

Sound isolation components, firestopping, and expansion control to be included with interior partition elements above as appropriate.

Associated Masterformat Sections: 13 48 00 / 09 81 00 / 07 84 00 / 07 95 00

See [General Notes](#): Supplementary Components

Send feedback to communications@bimforum.org



Copyright © 2023 BIMForum. All rights reserved.
This document is copyrighted under a [Creative Commons Attribution-NonCommercial-NoDerivatives 4.0 International License](#).

Uniformat / Omniclass / Uniclass

C1020 / 21-03 10 20 / Ss 25 30 95 41

Interior Windows

Includes: Interior fixed or operable windows used singly and in multiples. Includes Interior Window Supplementary Components as appropriate. Includes metal, wood, plastic, and composite window units.

Associated Masterformat Sections: 08 50 00 / 01 84 13

100	See C10	
200	Inclusions <ul style="list-style-type: none"> • Generic window objects 	

C1020.10 / 21-03 10 20 10 / Ss 25 30 95 41

Interior Operating Windows

Includes: Interior fixed or operable windows used singly and in multiples. Includes Interior Window Supplementary Components as appropriate. Includes metal, wood, plastic, and composite window units.

Associated Masterformat Sections: 08 50 00

100	N/A	
200	See C1020	
300	Inclusions: <ul style="list-style-type: none"> • specific type and size • Direction of opening 	
350	Inclusions: <ul style="list-style-type: none"> • Attachment elements of window to structure 	
400	Inclusions: <ul style="list-style-type: none"> • Detailed frame extrusion profiles • Fasteners 	

C1020.20 / 21-03 10 20 20 / Ss 25 30 95 41

Interior Fixed Windows

Includes: Interior fixed or operable windows used singly and in multiples. Includes Interior Window Supplementary Components as appropriate. Includes metal, wood, plastic, and composite window units.

Associated Masterformat Sections: 08 50 00

See C1020.1010

C1020.50 / 21-03 10 20 50 / Ss 25 30 95 41

Interior Special Function Windows

Includes interior windows with special characteristics for a special function.

Associated Masterformat Sections: 08 56 00 / 08 56 19 / 08 56 46 / 08 56 49 / 08 88 49 / 08 56 53 / 08 88 53 / 08 88 56 / 08 56 63 / 08 56 73

See B2020.10

Unifomat / Omniclass / Uniclass

C1020.90 / 21-03 10 20 90 / Ss 25 30 95 41 Interior Window Supplementary Components

Includes: Frames, sills, operating hardware, glazing to be included with interior window elements above as appropriate.

Associated Masterformat Sections: 08 75 00 / 08 80 00

See [General Notes](#): Supplementary Components

C1030 / 21-03 10 30 / Ss 25 30 20 25 Interior Doors

Includes: Interior door assemblies. Includes metal doors and frames, wood doors and frames, plastic doors, and composite doors. Includes Interior Door Supplementary Components as appropriate.

Associated Masterformat Sections: 08 10 00 / 01 84 13

See B2050.10

C1030.10 / 21-03 10 30 10 / Ss 25 30 20 25 Interior Swinging Doors

Includes: Interior door assemblies. Includes metal doors and frames, wood doors and frames, plastic doors, and composite doors. Includes Interior Door Supplementary Components as appropriate.

Associated Masterformat Sections: 08 10 00

See B2050.10

C1030.20 / 21-03 10 30 20 / Ss 25 30 20 25 Interior Entrance Doors

Includes: Exterior personnel door assemblies at interior main entrances. Includes automatic, revolving, balanced, and other special operating entrance doors, and sliding storefront wall systems. Includes Interior Door Supplementary Components as appropriate when not part of storefront system.

Associated Masterformat Sections: 08 42 00 / 08 42 26 / 08 42 29 / 08 42 33 / 08 42 36
08 43 29

[See B2050.10]

C1030.25 / 21-03 10 30 25 / Ss 25 30 20 77 Interior Sliding Doors

Associated Masterformat Sections: 08 11 73 / 08 32 00

100	N/A	
200	See B2050	
300	See B2050	

Uniformat / Omniclass / Uniclass

350	Inclusions <ul style="list-style-type: none"> • jambs • Thresholds • Operation and mechanism element envelopes • Track • Connections and interfaces 	
400	Inclusions TBD	

C1030.30 / 21-03 10 30 30 / Ss 25 30 20 78

Interior Folding Doors

Associated Masterformat Sections: 08 35 13

[See C1030.25]

C1030.40 / 21-03 10 30 40 / Ss 25 30 20 74

Interior Coiling Doors

Associated Masterformat Sections: 08 33 00 / 08 33 13

100	N/A	
200	See C2050.10	
300	Inclusions <ul style="list-style-type: none"> • Element envelopes of individual panels • Space reservation for support system, storage pocket, operating mechanisms • Clearances for swing radii 	
350	Inclusions: <ul style="list-style-type: none"> • Attachment points for support system • Support system • Storage pocket • Operating mechanism 	
400	Inclusions <ul style="list-style-type: none"> • connections and interfaces • brackets, supports, • sealants, • thresholds. 	

C1030.50

Interior Panel Doors

Includes: Interior large opening doors constructed of panels that move.

Associated Masterformat Sections: 08 36 00 / 08 36 13 / 08 36 16 / 08 36 19 / 08 36 23

[See C1030.40]

Uniformat / Omniclass / Uniclass

C1030.70 / 21-03 10 30 70 / Ss 25 30 20 25

Interior Special Function Doors

Includes: Interior door assemblies for a variety of special functions and applications involving a variety of operating methods. Includes Interior Door Supplementary Components as appropriate.

Associated Masterformat Sections: 08 30 00. / 08 34 13 / 08 34 19 / 08 34 33 / 08 34 36
08 34 46 / 08 34 49 / 08 88 49 / 08 34 53 / 08 42 33.13 / 08 88 53 / 08 88 56 / 08 34 59
08 34 63 / 08 34 73 / 08 38 00 / 08 39 00

[See C1030.40]

C1030.80 / 21-03 10 30 80 / Ss 25 30 20 35

Interior Access Doors and Panels

Includes: Doors and panels in walls, ceilings, and floors to provide access to concealed spaces. Includes frames and hardware.

Associated Masterformat Sections: 08 31 00

[See B2050]

C1030.90 / 21-03 10 30 90 / Ss 25 30 20 25

Interior Door Supplementary Components

Includes: Frames, hardware, glazing, and louvers that are part of door to be included with interior door elements above as appropriate.

Associated Masterformat Sections: 08 10 00 / 08 30 00 / 08 71 00 / 08 80 00 / 08 91 26

See [General Notes](#): Supplementary Components

C1040 / 21-03 10 40 / --

Interior Grilles and Gates

Includes: Interior operable grilles and gates Includes frames and hardware.

C1040.10 / 21-03 10 40 10 / Ss 25 50 35

Interior Grilles

Associated Masterformat Sections: 08 11 74 / 08 33 00 / 08 35 16

See B2050.10

C1040.50 / 21-03 10 40 50 / Ss 25 32 35

Interior Gates

Includes: Interior devices of solid or open construction, usually hinged, to provide moveable barrier for access through partition or other divider. Includes hardware, accessories, and finishing.

Associated Masterformat Sections: 08 34 56 / 10 22 16

[See B2050.10]

Unifomat / Omniclass / Uniclass

C1060 / 21-03 10 60 / Ss 30 20 70

Raised Floor Construction

Associated Masterformat Sections: 01 84 13 / 01 84 13 / 01 84 13 / 01 84 13 / 01 84 13
01 84 13 / 01 84 13 / 01 84 13 / 01 84 13

C1060.10 / 21-03 10 60 10 / Ss 30 20 70 70

Access Flooring

Includes: Free-standing, elevated accessible floor assembly forming an underfloor cavity that may be used for utility or other purposes.

Associated Masterformat Sections: 09 69 00

100	N/A	
200	Inclusions: Floor level	
300	Inclusions Floor element Access panels	
350	Inclusions: Locations of vertical supports	

C1060.30 / 21-03 10 60 30 / Ss 30 12 64

Platform/Stage Floors

Includes: Fixed construction of raised floor for platforms or stages.

[See B1010]

C1070 / 21-03 10 70 / --

Suspended Ceiling Construction

Includes: Ceiling Suspension Components.

Associated Masterformat Sections: 01 84 13 / 01 84 13

100	N/A	
200	Inclusions: Element envelope	

C1070.10 / 21-03 10 70 10 / Ss 30 25 22 1

Acoustical Suspended Ceilings

Includes: Suspended tiles and panels with specific characteristics for acoustical purposes.

Associated Masterformat Sections: 09 51 00 / 09 81 00

100	See C1070	
200	See C1070	
300	Inclusions: <ul style="list-style-type: none"> • System thickness. • Changes in ceiling system indicated • expansion or control joints shown as linework or modeled. • Ceiling grid shown as linework. 	

Send feedback to communications@bimforum.org



Copyright © 2023 BIMForum. All rights reserved
This document is copyrighted under a [Creative Commons Attribution-NonCommercial-NoDerivatives 4.0 International License](https://creativecommons.org/licenses/by-nc-nd/4.0/).

Uniformat / Omniclass / Uniclass

350	<p>Inclusions:</p> <ul style="list-style-type: none"> • Ceiling suspension grid. • Insulation • Openings with any dimension greater than 6" (15 cm) or as noted • Hangers and kickers. • Expansion or control joints at accurate width. 	
-----	--	--

C1070.20 / 21-03 10 70 20 / Ss 30 25 10 10 Suspended Plaster and Gypsum Board Ceilings

Includes: Suspended assemblies with plaster and gypsum board surfaces.

Associated Masterformat Sections: 09 20 00 / 09 22 26 / 09 81 00

100	See C1070	
200	See C1070	
300	<p>Inclusions:</p> <ul style="list-style-type: none"> • Overall system thickness including framing. • Bulkheads • Openings with any dimension greater than 6" (15 cm) or as noted 	
350	<p>Inclusions</p> <ul style="list-style-type: none"> • Framing and bracing elements. • Insulation • expansion or control joints shown as linework or modeled. 	
400	<p>Inclusions:</p> <ul style="list-style-type: none"> • All assembly components 	

C1070.50 / 21-03 10 70 50 / Ss 30 25 22 Specialty Suspended Ceilings

Includes: Suspended specialty ceiling panels, units, and materials manufactured as finished

Associated Masterformat Sections: 09 54 00 / 09 56 00

[See C1070.10 or C1070.20]

C1070.70 / 21-03 10 70 70 / Ss 30 25 22 Special Function Suspended Ceilings

Includes: Suspended ceiling assemblies with an additional special function including integrated ceiling assemblies.

Associated Masterformat Sections: 09 57 00 / 09 57 53 / 09 58 00

[See C1070.10 or C1070.20]

Unifomat / Omniclass / Uniclass

C1070.90 / 21-03 10 70 90 / Ss 30 25 22

Ceiling Suspension Components

Includes: Hangers and framing to suspend ceiling and sound isolation components to be included with suspended ceiling construction elements above as appropriate.

Associated Masterformat Sections: 13 48 00

See C1070.10 or C1070.20 for hanger requirements

C1090 / 21-03 10 90 / --

Interior Specialties

C1090.10 / 21-03 10 90 10 / Ss 25 15 60 35

Interior Railings and Handrails

Includes: Complete interior railing assemblies of various types including glazed railings.

Associated Masterformat Sections: 01 84 00 / 01 84 00 / 01 84 00 / 01 84 00 / 05 52 00
05 73 00 / 06 43 16 / 06 63 00 / 06 81 00

100	N/A	
200	Inclusions: <ul style="list-style-type: none">• Element envelope	
300	Inclusions <ul style="list-style-type: none">• Individual members (e.g., uprights and longitudinal)	
350	Inclusions <ul style="list-style-type: none">• Attachment points	
400	Inclusions <ul style="list-style-type: none">• All assembly components including fasteners and supports.	

C1090.15 / 21-03 10 90 15 / Ss 25 50 45 45

Interior Louvers

Includes: Interior louvers, and other items for ventilation which are not an integral part of the mechanical system. Includes operable and stationary louvers.

Associated Masterformat Sections: 08 91 00 / 01 84 00

100	Inclusions <ul style="list-style-type: none">• symbol	
200	Inclusions <ul style="list-style-type: none">• Generic model element	
300	Inclusions <ul style="list-style-type: none">• element envelope	
350	Inclusions <ul style="list-style-type: none">• vanes	

Send feedback to communications@bimforum.org



Copyright © 2023 BIMForum. All rights reserved.
This document is copyrighted under a [Creative Commons Attribution-NonCommercial-NoDerivatives 4.0 International License](https://creativecommons.org/licenses/by-nc-nd/4.0/).

Uniformat / Omniclass / Uniclass

C1090.20 / 21-03 10 90 20 / Ss 40 25 26

Information Specialties

Includes: Visual display units, display cases, directories, interior signage, telephone specialties, and informational kiosks.

Associated Masterformat Sections: 10 10 00 / 10 11 00 / 10 11 13 / 10 11 16 / 10 11 23

10 11 33 / 10 11 36 / 10 11 39 / 10 11 43 / 10 11 46 / 10 12 00 / 10 13 00 / 10 14 00 10 17 00 / 10 18 00

C1090.25 / 21-03 10 90 25 / Ss 25 12 60 60

Compartments and Cubicles

Includes: Manufactured compartments and cubicles for specific purposes. Includes toilet compartments, shower stalls, etc.

Associated Masterformat Sections: 10 21 00 / 10 21 13 / 10 21 16 / 10 21 23 / 10 28 19

C1090.30 / 21-03 10 90 30 / Ss 25 12 65

Service Walls

Includes: Wall assemblies and wall-mounted units incorporating services.

Associated Masterformat Sections: 10 25 00 / 10 25 13 / 10 25 16

[See C1010.10]

C1090.35 / 21-03 10 90 35 / Pr 35 90 43

Wall and Door Protection

Includes: Manufactured protective devices for walls and doors. Includes corner guards, bumper guards, and protective wall covering.

Associated Masterformat Sections: 10 26 00 / 10 26 13 / 10 26 16 / 10 26 23 / 10 26 33

C1090.40 / 21-03 10 90 40 / Pr 40 20 76

Toilet, Bath and Laundry Accessories

Includes: Manufactured items for use in conjunction with toilets, baths, and laundries.

Associated Masterformat Sections: 10 28 00 / 10 28 13 / 10 28 16 / 10 28 23

C1090.45 / 21-03 10 90 45 / Ss 70 80 33

Interior Gas Lighting

Associated Masterformat Sections: 10 84 16

Uniformat / Omniclass / Uniclass

C1090.50 / 21-03 10 90 50 / Pr 70 60 82

Fireplaces and Stoves

Includes: Masonry fireplaces and manufactured and fabricated fireplaces, stoves, chimneys, dampers, and specialties for use in construction of fireplaces and stove units.

Associated Masterformat Sections: 10 30 00 / 04 50 00 / 04 57 00 / 10 31 00 / 10 31 13
10 32 00 / 10 35 00

C1090.60 / 21-03 10 90 60 / Ss 75 50

Safety Specialties

Includes: Accessories that provide emergency aid.

Associated Masterformat Sections: 10 40 00 / 10 41 00 / 10 43 00

C1090.70 / 21-03 10 90 70 / Pr 40 30 78

Storage Specialties

Includes: Lockers, postal specialties, storage specialties, and wardrobe and closet specialties.

Associated Masterformat Sections: 10 50 00 / 10 51 00 / 10 51 53 / 10 55 00 / 10 55 23 / 10 55 91 / 10 56 00 / 10 56 29 / 10 56 33 / 10 57 00 / 10 57 13 / 10 57 33

C1090.90 / 21-03 10 90 90 / Ss 40

Other Interior Specialties

Includes: Pest control devices, flags and banners, security mirrors and domes, and scales.

Associated Masterformat Sections: 10 80 00 / 10 81 00 / 10 81 16 / 10 81 19 / 10 83 00 / 08 83 00 / 10 86 00 / 10 88 00

C20 / 21-03 20 / Ss 25 45

Interior Finishes

Associated Masterformat Sections: 01 84 19

100	N/A	
200	Inclusions <ul style="list-style-type: none">Area defined	
300	Inclusions <ul style="list-style-type: none">Thickness if greater than ¼" (6 mm) or as noted	
350	Inclusions: <ul style="list-style-type: none">Measurable individual layers (e.g. grout and tile for mudset tile)	

Unifomat / Omniclass / Uniclass

C2010 / 21-03 20 10 / Ss 25 45

Wall Finishes

Includes: Wall finishes applied over solid substrates. Includes Wall Finish Supplementary Components as appropriate.

Associated Masterformat Sections: 09 70 00 / 01 84 19 / 01 84 19 / 01 84 19 / 01 84 19 / 01 84

C2010.10 / 21-03 20 10 10 / Ss 25 45 88

Tile Wall Finish

Includes: Manufactured surfacing units of impervious, vitreous, semi-vitreous, and non-vitreous materials; glazed, unglazed, conductive, and textured surfaces.

Associated Masterformat Sections: 09 30 00

See C20

C2010.20 / 21-03 20 10 20 / Ss 25 25

Wall Paneling

Includes: Covering or cladding of interior walls with paneling. Includes associated furring, fastening, and trim.

Associated Masterformat Sections: 06 42 00 / 06 25 00 / 06 26 00 / 06 64 00 / 06 83 00

See C20

C2010.30 / 21-03 20 10 30 / Ss 25 45 74

Wall Coverings

Includes: Wall coverings applied over solid substrates. Includes vinyl-coated fabric, vinyl and cork wall coverings; wall papers; and flexible wood sheets.

Associated Masterformat Sections: 09 72 00 / 09 74 00

See C20

C2010.35 / 21-03 20 10 35 / Ss 25 45 74

Wall Carpeting

Includes: Wall carpet materials and accessories.

Associated Masterformat Sections: 09 73 00

See C20

C2010.50 / 21-03 20 10 50 / Ss 25 20 85

Stone Facing

Includes: Natural stone applied as an interior veneer surface.

Associated Masterformat Sections: 09 75 00

See C20

Send feedback to communications@bimforum.org



Copyright © 2023 BIMForum. All rights reserved.
This document is copyrighted under a [Creative Commons Attribution-NonCommercial-NoDerivatives 4.0 International License](https://creativecommons.org/licenses/by-nc-nd/4.0/).

Uniformat / Omniclass / Uniclass

C2010.60 / 21-03 20 10 60 / Ss 25 45

Special Wall Surfacing

Includes: Manufactured decorative interior wall surface products including plastic blocks.

Associated Masterformat Sections: 09 77 00 / 09 77 13 / 09 77 23 / 09 76 00

See C20

C2010.70 / 21-03 20 10 70 / Ss 40 90 60

Wall Painting and Coating

Includes: Interior painting and coating with transparent and opaque finishes. Includes stains, varnishes, lacquers, primers, fillers, paint removers, and waxes, and preparation of surfaces.

Associated Masterformat Sections: 09 90 00

See C20

C2010.80 / 21-03 20 10 80 / Ss 25 45 02

Acoustical Wall Treatment

Includes: Sound absorbing, reflecting, and diffusing wall units, and accessories.

Associated Masterformat Sections: 09 83 13 / 09 84 00 / 09 84 33

See C20

C2010.90 / 21-03 20 10 90 / Ss 25 45

Wall Finish Supplementary Components

Includes: Furring to be included with wall finish elements above as appropriate.

Associated Masterformat Sections: 06 10 00 / 09 22 13

See [General Notes](#): Supplementary Components

C2020 / 21-03 20 20 / Ss 25 25 45

Interior Fabrications

Includes: Interior fabrications of a variety of materials formed to various profiles for a variety of purposes including column covers.

Associated Masterformat Sections: 03 49 00 / 05 50 00 / 05 58 13 / 05 70 00 / 06 44 00 / 06 60 00 / 06 61 00 / 06 80 00 / 09 27 00

For drywall fabrications see C1010.10

For all others See [Fundamental LOD Definitions](#)

Unifomat / Omniclass / Uniclass

C2030 / 21-03 20 30 / Ss 30 42

Flooring

Includes: Flooring Supplementary Components as appropriate.

Associated Masterformat Sections: 09 60 00 / 01 84 19

See C20

C2030.10 / 21-03 20 30 10 / Ss 30 42

Flooring Treatment

Includes: Coatings and surfacings for finished floor, applied to provide a specific performance characteristic.

Associated Masterformat Sections: 09 61 00 / 09 61 13

See C20

C2030.20 / 21-03 20 30 20 / Ss 30 42 32 40

Tile Flooring

Includes: Manufactured surfacing units of impervious, vitreous, semi-vitreous, and non-vitreous materials; glazed, unglazed, conductive, abrasive, and textured surfaces. Includes wall base units.

Associated Masterformat Sections: 09 30 00

See C20

C2030.30 / 21-03 20 30 30 / Ss 30 42

Specialty Flooring

Includes: Heavy duty and other specialty flooring. Includes asphaltic plank, laminate, bamboo, leather, cork, acoustic, synthetic turf, metal, structural glass, chemical-resistant, acid resistant, conductive, and static control flooring.

Associated Masterformat Sections: 09 62 00 / 09 35 00 / 09 63 13.35 / 09 62 35 / 09 33 00 / 09 65 33 / 09 66 33 / 09 61 36 / 09 65 36

See C20

C2030.40 / 21-03 20 30 40 / Ss 30 42 50

Masonry Flooring

Includes: Fired clay unit masonry, cat stone, and stone flooring. Includes wall base.

Associated Masterformat Sections: 09 63 00 / 09 63 13 / 09 63 40 / 09 63 43

See C20

Unifomat / Omniclass / Uniclass

C2030.45 / 21-03 20 30 45 / Ss 30 20 90

Wood Flooring

Includes: Strip, parquet, block, and composition wood flooring.

Associated Masterformat Sections: 09 64 00

See C20

C2030.50 / 21-03 20 30 50 / Ss 30 42 72 72

Resilient Flooring

Includes: Resilient tile and sheet flooring. Includes integral and applied wall bases.

Associated Masterformat Sections: 09 65 00

See C20

C2030.60 / 21-03 20 30 60 / Ss 30 42 90 90

Terrazzo Flooring

Includes: Cast-in-place, sand-cushion, monolithic, bonded and adhesively-bonded portland cement terrazzo; poured-in-place epoxy, polyester, and resinous matrix terrazzo; and precast terrazzo. Includes integral or precast wall bases, accessories, and finish sealers.

Associated Masterformat Sections: 09 66 00 / 09 66 13 / 09 66 16 / 09 66 23

See C20

C2030.70 / 21-03 20 30 70 / Ss 30 42 54 75

Fluid-Applied Flooring

Includes: Flooring applied in a viscous state.

Associated Masterformat Sections: 09 67 00 / 09 67 13 / 09 67 16 / 09 67 19 / 09 67 23 / 09 67 26

See C20

C2030.75 / 21-03 20 30 75 / Ss 30 42 72

Carpeting

Includes: Floor carpet materials including cushions, accessories, and wall base.

Associated Masterformat Sections: 09 68 00 / 09 68 13 / 09 68 16

See C20

C2030.80 / 21-03 20 30 80 / Ss 30 20 95 15

Athletic Flooring

Includes: Flooring for athletic purposes.

Associated Masterformat Sections: 09 64 66 / 09 65 66 / 09 67 66

See C20

Send feedback to communications@bimforum.org



Copyright © 2023 BIMForum. All rights reserved.
This document is copyrighted under a [Creative Commons Attribution-NonCommercial-NoDerivatives 4.0 International License](https://creativecommons.org/licenses/by-nc-nd/4.0/).

Uniformat / Omniclass / Uniclass

C2030.85 / 21-03 20 30 85 / Ss 30 60 30 26

Entrance Flooring

Includes: Special floor surfaces at entrances.

Associated Masterformat Sections: 12 48 13 / 12 48 16 / 12 48 19 / 12 48 23 / 12 48 26

See C20

C2030.90 / 21-03 20 30 90 / Pr 35 90 31

Floor Supplementary Components

Includes: Furring, underlayment, and sound and vibration control to be included with flooring elements above as appropriate.

Associated Masterformat Sections: 06 10 00 / 06 16 26 / 09 60 13 / 09 62 48

See [General Notes](#): Supplementary Components

C2040 / 21-03 20 40 / Ss 35 40

Stair Finishes

Includes: Stair tread, riser, and landing finish of various materials.

Associated Masterformat Sections: 01 84 19

See C20

C2040.20 / 21-03 20 40 20 / Ss 35 40

Tile Stair Finish

See C20

C2040.40 / 21-03 20 40 40 / Ss 35 40

Masonry Stair Finish

See C20

C2040.45 / 21-03 20 40 45 / Ss 35 40

Wood Stair Finish

See C20

C2040.50 / 21-03 20 40 50 / Ss 35 40

Resilient Stair Finish

See C20

Send feedback to communications@bimforum.org



Copyright © 2023 BIMForum. All rights reserved
This document is copyrighted under a [Creative Commons Attribution-NonCommercial-NoDerivatives 4.0 International License](https://creativecommons.org/licenses/by-nc-nd/4.0/).

Unifomat / Omniclass / Uniclass

C2040.60 / 21-03 20 40 60 / Ss 35 40

Terrazzo Stair Finish

See C20

C2040.75 / 21-03 20 40 75 / Ss 35 40 82

Carpeted Stair Finish

See C20

C2050 / 21-03 20 50 / Ss 30 47

Ceiling Finishes

Includes: Finishes applied to interior ceiling substrates. Ceiling finishes may be applied to suspended ceiling construction. Includes Ceiling Finish Supplementary Components as appropriate.

See C20

C2050.10 / 21-03 20 50 10 / Ss 30 25 10

Plaster and Gypsum Board Finish

See C20

C2050.20 / 21-03 20 50 20 / Ss 30 25 10

Ceiling Paneling

See C20

C2050.70 / 21-03 20 50 70 / Ss 40 90 60

Ceiling Painting and Coating

See C20

C2050.80 / 21-03 20 50 80 / Ss 30 25 22 1

Acoustical Ceiling Treatment

See C20

C2050.90 / 21-03 20 50 90 / Ss 30 47

Ceiling Finish Supplementary Components

See [General Notes](#): Supplementary Components

Send feedback to communications@bimforum.org



Copyright © 2023 BIMForum. All rights reserved
This document is copyrighted under a [Creative Commons Attribution-NonCommercial-NoDerivatives 4.0 International License](https://creativecommons.org/licenses/by-nc-nd/4.0/).

Unifomat / Omniclass / Uniclass

D / 21-04 00 00 / -- SERVICES

Associated Masterformat Sections: 01 86 00

D10 / 21-04 10 / Ss 80 20 Conveying

Associated Masterformat Sections: 01 85 00 / 14 00 00

100	Inclusions: <ul style="list-style-type: none">• Schematic model elements.• indication of entry and exit points	
-----	---	--

D1010 / 21-04 10 10 / Ss 80 50 Vertical Conveying Systems

D1010.10 / 21-04 10 10 10 / Ss 80 50 60 26 Elevators

Includes: Passenger and freight elevators of all types, including cars, enclosures, controls, safety equipment, hoist way equipment, and elevator machinery. Includes associated metal fabrications including pit ladders.

Associated Masterformat Sections: 01 85 00 / 14 20 00 / 14 21 13 / 14 21 23 / 14 21 33 / 14 21 43 / 14 24 13 / 14 24 23 / 14 24 33 / 14 24 43 / 14 26 00 / 14 27 00 / 14 28 00

100	See D10	
-----	---------	---

Send feedback to communications@bimforum.org



Copyright © 2023 BIMForum. All rights reserved.
This document is copyrighted under a [Creative Commons Attribution-NonCommercial-NoDerivatives 4.0 International License](https://creativecommons.org/licenses/by-nc-nd/4.0/).

Uniformat / Omniclass / Uniclass

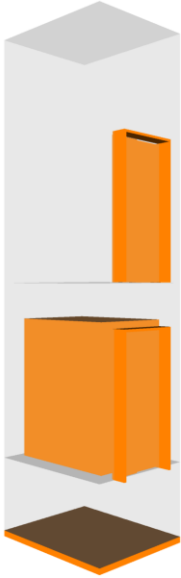
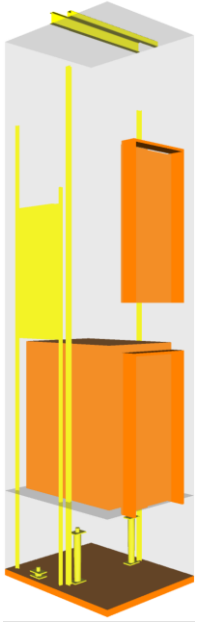
200	<p>Inclusions</p> <ul style="list-style-type: none">• Assumed envelope of shaft• Pit• Location and nominal size of all stops and doors• Specify conveyance type (e.g., hydraulic vs. traction elevator)• Specify what is being conveyed (e.g., people vs. freight)• Location of elevator machine	 <p>1</p>
300	<p>Inclusions</p> <ul style="list-style-type: none">• Pathway envelope of moving parts (e.g., cab, counterweight), including required clearances• system elements(e.g., tracks)• Pits, control rooms, machine rooms, and associated equipment if applicable.• Major structural support elements (e.g., elevator beam).	 <p>1</p>

Send feedback to communications@bimforum.org



Copyright © 2023 BIMForum. All rights reserved
This document is copyrighted under a [Creative Commons Attribution-NonCommercial-NoDerivatives 4.0 International License](https://creativecommons.org/licenses/by-nc-nd/4.0/).

Uniformat / Omniclass / Uniclass

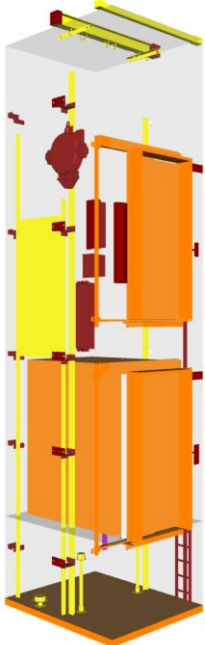
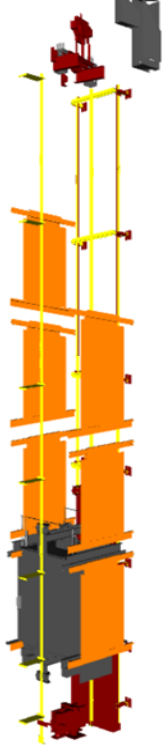
350	<p>Inclusions:</p> <ul style="list-style-type: none">• Connections: mechanical and/or electrical services.• connection points between elevator components and building structure• Sizing adjusted to the actual manufacturer specifications.• Guiding tracks/rails• Service/access zones	 <p>1</p>
400	<p>Inclusions</p> <ul style="list-style-type: none">• All connections, supports, framing, and other supplementary components.	 <p>1</p>

Send feedback to communications@bimforum.org



Uniformat / Omniclass / Uniclass

D1010.20 / 21-04 10 10 20 / Ss 80 50 60

Lifts

Includes: Vertical or inclined lifts and related equipment for a variety of purposes. Sidewalk lifts include doors.

Associated Masterformat Sections: 01 85 00 / 14 40 00 / 14 41 00 / 14 42 00 / 14 43 00
14 43 13 / 14 43 16 / 14 44 00 / 14 45 00

See D1010.10

D1010.30 / 21-04 10 10 30 / Ss 80 20 62 28

Escalators

Includes: Passenger conveying systems composed of moving treads installed in inclined position including associated components, hardware, controls, safety equipment, and related items.

Associated Masterformat Sections: 01 85 00 / 14 31 00

100	See D10	
200	Inclusions: <ul style="list-style-type: none">• Element envelope	
300	Inclusions <ul style="list-style-type: none">• Balustrade• Clear Egress Zones	
350	Inclusions: <ul style="list-style-type: none">• Connections to services (e.g., mechanical, electrical).• connection points between elevator components and building structure• Modeled actual manufacturer dimensions.• Guiding tracks/rails• Service/access zones• Fixing points of truss	

D1010.50 / 21-04 10 10 50 / Ss 80 50 60 50

Dumbwaiters

Includes: Packaged and field assembled, motorized and hand- operated dumbwaiters including associated components for book lifts, cart lifts, and other applications. Systems include associated components, hardware, controls, and safety equipment.

Associated Masterformat Sections: 01 85 00 / 14 10 00

[See D1010.10]

D1010.60 / 21-04 10 10 60 / Ss 80 20 62

Moving Ramps

Includes: Passenger conveying systems composed of moving belts installed in inclined position including associated components, hardware, controls, safety equipment, and related items.

Associated Masterformat Sections: 01 85 00 / 14 33 00

Send feedback to communications@bimforum.org



Copyright © 2023 BIMForum. All rights reserved
This document is copyrighted under a [Creative Commons Attribution-NonCommercial-NoDerivatives 4.0 International License](https://creativecommons.org/licenses/by-nc-nd/4.0/).

Unifomat / Omniclass / Uniclass

D1030 / 21-04 10 30 / Ss 80 20 62 Horizontal Conveying

Associated Masterformat Sections: 01 85 00

100	[See D10]	
200	Inclusions: <ul style="list-style-type: none">• Generic representation of the material handling system envelope, including critical path of travel zones• Specify conveyance type• Specify what is being conveyed	
300	Inclusions: <ul style="list-style-type: none">• Specific system elements modeled by type, including all path of travel zones. Including:• Clear Egress Zones• Structural Clearance zones• Material path clearance zones	
350	Inclusions: <ul style="list-style-type: none">• Service/access zones• Modeled at actual manufacturer dimensions.• Fixing points of truss	

D1030.10 / 21-04 10 30 10 / Ss 80 20 62 53 Moving Walks

Includes: Passenger conveying systems composed of moving belts installed in horizontal position including associated components, hardware, controls, safety equipment, and related items.

Associated Masterformat Sections: 01 85 00 / 14 32 00

[See D1030]

D1030.30 / 21-04 10 30 30 / Ss 80 80 Turntables

Includes: Structural turntables for various applications.

Associated Masterformat Sections: 01 85 00 / 14 70 00 / 14 71 00 / 14 71 11 / 14 72 00
14 72 25 / 14 73 00 / 14 73 59 / 14 74 00 / 14 74 61

[See D1030]

D1030.50 / 21-04 10 30 50 / Ss 80 90 05 60 Passenger Loading Bridges

Includes: Operating bridges for loading and unloading of passengers to and from aircraft and ships.

Associated Masterformat Sections: 01 85 00 / 34 77 13

[see D1030]

Send feedback to communications@bimforum.org



Copyright © 2023 BIMForum. All rights reserved
This document is copyrighted under a [Creative Commons Attribution-NonCommercial-NoDerivatives 4.0 International License](https://creativecommons.org/licenses/by-nc-nd/4.0/).

Uniformat / Omniclass / Uniclass

D1030.70 / 21-04 10 30 70 / Ss 80 20 62

People Movers

Includes: Single rail vehicles suspended from or straddle the guideway. Includes associated track, equipment, controls, and accessories. Includes: Steep cable railways in which ascending cars counterbalance descending cars. Includes associated track, cable. Includes: Steep slope transportation system utilizing moving cable. Includes associated cable, support structures, equipment, controls, and accessories.

Associated Masterformat Sections: 01 85 00 / 34 12 00 / 34 13 00 / 34 14 00

[see D1030]

D1050 / 21-04 10 50 / Ss 80 20 10

Material Handling

Associated Masterformat Sections: 01 85 00

100	See D10	
200	Inclusions: <ul style="list-style-type: none"> • Generic representation of the material handling system envelope, including critical path of travel zones • Specify conveyance type • Specify what is being conveyed 	
300	Inclusions: <ul style="list-style-type: none"> • Specific system elements modeled by type, including all path of travel zones. Including: <ul style="list-style-type: none"> • Clear Egress Zones • Structural Clearance zones • Material path clearance zones 	
350	Inclusions: <ul style="list-style-type: none"> • Sizing adjusted to the actual manufacturer specifications. • Fixing points of truss • Service/access zones 	
400	Inclusions: <ul style="list-style-type: none"> • All connections, supports, framing, and other supplementary components. 	

D1050.10 / 21-04 10 50 10 / Ss 80 30 15

Cranes

Includes: Hoisting towers, cranes, crane rails, and related accessories.

Associated Masterformat Sections: 41 22 13

100	See D10	
200	Inclusions: <ul style="list-style-type: none"> • Envelope of zone of operation 	
300	Inclusions: <ul style="list-style-type: none"> • Specific system elements • Structural support elements. • Guiding tracks and rails 	

Send feedback to communications@bimforum.org



Copyright © 2023 BIMForum. All rights reserved
This document is copyrighted under a [Creative Commons Attribution-NonCommercial-NoDerivatives 4.0 International License](https://creativecommons.org/licenses/by-nc-nd/4.0/).

Uniformat / Omniclass / Uniclass

350	Inclusions: <ul style="list-style-type: none">• Sizing adjusted to the actual manufacturer dimensions.• Service and access zones• Connections to mechanical or electrical services	
-----	---	--

D1050.20 / 21-04 10 50 20 / Ss 80 30 40

Hoists

Includes: Manual and motor operated hoists and related accessories.

Associated Masterformat Sections: 41 22 23

[See D1050.10]

D1050.30 / 21-04 10 50 30 / Ss 80 30 20

Derricks

Includes: Manual and motor operated derricks and related accessories.

Associated Masterformat Sections: 41 22 33

[See D1050.10]

D1050.40 / 21-04 10 50 40 / Ss 80 20

Conveyors

Includes: Automatic guided vehicles, conveyors, diverters, and chutes. Includes controls and accessories.

Associated Masterformat Sections: 41 21 00

[See D1050.10]

D1050.50 / 21-04 10 50 50 / Ss 80 20 06

Baggage Handling Equipment

Includes: Operating equipment for handling, scanning, and weighing of baggage at terminals. Includes controls and accessories.

Associated Masterformat Sections: 34 77 16

[see D5010.10]

D1050.60 / 21-04 10 50 60 / Ss 37 14

Chutes

Includes: Chutes which support the operation of the building or structure.

Associated Masterformat Sections: 14 91 00 / 14 91 13 / 14 91 23 / 14 91 33 / 14 91 82

[see D5010.10]

Uniformat / Omniclass / Uniclass

D1050.70 / 21-04 10 50 70 / Ss 80 20 65

Pneumatic Tube Systems

Includes: Pneumatically operated tube system for the delivery of small items within a facility. Includes controls and accessories.

Associated Masterformat Sections: 14 92 00

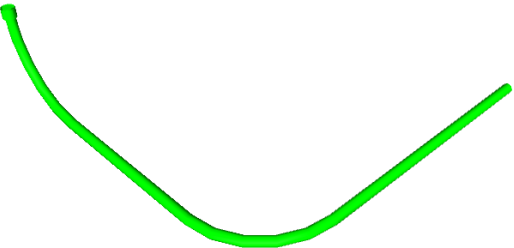
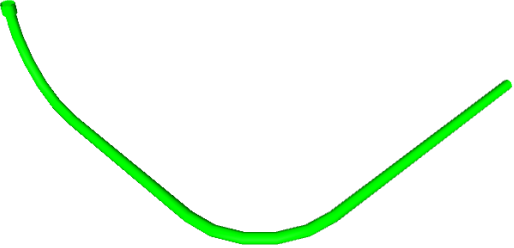
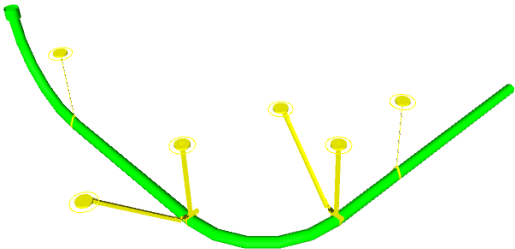
100	<p>Inclusions:</p> <ul style="list-style-type: none"> • Diagrammatic elements or quantitative call outs; • Conceptual and/or schematic flow diagrams; 	
200	<p>Inclusions:</p> <ul style="list-style-type: none"> • Generic elements; • layout with approximate size, shape, and location of equipment and tubing; 	
300	<p>Inclusions:</p> <ul style="list-style-type: none"> • design-specified elements; • Specified size, shape, spacing, and location of equipment and tubing; 	
350	<p>Inclusions:</p> <ul style="list-style-type: none"> • actual size, shape, spacing, and location/connections of equipment and tubing; • actual size, shape, spacing, and clearances of all hangers, supports, vibration and seismic control • floor and wall penetrations. • Service/access zones. 	

Send feedback to communications@bimforum.org



Copyright © 2023 BIMForum. All rights reserved.
This document is copyrighted under a [Creative Commons Attribution-NonCommercial-NoDerivatives 4.0 International License](https://creativecommons.org/licenses/by-nc-nd/4.0/).

Uniformat / Omniclass / Uniclass

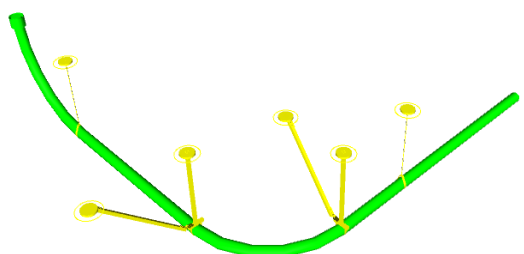
400	<p>Inclusions:</p> <ul style="list-style-type: none">• Supplementary components added to the model required for fabrication and field installation	 A diagram showing a thick, curved green line representing a structure. Several yellow circles are connected to the green line by thin yellow lines, indicating specific points of interest or components. The green line starts high on the left, curves down to a minimum, and then curves back up to the right.
-----	--	--

D1080 / 21-04 10 80 / Ss 80 30 25 Operable Access Systems

Associated Masterformat Sections:

See [Fundamental LOD Definitions](#)

D1080.10 / 21-04 10 80 10 / Ss 80 30 25 0 Suspended Scaffolding

Includes: Suspended scaffolding when part of the completed project.

Associated Masterformat Sections: 14 81 00

See [Fundamental LOD Definitions](#)

D1080.20 / 21-04 10 80 20 / Ss 80 30 25 Rope Climbers

Includes: Powered rope climbers to access exterior façade.

Associated Masterformat Sections: 14 82 00

See [Fundamental LOD Definitions](#)

D1080.30 / 21-04 10 80 30 / Ss 80 30 25 0 Elevating Platforms

Includes: Fixed elevating platforms to provide a movable elevated working platform for people and materials.

Associated Masterformat Sections: 14 83 00

See [Fundamental LOD Definitions](#)

Send feedback to communications@bimforum.org



Copyright © 2023 BIMForum. All rights reserved.
This document is copyrighted under a [Creative Commons Attribution-NonCommercial-NoDerivatives 4.0 International License](#).

Unifomat / Omniclass / Uniclass

D1080.40 / 21-04 10 80 40 / Ss 80 30 25

Powered Scaffolding

Includes: Powered scaffolding when part of the completed project.

Associated Masterformat Sections: 14 84 00 / 14 84 13

See [Fundamental LOD Definitions](#)

D1080.50 / 21-04 10 80 50 / Ss 80 30 25

Building Envelope Access

Associated Masterformat Sections: 11 24 23

See [Fundamental LOD Definitions](#)

D20 / 21-04 20 / --

Plumbing

Associated Masterformat Sections: 01 86 16 / 22 00 00

100	Inclusions: <ul style="list-style-type: none">• Diagrammatic or schematic elements;	
-----	---	--

D2010 / 21-04 20 10 / Ss 55 70 38

Domestic Water Distribution

Includes: Facility domestic water distribution system. Include Domestic Water Distribution Supplementary Components as appropriate.

Associated Masterformat Sections: 01 86 16 / 22 11 00

100	See D20	
200	Inclusions: <ul style="list-style-type: none">• Schematic layout of generic model elements with approximate size, shape, and location of elements;	

Unifomat / Omniclass / Uniclass

D2010.10 / 21-04 20 10 10 / Ss 55 15 65

Facility Potable-Water Storage Tanks

Includes: Tanks for storage of potable water serving a facility and located within, on, under, or closely associated with a structure.

Associated Masterformat Sections: 22 12 00

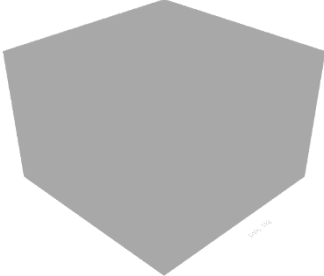
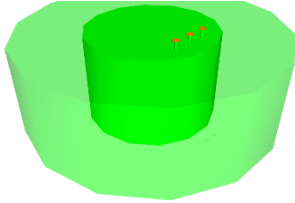
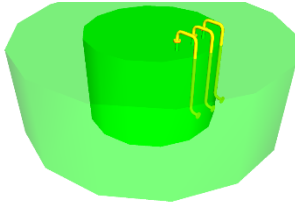
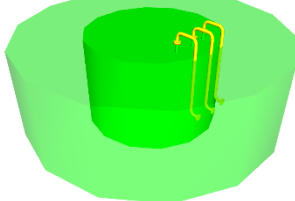
100	See D20	
200	<p>Inclusions:</p> <ul style="list-style-type: none"> • layout with approximate size, shape, and location 	
300	<p>Inclusions:</p> <ul style="list-style-type: none"> • Design-specified size, shape, spacing, and location • Access/code clearance requirements • Approximate allowances for clearances required for all specified anchors, supports, vibration and seismic control that are utilized in the layout of tanks(s) are modeled or accommodated by model checking software; 	
350	<p>Inclusions:</p> <ul style="list-style-type: none"> • Actual construction elements size and shape, spacing, and location/connections of tank(s) • Actual size and shape, spacing, and clearances required for all specified anchors, supports, vibration and seismic control that are utilized in the layout of tanks(s) are modeled or accommodated by model checking software. 	
400	<p>Inclusions:</p> <ul style="list-style-type: none"> • Supplementary components required for fabrication and field installation. 	

Send feedback to communications@bimforum.org



Copyright © 2023 BIMForum. All rights reserved.
This document is copyrighted under a [Creative Commons Attribution-NonCommercial-NoDerivatives 4.0 International License](https://creativecommons.org/licenses/by-nc-nd/4.0/).



Unifomat / Omniclass / Uniclass

D2010.20 / 21-04 20 10 20 / Ss 55 70 38

Domestic Water Equipment

Includes: Equipment for domestic water distribution system. Includes: Equipment for the softening of domestic water. Includes: Equipment for the filtering of domestic water. Includes: Equipment to heat domestic water. Includes electric and fuel-fired equipment. Includes: Equipment to heat domestic water by means of heat exchange.

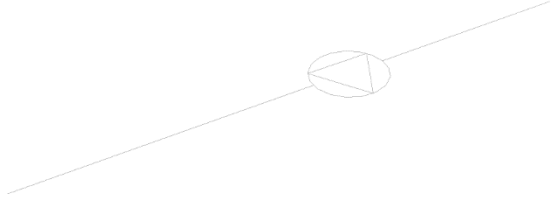
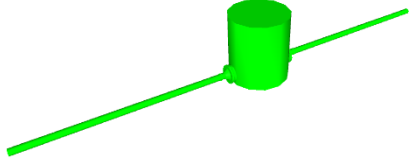
Associated Masterformat Sections: 22 11 23 / 22 31 00 / 22 32 00 / 22 33 00 / 22 34 00 / 22 35 00

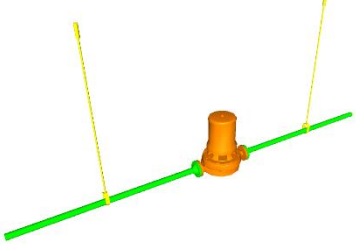
100	See D20	
200	<p>Inclusions:</p> <ul style="list-style-type: none"> Schematic layout with approximate size, shape, and location 	
300	<p>Inclusions:</p> <ul style="list-style-type: none"> Design-specified size, shape, spacing, and location of equipment; Approximate allowances for clearances required for all specified anchors, supports, vibration and seismic control that are utilized in the layout of equipment; Access/code clearance requirements modeled. 	
350	<p>Inclusions:</p> <ul style="list-style-type: none"> Actual construction elements size, shape, spacing, and location/connections Actual size, shape, spacing, and clearances required for all specified anchors, supports, vibration and seismic control that are utilized in the layout of equipment. Actual access/code clearance requirements modeled. 	

Send feedback to communications@bimforum.org



Copyright © 2023 BIMForum. All rights reserved
This document is copyrighted under a [Creative Commons Attribution-NonCommercial-NoDerivatives 4.0 International License](https://creativecommons.org/licenses/by-nc-nd/4.0/).

Unifomat / Omniclass / Uniclass

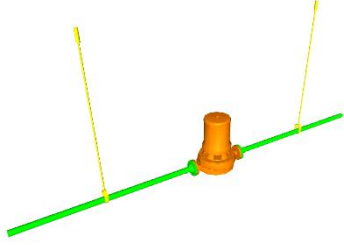
400	See D2010.10	
-----	--------------	---

D2010.40 / 21-04 20 10 40 / Ss 55 70 38 Domestic Water Piping

Includes: Piping, valves, and specialties associated with domestic water distribution located within, under, or closely associated with a structure. Includes circulating pumps. May Include: Water service from the structure to the utility water service line.

Associated Masterformat Sections: 22 11 16 / 22 11 19

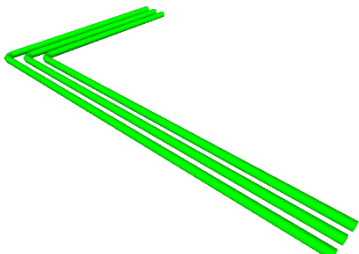
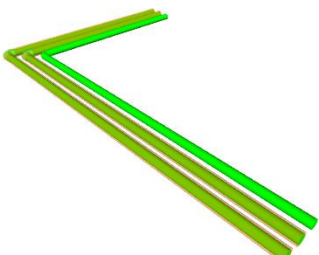
100	<p>Inclusions:</p> <ul style="list-style-type: none"> • Diagrammatic or schematic elements; • Conceptual and/or schematic flow diagrams; 	
200	<p>Inclusions:</p> <ul style="list-style-type: none"> • Schematic layout with approximate size, shape, and location of mains and risers; 	
300	<p>Inclusions:</p> <ul style="list-style-type: none"> • Design-specified size, shape, spacing, and location of pipe, valves, fittings, and insulation for risers, mains, and branches; • Approximate allowances for clearances required for all specified hangers, supports, vibration and seismic control that are to be utilized in the layout of all risers, mains, and branches; • Access/code clearance requirements modeled. 	

Send feedback to communications@bimforum.org



Copyright © 2023 BIMForum. All rights reserved
This document is copyrighted under a [Creative Commons Attribution-NonCommercial-NoDerivatives 4.0 International License](https://creativecommons.org/licenses/by-nc-nd/4.0/).

Unifomat / Omniclass / Uniclass

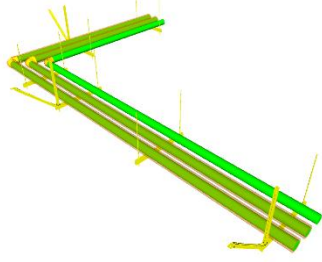
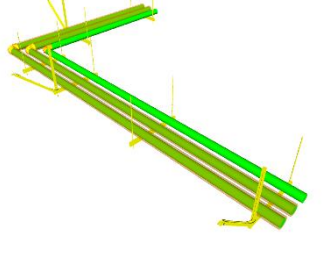
350	<p>Inclusions:</p> <ul style="list-style-type: none"> • Actual construction elements; • Actual size, shape, spacing, and location/connections of pipe, valves, fittings, and insulation for risers, mains, and branches; • Actual size, shape, spacing, and clearances required for all hangers, supports, vibration and seismic control that are utilized in the layout of all risers, mains, and branches; • Actual floor and wall penetration elements. • Actual access/code clearance requirements modeled. 	
400	See D2010.10	

D2010.60 / 21-04 20 10 60 / Ss 40 15 75

Plumbing Fixtures

Includes: Terminal devices on the domestic water plumbing system. Includes rough-in piping, trim, fittings, and connection to vent piping.

Associated Masterformat Sections: 22 40 00 / 22 41 00 / 22 41 13 / 22 41 16 / 22 41 19 / 22 41 23 / 22 41 26 / 22 41 36 / 22 41 39 / 22 42 00 / 22 42 13 / 22 42 16 / 22 42 19 / 22 42 23 / 22 42 26 / 22 42 29 / 22 42 33 / 22 42 36 / 22 42 39 / 22 42 43 / 22 43 00 / 22 43 13 / 22 43 16 / 22 43 19 / 22 43 23 / 22 43 39 / 22 43 43 / 22 45 00 / 22 45 13 / 22 45 16 / 22 45 26 / 22 45 29 / 22 45 33 / 22 45 36 / 22 46 00 / 22 46 13 / 22 46 16 / 22 46 39 / 22 46 43 / 22 46 53 / 22 47 00 / 22 47 13 / 22 47 23

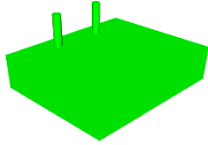
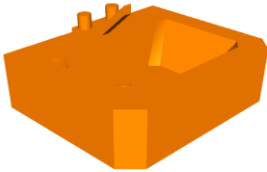

100	See D20	
200	<p>Inclusions:</p> <ul style="list-style-type: none"> • Schematic layout with approximate size, shape, and location; • Carrier and wall width requirements; 	
300	<p>Inclusions:</p> <ul style="list-style-type: none"> • Modeled as design-specified size, shape, spacing, and location; • Approximate allowances for clearances required for all specified supports that are to be utilized in the layout of all fixtures; • Access/code clearance requirements modeled. 	

Send feedback to communications@bimforum.org



Copyright © 2023 BIMForum. All rights reserved.
This document is copyrighted under a [Creative Commons Attribution-NonCommercial-NoDerivatives 4.0 International License](https://creativecommons.org/licenses/by-nc-nd/4.0/).

Unifomat / Omniclass / Uniclass

350	<p>Inclusions:</p> <ul style="list-style-type: none"> Modeled as actual construction elements size, shape, spacing, and location/connections of fixtures/carriers; Actual size, shape, spacing, and clearances required for all supports that are utilized in the layout of all fixtures. Actual access/code clearance requirements modeled. 	
400	See D2010.10	

D2010.90 / 21-04 20 10 90 / Ss 55 70

Domestic Water Distribution Supplementary Components

Includes: Common work results for plumbing, plumbing insulation, and instrumentation. Includes: expansion fittings, meters, gages, valves, hangers, supports, heat tracing, vibration and seismic controls.

Associated Masterformat Sections: 05 45 13 / 22 05 00 / 22 05 16 / 22 05 19 / 22 05 23
22 05 29 / 22 05 33 / 22 05 48 / 22 05 53 / 22 07 00 / 22 09 00

See [General Notes](#): Supplementary Components

D2020 / 21-04 20 20 / Ss 50 30 4

Sanitary Drainage

Includes: Facility sanitary sewerage system located within, under, or closely associated with a structure. Include Sanitary Drainage Supplementary Components as appropriate.

Associated Masterformat Sections: 01 86 16 / 22 13 00

100	See D20	
200	See D2010	





Unifomat / Omniclass / Uniclass

D2020.10 / 21-04 20 20 10 / Ss 50 30 04

Sanitary Sewerage Equipment

Includes: Interceptor, separator, pumps, and septic tanks that are part of facility sanitary sewerage system.

Associated Masterformat Sections: 22 13 23 / 22 13 26 / 22 13 29 / 22 13 33 / 22 13 36
22 13 43 / 22 13 53

100	See D20	
200	<p>Inclusions:</p> <ul style="list-style-type: none"> Schematic layout with approximate size, shape, and location. 	
300	<p>Inclusions:</p> <ul style="list-style-type: none"> design specified size, shape, spacing, and location of equipment. Approximate allowances for clearances required for all specified anchors, supports, vibration and seismic control that are utilized in the layout of equipment are modeled. Access/code clearance requirements modeled. 	
350	<p>Inclusions:</p> <ul style="list-style-type: none"> Actual size, shape, spacing, and clearances required for all specified anchors, supports, vibration and seismic control that are utilized in the layout of equipment. Actual access/code clearance requirements modeled. 	
400	<p>Inclusions:</p> <ul style="list-style-type: none"> Supplementary components added to the model required for fabrication and field installation 	

Unifomat / Omniclass / Uniclass

D2020.30 / 21-04 20 20 30 / Ss 50 30 04

Sanitary Sewerage Piping

Includes: Sanitary waste and vent piping system within and under structures. May Include: Sanitary piping from the structure to the utility sanitary sewer.

Associated Masterformat Sections: 22 13 13 / 22 13 16 / 22 13 19 / 22 05 73 / 22 05 76

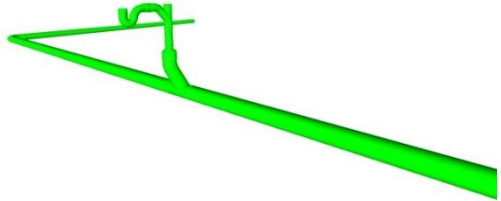
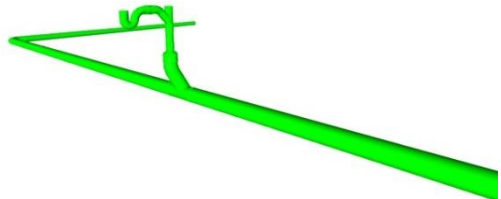
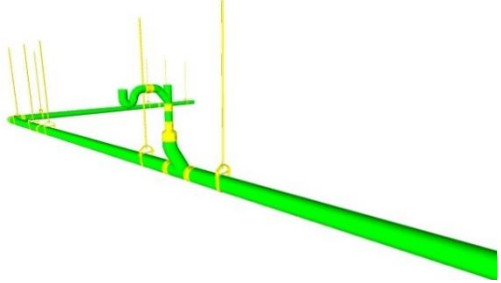
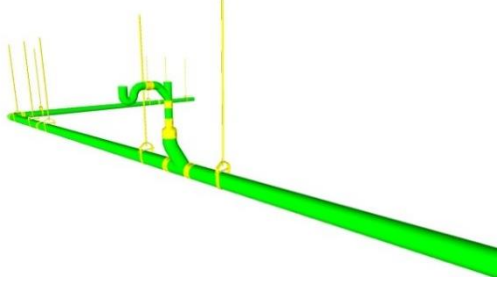
100	See D20	
200	<p>Inclusions:</p> <ul style="list-style-type: none"> Schematic layout with approximate size, shape, and location of mains and risers. 	
300	<p>Inclusions:</p> <ul style="list-style-type: none"> design-specified size, shape, spacing, location, and slope of pipe, valves, fittings, and insulation for risers, mains, and branches. Approximate allowances for clearances required for all specified hangers, supports, vibration and seismic control that are to be utilized in the layout of all risers, mains, and branches. Access/code clearance requirements modeled 	
350	<p>Inclusions:</p> <ul style="list-style-type: none"> Actual construction elements. Actual size, shape, spacing, location, connections, and slope of pipe, valves, fittings, and insulation for risers, mains, and branches. Actual size, shape, spacing, and clearances required for all hangers, supports, vibration and seismic control that are utilized in the layout of all risers, mains, and branches. Actual floor and wall penetration elements. Actual access/code clearance requirements modeled 	
400	See D2020.10	

Send feedback to communications@bimforum.org



Copyright © 2023 BIMForum. All rights reserved
This document is copyrighted under a [Creative Commons Attribution-NonCommercial-NoDerivatives 4.0 International License](https://creativecommons.org/licenses/by-nc-nd/4.0/).

Unifomat / Omniclass / Uniclass

D2020.90 / 21-04 20 20 90 / Ss 50 30 04

Sanitary Drainage Supplementary Components

Includes: Common work results for plumbing, plumbing insulation, and instrumentation and control for plumbing to be included with sanitary drainage elements above as appropriate. Includes expansion fittings, meters, gages, valves, hangers, supports, heat tracing, vibration and seismic controls.

Associated Masterformat Sections: 05 45 13 / 22 05 00 / 22 05 16 / 22 05 19 / 22 05 23
22 05 29 / 22 05 33 / 22 05 48 / 22 05 53 / 22 07 00 / 22 09 00

See [General Notes](#): Supplementary Components

D2030 / 21-04 20 30 / --

Building Support Plumbing Systems

Includes: Facility storm water drainage and gray water systems. Include Building Support Plumbing System Supplementary Components as appropriate.

Associated Masterformat Sections: 01 86 16 / 22 14 00



100	See D20	
200	See D2010	

D2030.10 / 21-04 20 30 10 / Ss 50 35 80



Stormwater Drainage Equipment

Includes: Drainage pumps, and sump pumps that are part of stormwater drainage system.

Associated Masterformat Sections: 22 14 29 / 22 14 33 / 22 14 36 / 22 14 53

100	Inclusions: <ul style="list-style-type: none"> • Diagrammatic or schematic model elements. • Conceptual and/or schematic layout; 	
200	Inclusions: <ul style="list-style-type: none"> • Schematic layout with approximate size, shape, and location of equipment. • Approximate access/code clearance requirements. 	
300	Inclusions: <ul style="list-style-type: none"> • design-specified size, shape, spacing, and location. • Approximate allowances for clearances required for all specified anchors, supports, vibration and seismic control that are utilized in the layout of equipment. • Access/code clearance requirements modeled. 	

Unifomat / Omniclass / Uniclass

350	<p>Inclusions:</p> <ul style="list-style-type: none"> • actual construction elements size, shape, spacing, and location/connections of equipment, • Actual size, shape, spacing, and clearances required for all specified anchors, supports, vibration and seismic control that are utilized in the layout of equipment. • Actual access/code clearance requirements modeled. 	
400	<p>Inclusions:</p> <ul style="list-style-type: none"> • Supplementary components added to the model required for fabrication and field installation. 	

D2030.20 / 21-04 20 30 20 / Ss 50 35 80 Stormwater Drainage Piping

Includes: Storm drainage piping system within, under, or closely associated with a structure. Includes storm drains for areas closely associated with a structure such as courtyards, plazas, and loading dock areas. May Include: Storm drainage piping from the structure to the utility storm drain.

Associated Masterformat Sections: 22 05 73 / 22 05 76 / 22 14 13 / 22 14 16 / 22 14 23

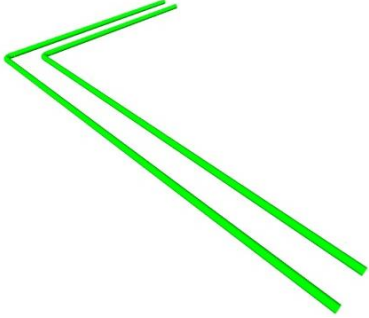
100	See D20	
200	<p>Inclusions:</p> <ul style="list-style-type: none"> • Schematic layout with approximate size, shape, and location of mains and risers. 	

Unifomat / Omniclass / Uniclass

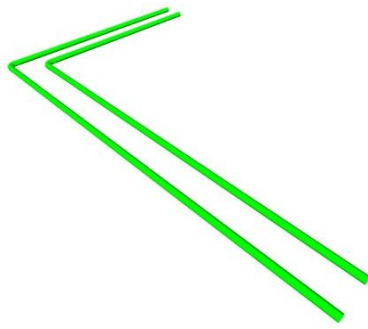
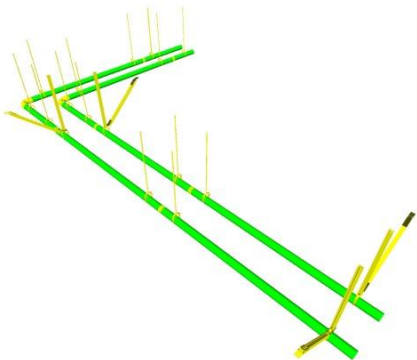
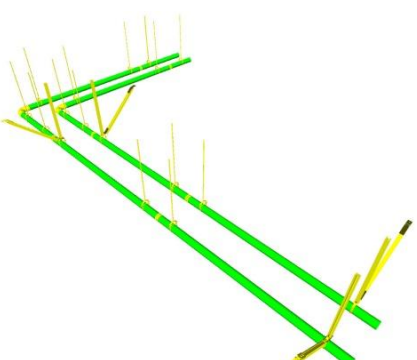
300	<p>Inclusions:</p> <ul style="list-style-type: none">• design-specified size, shape, spacing, location, and slope of pipe, valves, fittings, and insulation for risers, mains, and branches.• Approximate allowances for clearances required for all specified hangers, supports, vibration and seismic control that are to be utilized in the layout of all risers, mains, and branches.• Access/code clearance requirements modeled.	
350	<p>Inclusions:</p> <ul style="list-style-type: none">• actual size, shape, spacing, location, connections, and slope of pipe, valves, fittings, and insulation for risers, mains, and branches.• Actual size and shape, spacing, and clearances required for all hangers, supports, vibration and seismic control that are utilized in the layout of all risers, mains, and branches.• Actual access/code clearance requirements modeled.• Actual floor and wall penetration elements.	
400	See D2030.10	

Unifomat / Omniclass / Uniclass

D2030.30 / 21-04 20 30 30 / Ss 50 35 80

Facility Stormwater Drains

Includes: Various types of drains to collect storm water.

Associated Masterformat Sections: 22 14 26

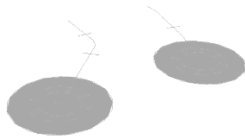
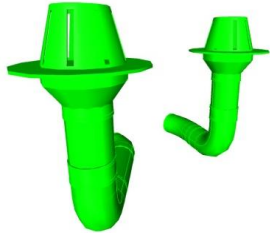
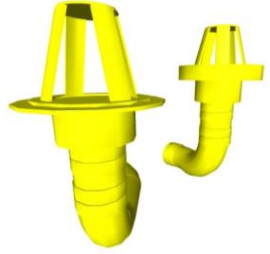
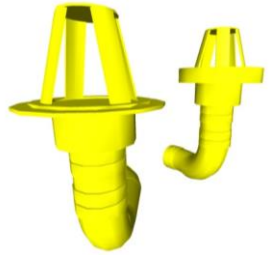
100	See D20	
200	<p>Inclusions:</p> <ul style="list-style-type: none"> Schematic layout with approximate size, shape, and location. 	
300	<p>Inclusions:</p> <ul style="list-style-type: none"> design-specified size, shape, spacing, and location of components. Approximate allowances for clearances required for all specified hangers, supports, vibration and seismic control that are to be utilized in the layout of all components. Access/code clearance requirements modeled. 	
350	<p>Inclusions:</p> <ul style="list-style-type: none"> actual construction elements size, shape, spacing, and location/connections of components. Actual size, shape, spacing, and clearances required for all hangers, supports, vibration and seismic control that are utilized in the layout of all components. Actual access/code clearance requirements modeled. 	
400	See D2030.10	

Send feedback to communications@bimforum.org



Copyright © 2023 BIMForum. All rights reserved
This document is copyrighted under a [Creative Commons Attribution-NonCommercial-NoDerivatives 4.0 International License](https://creativecommons.org/licenses/by-nc-nd/4.0/).

Uniformat / Omniclass / Uniclass

D2030.60 / 21-04 20 30 60 / Ss 55 70 97 35

Gray Water Systems

Includes: Systems to collect, treat, and distribute gray water for other uses such as irrigation.

Associated Masterformat Sections: 22 13 63

[See D2030.20]

D2030.90 / 21-04 20 30 90 / --

Building Support Plumbing System Supplementary Components

Includes: Common work results for plumbing, plumbing insulation, and instrumentation and control for plumbing to be included with building support plumbing system elements above as appropriate. Includes expansion fittings, meters, gages, valves, hangers, supports, heat tracing, vibration and seismic controls.

Associated Masterformat Sections: 05 45 13 / 22 05 00 / 22 05 16 / 22 05 19 / 22 05 23
22 05 29 / 22 05 33 / 22 05 48 / 22 05 53 / 22 07 00 / 22 09 00

See [General Notes](#): Supplementary Components

D2050 / 21-04 20 50 / Ss 55 20 15

General Service Compressed-Air

Includes: Compressed air system serving general service requirements

Associated Masterformat Sections: 01 86 16 / 22 15 00 / 22 15 13 / 22 15 16 / 22 15 19

[See D2060.10 – Compressed-Air Systems]

D2060 / 21-04 20 60 / Ss 55 60

Process Support Plumbing Systems

Includes: Process Support Plumbing System Supplementary Components as appropriate.

Associated Masterformat Sections:

100	See D20	
200	Inclusions: <ul style="list-style-type: none">Schematic layout with approximate size, shape, and location of mains and risers.	

D2060.10 / 21-04 20 60 10 / Ss 55 20 15

Compressed-Air Systems

Associated Masterformat Sections: 01 86 16 / 22 61 00 / 22 61 13 / 22 61 19

100	See D20	
-----	---------	--

Uniformat / Omniclass / Uniclass

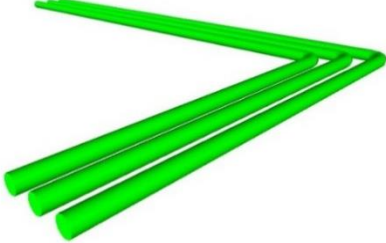
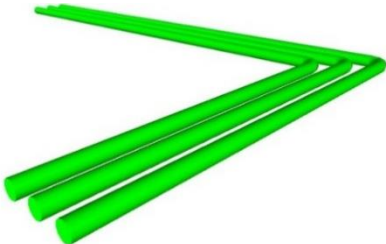
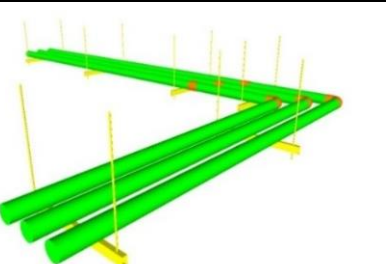
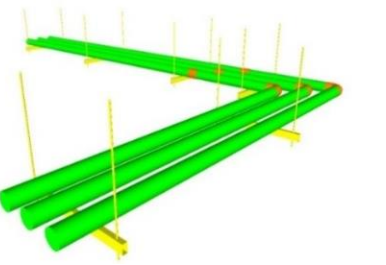
200	See D2060	
300	<p>Inclusions:</p> <ul style="list-style-type: none"> • design-specified size, shape, spacing, location, and slope of equipment/pipe, valves, fittings, and insulation for risers, mains, and branches. • Approximate allowances for clearances required for all specified hangers, supports, vibration and seismic control that are to be utilized in the layout of all risers, mains, and branches. • Access/code clearance requirements modeled. 	
350	<p>Inclusions:</p> <ul style="list-style-type: none"> • actual size, shape, spacing, location, connections, and slope of equipment/pipe, valves, fittings, and insulation for risers, mains, and branches. • Actual size, shape, spacing, and clearances required for all hangers, supports, vibration and seismic control that are utilized in the layout of all risers, mains, and branches. • Actual access/code clearance requirements modeled. • Actual floor and wall penetration elements. 	
400	<p>Inclusions:</p> <ul style="list-style-type: none"> • Supplementary components added to the model required for fabrication and field installation. 	

D2060.20 / 21-04 20 60 20 / Ss 55 20 94

Vacuum Systems

Includes: Vacuum systems for laboratory and healthcare purposes.

Associated Masterformat Sections: 01 86 16 / 22 62 00 / 22 62 13 / 22 62 19 / 22 62 23

[See D2060.10]

Unifomat / Omniclass / Uniclass

D2060.30 / 21-04 20 60 30 / Ss 55 20 34

Gas Systems

Includes: Gas systems for laboratory and healthcare purposes.

Associated Masterformat Sections: 01 86 16 / 22 63 00 / 22 63 13 / 22 63 19

[See D2060.10]

D2060.40 / 21-04 20 60 40 / Ss 50 20

Chemical-Waste Systems

Includes: Chemical-waste systems for laboratory and healthcare purposes.

Associated Masterformat Sections: 01 86 16 / 22 66 00 / 22 66 53 / 22 66 70 / 22 66 83

[See D2060.10]

D2060.50 / 21-04 20 60 50 / Ss 55 70

Processed Water Systems

Includes: Processed water systems for laboratory and healthcare purposes.

Associated Masterformat Sections: 01 86 16 / 22 67 00 / 22 67 13 / 22 67 19

[See D2060.10]

D2060.90 / 21-04 20 60 90 / Ss 55 60

Process Support Plumbing System Supplementary Components

Includes expansion fittings, meters, gages, valves, hangers, supports, heat tracing, vibration and seismic controls. Includes: Common work results for plumbing, plumbing insulation, and instrumentation and controls to be included with process support plumbing systems elements above as appropriate.

Associated Masterformat Sections: 05 45 13 / 05 45 23 / 22 05 00 / 22 05 23 / 22 05 29 / 22 05 33 / 22 05 48 / 22 05 53 / 22 07 00 / 22 09 00

See [General Notes](#): Supplementary Components

D30 / 21-04 30 / Ss 60

Heating, Ventilation, and Air Conditioning (HVAC)

Associated Masterformat Sections: 01 86 19 / 23 00 00

100	Inclusions: <ul style="list-style-type: none">• Diagrammatic or schematic model elements.• conceptual and/or schematic layout/flow diagram;	
-----	--	--

Unifomat / Omniclass / Uniclass

D3010 / 21-04 30 10 / Ss 55 50 Facility Fuel Systems

Includes: Fuel-oil, gasoline, natural-gas, and liquefied-petroleum fuel systems associated with a structure.

Associated Masterformat Sections: 01 86 19 / 23 10 00

100	See D30	
200	<p>Inclusions:</p> <ul style="list-style-type: none"> Schematic layout with approximate size, shape, and location of element(s); Approximate access/code clearance requirements modeled. 	

D3010.10 / 21-04 30 10 10 / Ss 55 50 46 Fuel Piping

Includes: Fuel piping, valves, piping specialties, and other components within, under, or closely associated with a structure.

Associated Masterformat Sections: 23 11 00

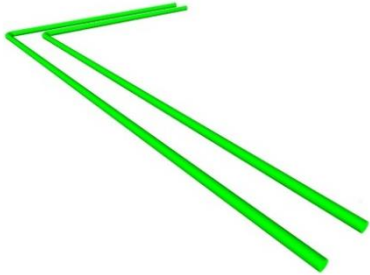
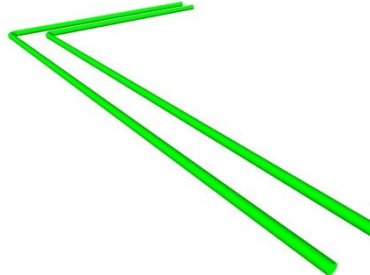
100	See D30	
200	See D3010	
300	<p>Inclusions:</p> <ul style="list-style-type: none"> design-specified size, shape, spacing, and location of pipe, valves, fittings, and insulation for risers, mains, and branches. Approximate allowances for clearances required for all specified hangers, supports, vibration and seismic control that are to be utilized in the layout of all risers, mains, and branches. Access/code clearance requirements modeled. 	

Unifomat / Omniclass / Uniclass

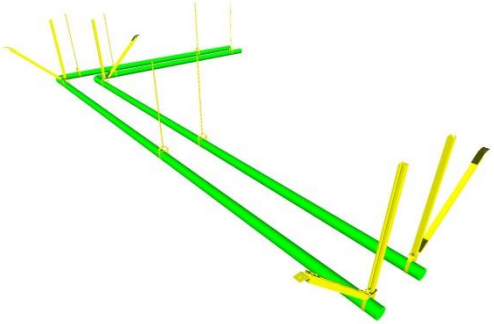
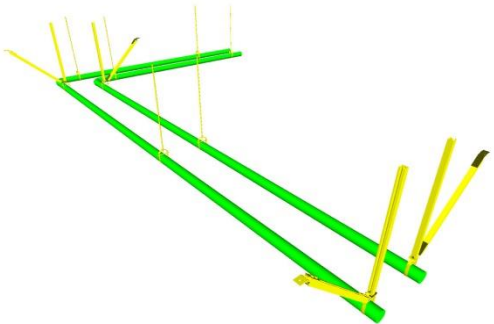
350	<p>Inclusions:</p> <ul style="list-style-type: none"> • actual size, shape, spacing, and location/connections of pipe, valves, fittings, and insulation for risers, mains, and branches. • Actual size, shape, spacing, and clearances required for all hangers, supports, vibration and seismic control that are utilized in the layout of all risers, mains, and branches. • Actual access/code clearance requirements. • Actual floor and wall penetration elements modeled. 	
400	<p>Inclusions:</p> <ul style="list-style-type: none"> • Supplementary components added to the model required for fabrication and field installation 	

D3010.30 / 21-04 30 10 30 / Ss 55 50 Fuel Pumps

Includes: Fuel pumps within or closely associated with a structure.

Associated Masterformat Sections: 23 12 00 / 23 12 13 / 23 12 16

100	See D30	
200	See D3010	
300	<p>Inclusions:</p> <ul style="list-style-type: none"> • design-specified size, shape, spacing, and location of equipment. • Approximate allowances for clearances required for all specified anchors, supports, vibration and seismic control that are utilized in the layout of equipment. • Access/code clearance requirements modeled. 	
350	<p>Inclusions:</p> <ul style="list-style-type: none"> • Modeled as actual size, shape, spacing, and location/connections of equipment. • Actual size, shape, spacing, and clearances required for all specified anchors, supports, vibration and seismic control that are utilized in the layout of equipment. • Actual access/code clearance requirements modeled. 	

Send feedback to communications@bimforum.org



Copyright © 2023 BIMForum. All rights reserved.
This document is copyrighted under a [Creative Commons Attribution-NonCommercial-NoDerivatives 4.0 International License](https://creativecommons.org/licenses/by-nc-nd/4.0/).

Uniformat / Omniclass / Uniclass

400	See D3010.10	
-----	--------------	--

D3010.50 / 21-04 30 10 50 / Ss 55 10 75 0 Fuel Storage Tanks

Includes: Fuel tanks under or closely associated with a structure.

Associated Masterformat Sections: 23 13 00

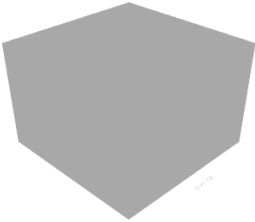
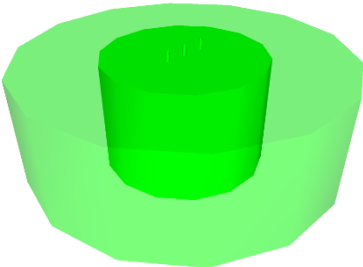
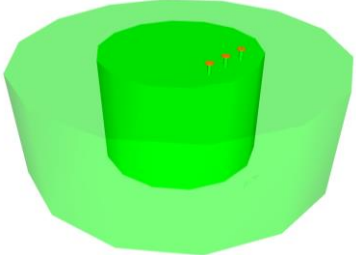
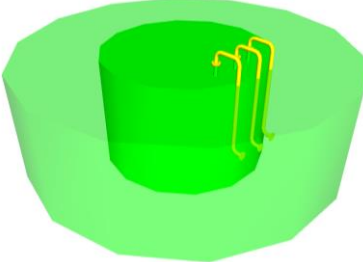
100	See D30	
200	See D3010	
300	Inclusions: <ul style="list-style-type: none"> design-specified size, shape, spacing, and location of tank(s). approximate allowances for spacing and clearances required for all specified anchors, supports, vibration and seismic control that are utilized in the layout. access/code clearance requirements modeled. 	
350	Inclusions: <ul style="list-style-type: none"> actual size, shape, spacing, and location/connections of tank(s). actual size, shape, spacing, and clearances required for all specified anchors, supports, vibration and seismic control that are utilized in the layout actual access/code clearance requirements modeled. 	

Send feedback to communications@bimforum.org



Copyright © 2023 BIMForum. All rights reserved.
This document is copyrighted under a [Creative Commons Attribution-NonCommercial-NoDerivatives 4.0 International License](https://creativecommons.org/licenses/by-nc-nd/4.0/).

Unifomat / Omniclass / Uniclass

400	See D3010.10	
-----	--------------	---

D3020 / 21-04 30 20 / Ss 60 40 37 Heating Systems

Includes: Associated ductwork, piping, valves, and specialties. Includes: Heating System Supplementary Components as appropriate.
Associated Masterformat Sections: 01 86 19

100	See D30	
200	<p>Inclusions:</p> <ul style="list-style-type: none"> Schematic layout with approximate size, shape, and location of element(s). 	

D3020.10 / 21-04 30 20 10 / Ss 60 40 37 Heat Generation

Includes: Boilers, furnaces, solar, geothermal, and biomass heat generation, fuel fired heaters, and heat exchangers. Includes: Fuel-fired boilers and generators for hot water and steam systems. Includes breechings, chimneys, and stacks. Includes: Electric boilers and generators for hot water and steam systems. Includes: Equipment to remove oxygen and other dissolved gases in boiler feed. Includes: Fuel-fired and electric furnaces. Includes: Equipment powered by solar energy. Includes: Fuel-fired radiant and unit heaters. Includes: Equipment used to transfer heat from one medium to another.

Associated Masterformat Sections: 23 51 00 / 23 52 00 / 23 52 13 / 23 53 00 / 23 53 13 / 23 53 16 / 23 54 00 / 23 56 00 / 23 56 13 / 23 56 16 / 23 55 00 / 23 57 00

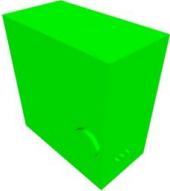
100	See D30	
200	See D3020	

Uniformat / Omniclass / Uniclass

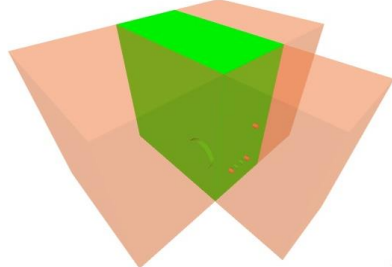
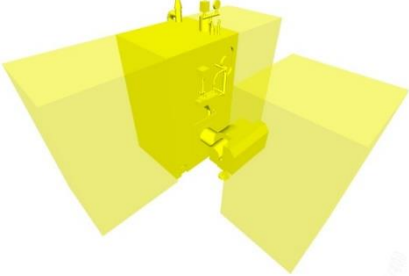
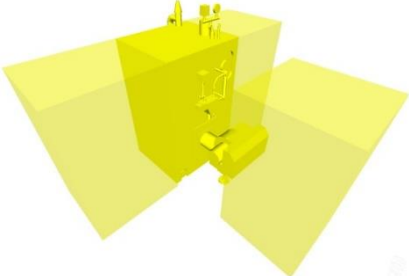
300	<p>Inclusions:</p> <ul style="list-style-type: none"> • design-specified size, shape, spacing, and location of equipment. • Approximate allowances for clearances required for all specified anchors, supports, vibration and seismic control that are utilized in the layout of equipment. • Access/code clearance requirements modeled. 	
350	<p>Inclusions:</p> <ul style="list-style-type: none"> • actual size, shape, spacing, and location/connections of equipment, • Actual size, shape, spacing, and clearances required for all specified anchors, supports, vibration and seismic control that are utilized in the layout of equipment. • Actual access/code clearance requirements modeled. 	
400	<p>Inclusions:</p> <ul style="list-style-type: none"> • Supplementary components added to the model required for fabrication and field installation. 	

D3020.30 / 21-04 30 20 30 / Ss 60 40 37 Thermal Heat Storage

Includes: Equipment to store thermal energy for use in heating and with charging or discharging this energy at a controllable rate.

Associated Masterformat Sections: 23 71 13

[See D3020.10]

D3020.70 / 21-04 30 20 70 / Ss 60 40 37 Decentralized Heating Equipment

Includes: Heating equipment that serves a portion of a HVAC system. Includes: Convection units may provide heating and cooling.

Includes: Electric cables or panels and hydronic piping used for radiant heating for space heating.

Associated Masterformat Sections: 23 80 00 / 23 82 00 / 23 82 13 / 23 82 14 / 23 82 16 / 23 82 19 / 23 82 23 / 23 82 26 / 23 82 29 / 23 82 33 / 23 82 36 / 23 82 39 / 23 83 00

[See D3020.10]

Send feedback to communications@bimforum.org



Copyright © 2023 BIMForum. All rights reserved.
This document is copyrighted under a [Creative Commons Attribution-NonCommercial-NoDerivatives 4.0 International License](https://creativecommons.org/licenses/by-nc-nd/4.0/).

Uniformat / Omniclass / Uniclass

D3020.90 / 21-04 30 20 90 / Ss 60 40 37

Heating System Supplementary Components

Includes: Common work results for HVAC, insulation, and instrumentation and control to be included in heating system elements above as appropriate.

Associated Masterformat Sections: 05 45 13 / 23 05 00 / 23 05 19 / 23 05 23 / 23 05 29 / 23 05 48 / 23 05 53 / 23 05 63 / 23 05 66 / 23 05 93 / 23 07 00 / 23 09 00

See [General Notes](#): Supplementary Components

D3030 / 21-04 30 30 / Ss 60 40 17

Cooling Systems

Includes: Associated ductwork, piping, valves, and specialties. Includes: Cooling System Supplementary Components as appropriate.

Associated Masterformat Sections: 01 86 19

100	See D30	
200	Inclusions: <ul style="list-style-type: none"> Schematic layout with approximate size, shape, and location of element(s). 	

D3030.10 / 21-04 30 30 10 / Ss 60 40 17 0

Central Cooling

Includes: Refrigerant compressors, condensers, packaged compressor and condenser units, water chillers, and cooling towers.

Includes: Various type of compressors used in refrigeration process. Includes: Condensing units used to reject heat from the refrigeration process. Includes: Compressor in combination with condensing units used to reject heat from the refrigeration process.

Includes: Various types of chillers used for building space cooling. Includes: Factory- and field-fabricated cooling towers and liquid coolers. Includes piping and specialties. chemical water treatment. vibration and seismic controls. and integral controls not a part of the condenser water distribution systems.

Associated Masterformat Sections: 23 60 00 / 23 61 00 / 23 62 00 / 23 63 00 / 23 64 00 / 23 65 00

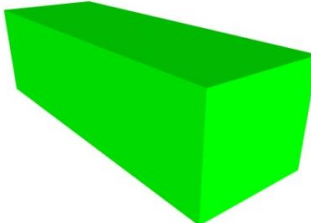
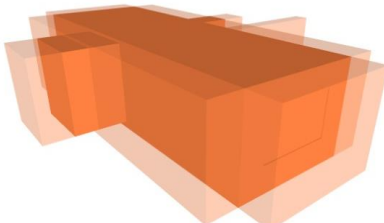
100	See D30	
200	See D3030	
300	Inclusions: <ul style="list-style-type: none"> s design-specified size, shape, spacing, and location of equipment. Approximate allowances for clearances required for all specified anchors, supports, vibration and seismic control that are utilized in the layout of equipment. Access/code clearance requirements modeled. 	

Send feedback to communications@bimforum.org



Copyright © 2023 BIMForum. All rights reserved
This document is copyrighted under a [Creative Commons Attribution-NonCommercial-NoDerivatives 4.0 International License](#).

Unifomat / Omniclass / Uniclass

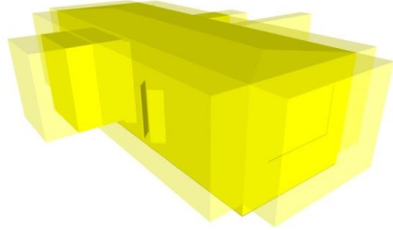
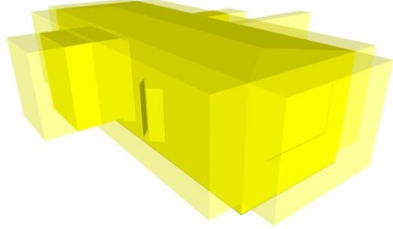
350	<p>Inclusions:</p> <ul style="list-style-type: none"> • actual size, shape, spacing, and location/connections of equipment. • Actual size, shape, spacing, and clearances required for all specified anchors, supports, vibration and seismic control that are utilized in the layout of equipment. • Actual access/code clearance requirements modeled. 	
400	<p>Inclusions:</p> <ul style="list-style-type: none"> • Supplementary components added to the model required for fabrication and field installation. 	

D3030.30 / 21-04 30 30 30 / Ss 65 80 45 25 Evaporative Air-Cooling

Includes: Equipment used to reject heat from the refrigeration process by evaporation.

Associated Masterformat Sections: 23 76 00

100	See D3030.10	
200	See D3030.10	
300	See D3030.10	
350	See D3030.10	

Send feedback to communications@bimforum.org



Copyright © 2023 BIMForum. All rights reserved
This document is copyrighted under a [Creative Commons Attribution-NonCommercial-NoDerivatives 4.0 International License](https://creativecommons.org/licenses/by-nc-nd/4.0/).

Uniformat / Omniclass / Uniclass

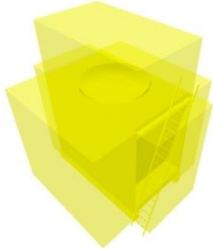
400	See D3030.10	
-----	--------------	---

D3030.50 / 21-04 30 30 50 / Ss 60 40 17 Thermal Cooling Storage

Includes: Equipment to store thermal energy for use in cooling and with charging or discharging this energy at a controllable rate.

Associated Masterformat Sections: 23 71 00 / 23 71 16 / 23 71 19

[See D3030.10]

D3030.70 / 21-04 30 30 70 / Ss 60 40 17 Decentralized Cooling

Includes: Cooling equipment that serves a portion of a HVAC system. Note: Convection units may provide heating and cooling.

Associated Masterformat Sections: 23 80 00 / 23 81 13 / 23 81 16 / 23 81 19 / 23 81 23 /
23 81 26 / 23 81 43 / 23 81 46 / 23 82 00 / 23 82 13 / 23 82 14 / 23 82 16 / 23 82 19 /
23 82 23 / 23 82 26

[See D3030.10]

D3030.90 / 21-04 30 30 90 / Ss 60 40 17 Cooling System Supplementary Components

Includes expansion fittings, meters, gages, valves, hangers, supports, heat tracing, vibration and seismic controls. Includes: Common work results for HVAC, insulation, and instrumentation and control to be included in cooling system elements above as appropriate.

Associated Masterformat Sections: 05 45 13 / 23 05 00 / 23 05 19 / 23 05 23 / 23 05 29 /
23 05 48 / 23 05 53 / 23 05 63 / 23 05 66 / 23 05 93 / 23 07 00 / 23 09 00

See [General Notes](#): Supplementary Components

D3050 / 21-04 30 50 / Ss 60 40 84 Facility HVAC Distribution Systems

Includes: Facility Distribution Systems Supplementary Components as appropriate.

Associated Masterformat Sections:

100	See D30	
200	<p>Inclusions:</p> <ul style="list-style-type: none"> Schematic layout with approximate size, shape, and location of element(s). 	

Send feedback to communications@bimforum.org



Unifomat / Omniclass / Uniclass

D3050.10 / 21-04 30 50 10 / Ss 60 40 84 0

Facility Hydronic Distribution

Includes: Piping systems and equipment for distribution of heating hot water and cooling chilled water. Includes piping systems, pumps, tanks, supports and anchors, vibration and seismic controls, identification, and piping and equipment insulation.

Associated Masterformat Sections: 01 86 19 / 23 21 13 / 23 21 23 / 23 25 00

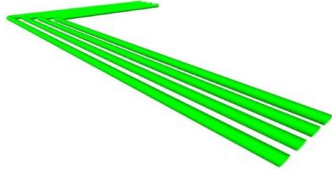
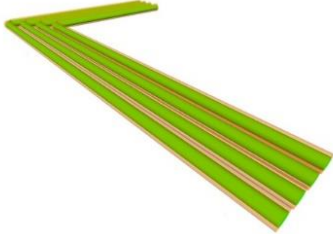
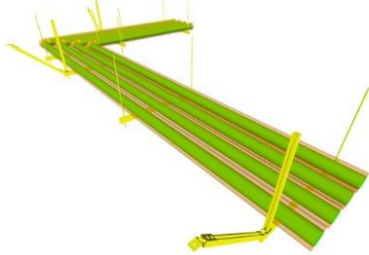
100	See D30	
200	See D3050	
300	<p>Inclusions:</p> <ul style="list-style-type: none"> • design-specified size, shape, spacing, location, and slope of pipe, valves, fittings, and insulation for risers, mains, and branches. • Approximate allowances for clearances required for all specified hangers, supports, vibration and seismic control that are to be utilized in the layout of all risers, mains, and branches. • Access/code clearance requirements modeled. 	
350	<p>Inclusions:</p> <ul style="list-style-type: none"> • actual size, shape, spacing, location, connections, and slope of pipe, valves, fittings, and insulation for risers, mains, and branches. • Actual size, shape, spacing, and clearances required for all hangers, supports, vibration and seismic control that are utilized in the layout of all risers, mains, and branches. • Actual floor and wall penetration elements. • Actual access/code clearance requirements modeled. 	

Unifomat / Omniclass / Uniclass

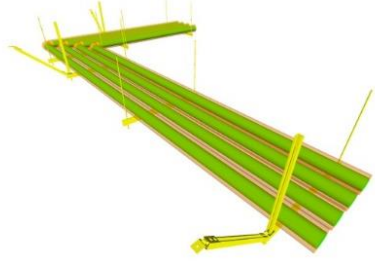
400	<p>Inclusions:</p> <ul style="list-style-type: none"> Supplementary components added to the model required for fabrication and field installation. 	
-----	---	---

D3050.30 / 21-04 30 50 30 / Ss 55 40 Facility Steam Distribution

Includes: Piping systems and equipment for distribution of steam and condensate return. Includes piping systems, pumps, tanks, supports and anchors, vibration and seismic controls, identification, and piping and equipment insulation.

Associated Masterformat Sections: 01 86 19 / 23 22 13 / 23 22 23 / 23 25 19

[See D3050.10]

D3050.50 / 21-04 30 50 50 / Ss 65 80 0 0 HVAC Air Distribution

Includes: Systems for distribution of air including supply systems, return systems, and general exhaust systems. Does not include special exhaust systems such as kitchen hood, paint booth, and fume hood exhaust systems. Includes: Air-handling units consisting of fans, coils, dampers, control devices, and other accessories. Includes: Ducts, duct accessories, fans, terminal units, and air inlets and outlets. Includes: Devices of a variety of types to clean distribution air. Includes: Equipment that adds or removes moisture from a medium in order to control the humidity.

Associated Masterformat Sections: 01 86 19 / 23 73 00 / 23 74 00 / 23 75 00 / 23 30 00 / 23 34 00 / 23 31 00 / 23 32 00 / 23 33 00 / 23 36 00 / 23 37 00 / 23 40 00 / 23 41 00 / 23 42 00 / 23 43 00 / 23 84 00

100	See D30	
200	See D3050	
300	<p>Inclusions:</p> <ul style="list-style-type: none"> design-specified size, shape, spacing, and location of duct, dampers, fittings, and insulation for risers, mains, and branches. Approximate allowances for clearances required for all specified hangers, supports, vibration and seismic control that are to be utilized in the layout of all risers, mains, and branches. Access/code clearance requirements modeled. 	

Unifomat / Omniclass / Uniclass

350	<p>Inclusions:</p> <ul style="list-style-type: none"> • actual size, shape, spacing, and location/connections of duct, dampers, fittings, and insulation for risers, mains, and branches. • Actual size, shape, spacing, and clearances required for all hangers, supports, vibration and seismic control that are utilized in the layout of all risers, mains, and branches. • Actual floor and wall penetration elements. • Actual access/code clearance requirements modeled. 	
400	See D3050.10	

D3050.90 / 21-04 30 50 90 / Ss 60 40 84

Facility Distribution Systems Supplementary Components

Includes expansion fittings, meters, gages, valves, hangers, supports, heat tracing, vibration and seismic controls. Includes: Common work results for HVAC, insulation, and instrumentation and control to be included in distribution system elements above as appropriate.

Associated Masterformat Sections: 05 45 13 / 23 05 00 / 23 05 16 / 23 05 19 / 23 05 23 / 23 05 29 / 23 05 33 / 23 05 48 / 23 05 53 / 23 05 63 / 23 05 66 / 23 05 93 / 23 07 00 / 23 09 00

See [General Notes](#): Supplementary Components

D3060 / 21-04 30 60 / Ss 65 40 0 0

Ventilation

Includes: Supply air, return air, exhaust air, outside air, and air cleaning systems. Includes Ventilation Supplementary Components as appropriate.

Associated Masterformat Sections: 01 86 19

100	See D30	
200	<p>Inclusions:</p> <ul style="list-style-type: none"> • Schematic layout with approximate size, shape, and location of mains and risers. 	

D3060.10 / 21-04 30 60 10 / Ss 65 40 33 51

Supply Air

Associated Masterformat Sections: 23 34 00 / 23 31 00 / 23 32 00 / 23 33 00 / 23 36 00 / 23 37 00

100	See D30	
-----	---------	--

Uniformat / Omniclass / Uniclass

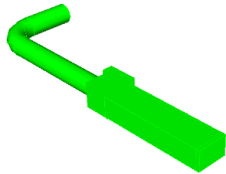
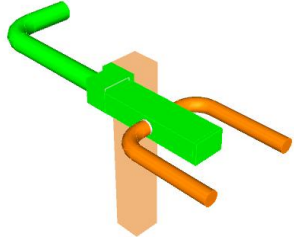
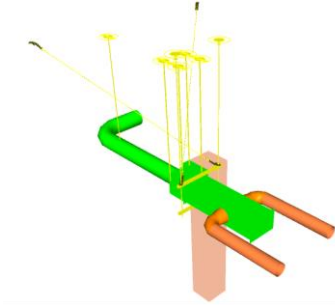
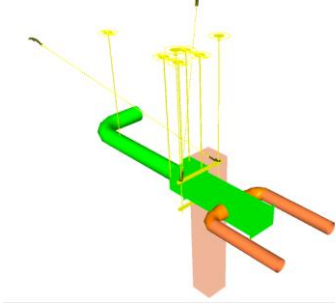
200	See D3060	
300	<p>Inclusions:</p> <ul style="list-style-type: none"> • design-specified size, shape, spacing, and location of duct, dampers, fittings, and insulation for risers, mains, and branches. • Approximate specified allowances for clearances required for all hangers, supports, vibration and seismic control that are to be utilized in the layout of all risers, mains, and branches. • Access/code clearance requirements modeled. 	
350	<p>Inclusions:</p> <ul style="list-style-type: none"> • actual size, shape, spacing, and location/connections of duct, dampers, fittings, and insulation for risers, mains, and branches. • Actual size, shape, spacing, and clearances required for all hangers, supports, vibration and seismic control that are utilized in the layout of all risers, mains, and branches. • Actual floor and wall penetration elements. • Actual access/code clearance requirements modeled. 	
400	<p>Inclusions:</p> <ul style="list-style-type: none"> • Supplementary components added to the model required for fabrication and field installation. 	

D3060.20 / 21-04 30 60 20 / Ss 65 40

Return Air

Associated Masterformat Sections: 23 34 00 / 23 31 00 / 23 32 00 / 23 33 00 / 23 37 00

[See D3060.10]

Send feedback to communications@bimforum.org



Copyright © 2023 BIMForum. All rights reserved
This document is copyrighted under a [Creative Commons Attribution-NonCommercial-NoDerivatives 4.0 International License](https://creativecommons.org/licenses/by-nc-nd/4.0/).



Unifomat / Omniclass / Uniclass

D3060.30 / 21-04 30 60 30 / Ss 65 40

Exhaust Air

Includes: Special systems for exhausting air such as kitchen hood, paint booth, and fume hood exhaust systems.

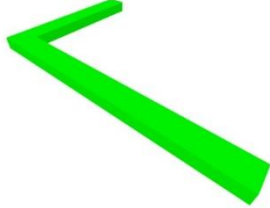
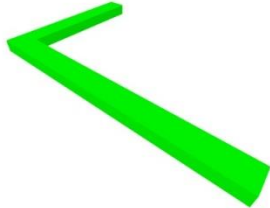
Associated Masterformat Sections: 23 35 00 / 23 35 13.13 / 23 35 16 / 23 38 00 / 23 38 13 / 23 38 16 / 23 34 00 / 23 31 00 / 23 32 00 / 23 33 00 / 23 37 00

100	See D30	
200	See D3060	
300	<p>Inclusions:</p> <ul style="list-style-type: none"> • design-specified size, shape, spacing, location, duct slope (if required), dampers, fittings, insulation for risers, mains, and branches. • Approximate specified allowances for clearances required for all hangers, supports, vibration and seismic control that are to be utilized in the layout of all risers, mains, and branches. • Access/code clearance requirements modeled. 	
350	<p>Inclusions:</p> <ul style="list-style-type: none"> • actual size, shape, spacing, location, and slope (if required)/connections of duct, dampers, fittings, and insulation for risers, mains, and branches. • Actual size, shape, spacing, and clearances required for all hangers, supports, vibration and seismic control that are utilized in the layout of all risers, mains, and branches. • Actual floor and wall penetration elements. • Actual access/code clearance requirements modeled. 	
400	See D3060.10	

Send feedback to communications@bimforum.org



Copyright © 2023 BIMForum. All rights reserved
This document is copyrighted under a [Creative Commons Attribution-NonCommercial-NoDerivatives 4.0 International License](https://creativecommons.org/licenses/by-nc-nd/4.0/).

Unifomat / Omniclass / Uniclass

D3060.40 / 21-04 30 60 40 / Ss 65 40 33 51

Outside Air

Associated Masterformat Sections: 23 34 00 / 23 31 00 / 23 32 00 / 23 33 00 / 23 36 00 / 23 37 00

[See D3060.10]

D3060.60 / 21-04 30 60 60 / Pr 60 60 36

Air-to-Air Energy Recovery

Includes: Air-to-air energy recovery units.

Associated Masterformat Sections: 23 72 00

[See D3060.10]

D3060.70 / 21-04 30 60 70 / Pr 65 57 02

HVAC Air Cleaning

Associated Masterformat Sections: 23 40 00

[See D3060.10]

D3060.90 / 21-04 30 60 90 / Ss 65 40

Ventilation Supplementary Components

Includes expansion fittings, meters, gages, valves, hangers, supports, heat tracing, vibration and seismic controls. Includes: Common work results for HVAC, insulation, and instrumentation and control to be included in ventilation elements above as appropriate.

Associated Masterformat Sections: 05 45 13 / 23 05 00 / 23 05 29 / 23 05 48 / 23 05 53 / 23 05 63 / 23 05 66 / 23 05 93 / 23 07 00 / 23 09 00

See [General Notes](#): Supplementary Components

D3070 / 21-04 30 70 / Ss 60

Special Purpose HVAC Systems

Associated Masterformat Sections:

100	See D30	
200	Inclusions: <ul style="list-style-type: none">Schematic layout with approximate size, shape, and location of components.	

Uniformat / Omniclass / Uniclass

D3070.10 / 21-04 30 70 10 / Ss 60 30 60

Snow Melting

Includes: Electric cables and hydronic piping used for snow and ice control.

Associated Masterformat Sections: 23 83 13 / 23 83 16

100	See D30	
200	See D3070	
300	Inclusions: <ul style="list-style-type: none"> design-specified size, shape, spacing, and location of supplementary components. approximate allowances for clearances required for all specified hangers, supports, vibration and seismic control that are to be utilized in the layout of all supplementary components. access/code clearance requirements. 	
350	Inclusions: <ul style="list-style-type: none"> Modeled as actual size, shape, spacing, and location/connections of supplementary components. Actual size, shape, spacing, and clearances required for all hangers, supports, vibration and seismic control that are utilized in the layout of all supplementary components. Actual access/code clearance requirements. 	
400	Inclusions: <ul style="list-style-type: none"> Supplementary components added to the model required for fabrication and field installation. 	

D40 / 21-04 40 / Ss 55 30

Fire Protection

100	Inclusions: <ul style="list-style-type: none"> Diagrammatic or schematic model elements. Conceptual and/or schematic layout/flow diagram. 	
-----	---	--

D4010 / 21-04 40 10 / Ss 55 30

Fire Suppression

Includes: Fire Suppression Supplementary Components as appropriate.

Associated Masterformat Sections: 01 86 13 / 21 00 00

100	See D40	
200	Inclusions: <ul style="list-style-type: none"> Schematic layout with approximate size, shape, and location of mains and risers. 	



Unifomat / Omniclass / Uniclass

D4010.10 / 21-04 40 10 10 / Ss 55 30 98

Water-Based Fire-Suppression

Includes: Systems that use water for fire extinguishing and suppression. Includes piping, fittings, and specialties; hoses, valves, cabinets; fire pumps, accessories, and controls. Includes: Piping, fittings, valves, hangers, supports, other specialties, and sprinklers for fire protection systems. Includes limited area sprinkler systems, fire pumps, accessories, and controls.

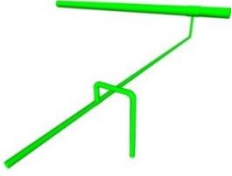
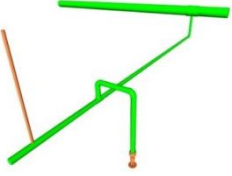
Associated Masterformat Sections: 01 86 13 / 21 10 00 / 21 11 00 / 21 12 00 / 21 13 00 / 21 13 13 / 21 13 16 / 21 13 19 / 21 13 23 / 21 13 26 / 21 13 29 / 21 13 36 / 21 13 39 / 21 30 00 / 21 40 00

100	See D40	
200	See D4010	
300	<p>Inclusions:</p> <ul style="list-style-type: none"> design-specified size, shape, spacing, and location of pipe/slope (if required)/valves/fittings/insulation for risers, mains, and branches/standpipes. Approximate allowances for clearances required for all specified hangers, supports, vibration and seismic control that are to be utilized in the layout of all risers, mains, and branches/standpipes. Access/code clearance requirements modeled. 	
350	<p>Inclusions:</p> <ul style="list-style-type: none"> actual size, shape, spacing, and location/ slope (if required)/connections of pipe, valves, fittings, and insulation for risers, mains, and branches/standpipes. Actual size, shape, spacing, and clearances required for all hangers, supports, vibration and seismic control that are utilized in the layout of all risers, mains, and branches/standpipes. Actual floor and wall penetration elements. Actual access/code clearance requirements modeled. 	
400	<p>Inclusions:</p> <ul style="list-style-type: none"> Supplementary components added to the model required for fabrication and field installation. 	

Uniformat / Omniclass / Uniclass

D4010.50 / 21-04 40 10 50 / Ss 55 30

Fire-Extinguishing

Includes: Systems that use other than water for fire extinguishing and suppression. Includes piping, fittings, and specialties; valves, accessories, and controls.

Associated Masterformat Sections: 21 20 00 / 21 21 00 / 21 22 00 / 21 23 00 / 21 24 00

[See D4010.10]

D4010.90 / 21-04 40 10 90 / Ss 55 30

Fire Suppression Supplementary Components

Includes: Expansion fittings and loops, meters and gages, general-duty valves, hanger and supports, heat tracing, vibration and seismic controls, identification, insulation, and instrumentation and control to be included in fire protection elements above as appropriate.

Associated Masterformat Sections: 05 45 13 / 21 05 00 / 21 05 16 / 21 05 19 / 21 05 23 / 21 05 29 / 21 05 33 / 21 05 48 / 21 05 53 / 21 07 00 / 21 09 00

See [General Notes](#): Supplementary Components

D4030 / 21-04 40 30 / Ss 55 30

Fire Protection Specialties

Includes: Firefighting devices and storage cabinets except devices connected to a fire suppression system.

Associated Masterformat Sections: 10 44 00

100	See D40	
200	Inclusions: <ul style="list-style-type: none">Schematic layout with approximate size, shape, and location of components.	

D4030.10 / 21-04 40 30 10 / Pr 80 77 28 28

Fire Protection Cabinets

Associated Masterformat Sections: 10 44 13

100	See D40	
200	See D4030	
300	Inclusions: <ul style="list-style-type: none">design-specified size, shape, spacing, and location of components.Approximate allowances for clearances required for all specified hangers, supports, vibration and seismic control that are to be utilized in the layout of all components.Access/code clearance requirements modeled.	

Unifomat / Omniclass / Uniclass

350	<p>Inclusions:</p> <ul style="list-style-type: none"> • actual size, shape, spacing, and location/connections of components. • Actual size, shape, spacing, and clearances required for all hangers, supports, vibration and seismic control that are utilized in the layout of all components. • Actual access/code clearance requirements modeled. 	
400	<p>Inclusions:</p> <ul style="list-style-type: none"> • Supplementary components added to the model required for fabrication and field installation. 	

D4030.30 / 21-04 40 30 30 / Ss 55 30 65

Fire Extinguishers

Associated Masterformat Sections: 10 44 16

[See D4030.10]

D4030.50 / 21-04 40 30 50 / TE 70 20 20 10

Breathing Air Replenishment Systems

Associated Masterformat Sections: 10 44 33

[See D4030.10]

D4030.70 / 21-04 40 30 70 / Ss 55 30 65 65

Fire Extinguisher Accessories

Associated Masterformat Sections: 10 44 43

[See D4030.10]

D50 / 21-04 50 / --

Electrical

Associated Masterformat Sections: 26 00 00 / 01 86 26

100	<p>Inclusions:</p> <ul style="list-style-type: none"> • Diagrammatic or schematic model elements; • conceptual and/or schematic layout; 	
-----	---	--

D5010 / 21-04 50 10 / --

Facility Power Generation

Includes: Power Generation Supplementary Components as appropriate.

Associated Masterformat Sections: 01 86 26

100	See D50	
-----	---------	--

Send feedback to communications@bimforum.org



Copyright © 2023 BIMForum. All rights reserved.
This document is copyrighted under a [Creative Commons Attribution-NonCommercial-NoDerivatives 4.0 International License](https://creativecommons.org/licenses/by-nc-nd/4.0/).

Unifomat / Omniclass / Uniclass

200	<p>Inclusions:</p> <ul style="list-style-type: none"> Schematic layout with approximate size, shape, and location of equipment; 	
-----	--	--

D5010.10 / 21-04 50 10 10 / Ss 70 10 30 Packaged Generator Assemblies

Includes: Generator, frequency changers, and rotary converters and uninterruptible power units.

Associated Masterformat Sections: 26 32 00 / 26 32 13 / 26 32 16 / 26 32 19 / 26 32 23 / 26 32 26 / 26 32 29 / 26 32 33

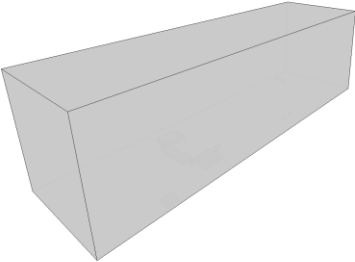
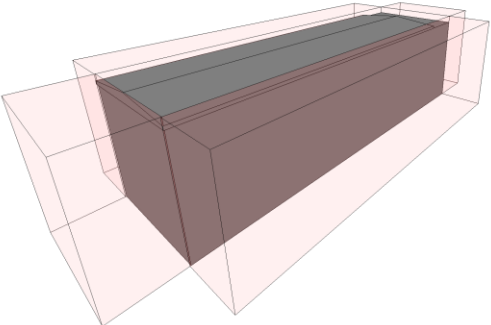
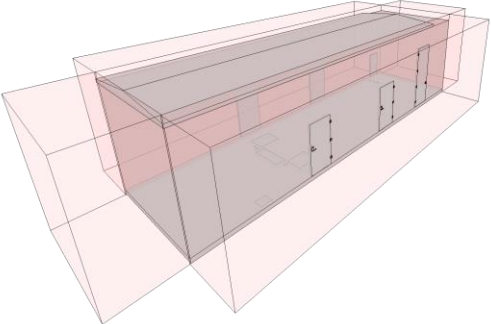
100	See D50	
200	See D5010	
300	<p>Inclusions:</p> <ul style="list-style-type: none"> Design-specified size, shape, spacing, and location of equipment and associated components. Approximate allowances for clearances required for all specified supports and seismic control. Access/code clearance requirements modeled. 	
350	<p>Inclusions:</p> <ul style="list-style-type: none"> Actual size, shape, spacing, location of equipment, and associated components. Actual size, shape, spacing, location for supports, and seismic control. Actual size, shape, and location/connections of equipment and support structure/pads. Actual access/code clearance requirements modeled. 	

Uniformat / Omniclass / Uniclass

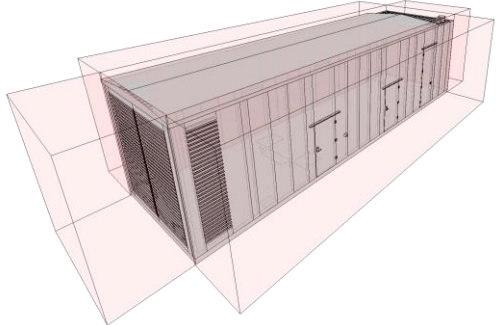
400	<p>Inclusions:</p> <ul style="list-style-type: none">• Supplementary components added to the model required for fabrication and field installation.	
-----	---	---

D5010.20 / 21-04 50 10 20 / Pr 60 70 06

Battery Equipment

Includes: Batteries, battery racks, battery chargers, static power converters, uninterruptible power supplies, and accessories.

Associated Masterformat Sections: 26 33 00 / 26 33 13 / 26 33 16 / 26 33 19 / 26 33 23 / 26 33 33 / 26 33 43 / 26 33 46 / 26 33 53

[See D5010.10]

D5010.30 / 21-04 50 10 30 / Ss 70 10 70 35

Photovoltaic Collectors

Includes: Solar cells to convert sunlight to electricity.

Associated Masterformat Sections: 26 31 00

[See D5010.10]

D5010.40 / 21-04 50 10 40 / Pr 60 70 65 30

Fuel Cells

Includes: Fuel cell electricity generating equipment.

Associated Masterformat Sections: 48 18 00

[See D5010.10]

D5010.60 / 21-04 50 10 60 / Pr 65 72 43

Power Filtering and Conditioning

D5010.70 / 21-04 50 10 70 / Ss 70 30

Transfer Switches

Includes: Switches that transfer from one source of electricity to another.

Associated Masterformat Sections: 26 36 00

[See D5010.10]

Send feedback to communications@bimforum.org



Copyright © 2023 BIMForum. All rights reserved
This document is copyrighted under a [Creative Commons Attribution-NonCommercial-NoDerivatives 4.0 International License](https://creativecommons.org/licenses/by-nc-nd/4.0/).

Unifomat / Omniclass / Uniclass

D5010.90 / 21-04 50 10 90 / Ss 70 10 30 72 Facility Power Generation Supplementary Components

See [General Notes](#): Supplementary Components

D5020 / 21-04 50 20 / Ss 70 30 Electrical Service and Distribution

Includes: Electrical Service and Distribution Supplementary Components as appropriate.

100	See D50	
200	Inclusions: <ul style="list-style-type: none"> Schematic layout with approximate size, shape, and location of equipment; 	
300	Inclusions: <ul style="list-style-type: none"> Design-specified size, shape, spacing, and location of equipment and associated components; Approximate allowances for clearances required for all specified supports and seismic control; Access/code clearance requirements modeled. 	

D5020.10 / 21-04 50 20 10 / Ss 70 30 45 45 Electrical Service Entrance

Includes: Meters, substations, transformers, switchgear, switchboards, and protective devices where electrical power enters structure.

Associated Masterformat Sections: 26 21 00 / 26 16 00 / 26 11 00 / 26 12 00 / 26 22 00 / 26 13 00 / 22 23 00 / 26 18 00 / 22 28 00

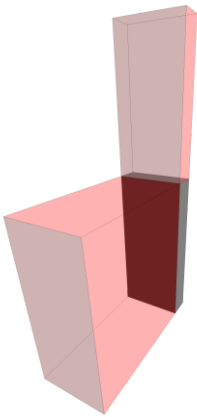
100	See D50	
200	See D5020	
300	Inclusions: <ul style="list-style-type: none"> Design-specified size, shape, spacing, location of equipment, and associated components. approximate allowances for clearances required for all specified supports and seismic control. access/code clearance requirements modeled. 	

Unifomat / Omniclass / Uniclass

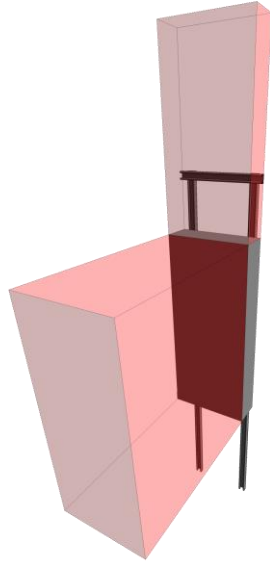
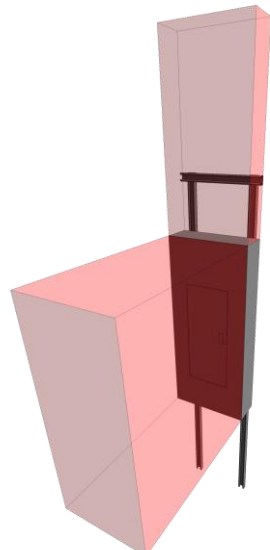
350	<p>Inclusions:</p> <ul style="list-style-type: none"> • Actual size, shape, spacing, location of equipment, and associated components. • Actual size, shape, spacing, location for supports and seismic control • Actual size, shape, and location/connections of equipment and support structure/pads. • Actual access/code clearance requirements modeled. 	
400	<p>Inclusions:</p> <ul style="list-style-type: none"> • Supplementary components added to the model required for fabrication and field installation. 	

D5020.30 / 21-04 50 20 30 / Ss 70 30 45 45

Power Distribution

Includes: Bus assemblies, distribution equipment, and electrical wiring system to distribute electrical power to switchboards, panelboards, and motor control centers.

Associated Masterformat Sections: 26 20 00 / 26 24 00 / 26 24 13 / 26 24 16 / 26 24 19 / 26 25 00 / 26 27 00 / 26 27 16 / 26 05 33 / 26 05 43 / 26 05 36 / 26 05 13

100	See D50	
-----	---------	--

Send feedback to communications@bimforum.org



Copyright © 2023 BIMForum. All rights reserved
This document is copyrighted under a [Creative Commons Attribution-NonCommercial-NoDerivatives 4.0 International License](https://creativecommons.org/licenses/by-nc-nd/4.0/).

Unifomat / Omniclass / Uniclass

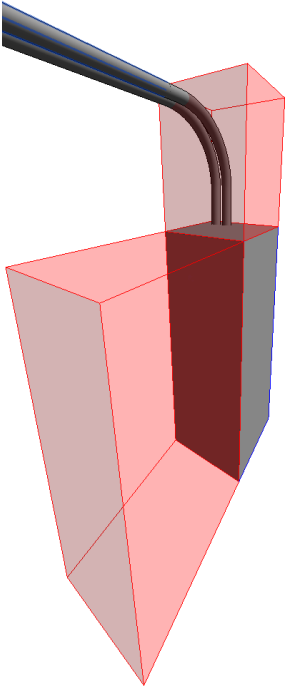
200	See D5020	
-----	-----------	---

Unifomat / Omniclass / Uniclass

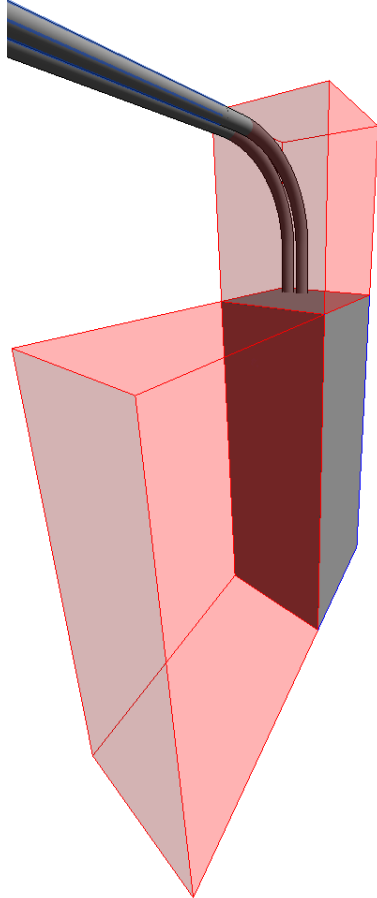
300	<p>Inclusions:</p> <ul style="list-style-type: none">• Design-specified size, shape, spacing, location of raceways, boxes, enclosures, and equipment.• Approximate allowances for spacing and clearances required for all specified hangers, supports and seismic control.• Access/code clearance requirements modeled.	 A 3D perspective rendering of a cable tray system. A dark blue cable enters from the top left, curves downwards, and then runs horizontally through a red, rectangular tray. The tray is supported by a vertical red post. The tray and post are shown in a semi-transparent red color, revealing the internal structure and the cable's path. The tray has a sloped bottom and a vertical side wall. The cable is shown in a dark blue color with a metallic sheen.
-----	---	---

Send feedback to communications@bimforum.org



Copyright © 2023 BIMForum. All rights reserved
This document is copyrighted under a [Creative Commons Attribution-NonCommercial-NoDerivatives 4.0 International License](https://creativecommons.org/licenses/by-nc-nd/4.0/).

Unifomat / Omniclass / Uniclass

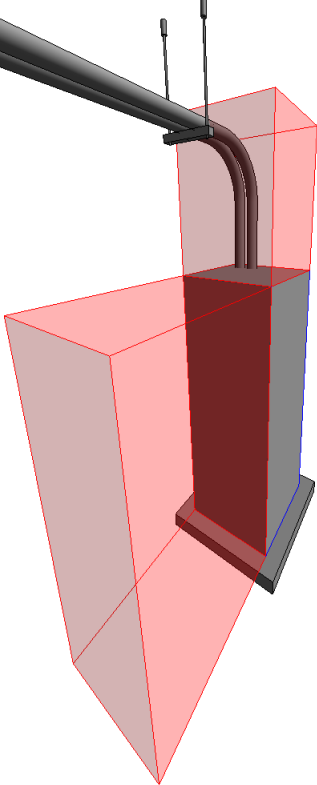
350	<p>Inclusions:</p> <ul style="list-style-type: none">• Actual size, shape, spacing, and location of raceways, boxes, and enclosures.• Actual size, shape, spacing, and location for supports and seismic control.• Actual size, shape, and location/connections of equipment and support structure/pads.• Actual floor and wall penetration elements are modeled.• Actual access/code clearance requirements modeled.	 A 3D architectural rendering showing a cable tray system. A black cable tray is mounted on a wall and extends through a wall and floor. The wall and floor are shown as semi-transparent red blocks. The cable tray is supported by a dark grey structure. The rendering illustrates the penetration of the cable tray through the wall and floor, showing the supports and the tray's path.
-----	---	---

Unifomat / Omniclass / Uniclass

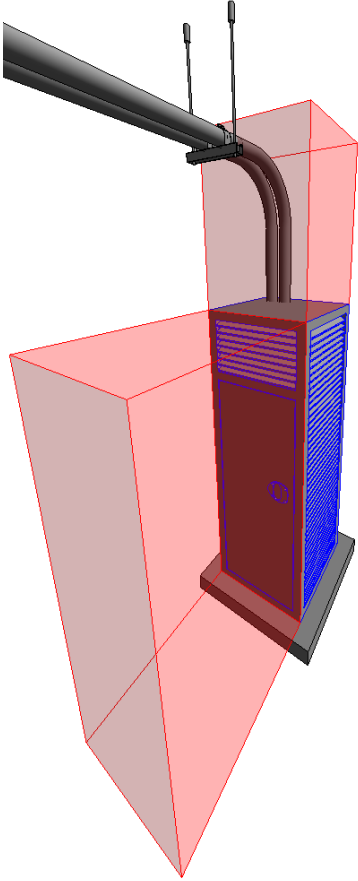
400	<p>Inclusions:</p> <ul style="list-style-type: none"> Supplementary components added to the model required for fabrication and field installation. 	
-----	---	--

D5020.70 / 21-04 50 20 70 / Ss 70 30 45 45 Facility Grounding

Includes: Raceways, wiring and devices for grounding and bonding an electrical distribution system.

Associated Masterformat Sections: 26 05 26 / 26 05 33 / 26 05 13

100	See D50	
200	See D5020	
300	<p>Inclusions:</p> <ul style="list-style-type: none"> Design-specified size, shape, spacing, location of raceways, boxes, enclosures, and the electrical equipment and end-devices served. Approximate allowances for clearances required for all specified hangers, supports, and seismic control. Access/code clearance requirements modeled. 	

Send feedback to communications@bimforum.org



Copyright © 2023 BIMForum. All rights reserved
This document is copyrighted under a [Creative Commons Attribution-NonCommercial-NoDerivatives 4.0 International License](https://creativecommons.org/licenses/by-nc-nd/4.0/).

Uniformat / Omniclass / Uniclass

350	Inclusions: <ul style="list-style-type: none"> • Actual size, shape, spacing, and location of raceways, boxes, enclosures, and the electrical equipment and end-devices served. • Actual size, shape, spacing, and location for supports and seismic control. • Actual floor and wall penetration elements actual access/code clearance requirements modeled. 	
400	Inclusions: <ul style="list-style-type: none"> • Supplementary components added to the model required for fabrication and field installation. 	

D5020.90 / 21-04 50 20 90 / Ss 70 30 45 45

Electrical Service and Distribution Supplementary Components

Includes: Grounding and bonding, hanger and supports, raceways and boxes, cable trays, utility poles, vibration and seismic controls, identification, wiring connectors, and instrumentation and control to be included in electrical service and distribution systems elements above as appropriate.

Associated Masterformat Sections: 05 45 16 / 26 05 00 / 26 05 26 / 26 05 29 / 26 05 33 / 26 05 36 / 26 05 46 / 26 05 48 / 26 05 53 / 26 05 83 / 26 09 00

100	See D50	
200	See D5020	
300	Inclusions: <ul style="list-style-type: none"> • Design-specified size, shape, spacing, and location of raceways, boxes, enclosures, and the electrical equipment and end-devices served; • Approximate allowances for clearances required for all specified hangers, supports, and seismic control; • Access/code clearance requirements modeled. 	
350	Inclusions: <ul style="list-style-type: none"> • Actual size, shape, spacing, and location of raceways, boxes, enclosures, and the electrical equipment and end-devices served; • Actual size, shape, spacing, and location for supports and seismic control; • Actual floor and wall penetration elements. • Actual access/code clearance requirements modeled. 	
400	Inclusions: <ul style="list-style-type: none"> • Supplementary components added to the model required for fabrication and field installation. 	

D5030 / 21-04 50 30 / Ss 70 30 45 45

General Purpose Electrical Power

Includes: General Purpose Electrical Power Supplementary Components as appropriate.

Associated Masterformat Sections: 01 86 26

100	See D50	
-----	---------	--

Send feedback to communications@bimforum.org



Copyright © 2023 BIMForum. All rights reserved.
This document is copyrighted under a [Creative Commons Attribution-NonCommercial-NoDerivatives 4.0 International License](https://creativecommons.org/licenses/by-nc-nd/4.0/).

Unifomat / Omniclass / Uniclass

200	<p>Inclusions:</p> <ul style="list-style-type: none"> Schematic layout with approximate size, shape, and location of equipment; 	
-----	--	--

D5030.10 / 21-04 50 30 10 / Ss 70 30 45 45 Branch Wiring System

Includes: Raceways, ducts, cable trays, and wiring to deliver power from branch panelboards to the point of use.

Associated Masterformat Sections: 26 05 33 / 26 05 43 / 26 05 36 / 26 05 19

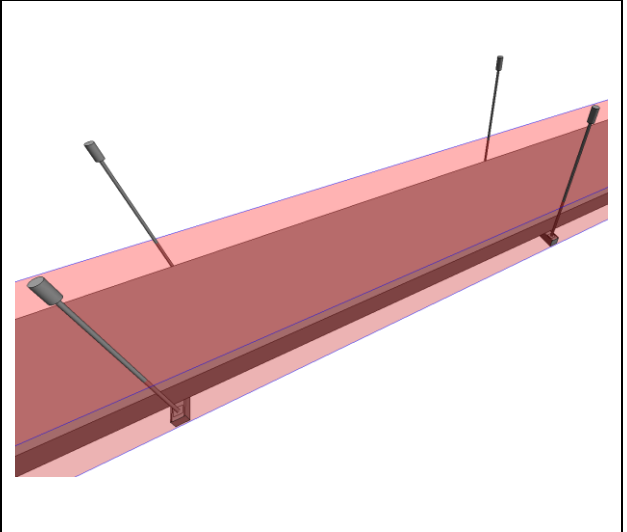
100	See D50	
200	See D5030	
300	<p>Inclusions:</p> <ul style="list-style-type: none"> Design-specified size, shape, spacing, and location of raceways, boxes, and enclosures; Approximate allowances for clearances required for all specified hangers, supports and seismic control; Access/code clearance requirements modeled. 	
350	<p>Inclusions:</p> <ul style="list-style-type: none"> Actual size, shape, spacing, and location of raceways, boxes, enclosures; Actual size, shape, spacing, and location for supports and seismic control; Actual floor and wall penetration elements. Actual access/code clearance requirements modeled. 	 <p>The diagram shows a 3D cutaway view of a raceway system. A red raceway is mounted on a wall and floor. It is supported by metal hangers. The raceway penetrates through a wall and a floor, with penetration elements shown. The raceway is shown in a perspective view, highlighting its length and the way it is supported and installed.</p>

Unifomat / Omniclass / Uniclass

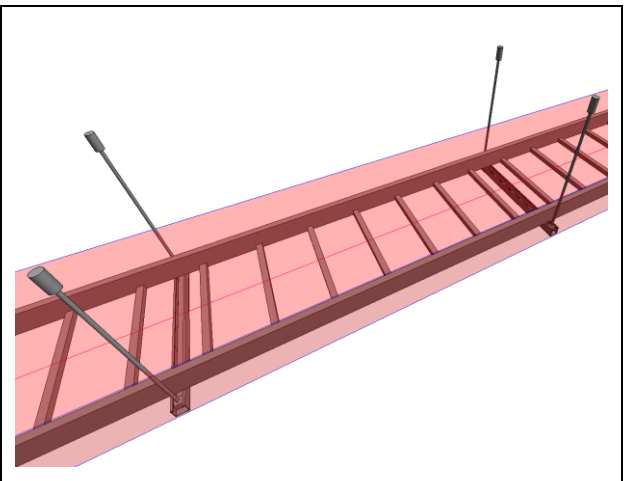
400	<p>Inclusions:</p> <ul style="list-style-type: none"> Supplementary components added to the model required for fabrication and field installation. 	
-----	---	--

D5030.50 / 21-04 50 30 50 / Ss 70 30 45 45

Wiring Devices

Includes: Electrical devices at point of use including electrical outlets and switches.

Associated Masterformat Sections: 26 27 26

100	See D50	
200	See D5030	
300	<p>Inclusions:</p> <ul style="list-style-type: none"> Design-specified size, shape, and location of outlet boxes and devices Access/code clearance requirements modeled. 	
350	<p>Inclusions:</p> <ul style="list-style-type: none"> Actual size, shape, spacing, and location of outlet boxes and devices. Actual access/code clearance requirements modeled. 	
400	<p>Inclusions:</p> <ul style="list-style-type: none"> Supplementary components added to the model required for fabrication and field installation. 	

D5030.90 / 21-04 50 30 90 / Ss 70 30 45 45

General Purpose Electrical Power Supplementary Components

Includes: Grounding and bonding, hanger and supports, raceways and boxes, cable trays, vibration and seismic controls, identification, wiring connectors, and instrumentation and control to be included in general purpose electrical power elements above as appropriate.

Associated Masterformat Sections: 05 45 16 / 26 05 00 / 26 05 26 / 26 05 29 / 26 05 33 / 26 05 36 / 26 05 48 / 26 05 53 / 26 05 83 / 26 09 00

100	See D50	
200	See D5030	

Send feedback to communications@bimforum.org



Copyright © 2023 BIMForum. All rights reserved
This document is copyrighted under a [Creative Commons Attribution-NonCommercial-NoDerivatives 4.0 International License](https://creativecommons.org/licenses/by-nc-nd/4.0/).

Unifomat / Omniclass / Uniclass

300	Inclusions: <ul style="list-style-type: none"> • Design-specified size, shape, and location of Supplementary Components • Access/code clearance requirements modeled. 	
350	Inclusions: <ul style="list-style-type: none"> • Actual size, shape, spacing, and location of outlet boxes and devices. • Actual access/code clearance requirements modeled. 	
400	Inclusions: <ul style="list-style-type: none"> • Supplementary components added to the model required for fabrication and field installation. 	

D5040 / 21-04 50 40 / Ss 70 80

Lighting

Includes: Lighting Supplementary Components as appropriate.

Associated Masterformat Sections: 26 50 00 / 01 86 26

100	See D50	
200	Inclusions: <ul style="list-style-type: none"> • Schematic layout with approximate size, shape, and location of equipment; 	

D5040.10 / 21-04 50 40 10 / Pr 70 70 47

Lighting Control

Includes: Clock and calendar, photoelectric switches, occupancy sensors, and light-leveling control devices.

Associated Masterformat Sections: 26 09 23 / 26 09 26 / 26 09 33 / 26 09 36 / 26 09 43 /

26 09 61

100	See D50	
200	See D5040	
300	Inclusions: <ul style="list-style-type: none"> • Design-specified size, shape, and location of enclosures, equipment, and devices; • Access/code clearance requirements modeled. 	
350	Inclusions: <ul style="list-style-type: none"> • Actual size, shape, spacing, and location of enclosures, equipment, and control devices; • Actual size, shape, and location/connections of equipment and control devices. • Actual access/code clearance requirements modeled. 	
400	Inclusions: <ul style="list-style-type: none"> • Supplementary components added to the model required for fabrication and field installation. 	

Send feedback to communications@bimforum.org



Copyright © 2023 BIMForum. All rights reserved.
This document is copyrighted under a [Creative Commons Attribution-NonCommercial-NoDerivatives 4.0 International License](https://creativecommons.org/licenses/by-nc-nd/4.0/).

Unifomat / Omniclass / Uniclass

D5040.20 / 21-04 50 40 20 / Ss 70 80 33 35

Branch Wiring for Lighting

Includes: Raceways, ducts, cable trays, and wiring beyond branch circuit panelboards to lighting fixtures.

Associated Masterformat Sections: 26 05 33 / 26 05 43 / 26 05 36 / 26 05 19 / 26 27 26

100	See D50	
200	See D5040	
300	Inclusions: <ul style="list-style-type: none"> • Design-specified size, shape, and location of raceways, boxes, and enclosures to fixture locations; • Approximate allowances for clearances required for all specified hangers, supports, and seismic control. • Access/code clearance requirements modeled. 	
350	Inclusions: <ul style="list-style-type: none"> • Actual size, shape, spacing, and location of raceways, boxes, and enclosures to fixture locations; • Actual size, shape, spacing, and location for supports and seismic control; • Actual floor and wall penetration elements. • Actual access/code clearance requirements modeled. 	
400	Inclusions: <ul style="list-style-type: none"> • Supplementary components added to the model required for fabrication and field installation. 	

D5040.50 / 21-04 50 40 50 / Ss 70 80

Lighting Fixtures

Includes: Luminaires, lighting equipment, ballasts, and accessories. Includes fluorescent, high intensity discharge, incandescent, mercury vapor, neon, and sodium vapor lighting.

Associated Masterformat Sections: 26 50 00 / 26 51 00 / 26 52 00 / 26 53 00 / 26 54 00 / 26 55 00 / 26 55 23 / 26 55 29 / 26 55 33 / 26 55 36 / 26 55 39 / 26 55 53 / 26 55 59 / 26 55 61 / 26 55 63 / 26 55 70

100	See D50	
200	See D5040	
300	Inclusions: <ul style="list-style-type: none"> • Design-specified size, shape, and location of lighting fixtures; • Approximate allowances for spacing and clearances required for all specified hangers, supports and seismic control; • Access/code clearance requirements modeled. 	
350	Inclusions: <ul style="list-style-type: none"> • Actual size, shape, spacing, and location of lighting fixtures. • Actual size, shape, spacing, and location for supports and seismic control. • Actual access/code clearance requirements modeled. 	

Send feedback to communications@bimforum.org



Copyright © 2023 BIMForum. All rights reserved
This document is copyrighted under a [Creative Commons Attribution-NonCommercial-NoDerivatives 4.0 International License](https://creativecommons.org/licenses/by-nc-nd/4.0/).

Unifomat / Omniclass / Uniclass

400	Inclusions: <ul style="list-style-type: none"> Supplementary components added to the model required for fabrication and field installation. 	
-----	--	--

D5040.90 / 21-04 50 40 90 / Ss 70 80 Lighting Supplementary Components

See [General Notes](#): Supplementary Components

D5080 / 21-04 50 80 / Ss 70 Miscellaneous Electrical Systems

Includes: Miscellaneous Electrical Systems Supplementary Components as appropriate.

100	See D50	
200	Inclusions: <ul style="list-style-type: none"> Schematic layout with approximate size, shape, and location of equipment; 	

D5080.10 / 21-04 50 80 10 / Ss 75 50 45 45 Lightning Protection

Includes: Wiring and equipment for lightning protection.

Associated Masterformat Sections: 26 41 00 / 01 86 26 / 26 41 13 / 26 41 16 / 26 41 19 / 26 41 23

100	See D50	
200	See D5080	
300	Inclusions: <ul style="list-style-type: none"> Design-specified size, shape, and location of raceways, boxes, enclosures including the electrical equipment and end-devices served; Approximate allowances for clearances required for all specified hangers, supports and seismic control; Access/code clearance requirements modeled. 	
350	Inclusions: <ul style="list-style-type: none"> Actual size, shape, spacing, and location of raceways, boxes, enclosures including the electrical equipment, fixtures, and end-devices served Actual size, shape, spacing, and location for supports and seismic control; Actual size, shape, and location/connections of equipment and support structure/pads; Actual floor and wall penetration elements . Actual access/code clearance requirements modeled. 	
400	Inclusions: <ul style="list-style-type: none"> Supplementary components added to the model required for fabrication and field installation. 	

Send feedback to communications@bimforum.org



Copyright © 2023 BIMForum. All rights reserved
This document is copyrighted under a [Creative Commons Attribution-NonCommercial-NoDerivatives 4.0 International License](#).

Unifomat / Omniclass / Uniclass

D5080.40 / 21-04 50 80 40 / Ss 75 50 15
Cathodic Protection

D5080.70 / 21-04 50 80 70 / Pr 65 72 27 88
Transient Voltage Suppression

Includes: Devices to protect against voltage surges on electrical distribution systems.

Associated Masterformat Sections: 26 43 00

100	See D50	
200	See D5080	
300	Inclusions: <ul style="list-style-type: none">• Design-specified size, shape, and location of equipment;• Approximate allowances for clearances required for all specified hangers, supports and seismic control;• Access/code clearance requirements modeled.	
350	Inclusions: <ul style="list-style-type: none">• Actual size, shape, spacing, and location of the equipment;• Actual size, shape, spacing, and location for supports and seismic control.• Actual access/code clearance requirements modeled.	
400	Inclusions: <ul style="list-style-type: none">• Supplementary components added to the model required for fabrication and field installation.	

D5080.90 / 21-04 50 80 90 / Pr 65 72
Miscellaneous Electrical Systems Supplementary Components

See [General Notes](#): Supplementary Components

D60 / 21-04 60 / Ss 75 10 Communications

Associated Masterformat Sections: 27 00 00 / 01 86 29

See [Fundamental LOD Definitions](#)

Send feedback to communications@bimforum.org



Copyright © 2023 BIMForum. All rights reserved
This document is copyrighted under a [Creative Commons Attribution-NonCommercial-NoDerivatives 4.0 International License](#).

Uniformat / Omniclass / Uniclass

D6010 / 21-04 60 10 / Ss 75 10 21 21

Data Communications

Includes: Communications Supplementary Components as appropriate.

Associated Masterformat Sections: 27 20 00 / 01 86 29

See [Fundamental LOD Definitions](#)

D6010.10 / 21-04 60 10 10 / Ss 75 10 21 21

Data Communications Network Equipment

Includes: Switching and routing equipment for data communications.

Associated Masterformat Sections: 27 21 00 / 27 21 13 / 27 21 16 / 27 21 29 / 27 21 33

100	See D50	
200	See D5010	
300	Inclusions: <ul style="list-style-type: none"> design-specified size, shape, spacing, and location of equipment and associated components; approximate allowances for clearances required for all specified supports and seismic control; access/code clearance requirements modeled. 	
350	Inclusions: <ul style="list-style-type: none"> actual size, shape, spacing, and location of equipment and associated components; actual size, shape, spacing, and location for supports and seismic control; actual size, shape, and location/connections of equipment and support structure/pads. actual access/code clearance requirements modeled. 	
400	Inclusions: <ul style="list-style-type: none"> Supplementary components added to the model required for fabrication and field installation. 	

D6010.20 / 21-04 60 10 20 / Pr 70 75 52

Data Communications Hardware

Includes: Computer equipment for data communications.

Associated Masterformat Sections: 27 22 00 / 07 22 13 / 07 22 16 / 07 22 19 / 07 22 23 / 07 22 26 / 07 22 29

100	See D50	
200	See D5010	
300	Inclusions: <ul style="list-style-type: none"> design-specified size, shape, and location of equipment and associated components. approximate allowances for clearances required for all specified supports and seismic control. access/code clearance requirements modeled. 	

Send feedback to communications@bimforum.org



Copyright © 2023 BIMForum. All rights reserved.
This document is copyrighted under a [Creative Commons Attribution-NonCommercial-NoDerivatives 4.0 International License](#).

Uniformat / Omniclass / Uniclass

350	Inclusions: <ul style="list-style-type: none"> • actual size, shape, spacing, and location of equipment and associated components; • actual size, shape, spacing, and location for supports and seismic control; • actual size, shape, and location/connections of equipment and support structure/pads. • actual access/code clearance requirements modeled. 	
400	Inclusions: <ul style="list-style-type: none"> • Supplementary components added to the model required for fabrication and field installation. 	

D6010.30 / 21-04 60 10 30 / Pr 70 75 15 Data Communications Peripheral Data Equipment

Includes: Additional equipment for data communications.

Associated Masterformat Sections: 27 24 00 / 27 24 13 / 27 24 26 / 27 24 19 / 27 24 23 / 27 24 26 / 27 24 29

100	See D50	
200	See D5010	
300	Inclusions: <ul style="list-style-type: none"> • design-specified size, shape, and location of equipment and associated components; • approximate allowances for clearances required for all specified supports and seismic control; • access/code clearance requirements modeled. 	
350	Inclusions: <ul style="list-style-type: none"> • actual size, shape, spacing, and location of equipment and associated components; • actual size, shape, spacing, and location for supports and seismic control; • actual size, shape, and location/connections of equipment and support structure/pads. • actual access/code clearance requirements modeled. 	
400	Inclusions: <ul style="list-style-type: none"> • Supplementary components added to the model required for fabrication and field installation. 	

D6020 / 21-04 60 20 / Ss 75 10 21 88 Voice Communications

Includes: Communications Supplementary Components as appropriate.

Associated Masterformat Sections: 27 30 00 / 01 86 29

See [Fundamental LOD Definitions](#)

Send feedback to communications@bimforum.org



Copyright © 2023 BIMForum. All rights reserved
This document is copyrighted under a [Creative Commons Attribution-NonCommercial-NoDerivatives 4.0 International License](#).

Uniformat / Omniclass / Uniclass

D6030 / 21-04 60 30 / --

Audio-Video Communication

Includes: Communications Supplementary Components as appropriate.

Associated Masterformat Sections: 27 40 00 / 01 86 29

See [Fundamental LOD Definitions](#)

D6060 / 21-04 60 60 / Ss 75 70 54 15

Distributed Communications and Monitoring

Includes: Communications Supplementary Components as appropriate.

Associated Masterformat Sections: 27 50 00 / 01 86 29

See [Fundamental LOD Definitions](#)

D6090 / 21-04 60 90 / Ss 75 10

Communications Supplementary Components

See [Fundamental LOD Definitions](#)

D70 / 21-04 70 / Ss 75 40

Electronic Safety and Security

Associated Masterformat Sections: 28 00 00 / 01 86 33

See [Fundamental LOD Definitions](#)

D7010 / 21-04 70 10 / Ss 75 40

Access Control and Intrusion Detection

Includes: Electronic Safety and Security Supplementary Components as appropriate.

Associated Masterformat Sections: 28 10 00 / 01 86 33

See [Fundamental LOD Definitions](#)

D7030 / 21-04 70 30 / Ss 75 40 53

Electronic Surveillance

Includes: Equipment for detecting and controlling access by persons to a facility site, building, or within a building. Includes Electronic Safety and Security Supplementary Components as appropriate.

Associated Masterformat Sections: 28 20 00 / 01 86 33

See [Fundamental LOD Definitions](#)

Send feedback to communications@bimforum.org



Copyright © 2023 BIMForum. All rights reserved.
This document is copyrighted under a [Creative Commons Attribution-NonCommercial-NoDerivatives 4.0 International License](#).

Unifomat / Omniclass / Uniclass

D7050 / 21-04 70 50 / Ss 75 50

Detection and Alarm

Includes: Equipment for detecting hazardous conditions in a building or on a facility site and communicating an alarm signal. Includes alarm devices, detection devices, safety switches, and associated items. Includes Electronic Safety and Security Supplementary Components as appropriate.

Associated Masterformat Sections: 28 30 00 / 01 86 33

D7070 / 21-04 70 70 / Ss 75 70 54 15

Electronic Monitoring and Control

Includes: Electronic Safety and Security Supplementary Components as appropriate.

Associated Masterformat Sections: 28 46 00 / 01 86 33

D7090 / 21-04 70 90 / Ss 75 50

Electronic Safety and Security Supplementary Components

See [General Notes](#): Supplementary Components

D80 / 21-04 80 / Ss 75 70

Integrated Automation

Associated Masterformat Sections: 25 00 00 / 01 86 23

See [Fundamental LOD Definitions](#)

D8010 / 21-04 80 10 / Ss 75 70

Integrated Automation Facility Controls

Includes: Hardware and/or software that allows the building automation system to monitor and control other facility equipment and systems. Includes Integrated Automation Supplementary Components as appropriate.

Associated Masterformat Sections: 25 50 00 / 01 86 23

See [Fundamental LOD Definitions](#)

Unifomat / Omniclass / Uniclass

E / 21-05 00 00 / -- EQUIPMENT & FURNISHINGS

E10 / 21-05 10 00 / -- Equipment

Associated Masterformat Sections: 11 00 00 / 01 87 13

100	Inclusions <ul style="list-style-type: none"> • Diagrammatic or schematic model elements; • conceptual and/or schematic layout; 	
-----	---	--

E1010 / 21-05 10 10 / -- Vehicle and Pedestrian Equipment

Associated Masterformat Sections: 11 10 00

100	See E10	
200	Inclusions <ul style="list-style-type: none"> • Schematic layout with approximate size, shape, and location of equipment; 	

E1010.10 / 21-05 10 10 10 / Ss 40 85 72 33 Vehicle Servicing Equipment

Includes: Equipment associated with vehicle service facilities.

Associated Masterformat Sections: 11 11 00 / 11 11 19 / 11 11 23 / 11 11 26

100	See E10	
200	See E1010	
300	Inclusions: <ul style="list-style-type: none"> • design-specified size, shape, spacing, and location of equipment and associated components; • Geometry of required clearances 	
350	Inclusions <ul style="list-style-type: none"> • actual size, shape, spacing, and location of equipment and associated components; • actual size, shape, spacing, and location for supports and seismic control; • actual size, shape, and location of service connections and support structure/pads. 	

Send feedback to communications@bimforum.org



Copyright © 2023 BIMForum. All rights reserved.
This document is copyrighted under a [Creative Commons Attribution-NonCommercial-NoDerivatives 4.0 International License](https://creativecommons.org/licenses/by-nc-nd/4.0/).

Uniformat / Omniclass / Uniclass

400	Inclusions <ul style="list-style-type: none">Supplementary components required for fabrication and field installation.	
-----	--	--

E1010.30 / 21-05 10 10 30 / Ss 40 85 72 11 Interior Parking Control Equipment

Includes: Equipment associated with the control of movement of vehicle parking.

Associated Masterformat Sections: 11 12 00 / 11 12 13 / 11 12 16 / 11 12 23 / 11 12 26 / 11 12 33

[See E1010.10]

E1010.50 / 21-05 10 10 50 / Ss 80 50 60 Loading Dock Equipment

Includes: Equipment for the protection of service docks and for the loading and unloading of service vehicles.

Associated Masterformat Sections: 11 13 00 / 11 13 13 / 11 13 16 / 11 13 19.13 / 11 13 19.23 / 11 13 26

[See E1010.10]

E1010.70 / 21-05 10 10 70 / Ss 40 10 Interior Pedestrian Control Equipment

Includes: Equipment associated with the control of movement of pedestrians.

Associated Masterformat Sections: 11 14 00 / 11 14 13 / 11 14 16 / 11 14 26 / 11 14 43 / 11 14 53

[See E1010.10]

E1030 / 21-05 10 30 / Ss 40 20 15 Commercial Equipment

Associated Masterformat Sections: 11 20 00

[See E1010]

E1030.10 / 21-05 10 30 10 / Ss 40 20 15 71 Mercantile and Service Equipment

Includes: Equipment used in retail and service stores.

Associated Masterformat Sections: 11 21 00 / 11 21 13 / 11 21 23 / 11 21 33 / 11 21 43 / 11 21 53

[See E1010.10]

Send feedback to communications@bimforum.org



Copyright © 2023 BIMForum. All rights reserved.
This document is copyrighted under a [Creative Commons Attribution-NonCommercial-NoDerivatives 4.0 International License](https://creativecommons.org/licenses/by-nc-nd/4.0/).

Uniformat / Omniclass / Uniclass

E1030.20 / 21-05 10 30 20 / Pr 40 30 75 94

Vault Equipment

Includes: Equipment specifically designed for money or valuable material storage, including vault ventilators and specialized security equipment.

Associated Masterformat Sections: 11 16 00 / 11 16 13 / 11 16 16 / 11 16 23

[See E1010.10]

E1030.25 / 21-05 10 30 25 / Ss 40 20 15 71

Teller and Service Equipment

Includes: Equipment specifically designed for handling and transfer of money and other high-security items.

Associated Masterformat Sections: 11 17 00 / 11 17 13 / 11 17 16 / 11 17 23 / 11 17 33 / 11 17 36

[See E1010.10]

E1030.30 / 21-05 10 30 30 / Ss 40 20 15 71

Refrigerated Display Equipment

Includes: Display cases that include refrigeration.

Associated Masterformat Sections: 11 22 00

[See E1010.10]

E1030.35 / 21-05 10 30 35 / Ss 40 15 46 15

Commercial Laundry and Dry Cleaning Equipment

Includes: Equipment for commercial laundry and dry-cleaning operations including coin-operated equipment.

Associated Masterformat Sections: 11 23 00 / 11 23 13 / 11 23 16 / 11 23 19 / 11 23 23 / 11 23 26 / 11 23 33 / 11 23 43

[See E1010.10]

E1030.40 / 21-05 10 30 40 / --

Maintenance Equipment

Includes: Built-in and free-standing equipment for building maintenance.

Associated Masterformat Sections: 11 24 00 / 11 24 13 / 11 24 16 / 11 24 19 / 11 24 23.13

[See E1010.10]

Unifomat / Omniclass / Uniclass

E1030.50 / 21-05 10 30 50 / Ss 40 45 37

Hospitality Equipment

Includes: Specialized equipment for the purpose of registering, admitting, and controlling rooms and other information at hotels, motels, hospitals, and other similar facilities.

Associated Masterformat Sections: 11 25 00 / 11 25 13

[See E1010.10]

E1030.55 / 21-05 10 30 55 / Ss 40 45 37 45

Unit Kitchens

Includes: Manufactured units incorporating plumbing fixtures, appliances, casework and countertops.

Associated Masterformat Sections: 11 26 00

[See E1010.10]

E1030.60 / 21-05 10 30 60 / Ss 40 25 75 21

Photographic Processing Equipment

Includes: Photographic film processing equipment and other products for darkroom use.

Associated Masterformat Sections: 11 27 00 / 11 27 13 / 11 27 16

[See E1010.10]

E1030.70 / 21-05 10 30 70 / Ss 40 15 58

Postal, Packaging and Shipping Equipment

Includes: Equipment for normal mailing, packaging, shipping, and delivery operations for professional, commercial, and institutional applications.

Associated Masterformat Sections: 11 29 00 / 11 29 23 / 11 29 33 / 11 29 55 / 11 28 23

[See E1010.10]

E1030.75 / 21-05 10 30 75 / Ss 40 15 58

Office Equipment

Includes: Computers, printers, copiers, drafting equipment, plotters, carto-stereographs, and other equipment used in offices.

Associated Masterformat Sections: 11 28 00 / 11 28 13 / 11 28 16 / 11 28 19 / 11 28 23

[See E1010.10]

Uniformat / Omniclass / Uniclass

E1030.80 / 21-05 10 30 80 / Ss 40 15 25

Foodservice Equipment

Includes: Equipment used for liquid and solid food storage, preparation, display, serving, and clean-up in commercial and institutional kitchens and bars.

Associated Masterformat Sections: 11 40 00 / 11 41 00 / 11 41 13 / 11 41 23 / 11 41 26 /
11 41 33 / 11 42 00 / 11 43 00 / 11 41 13 / 11 41 16 / 11 44 00 / 11 44 13 / 11 44 16 /
11 46 00 / 11 46 13 / 11 46 16 / 11 46 19 / 11 47 00 / 11 48 00 / 11 48 13

[See E1010.10]

E1040 / 21-05 10 40 / --

Institutional Equipment

Associated Masterformat Sections: 11 50 00

[See E1010]

E1040.10 / 21-05 10 40 10 / Ss 40 25 26

Educational and Scientific Equipment

Includes: Equipment associated with libraries, education facilities, laboratories, planetariums, observatories, and museums.

Associated Masterformat Sections: 11 50 00 / 11 51 00 / 11 51 13 / 11 51 16 / 11 51 19 /
11 51 23 / 11 52 00 / 11 52 13 / 11 52 16 / 11 52 19 / 11 53 00 / 11 53 13 / 11 53 16 /
11 53 19 / 11 53 23 / 11 53 33 / 11 53 43 / 11 53 53 / 11 55 00 / 11 55 13 / 11 55 16 /
11 56 00 / 11 56 13 / 11 57 00 / 11 59 00 / 11 95 00 / 11 95 13

[See E1010.10]

E1040.20 / 21-05 10 40 20 / Ss 40 50 50

Healthcare Equipment

Includes: Specialized equipment for healthcare facilities for humans and animals. Includes film illuminators, fluoroscopes, hubbard tubs, radio isotopic equipment, and surgical equipment.

Associated Masterformat Sections: 11 70 00 / 05 45 23 / 11 71 00 / 11 72 00 / 11 73 00 /
11 74 00 / 11 75 00 / 11 76 00 / 11 77 00 / 11 78 00 / 11 78 13 / 11 78 16 / 11 78 19 /
11 79 00

[See E1010.10]

E1040.40 / 21-05 10 40 40 / Ss 40 25 71

Religious Equipment

Includes: Built-in and free-standing religious equipment, including baptistery and chancel fittings.

Associated Masterformat Sections: 11 91 00 / 11 91 13

[See E1010.10]

Uniformat / Omniclass / Uniclass

E1040.60 / 21-05 10 40 60 / Ss 25 38 20

Security Equipment

Includes: Equipment specifically designed for secure operations.

Associated Masterformat Sections: 11 18 00 / 11 18 13 / 11 18 16 / 11 18 23

[See E1010.10]

E1040.70 / 21-05 10 40 70 / Ss 40 20 65 22

Detention Equipment

Includes: Equipment specifically designed for detention facilities.

Associated Masterformat Sections: 11 19 00 / 01 87 13 / 11 19 13 / 11 19 16

[See E1010.10]

E1060 / 21-05 10 60 / Ss 40 45 70

Residential Equipment

Includes: Built-in and free-standing appliances and other components specifically for residential use.

Associated Masterformat Sections: 11 30 00

[See E1010]

E1060.10 / 21-05 10 60 10 / Pr 40 70 24

Residential Appliances

Associated Masterformat Sections: 11 31 00 / 11 31 13 / 11 31 23

[See E1010.10]

E1060.50 / 21-05 10 60 50 / Ss 35 10 40

Residential Stairs

Associated Masterformat Sections: 11 33 00

[See B1080]

E1060.70 / 21-05 10 60 70 / Pr 65 67 29 23

Residential Ceiling Fans

Associated Masterformat Sections: 11 34 00

[See E1010.10]

Unifomat / Omniclass / Uniclass

E1070 / 21-05 10 70 / Ss 40 70

Entertainment and Recreational Equipment

Includes: Equipment for use in athletic, recreational, and therapeutic activities.

Associated Masterformat Sections:

[See E1010]

E1070.10 / 21-05 10 70 10 / Ss 40 25 20 90

Theater and Stage Equipment

Includes: Equipment for support of theatrical, instrumental, and voice programs. Includes cycloramas, entertainment ticket dispensers, scenery and flats, and tormentors.

Associated Masterformat Sections: 11 61 00 / 11 61 13 / 11 61 23 / 11 61 33 / 11 61 43

[See E1010.10]

E1070.20 / 21-05 10 70 20 / Ss 40 25 20

Musical Equipment

Includes: Musical instruments, including prefabricated and field assembled instruments.

Associated Masterformat Sections: 11 62 00 / 11 62 13 / 11 62 16 / 11 62 19

[See E1010.10]

E1070.50 / 21-05 10 70 50 / Ss 40 70 75

Athletic Equipment

Includes: Equipment for use in interior athletic and exercise activities.

Associated Masterformat Sections: 11 66 00 / 11 66 13 / 11 66 23 / 11 66 43 / 11 66 53

[See E1010.10]

E1070.60 / 21-05 10 70 60 / Ss 40 70

Recreational Equipment

Includes: Equipment for use in recreational activities. Includes curling rinks and pistol and rifle range equipment.

Associated Masterformat Sections: 11 67 00 / 11 67 13 / 11 67 23 / 11 67 33 / 11 67 43 /

11 67 53

[See E1010.10]

E1090 / 21-05 10 90 / Ss 40 15 35 35

Other Equipment

Associated Masterformat Sections: 11 90 00

[See E1010]

Uniformat / Omniclass / Uniclass

E1090.10 / 21-05 10 90 10 / Ss 50 80

Solid Waste Handling Equipment

Includes: Equipment involving the collection, shredding, compaction, removal and incineration of trash and other solid waste

Associated Masterformat Sections: 11 82 00 / 01 87 13 / 11 82 13 / 11 82 19 / 11 82 23 /
11 82 26 / 11 82 29 / 11 82 33 / 11 82 36

[See E1010.10]

E1090.30 / 21-05 10 90 30 / Ss 40 30 02

Agricultural Equipment

Includes: Equipment related to land cultivating, raising crops, and feeding, breeding, and raising of livestock.

Associated Masterformat Sections: 11 92 00 / 11 92 13 / 11 92 16 / 11 92 19 / 11 92 23

[See E1010.10]

E1090.40 / 21-05 10 90 40 / Ss 40 30 02 37

Horticultural Equipment

Includes: Equipment related to cultivating flowers, fruits, vegetables, or ornamental plants.

Associated Masterformat Sections: 11 93 00 / 11 93 13 / 11 93 16 / 11 93 19 / 11 93 23 /
11 93 26 / 11 93 29 / 11 93 33 / 32 86 00

[See E1010.10]

E1090.60 / 21-05 10 90 60 / Ss 40 30 42

Decontamination Equipment

Includes: Equipment associated with decontamination operations.

Associated Masterformat Sections:

[See E1010.10]

E20 / 21-05 20 / Ss 40 45

Furnishings

Associated Masterformat Sections: 12 00 00 / 01 87 16

100	Inclusions <ul style="list-style-type: none">A schematic model element or symbol	
-----	--	--

E2010 / 21-05 20 10 / Ss 40 45

Fixed Furnishings

Associated Masterformat Sections:

100	See E20	
-----	---------	--

Send feedback to communications@bimforum.org



Copyright © 2023 BIMForum. All rights reserved
This document is copyrighted under a [Creative Commons Attribution-NonCommercial-NoDerivatives 4.0 International License](https://creativecommons.org/licenses/by-nc-nd/4.0/).

Uniformat / Omniclass / Uniclass

200	Inclusions <ul style="list-style-type: none">• Generic model elements with approximate size.	
300	Inclusions <ul style="list-style-type: none">• Model element with as-designed dimensions	

E2010.10 / 21-05 20 10 10 / Ss 40 25 20 4

Fixed Art

Includes: Interior and exterior fixed art objects.

Associated Masterformat Sections: 12 10 00 / 12 11 00 / 12 12 00 / 12 12 23 / 12 12 26 / 12 14 00 / 12 17 00 / 12 19 00

See E2010

E2010.20 / 21-05 20 10 20 / Ss 25 50 45

Window Treatments

Includes: Interior window coverings and associated hardware and controls.

Associated Masterformat Sections: 12 20 00 / 12 21 00 / 12 22 00 / 12 23 00 / 12 24 00 / 12 25 00

[See E2010.10]

E2010.30 / 21-05 20 10 30 / Ss 40 15 35

Casework

Includes: Custom and manufactured stock design steel, wood, and laminate faced cabinets and other casework units. Includes countertops with integral sinks, fixtures and accessories.

Associated Masterformat Sections: 12 30 00 / 12 35 00 / 12 35 17 / 12 35 25 / 12 35 30 / 12 35 33 / 12 35 50 / 12 35 53 / 12 35 59 / 12 35 70 / 12 35 91 / 12 36 00

See E2010

E2010.70 / 21-05 20 10 70 / Pr 40 30 29

Fixed Multiple Seating

Includes: Fixed, and telescoping seating for theaters, auditoriums, lecture halls, stadiums, arenas, gymnasiums, religious buildings, restaurants, and other facilities where multiple seating is required.

Associated Masterformat Sections: 12 60 00 / 12 61 00 / 12 63 00 / 13 34 16.53 / 12 64 00 / 12 65 00 / 12 66 00 / 12 67 00 / 12 68 00

[See E2010]

Unifomat / Omniclass / Uniclass

E2010.90 / 21-05 20 10 90 / Pr 40 30

Other Fixed Furnishings

Includes: Fixed artificial plants, planters, and accessories.

Associated Masterformat Sections: 12 90 00 / 12 92 00 / 12 92 13 / 12 92 33 / 12 92 43
See E2010

E2050 / 21-05 20 50 / Pr 40 50

Movable Furnishings

Includes: *Items of moveable furniture* and furnishing accessories. Includes furniture for a variety of uses including classroom, dormitory, ecclesiastical, hotel and motel, laboratory, library, lounge, medical, office, restaurant, and residential.

Associated Masterformat Sections:
[See E2010]

E2050.10 / 21-05 20 50 10 / Ss 40 25 20 4

Movable Art

Includes: *Interior and exterior moveable art objects such as paintings, and sculpture.*

Associated Masterformat Sections: 12 10 00 / 12 14 00 / 12 19 0
[See E2010]

E2050.30 / 21-05 20 50 30 / Pr 40 50

Furniture

Includes: *Movable interior furniture.*

Associated Masterformat Sections: 12 50 00 / 12 51 00 / 12 52 00 / 12 52 23 / 12 52 70 /
12 53 00 / 12 54 00 / 12 54 13 / 12 54 16 / 12 55 00 / 12 56 00 / 12 56 33 / 12 56 39 /
12 56 43 / 12 56 51 / 12 56 52 / 12 56 53 / 12 56 70 / 12 57 00 / 12 57 13 / 12 57 16 /
12 58 00 / 12 59 00

[See E2010]

E2050.40 / 21-05 20 50 40 / Pr 40 50

Accessories

Includes: *Interior furnishing accessories not attached to permanent construction.*

Associated Masterformat Sections: 12 40 00 / 12 41 00 / 12 42 00 / 12 43 00 / 12 44 00 /
12 44 16 / 12 45 00 / 12 46 00 / 12 48 00

[See E2010]

Unifomat / Omniclass / Uniclass

E2050.60 / 21-05 20 50 60 / Pr 40 50 12

Movable Multiple Seating

Includes: Portable seating for auditoriums, lecture halls, stadiums, arenas, gymnasiums, religious buildings, restaurants, and other facilities where multiple seating is required.

Associated Masterformat Sections: 12 60 00 / 12 62 00 / 12 65 00 / 12 67 00 / 12 68 00

[See E2010]

E2050.90 / 21-05 20 50 90 / Pr 40 50

Other Movable Furnishings

Includes: Moveable artificial plants, and planters.

Associated Masterformat Sections: 12 90 00 / 12 92 00 / 12 92 13 / 12 92 33 / 12 92 43

[See E2010]

Uniformat / Omniclass / Uniclass

F / 21-06 00 00 / -- SPECIAL CONSTRUCTION & DEMOLITION

F10 / 21-06 10 / -- Special Construction

Associated Masterformat Sections: 01 88 13

F1010 / 21-06 10 10 / Ss 20 10 60 Integrated Construction

Associated Masterformat Sections:

See [Fundamental LOD Definitions](#)

F1020 / 21-06 10 20 / -- Special Structures

Associated Masterformat Sections: 13 30 00 / 01 88 13

See [Fundamental LOD Definitions](#)

F1020.40 / 21-06 10 20 40 / Ss 40 5 Special Structures: Metal Building Systems

Includes: Prefabricated buildings and structures assembled on temporary and permanent foundations.

Associated Masterformat Sections: 13 34 00 / 01 88 13 / 13 34 13 / 13 34 16 / 13 34 19 / 13 34 56

100	Inclusions: <ul style="list-style-type: none">Schematic layout	
200	Inclusions: <ul style="list-style-type: none">Element envelope	
300	Inclusions: <ul style="list-style-type: none">Element envelope	

F1030 / 21-06 10 30 / -- Special Function Construction

See [Fundamental LOD Definitions](#)

Send feedback to communications@bimforum.org



Copyright © 2023 BIMForum. All rights reserved.
This document is copyrighted under a [Creative Commons Attribution-NonCommercial-NoDerivatives 4.0 International License](#).

Uniformat / Omniclass / Uniclass

F1050 / 21-06 10 50 / -- Special Facility Components

See [Fundamental LOD Definitions](#)

F1060 / 21-06 10 60 / Ss 40 70 75 Athletic and Recreational Special Construction

Includes: Special construction for athletic and recreational activities that are directly related to the adjacent construction.

Associated Masterformat Sections: 13 28 00

See [Fundamental LOD Definitions](#)

F1080 / 21-06 10 80 / -- Special Instrumentation

Includes: Instrumentation for measuring and recording phenomena such as stresses in structures, solar and wind energy, and effects of earthquakes.

Associated Masterformat Sections: 13 50 00

See [Fundamental LOD Definitions](#)

F20 / 21-06 20 00 / Ss 15 30 Facility Remediation

Associated Masterformat Sections:

F2010 / 21-06 20 10 / Ss 15 30 Hazardous Materials Remediation

Includes: Remediation for abatement and removal and disposal of contaminated materials within structures.

Associated Masterformat Sections: 02 80 00

See [Fundamental LOD Definitions](#)

F30 / 21-06 30 00 / Ac 10 10 25 Demolition

Associated Masterformat Sections:

Send feedback to communications@bimforum.org



Copyright © 2023 BIMForum. All rights reserved
This document is copyrighted under a [Creative Commons Attribution-NonCommercial-NoDerivatives 4.0 International License](#).

Unifomat / Omniclass / Uniclass

F3010 / 21-06 30 10 / Ac 10 10 25 Structure Demolition

Includes: Complete removal and disposal of structures.

Associated Masterformat Sections: 02 41 16

See [Fundamental LOD Definitions](#)

F3030 / 21-06 30 30 / Ac 10 10 25 Selective Demolition

Includes: Removal and disposal of parts of structures.

Associated Masterformat Sections: 02 41 19

See [Fundamental LOD Definitions](#)

F3050 / 21-06 30 50 / Ac 10 80 Structure Moving

Includes: Preparation and processes of relocating and raising structures.

Associated Masterformat Sections: 02 43 00

See [Fundamental LOD Definitions](#)

Uniformat / Omniclass / Uniclass

G / 21-07 00 00 / -- **SITWORK**

Associated Masterformat Sections:

G10 / 21-07 10 00 / Ac 10 **Site Preparation**

Associated Masterformat Sections: 01 89 13

G1010 / 21-07 10 10 / Ac 10 30 **Site Clearing**

Includes: Removal of vegetation from the site, including stripping of sod and soil, and tree pruning for site clearing.

Associated Masterformat Sections: 31 10 00 / 31 11 00 / 31 13 00 / 31 14 00 / 31 14 13 / 31 14 16

G1020 / 21-07 10 20 / Ac 10 10 25 **Site Elements Demolition**

Includes: Removal of above and below grade site improvements.

Associated Masterformat Sections: 02 41 13

G1030 / 21-07 10 30 / -- **Site Element Relocations**

Includes: Relocation of utility systems.

G1050 / 21-07 10 50 / Ac 10 75 65 **Site Remediation**

Includes: Remediation of contaminated sites.

Associated Masterformat Sections: 02 50 00 / 01 89

G1070 / 21-07 10 70 / -- **Site Earthwork**

Includes: Moving earth to establish new contours and elevations.

Associated Masterformat Sections: 31 20 00 / 01 89 13

Send feedback to communications@bimforum.org



Copyright © 2023 BIMForum. All rights reserved
This document is copyrighted under a [Creative Commons Attribution-NonCommercial-NoDerivatives 4.0 International License](https://creativecommons.org/licenses/by-nc-nd/4.0/).

Uniformat / Omniclass / Uniclass

G1070.10 / 21-07 10 70 10 / --

Grading

Includes: Earthmoving to reshape contours.

Associated Masterformat Sections: 31 20 00 / 01 89 13

100	Inclusions: <ul style="list-style-type: none"> • Surface as a plane 	
200	Inclusions: <ul style="list-style-type: none"> • Surface interpolation between identified control elevations (e.g., building floor levels, existing hardscape) 	
300	Inclusions: <ul style="list-style-type: none"> • Complete surface definition 	

G20 / 21-07 20 / --

Site Improvements

Associated Masterformat Sections: 01 89 16

100	Inclusions: <ul style="list-style-type: none"> • Diagrammatic or schematic model elements. 	
-----	---	--

G2010 / 21-07 20 10 / Ss 30 14 05

Roadways

Includes: Pavement, curbs and gutters, appurtenances, lighting, and vehicle fare collection for roadways. May Include: Site earthwork.

Associated Masterformat Sections: 01 89 16

G2010.10

Roadway Pavement

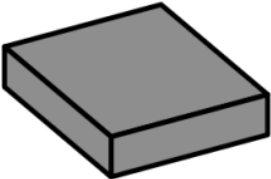
100	See G20	
200	Inclusions: <ul style="list-style-type: none"> • Plan extent of pavement • Nominal thickness 	

2

Uniformat / Omniclass / Uniclass

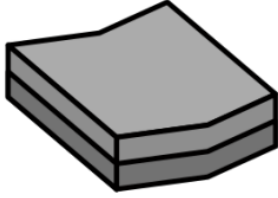
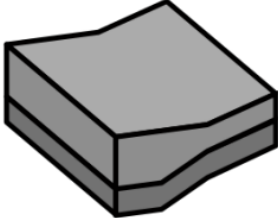
300	<p>Inclusions:</p> <ul style="list-style-type: none"> • Thickness of buildup • Grading information (points and edges) • 2D Pattern of joints 	 <p style="text-align: right;">2</p>
350	<p>Inclusions:</p> <ul style="list-style-type: none"> • Grading information (points and edges) • Expansion joints • Path intersections • Curb ramps • Thickened edges 	 <p style="text-align: right;">2</p>

G2010.20 Roadway Curbs and Gutters

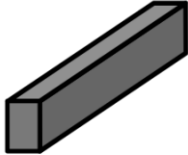
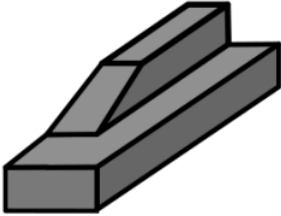
100	See G20	
200	<p>Inclusions:</p> <ul style="list-style-type: none"> • Full plan extents 	 <p style="text-align: right;">2</p>
300	<p>Inclusions:</p> <ul style="list-style-type: none"> • Profile of curb • Finish grade (top) • Curb cuts and tapers (e.g. for ramps) 	 <p style="text-align: right;">2</p>

Unifomat / Omniclass / Uniclass

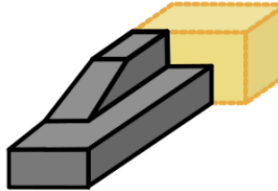
350	<p>Inclusions:</p> <ul style="list-style-type: none"> • Rough openings for storm drains or inlets 	 <p style="text-align: right;">2</p>
400	<p>Inclusions:</p> <ul style="list-style-type: none"> • Chamfers and nosing • joints 	

G2010.40 Roadway Appurtenances

See [General Notes](#): Appurtenances

G2020 / 21-07 20 20 / Ss 40 85 72 11 Parking Lots

Includes: Pavement, curbs and gutters, appurtenances, lighting, and parking control equipment for parking lots. May Include: Site earthwork

Associated Masterformat Sections: 01 89 16

G2020.10 / 21-07 20 20 10 / Ss 30 14 05 6 Parking Lot Pavement

Includes: Prepared and compacted soil and granular layers placed prior to installation of parking lot pavement. Includes: Finished parking lot pavement of granular and asphaltic materials. Includes: Finished parking lot pavement with high bending resistance, usually of concrete. Includes: Blocks or tiles used for parking lot pavement. Unit pavers set in mastic, sand, or mortar.

Associated Masterformat Sections: 32 10 00 / 32 12 00 / 32 13 00 / 32 14 00 / 32 15 00

See G2010.10

G2020.20 / 21-07 20 20 20 / Ss 30 75 45 Parking Lot Curbs and Gutters

Includes: Construction at perimeter of parking lot pavement to separate pavement from adjacent surfaces, provide vehicular restraint, and facilitate drainage.

Associated Masterformat Sections: 32 16 13

See G2010.20

Send feedback to communications@bimforum.org



Copyright © 2023 BIMForum. All rights reserved.
This document is copyrighted under a [Creative Commons Attribution-NonCommercial-NoDerivatives 4.0 International License](https://creativecommons.org/licenses/by-nc-nd/4.0/).

Uniformat / Omniclass / Uniclass

G2020.40 / 21-07 20 20 40 / Ss 40 85 72

Parking Lot Appurtenances

Includes traffic signals, signage, striping.

Associated Masterformat Sections: 32 17 00 / 32 17 13 / 32 17 43 / 10 14 53 / 32 17 23

See [General Notes](#): Appurtenances

G2030 / 21-07 20 30 / Ss 30 14

Pedestrian Plazas and Walkways

Includes: Pavement, curbs and gutters, appurtenances, lighting, and pedestrian control equipment for pedestrian plazas and walkways. Includes exterior steps and ramps. May Include: Site earthwork.

Associated Masterformat Sections: 01 89 16

For Pedestrian control equipment and other street or exterior furniture see E2010 / 21-05 20 10 Fixed Furnishings

For Handrails see C1090.10 / 21-03 10 90 10 Interior Railings and Handrails

For Site Earthwork and Grading see G1070 / 21-07 10 70 10 Grading

For Drainage see G3030 / 21-07-30-30

G2030.10

Pedestrian Pavement

See G2010.10

G2030.20

Pedestrian Pavement Curbs and Gutters

See G2010.20

G2030.30

Exterior Steps and Ramps

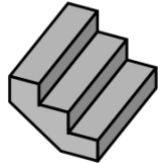
100	See G20	
200	Inclusions: <ul style="list-style-type: none">• Full plan extents	 2

Uniformat / Omniclass / Uniclass

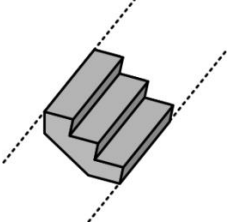
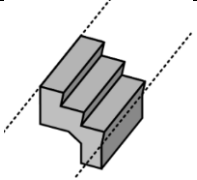
300	Inclusions: <ul style="list-style-type: none">• Stair grades at top and bottom• Nosing	 <p>2</p>
350	Inclusions: <ul style="list-style-type: none">• Thickened edges and/or footings	 <p>2</p>
400	Inclusions: <ul style="list-style-type: none">• Additional profile and nosing details• Dowels and reinforcing	

G2030.40 Pedestrian Pavement Appurtenances

See [General Notes](#): Appurtenances

G2030.70 Plaza and Walkway Lighting

See G4050

G2030.80 Exterior Pedestrian Control Equipment

See [Fundamental LOD Definitions](#)

G2040 / 21-07 20 40 / Airfields

Includes: Pavement, curbs and gutters, appurtenances, lighting, and airfield signally and control equipment for airfields. May Include: Site earthwork.

Associated Masterformat Sections: 01 89 16

Send feedback to communications@bimforum.org



Copyright © 2023 BIMForum. All rights reserved.
This document is copyrighted under a [Creative Commons Attribution-NonCommercial-NoDerivatives 4.0 International License](#).

Unifomat / Omniclass / Uniclass

G2050 / 21-07 20 50 / Ss 30 14

Athletic, Recreational, and Playfield Areas

Includes: Surfacing, fencing, equipment, grandstands and bleachers, and lighting for athletic, recreational, and playfield areas. May Include: Site earthwork.

Associated Masterformat Sections: 01 89 16

For Equipment and Play Structures, see sections 21-01 Substructure & 21-02 Shell.

100	See G20	
200	See G20	
300	<p>Element modeling to include:</p> <ul style="list-style-type: none"> • Overall size and geometry of all elements • Crossfalls & drainage slopes • Linemarking 	
350	<p>Element modeling to include:</p> <ul style="list-style-type: none"> • Fall zones • Subsurface structure 	

G2060 / 21-07 20 60 / -- Site Development

G2060.60 Retaining Walls

100	See G20	
200	<p>Inclusions:</p> <ul style="list-style-type: none"> • Full plan extents 	

2

Uniformat / Omniclass / Uniclass

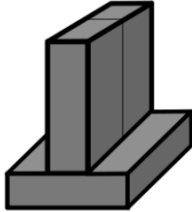
300	<p>Inclusions:</p> <ul style="list-style-type: none"> • thickness of wall • Top of wall • depth may be approximate 	 <p style="text-align: right;">2</p>
350	<p>Inclusions:</p> <ul style="list-style-type: none"> • All layers • Footing 	 <p style="text-align: right;">2</p>
400	<p>Inclusions:</p> <ul style="list-style-type: none"> • Joints • Reinforcing 	

G2060.60 Stairs

See G2030.30

G2080 / 21-07 20 80 / -- Landscaping

Includes: Trees, grass, and planting

Associated Masterformat Sections: 31 20 00 / 01 89 13

G2080.10 Planting Irrigation

100	See G20	
200	<p>Inclusions:</p> <ul style="list-style-type: none"> • Schematic layout with approximate size, shape, and location of mainline. 	 <p style="text-align: right;">2</p>

Send feedback to communications@bimforum.org



Copyright © 2023 BIMForum. All rights reserved.
This document is copyrighted under a [Creative Commons Attribution-NonCommercial-NoDerivatives 4.0 International License](https://creativecommons.org/licenses/by-nc-nd/4.0/).

Uniformat / Omniclass / Uniclass

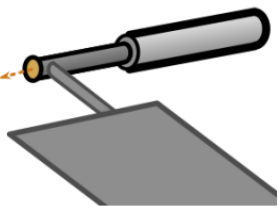
300	<p>Inclusions:</p> <ul style="list-style-type: none"> • Accurate mainline and point of connection (POC) • Major components (pumps, controllers, flow sensors, etc.) and all fittings (valves, sprinkler heads, etc) and other are shown, though may be diagrammatic and not fully sized on laterals • Major servicing and access clearance requirements are depicted • Concrete pads modeled at nominal thickness if applicable • Drip areas designated in plan 	 <p style="text-align: right;">2</p>
350	<p>Inclusions:</p> <ul style="list-style-type: none"> • Mainline sleeving • Drip lines, may be delineated as massing/area element at specified elevation (in 3d model) • Lateral lines and sleeving are modeled as design-specified size and location 	 <p style="text-align: right;">2</p>
400	<p>Inclusions:</p> <ul style="list-style-type: none"> • Modeled as actual construction elements • Actual size, shape, spacing, and location/connections of pipe, valves, fittings, and sleeves 	

G2080.20 Turf and Grasses

Includes: Lawns and grasses including seeding and sodding.

For Grasses see G2080.40

100	See G20	
200	<p>Inclusions:</p> <ul style="list-style-type: none"> • Turf and seeding areas are shown. Areas may be flat or not represented as 3D elements 	
300	<p>Inclusions:</p> <ul style="list-style-type: none"> • All areas are separated by distinct species or mix • Areas or masses follow the grading surface 	
350	<p>Inclusions:</p> <ul style="list-style-type: none"> • Root system is accounted for within the depth of the massing element. 	

Send feedback to communications@bimforum.org





Copyright © 2023 BIMForum. All rights reserved.
This document is copyrighted under a [Creative Commons Attribution-NonCommercial-NoDerivatives 4.0 International License](https://creativecommons.org/licenses/by-nc-nd/4.0/).

Unifomat / Omniclass / Uniclass

400		
-----	--	--

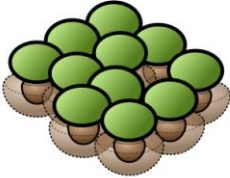

G2080.30 Plants: Trees and Large Shrubs

G2080.30.10 Groundcovers and Smaller Shrubs.

100	See G20	
200	<p>Inclusions:</p> <ul style="list-style-type: none"> • Larger mass, zones, or areas. • May be a flat mass or mesh 	 <p style="text-align: right;">2</p>
300	<p>Inclusions:</p> <ul style="list-style-type: none"> • All areas are separated by distinct species or mix • 3D form that drapes on grade (mass or individual plants) 	 <p style="text-align: right;">2</p>
350	<p>Inclusions:</p> <ul style="list-style-type: none"> • Clear zones around trees • Individual plants may be shown, though exact location may not be precise. • Root or container element shown for smaller plants or included in thickness for massed areas 	 <p style="text-align: right;">2</p>
400	<p>Inclusions:</p> <ul style="list-style-type: none"> • All individual plants are shown • Location is exact for install 	 <p style="text-align: right;">2</p>

Uniformat / Omniclass / Uniclass

G2080.30.20. Trees and Large Shrubs.

100	See G20	
200	<p>Inclusions:</p> <ul style="list-style-type: none"> Individual trees location is shown 	 <p style="text-align: right;">2</p>
300	<p>Inclusions:</p> <ul style="list-style-type: none"> 3D rootball and clear zone for hole (at installation) - Canopy size at maturity (75-100% height or as noted) 	 <p style="text-align: right;">2</p>
350	<p>Inclusions:</p> <ul style="list-style-type: none"> Staking and/or guying Canopy clearances at maturity 	 <p style="text-align: right;">2</p>
400		

G2080.80 Landscaping Activities

G2080.80.10 Planting Soil (Planting Preparation)

100	See G20	
-----	---------	--

Send feedback to communications@bimforum.org



Copyright © 2023 BIMForum. All rights reserved.
This document is copyrighted under a [Creative Commons Attribution-NonCommercial-NoDerivatives 4.0 International License](https://creativecommons.org/licenses/by-nc-nd/4.0/).

Unifomat / Omniclass / Uniclass

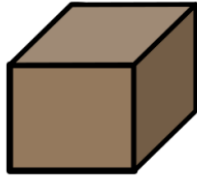
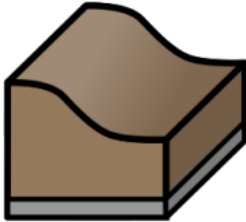
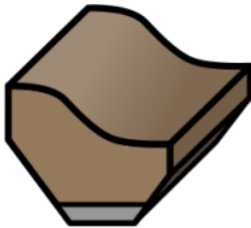
200	<p>Inclusions:</p> <ul style="list-style-type: none"> • Full plan extents • Nominal thickness of build up 	 <p style="text-align: right;">2</p>
300	<p>Inclusions:</p> <ul style="list-style-type: none"> • Finish grade • Actual thickness of buildup, including varying bottom slope(s) 	 <p style="text-align: right;">2</p>
350	<p>Inclusions:</p> <ul style="list-style-type: none"> • Tapered edges 	 <p style="text-align: right;">2</p>
400		

G2080.80.20 Existing Trees and Plant Protection

Includes: existing trees.

100	See G20	
200	<p>Inclusions:</p> <ul style="list-style-type: none"> • Existing trees, both to be removed and to retain • Model representation of planting size and extents may be approximate. • Tree protection zone/massing for existing trees 	
300	<p>Inclusions:</p> <ul style="list-style-type: none"> • Location of existing root zone is delineated in plan in the model. 	

Send feedback to communications@bimforum.org



Copyright © 2023 BIMForum. All rights reserved
This document is copyrighted under a [Creative Commons Attribution-NonCommercial-NoDerivatives 4.0 International License](https://creativecommons.org/licenses/by-nc-nd/4.0/).

Unifomat / Omniclass / Uniclass

350	Inclusions: <ul style="list-style-type: none"> Tree protection element/fencing for existing trees is modeled at correct height and shape 	
400		

G30 / 21-07 30 / Ss 55 20 Liquid and Gas Site Utilities

Associated Masterformat Sections: 01 89 19

100	Inclusions: <ul style="list-style-type: none"> Diagrammatic or schematic elements; 	
200	Inclusions: <ul style="list-style-type: none"> Schematic layout of generic model elements with approximate size, shape, and location of elements; 	

G3010 / 21-07 30 10 / Ss 55 70 Water Utilities

Includes: Water distribution for domestic consumption, fire fighting, and irrigation for a facility site and for multiple facilities. Includes trenching and backfilling. Includes Liquid and Gas Site Utilities Supplementary Components as appropriate.

Associated Masterformat Sections: 33 10 00

100	See G30	
200	See G30	

G3010.10 / 21-07 30 10 10 / Ss 55 70 38 Site Domestic Water Distribution

Includes: Supply wells, piping, equipment, storage tanks, and water ponds and reservoirs.

Associated Masterformat Sections: 01 89 19 / 33 21 00 / 33 11 00 / 33 12 00 / 33 12 13

33 12 16 / 33 12 19 / 33 12 23 / 33 12 33 / 33 13 00 / 33 16 00 / 33 47 19.13 / 33 47 13.13

33 47 16.13

100	See G30	
200	See G30	

Uniformat / Omniclass / Uniclass

G3010.30 / 21-07 30 10 30 / Ss 55 30 96

Site Fire Protection Water Distribution

Includes: Supply wells, piping, equipment, storage tanks, and water ponds and reservoirs.

Associated Masterformat Sections: 01 89 19 / 33 21 00 / 33 11 19 / 33 12 00 / 33 12 13 / 33 12 16 / 33 12 19 / 33 12 23 / 33 12 33 / 33 16 00 / 33 47 19.33 / 33 47 13.13 / 33 47 16.13

100	See G30	
200	See G30	

G3020 / 21-07 30 20 / --

Sanitary Sewerage Utilities

Includes: Sanitary sewerage for a facility site and for multiple facilities. Includes piping, septic tanks that serve multiple facilities, structures, and lagoons. Includes trenching and backfilling. Includes Liquid and Gas Site Utilities Supplementary Components as appropriate.

Associated Masterformat Sections: 33 30 00 / 01 89 19

100	See G30	
200	See G30	

G3020.20 / 21-07 30 20 20 / Ss 50 35 08 30

Sanitary Sewerage Piping

Associated Masterformat Sections: 33 31 00 / 33 33 00 / 33 34 00

100	See G30	
200	See G30	
300	Inclusions Design-specified elements	

G3020.50 / 21-07 30 20 50 / Ss 50 35 08

Sanitary Sewerage Structures

Associated Masterformat Sections: 33 39 00 / 33 39 13 / 33 39 23

100	See G30	
200	Inclusions: Element envelopes	
300	Inclusions: Design-specified elements	

Uniformat / Omniclass / Uniclass

G3030 / 21-07 30 30 / Ss 50 35 80

Storm Drainage Utilities

Includes: Storm drainage for surface or combination of surface and subsurface water for a facility site or for multiple facilities. Includes piping, culverts, water drains, drainage pumps, Subdrainage, and storm drainage ponds and reservoirs. Includes trenching and backfilling. Includes Liquid and Gas Site Utilities Supplementary Components as appropriate.

Associated Masterformat Sections: 01 89 19

100	See G30	
200	See G30	

G3050 / 21-07 30 50 / Ss 70 30

Site Energy Distribution

Includes: Energy distribution for a facility site or multiple facilities. Includes hydronic heating, steam energy, and hydronic cooling distribution. Includes trenching and backfilling. Includes Liquid and Gas Site Utilities Supplementary Components as appropriate.

100	See G30	
200	See G30	

G3060 / 21-07 30 60 / --

Site Fuel Distribution

Includes: Gas, fuel-oil, gasoline, diesel fuel, and aviation fuel distribution for a facility site or multiple facilities. Includes trenching and backfilling. Includes Liquid and Gas Site Utilities Supplementary Components as appropriate.

100	See G30	
200	See G30	

G3090 / 21-07 30 90 / --

Liquid and Gas Site Utilities Supplementary Components

Includes: Common work results for utilities and instrumentation and control to be included in liquid and gas utility elements above as appropriate.

See [General Notes](#): Supplementary Components

G40 / 21-07 40 / --

Electrical Site Improvements

Associated Masterformat Sections: 01 89 26

100	<p>Inclusions:</p> <ul style="list-style-type: none"> • Diagrammatic or schematic model elements; • conceptual and/or schematic layout; 	
-----	---	--

Unifomat / Omniclass / Uniclass

G4010 / 21-07 40 10 / --

Site Electric Distribution Systems

Description: Electrical wiring systems to distribute electrical power to on the Site. Includes Duct Banks, Pullboxes, vaults and transformers from the utility point of connection, to the building's main electric room.

Associated Masterformat Sections: 01 89 26

100	See G40	
200	Inclusions: <ul style="list-style-type: none"> Schematic layout with approximate size, shape, and location of equipment; 	
300	Inclusions: <ul style="list-style-type: none"> Design-specified size, shape, spacing, and location of equipment and associated components; Approximate allowances for clearances required for all specified supports and seismic control; Access/code clearance requirements modeled. 	
350	Inclusions: <ul style="list-style-type: none"> Actual size, shape, spacing, and location of raceways, boxes, and enclosures. Actual size, shape, spacing, and location for supports and seismic control. Actual size, shape, and location/connections of equipment and support structure/pads. Actual floor and wall penetration elements are modeled. Actual access/code clearance requirements modeled. 	

G4050 / 21-07 40 50 / Ss 70 80 25

Site Lighting

Description: Luminaires, lighting equipment, ballasts, and accessories. Includes fluorescent, high intensity discharge, incandescent, mercury vapor, neon, and sodium vapor lighting. Includes Pole Mount, Building Mount and on-grade fixtures for exterior lighting.

Associated Masterformat Sections: 26 56 29

100	See G40	
200	Inclusions: <ul style="list-style-type: none"> Schematic layout with approximate size, shape, and location of equipment; 	
300	Inclusions: <ul style="list-style-type: none"> Design-specified size, shape, and location of lighting fixtures; Approximate allowances for spacing and clearances required for all specified hangers, supports and seismic control; Access/code clearance requirements modeled. Poles 	

Send feedback to communications@bimforum.org



Copyright © 2023 BIMForum. All rights reserved.
This document is copyrighted under a [Creative Commons Attribution-NonCommercial-NoDerivatives 4.0 International License](https://creativecommons.org/licenses/by-nc-nd/4.0/).

Uniformat / Omniclass / Uniclass

G50 / 21-07 50 / Ss 75 10 Site Communications

100	Diagrammatic or schematic model elements: <ul style="list-style-type: none">conceptual and/or schematic layout;design performance parameters as defined in the BEP to be associated with model elements as non-graphic information.	
-----	--	--

G5010 / 21-07 50 10 / Ss 75 10 Site Communications Systems

Description: Conduit Systems for routing of Communication trunk systems.

Associated Masterformat Sections: 33 80 00

100	See G40	
200	See D6010.10	
300	See D6010.10	

G90 / 21-07 90 / -- Miscellaneous Site Construction

Associated Masterformat Sections: 01 89 29

G9010 / 21-07 90 10 / Ss 37 50 92 Tunnels

Includes: Vehicular, pedestrian, and service tunnels. Includes tunnel boring, bracing and jacking work, linings and casing, grouting support systems, boring machines, and control and spoil removal systems. Includes Tunnel Construction Related Activities as appropriate.

Associated Masterformat Sections: 31 70 00 / 01 89 29

See [Fundamental LOD Definitions](#)

USER GUIDE

0 Overview

0.1 Description

The *Level of Development (LOD) Specification* is a reference that enables practitioners in the AEC Industry to specify and articulate with a high degree of clarity the content and reliability of Building Information Models (BIMs) at various stages in the design and construction process.

The Specification is a detailed interpretation of the LOD schema developed by AIA Contract Documents for its *E201 2022 BIM Exhibit for Sharing Models with Project Participants* defining and illustrating characteristics of model elements of different building systems at different Levels of Development, organized according to CSI Unifomat 2010⁵. Its intent is to help explain the LOD framework and standardize its use so that it becomes more useful as a communication tool.

For Level of Development Definitions See [Fundamental LOD Definitions](#) above.

BIM as a Communication Tool

The LOD schema addresses several issues that arise when a BIM is used as a communication or collaboration tool, i.e., when someone other than the author extracts information from it:

- 1) During the design process, building systems and components progress from a vague conceptual idea to a precise description. In the past, there has been no simple way to designate where a model element is along this path. The author knows, but others often don't.
- 2) It's easy to misinterpret the precision at which an element is modeled. Hand drawings range from pen strokes on a napkin to hard lines with dimensions called out, and the precision of the drawing can be inferred from its appearance. In a model though, a generic component placed approximately can look exactly the same as a specific component located precisely, so we need something besides appearance to tell the difference.
- 3) It is possible to infer or extract information from a BIM that the author doesn't intend – unconfirmed dimensions can be measured with precision, assembly information often exists before it's been finalized, etc. In the past, this issue has been sidestepped with all-encompassing disclaimers that basically say, "Since some of the information in the model is unreliable, you may not rely on any of it." The LOD framework allows model authors to clearly state the reliability of given model elements, so the concept becomes "Since some of the information in the model is unreliable, you may only rely on it for what specifically say you can."
- 4) In a collaborative environment, where people other than the model author are depending on information from the model in order to move their own work forward, the design work plan takes on high importance – it is necessary for the model users to know when information will be available in order to plan their work. The LOD framework facilitates this.

The LOD Framework addresses these issues by providing an industry-developed standard to describe the state of development of various systems, assemblies, and components within a BIM. This standard enables consistency in communication and execution by facilitating the detailed definition of BIM milestones and deliverables.

0.1.1 LODs and Design Phase

The LODs are not defined by design phases. Rather, design phase completion, as well as any other milestone or deliverable, can be defined through the LOD language. There are several important reasons for this approach:

⁵ UniFormat™ Numbers and Titles used in this publication are from UniFormat™, published by CSI and Construction Specifications Canada (CSC), and are used with permission from CSI. For a more in-depth explanation of UniFormat™ and its use in the construction industry visit <http://www.csinet.org> or contact CSI, 110 South Union Street, Suite 100, Alexandria, VA 22314. (800) 689-2900.

- 1) There is currently no detailed standard for the design phases. Many architects have created in-house standards, but these differ from one firm to the next, and even within a single firm the requirements are sometimes adjusted to the needs of a project.
- 2) Building systems progress from concept to precise definition at different rates, so at any given time different elements will be at different points along this progression. At completion of the Schematic Design phase, for example, the model will include many elements at LOD 200, but will also include many at LOD 100, as well as some at LOD 300, and possibly even LOD 400.

0.1.2 LODs and Model Definition

There is no such thing as an “LOD ### model.” As previously noted, project models at any stage of delivery will invariably contain elements and assemblies at various levels of development. As an example, it is not logical to require an “LOD 200 model” at the completion of the schematic design phase. Instead, the “100% SD Model” will contain modeled elements at various levels of development.

0.2 Intent

0.2.1 Not a Set of Requirements

The Specification is not a set of requirements as to what is modeled when or by whom. Rather it is a language by which users can define these requirements for their own firms or projects. This clear articulation allows model authors to define what their models can be relied on for, and allows downstream users to clearly understand the usability and the limitations of models they are receiving.

To accomplish the Specification’s intent, its primary objectives are:

- 1) To help teams, including owners, to specify BIM deliverables and to get a clear picture of what will be included in a BIM deliverable
- 2) To help design managers explain to their teams the information and detail that needs to be provided at various points in the design process, and to track progress of their models
- 3) To allow downstream users to rely on specific information in models they receive from others.
- 4) To provide a standard that can be referenced by contracts and BIM execution plans.

0.2.2 Complements a BIM Execution Plan (BEP)

This Specification does not replace a project BEP, but rather is intended to be used in conjunction with such a plan, providing a means of defining models for specific information exchanges, milestones in a design work plan, and deliverables for specific functions.

0.3 Background

0.3.1 AIA Effort

In 2008, the AIA published its first set of Level of Development definitions in AIA Document *E202™-2008 Building Information Modeling Protocol*. Due to the rapidly evolving nature of the use of BIM, the AIA evaluated the *E202-2008*, including the LOD definitions. The result is the updated and reconfigured Digital Practice documents, *AIA E203™-2013, Building Information Modeling and Digital Data Exhibit*, *AIA G201™-2013, Project Digital Data Protocol Form*, and *AIA G202™-2013, Project Building Information Modeling Protocol Form*, which are accompanied by a detailed guide document entitled *Guide and Instructions to the AIA Digital Practice Documents*. The AIA’s updated Digital Practice documents include revised LOD definitions.

0.3.2 BIMForum Effort

In 2011 the BIMForum initiated the development of this LOD Specification and formed a working group comprising contributors from both the design and construction sides of the major disciplines. To help further the standardization and consistent use of the LOD schema, and to increase its usefulness as a foundation for collaboration, the AIA licensed the BIMForum to utilize its latest LOD definitions in this Specification. The BIMForum working group first interpreted the AIA’s basic LOD definitions for each building system, and then compiled examples to illustrate the interpretations. Because BIM is being put to an ever-increasing number of uses, the group

Send feedback to communications@bimforum.org



Copyright © 2023 BIMForum. All rights reserved.
This document is copyrighted under a [Creative Commons Attribution-NonCommercial-NoDerivatives 4.0 International License](https://creativecommons.org/licenses/by-nc-nd/4.0/).

decided that it was beyond the initial scope to address all of them. Instead, the definitions were developed to address model element geometry, with three of the most common uses in mind – quantity take-off, 3D coordination and 3D control and planning. The group felt that in taking this approach the interpretations would be complete enough to support other uses.

1 Using the Specification

1.1 Details

1.1.1 Order of Precedence

The body of this Specification expands on the Fundamental Definitions as they apply to specific building systems and sub-systems. In the event of any conflict, more specific expansions take precedence over less specific expansions and Fundamental Definitions, e.g. the expanded definitions for C1010 take precedence over those for C10, which in turn take precedence over the Fundamental Definitions.

1.1.2 LOD Definitions as Minimum Requirements

The LODs provide five snapshots of the progression of an element from conceptual to specified – there are many steps in this progression between the defined LODs. The LOD definitions, then, should be considered minimum requirements – i.e. an element has progressed to a given LOD only when all the requirements stated in the definition have been met.

1.1.3 LOD Definitions are Cumulative

For a given element each LOD definition includes the requirements of all previous LODs. Thus, for an element to qualify for LOD 300 it must meet all the requirements for 200 and 100 as well as those stated in the LOD 300 definition.

1.1.4 Model Element Author

This document does not prescribe who the author of a particular component at a given LOD should be – the sequence of responsibility for modeling various systems will vary from one project to another. To accommodate this variation this document defers to the concept of Model Element Author (MEA) as defined in the *AIA E203-2013*: “The Model Element Author is the entity (or individual) responsible for managing and coordinating the development of a specific Model Element to the LOD required for an identified Project milestone, regardless of who is responsible for providing the content in the Model Element.”⁶

1.1.5 2D Supplementary Drawings

In current practice models are often supplemented with 2D information such as detail drawings. This Specification does not address this supplementation, but rather deals only with what is modeled in 3D and non-graphic information associated with the modeled elements.

1.2 Project-Specific Information

As mentioned in the Overview above, this Specification is intended to be used in conjunction with a project BIMXP. Many information needs will vary from project to project, even for identical elements. This kind of information is therefore not included in the LOD definitions specified here, but rather is left to be addressed in individual BIMXPs. The following are some notable examples.

1.2.1 Size Thresholds

In most projects, a determination is made to model certain elements only if they are over a specified size – e.g. conduit less than 1/2” (10 mm) diameter is not modeled. These size thresholds do not consistently correspond to certain LODs, and they vary from project to

⁶ AIA Document *E203-2013 Building Information Modeling and Digital Data Exhibit*, Article 1.4.6. Copyright © American Institute of Architects 2013. All rights reserved. Definition quoted here by permission.

project. Thus, they are not specified in the LOD definitions but rather in the project's BIMXP, for example using the "Notes" cells in the Model Element Table of the AIA G202-2013.

1.3 Using the Specification with a BEP

Most BEPs include a section that details milestones as well as information exchanges – models to be produced to exchange specific information at specific points in a specific BIM use. In most cases, though, current practice is to accompany these models with the common "for reference only" disclaimer, diluting the effectiveness of the exchange. Referencing this Specification in the BIMXP and using it to concisely define the milestone and information exchange models brings many efficiencies to the process – among them:

1.3.1 Reliance

As noted above (see "BIM as a Communication Tool"), a major problem with allowing others to rely on a BIM is that it can contain information the author doesn't intend. By defining a model through the LOD Specification the author can limit reliance to only what he/she specifically states.

1.3.2 Multiple uses

Much model information is common across several information exchanges. This Specification facilitates the definition of models that will support multiple exchanges.

1.3.3 Efficient sequencing

The development of models as the design and construction process progresses follows logical sequences – much information depending on the prior development of other information. The definition of milestones, information exchanges, and other deliverables through this Specification facilitates the orderly sequencing of models to align with efficient development of information.

1.3.4 Avoidance of over-modeling

The LOD Specification facilitates the application of a pull-planning process to the modeling effort, limiting the development of model elements and information to that which the team identifies as useful.

Note that the definition and sequencing of models usually cannot be set in stone when the BIMXP is first developed. In most cases the modeling plan must evolve as the project progresses.

1.4 Implementation of the Specification

Currently, two methods of implementation have been developed.

1.4.1 Rely on the Model Element Table

Project team refers to a Model Element Table such Article 3.3 of the AIA G202-2013 or Part II of this Specification for the LODs of model elements. In this method, all elements referred to in a given Model Element Table line item are assumed to be at the LOD stated there. E.g. if the table lists interior doors as LOD 200 for a given model, all interior doors within the model are assumed to be at LOD 200.

1.4.2 Include LOD Designations as Attributes of Individual Model Elements

All elements within the model are provided with two attributes – Current LOD (the actual LOD of the element) and Target LOD (the LOD specified for that element in the Model Element Table). Elements default to a Current LOD of 100 or 200 as appropriate, and this attribute is elevated as the element is more fully developed. This method offers more flexibility and reliability, allowing differentiation between individual elements within a single model element table line item. Several software offerings provide the functionality of highlighting elements of various LODs or elements whose Current LOD is less than the Target LOD.

2 ORGANIZATION OF THE SPECIFICATION

2.1 Geometric and Attribute Information

To facilitate use of this Specification Attachment 1, Model Development Specification (MDS) has been provided. This attachment is a set of spreadsheets that can be used to collect and correlate LOD Information for a specific project.

A model element can contain two types of information: a) the element's geometry and b) associated numeric and/or textual attributes. To address these types of information this Specification contains two parts:

2.1.1 Part I: Element Geometry

Part I consists of narrative descriptions and illustrations of specific model elements at each LOD. Part I forms the bulk of this document.

2.1.2 Part II: Associated Attribute Information

Part II is contained in Attachment 1, a workbook that begins with the Model Element Table which mirrors the layout of the Model Element Table in the AIA G202-2013 Building Information Modeling Protocol Form, and can be referenced by that document. The Model Element Table references Attribute Tables that contain attribute information for various building systems.

2.1.3 Model Element Table

UniFormat Level	Use on this Project	Building Systems	Relevant Attribute Tables	SD			DD			CD			Estimating Est. 1			Estimating Bid Pkg.			LEED Cert. Check			LEED Cert. Submittal			
				Date	LOD	MEA	Notes	Date	LOD	MEA	Notes	Date	LOD	MEA	Notes	Date	LOD	MEA	Notes	Date	LOD	MEA	Notes	Date	LOD
A	10	Substructure																							
A	10	Foundations	A, B Concrete; A, B Wood; A, B Masonry; A, B Precast Concrete																						
A	10	Standard Foundations	A, B Concrete; A, B Wood; A, B Masonry; A, B Precast Concrete																						
A	10	Wall Foundations	A, B Concrete; A, B Wood; A, B Masonry; A, B Precast Concrete																						
A	10	Column Foundations	A, B Concrete; A, B Wood; A, B Masonry; A, B Precast Concrete																						
A	10	Special Foundations	A, B Concrete; A, B Wood; A, B Masonry; A, B Precast Concrete																						
A	10	Grade Beams	A, B Concrete; A, B Wood; A, B Masonry; A, B Precast Concrete																						
A	20	Subgrade Enclosures	A, B Concrete; A, B Wood; A, B Masonry; A, B Precast Concrete																						
A	20	Walls for Subgrade Enclosures	A, B Concrete; A, B Wood; A, B Masonry; A, B Precast Concrete																						
A	40	Slabs-on-Grade	A, B Str. Concrete																						
A	40	Standard Slabs-on-Grade	A, B Concrete																						
A	40	Structural Slabs-on-Grade	A, B Concrete																						
B	10	SHELL																							
B	10	Floor Construction	A, B Cold Formed Metal Framing; A, B Masonry; A, B Metal Deck; A, B Precast Concrete; A, B Steel Joist; A, B Structural Steel; A, B Concrete; A, B Wood																						
B	10	Floor Structural Frame																							
B	10	Concrete	A, B Concrete																						
B	10	Masonry	A, B Masonry																						

Figure 1. Model Element Table

2.1.4 Building Systems

The rows of the Model Element Table (Figure 1) are building elements listed in accordance with CSI Unifomat 2010. The table also lists Relevant Attribute Tables for each system, referring to the tabs containing attribute information for the associated system(s). If desired, users can add Attribute Tables for specific line items.

2.1.5 Milestones/Deliverables

The table includes columns for defining the LODs for various milestones within a project. Each milestone column has three sub-columns: Level of Development (LOD), Model Element Author (MEA), and Notes. The table in Attachment 1 shows standard milestones for the completion of the traditional design phases as well as examples of Project-Specific Milestones for interim reviews, specific

deliverables, BIM-Use information exchanges, etc. Users are encouraged to modify and add to these milestones as necessary. Once the milestones for a project have been determined, they can be re-ordered into a logical sequence as in Figure 2.

UniFormat Level	1	2	3	4	Use on this project	Relevant Attribute Tables	SD			Estimating Est. 1			DD			LEED Cert. Check			CD			Estimating Bid Pkg.			LEED Cert Submittal		
							Date	LOD	MEA	Notes	Date	LOD	MEA	Notes	Date	LOD	MEA	Notes	Date	LOD	MEA	Notes	Date	LOD	MEA	Notes	Date
SUBSTRUCTURE																											
A	10					Foundations	A, B Concrete; A, B Wood; A, B Masonry; A, B Precast Concrete																				
A	10	10				Standard Foundations	A, B Concrete; A, B Wood; A, B Masonry; A, B Precast Concrete																				
A	10	10	.10			Wall Foundations	A, B Concrete; A, B Wood; A, B Masonry; A, B Precast Concrete																				
A	10	10	.30			Column Foundations	A, B Concrete; A, B Wood; A, B Masonry; A, B Precast Concrete																				
A	10	20				Special Foundations	A, B Concrete; A, B Wood; A, B Masonry; A, B Precast Concrete																				
A	10	20	.80			Grade Beams	A, B Concrete; A, B Wood; A, B Masonry; A, B Precast Concrete																				
A	20					Subgrade Enclosures	A, B Concrete; A, B Wood; A, B Masonry; A, B Precast Concrete																				
A	20	10				Walls for Subgrade Enclosures	A, B Concrete; A, B Wood; A, B Masonry; A, B Precast Concrete																				
A	40					Slabs-on-Grade	A, B - Str. Concrete																				
A	40	10				Standard Slabs-on-Grade	A, B Concrete																				
A	40	20				Structural Slabs-on-Grade	A, B Concrete																				
B	10					SHELL																					
B	10	10				Superstructure Floor Construction	A, B Cold Formed Metal Framing; A, B Masonry; A, B Metal Deck; A, B Precast Concrete; A, B Steel Joist; A, B Structural Steel; A, B Concrete; A, B Wood																				
B	10	10	.10			Floor Structural Frame																					
B	10	10	.10			Concrete	A, B Concrete																				
B	10	10	.10			Masonry	A, B Masonry																				

Figure 2. Adding Milestones/Deliverables to the Model Element Table

2.1.6 Attribute Tables

A	B	C	D	E	F	G	H	I	J	K	L	M	N	O
B - Ext. Wall														
1	Baseline This work is licensed under the Creative Commons Attribution-NonCommercial 4.0 International License													
2	Additional Attribution-NonCommercial 4.0 International License													
3	Part 1 - Attribute Description													
4	Part 2 - Project-Specific Milestones (Examples)													
5	Attribute	Data Type	Units - Imp.	Units - Metric	Option Examples	Commentary	Estimating Est. 1	Estimating Bid Pkg.	LEED Cert. Check	LEED Cert Submittal				
6	Construction	Text			framed, unit masonry, paneled, EIFS, etc.									
7	Material - Skin	Text			tiles, composite, sheet metal, etc.									
8	Material - Substrate	Text			corrugated metal, plywood, composite panels, etc.									
9	Material - Insulation	Text												
10	Wall Type	Text												
11	Thermal Resistance	Number	R: h-ft ² -°F/Btu	m ² /C/W										
12	Thermal Transmittance	Number	U: Btu/(h-ft ² -°F/Btu)	W/(m ² ·C)										
13	Target LOD	Number	LOD #	LOD #	100, 200, 300, 350, 400									
14	Current LOD	Number	LOD #	LOD #	100, 200, 300, 350, 400									
15	Wind Load Capacity (drag)	Number	psf	Pa										
16	Wind Load Capacity (pressure)	Number	psf	Pa										
17	Fire Rating	Text			options: [UL label - A,B,C,D,E,S]									
18	Impact resistance	Text			options: [T/F, class]									
19	UV Resistance	Text			options: [T/F, class]									
20	Air Infiltration	Text			options: [T/F, class]									
21	Sound Transmission	Text												
22	Acoustic Rating	Text												
23	Security Rating	Text												
24	Glazing Area	Number	ft ²	m ²		Fraction of the glazing area relative to the total area of the filling element.								
25	Combustible	Logical			T/F	Indicates whether the object is made from combustible material.								
26	Surface Spread of Flame	Text												
27	isExternal	Logical			T/F	Should be set to TRUE for all external walls.								
28	Shop Submittal Parameters:													
29	Date - Issued For Construction	Date Time	yyyy-mm-ddThh:mm	yyyy-mm-ddThh:mm		{DateIFC}								
30	Date - Permitted	Date Time	yyyy-mm-ddThh:mm	yyyy-mm-ddThh:mm		{DatePermitted}								
31	Date - received for Shop Detailing	Date Time	yyyy-mm-ddThh:mm	yyyy-mm-ddThh:mm		{DateReceivedForShopDet}								
32	Date - Detailing Submitted for EOR review \ Out For Approval	Date Time	yyyy-mm-ddThh:mm	yyyy-mm-ddThh:mm		{DateOutForApproval}								
33	Date - Final Erection Drawings Approved for Fab	Date Time	yyyy-mm-ddThh:mm	yyyy-mm-ddThh:mm		{DateFinalForFab}								
34	Date - Fabrication Start	Date Time	yyyy-mm-ddThh:mm	yyyy-mm-ddThh:mm		{DateFabStart}								
35	Date - Fabrication End	Date Time	yyyy-mm-ddThh:mm	yyyy-mm-ddThh:mm		{DateFabEnd}								
36	Date - Fabrication Shipped	Date Time	yyyy-mm-ddThh:mm	yyyy-mm-ddThh:mm		{DateFabShip}								
37	Date - Fabrication Received	Date Time	yyyy-mm-ddThh:mm	yyyy-mm-ddThh:mm		{DateFabReceived}								
38	Date - Erection	Date Time	yyyy-mm-ddThh:mm	yyyy-mm-ddThh:mm		{DateErected}								
39	Date - Inspected	Date Time	yyyy-mm-ddThh:mm	yyyy-mm-ddThh:mm		{DateInspected}								

Figure 3. Typical Attribute Table

2.1.7 Attribute Table Anatomy

Attribute Tables consist of two parts.

- 1) Part 1, Attribute Description, lists Attributes relevant to the associated building system(s).
 - Attributes are grouped into two categories as shown – Baseline and Additional.

Send feedback to communications@bimforum.org



- The Baseline is the suggested list of attributes to be populated when no other requirements are known (BIM Uses, specific deliverables, etc.).
- The Additional category may be thought of as a “shopping list” – a list of possible attributes the team may want to consider.
- Data Types. For simplicity, the published Attribute Tables use only the following data types, but users setting up data for use in specific software may want to add others.

Text	An alphanumeric string not intended for use in calculations. E.g. room numbers are often considered text (even where they only contain numbers) since the numbers are not useful for calculations.
Number	A numerical value that can be entered directly into a program that will use it as input to calculations. Note that no distinction is made here between integers and real numbers.
Logical	Boolean in computer science terminology. A binary yes/no indication. Values for this type can be T or F, 1 or 0.
Date	ISO format is used in these tables: yyyy-mm-dd
Time	ISO format is used in these tables: hh:mm:ss
Datetime	ISO format is used in these tables: yyyy-mm-ddThh:mm:ss

- 2) Part 2, Milestones, is used to mark the attributes required for specific milestones and deliverables. The tables in Attachment 1 include example milestones, but users will customize the tables by copying the milestones they created for the Model Element Table.

2.1.8 MEPF Attribute Tables

The MEPF attribute tables use a somewhat different format than other sections, since components from multiple systems might be used to make up a specific element. For example, an air handler is primarily a D30 HVAC element, but can include plumbing, fire protection and electrical elements as well.

The MEP Systems tabs are grouped into two types:

- System component elements: D20 Plumbing, D30 HVAC, D40 Fire Protection and D50 Electrical.
- System distribution elements such as ducts, pipes, and cables: D Air Distribution, D Fluid Gas Distribution and D Electrical Distribution.

MEPF attribute tables are broken down into two main sections

- Global: Attributes that are common to all elements within the table
- Item-Specific: The suggested set of additional attributes that are specific to an individual type of element. In many tables, the Individual elements are organized into a hierarchy of classes and sub-classes. In these cases, the attributes applicable to a specific element include those listed for the element itself plus those listed in any of the classes above it in the hierarchy. E.g. as Figure 4 shows, the attributes for an oil meter include all those shown in bold.

Note: System Component elements use both the Global and Item-Specific attributes sections, while System Distribution elements use only the Item-Specific attribute section.

*Figure 4. MEPF
Attribute Table
Breakdown Structure*

2.1.9 Using the Attribute Tables

There are many ways to use the Attribute Tables – three are shown here.

- 1) Project teams adopt the Baseline attribute lists. The pre-populated correlation between Attributes and LODs represents current practices of proficient BIM users in the AEC industry.
- 2) Project teams create a custom correlation between LODs and Attribute population requirements. In this case the project team would edit the LOD Profile section to reflect the specific requirements of the project.
- 3) Project teams create new, project specific milestones and define Attribute population requirements in the Milestones sections. This approach will give project teams the greatest flexibility for defining Attribute population requirements.

Note that the element attribute author can be entered in the LOD profile instead of an “x” to indicate who is responsible for providing the information.