

# TRAMPOLINE USER MANUAL

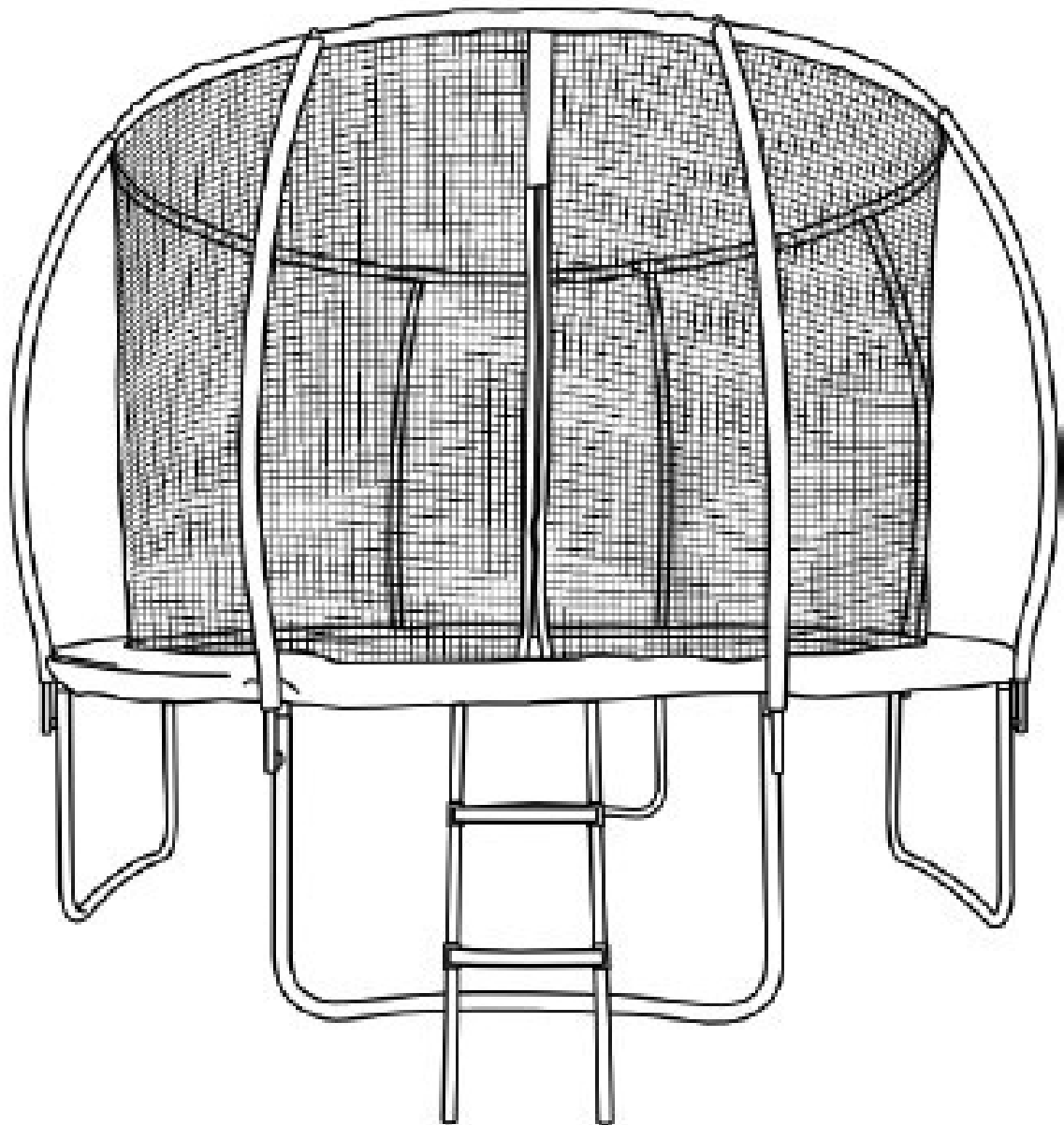



# THANK YOU FOR PURCHASING



We are grateful for trusting us with your new sports equipment.  
We are committed in creating the most refined choice of outdoor  
collection.

## CUSTOMER SERVICE

For questions and support please contact us at:

SUPPORT@GIDDYUPPRO.COM  
SARAH@GIDDYUPPRO.COM

## PREMIUM EXTENDED WARRANTY

For upgrading your Warranty to Premium 24 months  
just register your new product on  
[www.giddyuppro.com/warranty](http://www.giddyuppro.com/warranty).

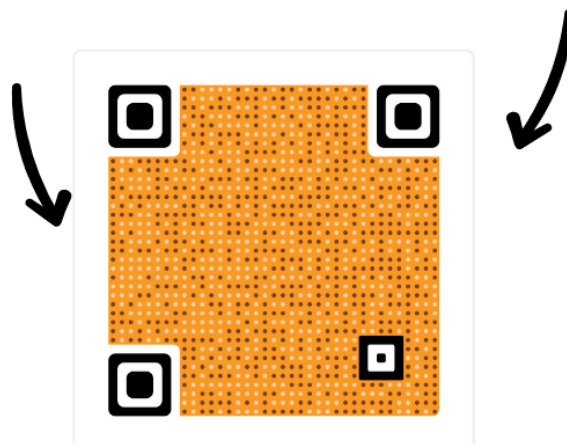

# DISCLAIMER

Please read the instructions before starting the installation process. Incorrect installation might damage the trampoline and cause serious injuries!

ADULT SUPERVISION & GUIDANCE ARE REQUIRED AT ALL TIMES.

- Max user weight limit: check size chart
- Not suitable for children under 36 months – small parts, choking hazard.
- The trampoline must be set up by an adult following the instructions.
- The trampoline is intended for outdoor use only.
- Always zip up the net before jumping.
- Take shoes off while jumping.
- Empty pockets and hands before jumping.
- Always jump in the middle of the mat.
- Do not eat while jumping. It is advisable not to bounce immediately after a meal.
- Only use the step ladder to climb in or get out of the trampoline.
- Do not use in strong wind conditions.

# ADVISORY

Recommended age 6+ years.

- DO NOT bury the trampoline in the ground.
- Place the trampoline on a leveled surface, at least 2m from any structure or obstructions (fence, garage, house, overhanging branches, electrical wires).
- Do not install the trampoline over concrete, asphalt, or any other hard surface.
- Do not install in the proximity of pools, swings, slides, or climbing frames.
- Any modifications made by the consumer to the original trampoline shall be carried out according to the instructions of the manufacturer.
- Inspect the trampoline net before every use.
- Make sure there are no children/ animals/ obstructions underneath the trampoline. Use the designed access points to climb in & out of the trampoline.
- Make sure the net is securely zipped before bouncing.
- Don't intentionally jump against the protection net as this will weaken it.
- Always jump in the middle of the mat and practice bounce techniques safely with adult supervision and guidance.



# GIDDY UP!



Make sure to properly run a complete check-up of the trampoline (main parts, frame, suspension system, mat, padding, net) at the beginning of each season and every 2 weeks!



Always supervise children while jumping. Make sure the safety net is securely closed.



Check all nuts and bolts for tightness and tighten when required. Make sure all sharp edges are properly covered. Replace covers when needed.



Do not jump with sharp object in your hands or pockets. Always take shoes off. Do not drink eat or smoke while using the trampoline.



Make sure the trampoline is securely lodged to the ground especially during strong wind conditions (e.g. steel bars in the ground or loads like sandbags or water bags). **DO NOT INSTALL** on uneven terrain.



Do not jump from high ledges into the trampoline. Do not attempt dangerous tricks.



Sunlight, rain, snow, and high temperatures reduce the strength of some parts over time. Cover the trampoline if not used for long periods of time.



Do not use the trampoline if there are obstructions underneath the jumping mat.



Trampoline and net should be packed away in winter. Make sure all parts are dry and packed securely



Do not exceed weight limit!

# PART LIST



8FT





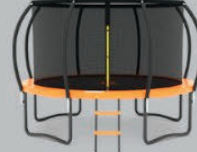



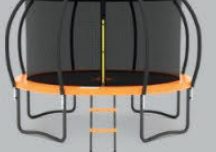





10FT

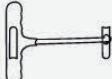

12FT



14FT

			8FT	10FT	12FT	14FT
<b>A</b>		Frame Cover	2pc	2pc	2pc	4pcs
<b>B</b>		Jumping Mat	1pc	1pc	1pc	1pc
<b>C</b>		Frame	6pc	8pc	8pc	8pc
<b>D</b>		Steel T-Connector	6pc	8pc	8pc	8pc
<b>E</b>		Spring	48pc	64pc	72pc	80pc
<b>F</b>		Leg Extension	6pc	8pc	8pc	8pc
<b>G</b>		W Shaped Leg	3pc	4pc	4pc	4pc
<b>H</b>		Spring Tool T-Hook	2pc	2pc	2pc	2pc
<b>I</b>		Bottom Pole	6pc	8pc	8pc	8pc
<b>J</b>		Upper Pole	6pc	8pc	8pc	8pc
<b>K</b>		Long Screw	12pc	16pc	16pc	16pc
<b>L</b>		Nut	12pc	16pc	16pc	16pc
<b>M</b>		Plastic Pad	12pc	16pc	16pc	16pc



8FT











10FT

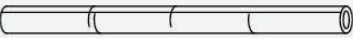

12FT



14FT

			8FT	10FT	12FT	14FT
<b>N</b>		Enclosure Net	1pc	1pc	1pc	1pcs
<b>O</b>		Fiberglass Stick	6pc	8pc	8pc	8pc
<b>P</b>		T-Connector	6pc	8pc	8pc	8pc
<b>Q</b>		Pole Foam	12pc	16pc	16pc	16pc
<b>R</b>		Wrench	1pc	1pc	1pc	1pc
<b>S</b>		Screw Nut	12pc	16pc	16pc	16pc
<b>T</b>		Ladder Pipe	2pc	2pc	2pc	2pc
<b>U</b>		Ladder Steps	2pc	2pc	2pc	2pc
<b>V</b>		Ladder Screw	4pc	4pc	4pc	4pc
<b>W</b>		Ladder Nut	4pc	4pc	4pc	4pc

# CONGRATULATIONS!

6

However, certain parts require some force to be put together correctly and should be handled by adults.

## Frame and Legs

### STEP 1

Insert the Leg Extension (F) into the W-Shaped Legs (G). Make sure the bumps are aligned with the holes in the bars and stick out through them completely. Bumps should face back and front.

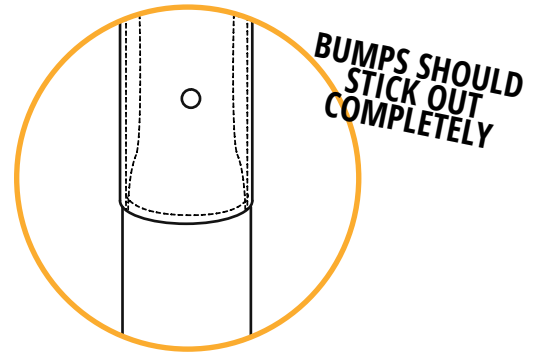
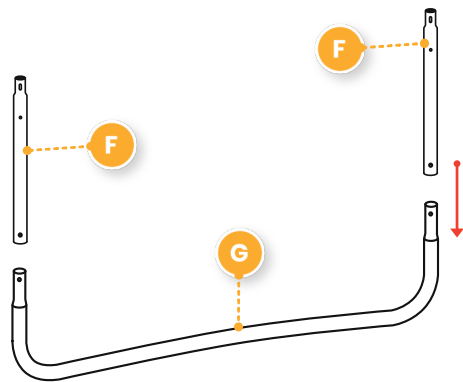

### STEP 2

Attach The Frame (C) to T-Connectors (D). Continue until you form the circle.

Tip: Have a second person or use a wall to apply some resistance against the frame to help it shift into place.

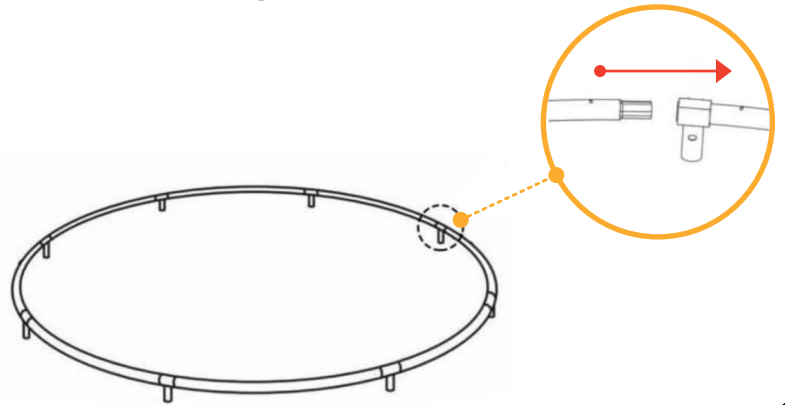
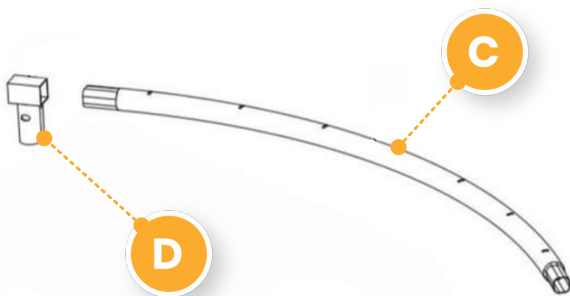

### STEP 3

Two people will be necessary at this point to install the trampoline. One person lifts up the circle frame, while the other lifts the W shaped leg tubes to a standing (vertical) position and inserts the Steel T-Connectors (D) into a W-Shaped Leg tube. Ensure the locking holes are aligned.

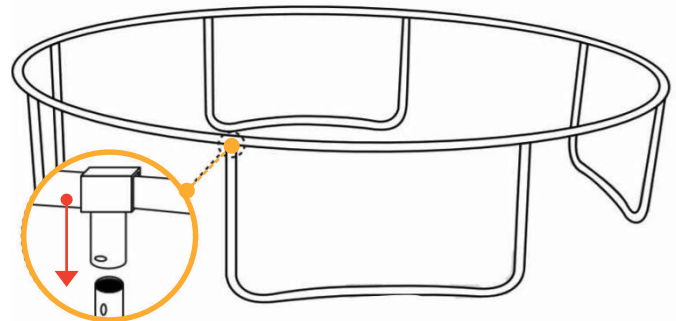
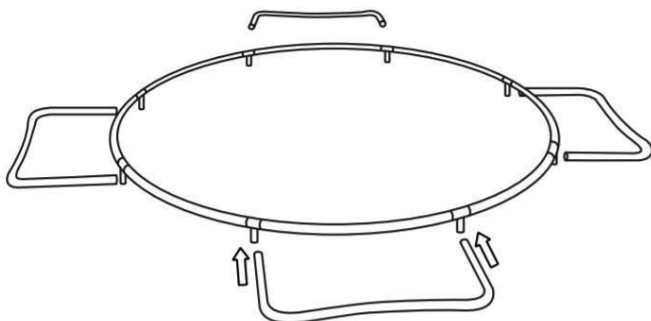



# Jumping Mat

7

## STEP 4

Layout the jumping mat (B) inside the circle frame. Make sure the Jumpzylla logo is facing UP. Insert one end of the spring (E) in the triangle ring of the jumping mat (B) and the other end pull it with the spring tool (H) and insert it into the frame hole.

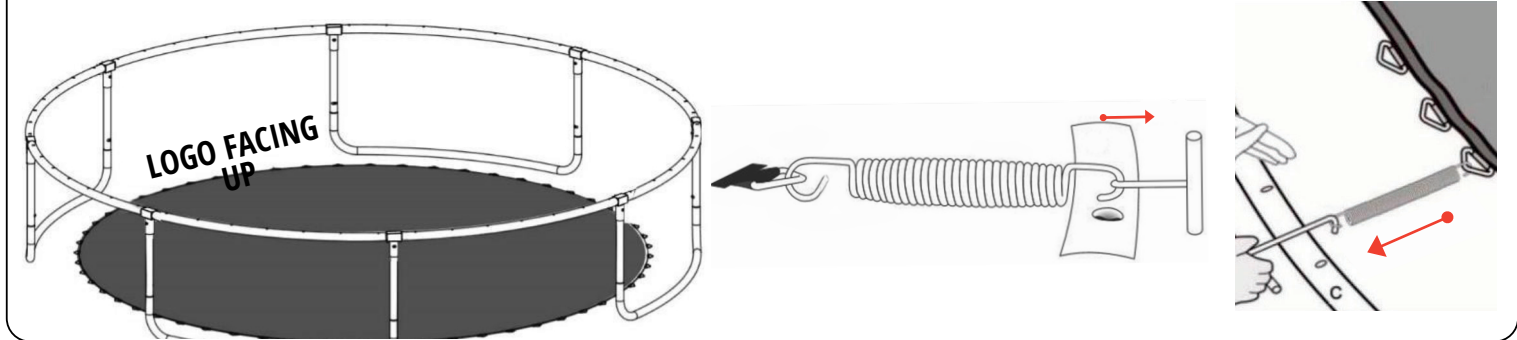

## STEP 5

Start installing the springs in an X shape. The tension needs to be distributed evenly for the net to be installed correctly. Gently tap down against the spring if the hook is not completely in the hole. Springs will create high levels of tension when assembled. Please take care not to pinch your fingers.

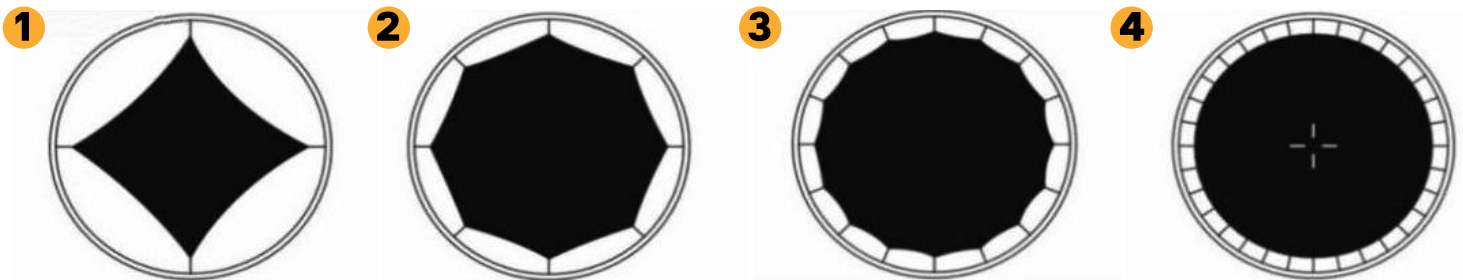

# Pole & Net Installation

## STEP 6

Firmly fix the bottom pole (I) to the plastic pad (M) then insert a long screw (K) through the pole, plastic pad, and leg extension then secure it at the end with a nut (L). Then insert the Upper Pole (J) into the Bottom Pole (I).

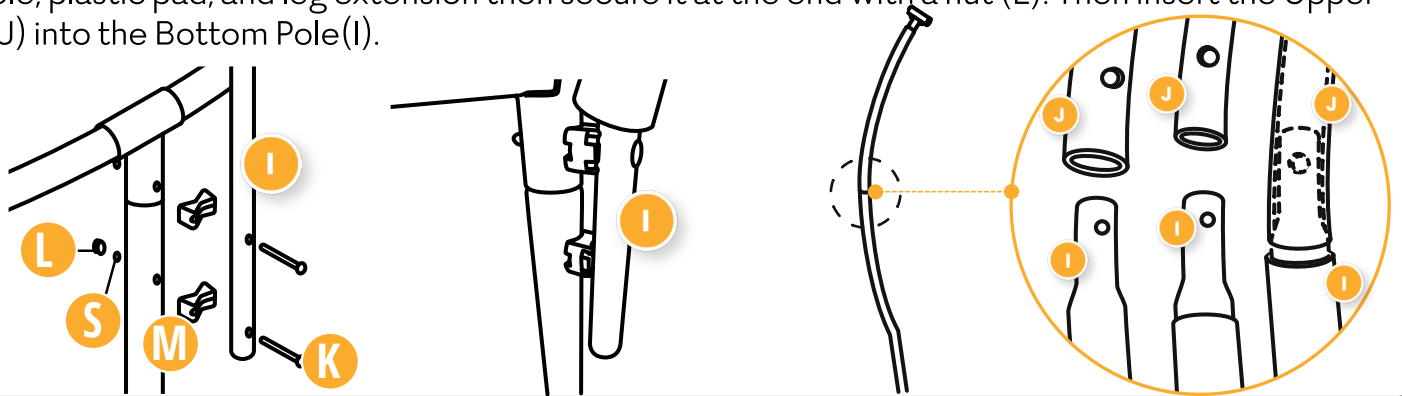

## STEP 7

Insert the Plastic T-Connector (P) into the top of the upper pole (bumps should face left and right). Press down with your fingers on the bumps on each side of the T-Connector. Make sure the cylinders are securely installed (the T-Connector bumps should stick out through the pole holes).

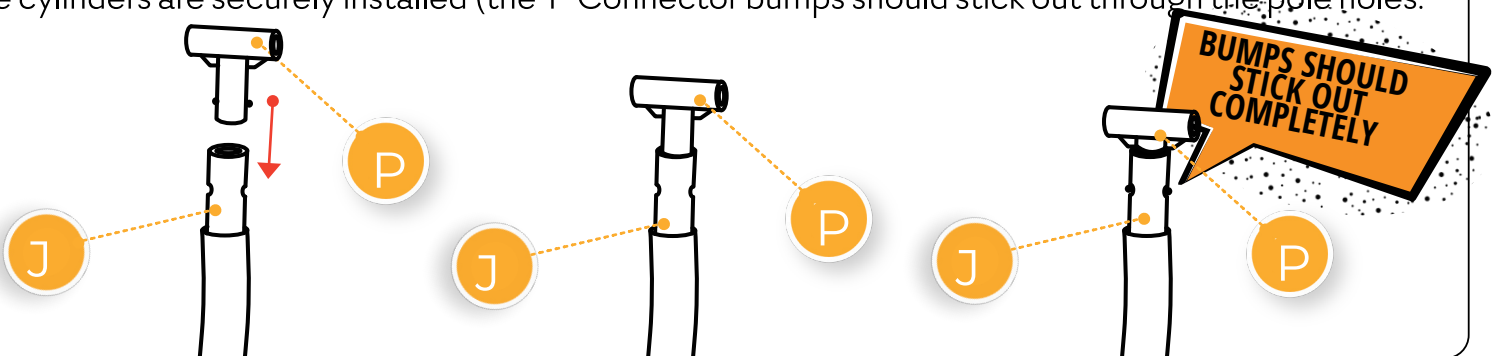

## STEP 8

Insert the fiberglass stick through the designed area in the safety net and connect it to the T-Connector.

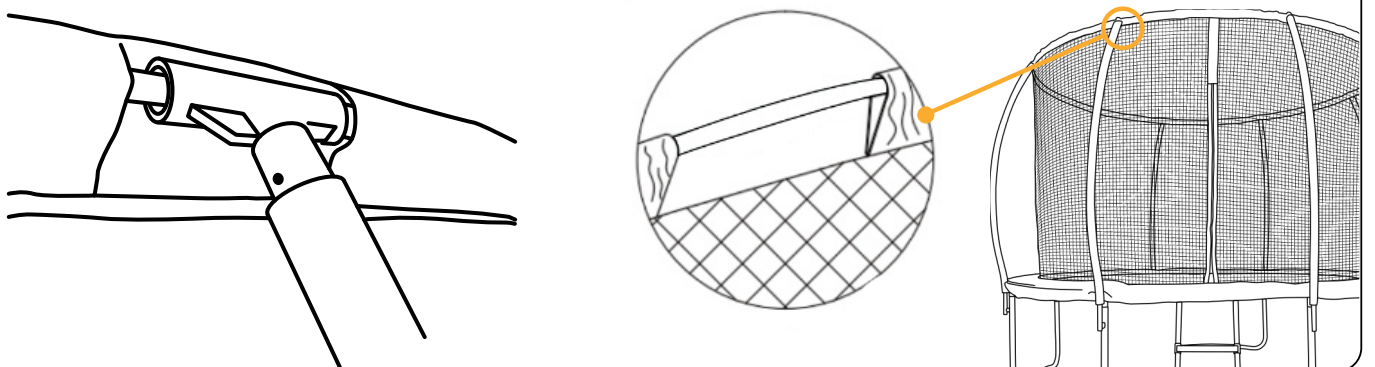

## TIP



You can connect all the fiberglass sticks through the safety net and to the T connectors until you have a circle. After this, you can insert all the T-Connectors into the Pole. 2 people are needed.

**STEP 9**

Pass every strip of the safety net through the metal triangles of the springs and secure it with the snap hook around the next triangle on the left. Continue in the same way. When you secure the clip make sure to pass it through the loops of the net.

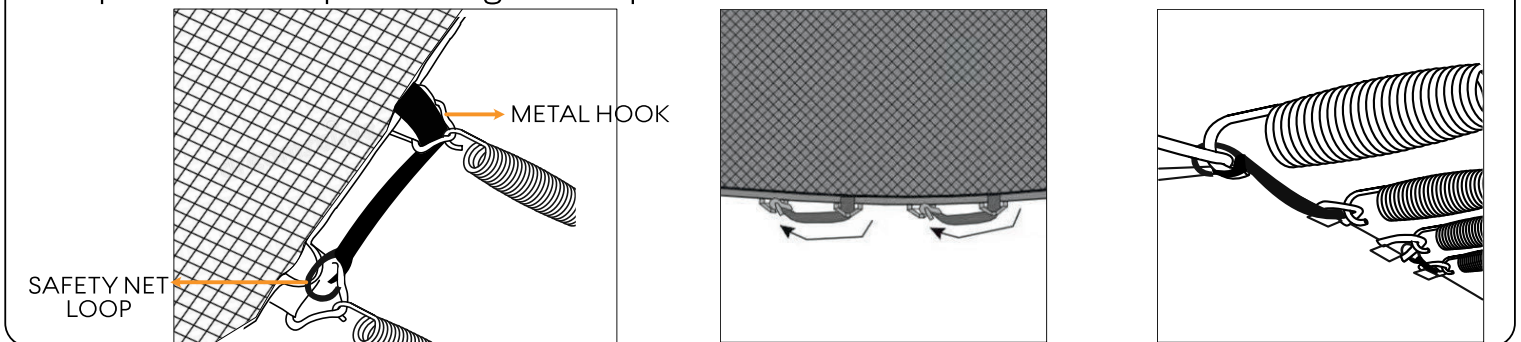
**STEP 10**

Cover the spring frame with the soft padding Frame Cover (A). Secure the padding parts together using the Velcro on each side, and tie the straps located underneath. Lay down the Frame Cover (A) so all the springs are covered. It should be fitted like a shower cap. Make sure it covers all metal parts.

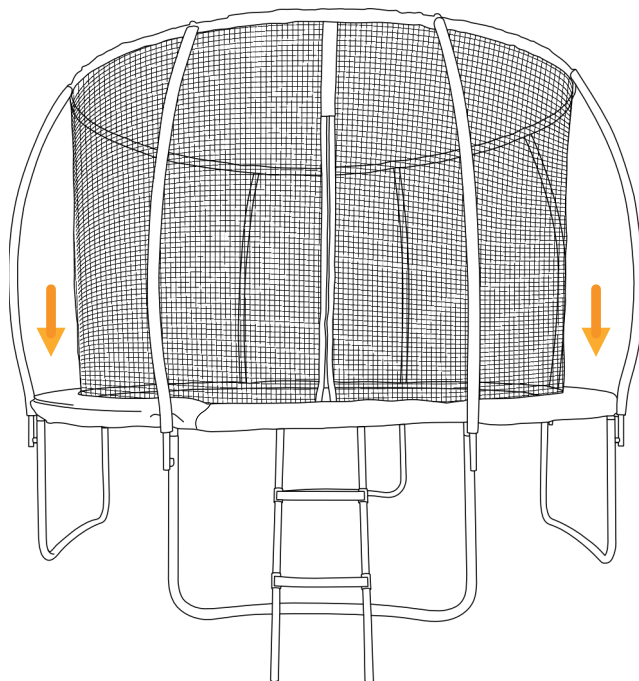
**ATTENTION**

If the thread is not correctly installed it might stop the zipper from closing properly. Please make sure the thread goes all around the net and is securely tightened.

## STEP 11

Align the two Ladder Pipes (T) and slide up the Steps one by one (U). Secure with the screws (V) and Ladder Nuts (W).

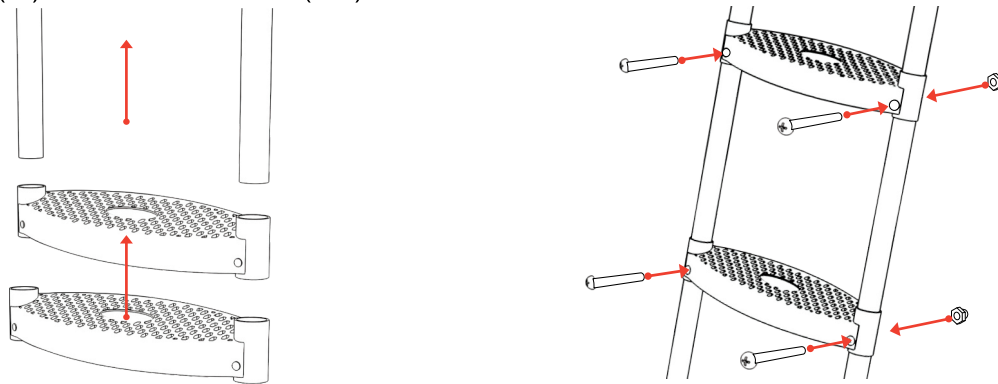

## STEP 12

Hook the step ladder to the Metal Frame (C) of the trampoline under the Frame Cover (A). Installation is complete and now you can enjoy your new Jumpzylla Trampoline. HAVE FUN!

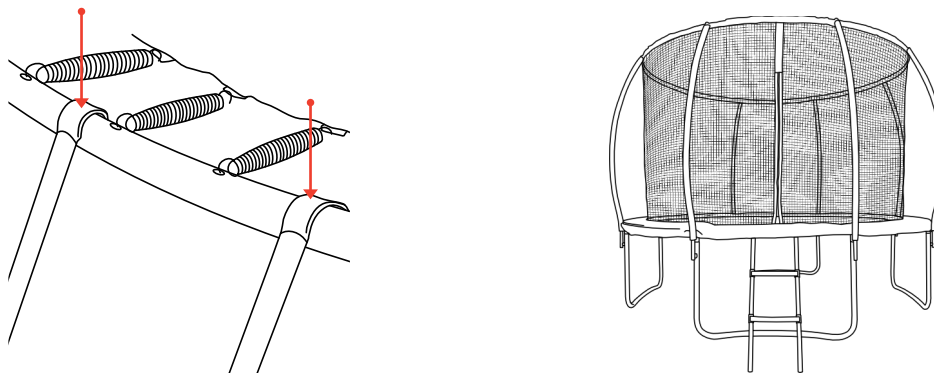



## WHAT'S IN THE BOX

- ✓ 1 TRAMPOLINE
- ✓ 1 LADDER
- ✓ 4 WIND STAKES
- ✓ 2 SPRING MOUNTING TOOLS
- ✓ 1 OWNER'S MANUAL

## WARRANTY POLICY

### Default 12-Month Warranty

This product is covered by GIDDY UP! Default Warranty for 12 months from the purchase date.

For upgrading your Warranty to Premium 24 months just register your new product on [www.giddyuppro.com/warranty](http://www.giddyuppro.com/warranty).

## PREMIUM EXTENDED WARRANTY

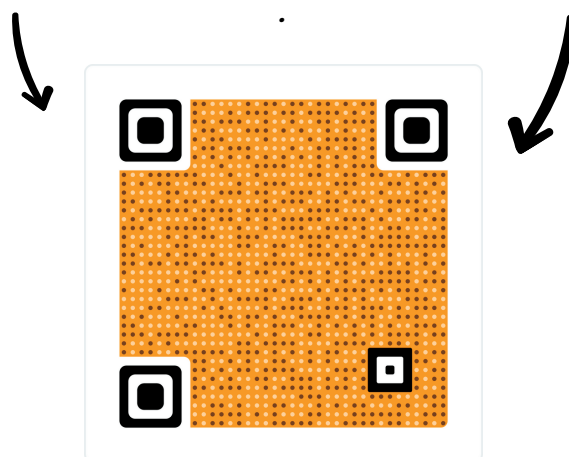

**PREMIUM EXTENDED WARRANTY**



