

BARE FLOOR CLEANING

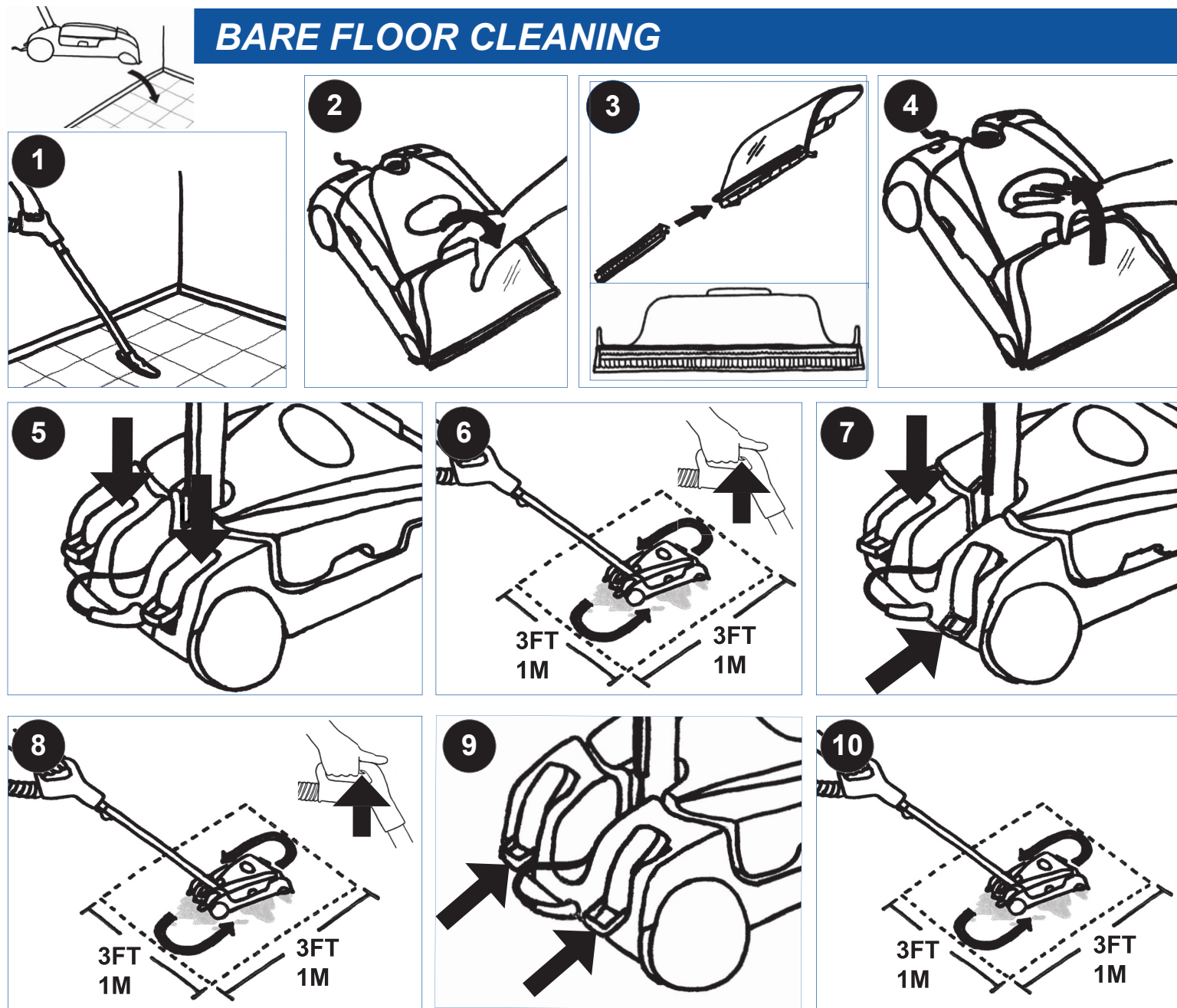

CLEANUP AND STORAGE

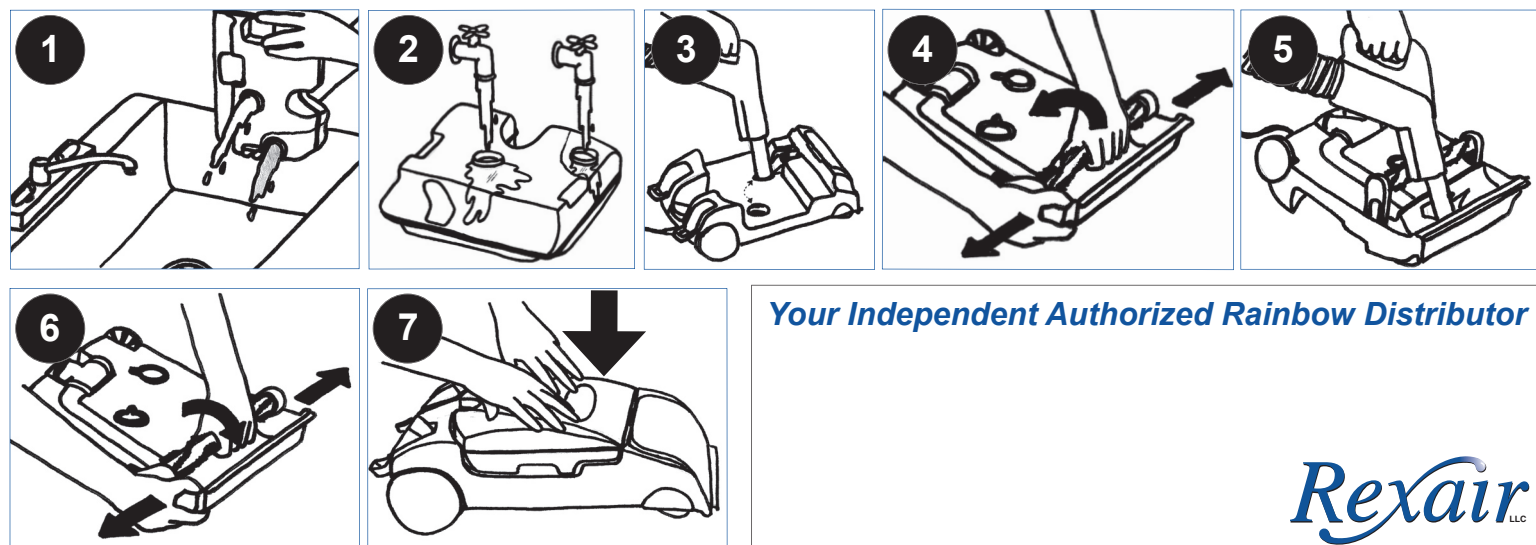

Your Independent Authorized Rainbow Distributor

Rexair^{LLC}

R13312A-0
©Rexair 2007

AquaMate[®]

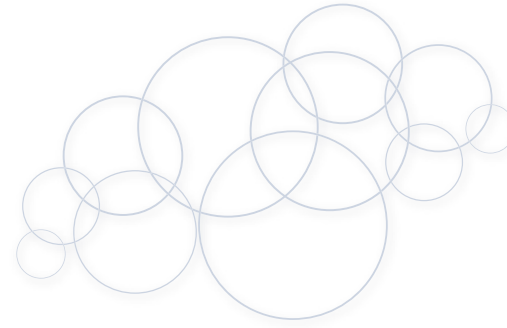

Owner's Manual



IMPORTANT SAFETY INSTRUCTIONS

When using an electrical appliance, basic precautions should always be followed, including the following:

Read all instructions before using this appliance.

WARNING—To reduce risk of fire, electrical shock or injury:

1. Do not leave appliance when plugged in. Unplug from outlet when not in use and before servicing.
2. To reduce the risk of electrical shock, use indoors only.
3. To avoid risk of electrical shock and to reduce risk of fire, use only Rainbow cleaning products intended for use with this machine.
4. To avoid risk of electrical shock, use ONLY the hose supplied with the Rainbow for wet pickup operations. See Rainbow Owner's Manual. Do not modify the electrified plug in any way.
5. The AquaMate contains an electric motor and power cord. To avoid risk of electrical shock, DO NOT immerse the electric cord in water while filling or cleaning the tank.

SAVE THESE INSTRUCTIONS!

PRODUCT VIEW



REGARDING THE AQUAMATE CLEAN WATER TANK SECTION:

6. **IMPORTANT**—The AquaMate water tank is designed to USE CLEAN, COLD TAP WATER ONLY. To avoid damage to the AquaMate, DO NOT place any of the following into the center water tank:
 - Hot water or liquids.
 - Detergents of any kind, including Rainbow products.
 - Commercially available cleaning liquids or compounds.
7. Use only AquaMate Shampoo or Floor Cleaner in the small side soap tank.
8. Do not use on hardwood, laminate or marble flooring.
9. Ensure the carpet has thoroughly **dried** before using the Rainbow Power Nozzle to vacuum.
10. Do not use the AquaMate when the clean water tank is empty. This could result in damage to the pump.
11. For further safety instructions, refer to Rainbow Owner's Manual.

SERVICING OF DOUBLE-INSULATED APPLIANCE:

In a double-insulated appliance, two systems of insulation are provided instead of grounding. No grounding means is provided on a double-insulated appliance, nor should a means of grounding be added to the appliance. Servicing a double-insulated appliance requires extreme care and knowledge of the system and should be done only by qualified Rainbow service personnel. Replacement parts for a double-insulated appliance must be identical to the parts they replace. A double-insulated appliance is marked with the words "DOUBLE INSULATION" or "DOUBLE-INSULATED." The symbol (square within a square) may also be marked on the appliance.



USE THE AQUAMATE® ONLY AS DIRECTED IN THIS OWNER'S MANUAL!

FOR HOUSEHOLD USE ONLY. Use with the Rainbow E2™ only.

www.rainbowsystem.com

CARPET PREPARATION

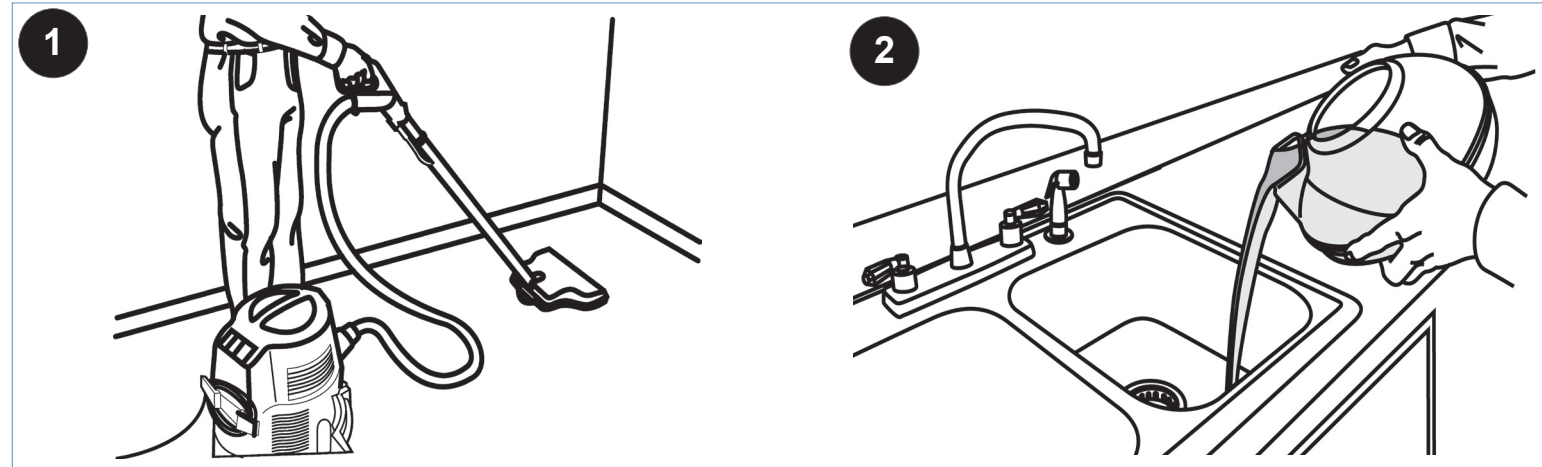

SETUP

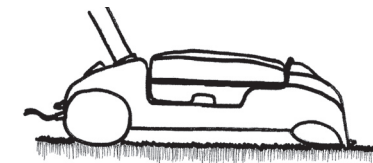
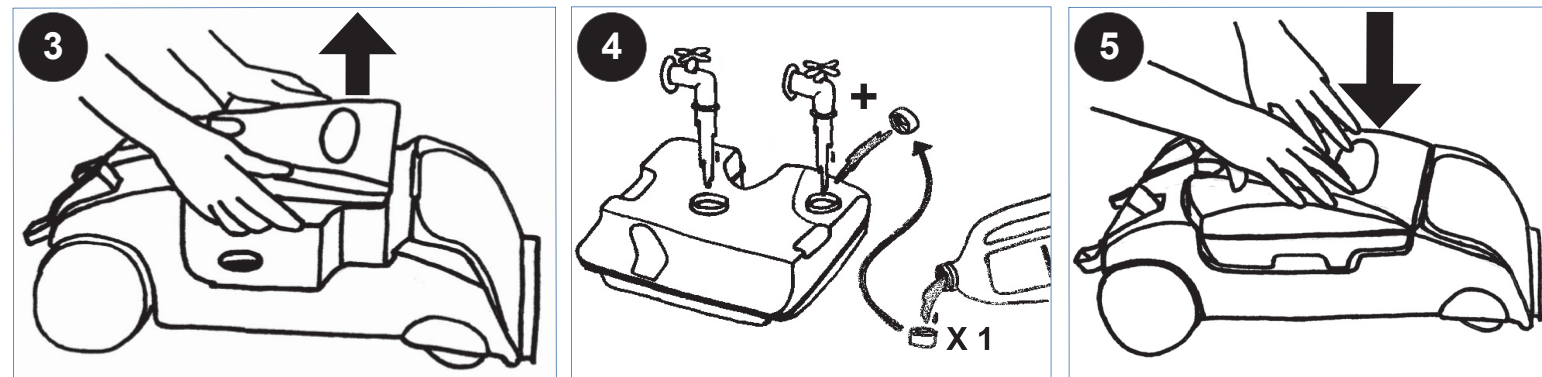

CARPET CLEANING

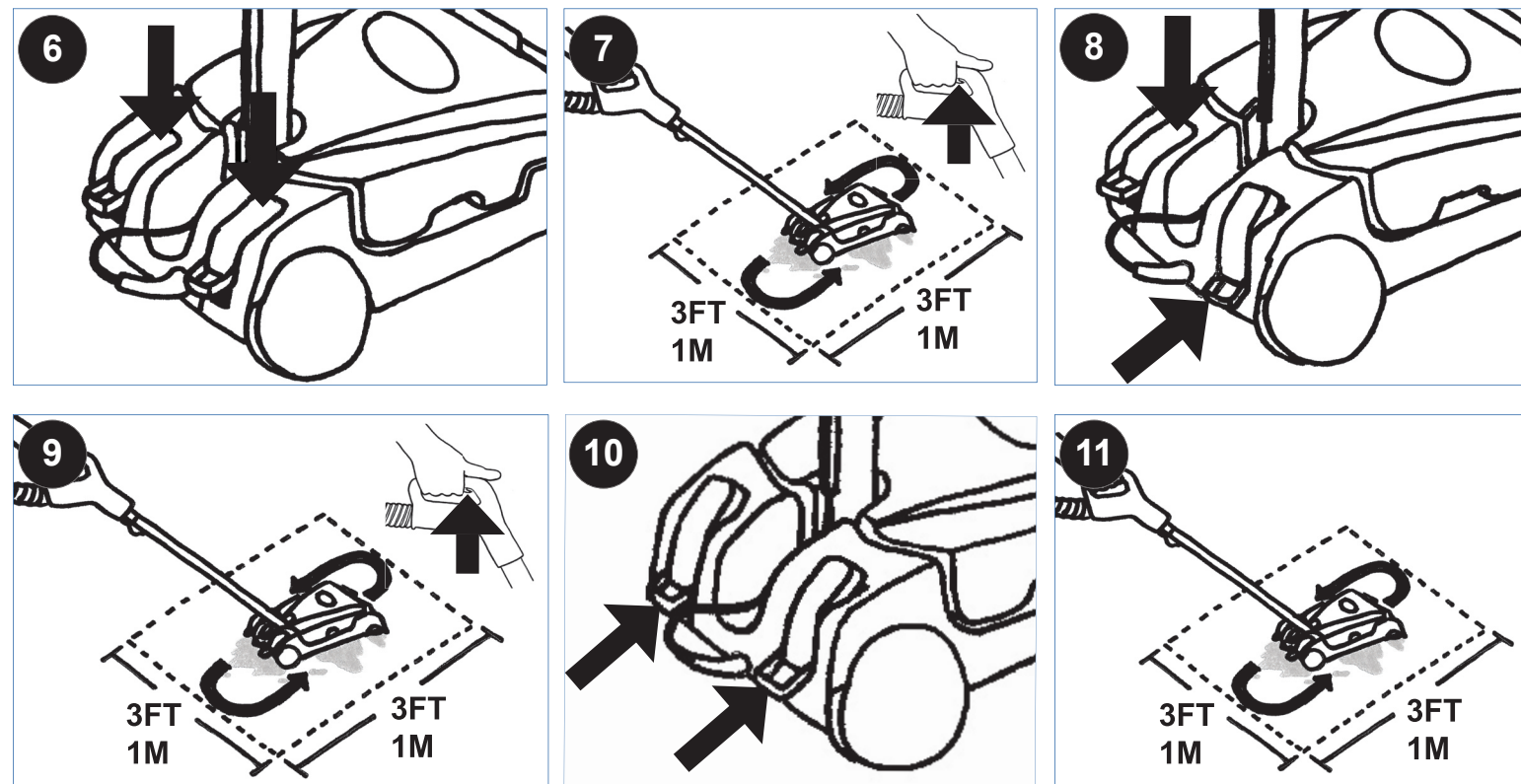

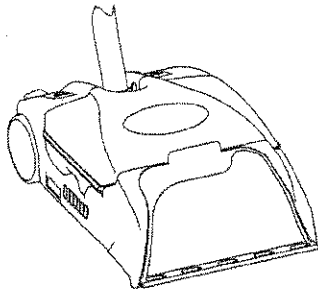

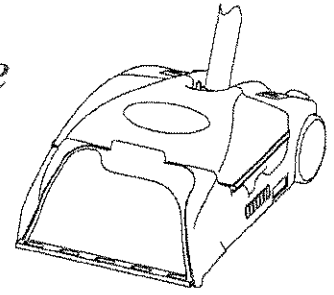

Operating Tips For AquaMate

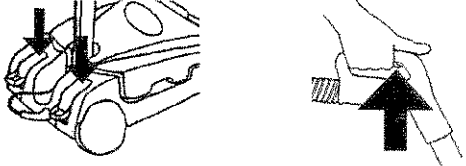
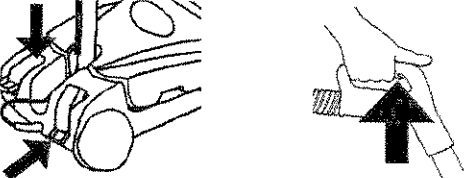

Four Modes of Operation

If you want:

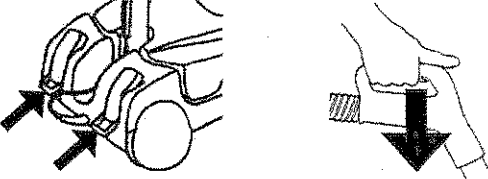
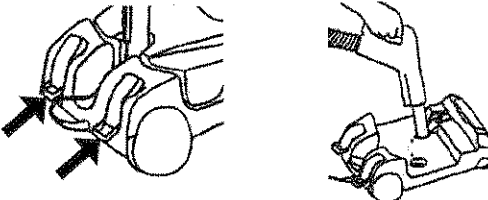
| | |
|--|---|
| <p>A Water and Soap To Spray For Shampooing— Brush Rotation:</p> |  <p>1) Both valves must be on; 2) Handle trigger is depressed.</p> |
| <p>B Water Only (No Soap) To Spray For Rinsing— Brush Rotation:</p> |  <p>1) Left valve is on; 2) Handle trigger is depressed.</p> |
| <p>C No Spray— Brush Rotation:</p> |  <p>1) Both valves must be off; 2) Handle trigger is depressed.</p> |
| <p>D Off / No Spray At All— No Brush Rotation:</p> |  <p>1) Both valves must be off; 2) Handle trigger is not depressed.</p> |
| <p>Storage:</p> |  <p>1) Both valves must be off.</p> |

Operating Tips For AquaMate

1. Install an empty water basin onto the Rainbow.
2. Use one capful of soap in the soap tank. Soap efficiency is greatly increased due to the rotating brush and agitation—each fiber is coated with soapy solution. A little soap goes a long way! Fill the remainder of the soap tank with water and **COMPLETELY** fill the water tank.
3. The new AquaMate allows the carpet fiber to be combed. Hair and fibers previously entangled are now extracted, so you can expect to see balls of hair and fiber often. The nozzle area is very small and was designed to maximize cleaning efficiency, so hair and fiber do not get sucked up. If the nozzle was larger, balls of debris would go up and decrease cleaning efficiency.
4. Don't store the AquaMate with water or soap in the tank. Always turn both valves off and remove the water tank. This eliminates a potential for leakage. Empty the tank and suck the water from the receptacles. If the AquaMate is unattended for a short period of time, remove the tank and turn it upside down on top of the AquaMate.
5. The brush roll can be pulled down to allow cleaning between uses.
6. Time to prime is around 20 seconds. To reduce priming time, several things can be done.
 - a) Make sure the water tank is fully seated;
 - b) Turn the soap valve off;
 - c) Cycle the water valve between on and off two times;
 - d) Squeeze and release the handle trigger several times.
7. Do not use on hardwood floors, laminates or marble.
Water warps wood, marble is soft!
8. If the soap tank is empty and the soap valve is on, no water will be dispensed because air is being sucked through the soap tank. If cleaning without soap, fill the soap tank with water to prevent loss of prime.

RAINBOW