



# 10 ft x 20 ft x 8 ft Instant Shelter ASSEMBLY MANUAL



## Parts Alert!

If you have a question or if there are missing parts, please call:

**203-591-9033**

or email [Service@shelterit.com](mailto:Service@shelterit.com)

Monday-Friday 9:00am-5:00 p.m. EST

**DO NOT RETURN TO STORE!**

Please read instructions fully before beginning assembly!

# TABLE OF CONTENTS

SAFETY CAUTIONS / CLEANING .....	2-3
PARTS LIST .....	4
ASSEMBLY INSTRUCTIONS .....	5-13
LIMITED WARRANTY .....	14

## SAFETY and PRE-ASSMEBLY CAUTIONS

READ PRIOR TO ASSEMBLY!

**DO NOT ASSEMBLE OR DISASSEMBLE THE STRUCTURE ON A WINDY DAY  
ONCE ASSEMBLED, IF HIGH WINDS ARE FORECAST WE RECOMMEND YOU REMOVE  
THE COVER AND STORE IT UNTIL THE WINDY CONDITIONS HAVE PASSED**

1. The cover is made of 3-layer polyethylene. Please do not use open flames and heated elements inside or in close proximity to the product (including all types of stoves, gas heaters, gas lanterns, citronella torches mosquito coils, etc.). The fabric will burn if left in continuous contact with a flame or heat source. Any damage to the cover as a result of using open flames or heating elements will void the Manufacturer's warranty.
2. This is a temporary structure and is not recommended for use as a permanent structure.
3. Choose your shelter's location carefully. Check for overhead utility lines, branches, etc. Do NOT install near roofs or other structures that may shed snow or ice onto the shelter.
4. Inventory all parts before attempting installation.
5. Always wear safety glasses and gloves when assembling or disassembling this product.
6. The shelter must be installed on a level surface.
7. Anchors must be used with all shelters. When erecting shelters, covers should NOT be installed on any product until it has been properly anchored to the ground. Any shelter that is not anchored securely or properly will blow away. Proper anchoring of the shelter and suitable soil conditions are the responsibility of the customer.
8. Never start gas engines from any vehicle or other machinery within a closed shelter. Special ventilation including an open door should be used at all times for these situations. Any work with paints, cleaning products, etc, may require additional ventilation. When possible always avoid working with such chemicals inside the shelter.
9. Do NOT use barbeque grills, smokers or other flammable equipment under or inside any shelter.
10. Do not cook, smoke, use flammable devices, refuel or store flammable materials in this shelter. Never use or ignite an open flame in the shelter. Open flames must be kept a safe distance away from the shelter.
11. No snow accumulation should be allowed on the shelter. Monitor continuously for accumulated snow on the roof. Snow or ice accumulation may cause your shelter to collapse. This shelter is NOT designed to hold heavy snow or ice loads. Brush snow and ice off the roof top with a broom or mop. Failure to remove snow will void the Manufacturer's warranty.
12. Never clear the roof of snow or debris from inside the shelter. Doing so will increase the risk of collapse, damage to property, personal injury and/or death.
13. Municipal by-laws must be verified prior to setting up this temporary shelter.

## CARE AND CLEANING

1. After assembly, periodically check the anchors, the tension of ratchets, buckles and all hardware to ensure the stability of the shelter. Especially during the first few weeks it will be necessary to tighten the cover and hardware. Always ensure that all covers and hardware are kept tightened.
2. Do NOT apply any "Protect & Shine" type products to the cover or other harsh abrasives including bleach or cleansers. The cover can be easily cleaned with mild soap and water. If storing the cover after cleaning, allow it to fully dry prior to storage.
3. Do NOT use the product for purposes or in an environment for which it is not intended. (e.g. extreme cold, high wind conditions, extreme heat, heavy rainfall, etc.).

**Please note that the Manufacturer has no control over the elements such as wind, heavy snow or rain. The Manufacturer cannot control the location or soil conditions into which the shelter is placed. The Manufacturer, without control of the elements, location or soil conditions, cannot be held responsible for damages caused by the shelter to other items or damages to the shelter itself.**

## ASSEMBLY

*Please read instructions fully before beginning assembly.*

### STEP 1: CHECKING THE PARTS

Unpack and check the contents of the box. Make sure that you have all the parts described in the parts list shown hereafter.





























**DO NOT RETURN PRODUCT TO THE STORE**

Missing parts, need replacements, or help with assembly please contact Customer Service:

**service@shelterit.com (+1) 203-591-9032**

Waterbury, CT 06710 U.S.A.

Part#	Description	Draw ing	Q ty
10201	#1 4-way Peak Connector		3
10202	#2 3-way Peak Connector		2
10203	#3 Rafter Pole		10
10204	#4 Upright Pole1		10
10205	#5 Upright Pole2 and Top Cross Rail -s		10
10206	#6 Steel Foot Plate		6
10207	#7 Upright Pole 3		4
10208	#8 Side Connector		10
10209	#9 Bend Corner Leg		4
102010	#10/#11 Top Cross Rail		4
102012	#12 Bottom cross rail -s		8
102013	#13 Bottom cross rail		8
102016	#16 Side cross rail -s		14
102017	#17 The end of Side cross rail		2
102018	#18 Steel Rod for Win Brace		4
102020	#20 Steel Rod for middle rib		3
102021	Wire Cable 1'		4
102022	Cable Clamp		4
102023	Removable 15" Auger Anchor		4
102024	4-Way Cover Rail Clamp		12
102025	3-Way Cover Rail Clamp		8
B 675	Bolt 3"	M6x75mm	10+1
B 633	Bolt 1" 3/8	M6x33mm	8+1
B 645	Bolt 2"	M6x45mm	96+1
N 6	Nut	M6	114+2
M 6	Washer	M6	8+1
S620	"S" Hook		4
E635	Eye Bolt with Nut		4
9913720	Roof Cover		1
2213770	Front Door Panel (with Zipper)		1
2413770	Back Panel		1
P 001	rope clamp		4

# Assembling the Frame

Visit Shelterit.com for installation Video

Diagram A below represents the completed Frame Assembly once steps 1- 4 are completed.

**Note: 2 or more people are required for safe and accurate assembly.**

When assembling the frame HAND TIGHTEN the bolts for the cross rails where the Square are located in Diagram A.

When putting the cover and doors on, they will need to be temporarily removed and retightened.

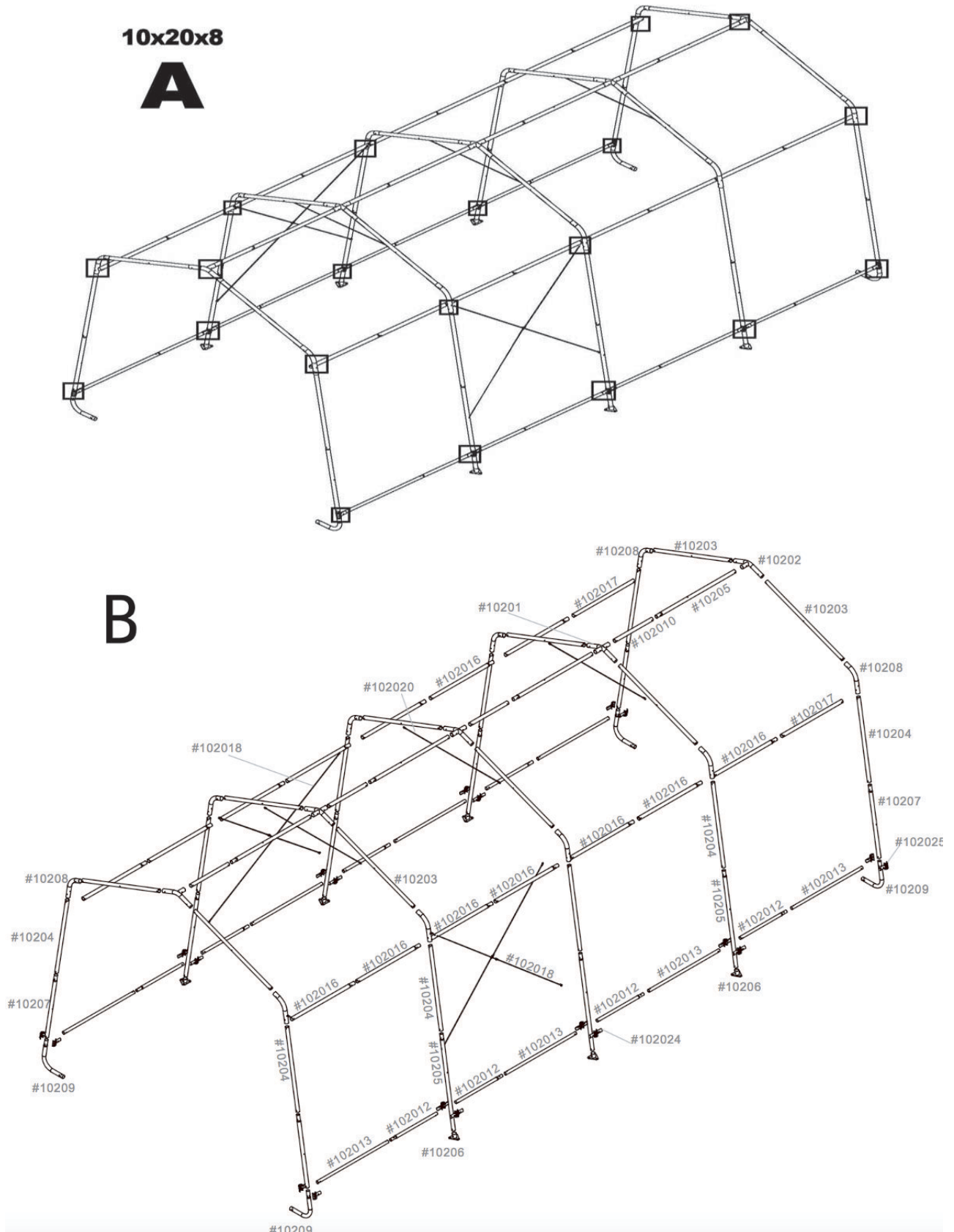

## Step 1 – Collect your Tools

Tools required to assemble the shelter include:

Safety Glasses – 1-pair per participant

1-Adjustable wrench or box wrench

1-Rubber mallet (to be used to ensure all pipes are fully inserted)

1-Step stool or ladder – shelter is 8' tall

1-Hammer to set bolts

Some of the tubes are manufactured with square small dents on one end to act as pressure points to insure the tube fit snug.

Assembly Tip: Using a hammer, tap the bolts to wedge them slightly into the opening. When tightening the self-locking nuts, ensure to draw the bolt heads into the holes of the pipe so that the head of the bolt when fully tightened is flush with the pipe. Failure to do so may cause bolts to tear the shelter's cover.

## Step 2: Assembling the Roof Visit Shelterit.com for installation Video

Layout the roof parts as shown in **Diagram C**. Look at B above for the part #s

Connect all parts as shown in **Diagram C** to form the peak of the shelter frame. Use 2" bolts and nuts to assemble the roof and the center truss brace rods together. Put the truss rod on the round head side of the bolt when connecting to the frame see **Diagram F**.

Install all carriage bolts with nuts facing into the center, inside of the frame to insure the cover does not tear

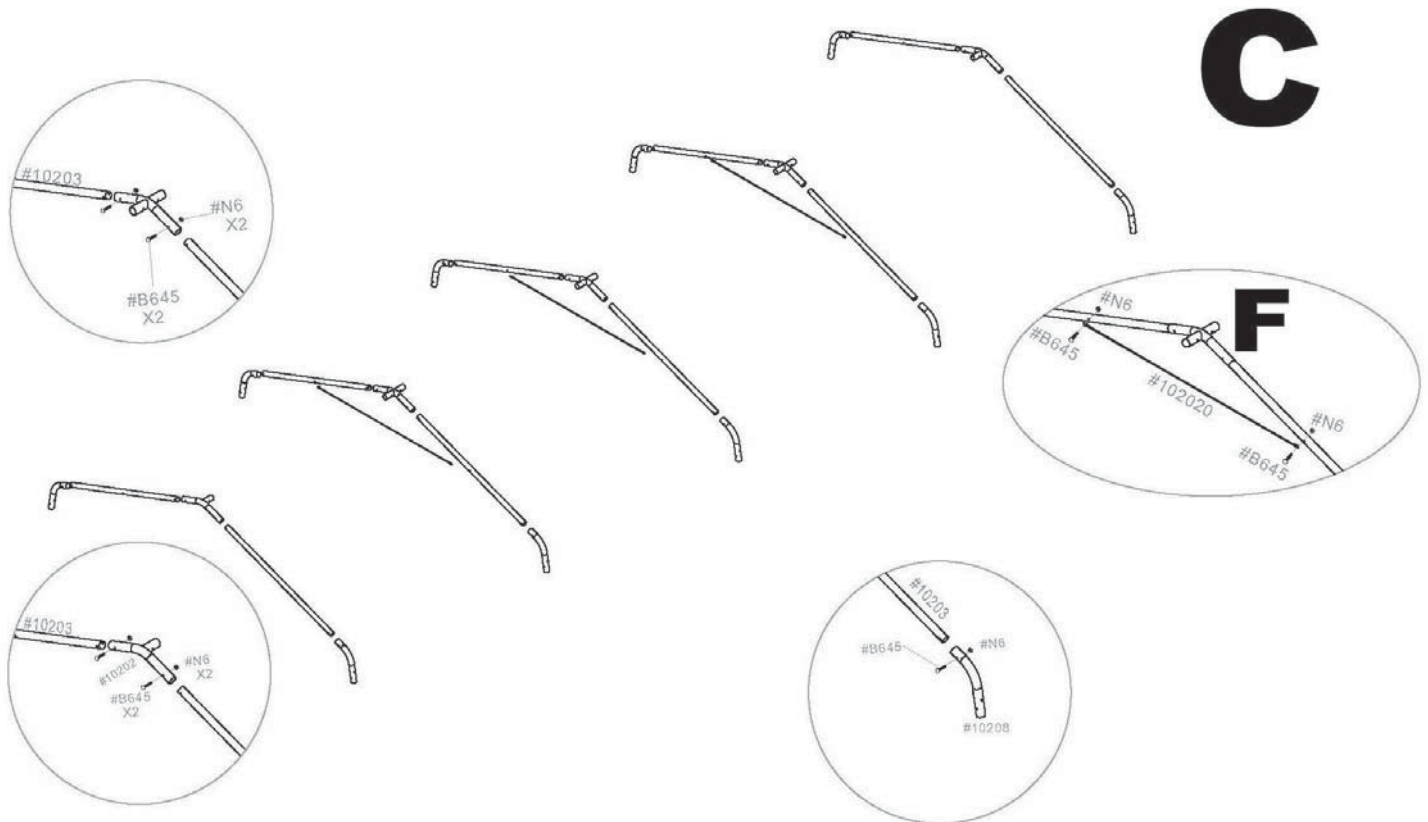



## Step 4: Attaching the upright Legs

- There are four corner legs and 6 middle legs. Assemble the four corner leg tubes for first. Please refer to Diagram H.
- Installing the upright legs. This is accomplished by lifting the side of the shelter while the other side remains resting on the ground.
- Have your 2" bolts ready. Insert the corner legs and center legs as shown in Diagram E H L
- Once the legs are assembled, connect the bottom of the X BRACES to the upright leg with a 2" bolt and washer with the nuts facing inside See Diagram L
- Connect the bottom cross rails and clamps Hand tight to the uprights for now. Repeat the process on the other side of the shelter. See Diagram E H L
- After the frame is up, install the center steel foot plates to the middle uprights see Diagram L .
- We recommend installing the temporary anchors, before installing the cover and doors See Diagram M on page 18

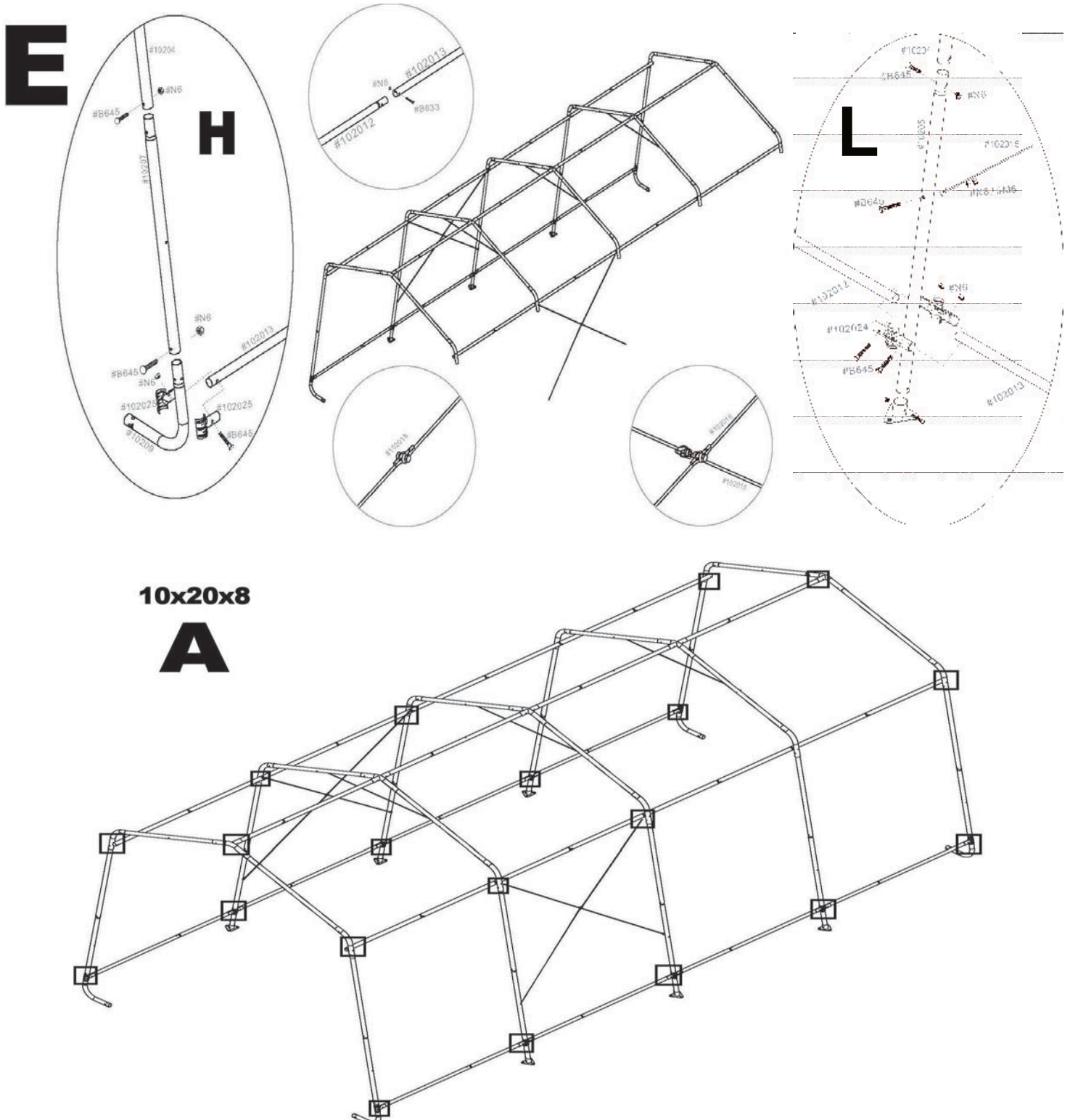



**STEP 5:** Installing the front and back door panel

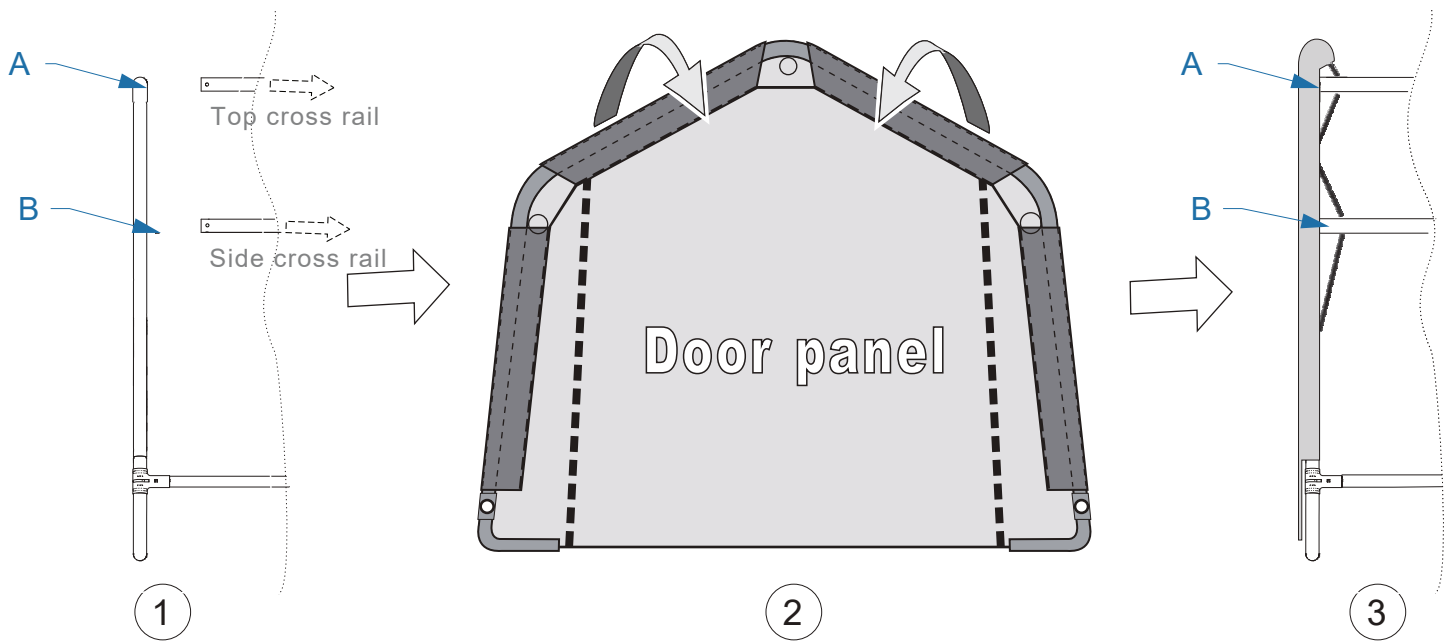
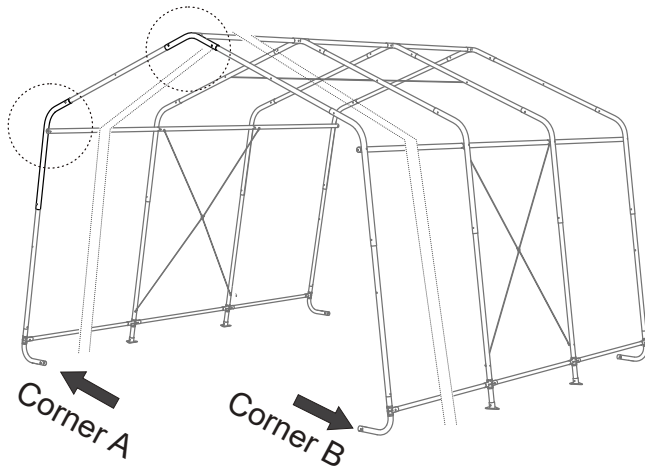

**DO NOT TIGHTEN THE EYE BOLT NUT UNTIL THE COVER ATTACHED**

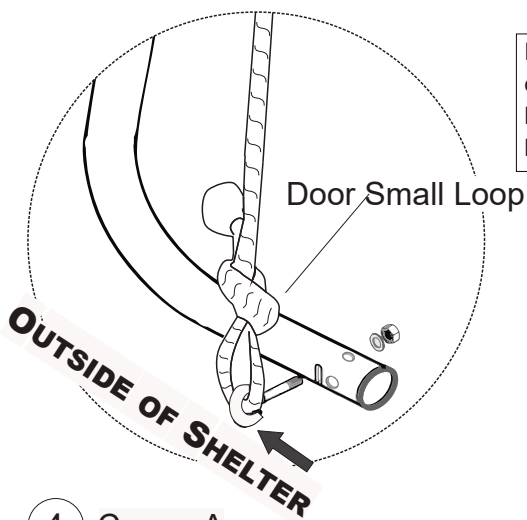

**4** Corner A

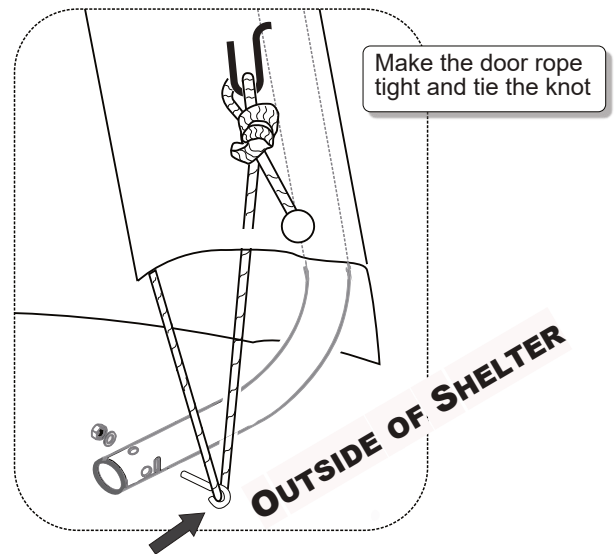

**5** Corner B

Installing the back door panel repeat process 1~5

## STEP 6: Installing the Covers



Visually check all pipes of the frame to ensure they are fully inserted into the next pipe before installing cover. Pipes may separate during installation of end covers and prevent proper installation of the main cover .

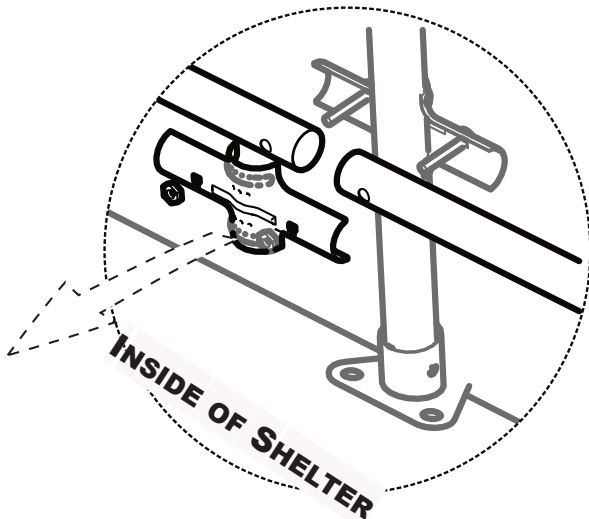
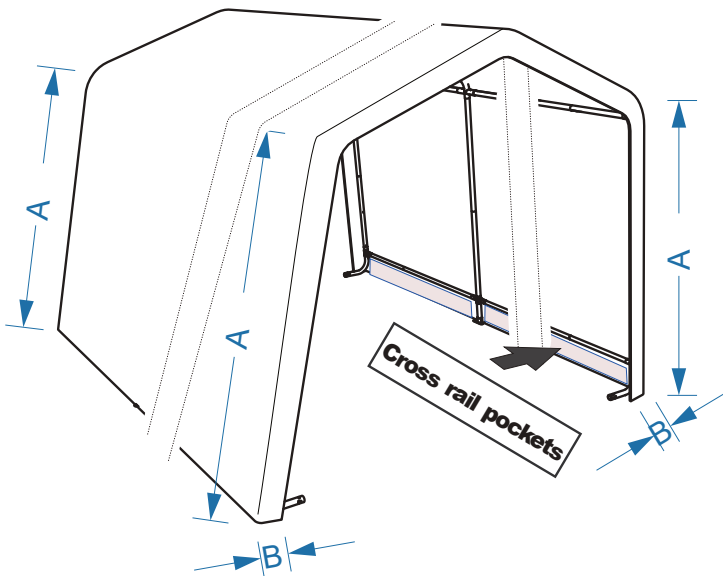
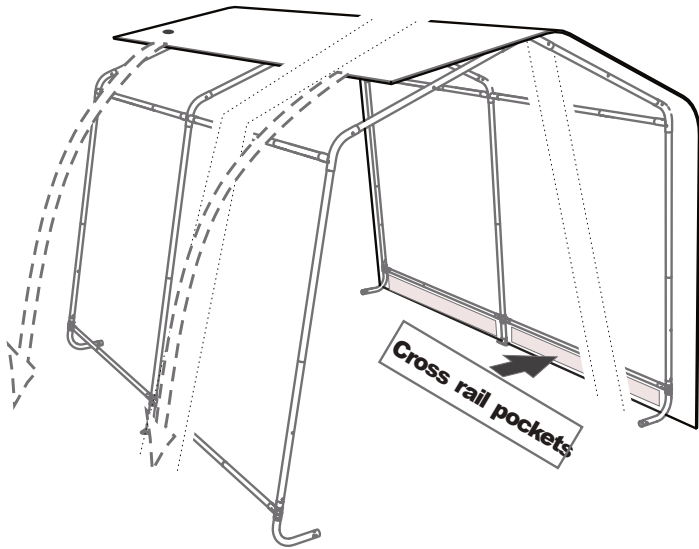

### REQUIRED 2 PEOPLE

Each positioned approximately one-third into the center of the cover, carefully pull the cover over the frame. When reaching the peak use a step stool or ladder to pass over this height.

Pull the cover over the frame so the rope in the pocket is in the front and back of the shelter, not on the side of the shelter.

The 4 corner ropes should be in the 4 corners. When the roof tarp is in position the empty cross rail pockets should be on the side of the shelter near the ground.

Disconnect the nuts & Rail Clamps and Bottom Rails

**STEP 7:** Installing Lower Cross Rails into the main Cover

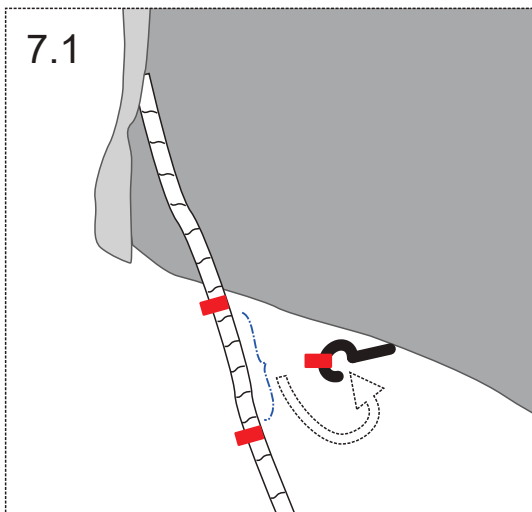
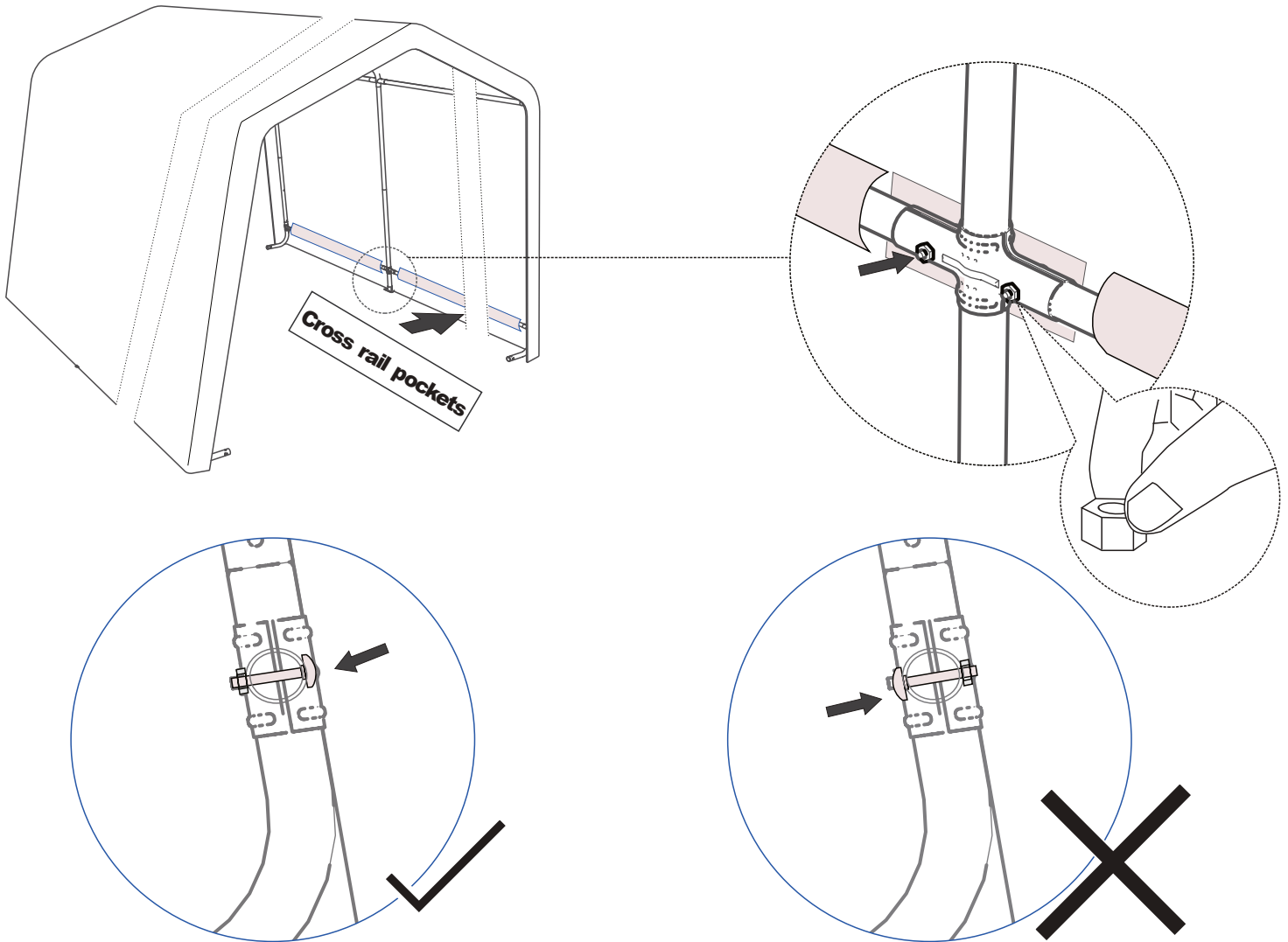

7.1 Hook the cover rope with Red tape to the bottom Eye hook Then take the rope under the door.

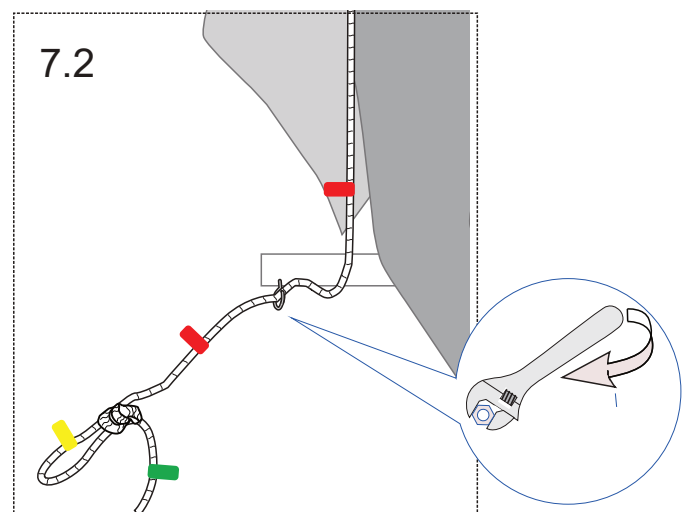

7.2 Take the cover rope under the door and hook the big loop with yellow tape to the S hook with the yellow tape on the corner upright.

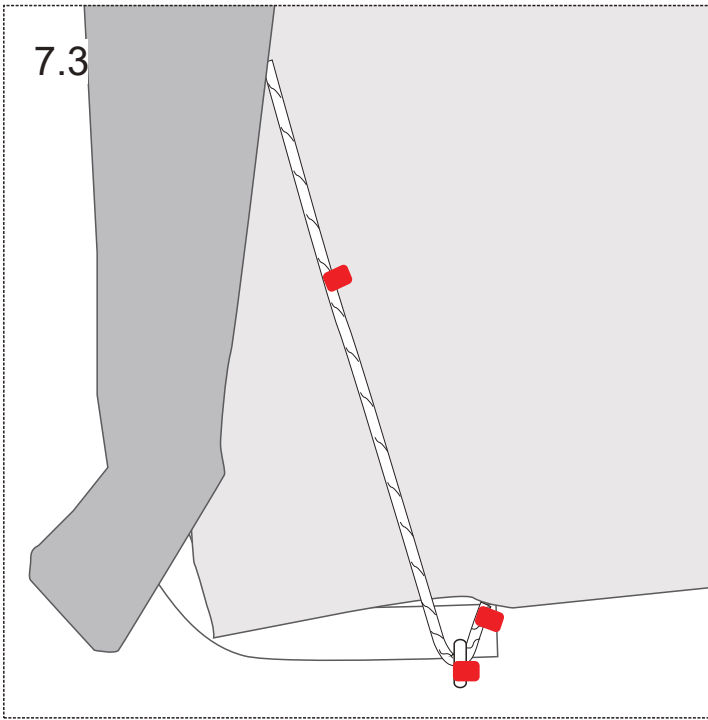

7.3  
Take the cover rope under the door and hook the big loop with yellow tape to the S hook with the yellow tape on the corner upright.

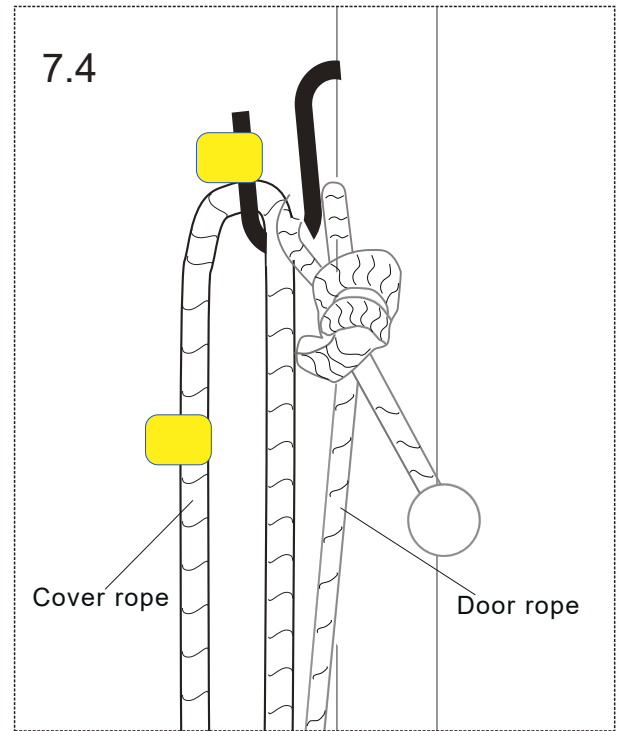

7.4  
Doors and cover big loops with yellow. Connect to corner S hook.

**EVEN THE COVER ON ALL 4 SIDES BEFORE PULLING THE COVER TIGHT**

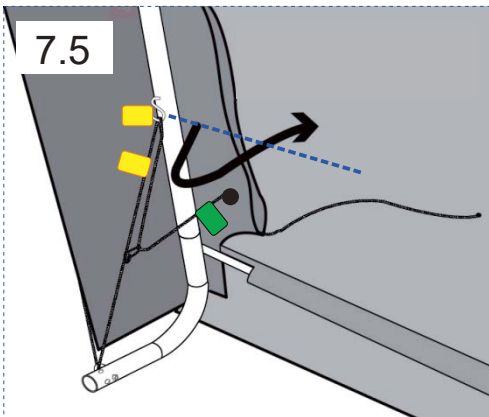

7.5  
Take the black ball end of the rope, and pull the Green label up to the high smaller S hook high. This will tighten the cover to the frame.

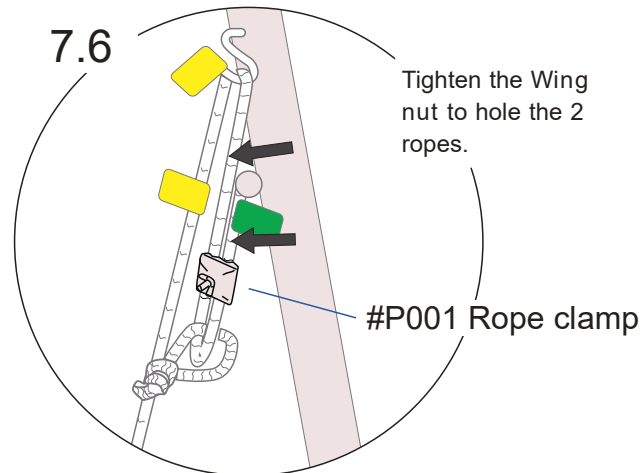

7.6  
Tighten the Wing nut to hole the 2 ropes.

#P001 Rope clamp

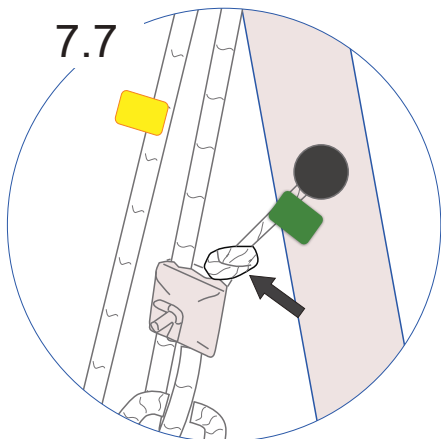

7.7

**TIP**

Tight a knot at end of rope and close to #29 Rope clamp. This will secure the cover

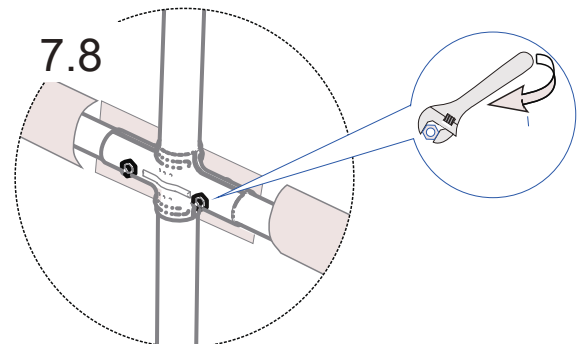

7.8

After the cover is tightened on the 4 corners with the ropes. Push and slide the bottom clamps down that are connected to the side cross rails to snug the sides of the cover to the frame. Tighten the bolts of the cross rail clamps.

## STEP 8: Square and Anchoring the Shelter

Ensure the frame is in the final desired location.

Check the measurement width in the front and back of the shelter.

Take a diagonal measurement, cross-corner to cross-corner. When these two measurements are equal the shelter is square. If not equal, tap the corner leg of the longer measurement with the rubber mallet, in the direction of the diagonally opposite leg to push (decrease) the length of the distance. Repeat (always taping against the longer measure) until both diagonals are equal.

Once equal, check the width measurements again to ensure all are correct

Next, at the curved feet of the shelter install anchors, by screwing the Removable Anchors # 16 in to the ground and to the inside of the shelter.

Secure with Cable #25 and Cable Clamp #26 as shown in Diagram M below.

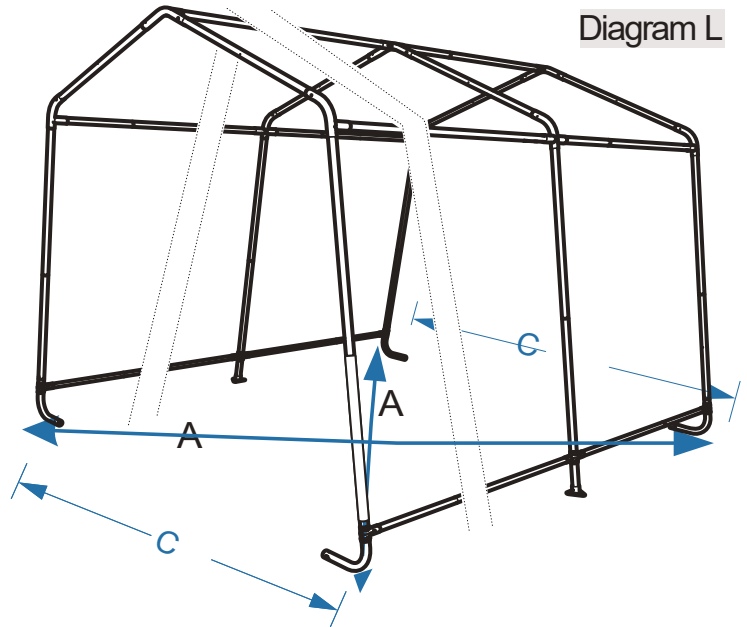
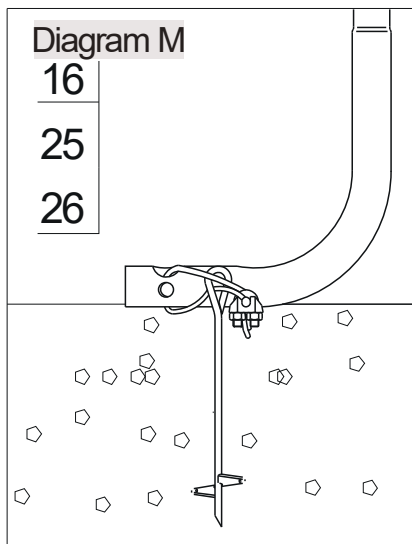

For ADDITIONAL ANCHORS check  
Customer service 203-591-9033

PLEASE RE-READ ALL WARNINGS CONTAINED ON PAGE 3 OF THESE INSTRUCTIONS. SAVE THESE INSTRUCTIONS FOR FUTURE USE.

To dismantle, execute all instructions in reverse order.

Store your shelter in a cool, dry location between seasons to prolong usable life of all components. Components are not equally durable and will require replacement over time at differing intervals.

# LIMITED WARRANTY

This product is guaranteed for 1 year from the date of original retail purchase against defects in materials and workmanship. Subject to the conditions and limitations described below, this product, must be returned with proof of purchase within the stated warranty period and if covered under this warranty, will be replaced (fully or partially with the same model or one of equal value or specification) at the Manufacturer's option.

Liability is restricted to repair or replacement only and does not include any related labor costs of installation, dismantling, repair or transportation costs.

**These warranties are subject to the following conditions and limitations:**

- a) A bill of sale verifying the purchase and purchase date must be provided.
- B) This warranty will not apply to any product or part thereof which is worn, broken or which has become inoperative due to abuse, weather, misuse, accidental damage, neglect or lack of proper installation, operation or maintenance (as outlined in the applicable owner's manual or operating instructions) or which is being used for industrial, professional, commercial or rental purposes.

---

- c) This warranty will not apply to normal wear and tear or to expendable parts or accessories that may be supplied with the product which are expected to become inoperative or unusable after a reasonable period of use.
- d) This warranty will not apply to routine maintenance and consumable items such as the cover, rope , nuts, bolts, etc.
- e) This warranty will not apply where damage is caused by repairs made or attempted by others (i.e. persons not authorized by the manufacturer).
- f) This warranty will not apply to any product that was sold to the original purchaser as a reconditioned or refurbished product (unless otherwise specified in writing).
- g) This warranty will not apply to any product or part thereof if any part from another manufacturer is installed therein or any repairs or alterations have been made or attempted by unauthorized persons.
- h) This warranty will not apply to normal deterioration of the exterior finish, such as, but not limited to, scratches, dents, paint chips, or to any corrosion or discolouring by heat, cold, abrasive and chemical cleaners.
- i) This warranty will not apply to component parts sold by and identified as the product of another company, which shall be covered under the other Product manufacturer's warranty, if any

## Additional Limitations

This warranty applies only to the original purchaser and may not be transferred. Neither the retailer nor the manufacturer shall be liable for any other expense, loss or damage, including, without limitation, any indirect, incidental, consequential or exemplary damages arising in connection with the sale, use or inability to use this product.

## Notice to Consumer

This warranty gives you specific legal rights, and you may have other rights, which may vary from province to province state to state. The provisions

Contained in this warranty are not intended to limit, modify, take away from, disclaim or exclude any statutory warranties set forth in any applicable provincial or federal legislation.

## Parts Alert!

If you have a question or if there are missing parts, please call:

**203-591-9033**

or email [Service@shelterit.com](mailto:Service@shelterit.com)

Monday-Friday 9:00am-5:00 p.m. EST

**DO NOT RETURN TO STORE!**