

BACKSTOP KIT WITH TARGETS FOR 4'x6' GOAL

No.	Sketch	Description	Part #	Qty
1		Bottom U Tube	PS46251 111	2
2		Top U Tube	PS46251 002	2
3		Lower Inside Upright	PS46252 003	2
4		Upper Inside Upright	PS46252 004	2
5		Outside Upright	PS46251 005	4
6		Bolts 8 x 75mm	B875	2
7		Bolts 8 x 30mm	B830	2
8		Butterfly Nuts 8mm	N80	3
9		15' Black Rope	9142	4
10		5' Black Rope	9143	2
11		15" Black Rope	9144	6
12		Side Backstop Net	9175	2
13		Top Backstop Net	9176	1
14		4x6 Hockey 4 Pocket Target Nets	69101	1
15		Black Bungee 5"	9153	6
16		Bolts 6mm x 75mm	8014	4
17		Butterfly Nuts 6mm	8015	5

Installation Instructions

Please read instructions
COMPLETELY
before assembly.



**DO NOT RETURN
PRODUCT TO THE
STORE**

Missing Parts,
Need Replacements, or
Help with Assembly

Please Contact
Customer Service:

Service@ezgoal.net
203 933 4442

West Haven, CT 06516



If you have the 4x6 hockey Ezgoal goal with the 1" ring  on the front uprights ,see figure (E), use page 2 to attach the backstop to the goal. For all other Ezgoals and goals use page 3 to attach the backstop to the goal.

Model #69109_{AP}

EZGoal 4x6 Backstop Kit

Figure 1

NOTE: Precision connection will fit snugly, use a rubber mallet or block of wood if needed.

Figure 1 Assemble 2 panels according to the diagram. Note: the corner loops on each panel should face each other and the down tube loops face back.

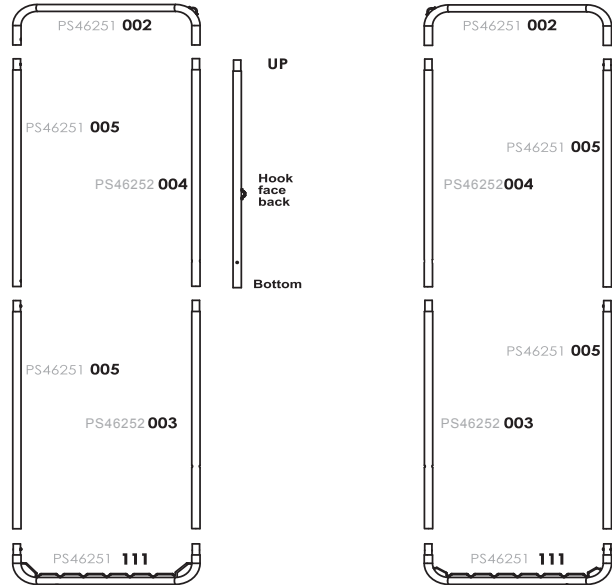

Figure 2 Side panel Assembly Lacing
Secure the 4 corners of the net, so it is easy to lace. Then labels should be on top. The lacing Should be snug. Start at the bottom in the middle of the wiggle wire. Use the 15' black ropes. See Details
1) B Corners, lace every square box.
2) C Side and top, lace every other square box.
3) D Bottom, lace every square box
Tie off with good Knots.

Figure 2 Fasten tight every other square with the cordage

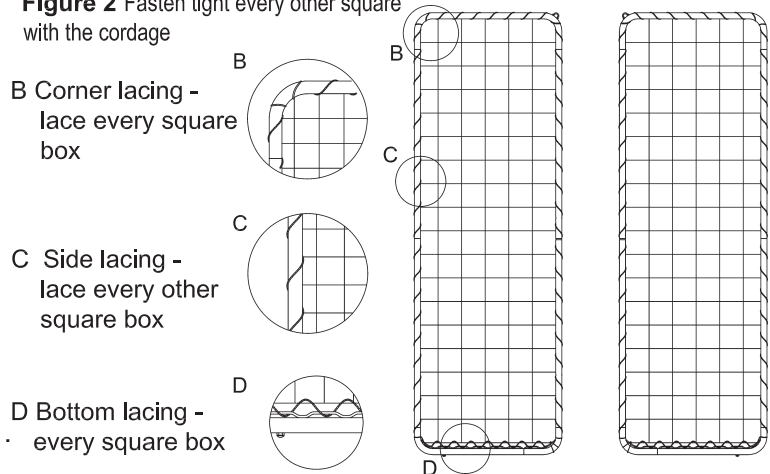

Figure 3 Bolting the side panels
If you have an Ezgoal Hockey net, the holes are predrilled to secure the side panels.

use (2) 75mm bolts and the 2 butterfly nuts on the top two holes.
(2) 30mm bolts on the bottom two-holes .
Figure (E) & (I)

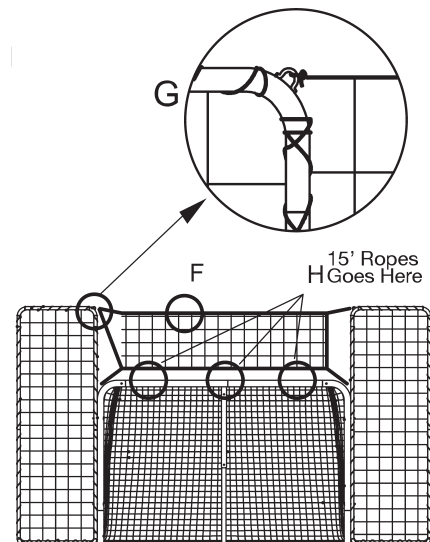
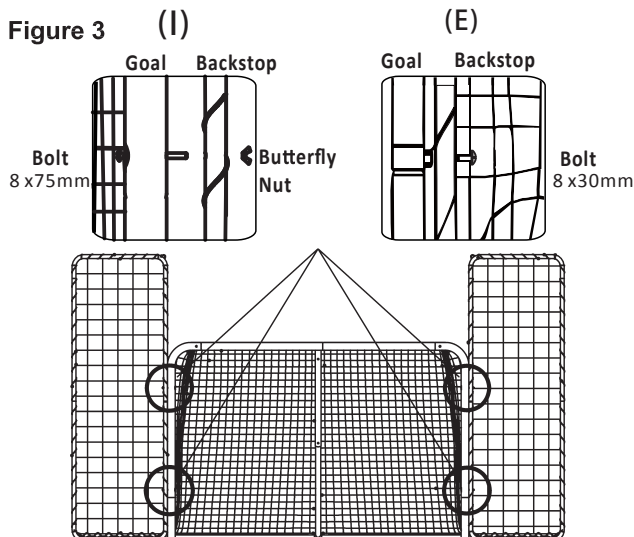

Figure 4 backstop top net connection

The thick black rope and label must be on top. (Detail F.) Using thin short rope corner ties, attach the top net to the 4 corner steel loops. Secure the heavy main rope on one panel to the steel loop, pull tight and secure the main rope to the opposite side panel . See (Detail G.) and the front of the color box. Repeat for the bottom rope , Use the 5'ropes to lace the top net to the side panels. See detail (G) and Figure 4 . Use the 15"rope , Tie bow knots, to secure the top net to the goal in a few locations (Detail H .)

EZGoal 4x6 Backstop Kit

NOTE: Precision connection will fit snugly, use a rubber mallet or block of wood if needed.

Figure 1 Assemble 2 panels according to the diagram. Note: the corner loops on each panel should face each other and the down tube loops face back when using bolt to see use to goal lacing.

Figure 2 Side Panel Assembly Lacing
Secure the 4 corners of the net, so it is easy to lace. Then labels should be on top. The lacing should be snug. Start at the bottom in the middle of the wiggle wire. Use the 15' black ropes. See Details

- 1) B Corners, lace every square box
 - 2) C Side and top, lace every other square box
 - 3) D Bottom, lace every square box
- Tie off with good Knots.

Figure 3 & 3A Attaching Side Panels to frame
There are 2 ways to connect the side panels to the goal. It can be bungeed or bolted to the goal.

Figure 3A Bungee connection
Use 3 bungees, space evenly, see Figure (5) on each side to secure the backstop to the goal when using bungees. The bungee balls must be on the back side of the goal!

Figure 3 Bolting the Side panels
if you have a EZgoal Hockey net, the holes are predrilled to secure the side panels. If you do not have holes on the goal. Stand the side panels along side of the goal. Drill 4 - 1/4" holes on the side of the goal to match the backstop holes. Attach them to the frame using the (4) 3" bolts and butterfly nuts. The bottom hole on the side panels adjusts up and down if needed to the goal holes. Detail (E)
Note: The head of the bolt should be on the inside of the goal.

Figure 4 Backstop Top Nets
The thick rope and label must be on top. (Detail F.) Using thin short corner ties attach the top net to the 4 corner steel loops. Secure the heavy main rope on one panel to the steel loop. pull tight and secure the main rope to the opposite side panel. (Detail G.) Repeat for the bottom rope box. Use the 4' ropes to lace the top net to the side panels. see detail G and figure 5. and the front of the box. Use the 15" rope, bow tie off the top net to the goal in a few locations. (Detail H.)

Folding & Storing :

Figure 5 Fold panels forward, this will help stabilize the unit in windy conditions. Note: never leave the unit unattended within 8' of vehicles, boats, homes, or any structure which may incur damage from the backstop or cause damage to the backstop.

Figure 1

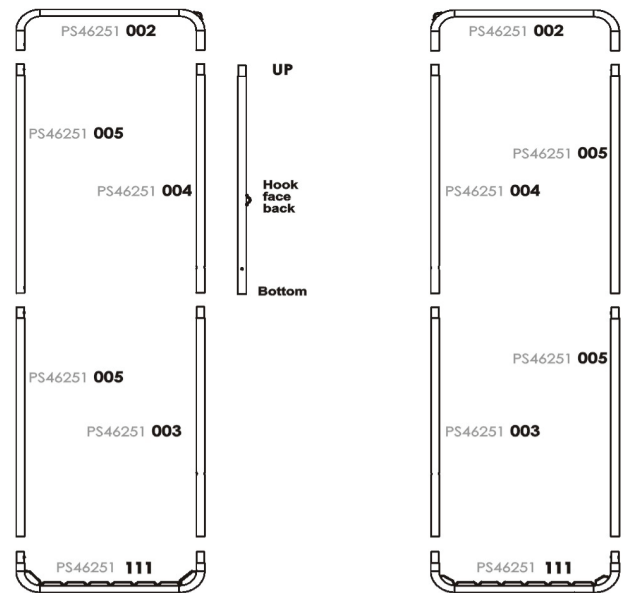

Figure 2 Fasten tight every other square with the cordage

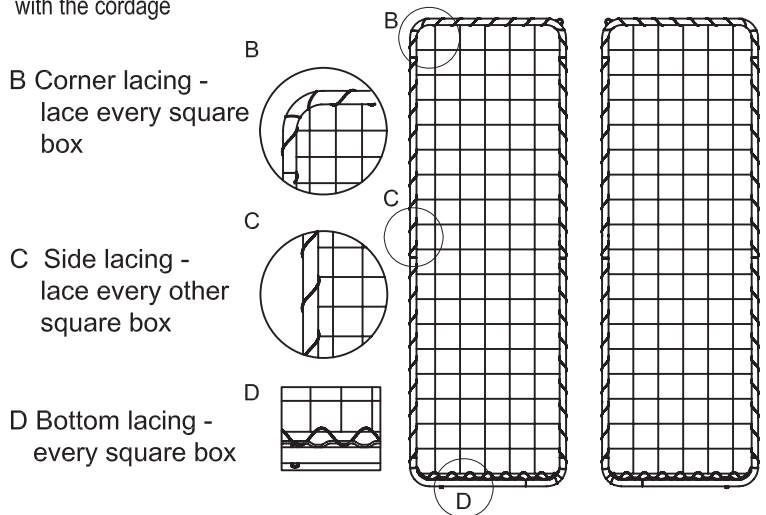

Figure 3

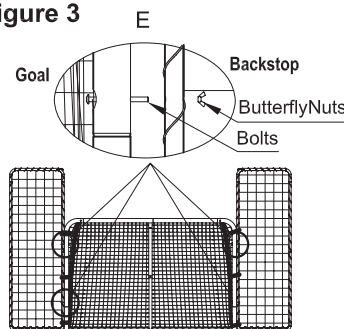

Figure 4

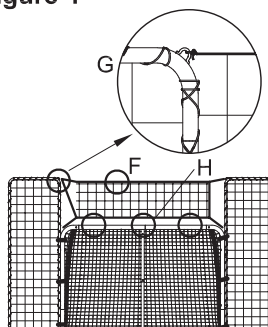

Figure 3A

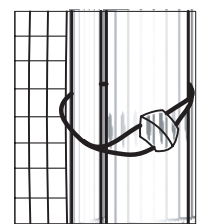
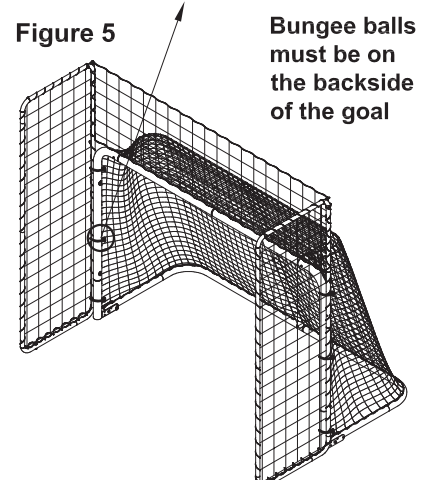

Figure 5



Folding and storing:

Note: This Backstop is designed to fold up in front of goal. To do this you need to find the button on the bottom back of the side uprights of the Ezgoal goal. Press the button in. This will enable the ring on the goal to rotate to the front of the goal with the backstop. See figure 5(1) (2) (3). This will make it so you can swing the backstop in front of the goal for storing.

Warning !!! Do not fold the backstop forward for storing without pressing the button Step 2

Note: For a none Ezgoal goal that is bolted, you will need to take the backstop off for storage.

See figure 5 (1) (2) (3).
Ezgoal Storage

Note: Only the 2013 Ezgoal with the 1" rings on the sides Fold in.

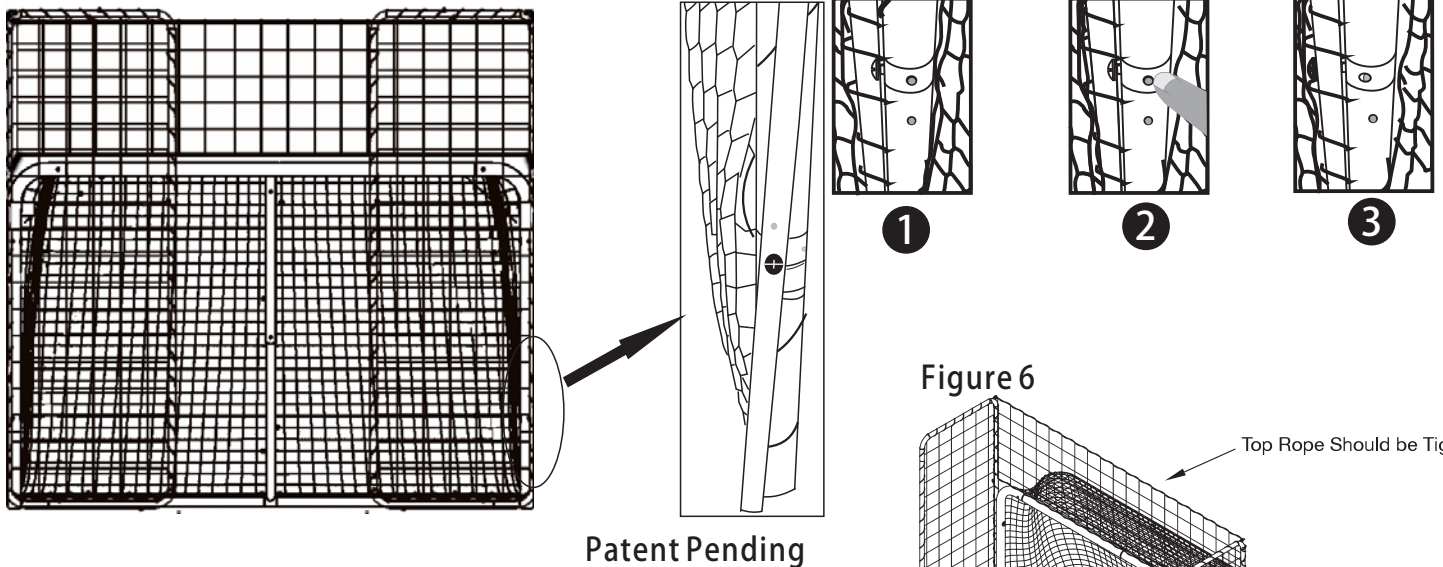
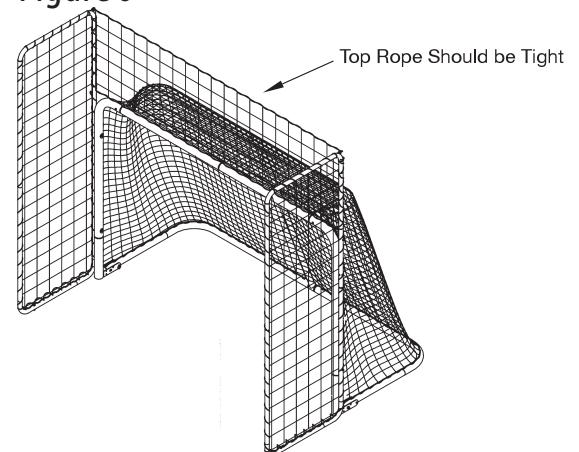

Figure 5

Figure 6

Figure 6 . Fold panels forward, this will help stabilize the unit in windy conditions. Note: never leave the unit unattended within 10' from vehicles, boats, homes, or any structure which may incur damage from the backstop or cause damage to the backstop.



To Order the Backstop Rebounder Visit ezgoal.net **CUSTOMER ASSISTANCE**

For help, replacement parts, questions or concerns about your EZ Goal Products, EMAIL or Call

EZ Goal Sports
Customer Service:
West Haven, CT 06516

Service@Ezgoal.net or 203 933 4442

SAFETY PRECAUTIONS



WARNING

- Manufacturer suggests wearing safety goggles for net assembly, to protect against bungee cords hitting eye.
- As with any play equipment, children **MUST** be supervised at all times.
- Use product on a level surface.
- Never use near steps or stairs.
- For outdoor use only.
- Allow 8 feet from structures such as a fence, garage, house, overhanging branches, laundry lines, or electrical wires.
- Use common sense, and all the same precautions as you would when playing sports.
- Secure unit, so high winds do not blow it over.



WARNING

- **NEVER** allow anyone (people or pets) to stand behind the net or in any possible path of a ball or puck should you miss the net or should the ball or puck go through the net.
- Inspect unit before and during each use. Replace any worn or damaged parts.
- Never allow children to stand on unit. This could cause damage to unit and result in an injury.
- Do not use bungees for any other purposes other than to apply net.
- As with any sporting activity, always wear the recommended safety equipment.
- Never leave children unattended.
- Use protective eyewear when securing bungees.

4'x6' 4 Pocket Target Nets Installation

Step 1 Lay out the EZ Goal target pockets in front Fig. 1 of the goal. Align the colored tabs in each pocket with the appropriate corner
BROWN upper right
BLUE upper left
ORANGE lower right
RED lower left

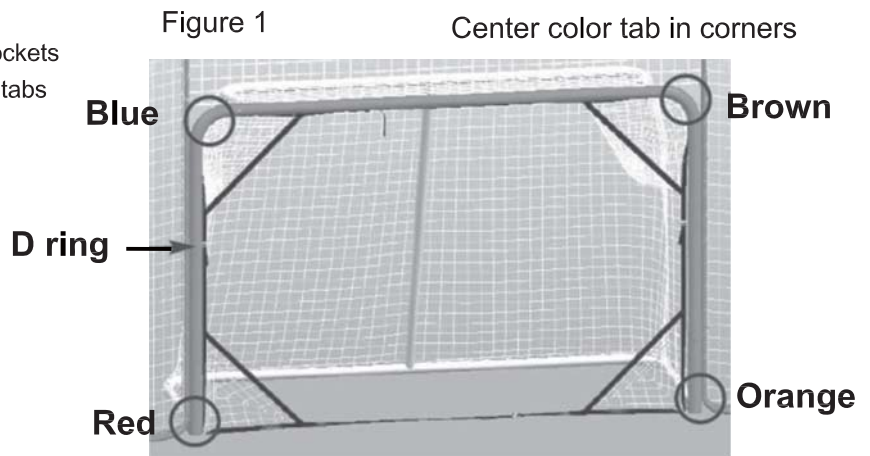

Step 2 Hook the 2 hooks on the back of the wire frame separated by about 4" or one wire loop. (see Figure 2) Keep the color tab in the middle of the corner while adjusting, leaving slack in the line for final adjustment with the D rings.

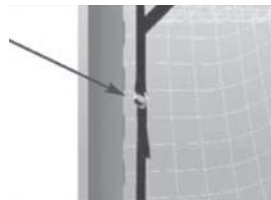
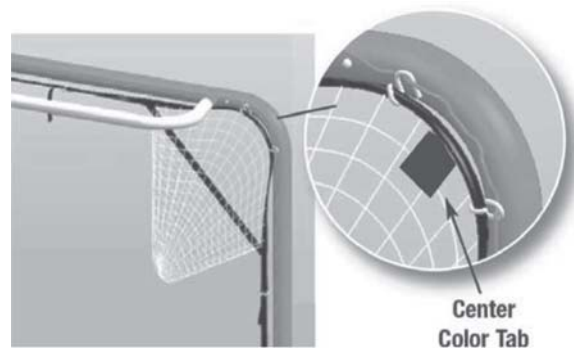
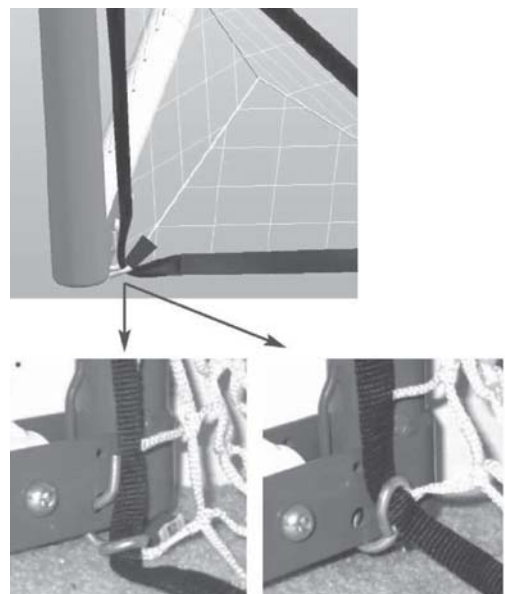

Figure 2



Step 3 Attach each bottom pocket by inserting hook through the lower bracket hole from the inside. (NOTE: you may also secure the hook in the bottom of the tube). Keep the color tabs in the four corners for the purpose of alignment. Fig. 3.

Figure 3



Step 4 Remove the slack from the straps by tightening the D-rings to a snug fit. (NOTE: adjust the straps so that the pocket and color tabs are centered in the corners).

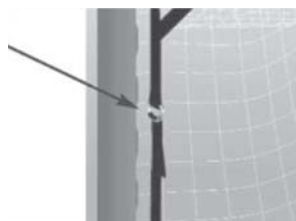

Backstop Rebounder Kit (Fits all goals)

#65121

Make a good player a better one!

#65511



To Order the Backstop Rebounder Visit ezgoal.net
CUSTOMER ASSISTANCE

For help, replacement parts, questions or concerns about your EZ Goal Products, EMAIL or Call

EZ Goal Sports
Customer Service:
West Haven, CT 06516

Service@Ezgoal.net or 203 933 4442

SAFETY PRECAUTIONS



WARNING

- Manufacturer suggests wearing safety goggles for net assembly, to protect against bungee cords hitting eye.
- As with any play equipment, children **MUST** be supervised at all times.
- Use product on a level surface.
- Never use near steps or stairs.
- For outdoor use only.
- Allow 8 feet from structures such as a fence, garage, house, overhanging branches, laundry lines, or electrical wires.
- Use common sense, and all the same precautions as you would when playing sports.
- Secure unit, so high winds do not blow it over.



WARNING

- **NEVER** allow anyone (people or pets) to stand behind the net or in any possible path of a ball or puck should you miss the net or should the ball or puck go through the net.
- Inspect unit before and during each use. Replace any worn or damaged parts.
- Never allow children to stand on unit. This could cause damage to unit and result in an injury.
- Do not use bungees for any other purposes other than to apply net.
- As with any sporting activity, always wear the recommended safety equipment.
- Never leave children unattended.
- Use protective eyewear when securing bungees.