



*Martha*  
**410R SERIES**

# Martha

## 410R SERIES



© 2022 England, Inc.

### Dimensions

	<i>O.A</i> <i>LENGTH</i>	<i>O.A</i> <i>DEPTH</i>	<i>O.A</i> <i>HEIGHT</i>	<i>SEAT</i> <i>LENGTH</i>	<i>SEAT</i> <i>DEPTH</i>	<i>SEAT</i> <i>HEIGHT</i>
<b>410-31R</b> Motion Chair	34"	36"	43"	21"	22"	20"

*Fabric in Photo:* Wolcott Portobello

Apr 22

### Features

<b>Cushions/Back</b>	Sinuous Wire
<b>Cushions/Back/Attached</b>	Block foam with polyester fiber wrap
<b>Cushions/Seat</b>	Block foam with polyester fiber wrap
<b>Fabric Types Available</b>	1, 6, 11, 14, 22
<b>Legs/Wood</b>	<i>Front:</i> 3.5" x 10" H.; <i>Back:</i> 2.5" x 6.25" H. (Screw-In)
<b>Options/Available</b> <i>(Additional Charge)</i>	<ul style="list-style-type: none"> <li>● <b>FK</b> - Frame Coil (Coil Core)</li> <li>● <b>PM</b> - Power</li> <li>● <b>PB</b> - Power w/Battery Pack</li> </ul>
<b>Seat Construction</b>	Sinuous Wire
<b>Seating/Tight</b>	Standard
<b>Welt/Matching</b>	Standard
<b>Wood Trim</b>	Medium brown finish on legs

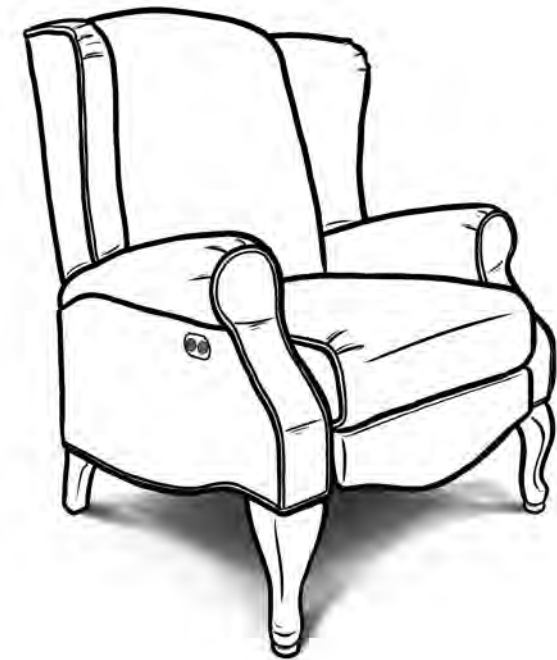



474



490-69N



494N

*Reynolds/ShIPLEY*  
**470/490 SERIES**

# Reynolds/Shipley

## 470/470N SERIES 490/490N SERIES



© 2022 England, Inc.

### Dimensions

		<i>O.A</i> <i>LENGTH</i>	<i>O.A</i> <i>DEPTH</i>	<i>O.A</i> <i>HEIGHT</i>	<i>SEAT</i> <i>LENGTH</i>	<i>SEAT</i> <i>DEPTH</i>	<i>SEAT</i> <i>HEIGHT</i>
474/474N/470-69/470-69N	Chair/Swivel Chair	30"	39"	41"	21"	23"	21"
494/494N/490-69/490-69N	Chair/Swivel Chair	30"	39"	41"	21"	23"	21"

*Fabric in Photo:* 474: Wolcott Portobello  
470-69N: Downton Milk  
494N: Madrid Fog\*

\*Discontinued fabric for viewing purposes only

Apr 22

N = Nails

### Features

<b>Cushions/Back</b>	Sinuous Wire
<b>Cushions/Back/Attached</b>	Block foam with polyester fiber cap
<b>Cushions/Seat</b>	Block foam with polyester fiber wrap
<b>Cushions/Ventilated</b>	Standard
<b>Fabric Types Available</b>	<b>470/470N:</b> 1, 6, 11, 14, 22 <b>490/490N:</b> 4, 15, 16
<b>Legs/Wood</b>	3" x 6" H. (Screw-In) <b>-69:</b> Swivel Base
<b>Options/Available</b> (Additional Charge)	<ul style="list-style-type: none"> <li>• <b>CK</b> - Coil Cushion</li> <li>• <b>FK</b> - Frame Coil (Coil Core) except -69</li> </ul>
<b>Seat Construction</b>	Sinuous Wire
<b>Seating/Loose/Reversible</b>	Standard
<b>Trim - Pewter Nails</b>	Standard on the 470N/490N
<b>Welt/Matching</b>	Standard
<b>Wood Trim</b>	Dark Brown finish on legs



470



490

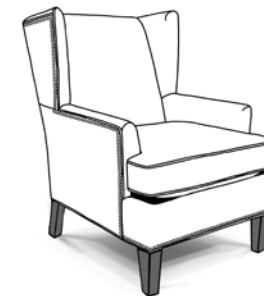

470N



490N





*Reagan*  
**510 SERIES**

# Reagan

## 510 SERIES



© 2022 England, Inc.

### Dimensions

	<i>O.A</i>	<i>O.A</i>	<i>O.A</i>	<i>SEAT</i>	<i>SEAT</i>	<i>SEAT</i>
	<i>LENGTH</i>	<i>DEPTH</i>	<i>HEIGHT</i>	<i>LENGTH</i>	<i>DEPTH</i>	<i>HEIGHT</i>
<b>510-71</b> Swivel Glider	29"	37"	35"	22"	22"	21"
<i>Fabric in Photo:</i> Amerie Portrait p/p Lucca Portrait						
Apr 22						

\* SPECIAL FABRIC INSTRUCTIONS  
1st: Body, 2nd Pillow

### Features

<b>Cushions/Back</b>	Sinuous Wire
<b>Cushions/Back/Attached</b>	Block foam with polyester fiber wrap
<b>Cushions/Seat</b>	Block foam with polyester fiber wrap
<b>Cushions/Ventilated</b>	Standard
<b>Fabric Types Available</b>	1, 6, 11, 14, 22
<b>Legs</b>	Swivel Base
<b>Options/Available</b> <i>(Additional Charge)</i>	<ul style="list-style-type: none"> <li>• <b>CK</b> - Coil cushions</li> <li>• <b>DP</b> - Feather Blend Pillow</li> </ul>
<b>Pillows/Contrasting</b>	Standard (One ea — 15" x 21")
<b>Pillows/Matching</b>	Available
<b>Pillow/Fabric Types Available</b>	1, 2, 3, 4, 6, 11, 12, 14, 15, 16, 22, 24
<b>Seat Construction</b>	Sinuous Wire
<b>Seating/Loose/Reversible</b>	Standard
<b>Welt/Matching</b>	Standard

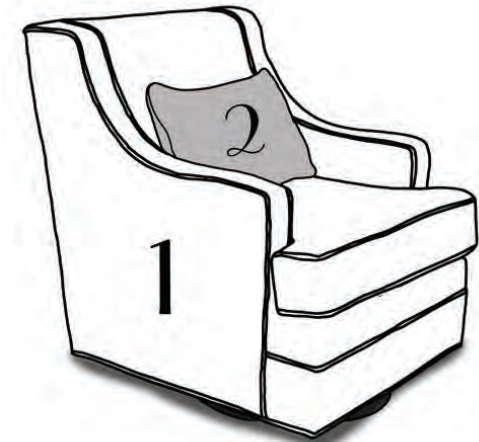



1K00



1K00N



1K00AL



1K00ALN

*Helen/Kora*  
**1K00/1K00AL SERIES**

# Helen/Kora

## 1K00/1K00N/1K00AL/1K00ALN SERIES

© 2021 England, Inc.

### Dimensions

		<i>O.A</i> <i>LENGTH</i>	<i>O.A</i> <i>DEPTH</i>	<i>O.A</i> <i>HEIGHT</i>	<i>SEAT</i> <i>LENGTH</i>	<i>SEAT</i> <i>DEPTH</i>	<i>SEAT</i> <i>HEIGHT</i>
<b>1K00-31</b>	Motion Chair	31"	36"	42"	21"	20"	21"
<b>1K0031N</b>	Motion Chair	31"	36"	42"	21"	20"	21"
<b>1K031AL</b>	Motion Chair	31"	36"	42"	21"	20"	21"
<b>1K31ALN</b>	Motion Chair	31"	36"	42"	21"	20"	21"

Aug 21

*Fabric in Photo:* 1K00: Espanola Sapphire  
 1K00N: Edison Ecu  
 1K00AL: Groundworx Groovy  
 1K00ALN: Salvador Copper

### Features

- Cushions/Back** Webbing
- Cushions/Back/Semi-Attached** Polyester fiber fill- *Zipper Access*
- Cushions/Seat** Block foam with polyester fiber wrap
- Fabric Types Available**
  - 1K00/N:** 1, 6, 11, 14, 22
  - 1K00AL/ALN:** 10, 25, 27
- Legs/Wood**
  - Front:* 1.5" x 1.5" x 6.5" H. Tapered (Screw-In)
  - Rear:* 1.5" x 2" x 3.75" H. Tapered (Screw- In)
- Options/Available**
  - **FK** - Frame Coil (Coil Core)
  - **PM** - Power
  - **PB** - Power w/ Battery Pack
- (Additional Charge)*
- Seat Construction** Sinuous Wire
- Seating/Tight** Standard
- Trim- Brass Nails** Standard - 1K00N/ 1K00ALN
- Welt/Matching** Standard
- Wood Trim** Dark Brown finish on legs



1K00AL



1K00



1K00ALN



1K00N





1180



1180AL

*Nellie*  
**1180/1180AL SERIES**

# Nellie

## 1180/1180AL SERIES

**England**  
FURNITURE CO.

© 2022 England, Inc.

### Dimensions

		<i>O.A</i> <i>LENGTH</i>	<i>O.A</i> <i>DEPTH</i>	<i>O.A</i> <i>HEIGHT</i>	<i>SEAT</i> <i>LENGTH</i>	<i>SEAT</i> <i>DEPTH</i>	<i>SEAT</i> <i>HEIGHT</i>
<b>1184</b>	Chair	35"	36"	42"	22"	22"	21"
<b>1184AL</b>	Chair	35"	36"	42"	22"	22"	21"

*Fabric in Photo:* 1180: Crosby Chambray  
1180AL: Evolution Pumice

Oct 22

### Features

**Cushions/Back**

Sinuous Wire

**Cushions/Back/Attached**

Block foam with polyester fiber cap

**Cushions/Seat**

Block foam with polyester fiber wrap

**Cushions/Ventilated**

Standard

**Fabric Types Available**

**1180:** 1, 6, 11, 14, 12, 22

**1180AL:** 10, 25

**Legs/Wood**

1.5" x 2.5" x 5" H. Pyramid (*Screw-In*)

**Options/Available**

• **CK** - Coil Cushion

(*Additional Charge*)

**Seat Construction - FK Standard**

Sinuous Wire

(*Frame Coil (Coil Core)*)

**Seating/Loose/Non-Reversible**

Standard on 1180AL

**Seating/Loose/Reversible**

Standard on 1180

**Welt/Matching**

Standard

**Wood Trim**

Dark Brown finish on legs



1180



1180AL



1300



1320

*Addie*  
**1310/1320 SERIES**

# Addie

## 1310/1320 SERIES

# England

FURNITURE CO.

© 2021 England, Inc.

### Dimensions

		<i>O.A</i>	<i>O.A</i>	<i>O.A</i>	<i>SEAT</i>	<i>SEAT</i>	<i>SEAT</i>
		<i>LENGTH</i>	<i>DEPTH</i>	<i>HEIGHT</i>	<i>LENGTH</i>	<i>DEPTH</i>	<i>HEIGHT</i>
<b>1310-31</b>	Motion Chair	35"	39"	41"	22"	22"	19"
<b>1320-31</b>	Motion Chair	35"	39"	41"	22"	22"	19"

*Fabric in Photo:* 1300: Baja Ice  
1320: Hazel Sky

June 21

### Features

<b>Cushions/Backs</b>	Webbing with Sinuous Wire
<b>Cushions/Back/Semi-Attached</b>	Block foam with polyester fiber fill - <i>Zipper Access</i>
<b>Cushions/Seat</b>	Block foam with polyester fiber wrap
<b>Cushions/Non-Ventilated</b>	Standard
<b>Fabric Types Available</b>	1310: 1, 6, 11, 14, 22 1320: 4, 15, 16
<b>Legs/Wood</b>	<b>Front:</b> 2.25" x 1.5" x 6" H (Turned; Screw-In) <b>Rear:</b> 2.67" x 2.22" x 3"H (Tapered; Screw-In)
<b>Options/Available</b> (Additional Charge)	<ul style="list-style-type: none"><li>● <b>PM</b> - Power Available</li><li>● <b>PB</b> - Power with battery pack available</li></ul>
<b>Seat Construction</b>	Sinuous Wire
<b>Seating/Tight</b>	Standard
<b>Welt/Matching</b>	Standard
<b>Wood Trim</b>	Dark brown finish on legs



1310



1320





1450N



1470N

*Annie*

**1450/1450N/1470/1470N SERIES**

# Annie

## 1450/1450N/1470/1470N SERIES

**England**  
FURNITURE CO.

© 2021 England, Inc.

### Dimensions

		<i>O.A</i>	<i>O.A</i>	<i>O.A</i>	<i>SEAT</i>	<i>SEAT</i>	<i>SEAT</i>
		<i>LENGTH</i>	<i>DEPTH</i>	<i>HEIGHT</i>	<i>LENGTH</i>	<i>DEPTH</i>	<i>HEIGHT</i>
<b>1450-71/145071N</b>	Swivel Glider	36"	38"	39"	23"	21"	21"
<b>1470-71/147071N</b>	Swivel Glider	36"	38"	39"	23"	21"	21"

*Fabric in Photo:* 1450N: Brandenburg Pewter  
1470N: Affair Seaspray

Oct 21

N = Nails

### Features

<b>Cushions/Back</b>	Sinuous Wire
<b>Cushions/Back/Semi-Attached</b>	Polyester fiber fill in a channel bag- <i>Zipper Access</i>
<b>Cushions/Seat</b>	Block foam with polyester fiber wrap
<b>Cushions/Ventilated</b>	Standard
<b>Fabric Types Available</b>	1450: 1, 6, 11, 12, 14 & 22 1470: 4 & 16
<b>Legs</b>	Swivel Glider Base
<b>Options/Available</b> <i>(Additional Charge)</i>	<ul style="list-style-type: none"> <li>● <b>CK</b> - Coil Cushion</li> <li>● <b>FK</b> - Frame Coil (Coil Core)</li> </ul>
<b>Seat Construction</b>	Sinuous Wire
<b>Seating/Reversible</b>	Standard
<b>Trim - Brass Nails</b>	Standard on 1450N & 1470N only
<b>Welt/Matching</b>	Standard

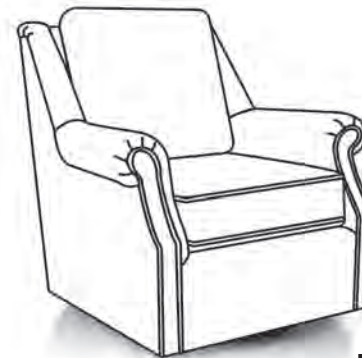

**1450**

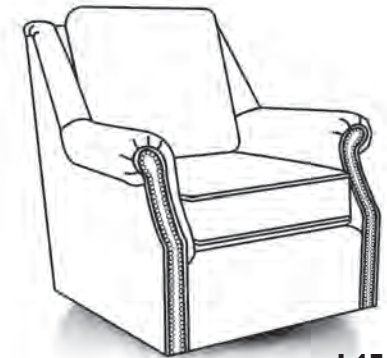

**1450N**



**1470**

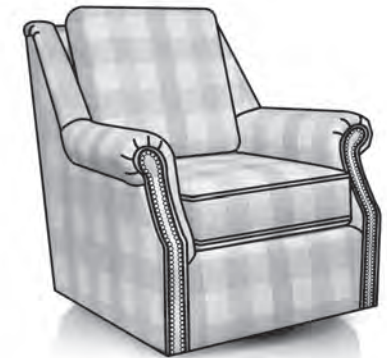

**1470N**



*Raleigh*  
**1750 SERIES**



# Raleigh

## 1750 SERIES

*England*  
FURNITURE CO.

© 2020 England, Inc.

### Dimensions

	<i>O.A.</i> <i>LENGTH</i>	<i>O.A.</i> <i>DEPTH</i>	<i>O.A.</i> <i>HEIGHT</i>	<i>SEAT</i> <i>LENGTH</i>	<i>SEAT</i> <i>DEPTH</i>	<i>SEAT</i> <i>HEIGHT</i>
<b>1750-69</b> Swivel Chair	31"	34"	35"	21"	21"	20"

*Fabric in Photo:* Tito Ash

Oct 20

### Features

**Cushions/Back**

Sinuous Wire

**Cushions/Back/Attached**

Block foam with polyester fiber cap

**Cushions/Seat**

Block foam with polyester fiber wrap

**Cushions/Ventilated**

Standard

**Fabric Types Available**

1, 6, 11, 14, 22

**Legs**

Swivel Base

**Options/Available**

● **CK** - Coil Cushion

*(Additional Charge)*

● **FK** - Frame Coil (Coil Core)

**Seat Construction**

Sinuous Wire

**Seating/Loose/Reversible**

Standard







193031R/193031H



1931ALR/19331HL

*Carolynne/Leonard*  
**1930R/1930H/1930ALR/1930ALH SERIES**

# Carolynne/Leonard

## 1930R/1930H SERIES

## 1930ALR/1930ALH SERIES



© 2022 England, Inc.

### Dimensions

	<i>O.A</i> <i>LENGTH</i>	<i>O.A</i> <i>DEPTH</i>	<i>O.A</i> <i>HEIGHT</i>	<i>SEAT</i> <i>LENGTH</i>	<i>SEAT</i> <i>DEPTH</i>	<i>SEAT</i> <i>HEIGHT</i>
<b>193031R</b> Motion Chair	34"	39"	42"	23"	21"	22"
<b>1931ALR</b> Motion Chair	34"	39"	42"	23"	21"	22"
<b>193031H</b> Motion Chair	34"	39"	42"	23"	21"	22"
<b>19331HL</b> Motion Chair	34"	39"	42"	23"	21"	22"

*Fabric in Photo:* 193031R: Texas Canyon  
1931ALR: Salvador Black Oak

Apr 22

**R=Revised** — This frame has been revised to improve the product.



H = Power Tilt Headrest

### Features

<b>Cushions/Back</b>	Webbing & Sinuous Wire
<b>Cushions/Back/Semi-Attached</b>	Polyester fiber fill - <i>Zipper Access</i>
<b>Cushions/Seat</b>	Block foam with polyester fiber wrap
<b>Fabric Types Available</b>	<b>1930R/1930H:</b> 1, 6, 11, 14, 22 <b>1930ALR/1930ALH:</b> 10, 25, 27
<b>Legs/Wood</b>	Front: 3 1/2" x 4" H. Taper; Back: 3" x 4" H. Taper (Screw-In)
<b>Options/Available</b> <i>(Additional Charge)</i>	<ul style="list-style-type: none"> <li>● <b>FK:</b> Frame Coil (Coil Core)</li> <li>● <b>PM:</b> Power available on 193031R/1931ALR</li> <li>● <b>PB:</b> Battery Pack</li> </ul>
<b>Power</b>	Standard on 193031H/19331HL
<b>Seat Construction</b>	Sinuous Wire
<b>Seating/Tight</b>	Standard
<b>Trim - Brass Nails</b>	Standard
<b>Welt/Matching</b>	Standard
<b>Wood Trim</b>	Dark Brown finish on legs



1930R/1930H



1930ALR/1930ALH



2A00-81



2A20-81

*June/Macy*  
**2A00/2A00N/2A20/2A20N SERIES**



June/Macy

## 2A00/2A00N/2A20/2A20N SERIES

**England**  
FURNITURE CO.

© 2022 England, Inc.

### Dimensions

		<i>O.A</i> <i>LENGTH</i>	<i>O.A</i> <i>DEPTH</i>	<i>O.A</i> <i>HEIGHT</i>
<b>2A00-81/2A0081N</b>	Storage Ottoman	40"	24"	18"
<b>2A20-81/2A2081N</b>	Storage Ottoman	40"	24"	18"

*Fabric in Photo:* 2A00-81: Brentwood Pepper Oct 22  
2A20-81: Faraday Pewter\*

*\*Discontinued fabric for viewing purposes only*

Vent holes are standard  
in ALL storage ottomans  
to prevent suffocation.

N = Nails

### Features

<b>Cushions/Seat</b>	Block foam with polyester fiber wrap
<b>Fabric Types Available</b>	<b>2A00:</b> 1, 6, 11, 14, 22 <b>2A20:</b> 4, 16
<b>Legs/Plastic</b>	Black Casters ( <i>Screw-In</i> )
<b>Seating/Tight</b>	Standard
<b>Storage</b>	Standard
<b>Trim-Brass Nails</b>	Standard on 2A00N & 2A20N
<b>Welt Matching</b>	Standard

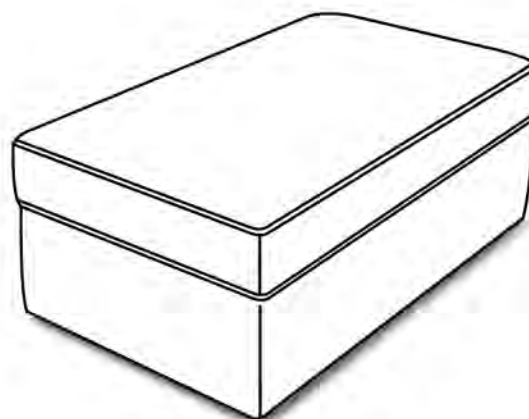

2A00-81



2A20-81





*Banks*  
**2B00 SERIES**

# Banks

## 2B00 SERIES



© 2023 England, Inc.

### Dimensions

		<i>O.A</i> <i>LENGTH</i>	<i>O.A</i> <i>DEPTH</i>	<i>O.A</i> <i>HEIGHT</i>	<i>SEAT</i> <i>LENGTH</i>	<i>SEAT</i> <i>DEPTH</i>	<i>SEAT</i> <i>HEIGHT</i>
<b>2B00-69</b>	Swivel Chair	31"	34"	29"	22"	25"	19"
<i>Fabric in Photo:</i> Lush Celadon p/p Capitol Coal							Apr 23

**\*SPECIAL FABRIC INSTRUCTIONS**  
1st: Body, 2nd: Pillow

### Features

<b>Cushions/Back</b>	Webbing
<b>Cushions/Back/Attached</b>	Block foam
<b>Cushions/Seat</b>	Block foam with polyester fiber cap
<b>Fabric Types Available</b>	1, 6, 11, 12, 14, 22
<b>Legs/Plastic</b>	Glide, Integral part of frame
<b>Options/Available</b>	<ul style="list-style-type: none"> <li>● <b>CK</b> - Coil Cushion</li> <li>● <b>DP</b> - Feather Blend Pillow</li> </ul>
<i>(Additional Charge)</i>	
<b>Pillows/Contrasting</b>	Standard (One ea - 20" x 20")
<b>Pillows/Matching</b>	Available
<b>Pillows/Fabric Types Available</b>	1, 2, 3, 4, 6, 11, 12, 14, 15, 16, 22, 24
<b>Seat Construction</b>	Sinuous Wire with Frame Coil
<b>Seating/Tight</b>	Standard
<b>Welt/Matching</b>	Standard





2F00



2F00N

*Parson*  
**2F00/2F00N SERIES**

Parson

## 2F00/2F00N SERIES



© 2022 England, Inc.

### Dimensions

		<i>O.A</i> <i>LENGTH</i>	<i>O.A</i> <i>DEPTH</i>	<i>O.A</i> <i>HEIGHT</i>
<b>2F00-81</b>	Storage Ottoman	21"	21"	20"
<b>2F0081N</b>	Storage Ottoman	21"	21"	20"

**Fabric in Photo:** **2F00-81:** Lucca Glow\* / Lucca Glow\* Oct 22  
**2F0081N:** Valleys Sandstone / Valleys Sandstone  
*\*Discontinued fabric for viewing purposes only.*

**Vent holes are standard in ALL storage ottomans to prevent suffocation.**

**\*SPECIAL FABRIC INSTRUCTIONS**  
 1st: Top, 2nd: Base

**N = Nails**

### Features

- Cushions/Seat** Block foam with polyester fiber wrap
- Fabric Types Available** Top: 1, 4, 6, 11, 12, 14, 15, 16, 22  
Base: 1, 6, 11, 12, 14, 22
- Legs/Plastic** Black Casters (*Screw-In*)
- Storage** Standard
- Trim - Pewter Nails** Standard on the 2F00N
- Welt/Matching** Standard

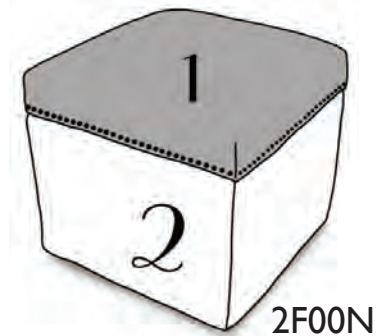
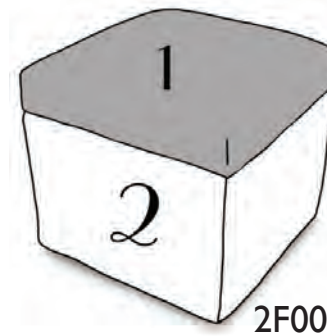





**2J00**



**2J20**



**2J00AL**

*Nessa*

**2J00/2J20/2J00AL SERIES**

# Nessa

## 2J00/2J20/2J00AL SERIES

See digital catalog for  
most up to date information.

# England

FURNITURE CO.

© 2023 England, Inc.

## Dimensions

	<i>O.A</i> <i>LENGTH</i>	<i>O.A</i> <i>DEPTH</i>	<i>O.A</i> <i>HEIGHT</i>	<i>SEAT</i> <i>LENGTH</i>	<i>SEAT</i> <i>DEPTH</i>	<i>SEAT</i> <i>HEIGHT</i>
<b>2J00-71</b> Swivel Chair	30"	40"	41"	20"	22"	21"
<b>2J20-71</b> Swivel Chair	30"	40"	41"	20"	22"	21"
<b>2J071AL</b> Swivel Chair	30"	40"	41"	20"	22"	21"
<b>2J00-26</b> Gliding Ottoman	27"	24"	17"			
<b>2J20-26</b> Gliding Ottoman	27"	24"	17"			
<b>2J026AL</b> Gliding Ottoman	27"	24"	17"			

*Fabric in Photo:* 2J00: Vati Granite  
2J20: Bond Street Slate  
2J00AL: Revelation Tigers Eye

Oct 23

## Features

<b>Cushions/Back</b>	Sinuous Wire
<b>Cushions/Back/Semi-Attached</b>	Block foam with polyester fiber wrap - <i>Zipper Access</i>
<b>Cushions/Seat</b>	Block foam with polyester fiber wrap
<b>Cushions/Ventilated</b>	Standard
<b>Fabric Types Available</b>	<b>2J00:</b> 1, 6, 11, 14, 22 <b>2J20:</b> 3, 4, 15, 16 <b>2J00AL:</b> 10, 25
<b>Legs</b>	Swivel Base
<b>Options/Available</b> (Additional Charge)	<ul style="list-style-type: none"> <li>• <b>CK</b> - Coil Cushion</li> <li>• <b>FK</b> - Frame Coil (Coil Core)</li> </ul>
<b>Seat Construction</b>	Sinuous Wire
<b>Seating/Loose/Reversible</b>	Standard
<b>Welt/Matching</b>	Standard

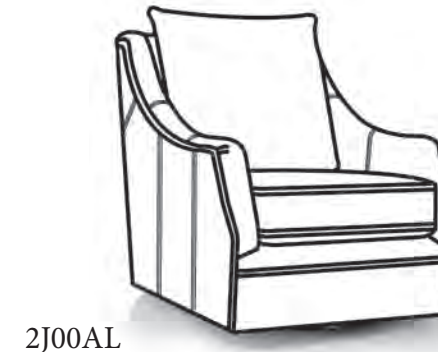
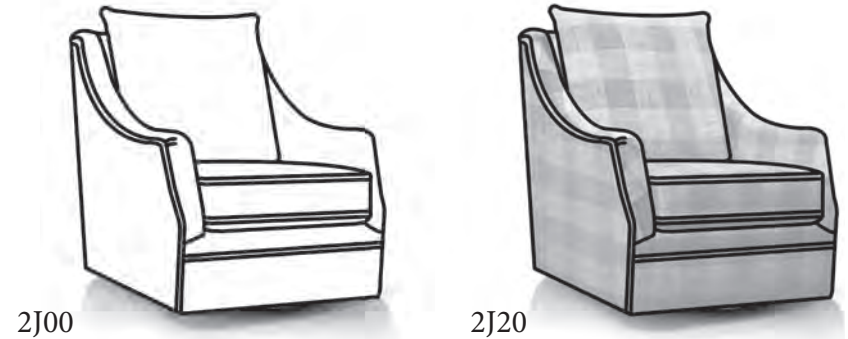



2080



2080AL

*Breland*  
**2080/2080AL SERIES**

Breland

# 2080/2080AL SERIES



© 2022 England, Inc.

## Dimensions

		<i>O.A</i> <i>LENGTH</i>	<i>O.A</i> <i>DEPTH</i>	<i>O.A</i> <i>HEIGHT</i>	<i>SEAT</i> <i>LENGTH</i>	<i>SEAT</i> <i>DEPTH</i>	<i>SEAT</i> <i>HEIGHT</i>
<b>2080</b>	Chair	35"	37"	39"	21"	22"	20"
<b>2080AL</b>	Chair	35"	37"	39"	21"	22"	20"

*Fabric in Photo:* 2080: Lola Rain  
2080AL: Cheyenne Hoss

Oct 22

## Features

- Cushions/Back** Sinuous Wire
- Cushions/Back/Attached** Block foam with polyester fiber wrap - *Zipper Access*
- Cushions/Seat** Block foam with polyester fiber wrap
- Cushions/Ventilated** Standard
- Fabric Types Available** **2080:** 1, 6, 11, 12, 14, 22  
**2080AL:** 10, 25
- Legs/Wood** **Front:** 3.25" x 2.25" x 3.75" H. (*Screw-In*)  
**Back:** 2.25" x 3.375" x 2.375" H. (*Screw-In*)
  - **CK** - Coil Cushion
  - **FK** - Frame Coil (Coil Core)
- Options/Available** (Additional Charge)
- Seat Construction** Sinuous Wire
- Seating/Loose/Non-Reversible** Standard on 2080AL
- Seating/Loose/Reversible** Standard on 2080
- Welt/Matching** Standard
- Wood Trim** Dark Brown finish on legs



2080



2080AL





*Alex*  
**2350 SERIES**

# Alex

## 2350 SERIES

*England*  
FURNITURE CO.

© 2020 England, Inc.

### Dimensions

	<i>O.A</i> <i>LENGTH</i>	<i>O.A</i> <i>DEPTH</i>	<i>O.A</i> <i>HEIGHT</i>	<i>SEAT</i> <i>LENGTH</i>	<i>SEAT</i> <i>DEPTH</i>	<i>SEAT</i> <i>HEIGHT</i>
<b>2350-69</b> Swivel Chair	48"	48"	32"	48"	33"	19"

*Fabric in Photo:* Murano Cloud p/p Altitude Shadow, Titan Shadow

Oct 20

### \*SPECIAL FABRIC INSTRUCTIONS

1st: Body, 2nd: Front Pillow,  
3rd: Two Back Pillows

### Features

<b>Cushions/Back</b>	Sinuous Wire
<b>Cushions/Back/Attached</b>	Block foam with polyester fiber cap
<b>Cushions/Seat</b>	Block foam with polyester fiber wrap
<b>Cushions/Ventilated</b>	Standard
<b>Fabric Types Available</b>	1, 6, 11, 14, 22
<b>Legs</b>	Swivel Base
<b>Options/Available</b> <i>(Additional Charge)</i>	<ul style="list-style-type: none"> <li>● <b>DP</b> - Feather Blend Pillow</li> <li>● <b>FK</b> - Frame Coil (Coil Core)</li> </ul>
<b>Seat Construction</b>	Sinuous Wire
<b>Seating/Loose/Reversible</b>	Standard
<b>Welt/Matching</b>	Standard, also on pillows

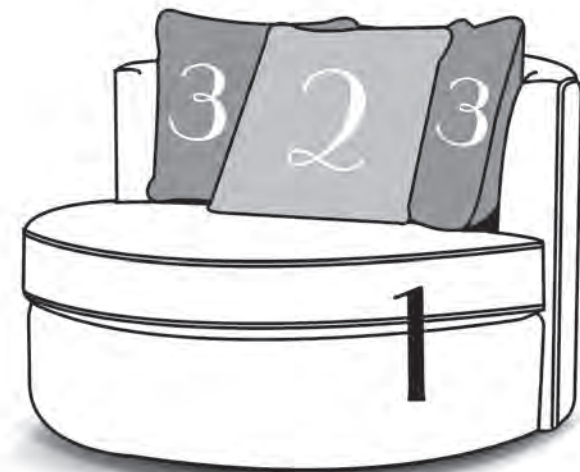



2400-81



24081AL



240081X

*Malibu/Lochlan*  
**2400/2400AL SERIES**



# Malibu/Lochlan

## 2400/2400AL SERIES



© 2023 England, Inc.

### Dimensions

		<i>O.A</i> <i>LENGTH</i>	<i>O.A</i> <i>DEPTH</i>	<i>O.A</i> <i>HEIGHT</i>
<b>2400-81</b>	Storage Ottoman	40"	24"	18"
<b>240081X</b>	Storage Ottoman	47"	29"	18"
<b>24081AL</b>	Storage Ottoman	40"	24"	18"

**Fabric in Photo:** 2400-81: Durango Metro  
 240081X Brentwood Pepper  
 24081AL: Salvador Suede

Apr 23

Vent holes are standard  
 in ALL storage ottomans  
 to prevent suffocation.



2400-81



240081X



24081AL

### Features

- Cushions/Seat** Block foam with polyester fiber wrap
- Fabric Types Available** **2400/2400X:** 1, 6, 11, 12, 14, 22  
**2400AL:** 10, 25, 27
- Legs/Plastic** Black Casters (Screw-In)
- Seating/Tight** Standard
- Storage** Standard
- Welt Matching** Standard





*Winnie*  
**2550 SERIES**

# Winnie

## 2550 SERIES



© 2021 England, Inc.

### Dimensions

	<i>O.A</i> <i>LENGTH</i>	<i>O.A</i> <i>DEPTH</i>	<i>O.A</i> <i>HEIGHT</i>	<i>SEAT</i> <i>LENGTH</i>	<i>SEAT</i> <i>DEPTH</i>	<i>SEAT</i> <i>HEIGHT</i>
2554 Chair	30"	38"	36"	22"	23"	20"

*Fabric in Photo:* Mazur Dove

Oct 21

### Features

<b>Cushion/Back</b>	Sinuous Wire
<b>Cushions/Back/Attached</b>	Block foam with polyester fiber cap
<b>Cushions/Seat</b>	Block foam with polyester fiber wrap
<b>Cushions/Ventilated</b>	Standard
<b>Fabric Types Available</b>	1, 6, 11, 14, 22
<b>Legs/Wood</b>	<b>Front:</b> 2.875" x 1.625" x 6" H. Tapered (Screw-In) <b>Rear:</b> 2.5" x 1.75" x 6" H. (Screw-In)
<b>Options Available</b>	<ul style="list-style-type: none"> <li>• <b>CK</b> - Coil Cushions</li> <li>• <b>FK</b> - Frame Coil (Coil Core)</li> </ul>
<i>(Additional Charge)</i>	
<b>Seat Construction</b>	Sinuous Wire
<b>Seating/Loose/Reversible</b>	Standard
<b>Welt/Matching</b>	Standard
<b>Wood Trim</b>	Dark brown finish on legs





2580



2580AL

*Harvey*  
**2580/2580AL SERIES**

# Harvey

## 2580/2580AL SERIES

**England**  
FURNITURE CO.

© 2022 England, Inc.

### Dimensions

		<i>O.A</i>	<i>O.A</i>	<i>O.A</i>	<i>SEAT</i>	<i>SEAT</i>	<i>SEAT</i>
		<i>LENGTH</i>	<i>DEPTH</i>	<i>HEIGHT</i>	<i>LENGTH</i>	<i>DEPTH</i>	<i>HEIGHT</i>
<b>2584</b>	Chair	31"	38"	44"	21"	22"	21"
<b>2584AL</b>	Chair	31"	38"	44"	21"	22"	21"

*Fabric in Photo:* 2580: Tehama Granite  
2580AL: Cheyenne Stirrup

Oct 22

### Features

#### Cushions/Back

Sinuuous Wire

#### Cushions/Back/Semi-Attached

Polyester fiber fill - *Zipper Access*

#### Cushions/Seat

Block foam with polyester fiber wrap

#### Cushions/Ventilated

Standard

#### Fabric Types Available

**2580:** 1, 6, 11, 12, 14, 22

**2580AL:** 10, 25

#### Legs/Wood

**Front:** 2.25" x 1.375" x 7" H. (*Screw-In*)

**Back:** 3.125" x 7" H. (*Screw-In*)

#### Options/Available

• **CK** - Coil Cushion

(*Additional Charge*)

• **FK** - Frame Coil (Coil Core)

#### Seat Construction

Sinuuous Wire

#### Seating/Loose/Non-Reversible

Standard on 2580AL

#### Seating/Loose/Reversible

Standard on 2580

#### Welt/Matching

Standard

#### Wood Trim

Dark Brown finish on legs

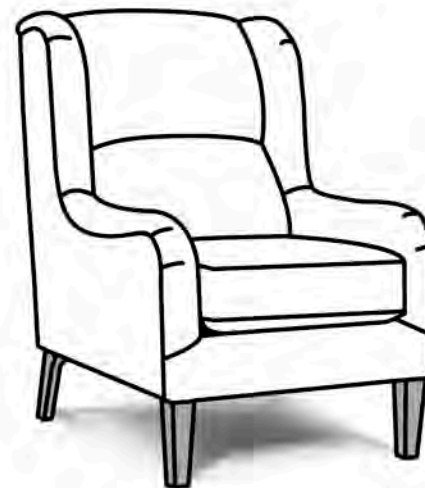

2580



2580AL





*Birdie*  
**2850 SERIES**

# Birdie

## 2850 SERIES



© 2022 England, Inc.

### Dimensions

		<i>O.A</i>	<i>O.A</i>	<i>O.A</i>	<i>SEAT</i>	<i>SEAT</i>	<i>SEAT</i>
		<i>LENGTH</i>	<i>DEPTH</i>	<i>HEIGHT</i>	<i>LENGTH</i>	<i>DEPTH</i>	<i>HEIGHT</i>
2854	Chair	34"	36"	38"	24"	21"	21"

*Fabric in Photo:* Duomo Jewel

Apr 22

### Features

- Cushions/Back** Sinuous Wire
- Cushions/Back/Semi-Attached** Block foam with polyester fiber wrap - Zipper Access
- Cushions/Seat** Block foam with polyester fiber wrap
- Cushions/Ventilated** Standard
- Fabric Types Available** 1, 6, 11, 12, 14, 22
- Legs/Wood** 2" x 6" H. Round Tapered (Screw-In)
- Options/Available**
  - **CK** - Coil Cushion
  - **FK** - Frame Coil (Coil Core)
- Seat Construction** Sinuous Wire
- Seating/Loose/Reversible** Standard
- Wood Trim** Dark Brown finish on legs





2900S



2900M

*Hutton*

**2900S/2900M SERIES**

# Hutton

## 2900S/2900M SERIES

**England**  
FURNITURE CO.

© 2023 England, Inc.

### Dimensions

		<i>O.A.</i> <i>LENGTH</i>	<i>O.A.</i> <i>DEPTH</i>	<i>O.A.</i> <i>HEIGHT</i>
<b>2907S</b>	Small Ottoman	19"	19"	19"
<b>2907M</b>	Medium Ottoman	25"	25"	19"

*Fabric in Photo:* **2900S:** Dapper Solitude  
**2900M:** Hixon Seaglass

Apr 23

### Features

<b>Cushions/Seat</b>	Block foam with polyester fiber wrap
<b>Fabric Types Available</b>	1, 6, 11, 12, 14, 22
<b>Legs/Plastic</b>	Black Casters (Screw-In)
<b>Welt/Matching</b>	Standard



2900S

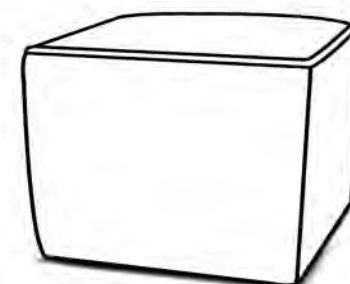

2900M





2910-69



2914



2914AL

*Loren/Louis*  
**2910/2910AL SERIES**

# Loren/Louis

## 2910/2910AL SERIES



© 2023 England, Inc.

### Dimensions

		<i>O.A</i> <i>LENGTH</i>	<i>O.A</i> <i>DEPTH</i>	<i>O.A</i> <i>HEIGHT</i>	<i>SEAT</i> <i>LENGTH</i>	<i>SEAT</i> <i>DEPTH</i>	<i>SEAT</i> <i>HEIGHT</i>
<b>2914/2914AL</b>	Chair	31"	37"	40"	21"	20"	21"
<b>2910-69/29169AL</b>	Swivel Chair	31"	37"	40"	21"	20"	21"
<b>2917/2917AL</b>	Ottoman	23"	19"	18"			

*Fabric in Photo:* **2910-69:** Triplet Party  
**2914:** Phelps Greystone  
**2914AL:** Revelation Steel

Apr 23

AL = All Leather

### Features

- Cushions/Backs** Webbing & Sinuous Wire
- Cushions/Back/Semi-Attached** Polyester fiber fill - *Zipper Access*
- Cushions/Seat** Block foam with polyester fiber wrap
- Cushions/Ventilated** Standard
- Fabric Types Available**
  - 2910:** 1, 6, 11, 14, 22
  - 2910AL:** 10, 25, 27
- Legs/Wood** 5" H. Tapered (Screw-In); -69: Swivel Base
- Options/Available**
  - **CK:** Coil Cushions except the Ottomans
  - **FK:** Frame Coil (Coil Core) except the Ottomans
- Seat Construction** Sinuous Wire
- Seating/Loose/Non-Reversible** **2910AL:** Standard
- Seating/Loose/Reversible** **2910:** Standard
- Welt/Matching** Standard
- Wood Trim** Dark Brown finish on legs except -69



**2914**



**2910-69**



3C0069N



3C20-69

*Jakson/Cunningham*  
**3C00/3C00N SERIES**  
**3C20/3C20N SERIES**



# Jakson/Cunningham

## 3C00/3C00N SERIES 3C20/3C20N



© 2022 England, Inc.

### Dimensions

		<i>O.A</i> <i>LENGTH</i>	<i>O.A</i> <i>DEPTH</i>	<i>O.A</i> <i>HEIGHT</i>	<i>SEAT</i> <i>LENGTH</i>	<i>SEAT</i> <i>DEPTH</i>	<i>SEAT</i> <i>HEIGHT</i>
3C04/3C04N/3C24/3C24N	Chair	32"	36"	36"	21"	20"	21"
3C00-69/3C0069N/3C20-69/3C2069N	Swivel Chair	32"	36"	34"	21"	20"	19"

*Fabric in Photo:* 3C0069N: Syren River  
3C20-69: Colantino Marble

Apr 22

N = Nails

### Features

**Cushions/Back**

Sinuous Wire

**Cushions/Back/Attached**

Block foam with polyester fiber wrap

**Cushions/Seat**

Block foam with polyester fiber wrap

**Cushions/Ventilated**

Standard

**Fabric Types Available**

**3C00/3C00N:** 1, 6, 11, 14, 22

**3C20/3C20N:** 4, 16

**Legs/Wood**

3.25" x 2.75" x 2.75" H. Tapered (Screw-In)

-69: Swivel Base

**Options/Available**

• **CK** - Coil cushions

*(Additional Charge)*

• **FK** - Frame Coil (Coil Core)

**Seat Construction**

Sinuous Wire

**Seating/Loose/Reversible**

Standard

**Trim-Brass Nails**

Standard on 3C00N & 3C20N

**Welt/Matching**

Standard

**Wood Trim**

Dark Brown finish on legs

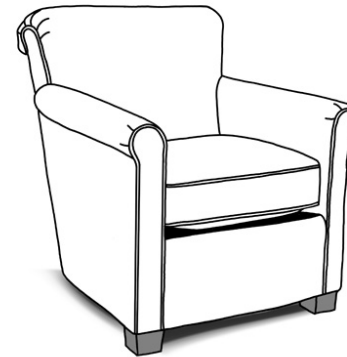

3C00

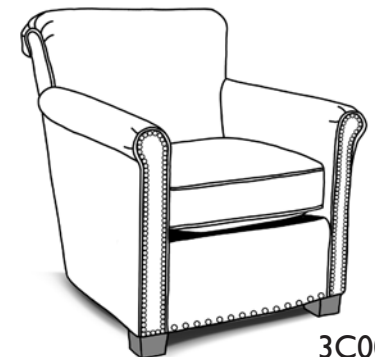

3C00N



3C20



3C20N





3D00



3D00AL

*Kenzie/Maddox*  
**3D00/3D00AL SERIES**

# Kenzie/Maddox

## 3D00/3D00AL SERIES



© 2021 England, Inc.

### Dimensions

		<i>O.A</i> <i>LENGTH</i>	<i>O.A</i> <i>DEPTH</i>	<i>O.A</i> <i>HEIGHT</i>	<i>SEAT</i> <i>LENGTH</i>	<i>SEAT</i> <i>DEPTH</i>	<i>SEAT</i> <i>HEIGHT</i>
<b>3D00-31</b>	Motion Chair	36"	36"	44"	21"	20"	20"
<b>3D031AL</b>	Motion Chair	36"	36"	44"	21"	20"	20"

*Fabric in Photo:* **3D00:** Greenbrier Flannel  
**3D00AL:** Evolution Fox

June 21

### Features

- Cushions/Back** Webbing w/Sinuous Wire
- Cushions/Back/Semi-Attached** Polyester fiber fill - *Zipper Access*
- Cushions/Seat** Block foam with polyester fiber wrap
- Fabric Types Available**
  - 3D00:** 1, 6, 11, 14, 22
  - 3D00AL:** 10, 25, 27
- Legs/Wood**
  - Front: 2.875" x 1.5" x 6" H. Tapered (*Screw-In*)
  - Rear: 6" H. Tapered (*Screw-In*)
- Options/Available**
  - **FK** - Frame Coil (Coil Core)
  - **PM** - Power
  - **PB** - Power w/Battery Pack
- Seat Construction** Sinuous Wire
- Seating/Tight** Standard
- Welt/Matching** Standard
- Wood Trim** Dark Brown finish on legs

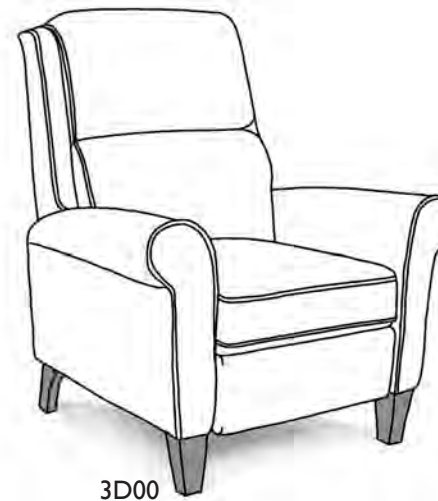



*Ellis*  
**3500 SERIES**



# Ellis

## 3S00 SERIES



© 2022 England, Inc.

### Dimensions

	<i>O.A</i> <i>LENGTH</i>	<i>O.A</i> <i>DEPTH</i>	<i>O.A</i> <i>HEIGHT</i>	<i>SEAT</i> <i>LENGTH</i>	<i>SEAT</i> <i>DEPTH</i>	<i>SEAT</i> <i>HEIGHT</i>
<b>3S00-69</b> Swivel Chair	38"	40"	32"	38"	22"	19"

*Fabric in Photo:* Burmese Birch p/p Potrero Granite

Apr 22

\*SPECIAL FABRIC INSTRUCTIONS

1st: Body, 2nd: Pillow, 3rd: Pillow

### Features

<b>Cushions/Back</b>	Sinuous Wire
<b>Cushions/Back/Loose</b>	Polyester fiber fill
<b>Cushions/Seat</b>	Block foam with polyester fiber wrap
<b>Cushions/Ventilated</b>	Standard
<b>Fabric Types Available</b>	1, 6, 11, 12, 14, 22
<b>Legs</b>	Swivel Base
<b>Options/Available</b> <i>(Additional Charge)</i>	<ul style="list-style-type: none"> <li>● <b>CK</b> - Coil Cushions</li> <li>● <b>DP</b> - Feather Blend Pillow</li> <li>● <b>FK</b> - Frame Coil (Coil Core)</li> </ul>
<b>Pillows/Contrasting</b>	Standard (Two — 20" x 20")
<b>Pillows/Matching</b>	Available
<b>Pillows/Fabric Types Available</b>	1, 2, 3, 4, 6, 11, 12, 14, 15, 16, 22, 24
<b>Seat Construction</b>	Sinuous Wire
<b>Seating/Loose/Reversible</b>	Standard







*Rayden*  
**3110 SERIES**

# Rayden

## 3110 SERIES



© 2022 England, Inc.

### Dimensions

	<i>O.A</i> <i>LENGTH</i>	<i>O.A</i> <i>DEPTH</i>	<i>O.A</i> <i>HEIGHT</i>	<i>SEAT</i> <i>LENGTH</i>	<i>SEAT</i> <i>DEPTH</i>	<i>SEAT</i> <i>HEIGHT</i>
<b>3110-69</b> Swivel Chair	38"	38"	36"	24"	22"	21"

*Fabric in Photo:* Scandi Onyx

Oct 22

### Features

<b>Cushions/Back/Semi-Attached</b>	Polyester fiber fill in a channel bag - <i>Zipper Access</i>
<b>Cushions/Seat</b>	Block foam with polyester fiber wrap
<b>Cushions/Ventilated</b>	Standard
<b>Fabric Types Available</b>	1, 6, 11, 12, 14, 22
<b>Legs/Plastic</b>	1.5" H. (Screw-In)
<b>Options/Available</b> <i>(Additional Charge)</i>	<ul style="list-style-type: none"> <li>● <b>CK</b> - Coil Cushion</li> <li>● <b>FK</b> - Frame Coil (Coil Core)</li> </ul>
<b>Seat Construction</b>	Sinuous Wire
<b>Seating/Loose/Reversible</b>	Standard





3310



3310AL



3320

*Pierce*  
**3310/3310AL/3320 SERIES**

Pierce

## 3310/3310AL/3320 SERIES

**England**  
FURNITURE CO.

© 2022 England, Inc.

### Dimensions

		<i>O.A</i>	<i>O.A</i>	<i>O.A</i>	<i>SEAT</i>	<i>SEAT</i>	<i>SEAT</i>
		<i>LENGTH</i>	<i>DEPTH</i>	<i>HEIGHT</i>	<i>LENGTH</i>	<i>DEPTH</i>	<i>HEIGHT</i>
<b>3310-71</b>	Swivel Glider	35"	36"	36"	21"	21"	20"
<b>33171AL</b>	Swivel Glider	35"	36"	36"	21"	21"	20"
<b>3320-71</b>	Swivel Glider	35"	36"	36"	21"	21"	20"

*Fabric in Photo:* **3310:** Fleeced Oyster  
**3310AL:** Cheyenne Rifle  
**3320:** Santiago Denim

Oct 22

### Features

**Cushions/Back**

Sinuous Wire

**Cushions/Back/Semi-Attached**

Block foam with polyester fiber cap

**Cushions/Seat**

Block foam with polyester fiber wrap

**Cushions/Ventilated**

Standard

**Fabric Types Available**

3310: 1, 6, 11, 12, 14, 22

3310AL: 10, 25

3320: 4, 16

**Legs/Wood**

Swivel Glider

**Options/Available**

• **CK** - Coil cushions

*(Additional Charge)*

**Seat Construction - FK Standard**

Sinuous Wire

*(Frame Coil (Coil Core))*

**Seating/Loose/Non-Reversible**

Standard on 3310AL only

**Seating/Loose/Reversible**

Standard on 3310 & 3320



3310



3310AL



3320





*Henley*  
**3350 SERIES**

# Henley

## 3350 SERIES



© 2023 England, Inc.

### Dimensions

	<i>O.A</i> <i>LENGTH</i>	<i>O.A</i> <i>DEPTH</i>	<i>O.A</i> <i>HEIGHT</i>	<i>SEAT</i> <i>LENGTH</i>	<i>SEAT</i> <i>DEPTH</i>	<i>SEAT</i> <i>HEIGHT</i>
<b>3350-69</b> Swivel Chair	29"	34"	35"	22"	22"	22"
<i>Fabric in Photo:</i> Modern Greystone						Apr 23

### Features

<b>Cushions/Back</b>	Sinuous Wire
<b>Cushions/Back/Semi-Attached</b>	Polyester fiber fill - <i>Zipper Access</i>
<b>Cushions/Seat</b>	Block foam with polyester fiber wrap
<b>Cushions/Ventilated</b>	Standard
<b>Fabric Types Available</b>	1, 6, 11, 14, 22
<b>Legs/Wood</b>	Swivel Base with finished wood legs
<b>Seat Construction</b>	Sinuous Wire
<b>Seating/Loose/Reversible</b>	Standard
<b>Wood Trim</b>	Dark brown finish on legs

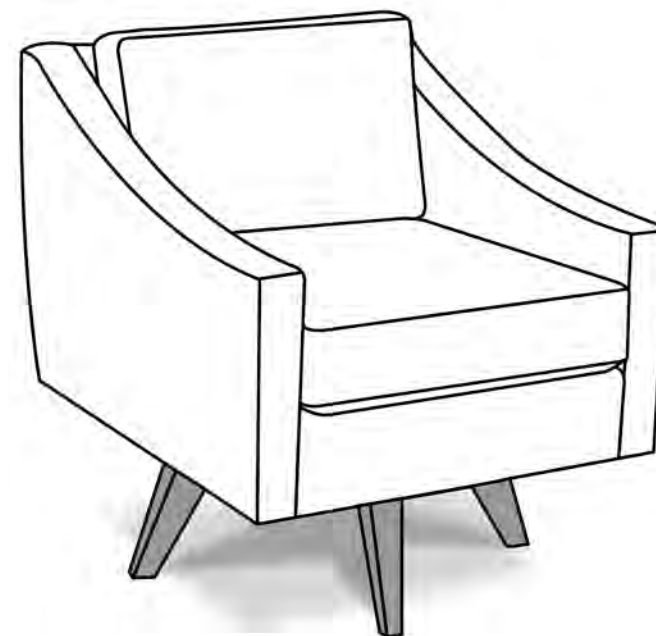



3550



3550AL

*Midtown/Auden*  
**3550/3550AL SERIES**

# Midtown/Auden

## 3550/3550AL SERIES



© 2023 England, Inc.

### Dimensions

	<i>O.A</i> <i>LENGTH</i>	<i>O.A</i> <i>HEIGHT</i>
<b>3550-81</b> Round Storage Ottoman	36" dia.	18"
<b>35581AL</b> Round Storage Ottoman	36" dia.	18"

*Fabric in Photo:* **3550-81:** Spin City Flannel Apr 23  
**3550AL:** Groundworx Groovy

Vent holes are standard in ALL storage ottomans to prevent suffocation.

### Features

<b>Cushions/Seat</b>	Block foam with polyester fiber wrap
<b>Fabric Types Available</b>	<b>3550:</b> 1, 6, 11, 12, 14, 22 <b>3550AL:</b> 10, 25, 27
<b>Legs/Plastic</b>	Black Casters (Screw-In)
<b>Seating/Loose/Non-Reversible</b>	Standard
<b>Storage</b>	Standard
<b>Welt/Matching</b>	Standard

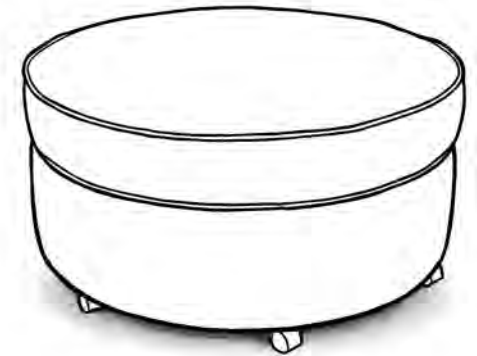

3550-81

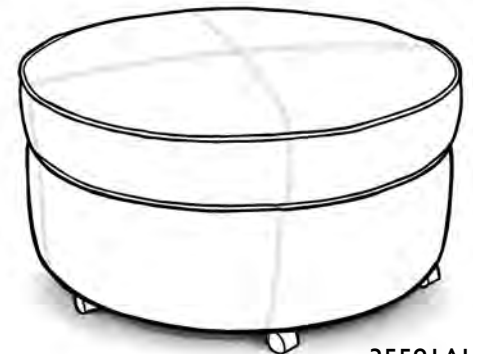

35581AL





*Taylor*  
**3700 SERIES**

# Taylor

## 3700 SERIES

*England*  
FURNITURE CO.

© 2023 England, Inc.

### Dimensions

		<i>O.A</i> <i>LENGTH</i>	<i>O.A</i> <i>DEPTH</i>	<i>O.A</i> <i>HEIGHT</i>	<i>SEAT</i> <i>LENGTH</i>	<i>SEAT</i> <i>DEPTH</i>	<i>SEAT</i> <i>HEIGHT</i>
<b>3700-71</b>	Swivel Glider	30"	36"	36"	23"	22"	21"
<i>Fabric in Photo:</i> Droplet Coral							Oct 21

### Features

<b>Cushions/Back</b>	Sinuous Wire
<b>Cushions/Back/Attached</b>	Block foam with polyester fiber cap
<b>Cushions/Seat</b>	Block foam with polyester fiber wrap
<b>Cushions/Ventilated</b>	Standard
<b>Fabric Types Available</b>	1, 6, 11, 12, 14, 22
<b>Legs</b>	Swivel Glider Base with black plastic glides
<b>Options/Available</b> <i>(Additional Charge)</i>	<ul style="list-style-type: none"> <li>● <b>CK</b> - Coil Cushion</li> <li>● <b>FK</b> - Frame Coil (Coil Core)</li> </ul>
<b>Seat Construction</b>	Sinuous Wire
<b>Seating/Loose/Reversible</b>	Standard





*Pharris*  
**3800 SERIES**

# Pharris

## 3800 SERIES



© 2021 England, Inc.

### Dimensions

		<i>O.A</i>	<i>O.A</i>	<i>O.A</i>	<i>SEAT</i>	<i>SEAT</i>	<i>SEAT</i>
		<i>LENGTH</i>	<i>DEPTH</i>	<i>HEIGHT</i>	<i>LENGTH</i>	<i>DEPTH</i>	<i>HEIGHT</i>
<b>3800-31</b>	Motion Chair	31"	36"	44"	20"	21"	21"

*Fabric in Photo:* Castor Flint

June 21

### Features

<b>Cushions/Back</b>	Webbing with Sinuous Wire
<b>Cushions/Back/Semi-Attached</b>	Block foam with polyester fiber wrap - <i>Zipper Access</i>
<b>Cushions/Seat</b>	Block foam with polyester fiber wrap
<b>Fabric Types Available</b>	1, 6, 11, 12, 14, 22
<b>Legs/Wood</b>	Front: 2.875" x 1.625" x 6" H. Tapered ( <i>Screw-In</i> ) Rear: 6" H. Tapered ( <i>Screw-In</i> )
<b>Options/Available</b> ( <i>Additional Charge</i> )	<ul style="list-style-type: none"> <li>● <b>PB</b> - Power w/Battery Pack</li> <li>● <b>PM</b> - Power Mech</li> </ul>
<b>Seat Construction</b>	Sinuous Wire
<b>Seating/Tight</b>	Standard
<b>Welt/Matching</b>	Standard
<b>Wood Trim</b>	Dark Brown finish on legs







3900



3900AL

*Hayli*  
**3900/3900AL SERIES**

# Hayli

## 3900/3900AL SERIES

**England**  
FURNITURE CO.

© 2023 England, Inc.

### Dimensions

		<i>O.A</i>	<i>O.A</i>	<i>O.A</i>	<i>SEAT</i>	<i>SEAT</i>	<i>SEAT</i>
		<i>LENGTH</i>	<i>DEPTH</i>	<i>HEIGHT</i>	<i>LENGTH</i>	<i>DEPTH</i>	<i>HEIGHT</i>
<b>3904</b>	Chair	33"	37"	36"	24"	20"	21"
<b>3904AL</b>	Chair	33"	37"	36"	24"	20"	21"

*Fabric in Photo:* 3900: Aztec Onyx  
3900AL: Revelation Steel

Apr 23

### Features

<b>Cushions/Back</b>	Sinuous Wire
<b>Cushions/Back/Semi-Attached</b>	Block foam with polyester fiber wrap - <i>Zipper Access</i>
<b>Cushions/Seat</b>	Block foam with polyester fiber wrap
<b>Cushions/Ventilated</b>	Standard
<b>Fabric Types Available</b>	<b>3900:</b> 1, 6, 11, 12, 14, 22 <b>3900AL:</b> 10, 25, 27
<b>Legs/Wood</b>	3" x 3" x 2.25" H (Screw-In)
<b>Options/Available</b> <i>(Additional Charge)</i>	<ul style="list-style-type: none"><li>● <b>CK</b> - Coil cushions</li><li>● <b>FK</b> - Frame Coil (Coil Core)</li></ul>
<b>Seat Construction</b>	Sinuous Wire
<b>Seating/Loose/Non-Reversible</b>	Standard on 3900AL only
<b>Seating/Loose/Reversible</b>	Standard on 3900
<b>Wood Trim</b>	Dark Brown finish on legs

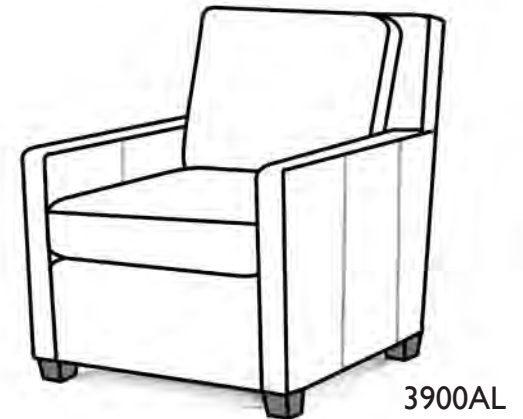



*Corey*  
**4B00 SERIES**

# Corey

## 4B00 SERIES

See digital catalog for  
most up to date information.

**England**  
FURNITURE CO.

© 2023 England, Inc.

### Dimensions

	<i>O.A</i> <i>LENGTH</i>	<i>O.A</i> <i>DEPTH</i>	<i>O.A</i> <i>HEIGHT</i>	<i>SEAT</i> <i>LENGTH</i>	<i>SEAT</i> <i>DEPTH</i>	<i>SEAT</i> <i>HEIGHT</i>
<b>4B00-33</b> Swivel Chair	41"	38"	39"	18"	21"	19"

*Fabric in Photo:* Mega Ivory

Oct 23

### Features

<b>Cushions/Back</b>	Sinuous Wire
<b>Cushions/Back/Attached</b>	Block foam with polyester fiber cap - <i>Zipper Access</i>
<b>Cushions/Seat</b>	Block foam with polyester fiber wrap
<b>Fabric Types Available</b>	1, 6, 11, 12, 14, 22
<b>Legs</b>	Swivel Base
<b>Options/Available</b> <i>(Additional Charge)</i>	<ul style="list-style-type: none"> <li>● <b>FK</b> - Frame Coil (Coil Core)</li> </ul>
<b>Seat Construction</b>	Sinuous Wire
<b>Seating/Tight/Non-Reversible</b>	Standard







*Walker*  
**4000 SERIES**

# Walker

## 4G00 SERIES



© 2022 England, Inc.

### Dimensions

	<i>O.A</i> <i>LENGTH</i>	<i>O.A</i> <i>DEPTH</i>	<i>O.A</i> <i>HEIGHT</i>
<b>4G00-81</b> Storage Ottoman	29"	27"	18"

*Fabric in Photo:* Jillian Jasper

Apr 22

Vent holes are standard  
in ALL storage ottomans  
to prevent suffocation.

### Features

<b>Cushions/Seat</b>	Block foam with polyester fiber wrap
<b>Fabric Types Available</b>	1, 6, 11, 14, 22
<b>Legs/Plastic</b>	Black Casters (Screw-In)
<b>Seating/Tight</b>	Standard
<b>Storage</b>	Standard
<b>Welt/Matching</b>	Standard

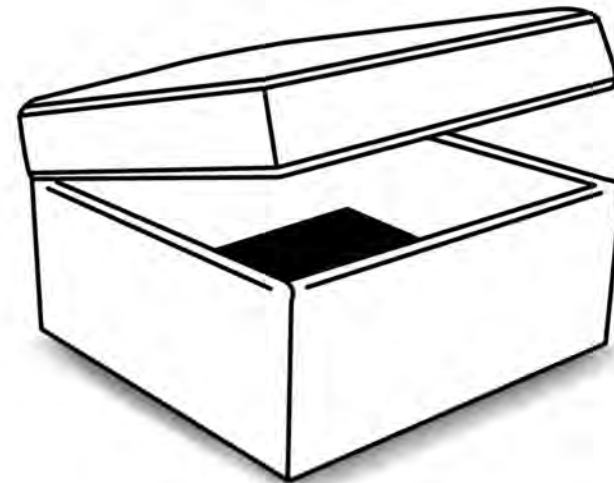



4530N



4530AL

*Saylor/Luther*

**4530/4530N/4530AL/4530ALN SERIES**

# Saylor/Luther

## 4530/4530N SERIES

## 4530AL/4530ALN SERIES



© 2022 England, Inc.

### Dimensions

		<i>O.A</i>	<i>O.A</i>	<i>O.A</i>	<i>SEAT</i>	<i>SEAT</i>	<i>SEAT</i>
		<i>LENGTH</i>	<i>DEPTH</i>	<i>HEIGHT</i>	<i>LENGTH</i>	<i>DEPTH</i>	<i>HEIGHT</i>
4534/N	Chair	32"	34"	42"	20"	21"	20"
4534AL/ALN	Chair	32"	34"	42"	20"	21"	20"

*Fabric in Photo:* 4534N: Spin City Flannel  
4534AL: Galveston Vintage\*

Oct 22

\*Discontinued fabric for viewing purposes only

### Features

<b>Cushions/Backs</b>	Sinuous Wire
<b>Cushions/Back/Attached</b>	Block foam with polyester fiber wrap
<b>Cushions/Seat</b>	Block foam with polyester fiber wrap
<b>Cushions/Ventilated</b>	Standard
<b>Fabric Types Available</b>	<b>4530/N:</b> 1, 6, 11, 14, 22 <b>4530AL/ALN:</b> 10, 25
<b>Options/Available</b> <i>(Additional Charge)</i>	• <b>FK</b> - Frame Coil (Coil Core) except the Ottoman
<b>Legs/Wood</b>	Front: 2.5" x 7.125" H. Pyramid; Rear: 2" x 7.125" H. <i>(Screw-In)</i>
<b>Seat Construction</b>	Sinuous Wire
<b>Seating/Loose/Non-Reversible</b>	Standard on 4530AL/ALN
<b>Seating/Loose/Reversible</b>	Standard on 4530/N
<b>Trim - Silver Nails</b>	Standard on 4530N & 4530ALN
<b>Welt/Matching</b>	Standard
<b>Wood Trim</b>	Dark brown finish on legs

*N = Nails*



4534N/4534ALN



4534/4534AL





*Smith*  
**4540/4540N SERIES**

# Smith

## 4540/4540N SERIES



© 2023 England, Inc.

### Dimensions

		O.A LENGTH	O.A DEPTH	O.A HEIGHT	SEAT LENGTH	SEAT DEPTH	SEAT HEIGHT
4544/N	Chair	32"	34"	42"	20"	21"	20"
<i>Fabric in Photo:</i> Mason Bisque / Wolcott Portobello							Apr 23

**\*SPECIAL FABRIC INSTRUCTIONS**  
 1st: Seat cushion, inside arm & back, seat deck & deck welt.  
 2nd: Outside arm, wing & back, Outside wing welt, Bottom of outside back, rollup welt

N = Nails

### Features

- Cushions/Backs** Sinuous Wire
- Cushions/Back/Attached** Block foam with polyester fiber wrap
- Cushions/Seat** Block foam with polyester fiber wrap
- Cushions/Ventilated** Standard
- Fabric Types Available** 1, 6, 11, 14, 22
- Legs/Wood** Front: 2.5" x 7.125" H. Taper;  
Rear: 2" x 7.125" H. (Screw-In)
- Options/Available**
  - **FK** - Frame Coil (Coil Core)
- (Additional Charge)*
- Seat Construction** Sinuous Wire
- Seating/Loose/Non-Reversible** Standard
- Trim - Silver Nails** Standard on 4540N only
- Welt/Matching** Standard
- Wood Trim** Dark brown finish on legs



4540



4540N



*Caylor*  
**4550 SERIES**

# Caylor

## 4550 SERIES



© 2023 England, Inc.

### Dimensions

	<i>O.A</i> <i>LENGTH</i>	<i>O.A</i> <i>DEPTH</i>	<i>O.A</i> <i>HEIGHT</i>
<b>4550-10</b> Large Ottoman	37"	37"	17"
<i>Fabric in Photo:</i> Dottie Silver			June 21

### Features

<b>Cushions/Seat</b>	Block foam w/polyester fiber wrap
<b>Fabric Types Available</b>	1, 6, 11, 12, 14, 22
<b>Legs/Wood</b>	3.25" x 3.25" x 2.75" H (Screw-In)
<b>Seat Construction</b>	Sinuous Wire
<b>Seating/Tight</b>	Standard
<b>Welt/Matching</b>	Standard
<b>Wood Trim</b>	Dark Brown finish on legs

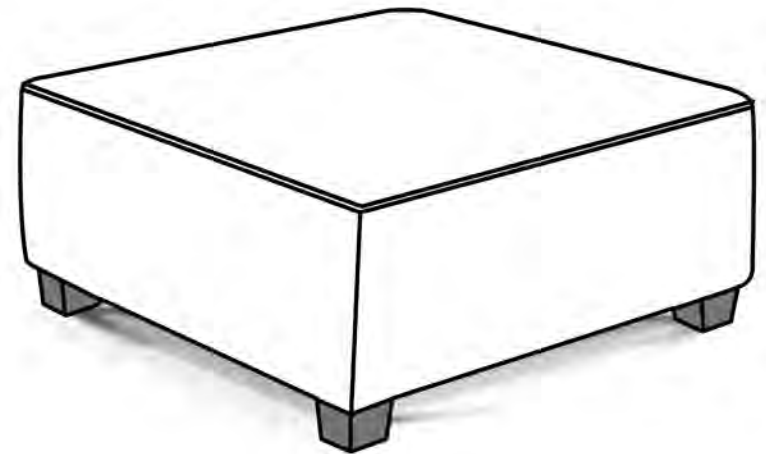





*Ezra*  
**4610 SERIES**

# Ezra

## 4610 SERIES



© 2021 England, Inc.

### Dimensions

	<i>O.A</i> <i>LENGTH</i>	<i>O.A</i> <i>DEPTH</i>	<i>O.A</i> <i>HEIGHT</i>	<i>SEAT</i> <i>LENGTH</i>	<i>SEAT</i> <i>DEPTH</i>	<i>SEAT</i> <i>HEIGHT</i>
<b>4610-69</b> Swivel Chair	29"	35"	39"	21"	22"	22"
<i>Fabric in Photo:</i> Casual Fog						June 21

### Features

<b>Cushions/Back</b>	Sinuous Wire
<b>Cushions/Back/Attached</b>	Black foam with Polyester fiber cap
<b>Cushions/Seat</b>	Block foam with polyester fiber wrap
<b>Cushions/Ventilated</b>	Standard
<b>Fabric Types Available</b>	1, 6, 11, 12, 14, 22
<b>Legs/Wood</b>	Swivel Base with finished wood legs
<b>Seat Construction</b>	Sinuous Wire
<b>Seating/Reversible</b>	Standard
<b>Wood Trim</b>	Dark brown finish on legs

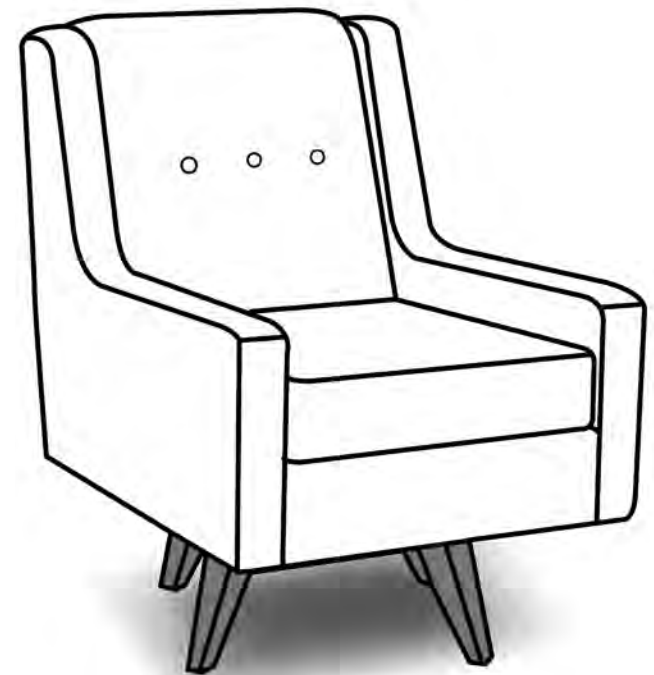



**4850**



**4850AL**



**4890**



**4890L**

*Levi*  
**4850/AL SERIES**  
**4890/L SERIES**

**Levi**  
**4850/AL SERIES**  
**4890/L SERIES**

*See digital catalog for  
most up to date information.*



© 2023 England, Inc.

**Dimensions**

		<i>O.A</i> <i>LENGTH</i>	<i>O.A</i> <i>DEPTH</i>	<i>O.A</i> <i>HEIGHT</i>	<i>SEAT</i> <i>LENGTH</i>	<i>SEAT</i> <i>DEPTH</i>	<i>SEAT</i> <i>HEIGHT</i>
<b>4854</b>	Chair	31"	40"	43"	22"	21"	22"
<b>4854AL</b>	Chair	31"	40"	43"	22"	21"	22"
<b>4894</b>	Chair	31"	40"	43"	22"	21"	22"
<b>4894L</b>	Chair	31"	40"	43"	22"	21"	22"

**\*SPECIAL FABRIC INSTRUCTIONS**

4584/4854AL: Body  
4894/4894L: 1st Outside Fabric; 2nd Inside Fabric

*Fabric in Photo: 4850: Mazur Dove*

*4850AL: Rumor Eclipse*

*4890: Drumbeat Chocolate/Tatum River Rock*

*4890L: Evolution Caribou/Succor Hickory*

Oct 23

**Features**

- Cushions/Back** Sinuous Wire
- Cushions/Back/Semi-Attached** Block foam with polyester fiber wrap - *Zipper Access*
- Cushions/Seat** Block foam with polyester fiber wrap
- Cushions/Ventilated** Standard
- Fabric Types Available**

**4850:** 1, 6, 11, 12, 14, 22  
**4850AL:** 10, 25  
**4890:** 1, 6, 11, 12, 14, 22  
**4890L:** outside 10, 25; inside 1, 6, 11, 12, 14, 22
- Legs/Wood** 1.6" x 2.88" x 6" H (*Screw-In*)
- Options/Available**
  - **CK** - Coil cushions
  - **FK** - Frame Coil (Coil Core)
- Seat Construction** Sinuous Wire
- Seating/Loose/Reversible** Standard except 4854AL
- Wood Trim** Dark Brown finish on legs



4850



4850AL



4890



4890L





4950



4950N

*Emory*  
**4950/4950N SERIES**

# Emory

## 4950/4950N SERIES

*England*  
FURNITURE CO.

© 2022 England, Inc.

### Dimensions

		<i>O.A</i>	<i>O.A</i>	<i>O.A</i>	<i>SEAT</i>	<i>SEAT</i>	<i>SEAT</i>
		<i>LENGTH</i>	<i>DEPTH</i>	<i>HEIGHT</i>	<i>LENGTH</i>	<i>DEPTH</i>	<i>HEIGHT</i>
<b>4950-71</b>	Swivel Glider	33"	37"	40"	23"	23"	21"
<b>495071N</b>	Swivel Glider	33"	37"	40"	23"	23"	21"

*Fabric in Photo:* 4950: Phelps Greystone  
4950N: Anita Oyster

Oct 22

N = Nails

### Features

<b>Cushions/Back</b>	Sinuous Wire
<b>Cushions/Back/Semi-Attached</b>	Block foam with polyester fiber wrap - <i>Zipper Access</i>
<b>Cushions/Seat</b>	Block foam with polyester fiber wrap
<b>Cushions/Ventilated</b>	Standard
<b>Fabric Types Available</b>	1, 6, 11, 12, 14 & 22
<b>Legs</b>	Swivel Glider Base
<b>Options/Available</b> <i>(Additional Charge)</i>	<ul style="list-style-type: none"> <li>● <b>CK</b> - Coil Cushion</li> <li>● <b>FK</b> - Frame Coil (Coil Core)</li> </ul>
<b>Seat Construction</b>	Sinuous Wire
<b>Seating/Reversible</b>	Standard
<b>Trim - Pewter Nails</b>	Standard on 4950N
<b>Welt/Matching</b>	Standard

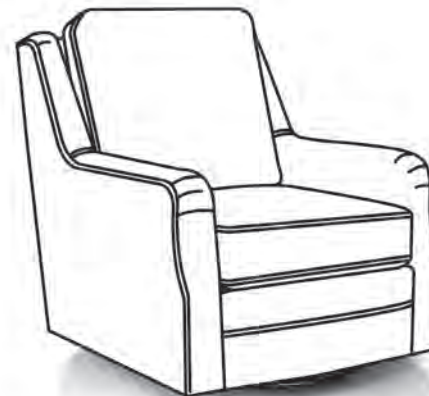

4950

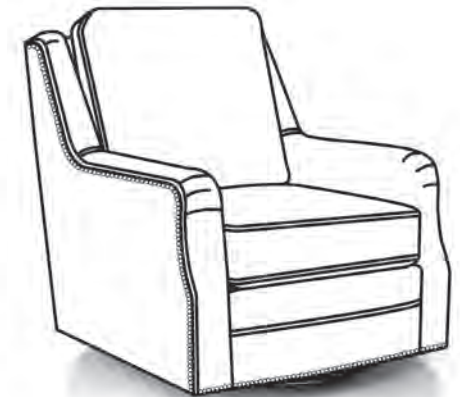

4950N



5D00



5D00AL



5D20

*Ellie*  
**5D00/5D00AL/5D20 SERIES**

# Ellie

## 5D00/5D00AL/5D20 SERIES

**England**  
FURNITURE CO.

© 2023 England, Inc.

### Dimensions

		<i>O.A</i>	<i>O.A</i>	<i>O.A</i>	<i>SEAT</i>	<i>SEAT</i>	<i>SEAT</i>
		<i>LENGTH</i>	<i>DEPTH</i>	<i>HEIGHT</i>	<i>LENGTH</i>	<i>DEPTH</i>	<i>HEIGHT</i>
<b>5D04</b>	Chair	33"	38"	40"	21"	23"	20"
<b>5D04AL</b>	Chair	33"	38"	40"	21"	23"	20"
<b>5D24</b>	Chair	33"	38"	40"	21"	23"	20"

*Fabric in Photo:* **5D00:** Emma Natural  
**5D00AL:** Evolution Pumice  
**5D20:** Hill Blue

April 23

### Features

<b>Cushions/Back</b>	Sinuous Wire
<b>Cushions/Back/Attached</b>	Block foam with polyester fiber cap
<b>Cushions/Seat</b>	Block foam with polyester fiber wrap
<b>Cushions/Ventilated</b>	Standard
<b>Fabric Types Available</b>	<b>5D00:</b> 1, 6, 11, 12, 14, 22 <b>5D00AL:</b> 10, 25 <b>5D20:</b> 4, 16
<b>Legs/Wood</b>	1.6" x 2.88" x 6" H (Screw-In)
<b>Options/Available</b> (Additional Charge)	• <b>CK</b> - Coil cushions • <b>FK</b> - Frame Coil (Coil Core)
<b>Seat Construction</b>	Sinuous Wire
<b>Seating/Loose/Non-Reversible</b>	Standard on 5D00AL only
<b>Seating/Loose/Reversible</b>	Standard on 5D00 & 5D20
<b>Welt/Matching</b>	Standard
<b>Wood Trim</b>	Dark Brown finish on legs



5D00



5D00AL



5D20





*Gigi*  
**5930 SERIES**

# Gigi

## 5930 SERIES

See digital catalog for  
most up to date information.

**England**  
FURNITURE CO.

© 2023 England, Inc.

### Dimensions

	<i>O.A</i> <i>LENGTH</i>	<i>O.A</i> <i>DEPTH</i>	<i>O.A</i> <i>HEIGHT</i>
<b>5930-10</b> Large Ottoman	37"	37"	18"
<i>Fabric in Photo:</i> Rialto Spruce			Oct 23

### Features

<b>Cushions/Seat</b>	Block foam w/polyester fiber wrap
<b>Fabric Types Available</b>	1, 6, 11, 12, 14 & 22
<b>Legs/Wood</b>	1.5" x 2.44" x 6" H Taper ( <i>Screw-In</i> )
<b>Seating/Tight</b>	Standard
<b>Wood Trim</b>	Dark Brown finish on legs

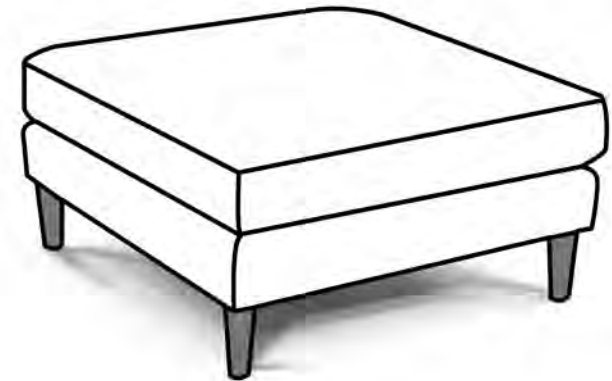



*Beau*  
**6050 SERIES**

# Beau

## 6050 SERIES



© 2023 England, Inc.

### Dimensions

	<i>O.A</i> <i>LENGTH</i>	<i>O.A</i> <i>DEPTH</i>	<i>O.A</i> <i>HEIGHT</i>	<i>SEAT</i> <i>LENGTH</i>	<i>SEAT</i> <i>DEPTH</i>	<i>SEAT</i> <i>HEIGHT</i>
<b>6054</b> Chair	34"	38"	39"	25"	21"	21"

*Fabric in Photo:* Adamas Indigo

Apr 23

### Features

<b>Cushions/Back</b>	Sinuous Wire
<b>Cushions/Back/Semi-Attached</b>	Polyester fiber fill in a channel bag - <i>Zipper Access</i>
<b>Cushions/Seat</b>	Block foam with polyester fiber wrap
<b>Cushions/Ventilated</b>	Standard
<b>Fabric Types Available</b>	1, 6, 11, 12, 14, 22
<b>Legs/Wood</b>	1" x 2" x 6" H. Tapered ( <i>Screw-In</i> )
<b>Options/Available</b>	<ul style="list-style-type: none"> <li>● <b>CK</b> - Coil Cushion</li> <li>● <b>FK</b> - Frame Coil (Coil Core)</li> </ul>
<i>(Additional Charge)</i>	
<b>Seat Construction</b>	Sinuous Wire
<b>Seating/Loose/Reversible</b>	Standard
<b>Wood Trim</b>	Dark Brown finish on legs

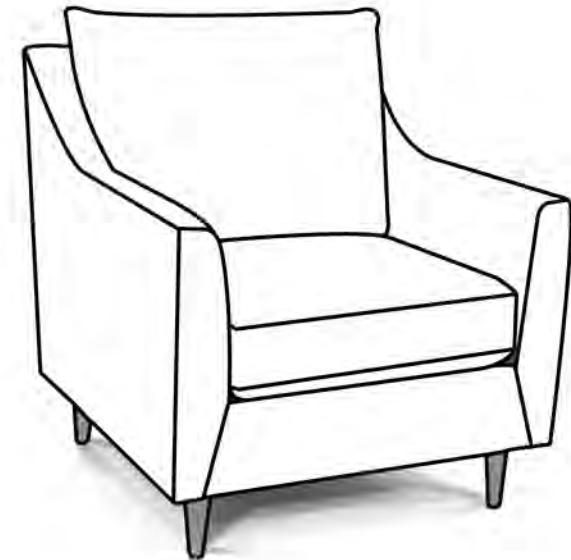





*Lina*  
**6100 SERIES**

# Lina

## 6100 SERIES



© 2023 England, Inc.

### Dimensions

		<i>O.A</i> <i>LENGTH</i>	<i>O.A</i> <i>DEPTH</i>	<i>O.A</i> <i>HEIGHT</i>
<b>6100-81</b>	Storage Ottoman	38"	38"	21"
<i>Fabric in Photo:</i>	Starr Chambray			Apr 23

Vent holes are standard  
in ALL storage ottomans  
to prevent suffocation.

### Features

<b>Cushions/Seat</b>	Block foam with polyester fiber wrap
<b>Fabric Types Available</b>	1, 6, 11, 12, 14, 22
<b>Legs/Plastic</b>	Black Casters (Screw-In)
<b>Seating/Tight</b>	Standard
<b>Storage</b>	Standard
<b>Welt Matching</b>	Standard

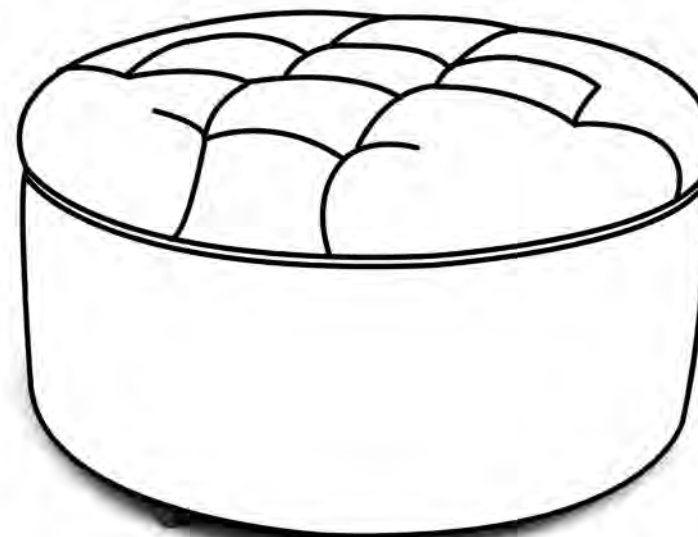



*Collegedale*  
**6200 SERIES**

# Collegedale

## 6200 SERIES



© 2021 England, Inc.

### Dimensions

		<i>O.A</i>	<i>O.A</i>	<i>O.A</i>	<i>SEAT</i>	<i>SEAT</i>	<i>SEAT</i>
		<i>LENGTH</i>	<i>DEPTH</i>	<i>HEIGHT</i>	<i>LENGTH</i>	<i>DEPTH</i>	<i>HEIGHT</i>
<b>6200-31</b>	Motion Chair	32"	34"	42"	21"	19"	21"

*Fabric in Photo:* Espanola Sapphire

Oct 21

### Features

<b>Cushions/Back</b>	Sinuous Wire
<b>Cushions/Back/Semi-Attached</b>	Block foam with polyester fiber wrap - <i>Zipper Access</i>
<b>Cushions/Seat</b>	Block foam with polyester fiber wrap
<b>Cushions/Ventilated</b>	Standard
<b>Fabric Types Available</b>	1, 6, 11, 14, 22
<b>Legs/Wood</b>	<b>Front:</b> 1.5" x 2.875" x 6" H. Tapered (Screw-In) <b>Back:</b> 2" x 3.25" x 6" H. (Screw-In)
<b>Options/Available</b> <i>(Additional Charge)</i>	<ul style="list-style-type: none"> <li>● <b>BP</b> - Power w/ Battery Pack</li> <li>● <b>PM</b> - Power</li> <li>● <b>FK</b> - Frame Coil (Coil Core)</li> </ul>
<b>Seat Construction</b>	Sinuous Wire
<b>Seating/Tight/ Non - Reversible</b>	Standard
<b>Welt/Matching</b>	Standard
<b>Wood Trim</b>	Dark Brown finish on legs

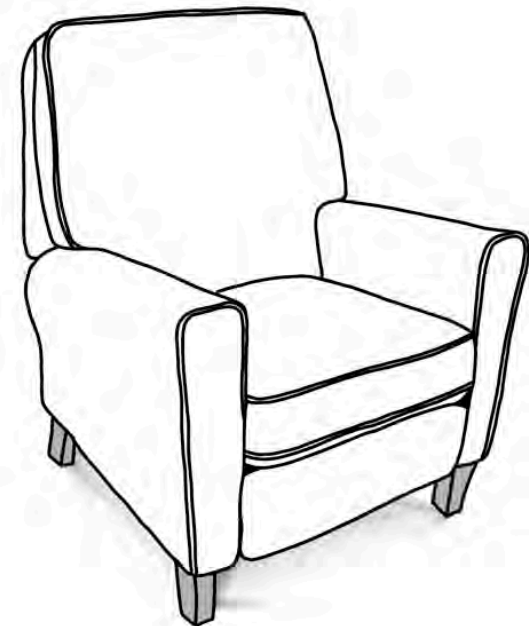





*Theo*  
**6300 SERIES**

Theo

## 6300 SERIES

**England**  
FURNITURE CO.

© 2023 England, Inc.

### Dimensions

		<i>O.A</i>	<i>O.A</i>	<i>O.A</i>	<i>SEAT</i>	<i>SEAT</i>	<i>SEAT</i>
		<i>LENGTH</i>	<i>DEPTH</i>	<i>HEIGHT</i>	<i>LENGTH</i>	<i>DEPTH</i>	<i>HEIGHT</i>
<b>6300-31</b>	Motion Chair	29"	36"	45"	21"	21"	21"

*Fabric in Photo:* Sidetracks Ash

Apr 23

### Features

**Cushions/Back**

Sinuous Wire

**Cushions/Back/Semi-Attached**

Block foam polyester fiber wrap - *Zipper Access*

**Cushions/Seat**

Block foam with polyester fiber wrap

**Fabric Types Available**

1, 6, 11, 12, 14, 22

**Legs/Wood**

**Front:** 1.5" x 2.5" x 5" H. (*Screw-In*)

**Back:** 2" x 3" x 3.75" H. (*Screw-In*)

**Options/Available**

● **FK** - Frame Coil (Coil Core)

(*Additional Charge*)

● **PM** - Power Mech

● **PB** - Power Mech with Battery Pack

**Seat Construction**

Sinuous Wire

**Seating/Tight**

Standard

**Wood Trim**

Dark Brown finish on legs





7F00M



7F00S



7F00

*Hermosa*  
**7F00/7F00M/7F00S SERIES**

# Hermosa

## 7F00/7F00M/7F00S SERIES



© 2020 England, Inc.

### Dimensions

		<i>O.A</i> <i>LENGTH</i>	<i>O.A</i> <i>DEPTH</i>	<i>O.A</i> <i>HEIGHT</i>
<b>7F07</b>	Ottoman	52"	52"	20"
<b>7F07M</b>	Medium Ottoman	40"	40"	20"
<b>7F07S</b>	Small Ottoman	32"	32"	20"

*Fabric in Photo:* 7F07M: Aria Asphalt  
7F07: Polo Club Teak\*  
7F07S: Oh Gee Brownstone  
\*Discontinued fabric- for viewing purposes only

Oct 20

### Features

<b>Cushions/Seat</b>	Block foam with polyester fiber wrap
<b>Fabric Types Available</b>	1, 6, 11, 12, 14, 22
<b>Legs/Plastic</b>	Black Casters (Screw-In)
<b>Seating/Tight</b>	Standard



7F07S

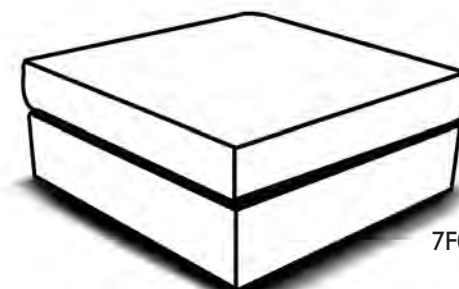

7F07M



7F07





*Ollie*  
**7000 SERIES**

# Ollie

## 7000 SERIES



© 2023 England, Inc.

### Dimensions

	<i>O.A</i>	<i>O.A</i>	<i>O.A</i>
	<i>LENGTH</i>	<i>DEPTH</i>	<i>HEIGHT</i>
<b>7000-10</b> Large Ottoman	34"	34"	18"
<i>Fabric in Photo:</i> Wheelie Mist			Oct 22

### Features

**Cushions/Seat**

Block foam w/polyester fiber wrap

**Fabric Types Available**

1, 6, 11, 12, 14 & 22

**Legs/Wood**

2.5" x 1.625" x 7.125" H Pyramid (*Screw-In*)

**Seating/Tight**

Standard

**Wood Trim**

Dark Brown finish on legs

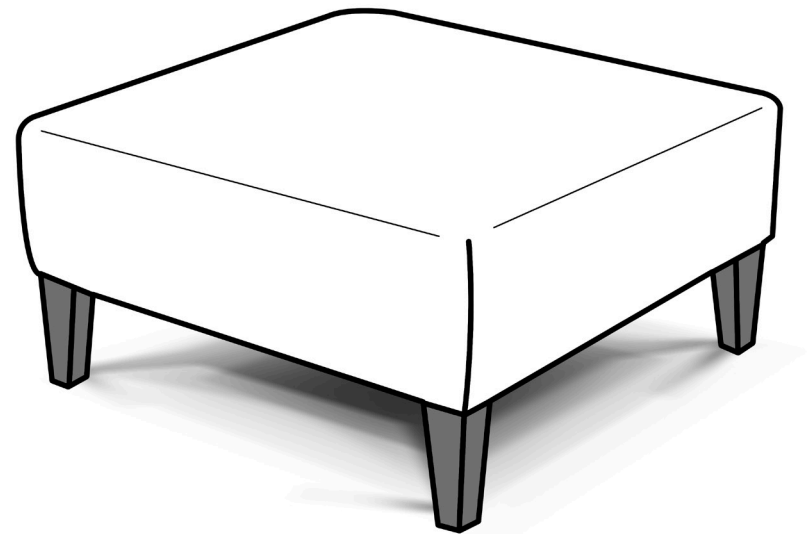



7350N



7350ALN



7370N

*Beale*  
**7350/N/AL/ALN/7370/N SERIES**

# Beale

## 7350/N/AL/ALN SERIES

## 7370/N SERIES



© 2023 England, Inc.

### Dimensions

		<i>O.A</i> <i>LENGTH</i>	<i>O.A</i> <i>DEPTH</i>	<i>O.A</i> <i>HEIGHT</i>	<i>SEAT</i> <i>LENGTH</i>	<i>SEAT</i> <i>DEPTH</i>	<i>SEAT</i> <i>HEIGHT</i>
7354/N	Chair	30"	39"	38"	22"	21"	20"
7354AL/ALN	Chair	30"	39"	38"	22"	21"	20"
7374/N	Chair	30"	39"	38"	22"	21"	20"

*Fabric in Photo:* 7350N: Martin Mulberry  
7350ALN: Rumor Bliss  
7370N: Lockhart Adobe

Apr 23

N = Nails

### Features

<b>Cushions/Back</b>	Sinuous Wire
<b>Cushions/Back/Attached</b>	Block foam with polyester fiber wrap - <i>Zipper Access</i>
<b>Cushions/Seat</b>	Block foam with polyester fiber wrap
<b>Cushions/Ventilated</b>	Standard
<b>Fabric Types Available</b>	7350/N: 1, 6, 11, 12, 14, 22 7350AL/ALN: 10, 25 7370/N: 4, 16
<b>Legs/Wood</b>	1.5" x 2.5" x 5" H (Screw-In)
<b>Options/Available</b> <i>(Additional Charge)</i>	<ul style="list-style-type: none"> <li>• <b>CK</b> - Coil cushions</li> <li>• <b>FK</b> - Frame Coil (Coil Core)</li> </ul>
<b>Seat Construction</b>	Sinuous Wire
<b>Seating/Loose/Non-Reversible</b>	Standard on 7350AL/ALN only
<b>Seating/Loose/Reversible</b>	Standard on 7350/N & 7370/N
<b>Trim/Brass Nails</b>	Standard on 7350N, 7350ALN & 7370N only
<b>Wood Trim</b>	Dark Brown finish on legs



7350



7350N



7350AL



7350ALN



7370



7370N





7550



7550AL

*Canton*  
**7550/AL SERIES**

# Canton

## 7550/AL SERIES



© 2021 England, Inc.

### Dimensions

	<i>O.A</i>	<i>O.A</i>	<i>O.A</i>
	<i>LENGTH</i>	<i>DEPTH</i>	<i>HEIGHT</i>
<b>7550-10</b> Large Ottoman	46"	28"	19"
<b>75510AL</b> Large Ottoman	46"	28"	19"

*Fabric in Photo:* 7550-10: Intrigue Paver  
75510AL: Evolution Dude Ranch

Oct 21

### Features

**Cushions/Seat**

Block foam w/polyester fiber wrap

**Fabric Types Available**

**7550:** 1, 6, 11, 12, 14 & 22

**7550AL:** 10, 25 & 27

**Legs/Wood**

2.5" x 1.625" x 7.125, Tapered Screw-In

**Seating/Tight**

Standard

**Welt/Matching**

Standard

**Wood Trim**

Dark Brown finish on legs

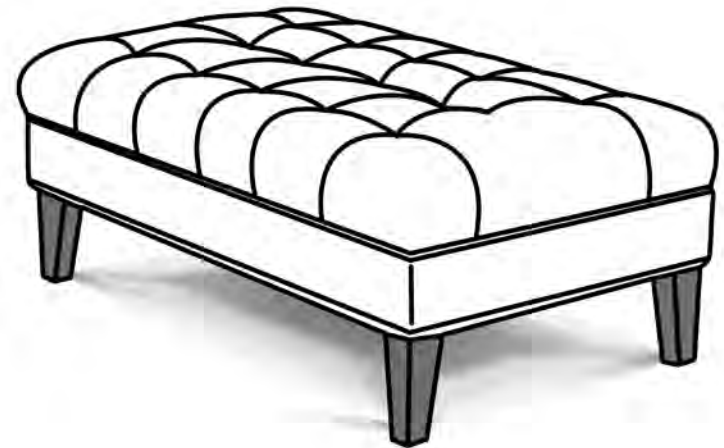



*Tate*  
**7600 SERIES**

# Tate

## 7600 SERIES



© 2022 England, Inc.

### Dimensions

	<i>O.A</i>	<i>O.A</i>	<i>O.A</i>
	<i>LENGTH</i>	<i>DEPTH</i>	<i>HEIGHT</i>
<b>7600-10</b> Large Ottoman	48"	25"	18"
<i>Fabric in Photo:</i> Kinley Chambray			Oct 22

### Features

**Cushions/Seat**

Block foam w/polyester fiber wrap

**Fabric Types Available**

1, 6, 11, 12, 14 & 22

**Legs/Wood**

2.25" x 1.5" x 7.125" H. Tapered (Screw-In)

**Seating/Tight**

Standard

**Wood Trim**

Dark Brown finish on legs

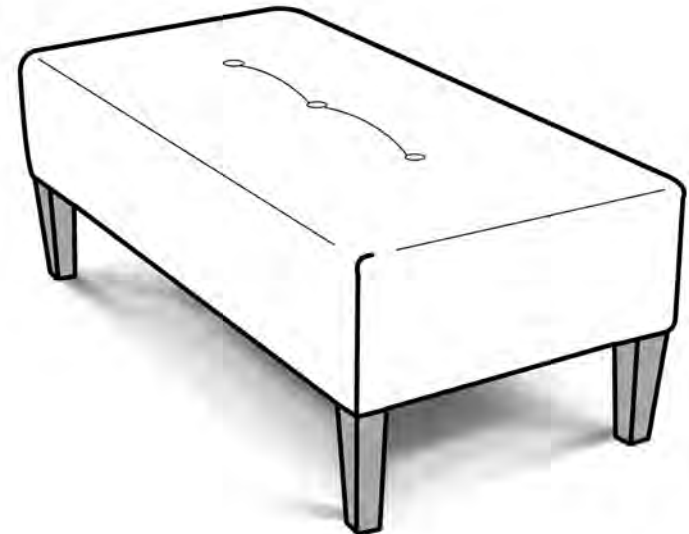





*Hendrix*

**7650/N/AL/ALN SERIES**

# Hendrix

## 7650/N/AL/ALN SERIES

See digital catalog for  
most up to date information.

# England

FURNITURE CO.

© 2023 England, Inc.

### Dimensions

		<i>O.A</i> <i>LENGTH</i>	<i>O.A</i> <i>DEPTH</i>	<i>O.A</i> <i>HEIGHT</i>
<b>7650-81/765081N</b>	Storage Ottoman	36"	36"	19"
<b>76581AL/76581LN</b>	Storage Ottoman	36"	36"	19"

*Fabric in Photo:* 765081N: Succor Hickory  
76581LN Evolution Deep Blue

Oct 23

Vent holes are standard  
in ALL storage  
ottomans  
to prevent suffocation.

N = Nails

### Features

<b>Cushions/Seat</b>	Block foam with polyester fiber wrap
<b>Fabric Types Available</b>	<b>7650/7650N:</b> 1, 6, 11, 12, 14, 22 <b>7650AL/7650ALN:</b> 10, 25
<b>Legs/Plastic</b>	Black Casters (Screw-In)
<b>Seating/Tight</b>	Standard
<b>Storage</b>	Standard
<b>Trim/Brass Nails</b>	Standard on 7650N & 7650ALN
<b>Welt Matching</b>	Standard

7650-81



765081N

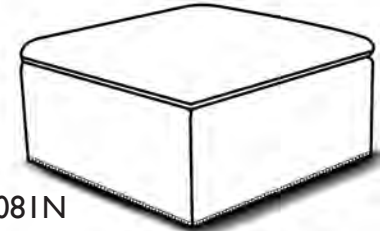

76581AL

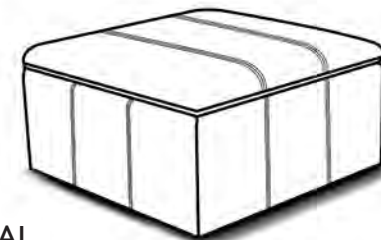

76581LN

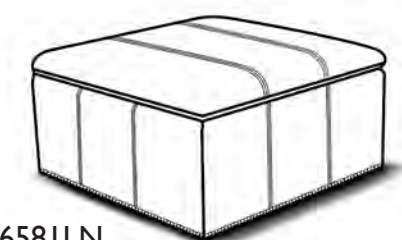



7700



7700X

*Austin*  
**7700 SERIES**

# Austin

## 7700 SERIES



© 2023 England, Inc.

### Dimensions

	<i>O.A</i> <i>LENGTH</i>	<i>O.A</i> <i>DEPTH</i>	<i>O.A</i> <i>HEIGHT</i>
<b>7700-81</b> Storage Ottoman	41"	25"	18"
<b>770081X</b> Storage Ottoman	48"	30"	18"

*Fabric in Photo:* 7700: Lola Timberwolf  
7700X: Superbad Livid

Apr 23

Vent holes are standard  
in ALL storage ottomans  
to prevent suffocation.

### Features

<b>Cushions/Seat</b>	Block foam with polyester fiber wrap
<b>Fabric Types Available</b>	1, 6, 11, 12, 14, 22
<b>Legs/Plastic</b>	Black Casters (Screw-In)
<b>Seating/Tight</b>	Standard
<b>Storage</b>	Standard
<b>Welt Matching</b>	Standard







**8C00**



**8C00AL**

*Harlow*  
**8C00/8C00AL SERIES**

# Harlow

## 8C00/8C00AL SERIES

See digital catalog for  
most up to date information.



© 2023 England, Inc.

### Dimensions

	<i>O.A</i> <i>LENGTH</i>	<i>O.A</i> <i>DEPTH</i>	<i>O.A</i> <i>HEIGHT</i>	<i>SEAT</i> <i>LENGTH</i>	<i>SEAT</i> <i>DEPTH</i>	<i>SEAT</i> <i>HEIGHT</i>
<b>8C00-69</b> Swivel Chair	33"	34"	43"	22"	22"	21"
<b>8C069AL</b> Swivel Chair	33"	34"	43"	22"	22"	21"

*Fabric in Photo:* 8C00: Andes Autumn  
8C00AL: Cheyenne Decoy

Oct 23

### Features

<b>Cushions/Back</b>	Sinuous Wire
<b>Cushions/Back/Attached</b>	Block foam with polyester fiber cap
<b>Cushions/Seat</b>	Block foam with polyester fiber wrap
<b>Fabric Types Available</b>	<b>8C00:</b> 1, 6, 11, 12, 14, 22 <b>8C00AL:</b> 10, 25
<b>Legs/Wood</b>	Swivel Base
<b>Seat Construction</b>	Sinuous Wire
<b>Seating/Loose/Non-Reversible</b>	Standard on 8C00AL only
<b>Seating/Loose/Reversible</b>	Standard on 8C00
<b>Wood Trim</b>	Dark Brown finish on legs



8C00



8C00AL



8V00



8V00XL

*Cullen*  
**8V00/8V00XL SERIES**

# Cullen

## 8V00 SERIES



© 2021 England, Inc.

### Dimensions

		<i>O.A</i> <i>LENGTH</i>	<i>O.A</i> <i>DEPTH</i>	<i>O.A</i> <i>HEIGHT</i>
<b>8V07</b>	Ottoman	32" dia.	-	18"
<b>8V07XL</b>	Extra Large Ottoman	40" dia.	-	18"

*Fabric in Photo:* 8V07: Copperleaf Indigo  
8V07XL: Wildcat Nile

Oct 21

### Features

<b>Cushions/Seat</b>	Block foam with polyester fiber cap
<b>Fabric Types Available</b>	1, 6, 11, 14, 22
<b>Legs/Plastic</b>	Black Casters (Screw-In)
<b>Seating/Tight</b>	Standard
<b>Welt/Matching</b>	Standard



8V00

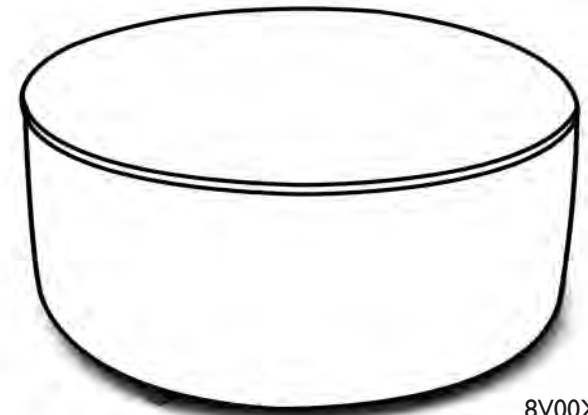

8V00XL





*Wright*  
**8W00 SERIES**

# Wright

## 8W00 SERIES



© 2023 England, Inc.

### Dimensions

		<i>O.A</i>	<i>O.A</i>	<i>O.A</i>	<i>SEAT</i>	<i>SEAT</i>	<i>SEAT</i>
		<i>LENGTH</i>	<i>DEPTH</i>	<i>HEIGHT</i>	<i>LENGTH</i>	<i>DEPTH</i>	<i>HEIGHT</i>
<b>8W00-31</b>	Motion Chair	34"	37"	45"	21"	20"	22"

*Fabric in Photo:* Starry Twilight

Apr 23

### Features

- Cushions/Back** Webbing w/Sinuous Wire
- Cushions/Back/Semi-Attached** Polyester fiber fill - *Zipper Access*
- Cushions/Seat** Block foam with polyester fiber cap
- Fabric Types Available** 1, 6, 11, 14, 22
- Legs/Wood** Front: 3" x 1.875" x 5" H. Tapered (*Screw-In*)  
Back: 3.1875" x 2" x 3.75" H. Tapered (*Screw-In*)
- Options/Available**
  - **FK** - Frame Coil (Coil Core)
  - **PM** - Power Available
  - **PB** - Battery Pack Available
- Seat Construction** Sinuous Wire
- Seating/Tight** Standard
- Wood Trim** Medium Brown finish on legs





*Arden*  
**8X00 SERIES**

# Arden

## 8X00 SERIES

# England

FURNITURE CO.

© 2023 England, Inc.

## Dimensions

	<i>O.A</i>	<i>O.A</i>	<i>O.A</i>	<i>SEAT</i>	<i>SEAT</i>	<i>SEAT</i>
	<i>LENGTH</i>	<i>DEPTH</i>	<i>HEIGHT</i>	<i>LENGTH</i>	<i>DEPTH</i>	<i>HEIGHT</i>
<b>8X04</b> Chair	35"	36"	42"	21"	23"	21"

*Fabric in Photo:* McKittrick Charcoal

Aug 23

## Features

<b>Cushions/Back</b>	Sinuous Wire
<b>Cushions/Back/Attached</b>	Block Foam with polyester fiber cap
<b>Cushions/Seat</b>	Block foam with polyester fiber wrap
<b>Cushions/Ventilated</b>	Standard
<b>Fabric Types Available</b>	1, 6, 11, 14, 22
<b>Legs/Wood</b>	5.5" H. Turned ( <i>screw-in</i> )
<b>Options/Available</b>	<ul style="list-style-type: none"><li>• <b>CK</b> - Coil Cushion</li><li>• <b>FK</b> - Fram Coil (Coil Core)</li></ul>
<i>(Additional Charge)</i>	
<b>Seat Construction</b>	Sinuous Wire
<b>Seating/Reversible</b>	Standard
<b>Welt/Matching</b>	Standard
<b>Wood Trim</b>	Medium Brown finish on legs







*Becca*  
**8Z00 SERIES**

# Becca

## 8Z00 SERIES



© 2022 England, Inc.

### Dimensions

	<i>O.A</i> <i>LENGTH</i>	<i>O.A</i> <i>DEPTH</i>	<i>O.A</i> <i>HEIGHT</i>	<i>SEAT</i> <i>LENGTH</i>	<i>SEAT</i> <i>DEPTH</i>	<i>SEAT</i> <i>HEIGHT</i>
<b>8Z00-69</b> Swivel Chair	33"	37"	39"	22"	21"	20"

*Fabric in Photo:* Copperleaf Indigo

Oct 22

### Features

<b>Cushions/Back</b>	Webbing
<b>Cushions/Back/Loose</b>	Block foam with polyester fiber wrap - <i>Zipper Access</i>
<b>Cushions/Seat</b>	Block foam with polyester fiber wrap
<b>Cushions/Ventilated</b>	Standard
<b>Fabric Types Available</b>	1, 6, 11, 14, 22
<b>Legs</b>	Swivel Base
<b>Options/Available</b> <i>(Additional Charge)</i>	<ul style="list-style-type: none"> <li>● <b>CK</b> - Coil Cushion</li> <li>● <b>FK</b> - Frame Coil (Coil Core)</li> </ul>
<b>Seat Construction</b>	Sinusuous Wire
<b>Seating/Loose/Reversible</b>	Standard





*Allie*  
**9600 SERIES**

# Allie

## 9G00 SERIES



© 2022 England, Inc.

### Dimensions

	<i>O.A</i> <i>LENGTH</i>	<i>O.A</i> <i>DEPTH</i>	<i>O.A</i> <i>HEIGHT</i>	<i>SEAT</i> <i>LENGTH</i>	<i>SEAT</i> <i>DEPTH</i>	<i>SEAT</i> <i>HEIGHT</i>
<b>9G00-71</b> Swivel Glider	30"	37"	38"	21"	22"	22"

*Fabric in Photo:* Olivia Pine

Apr 22

### Features

<b>Cushions/Back</b>	Sinuous Wire
<b>Cushions/Back/Attached</b>	Block Foam with polyester fiber cap
<b>Cushions/Seat</b>	Block foam with polyester fiber wrap
<b>Cushions/Ventilated</b>	Standard
<b>Fabric Types Available</b>	1, 6, 11, 14, 22
<b>Legs</b>	Swivel base with glide
<b>Options/Available</b>	<ul style="list-style-type: none"> <li>● <b>CK</b> - Coil Cushion</li> <li>● <b>FK</b> - Fram Coil (Coil Core)</li> </ul>
<i>(Additional Charge)</i>	
<b>Seat Construction</b>	Sinuous Wire
<b>Seating/Reversible</b>	Standard
<b>Welt/Matching</b>	Standard

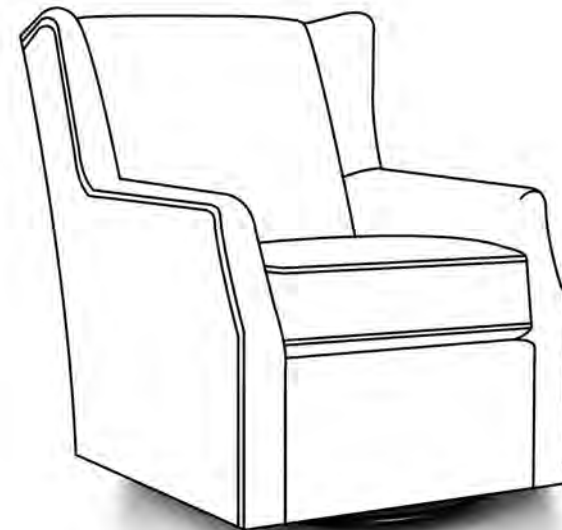





*Marley*  
**9H00/9H00N SERIES**

# Marley

## 9H00/9H00N SERIES

**England**  
FURNITURE CO.

© 2023 England, Inc.

### Dimensions

		<i>O.A</i>	<i>O.A</i>	<i>O.A</i>	<i>SEAT</i>	<i>SEAT</i>	<i>SEAT</i>
		<i>LENGTH</i>	<i>DEPTH</i>	<i>HEIGHT</i>	<i>LENGTH</i>	<i>DEPTH</i>	<i>HEIGHT</i>
<b>9H04/9H04N</b>	Chair	31"	38"	38"	22"	21"	21"
<i>Fabric in Photo:</i> Shoshanna Haze							Oct 21

N = Nails

### Features

<b>Cushions/Back</b>	Sinuous Wire
<b>Cushions/Back/Semi-Attached</b>	Block foam with polyester fiber wrap - <i>Zipper Access</i>
<b>Cushions/Seat</b>	Block foam with polyester fiber wrap
<b>Cushions/Ventilated</b>	Standard
<b>Fabric Types Available</b>	1, 6, 11, 14, 22
<b>Legs/Wood</b>	<b>Front:</b> 2.875" x 1.5" x 6" H Tapered ( <i>screw-in</i> ) <b>Rear:</b> 2.5" x 1.375" x 6" H ( <i>screw-in</i> )
<b>Options/Available</b>	<ul style="list-style-type: none"> <li>• <b>CK</b> - Coil Cushion</li> <li>• <b>FK</b> - Frame Coil (Coil Core)</li> </ul>
<i>(Additional Charge)</i>	
<b>Seat Construction</b>	Sinuous Wire
<b>Seating/Loose/Reversible</b>	Standard
<b>Trim - Brass Nails</b>	Standard on 9H00N only
<b>Wood Trim</b>	Dark Brown finish on legs



9H00N



9H00



9J00S



9J00M

*Asher*  
**9J00S/9J00M SERIES**

# Asher

## 9J00S/9J00M SERIES

**England**  
FURNITURE CO.

© 2023 England, Inc.

### Dimensions

		<i>O.A</i> <i>LENGTH</i>	<i>O.A</i> <i>DEPTH</i>	<i>O.A</i> <i>HEIGHT</i>
<b>9J07S</b>	Small Ottoman	19"	19"	18"
<b>9J07M</b>	Medium Ottoman	25"	25"	18"
<i>Fabric in Photo:</i> 9J00S: Nimah Gold 9J00M: Triplet Party				Oct 21

### Features

<b>Cushions/Seat</b>	Block foam with polyester fiber wrap
<b>Fabric Types Available</b>	1, 6, 11, 14, 22
<b>Legs/Plastic</b>	Nail on Glide
<b>Welt/Matching</b>	Standard

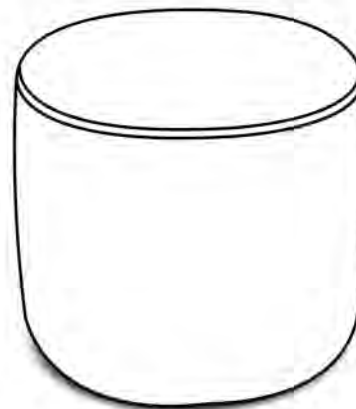

9J00S



9J00M





9000



9020

*Delia*  
**9000/9020 SERIES**

*Delia*

## 9000/9020 SERIES

*England*  
FURNITURE CO.

© 2023 England, Inc.

### Dimensions

	<i>O.A</i>	<i>O.A</i>	<i>O.A</i>
	<i>LENGTH</i>	<i>DEPTH</i>	<i>HEIGHT</i>
<b>9000-10</b> Large Ottoman	49"	30"	19"
<b>9020-10</b> Large Ottoman	49"	30"	19"

*Fabric in Photo:* 9000: Reno Camel  
9020: Northlawn Wheat

Oct 21

### Features

**Cushions/Seat**

Block foam w/polyester fiber wrap

**Fabric Types Available**

**9000:** 1, 6, 11, 12, 14, 22

**9020:** 4, 16

**Legs**

Nail on glide

**Seating/Tight**

Standard

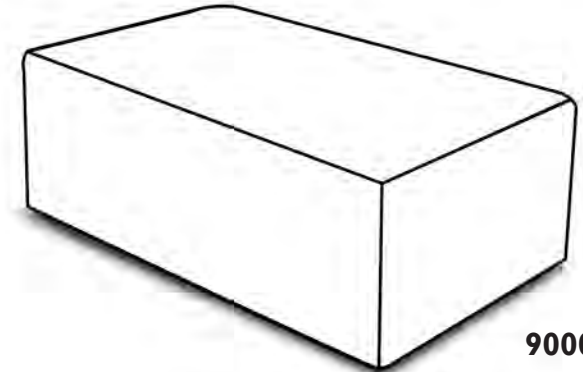



*Camden*  
**9950 SERIES**

# Camden

## 9950 SERIES



© 2023 England, Inc.

### Dimensions

	<i>O.A</i> <i>LENGTH</i>	<i>O.A</i> <i>DEPTH</i>	<i>O.A</i> <i>HEIGHT</i>	<i>SEAT</i> <i>LENGTH</i>	<i>SEAT</i> <i>DEPTH</i>	<i>SEAT</i> <i>HEIGHT</i>
9950-71 Swivel Glider	34"	35"	30"	22"	20"	21"

*Fabric in Photo:* Oliver Seaspray

Apr 23

### Features

<b>Cushions/Back</b>	Sinuous Wire
<b>Cushions/Back/Attached</b>	Block foam with polyester fiber wrap
<b>Cushions/Seat</b>	Block foam with polyester fiber wrap
<b>Cushions/Ventilated</b>	Standard
<b>Fabric Types Available</b>	1, 6, 11, 14, 22
<b>Legs/Plastic</b>	Swivel base with black glide
<b>Options/Available</b> <i>(Additional Charge)</i>	<ul style="list-style-type: none"> <li>• <b>CK</b> - Coil Cushion</li> </ul>
<b>Seat Construction</b>	Sinuous Wire
<b>Seating/Loose/Reversible</b>	Standard

