



April 2026 Price Book

Customized Resale

Effective for orders written: April 20, 2026

Edition Number: 26-04-AC-F

Issue Date: April 23, 2026

Office Copy Only

Prefix	Definiton	Prefix	Definiton	Prefix	Definiton
ROCKER RECLINERS / WALL RECLINERS / GLIDERS		RECLINA-WAY® MOTION		LA-Z-TIME® MODULARS	
010	Rocking Recliner	330	Wall Reclining Sofa	44A	Left-Arm Sitting Recliner
P10	Power Rocking Recliner	33U	Power Wall Reclining Sofa w/ Headrest	U4A	Power Left-arm Sitting Recliner w/ Headrest
10U	Power Rocking Recliner w/ Headrest	33X	Power Wall Reclining Sofa w/ Headrest & Lumbar	X4A	Power Left-arm Sitting Recliner w/ Headrest & Lumbar
10X	Power Rocking Recliner w/ Headrest & Lumbar	360	Wall Reclining Sofa w/ Drop Down Table	44B	Right-Arm Sitting Recliner
016	Wall Recliner	36U	Power Wall Reclining Sofa w/ Headrest & Drop Down Table	U4B	Power Right-Arm Sitting Recliner w/ Headrest
P16	Power Wall Recliner	36X	Power Wall Reclining Sofa w/ Headrest, Lumbar & Drop Down Table	X4B	Power Right-Arm Sitting Recliner w/ Headrest & Lumbar
16X	Power Wall Recliner w/ Headrest & Lumbar	320	Wall Reclining Loveseat	44C	Corner Unit
017	Swivel Gliding Recliner	32U	Power Wall Reclining Loveseat w/ Headrest	SC4	Storage Console
30L	Left-Arm Sitting Rocking Recliner	32X	Power Wall Reclining Loveseat w/ Headrest & Lumbar	44D	Left-Arm Sitting Reclining Loveseat
30R	Right-Arm Sitting Rocking Recliner	339	Wall Reclining Loveseat w/ Console	U4D	Power Left-Arm Sitting Reclining Loveseat w/ Headrest
SC3	Storage Console	U39	Power Wall Reclining Loveseat w/ Headrest & Console	X4D	Power Left-Arm Sitting Reclining Loveseat w/ Headrest & Lumbar
LIFT CHAIRS		X39	Power Wall Reclining Loveseat w/ Console, Headrest & Lumbar	44E	Right-Arm Sitting Reclining Loveseat
1HM	Gold Power Lift Recliner w/ Massage & Heat	LA-Z-TIME® MOTION		U4E	Power Right-Arm Sitting Reclining Loveseat w/ Headrest
1PH	Platinum Power Lift Recliner w/ Headrest & Lumbar	445	Reclining Chair and A Half	X4E	Power Right-Arm Sitting Reclining Loveseat w/ Headrest & Lumbar
1PL	Platinum Power Lift Recliner	U45	Power Reclining Chair and A Half w/ Headrest	M44	Armless Chair
3BL	Bronze Power Lift Recliner	X45	Power Reclining Chair and A Half w/ Headrest & Lumbar	44Q	Left-Arm Sitting Reclining Chaise
4LP	Silver Power Lift Recliner	443	Reclining 2-seat Sofa	U4Q	Power Left-Arm Sitting Reclining Chaise w/ Headrest
CLASSICS		U43	Power Reclining 2-seat Sofa w/ Headrest	X4Q	Power Left-Arm Sitting Reclining Chaise w/ Headrest & Lumbar
028	High Leg Reclining Chair	X43	Power Reclining 2-seat Sofa w/ Headrest & Lumbar	44S	Armless Recliner
295	High Leg Reclining Chair	444	Reclining Sofa	U4S	Power Armless Recliner w/ Headrest
29U	High Leg Reclining Chair w/ Headrest	U44	Power Reclining Sofa w/ Headrest	X4S	Power Armless Recliner w/ Headrest & Lumbar
COMPLEMENTS		X44	Power Reclining Sofa w/ Headrest & Lumbar	DISCLAIMER - 44S /U4S/ X4S is not designed to be an open ended piece. We recommend a modular unit be placed on either side of any 44S /U4S/ X4S unit. Due to exposed connectors, Motion-Modular peices are NOT intended to be used as stand-alone styles.	
024	Ottoman	446	Reclining Sofa w/ Drop Down Table		
210	High Leg Swivel Chair	U46	Power Reclining Sofa w/ Headrest & Drop Down Table	44V	Right-Arm Sitting Reclining Chaise
215	Swivel Chair	X46	Power Reclining Sofa w/ Headrest, Lumbar & Drop Down Table	U4V	Power Right-Arm Sitting Reclining Chaise w/ Headrest
		448	Reclining Loveseat	X4V	Power Right-Arm Sitting Reclining Chaise w/ Headrest & Lumbar
		U48	Power Reclining Loveseat w/ Headrest		
		X48	Power Reclining Loveseat w/ Headrest & Lumbar		
		449	Reclining Loveseat w/ Console		
		U49	Power Reclining Loveseat w/ Headrest & Console		
		X49	Power Reclining Loveseat w/ Headrest, Lumbar & Console		

Prefix	Definiton	Prefix	Definiton	Prefix	Definiton
LA-Z-MOTION®		STATIONARY SECTIONALS		COMFORT ESSENTIALS STATIONARY	
84U	Power Reclining Sofa w/ Headrest	60A	Left-Arm Sitting Chair	061	Sofa
88U	Power Reclining Loveseat w/ Headrest	6AL	Left-Arm Sitting Storage Arm	063	Loveseat
85U	Power Reclining Chair & A Half w/ Headrest	60B	Right-Arm Sitting Chair	023	Chair
81U	Power Reclining Chair w/ Headrest	6AR	Right-Arm Sitting Storage Arm	024	Ottoman
LA-Z-MOTION® MODULARS		60C	Rounded Corner Unit	DUO®	
8AU	Power Left-Arm Sitting Recliner w/ Headrest	6CC	90 Degree Corner Unit	P91	Power Reclining Sofa
8BU	Power Right-Arm Sitting Recliner w/ Headrest	60D	Left-Arm Sitting Loveseat	P93	Power Reclining Loveseat
8C0	Corner Unit	60E	Right-Arm Sitting Loveseat	P94	Power Recling Chair
8M0	Armless Middle	60L	Left-Arm Sitting Chaise	SPECIAL ITEMS	
8SU	Power Armless Recliner w/ Headrest	60R	Right-Arm Sitting Chaise	01P	Single Custom Pillow
8SC	Storage Console	60M	Armless Chair	08P	Pair of Custom Pillows
STATIONARY SOFAS & SLEEP SOFAS		6MM	Armless Loveseat	088	Misc. items (Bases, Armcaps, Mattresses, Audio etc.)
510	Queen Sleep Sofa	6SC	Storage Console	D88	DC Option Demonstration Cushion
51S	Queen Sleep Sofa w/ Chaise	6SP	Armless Full Sleep Sofa	Z88	Z6 Option Demonstration Cushion
520	Full Sleep Sofa	6SL	Left-Arm Sitting Chaise w/ Storage		
610	Sofa	6SR	Right-Arm Sitting Chaise w/ Storage		
61S	Sofa w/ Chaise	60W	Left-Arm Sitting Sofa w/ Attached Corner		
620	Apartment Size Sofa	60X	Right-Arm Sitting Sofa w/ Attached Corner		
630	Loveseat	60Y	Left-Arm Sitting Sofa		
555	Twin Sleep Chair	60Z	Right-Arm Sitting Sofa		
655	Chair & A Half				
230	Chair				
240	Ottoman				

STYLE NAME/NUMBER REFERENCE

Name	Style
ACADIA	811
ACE	805
ALANI	665
ALLEGRA	401
ALMA	425
APOLLO	757
ARMITAGE	812
ASTOR	519
AUDREY	457
AVA	769
BARON	807
BELLEVUE	421
BELMONT	804
BENNETT	899
BEXLEY	681
BILLIE	794
BRENTWOOD	430
BROOKS	727
CADE	803
CARLETON	471
CASSIAN	802
CHARLIE	638
CHARLOTTE	931
CLAYTON	562
CLYBOURN	813
COLBY	893
COLLAGE	734
COLLINS	494
CORY	205
DANTE	405
DORA	400
DORIAN	755
DUTTON	828
ELDORADO	423
EMMONS	781

Name	Style
FERNDALE	408
FINLEY	747
FLEETWOOD	678
FLETCHER	424
FULTON	717
GEMMA	406
GREYSON	530
HARBOR TOWN	799
HAVEN	450
JAMES	521
JASPER	709
JAY	706
JEAN	793
JOEL	761
JOSHUA	502
KELLS	782
KENNEDY	593
KIMBERLY	916
KODIE	715
LAUREL	411
LAUREN	677
LEAH	418
LENNON	787
LEO	30A
LIAM	786
MACKENZIE	435
MADDOX	759
MAEVE	402
MAVERICK	582
MEYER	694
MIDTOWN	479
MORRISON	766
NATALIE	491
NEO	762
NOAH	606

Name	Style
NORTON	820
OLIVER	301
OLSON	613
OPAL	456
OVATION	A86
PALMER	800
PARSENS	827
PAXTON	663
PINNACLE	512
PIPER	620
QUINAULT	810
RAE	416
RANDELL	777
REDWOOD	776
REED	704
REEGAN	460
RHEEVES	458
RILEY	448
ROBIN	774
ROMAN	722
ROUNDAABOUT	225
ROWAN	765
ROXIE	462
SAMMY	826
SCARLETT	431
SCOUT	304
SHERMAN	725
SHILOH	636
SPARROW	712
TAHOE	632
TROUPER	724
VAIL	403
WILMETTE	603
WYNNE	700

PRODUCT AVAILABILITY INDEX

Style	Name	Cover Availability			Reclining											Stationary								duo™							
		Fabric	Faux Leather	Leather	Sofa	Loveseat	Chair	Swivel Glider	Modular	Power Recline w/Hdrst/ Lumbar & Drop Down Table	Power Recline w/Hdrst/ Lumbar	Power Recline w/Hdrst	Power Recline	Heat / Massage	AudioLuxe	Lift Chair	Sofa	Queen Sleeper	Full Sleeper	Twin Sleeper	Loveseat	Chair	Ottoman	Swivel Chair	Chaise	Sectional	Sofa	Loveseat	Chair		
811	ACADIA	S	•	S	•	•	•		•																						
805	ACE	S	S	S						•	•																				
665	ALANI	S	•	•																					•	•					
401	ALLEGRA	•	•	•																											
425	ALMA	•	•																												
757	APOLLO	S	S	S	•	•	•		•	•	•																				
812	ARMITAGE	S	•	S					•		•																				
519	ASTOR	S	•	S							•	•				•															
457	AUDREY	•	•	•							•																				
769	AVA	S	•	S	•	•	•		•	•	•																				
807	BARON	S	S	S	•	•	•			•	•	•																			
421	BELLEVUE	•	•																												
804	BELMONT	S	•	S	•	•	•			•	•	•																			
899	BENNETT	S	•	•																									•	•	•
681	BEXLEY	S	•													•	•			•											
794	BILLIE	S	•																												
430	BRENTWOOD	•	•	•								•																			
727	BROOKS	S	•	•	•	•	•					•	•																		
803	CADE	S	•	S	•	•	•					•	•																		
471	CARLETON	•	•	•								•																			
802	CASSIAN	S	•	S	•	•	•					•	•																		
638	CHARLIE	S	•	S												•	•	•	•										•		
931	CHARLOTTE	•	•																												
562	CLAYTON	S	•																												
813	CLYBOURN	S	•	S	•	•	•					•																			
893	COLBY	S	•	•																									•	•	•

Style	Name	Cover Availability			Reclining											Stationary							duo™						
		Fabric	Faux Leather	Leather	Sofa	Loveseat	Chair	Swivel Glider	Modular	Power Recline w/Hdrst/ Lumbar & Drop Down Table	Power Recline w/Hdrst/ Lumbar	Power Recline w/Hdrst	Power Recline	Heat / Massage	AudioLuxe	Lift Chair	Sofa	Queen Sleeper	Full Sleeper	Twin Sleeper	Loveseat	Chair	Ottoman	Swivel Chair	Chaise	Sectional	Sofa	Loveseat	Chair
734	COLLAGE	S	•				•					•																	
494	COLLINS	S	•	•												•				•	•	•		•	•				
205	CORY	•	•	•																									
405	DANTE	•	•	•																									
400	DORA	•	•	•																	•	•	•						
755	DORIAN	S	S	S	•	•	•																						
828	DUTTON	S	S	S	•	•	•		•	•	•																		
423	ELDORADO	•	•	•																									
781	EMMONS	S	•	S	•	•	•									•													
408	FERNDALE	•	•	•																			•	•					
747	FINLEY	S	•	S	•	•	•	•																					
678	FLEETWOOD	S	•													•				•	•	•							
424	FLETCHER	•	•	•																									
717	FULTON	S		S																									
406	GEMMA	•	•	•																									
530	GREYSON	S	•	S	•	•	•		•	•	•																		
799	HARBOR TOWN	S	•	•																									
450	HAVEN	•	•	•																									
521	JAMES	S	S	S	•	•	•	•																					
709	JASPER	S	S	S																									
706	JAY	S	•	•	•	•	•																						
793	JEAN	S	•																										
761	JOEL	S	S		•	•	•																						
502	JOSHUA	S	S	S																									
782	KELLS	S	•	S																									
593	KENNEDY	S	•	•												•	•	•		•	•	•							

Style	Name	Cover Availability			Reclining											Stationary							duo						
		Fabric	Faux Leather	Leather	Sofa	Loveseat	Chair	Swivel Glider	Modular	Power Recline w/Hdrest/ Lumber & Drop Down Table	Power Recline w/Hdrest/ Lumbar	Power Recline w/Hdrest	Power Recline	Heat / Massage	AudioLuxe	Lift Chair	Sofa	Queen Sleeper	Full Sleeper	Twin Sleeper	Loveseat	Chair	Ottoman	Swivel Chair	Chaise	Sectional	Sofa	Loveseat	Chair
916	KIMBERLY	•					•																						
715	KODIE	S	•	S			•			•	•																		
411	LAUREL	S														•					•	•							
418	LEAH	S	•														•	•	•										
787	LENNON	S	•	S	•	•	•									•	•												
30A	LEO	•	•	•																									
786	LIAM	S	S	S	•	•	•															•							
435	MACKENZIE	S	•	S												•	•			•	•	•							
759	MADDOX	S	S	S	•		•									•	•												
402	MAEVE	•	•	•																	•	•	•						
582	MAVERICK	S	S	S			•																						
694	MEYER	S	•	•												•				•	•	•			•	•			
479	MIDTOWN	•		•																			•						
766	MORRISON	S	S	•	•	•	•		•	•	•																		
491	NATALIE	S														•	•			•	•	•							
762	NEO	S	S	S			•																						
606	NOAH	S	•	•												•				•	•	•							
820	NORTON	S	•	S			•																						
301	OLIVER	•	•	•																									
613	OLSON	S	•	S												•	•	•	•		•								
456	OPAL	•	•	•																			•						
A86	OVATION	S	•	S					•	•							•												
800	PALMER	S	•	S			•			•	•																		
827	PARSENS	S	•	•			•			•	•																		
663	PAXTON	S	•	•			•			•	•					•				•	•	•			•	•			



PRODUCT AVAILABILITY INDEX

Style	Name	Cover Availability			Reclining											Stationary								duo™					
		Fabric	Faux Leather	Leather	Sofa	Loveseat	Chair	Swivel Glider	Modular	Power Recline w/Hdrst/ Lumbar & Drop Down Table	Power Recline w/Hdrst/ Lumbar	Power Recline w/Hdrst	Power Recline	Heat / Massage	AudioLuxe	Lift Chair	Sofa	Queen Sleeper	Full Sleeper	Twin Sleeper	Loveseat	Chair	Ottoman	Swivel Chair	Chaise	Sectional	Sofa	Loveseat	Chair
512	PINNACLE	S	•	S	•	•	•	•			•	•				•													
620	PIPER	S	•	•												•	•			•									
810	QUINAULT	S	•	S	•	•	•																						
416	RAE	•	•	•			•																						
777	RANDELL	S	S	S			•				•	•																	
776	REDWOOD	S	•	S			•				•	•																	
704	REED	S	•	•			•				•	•																	
460	REEGAN	•	•	•																			•						
458	RHEEVES	•	•	•			•				•	•																	
448	RILEY	•	•	•			•																						
774	ROBIN	S	•		•	•	•				•	•																	
722	ROMAN	S	•	S	•	•	•				•	•																	
225	ROUNABOUT	•	•	•																		•							
765	ROWAN	S	•	S			•				•	•										•							
462	ROXIE	•	•																				•						
826	SAMMY	S	•	S			•				•	•																	
431	SCARLETT	•	•	•			•																						
304	SCOUT	•	•	•																		•							
725	SHERMAN	S	•	•			•					•																	
636	SHILOH	S	•	S												•	•	•	•		•								
712	SPARROW	S	•	S			•				•	•																	
632	TAHOE	S	•	•																		•			•				
724	TROUPER	S	S	S	•	•	•		•	•	•	•																	
403	VAIL	S	•	•			•				•																		
603	WILMETTE	S	•	S												•					•	•			•				
700	WYNNE	S	•	•			•				•	•																	



PRODUCT WARRANTY QUICK REFERENCE

	1 YEAR	2 YEARS	3 YEARS	5 YEARS	LIMITED LIFETIME
ROCKER RECLINERS, WALL RECLINERS, GLIDERS & RECLINA-WAY MOTION					
Mechanism					•
Frame					•
Show Wood	•				
Springs/Spring Systems and Swivels					•
Motor, Electrical Components			•		
AudioLuxe Electrical Components		•			
Battery Pack	•				
Cup Holders	•				
Polyurethane Foam Cushioning	•				
Ultra Plush Seat Cushioning	•				
La-Z-Boy® Contour Cushion (FS)			•		
LA-Z-TIME MOTION & MODULARS					
Mechanism, Mechanical Component					•
Frame					•
Show Wood	•				
Springs and Spring Systems					•
Cup Holders	•				
Polyurethane Foam Cushioning	•				
La-Z-Boy® Contour Cushion (FS)			•		
LA-Z-MOTION					
Mechanism			•		
Frame					•
Show Wood	•				
Springs/Spring Systems					•
Motor, Electrical Components			•		
Battery Pack	•				
Cup Holders	•				
Polyurethane Foam Cushioning	•				
La-Z-Boy® Contour Cushion (FS)			•		

	1 YEAR	3 YEARS	5 YEARS	LIMITED LIFETIME
CLASSICS				
Mechanism				•
Frame				•
Wood Frame (295-423)			•	
Show Wood	•			
Springs				•
Motor, Electrical Components		•		
Battery Pack	•			
Polyurethane Foam Cushioning	•			
La-Z-Boy® Contour Cushion (FS)		•		
COMPLEMENTS				
Mechanism				•
Frame				•
Wood Frame (265/245-408)			•	
Show Wood	•			
Springs and Swivels				•
Polyurethane Foam Cushioning	•			
ComfortCore® Cushion		•		
ComfortDown Cushion (DC)			•	
ComfortCore® with Contour Cushion (Z6)			•	
GOLD / PLATINUM / SILVER / BRONZE LIFT RECLINERS				
Lift Mechanism		•		
Frame				•
Springs and Spring Systems		•		
Motor, Electrical Components		•		
Polyurethane Foam Cushioning	•			
La-Z-Boy® Contour Cushion (FS)		•		



PRODUCT WARRANTY QUICK REFERENCE

	1 YEAR	3 YEARS	5 YEARS	LIMITED LIFETIME
duo™				
Frame				•
Show Wood	•			
Springs and Spring Systems				•
Mechanism				•
Motor, Electrical Components		•		
Battery Pack	•			
Polyurethane Foam Cushioning	•			
ComfortCore® Cushion		•		
ComfortDown Cushion (DC)			•	
ComfortCore® with Contour Cushion (Z6)			•	
STATIONARY SOFAS, SLEEP SOFAS, AND SECTIONALS				
Show Wood	•			
Frame				•
Springs and Spring Systems				•
Supreme Comfort Mechanism				•
Supreme Comfort Innerspring Mattress			•	
Slumber Air Mattress System			•	
Slumber Air Motor	•			
Tempur Response Mattress		•		
Polyurethane Foam Cushioning	•			
ComfortCore® Cushion		•		
ComfortDown Cushion (DC)			•	
ComfortCore® with Contour Cushion (Z6)			•	

	1 YEAR	3 YEARS	5 YEARS	LIMITED LIFETIME
FABRIC & LEATHER				
Fabric	•			
iClean® Fabric		•		
Leather	•			

FABRIC WARRANTY COVERAGE

Fabrics are warranted against nap loss, seam slippage and fabric separation. Warranty does not cover pilling, dye lot match or fading.

iClean® FABRIC and LEATHER WARRANTY COVERAGE

iClean® fabrics are warranted for three (3) years for specific stains. Standard fabric warranty for nap loss, seam failure and fabric separation applies. Labor: One (1) Year.

Covered stains include: beer, chocolate syrup, coffee, washable magic marker, dirt, ice cream, jelly, juices, ketchup, milk, salsa, soda, tea, urine, and wine.

Stains that ARE NOT covered include, but are not limited to: Oil-based products (such as salad dressing and lotion), wax-based products (such as candle wax and crayons), ink marks and mustard.

LEATHER WARRANTY COVERAGE

Leather warranty is one (1) year. (Warranty does not cover dye lot match or fading.)

La-Z-Boy Incorporated will pay reasonable and customary labor charges to repair or replace defective parts for one (1) year from the date of delivery to the original purchaser. No labor will be paid for replacing foam in styles with loose seat and/or back cushions. Please refer to the warranty card for further details.



TERMS AND CONDITIONS OF SALE

ACCEPTANCE OF TERMS AND CONDITIONS

These terms and conditions of sale shall govern all furniture orders submitted by any Dealer or reseller of La-Z-Boy products ("Dealer"). Any attempt to change or add to these terms by Dealer, or any conflicting terms on any correspondence, purchase order, or other form sent by Dealer is hereby objected to and rejected. Purchaser shall be deemed to have agreed to these terms and conditions of sale by placing an order, accepting delivery or by making payment for any order. No oral agreement, course of prior dealings between the parties or trade usage shall amend or supplement any of the terms or conditions herein. No additions or modifications can be made except in a writing signed by both Dealer and La-Z-Boy Incorporated ("La-Z-Boy") that expressly references the amendment of these terms. Hereunder, a reference to "you" shall mean a reference to the Dealer and a reference to "we" or "our" shall be a reference to La-Z-Boy

PRICING & TERMS

Pricing for products shall be as set forth in the applicable La-Z-Boy price list in effect on the date of our acceptance of a purchase order. Prices are subject to change without notice. Unless otherwise agreed upon, all prices are FOB point of origin. Title to the goods passes from La-Z-Boy to the Dealer when the goods are delivered to the common carrier. The Dealer assumes risk of loss or damage to the goods while they are in transit and is responsible for paying all shipping charges. Freight claims are the Dealer's responsibility, but La-Z-Boy will assist in processing claims on Dealer's behalf at the request of the Dealer.

All sales, use, excise and other taxes applicable to the sale of La-Z-Boy products shall be paid by Dealer. If Dealer claims an exemption from any tax, Dealer shall submit to La-Z-Boy the appropriate exemption certificates. Prepaid freight, sales taxes, and other such charges are not subject to any cash discount provided by La-Z-Boy.

Payment is due per the terms stated on your invoice. When invoices remain unpaid past such due date, new orders can be held by La-Z-Boy. In the event Dealer defaults on payment, Dealer shall be liable for all collection costs, including reasonable attorney's fees and costs. A SERVICE CHARGE OF THREE QUARTERS OF ONE PERCENT (3/4%) PER MONTH WILL BE CHARGED ON ALL PAST DUE ACCOUNTS.

CANADIAN DEALERS	
CURRENCY	All costs and upcharges are listed in U.S. dollars. All customized resales are listed in Canadian dollars.
IMPORT SURCHARGE	Certain styles may be subject to import surcharge which is not reflected in the prices shown. Please contact your La-Z-Boy Account Executive for details.

ELECTRONIC ORDER ENTRY

La-Z-Boy can receive orders manually or through Electronic Data Interface (EDI). If you are interested in EDI capability, please contact your Account Executive.

Interactively: Online access into the La-Z-Boy corporate computing services. This allows you to directly enter La-Z-Boy orders or inquire into their shipping status.

Batch: Information passed to and from your computer and the La-Z-Boy corporate computing services. This is often called electronic data interchange, or EDI. This allows you to send orders to La-Z-Boy that have already been entered into your computer.

ORDER FOBS (Refer to style for appropriate code.)

- 05 Neosho, Missouri
- 06 Dayton, Tennessee

ORDER ACKNOWLEDGEMENTS

La-Z-Boy will acknowledge all Dealer orders. You should examine your order acknowledgement data immediately upon receipt and promptly report any discrepancies to the Order Support department. If you do not report any discrepancy, you will be responsible for the order as acknowledged.

ORDER CANCELLATIONS

Custom orders or stock orders which are requested to "ship as soon as possible" may not be cancelled or changed as these items are put into production immediately. Once an order is selected for production, it cannot be changed or cancelled. The following exceptions apply (a) we will allow a 24-hour cancellation time on custom orders from the acknowledgement date, (b) cancellations are allowed on stock orders scheduled for future "expect-to-ship" ("ETS") dates provided such cancellations are received at least four (4) weeks prior to ship dates and provided that production on such order has not yet begun. Due to extended shipping times from global suppliers, cancellations on signature leather styles are not allowed once an ETS date is assigned.

ORDER CHANGES

Any requested order changes must be submitted in writing to our Order Support department, and we may accept or reject them at our discretion. Changes include style, cover, color, options, ship date, and quantity. In general, changes to Customer-sold orders will be honored if made within 24 hours of the acknowledgement date. Changes to stock orders with future ETS dates must be made four weeks prior to ship date.

LIMITED WARRANTY

(a) La-Z-Boy warrants only that its products sold to Dealer are free of defects in workmanship and materials, during the applicable warranty period set forth on the Warranty Quick Reference Guide attached hereto ("Warranty Guide"). The Warranty Guide can be updated by La-Z-Boy from time to time at its discretion.

(b) La-Z-Boy cannot guarantee fabrics or leather against fading, soiling, crushing or wear. Because of dye lot variation on fabric rolls, colors may not match exactly. Altering product or using non-La-Z-Boy parts will void the warranty.

ALL WARRANTIES ARE VOIDED BY EVIDENCE OF EXCESSIVE SOILING, IMPROPER CLEANING OR TREATMENT, ABUSE, OR ABNORMAL USE OR USE CONTRARY TO THE ADVISORIES PROVIDED BY LA-Z-BOY. WARRANTIES DO NOT APPLY TO PRODUCTS USED FOR RENTAL, BUSINESS, COMMERCIAL, INSTITUTIONAL, OR OTHER NON-RESIDENTIAL USES.

THESE WARRANTIES ARE YOUR EXCLUSIVE REMEDY AND NO OTHER WARRANTIES, EXPRESS OR IMPLIED, INCLUDING, BUT NOT LIMITED TO, THE IMPLIED WARRANTIES OF MERCHANTABILITY AND FITNESS FOR A PARTICULAR PURPOSE, APPLY. IN NO EVENT WILL LA-Z-BOY BE LIABLE FOR INCIDENTAL OR CONSEQUENTIAL DAMAGES, EVEN IF IT HAD REASON TO KNOW IN ADVANCE THAT SUCH DAMAGES WERE POSSIBLE. THE MAXIMUM LIABILITY, IF ANY, OF LA-Z-BOY FOR ALL DAMAGES HEREUNDER IS LIMITED TO THE PURCHASE PRICE OF THE DEFECTIVE OR NON-CONFORMING PRODUCTS. ANY ACTION ARISING HEREUNDER MUST BE BROUGHT WITHIN ONE YEAR FROM THE DATE OF SALE. THESE WARRANTIES GIVE YOU SPECIFIC LEGAL RIGHTS, AND YOU MAY HAVE OTHER RIGHTS THAT VARY FROM JURISDICTION TO JURISDICTION. SOME JURISDICTIONS DO NOT ALLOW THE EXCLUSION OF IMPLIED WARRANTIES OR THE LIMITATION OF DAMAGES SO THE ABOVE EXCLUSION AND LIMITATIONS MAY NOT APPLY TO YOU. IN THE EVENT THE WARRANTY EXCLUSIONS DO NOT APPLY TO YOU, THEN, WHERE LEGALLY PERMISSIBLE, SUCH WARRANTIES ARE LIMITED IN DURATION TO THE WARRANTY PERIOD AND NO WARRANTIES APPLY AFTER THAT PERIOD.

FORCE MAJEURE

La-Z-Boy shall not be liable or responsible to Dealer for any failure to perform to the extent such failure to perform is caused by or results from acts or circumstances beyond the reasonable control of La-Z-Boy including, without limitation, acts of God, flood, fire, earthquake, explosion, governmental actions, war, civil unrest, national emergency, or restraints or delays affecting carriers or inability or delay in obtaining supplies of adequate or suitable materials.

GOVERNING LAW AND JURISDICTION

Any disputes arising between La-Z-Boy and Dealer shall be governed by and construed in accordance with the internal laws of the State of Michigan without giving effect to any choice or conflict of law provision or rule. Any legal suit, action or proceeding arising out of or relating to purchases of products by Dealer from La-Z-Boy shall be instituted in the federal or state courts located in the state of Michigan and each party irrevocably submits to the exclusive jurisdiction of such courts in any such suit, action or proceeding.

SEVERABILITY

If any term or provision herein is invalid, illegal or unenforceable in any jurisdiction, such invalidity, illegality or unenforceability shall not affect any other term or provision or invalidate or render unenforceable such term or provision in any other jurisdiction

NONCONFORMING GOODS

You should immediately inspect each shipment completely when it arrives and immediately notify La-Z-Boy if you believe that all or a portion of any shipment is different from what you ordered. Dealers are bound to pay for all shipments accepted from the carrier regardless of whether the Dealer inspects the shipment.

DAMAGED MERCHANDISE RETURN POLICY

La-Z-Boy merchandise is thoroughly inspected and carefully packaged at point of shipment. Responsibility for its safe delivery was assumed by the carrier at the time of shipment. Therefore, any visible or concealed loss or damage must be so noted on the bill of lading at the time of receipt and a claim must be filed by the Dealer with the carrier for the damaged item. Contact the La-Z-Boy Logistics Department for any required assistance.

RETURNS

If an error occurs in your order, or if you receive defective merchandise, please report it to us as soon as possible in writing, but in no case later than 30-days of the invoice date. Claims not submitted in writing within 30 days of the invoice date will not be honored. No returns will be accepted without prior authorization from La-Z-Boy with a return authorization number assigned. We will refuse to accept delivery of any merchandise returned to us without such authorization.

PILLOWS ON LEATHER AND FAUX LEATHER UNITS

Pillows are not available in LL, LS, LM, RL, BU or UE cap codes.

To receive accent pillows on applicable LL, LS, LM, RL, BU or UE cap code styles, the P1 option **MUST** be entered with an appropriate (non-BU or UE cap code) fabric number.

If the P1 option is not ordered, no accent pillows will ship with the unit.

Custom pillows are complimentary.

STYLE AND PREFIX STATUS

NEW! - Style and/or Prefix is new to the product offering. First ship dates vary. Please consult your sales representative for details.

DISC! - Style and/or Prefix is being discontinued. Orders will not be accepted after the last acknowledgement date.

PHASE OUT (WQL) - Style, Prefix, and/or Select Cover is being phased out, but will remain active and orders will be accepted while quantities last (WQL).

Note: Select Cover phase outs have (WQL) listed after the cover number / name on the style page.

FINISHES

007 FINISH - BROWN MAHOGANY



The medium brown patina of this finish is a classic that easily mixes with other finishes in a room for an enduring look that never goes out of style.

021 FINISH - COFFEE



A deep rich finish with dark brown undertones, this sophisticated hue creates a contemporary vibe and an up-to-the-minute look.

041 FINISH - GRAPHITE



With understated gray tones that project a style that's both dramatic and modern, this finish makes a powerful design statement in any room.

071 FINISH - DRIFTWOOD



This textured, lighter natural wood tone produces a more casual finish that is mixable within any room environment.

142 FINISH - MESA

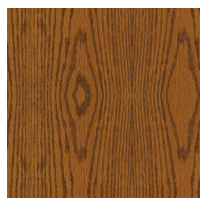

Medium brown with red undertones, this finish has a look that will add both richness and warmth to the look of your home.

*Only available on 295-423

DIMENSIONS

La-Z-Boy products are hand crafted and variations from standard dimensions can occur. Construction differences in upholstery covering (cloth and leather) can cause variances in dimensions. In addition, construction differences in cloth upholstery fabrics can cause variance on the product's appearance. Standard dimension codes are listed for each product and are listed below. For more detailed specifications and dimensions, please refer to the Product Information Guide.

H: Height	W: Width	D: Depth	RD: Recline Distance	WT: Weight
SH: Seat Height	SW: Seat Width	SD: Seat Depth	AH: Arm Height	SF: Seat Factor

DIMENSION DESCRIPTIONS

- Height (Back)) - From floor to top and center of back.
- Width (Body) - Outside width of body at widest point-including handle.
- Depth (Body) - Depth of unit from wall to front edge (measurement taken when unit is pushed up against wall).
- Seat Height - From floor to top of seat cushion crown.
- Seat Width (Inside Arms) - Cushion width from inside of both front arms.
- Seat Depth - From front cushion seat face to lower inside back pillow.
- Arm Height - From floor to top of arm.
- Fully Extended - Depth of unit from front of legrest to top of back when fully reclined/extended.

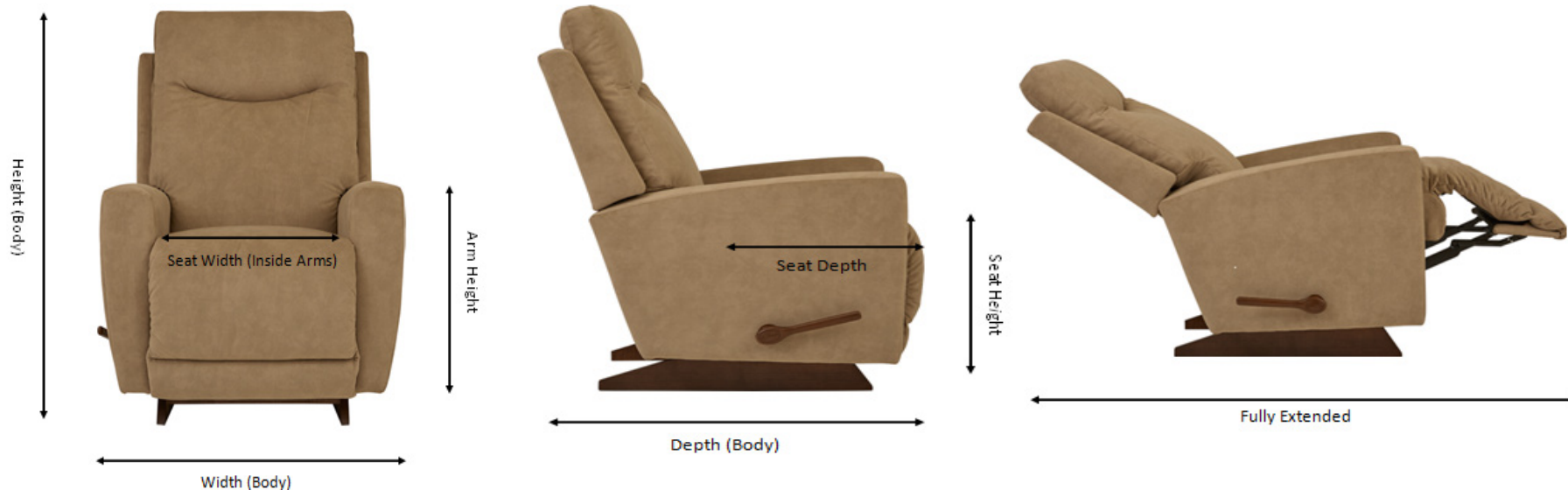

CORNER UNIT WALL SPACE

When measuring wall space on a corner unit, the Wall Space Required dimension is the total distance of wall space used for both sides of the corner unit when placed in a 90° corner. When measuring wall space, do not measure around the corner, measure each wall separately. Please refer to a modular pad with a corner unit for additional help.

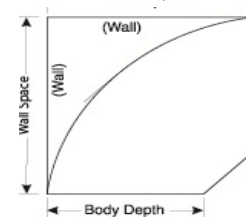

SEAT FACTORS

Seat factor information is listed in the price book for each style. Please note seat factors are determined by packaging dimensions, NOT the style dimensions. This information has been added for a quick reference. If there are any discrepancies between the information provided in this price book and the official seat factor listing provided and maintained by our logistics department, the logistics document takes precedence.

COVER AVAILABILITY (CAP) CODE

Fabric Cap Codes

UR (Up the Roll)

The vertical direction of the pattern pieces is cut parallel to the selvage. No pattern match is possible. With the exception of velvet, no fabric pattern direction is evident. When UR cap code fabrics are applied to sofas, sleep Sofas, and multiple seat modular units, the front rail will be vertically seamed and may not match horizontally or vertically.

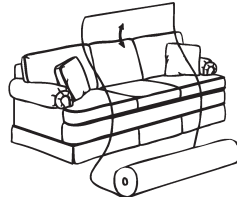

DR (Directional Railroad)

The vertical direction of the pattern pieces is cut perpendicular to the selvage (railroad). No vertical fabric pattern match is possible. There may or may not be a horizontal fabric pattern match depending on fabric design.

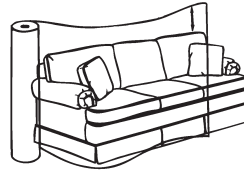

VS (Vertical Stripe)

Fabric is railroaded and is matched vertically only. The vertical direction of the fabric pattern pieces is cut perpendicular to the selvage. Seat cushions are reversible on mirrored- image design fabrics. Note: The outside back matching and piecing will vary by style and the design of the product.

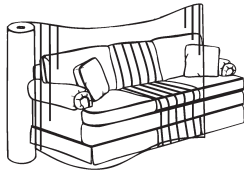

PS (Plaid Stripe)

Fabric is railroaded and is matched vertically and horizontally. The vertical direction of the fabric pattern pieces is cut perpendicular to the selvage. Seat cushions are reversible in the case of mirror - image design fabrics. Note: The outside back matching and piecing will vary by style and the design of the product.

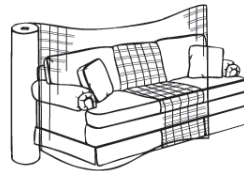

DP (Directional Plaid)

Fabric is railroaded and is matched vertically and horizontally. The fabric pattern has an upward direction. Seat cushions are reversible. The vertical direction of the fabric pattern pieces is cut perpendicular to the selvage. Note: The outside back matching and piecing will vary by style and the design of the product.

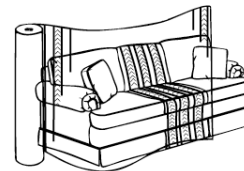

NP (Non-Mirrored Plaid)

Fabric is railroaded and is matched vertically only. The fabric has a non-mirrored image in the design of the fabric making the seat cushions non-reversible. Note: The outside back matching and piecing will vary by style and the design of the product.

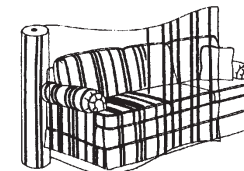

HS (Horizontal Stripe)

Fabric is a vertical direction with pattern pieces cut parallel to the selvage. Pattern pieces are locked on the stripe line allowing a horizontal flow across the inside backs, inside arms, seats, and rails..

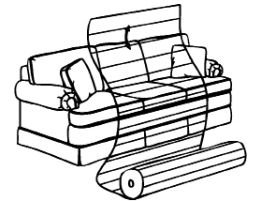

UE (Urethane)

The vertical direction of the pattern pieces is cut perpendicular to the selvage (railroad). No vertical fabric pattern match is possible. Units with loose seats and/or backs will have venting and/or tan denim on one side.



BU (Breathable Urethane)

The vertical direction of the pattern pieces is cut perpendicular to the selvage (railroad). No vertical fabric pattern match is possible. After-treatment should not be used on BU cap code covers. Units with loose seats and/or backs will have venting and/or tan denim on one side.

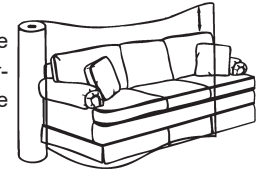

RL (Recycled Leather)

A composite material constructed of recycled leather scraps with a cellular polyurethane face. The vertical direction of the pattern pieces is cut perpendicular to the selvage (railroad). No vertical fabric pattern match is possible. After-treatment should not be used on RL cap code covers. Units with loose seats and/or backs will have venting and/or tan denim on one side..

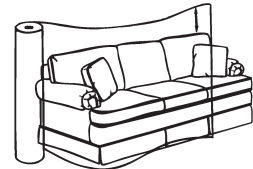

Leather Cap Codes

LM (Leather Mate)

This is a combination of leather and vinyl or leather and polyurethane. The leather pieces are in areas that "touch the body", i.e. back, seat, inside arms. The vinyl or polyurethane pieces are the outer parts of the unit.

LL (Full Leather)

This unit will be covered in all top grain leather. Units with loose seats and/or backs will have venting and/or tan denim on one side.

All SELECT LEATHER is leather/urethane match.

FABRIC WEARABILITY



NORMAL

This fabric is recommended for use on all La-Z-Boy upholstered furniture.



MEDIUM

This fabric is recommended for use on sofas, sleep sofas, Duo®, La-Z-Boy Classics®, and Occasional Chairs. It is not allowed for use on recliners, motion sofas, or motion modulars.



PERFORMANCE

This fabric is recommended for use on all La-Z-Boy upholstered furniture. While La-Z-Boy's fabrics are all tested to the highest industry standards, Performance Fabrics must receive excellent ratings for physical durability. Performance fabrics outperform other fabrics by receiving outstanding results for pilling, abrasion and fraying.

SPECIALTY FABRIC DESCRIPTIONS



STAIN RESISTANT - Innovative i-Clean® technology surrounds each fabric fiber creating a barrier that repels spills before they turn into stains.



PET FRIENDLY - These fabrics are durability tested to simulate scratches and wear from pets and include i-Clean® technology.



ECO FRIENDLY - conserve Sustainable Fabrics are soft, durable and made from recycled water bottles.



ENERGY RESTORATION - Restore by Nanobionic features a mineral-based fabric coating that transforms natural body heat into energy.



ANTIMICROBIAL - Antimicrobial properties surround each fiber to protect against mold, mildew and odor-causing bacteria.



BLEACH CLEANABLE - May be cleaned with a proper ratio of 1 part household bleach to 10 parts water. Thoroughly rinse with water following diluted bleach cleaning.

LEATHER HIDES

Leather can be ordered through the Fabric Order Tab in A.S.A.P also. It is only available by the full hide and priced as such, depending on leather grade. Each hide is approximately 52-54 square feet

LEATHER SEATING

Leather seating may have a tendency to develop body impressions on seats and backs. These impressions are the result of stretching of fibers and should not be considered defective workmanship, tailoring or material.

Note: All upholstery covered in ALL LEATHER have pieced outside sides and backs. In addition, some recliners have other parts pieced, which varies by style. Units with loose seats and/or backs will have venting and/or tan denim on one side.

CLEANING CODE INSTRUCTIONS

- W** Use a water-based cleaning agent or foam. Professional cleaning is recommended.
- S** Use a mild, water-free dry cleaning agent. Professional cleaning is recommended.
- WS** Either water-based cleaning agents or a dry cleaning solvent or foam type cleaner may be used. Professional cleaning is recommended.
- X** Do not use a foam or liquid cleaner of any type. Vacuum or brush lightly to remove soil. Professional cleaning is recommended.
- W*B** Use a water-based cleaning agent or foam. *May be cleaned with a proper ratio of 1 part household bleach to 10 parts water. Thoroughly rinse with water following diluted bleach cleaning. Professional cleaning is recommended.

Standard Reclining Seat Construction Standard seat constructions consist of original chaise and non-chaise seating, pillow tops, box borders and bullnose - featuring 27 lb./1.8 density polyurethane foam standard seat cores and spring ups.

Ultra Plush A softer seat is achieved by adding an extra layer of 12 lb. polyurethane foam on top of the polyurethane foam core.

Summit Five seat springs and a 36 lb. foam core give the Summit optimal support.

Lift Seat Construction The 36 lb./2.5 density core allows for a lower profile lift chair seat, while a soft batting topper gives extra comfort. The seat is reinforced with a spring support and a deck pad.

Faux Box Border Features a completely square 27 lb. polyurethane foam core giving the seat a look resembling stationary seat seating

Comfort Essentials Stationary Cushion Stationary seating construction featuring a 27 lb. polyurethane foam core with a 20 lb. topper foam and wrapped in a 3/4 ounce batting.

ComfortCore® Standard for La-Z-Boy Premier stationary seating construction. Features zoned cushioning consisting of a 36 lb. and 27 lb. polyurethane center

Content

- 1 - Nonwoven Spring Cover
- 2 - Flex Pad
- 3 - Polyurethane Foam Core 27 lb./1.8 Density
- 4 - Polyurethane Foam Core 36 lb./2.5 Density
- 5 - Polyurethane Foam Topper 12 lb./1.1 Density
- 6 - Polyurethane Foam Topper 20 lb./1.1 Density
- 7 - 3/4 oz Batting

Standard Reclining

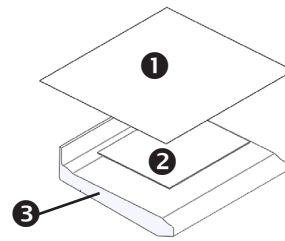

Ultra Plush

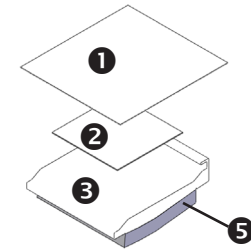

Summit

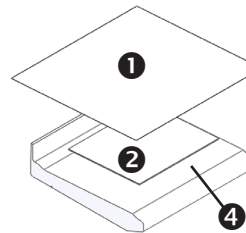

Lift

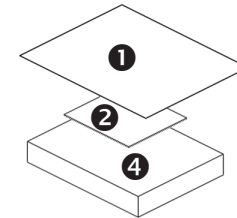

Faux Box Border

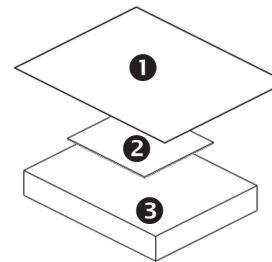

Comfort Essentials Stationary

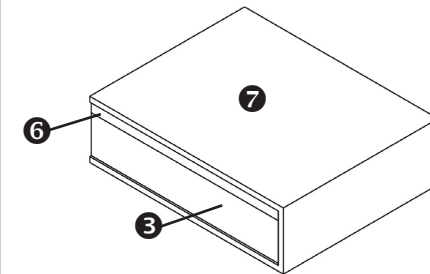

ComfortCore

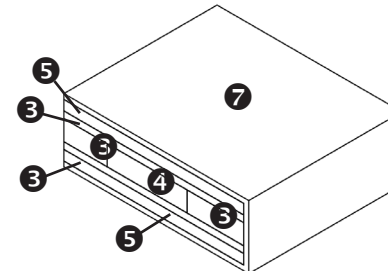

Original Bucket Thin, wedge-shaped polyurethane foam seat side fillers create a soft bucket shape.

Sculpted Bucket Top and bottom polyurethane foam fillers create a deep sculpted seat. The top fillers do not extend to the front of the seat.

440/444 Sculpted Bucket Features 36 lb. top polyurethane foam wedge fillers for increased support.

Hybrid Bucket Includes 27 lb. top polyurethane foam fillers that extend to the front of the seat, and 36 lb. bottom foam fillers.

440/444 Hybrid Bucket Supportive 36 lb. polyurethane foam wedge fillers sit on top of a contour cut polyurethane foam core.

Original Bucket

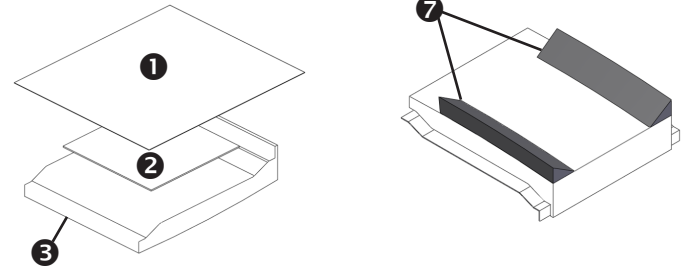

Sculpted Bucket

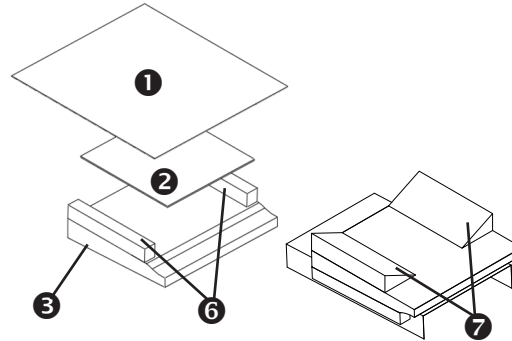

440/444 Sculpted

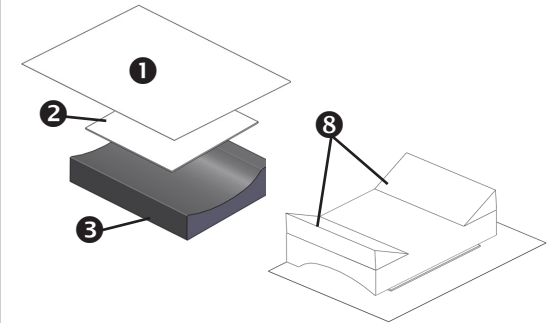

Hybrid Bucket

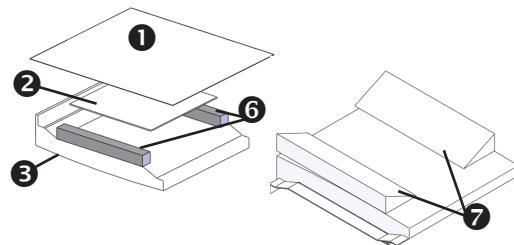

440/444 Hybrid Bucket

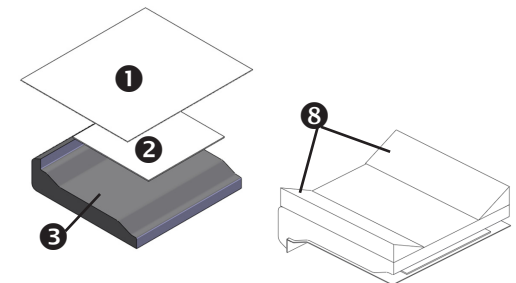

Content

- 1 - Nonwoven Spring Cover
- 2 - Flex Pad
- 3 - Polyurethane Foam Core 27 lb./1.8 Density
- 4 - Polyurethane Foam Core 36 lb./2.5 Density
- 5 - Polyurethane Foam Topper 12 lb./1.1 Density
- 6 - Polyurethane Foam Fillers 36 lb./2.5 Density
- 7 - Seat Side Polyurethane Foam Fillers 27 lb./1.8 Density
- 8 - Seat Side Polyurethane Foam Fillers 36 lb./2.5 Density

La-Z-Boy® Contour Cushion Reclining seat construction features a seat topper of temperature-resistant, 2.5 density foam to provide superior relaxation as the foam contours to your body. Couples with a 2.5 density 36 lb. polyurethane core for additional support. Chaise seats additionally feature temperature-resistant polyurethane within the chaise.

La-Z-Boy® Contour Cushion - Bucket Construction A 2.5 density 36 lb. polyurethane core pairs with a temperature-resistant polyurethane chaise to provide superior relaxation with long-term support.

ComfortCore® with Contour This La-Z-Boy Premier stationary seating upgrade features the patented zone seat construction. From the ComfortCore® construction, the outer 12 lb. polyurethane layers have been replaced with temperature-resistant, 2.5 density foam to provide superior relaxation as the foam contours to your body. The 27 lb. inner polyurethane layers in the standard cushion are also replaced with 36 lb. polyurethane for additional support.

ComfortDown La-Z-Boy Premier stationary seating upgrade featuring pocketed coil springs wrapped in 1.8 density polyurethane foam and 1 oz. batting, contained within a 50/50 blended 10/90 down feather/7-denier polyester fiber filled jacket of down-proof ticking.

Content

- 1 - Nonwoven Spring Cover
- 2 - Flex Pad
- 3 - Polyurethane Foam Core 27 lb./1.8 Density
- 4 - Polyurethane Foam Core 36 lb./2.5 Density
- 5 - Temperature-Resistant Polyurethane Foam Topper 2.5 Density
- 6 - Polyurethane Foam 16 lb./1.8 Density
- 7 - 3/4 oz Batting
- 8 - Down-Feather/Fiber Filled Jacket
- 9 - Pocketed Coil Springs

La-Z-Boy® Contour

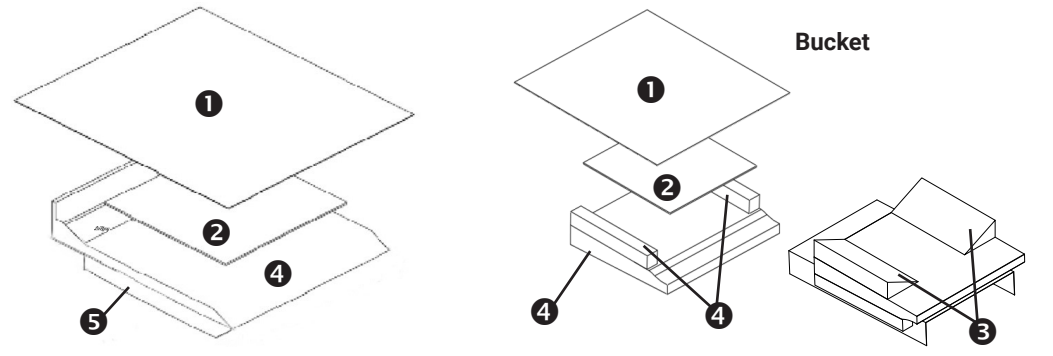

ComfortCore® with Con-

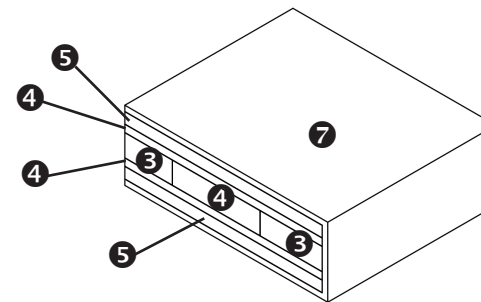

ComfortDown

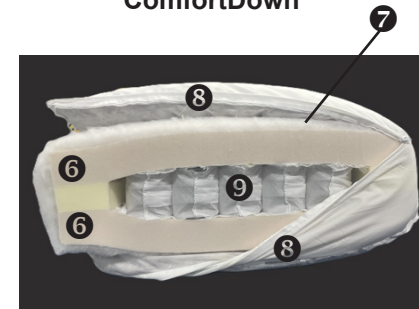

YARDAGE				Fabric can be ordered through the Cover Order tab in S.P.O.T. Fabric width is 54 inches and is priced per yard. Following are the prices per yard of fabric.			
B-C		D-F, RE		G-N		P-Q	
\$69		\$79		\$89		\$99	

ARM CAPS & DEMO CUSHIONS	PRICING	ORDER FOB'S	STD FINISH	OPT FINISHES	CAP CODES	SPECIAL INFO	DIMENSIONS			
							H	W	D	SF
088AC2 (2) Napkin-Style Arm Cap / Headrest Covers	\$69	06	N/A	N/A	DR, UR, DP, NP, PS, UE, VS, BU, RL	Shipped separately via UPS only. NOT available in LL, LS, or LM cap codes. No warranty.	-	16.8	16.8	-
088AC3 (3) Napkin-Style Arm Cap / Headrest Covers	\$89	06	N/A	N/A	DR, UR, DP, NP, PS, UE, VS, BU, RL	Shipped separately via UPS only. NOT available in LL, LS, or LM cap codes. No warranty.	-	16.8	16.8	-
088AC4 (4) Napkin-Style Arm Cap / Headrest Covers	\$119	06	N/A	N/A	DR, UR, DP, NP, PS, UE, VS, BU, RL	Shipped separately via UPS only. NOT available in LL, LS, or LM cap codes. No warranty.	-	16.8	16.8	-
D88613 Olson DC Demo Cushion	Leather: \$389 Fabric: \$339	06	N/A	N/A	DR, UR, DP, NP, PS, UE, VS, BU, RL	Includes one (1) demonstration cushion with the DC option (D88) for use on the 610-613 Olson sofa.	-	-	-	-
Z88613 Olson Z6 Demo Cushion	Fabric: \$229 Leather: \$279	06	N/A	N/A	DR, UR, DP, NP, PS, UE, VS, BU, RL	Includes one (1) demonstration cushion with the Z6 option (Z88) for use on the 610-613 Olson sofa.	-	-	-	-
D88636 Shiloh DC Demo Cushion	Leather: \$389 Fabric: \$339	06	N/A	N/A	DR, UR, DP, NP, PS, UE, VS, BU, RL	Includes one (1) demonstration cushion with the DC option (D88) for use on the 610-636 Shiloh sofa.	-	-	-	-
Z88636 Shiloh Z6 Demo Cushion	Fabric: \$229 Leather: \$279	06	N/A	N/A	DR, UR, DP, NP, PS, UE, VS, BU, RL	One (1) demonstration cushion with the Z6 option (Z88) for use on the 610-636 Shiloh sofa.	-	-	-	-
D88638 Charlie DC Demo Cushion	Fabric: \$339 Leather: \$389	06	N/A	N/A	DR, UR, DP, NP, PS, UE, VS, BU, RL	One (1) demonstration cushion with the DC option (D88) for use on the 610-638 Charlie sofa.	-	-	-	-
Z88638 Charlie Z6 Demo Cushion	Leather: \$279 Fabric: \$229	06	N/A	N/A	DR, UR, DP, NP, PS, UE, VS, BU, RL	One (1) demonstration cushion with either the Z6 option (Z88) for use on the 610-638 Charlie sofa.	-	-	-	-

AUDIO	PRICING	ORDER FOB'S	STD FINISH	OPT FINISHES	CAP CODES	SPECIAL INFO	DIMENSIONS			
							H	W	D	SF
NEW! 0881AT Audio Transmitter	\$159	36, 45	N/A	N/A	N/A	Audio Transmitter (dongle) for use with A86 Ovation Audio	-	-	-	-
NEW! 0881SB Klipsch Flexus CORE 200 Soundbar	\$889	36, 45	N/A	N/A	N/A	Klipsch Flexus CORE 200 Soundbar - for use with A86 Ovation Audio	-	-	-	-

RECLINER SWIVEL & TALL BASES	PRICING	ORDER FOB'S	STD FINISH	OPT FINISHES	CAP CODES	SPECIAL INFO	DIMENSIONS			
							H	W	D	SF
088123 Swivel Base Assembly Kit - Standard Manual Rocker	\$179	36, 45	007	021	N/A	360-degree swivel. Reference Product Information Guide for compatible base assembly kit number(s).	-	-	-	-
088124 Swivel Base Assembly Kit - Tall Manual Rocker	\$179	36, 45	007	021	N/A	360-degree swivel. Reference Product Information Guide for compatible base assembly kit number(s).	-	-	-	-
088126 Swivel Base Assembly Kit - Standard Power Rocker	\$179	36, 45	007	021	N/A	145-degree swivel. Reference Product Information Guide for compatible base assembly kit number(s).	-	-	-	-
08812T Swivel Base Assembly Kit - Tall Power Rocker	\$179	36, 45	007	021	N/A	145-degree swivel. Also adds 1 inch to seat height and overall height. Reference Product Information Guide for compatible base assembly kit number(s).	-	-	-	-
088131 Rocker Base Assembly Kit - Standard	\$89	36, 45	007	021	N/A	Reference Product Information Guide for compatible base assembly kit number(s).	-	-	-	-
088210 Rocker Base Assembly Kit - Tall	\$89	36, 45	007	021	N/A	Adds 1.5 inches to seat height and overall height. Reference Product Information Guide for compatible base assembly kit number(s).	-	-	-	-
088212 Rocker Base Assembly Kit - Summit	\$89	36, 45	007	021	N/A	Adds 1.5 inches to seat height and overall height. Reference Product Information Guide for compatible base assembly kit number(s).	-	-	-	-
088266 Wall Recliner Base Assembly Kit - Tall	\$89	36, 45	007	021	N/A	Adds 1.5 inches to seat height and overall height. Reference Product Information Guide for compatible base assembly kit number(s).	-	-	-	-
088268 Wall Recliner Base Assembly Kit - Summit	\$89	36, 45	007	021	N/A	Allows for base finish change on inventory.	-	-	-	-

BATTERY PACKS	PRICING	ORDER FOB'S	STD FINISH	OPT FINISHES	CAP CODES	SPECIAL INFO	DIMENSIONS			
							H	W	D	SF
088BP1 Battery Pack (for styles w/ (1) power supply)	\$169	36	N/A	N/A	N/A	Replaces corded power supply. Includes (1) battery pack. Not for use with LUXURY-LIFT® chairs or Power Bundle consoles.	-	-	-	-
088BP2 Battery Pack (for styles w/ (2) power supplies)	\$339	36	N/A	N/A	N/A	Replaces corded power supply. Includes (2) battery packs. Not for use with LUXURY-LIFT® chairs or Power Bundle consoles	-	-	-	-
0881YC duo® Battery Pack (for styles w/ (2) power recliners)	\$339	36	N/A	N/A	N/A	Replaces corded power supply. Includes (2) battery packs and (1) battery shelf. Not for use with LUXURY-LIFT® chairs or Power Bundle consoles.	-	-	-	-

HANDLES BY THE CASE - ARC	PRICING	ORDER FOB'S	STD FINISH	OPT FINISHES	CAP CODES	SPECIAL INFO	DIMENSIONS			
							H	W	D	SF
088HAL Arc Handle - Left Side Sitting	\$39	36	N/A	N/A	N/A	Minimum order (case) quantity = 48. 1 unit (1 handle + 1 escutcheon).	-	-	-	-
088HAR Arc Handle - Right Side Sitting	\$39	36	N/A	N/A	N/A	Minimum order (case) quantity = 48. 1 unit (1 handle + 1 escutcheon).	-	-	-	-
088HBL Black Arc Handle - Left Side Sitting	\$39	36	N/A	N/A	N/A	Minimum order (case) quantity = 48. 1 unit (1 handle + 1 escutcheon).	-	-	-	-
088HBR Black Arc Handle - Right Side Sitting	\$39	36	N/A	N/A	N/A	Minimum order (case) quantity = 48. 1 unit (1 handle + 1 escutcheon).	-	-	-	-

HANDLES BY THE CASE - STANDARD	PRICING	ORDER FOB'S	STD FINISH	OPT FINISHES	CAP CODES	SPECIAL INFO	DIMENSIONS			
							H	W	D	SF
088HEL Elongated Handle - Left Side Sitting	\$19	36	007	021	N/A	Minimum order (case) quantity = 100. 1 unit (1 handle + 1 escutcheon).	-	-	-	-
088HER Elongated Handle - Right Side Sitting	\$19	36	007	021	N/A	Minimum order (case) quantity = 100. 1 unit (1 handle + 1 escutcheon).	-	-	-	-
088HCL Standard Handle - Left Side Sitting	\$19	36	007	021	N/A	Minimum order (case) quantity = 100. 1 unit (1 handle + 1 escutcheon).	-	-	-	-
088HCR Standard Handle - Right Side Sitting	\$19	36	007	021	N/A	Minimum order (case) quantity = 100. 1 unit (1 handle + 1 escutcheon).	-	-	-	-





MISC ITEMS	PRICING	ORDER FOB'S	STD FINISH	OPT FINISHES	CAP CODES	SPECIAL INFO	DIMENSIONS			
							H	W	D	SF
088110 Removable Table Kit for Power Bundle Console	\$119	36, 37	N/A	N/A	N/A	Includes (1) removable table that can be used with the table ports included as part of the CB option on 449/U49/X49 and SC4 prefixes. NOTE: Only recommended for use on console units.	-	-	-	-
088111 Removeable Tablet Holder for Power Console Bundle	\$119	36, 37	N/A	N/A	N/A	Includes (1) removable tablet holder that can be used with the table ports included as part of the CB option on 449/U49/X49 prefixes. NOTE: Comes standard with 762 Neo.	-	-	-	-
088112 Removable Table Kit for Power Bundle Console - Brown Mahogany	\$119	36, 37	N/A	N/A	N/A	Includes (1) removable wood table in brown mahogany finish that can be used with the table ports included as part of the CM option on loveseat w/ console and SC3/SC4 prefixes. NOTE: Only recommended for use on console units.	-	-	-	-
088113 Removable Table Kit for Power Bundle Console - Coffee	\$119	36, 37	N/A	N/A	N/A	Includes (1) removable wood table in coffee finish that can be used with the table ports included as part of the CC option on loveseat w/ console and SC3/SC4 prefixes. NOTE: Only recommended for use on console units.	-	-	-	-

MISC ITEMS	PRICING	ORDER FOB'S	STD FINISH	OPT FINISHES	CAP CODES	SPECIAL INFO	DIMENSIONS			
							H	W	D	SF
0881CT Case of Removable Table Kits for Power Bundle Console	\$1339	36, 37	N/A	N/A	N/A	Includes (12) removable tables that can be used with the table ports included as part of the CB option on 449/U49/X49 and SC4 prefixes.	-	-	-	-
0881CH Case of Removable Tablet Holder Kits for Table Port	\$1779	36, 37	N/A	N/A	N/A	Includes (16) removable tablet holders that can be used with the table ports included as part of the CB option on 449/U49/X49 prefixes.	-	-	-	-
0881CC Case of Removable Table Kits for Power Bundle Console - Coffee	\$1339	36, 37	N/A	N/A	N/A	Includes (12) removable wood tables in coffee finish that can be used with the table ports included as part of the CC option on loveseat w/ console and SC3/SC4 prefixes. NOTE: Only recommended for use on console units.	-	-	-	-
0881CM Case of Removable Table Kits for Power Bundle Console - Brown Mahogany	\$1339	36, 37	N/A	N/A	N/A	Includes (12) removable wood tables in brown mahogany finish that can be used with the table ports included as part of the CM option on loveseat w/ console and SC3/SC4 prefixes. NOTE: Only recommended for use on console units.	-	-	-	-













SLUMBER AIR MATTRESSES	PRICING	ORDER FOB'S	STD FINISH	OPT FINISHES	CAP CODES	SPECIAL INFO	DIMENSIONS			
							H	W	D	SF
088151 SlumberAir® Mattress System - Queen	\$669	36, 37	N/A	N/A	N/A	MUST be used in a sleeper mechanism that can accommodate at least a 5" mattress or the warranty is void.	-	-	-	1
088152 SlumberAir® Mattress System - Full	\$669	36, 37	N/A	N/A	N/A	MUST be used in a sleeper mechanism that can accommodate at least a 5" mattress or the warranty is void.	-	-	-	1
088155 SlumberAir® Mattress System - Twin	\$669	36, 37	N/A	N/A	N/A	MUST be used in a sleeper mechanism that can accommodate at least a 5" mattress or the warranty is void.	-	-	-	1













TEMPUR-RESPONSE MATTRESSES	PRICING	ORDER FOB'S	STD FINISH	OPT FINISHES	CAP CODES	SPECIAL INFO	DIMENSIONS			
							H	W	D	SF
088T51 Tempur-Response® Mattress - Queen	\$779	36, 37	N/A	N/A	N/A	La-Z-Boy® plus TEMPUR-Response® Memory Foam mattresses are sensitive to temperature and may feel firmer in rooms 65° F or colder. Mattresses are responsive to body temperature and will soften when occupied. The use of electric blankets or heating pads is not recommended.	5	60	72	1







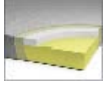

TEMPUR-RESPONSE MATTRESSES	PRICING	ORDER FOB'S	STD FINISH	OPT FINISHES	CAP CODES	SPECIAL INFO	DIMENSIONS			
							H	W	D	SF
088T52 Tempur-Response® Mattress - Full	\$779	36, 37	N/A	N/A	N/A	La-Z-Boy® plus TEMPUR-Response® Memory Foam mattresses are sensitive to temperature and may feel firmer in rooms 65° F or colder. Mattresses are responsive to body temperature and will soften when occupied. The use of electric blankets or heating pads is not recommended.	5	52	72	1
088T55 Tempur-Response® Mattress - Twin	\$779	36, 37	N/A	N/A	N/A	La-Z-Boy® plus TEMPUR-Response® Memory Foam mattresses are sensitive to temperature and may feel firmer in rooms 65° F or colder. Mattresses are responsive to body temperature and will soften when occupied. The use of electric blankets or heating pads is not recommended.	5	32	72	1

FEATURES (STANDARD)	PRICING	SPECIAL INFO
 DS Dual Comfort Selector - Standard (Feature)	\$0	Designates that a unit features right and left side sitting standard handles.
 NN No Nail Head Trim (Feature)	\$0	Removes standard Nail Head Trim.
 RT Control Panel (Feature)	\$0	Designates that a unit features a right side sitting control panel.
SS Standard Seat Construction (Feature)	\$0	Designates the unit features the standard construction based on the product category.
 T2 Dual Control Panel (Feature)	\$0	Designates that a unit features right and left side sitting control panels.

OPTIONS	PRICING	SPECIAL INFO
 1H Dual Comfort Selector - Arc	\$119	Replaces standard handles with two (2) Arc style handles; Brushed Nickel finish.

OPTIONS	PRICING	SPECIAL INFO
 <p>2E Dual Comfort Selectors - Elongated</p>	<p>\$119</p>	<p>Replaces standard handles with two (2) elongated handles, adding 2 inches in length to each comfort selector.</p>
 <p>3H Dual Comfort Selectors - Black Arc</p>	<p>\$119</p>	<p>Replaces standard handles with two (2) Arc style handles; Matte Black finish.</p>
 <p>4C Casters</p>	<p>\$59</p>	<p>Replaces all four stationary legs with casters.</p>
 <p>CB Power Console Bundle - Black</p>	<p>\$339</p>	<p>Adds (1) wireless charging tray, (2) electrical outlets and (2) USB ports to the inside of the storage tub (under flip-top), (2) table ports and (1) removable table.</p>
 <p>CC Power Console Bundle - Coffee</p>	<p>\$339</p>	<p>Adds (1) wireless charging tray, (2) electrical outlets and (2) USB ports to the inside of the storage tub (under flip-top), (2) table ports and (1) removable wood table in coffee finish.</p>
 <p>CM Power Console Bundle - Brown Mahogany</p>	<p>\$339</p>	<p>Adds (1) wireless charging tray, (2) electrical outlets and (2) USB ports to the inside of the storage tub (under flip-top), (2) table ports and (1) removable wood table in brown mahogany finish.</p>
 <p>DC ComfortDown Cushion</p>	<p>Sofa: \$499 Loveseat / Chaise / Cuddler / Corner: \$339 Chair / Single Arm / Armless Middle: \$169</p>	<p>Upgrades standard ComfortCore® seat cushions to ComfortDown Cushion which features individually pocketed coil springs and high-resiliency foam core, wrapped in a 90/10% feather/down and 50% fiber blend jacket.</p>
 <p>ES Single Comfort Selector - Elongated</p>	<p>\$59</p>	<p>Replaces standard handle with elongated handle, adding 2 inches in length to the comfort selector.</p>
 <p>FN Finish Change</p>	<p>Recliners, Motion: \$0</p>	<p>Changes the finish color. Enter option code followed by the 3-digit finish color number. Reference style pages for appropriate optional finish color codes.</p>
 <p>FP FeatherLite Comfort Pillow(s)</p>	<p>Double-Pillow units: \$59 Single-Pillow units: \$39</p>	<p>Upgrades ALL accent pillows to the luxurious comfort of 95% duck feathers, 5% duck down.</p>
 <p>FS La-Z-Boy® Contour Cushion</p>	<p>Loveseat/Chaise/Cuddler/Corner/Chair & a Half: \$229 Chair/Single Seat: \$119 Sofa: \$339</p>	<p>Upgrades standard seat, chaise, and legrest on recliner and motion sofa styles to La-Z-Boy® Contour Cushion foam cushioning.</p>
 <p>H1 Single Comfort Selector - Arc</p>	<p>\$59</p>	<p>Replaces standard handle with Arc style handle; Brushed Nickel finish.</p>

OPTIONS	PRICING	SPECIAL INFO
 <p>H3 Single Comfort Selector - Black Arc</p>	<p>\$59</p>	<p>Replaces standard handle with Arc style handle; Matte Black finish.</p>
 <p>HW Hand Wand</p>	<p>\$59</p>	<p>Replaces standard control panel with corded hand wand.</p>
 <p>L1 Left Side Sitting Comfort Selector - Arc</p>	<p>\$59</p>	<p>Replaces standard handle with Arc style handle and moves it to left side sitting; Brushed Nickel finish.</p>
 <p>L3 Left Side Sitting Comfort Selector - Black Arc</p>	<p>\$59</p>	<p>Replaces standard handle with Arc style handle and moves it to left side sitting; Matte Black finish.</p>
 <p>LE Left Side Sitting Comfort Selector - Elongated</p>	<p>\$59</p>	<p>Replaces standard handle with elongated handle, adding 2 inches in length to the comfort selector, and moves it to left side sitting.</p>
 <p>LG Leg Change</p>	<p>\$59</p>	<p>Changes the standard leg to a different leg design. Leg designs vary by style; reference style pages, under "Special Information" for details.</p>
 <p>LS Left Side Sitting Comfort Selector - Standard</p>	<p>\$0</p>	<p>Changes location of the handle from right side sitting to left side sitting.</p>
 <p>LT Left Side Sitting Activation - Control Panel</p>	<p>\$0</p>	<p>Changes location of the control panel from right side sitting to left side sitting.</p>
 <p>LW Left Side Sitting Activation - Wireless Remote</p>	<p>Recliners: \$0 Motion / Modulars: \$119</p>	<p>Replaces standard control panel with a mounted cradle with wireless remote and moves it to left side sitting.</p>
 <p>MA SlumberAir® Mattress System</p>	<p>\$449</p>	<p>Replaces standard sleeper mattress to SlumberAir® mattress with inflatable air-cushioned top. Includes electric air pump.</p>
 <p>MT Tempur-Response® Mattress</p>	<p>\$559</p>	<p>Replaces standard sleeper mattress with Tempur-Response® mattress. Temperature sensitive: may feel firmer in rooms 65° F or colder; will soften when occupied in response to body temperature. Use of electric blankets or heating pads is not recommended.</p>
 <p>NB Hammered Black Nickel Nail Head Trim</p>	<p>\$119</p>	<p>Adds hammered black nickel nail head trim. Nail head locations vary, reference style pages, under "Special Information: for details.</p>

OPTIONS	PRICING	SPECIAL INFO
 <p>NH Nail Head Trim - Brass</p>	<p>Nail Head Trim - Brass: \$119</p>	<p>Adds or designates brass nail head trim. Nail head locations vary, reference style pages, under "Special Information" for details.</p>
 <p>NS Nail Head Trim - Platinum</p>	<p>\$119</p>	<p>Adds platinum nail head trim. Nail head locations vary, reference style pages, under "Special Information" for details.</p>
 <p>P1 Contrasting Pillow(s)</p>	<p>\$0</p>	<p>Changes the cover on the accent pillow(s). Enter option code followed by the contrasting fabric number. Pillows are not available in LL, LS, LM, RL, BU or UE cap code covers.</p>
 <p>P2 Contrasting Pillow(s)</p>	<p>\$0</p>	<p>Changes the cover on the accent pillow(s). Enter option code followed by the contrasting fabric number. Pillows are not available in LL, LS, LM, RL, BU or UE cap code covers.</p>
 <p>RW Wireless Remote (Feature)</p>	<p>Recliners: \$0 Motion / Modulars: \$119</p>	<p>Designates that a unit features mounted cradle with wireless remote.</p>
 <p>SL Swivel Base - Power Recliners</p>	<p>\$139</p>	<p>Adds 145-degree swivel base on applicable power rocker recliner styles. Also adds 1 inch to seat height and overall height.</p>
 <p>SW Swivel Base - Manual Recliners</p>	<p>\$139</p>	<p>Adds 360-degree swivel base on applicable manual rocker recliner styles.</p>
 <p>W2 Dual Activation - Wireless Remotes</p>	<p>\$229</p>	<p>Replaces standard control panels with (2) mounted cradles with wireless remotes.</p>
 <p>Z6 ComfortCore® with Contour Cushion</p>	<p>Chair/Single Arm/Armless Middle: \$119 Sofa: \$339 Loveseat/Chaise/Cuddler/Corner: \$229</p>	<p>Upgrades standard ComfortCore® seat cushions to ComfortCore plus with Contour Cushion.</p>



General guidance, may not apply to all prefixes. Please refer to Product Info Guide for more detail by prefix.

ORDER FOB'S: 05, 06

BACKS: N/A

PILLOWS: N/A

STD FINISH: N/A

SEATS: N/A

OPT FINISHES: N/A

CAP CODES: DR, UR, DP, NP, PS, VS

FEATURES: Fiber fill

BATTERY: N/A

SPECIAL INFO: Shipped via UPS

SELECT FABRIC: N/A

SELECT FAUX LEATHER: N/A

SELECT LEATHER: N/A

CUSTOM PILLOWS	GRADE	SELECT			CUSTOM FABRIC				CUSTOM LEATHER / PLUS				AVAILABLE OPTIONS	DIMENSIONS			
		FAB	FAUX LTH	LTH	B-C	D-F, RE	G-N	P-Q	BL	DL	FL	HL		H	W	D	SF
01P202 (1) Box Border Kidney	COST	-	-	-	-	-	-	-	-	-	-	-	FP	12	21	-	-
	RESALE	-	-	-	69	69	69	69	-	-	-	-					
01P204 (1) Long Knife Edge Kidney	COST	-	-	-	-	-	-	-	-	-	-	-	FP	11	36	-	-
	RESALE	-	-	-	89	89	89	89	-	-	-	-					
01P203 (1) Long Box Border Kidney	COST	-	-	-	-	-	-	-	-	-	-	-	FP	12	26	-	-
	RESALE	-	-	-	79	79	79	79	-	-	-	-					
01P222 (1) 18" Knife Edge w/ Welt	COST	-	-	-	-	-	-	-	-	-	-	-	FP	18	18	-	-
	RESALE	-	-	-	69	69	69	69	-	-	-	-					
01P262 (1) 20" Knife Edge w/ Welt	COST	-	-	-	-	-	-	-	-	-	-	-	FP	20	20	-	-
	RESALE	-	-	-	79	79	79	79	-	-	-	-					
08P201 (1) Knife-Edge Kidney w/ Welt	COST	-	-	-	-	-	-	-	-	-	-	-	FP	12	23	-	-
	RESALE	-	-	-	59	59	59	59	-	-	-	-					
08P220 (2) 18" Knife Edge	COST	-	-	-	-	-	-	-	-	-	-	-	FP	18	18	-	-
	RESALE	-	-	-	89	89	89	89	-	-	-	-					
08P260 (2) 20" Knife Edge	COST	-	-	-	-	-	-	-	-	-	-	-	FP	20	20	-	-
	RESALE	-	-	-	99	99	99	99	-	-	-	-					
08P222 (2) 18" Knife Edge w/ Welt	COST	-	-	-	-	-	-	-	-	-	-	-	FP	18	18	-	-
	RESALE	-	-	-	109	109	109	109	-	-	-	-					
08P262 (2) 20" Knife Edge w/ Welt	COST	-	-	-	-	-	-	-	-	-	-	-	FP	20	20	-	-
	RESALE	-	-	-	119	119	119	119	-	-	-	-					



General guidance, may not apply to all prefixes. Please refer to Product Info Guide for more detail by prefix.

ORDER FOB'S: 05, 06
STD FINISH: N/A
OPT FINISHES: N/A
BATTERY: N/A
SPECIAL INFO: N/A
SELECT FABRIC: N/A

BACKS: N/A
SEATS: Box-border, lift-top, foam
CAP CODES: DR, UR, DP, NP, PS, UE, VS, BU, RL, LL

PILLOWS: N/A
FEATURES: Storage, (4) casters, welt trim on top and rails

SELECT FAUX LEATHER: N/A

SELECT LEATHER: N/A

205 CORY	GRADE	SELECT			CUSTOM FABRIC				CUSTOM LEATHER / PLUS				AVAILABLE OPTIONS	DIMENSIONS				
		FAB	FAUX LTH	LTH	B-C	D-F, RE	G-N	P-Q	BL	DL	FL	HL		H	W	D	RD	WT
		SH	SW	SD	AH	SF												
024205 Ottoman	COST	-	-	-	-	-	-	-	-	-	-	-	N/A	20	45	26	-	62
	RESALE	-	-	-	799	859	909	959	-	1249	1359	1459		-	-	-	-	0.5



General guidance, may not apply to all prefixes. Please refer to Product Info Guide for more detail by prefix.

ORDER FOB'S: 05, 06
STD FINISH: N/A
OPT FINISHES: N/A
BATTERY: N/A
SPECIAL INFO: N/A
SELECT FABRIC: N/A

BACKS: N/A
SEATS: Attached, button-tufted, foam
CAP CODES: DR, UR, DP, NP, PS, UE, VS, BU, RL, LL

PILLOWS: N/A
FEATURES: Hidden casters, welt trim on top

SELECT FAUX LEATHER: N/A

SELECT LEATHER: N/A

225 ROUNDABOUT	GRADE	SELECT			CUSTOM FABRIC				CUSTOM LEATHER / PLUS				AVAILABLE OPTIONS	DIMENSIONS				
		FAB	FAUX LTH	LTH	B-C	D-F, RE	G-N	P-Q	BL	DL	FL	HL		H	W	D	RD	WT
		SH	SW	SD	AH	SF												
024225 Ottoman	COST	-	-	-	-	-	-	-	-	-	-	-	N/A	18	35	35	-	26
	RESALE	-	-	-	449	499	559	609	-	809	919	1029		-	-	-	-	0.5

General guidance, may not apply to all prefixes. Please refer to Product Info Guide for more detail by prefix.



ORDER FOB'S: 05, 06
STD FINISH: N/A
OPT FINISHES: N/A
BATTERY: N/A
SPECIAL INFO: N/A
SELECT FABRIC: N/A

BACKS: N/A
SEATS: N/A
CAP CODES: DR, UR, DP, NP, PS, UE, VS, BU, RL, LL, LM

PILLOWS: N/A
FEATURES: Removable top. Storage, (4) casters.

SELECT FAUX LEATHER: N/A

SELECT LEATHER: N/A

301 OLIVER	GRADE	SELECT			CUSTOM FABRIC				CUSTOM LEATHER / PLUS				AVAILABLE OPTIONS	DIMENSIONS				
		FAB	FAUX LTH	LTH	B-C	D-F, RE	G-N	P-Q	BL	DL	FL	HL		H	W	D	RD	WT
		SH	SW	SD	AH	SF												
245301 Ottoman	COST	-	-	-	-	-	-	-	-	-	-	-	N/A	18	39.5	39.5	-	60
	RESALE	-	-	-	619	669	729	779	879	979	1089	1199		-	-	-	-	0.5

General guidance, may not apply to all prefixes. Please refer to Product Info Guide for more detail by prefix.

NEW!



ORDER FOB'S: 05, 06
STD FINISH: 067
OPT FINISHES: N/A
BATTERY: N/A
SPECIAL INFO: N/A
SELECT FABRIC: N/A

BACKS: N/A
SEATS: N/A
CAP CODES: DR, UR, DP, NP, PS, UE, VS, BU, RL, LL, LM

PILLOWS: N/A
FEATURES: Removable wood top, storage, hidden casters

SELECT FAUX LEATHER: N/A

SELECT LEATHER: N/A

304 SCOUT	GRADE	SELECT			CUSTOM FABRIC				CUSTOM LEATHER / PLUS				AVAILABLE OPTIONS	DIMENSIONS				
		FAB	FAUX LTH	LTH	B-C	D-F, RE	G-N	P-Q	BL	DL	FL	HL		H	W	D	RD	WT
		SH	SW	SD	AH	SF												
NEW! 245304 Ottoman	COST	-	-	-	-	-	-	-	-	-	-	-	N/A	18	22.5	22.5	-	39.5
	RESALE	-	-	-	339	399	449	499	529	629	739	839		-	-	-	-	0.5



General guidance, may not apply to all prefixes. Please refer to Product Info Guide for more detail by prefix.

ORDER FOB'S: 05, 06

BACKS: N/A

PILLOWS: N/A

STD FINISH: 007

SEATS: Reversible to button-tufted or table surface

OPT FINISHES: 021, 041, 071

CAP CODES: DR, UR, DP, NP, PS, UE, VS, BU, RL, LL

FEATURES: Storage, decorative wood legs, welt trim on upholstered top

BATTERY: N/A

SPECIAL INFO: N/A

SELECT FAUX LEATHER: N/A

SELECT LEATHER: N/A

SELECT FABRIC: N/A

30A LEO	GRADE	SELECT			CUSTOM FABRIC				CUSTOM LEATHER / PLUS				AVAILABLE OPTIONS	DIMENSIONS				
		FAB	FAUX LTH	LTH	B-C	D-F, RE	G-N	P-Q	BL	DL	FL	HL		H	W	D	RD	WT
		SH	SW	SD	AH	SF												
02430A Ottoman	COST	-	-	-	-	-	-	-	-	-	-	-	4C, FN	21.5	22.5	22.5	-	42
	RESALE	-	-	-	449	499	559	609	-	809	919	1029		-	-	-	-	0.5



General guidance, may not apply to all prefixes. Please refer to Product Info Guide for more detail by prefix.

ORDER FOB'S: 05, 06

BACKS: Tight, foam

PILLOWS: N/A

STD FINISH: 007

SEATS: Loose, box-border, Premier standard (SS)

OPT FINISHES: 021, 041, 071

CAP CODES: DR, UR, DP, NP, PS, UE, VS, BU, RL, LL, LM

FEATURES: Decorative wood legs or swivel base, welt trim

BATTERY: N/A

SPECIAL INFO: 041 and 071 finishes are ONLY available on 235/245 prefixes.

SELECT FAUX LEATHER: N/A

SELECT LEATHER: N/A

SELECT FABRIC: N/A

400 DORA	GRADE	SELECT			CUSTOM FABRIC				CUSTOM LEATHER / PLUS				AVAILABLE OPTIONS	DIMENSIONS				
		FAB	FAUX LTH	LTH	B-C	D-F, RE	G-N	P-Q	BL	DL	FL	HL		H	W	D	RD	WT
		SH	SW	SD	AH	SF												
225400 Swivel Gliding Chair	COST	-	-	-	-	-	-	-	-	-	-	-	DC, FN, Z6	41.5	34.5	38	-	106.5
	RESALE	-	-	-	899	1019	1129	1249	1289	1499	1719	1929		22	22	22	26	2
235400 Chair	COST	-	-	-	-	-	-	-	-	-	-	-	DC, FN, Z6	41.5	34.5	37.5	-	56.5
	RESALE	-	-	-	689	799	919	1039	1029	1239	1449	1659		22	22	22	26.5	2
245400 Ottoman	COST	-	-	-	-	-	-	-	-	-	-	-	FN	20	29	23.5	-	17.5
	RESALE	-	-	-	369	419	469	529	539	639	749	859		-	-	-	-	0.5



General guidance, may not apply to all prefixes. Please refer to Product Info Guide for more detail by prefix.

ORDER FOB'S: 05, 06

BACKS: Tight, foam

PILLOWS: N/A

STD FINISH: 021

SEATS: Loose, box-border, Premier standard (SS)

OPT FINISHES: 007, 041

CAP CODES: DR, UR, DP, NP, PS, UE, VS, BU, RL, LL

FEATURES: Decorative wood legs or swivel base, welt trim on arms and seat

BATTERY: N/A

SPECIAL INFO: 041 finish is ONLY available on 235/245 prefixes.

SELECT FABRIC: N/A

SELECT FAUX LEATHER: N/A

SELECT LEATHER: N/A

401 ALLEGRA	GRADE	SELECT			CUSTOM FABRIC				CUSTOM LEATHER / PLUS				AVAILABLE OPTIONS	DIMENSIONS				
		FAB	FAUX LTH	LTH	B-C	D-F, RE	G-N	P-Q	BL	DL	FL	HL		H	W	D	RD	WT
		SH	SW	SD	AH	SF												
225401 Swivel Gliding Chair	COST	-	-	-	-	-	-	-	-	-	-	-	DC, FN, Z6	36	34	35	-	96
	RESALE	-	-	-	899	1019	1129	1249	-	1589	1799	2019		21	20	20	27.5	2
235401 Chair	COST	-	-	-	-	-	-	-	-	-	-	-	DC, FN, Z6	35.5	34	34	-	43
	RESALE	-	-	-	739	859	969	1089	-	1379	1589	1799		20.5	20.5	20	27	2
245401 Ottoman	COST	-	-	-	-	-	-	-	-	-	-	-	FN	19	27.5	23	-	20
	RESALE	-	-	-	369	419	469	529	-	709	809	919		-	-	-	-	0.5



General guidance, may not apply to all prefixes. Please refer to Product Info Guide for more detail by prefix.

ORDER FOB'S: 05, 06

BACKS: Blown fiber, loose

PILLOWS: N/A

STD FINISH: 007

SEATS: Attached (SS)

OPT FINISHES: 021, 041, 071

CAP CODES: DR, UR, BU, RL, LL, LM

FEATURES: N/A

BATTERY: N/A

SPECIAL INFO: 041 and 071 finishes are ONLY available on 235 prefix.

SELECT FABRIC: N/A

SELECT FAUX LEATHER: N/A

SELECT LEATHER: N/A

402 MAEVE	GRADE	SELECT			CUSTOM FABRIC				CUSTOM LEATHER / PLUS				AVAILABLE OPTIONS	DIMENSIONS				
		FAB	FAUX LTH	LTH	B-C	D-F, RE	G-N	P-Q	BL	DL	FL	HL		H	W	D	RD	WT
		SH	SW	SD	AH	SF												
225402 Swivel Gliding Chair	COST	-	-	-	-	-	-	-	-	-	-	-	FN, Z6	35.5	31	40	-	102
	RESALE	-	-	-	959	1079	1199	1309	1299	1519	1729	1939		19.5	22.5	22	25.5	2
235402 Chair	COST	-	-	-	-	-	-	-	-	-	-	-	FN, Z6	37	31	40	-	71
	RESALE	-	-	-	739	859	969	1089	1029	1239	1449	1659		21	22.5	22	27	2
245402 Ottoman	COST	-	-	-	-	-	-	-	-	-	-	-	N/A	18	28	22	-	33
	RESALE	-	-	-	469	529	579	629	809	919	1029	1129		-	-	-	-	0.5



General guidance, may not apply to all prefixes. Please refer to Product Info Guide for more detail by prefix.

ORDER FOB'S: 05, 06 **BACKS:** Blown fiber **SWIVEL:** 088123, 088124, 088126, 08812T
STD FINISH: 007 **SEATS:** Standard (SS) **TALL:** 088210, 088266
OPT FINISHES: 021 **CAP CODES:** DR, UR, UE, BU, RL, LL, LM **FEATURES:** N/A
BATTERY: 088BP1
SPECIAL INFO: N/A
SELECT FABRIC: **SELECT FAUX LEATHER:** N/A **SELECT LEATHER:** N/A

B1538 Seamount
 C1860 Persia

403 VAIL	GRADE	SELECT			CUSTOM FABRIC				CUSTOM LEATHER / PLUS				AVAILABLE OPTIONS	DIMENSIONS				
		FAB	FAUX LTH	LTH	B-C	D-F, RE	G-N	P-Q	BL	DL	FL	HL		H	W	D	RD	WT
														SH	SW	SD	AH	SF
010403 Rocking Recliner	COST	-	-	-	-	-	-	-	-	-	-	-	ES, FN, FS, H1, H3, L1, L3, LE, LS, SW	40.5	32	36	13	62
	RESALE	579	-	-	699	809	929	1049	959	1169	1389	1599		18	17.5	19.5	23	1
P10403 Power Rocking Recliner	COST	-	-	-	-	-	-	-	-	-	-	-	FN, FS, HW, LT, SL	40.5	30	36	13	80
	RESALE	789	-	-	909	1029	1139	1259	1169	1389	1599	1809		18	17.5	19.5	23	1
016403 Wall Recliner	COST	-	-	-	-	-	-	-	-	-	-	-	ES, FN, FS, H1, H3, L1, L3, LE, LS	40.5	32	36	5	69
	RESALE	609	-	-	729	839	959	1079	989	1209	1419	1629		18	17.5	19.5	23	1
P16403 Power Wall Recliner	COST	-	-	-	-	-	-	-	-	-	-	-	FS, HW, LT	40.5	30	36	5	73
	RESALE	819	-	-	939	1059	1169	1289	1209	1419	1629	1839		18	17.5	19.5	23	1



General guidance, may not apply to all prefixes. Please refer to Product Info Guide for more detail by prefix.

ORDER FOB'S: 05, 06 **BACKS:** Semi-attached foam **PILLOWS:** N/A
STD FINISH: 007 **SEATS:** Attached box-border (SS)
OPT FINISHES: 021, 041, 071 **CAP CODES:** DR, UR, DP, NP, PS, UE, VS, BU, RL, LL, LM **FEATURES:** Decorative wood legs
BATTERY: 088BP1
SPECIAL INFO: N/A
SELECT FABRIC: N/A **SELECT FAUX LEATHER:** N/A **SELECT LEATHER:** N/A

405 DANTE	GRADE	SELECT			CUSTOM FABRIC				CUSTOM LEATHER / PLUS				AVAILABLE OPTIONS	DIMENSIONS				
		FAB	FAUX LTH	LTH	B-C	D-F, RE	G-N	P-Q	BL	DL	FL	HL		H	W	D	RD	WT
														SH	SW	SD	AH	SF
295405 High Leg Reclining Chair	COST	-	-	-	-	-	-	-	-	-	-	-	FN, FS	43	29.5	43	-	105
	RESALE	-	-	-	1059	1169	1289	1409	1519	1729	1939	2149		21.5	21	21	24.5	1
29U405 High Leg Power Recliner w/ Headrest	COST	-	-	-	-	-	-	-	-	-	-	-	FN, FS, LW	43	29.5	43	-	115
	RESALE	-	-	-	1479	1599	1719	1829	1939	2149	2369	2579		21.5	21	21	24.5	1



General guidance, may not apply to all prefixes. Please refer to Product Info Guide for more detail by prefix.

ORDER FOB'S: 05, 06

STD FINISH: 007

OPT FINISHES: 021, 041, 071

BATTERY: N/A

SPECIAL INFO: N/A

SELECT FABRIC: N/A

BACKS: Tight, button-tufted foam

SEATS: Loose, box-border foam (SS)

CAP CODES: DR, UR, UE, BU, RL, LL, LM

SELECT FAUX LEATHER: N/A

PILLOWS: N/A

FEATURES: Decorative wood legs, welt trim on outside back and arms

SELECT LEATHER: N/A

406 GEMMA	GRADE	SELECT			CUSTOM FABRIC				CUSTOM LEATHER / PLUS				AVAILABLE OPTIONS	DIMENSIONS				
		FAB	FAUX LTH	LTH	B-C	D-F, RE	G-N	P-Q	BL	DL	FL	HL		H	W	D	RD	WT
		SH	SW	SD	AH	SF												
235406 Chair	COST	-	-	-	-	-	-	-	-	-	-	-	FN, Z6	38.5	29.5	33.5	-	47
	RESALE	-	-	-	689	799	919	1039	1029	1239	1449	1659		20.5	20	21.5	24	1



General guidance, may not apply to all prefixes. Please refer to Product Info Guide for more detail by prefix.

ORDER FOB'S: 05, 06

STD FINISH: 007

OPT FINISHES: 021, 041, 071

BATTERY: N/A

SPECIAL INFO: N/A

SELECT FABRIC: N/A

BACKS: Semi-attached, chambered blown fiber

SEATS: Attached, foam box-border (SS)

CAP CODES: DR, UR, DP, NP, PS, UE, VS, BU, RL, LL

SELECT FAUX LEATHER: N/A

PILLOWS: N/A

FEATURES: Decorative wood base and legs, padded outside arms and back, welt trim on arms and seat

SELECT LEATHER: N/A

408 FERNDALE	GRADE	SELECT			CUSTOM FABRIC				CUSTOM LEATHER / PLUS				AVAILABLE OPTIONS	DIMENSIONS				
		FAB	FAUX LTH	LTH	B-C	D-F, RE	G-N	P-Q	BL	DL	FL	HL		H	W	D	RD	WT
		SH	SW	SD	AH	SF												
265408 Reclining Chair	COST	-	-	-	-	-	-	-	-	-	-	-	FN, FS	40	32	34.5	10	54
	RESALE	-	-	-	889	999	1119	1239	-	1429	1639	1859		20	20.5	20	26.5	1
245408 Ottoman	COST	-	-	-	-	-	-	-	-	-	-	-	FN	18	25	22	-	19
	RESALE	-	-	-	459	519	569	619	-	739	839	949		-	-	-	-	0.5



General guidance, may not apply to all prefixes. Please refer to Product Info Guide for more detail by prefix.

ORDER FOB'S: 05, 06

BACKS: Semi-attached, chambered blown fiber **PILLOWS:** N/A

STD FINISH: 007

SEATS: Loose box-border, Premier standard (SS)

OPT FINISHES: 021

CAP CODES: DR, UR, DP, NP, PS, UE, VS, BU, **FEATURES:** Swivel base, padded outside arms and back, welt trim on arms and seat

BATTERY: N/A

SPECIAL INFO: N/A

SELECT FABRIC: N/A

SELECT FAUX LEATHER: N/A

SELECT LEATHER: N/A

408 FERNDALE SWIVEL	GRADE	SELECT			CUSTOM FABRIC				CUSTOM LEATHER / PLUS				AVAILABLE OPTIONS	DIMENSIONS				
		FAB	FAUX LTH	LTH	B-C	D-F, RE	G-N	P-Q	BL	DL	FL	HL		H	W	D	RD	WT
		SH	SW	SD	AH	SF												
225408 Swivel Gliding Chair	COST	-	-	-	-	-	-	-	-	-	-	-	DC, FN, Z6	39	35	37	-	104.5
	RESALE	-	-	-	959	1079	1199	1309	-	1639	1859	2069		21	22	20.5	25.5	2

DISC!



General guidance, may not apply to all prefixes. Please refer to Product Info Guide for more detail by prefix.

ORDER FOB'S: 05, 06

BACKS: Semi-attached, button-tufted, blown fiber **PILLOWS:** 18" knife-edge w/ welt (P1)

STD FINISH: 021

SEATS: Loose, box-border, Premier standard (SS)

OPT FINISHES: 007, 041

CAP CODES: DR, UR **FEATURES:** Decorative wood legs, welt trim on arm posts, seats, and backs

BATTERY: N/A

SPECIAL INFO: N/A

SELECT FABRIC:

SELECT FAUX LEATHER: N/A

SELECT LEATHER: N/A

C1659 McKittrick
C2042 Duffey

411 LAUREL	GRADE	SELECT			CUSTOM FABRIC				CUSTOM LEATHER / PLUS				AVAILABLE OPTIONS	DIMENSIONS				
		FAB	FAUX LTH	LTH	B-C	D-F, RE	G-N	P-Q	BL	DL	FL	HL		H	W	D	RD	WT
		SH	SW	SD	AH	SF												
DISC! 610411 Sofa	COST	-	-	-	-	-	-	-	-	-	-	-	DC, FN, FP, P1, Z6	39	80	38	-	119
	RESALE	1249	-	-	1409	1569	1729	1889	-	-	-	-		22	65	21	27	3
DISC! 655411 Chair & a Half	COST	-	-	-	-	-	-	-	-	-	-	-	DC, FN, FP, P1, Z6	39	52	38	-	87
	RESALE	1089	-	-	1209	1319	1439	1559	-	-	-	-		22	37	21	27	2
DISC! 240411 Ottoman	COST	-	-	-	-	-	-	-	-	-	-	-	FN	19	41	23.5	-	27
	RESALE	459	-	-	519	569	619	669	-	-	-	-		-	-	-	-	-

NEW!



General guidance, may not apply to all prefixes. Please refer to Product Info Guide for more detail by prefix.

ORDER FOB'S: 05, 06

STD FINISH: 007

OPT FINISHES: 021, 041

BATTERY: N/A

SPECIAL INFO: N/A

SELECT FABRIC: N/A

BACKS: Tight, foam

SEATS: Attached box-border (SS)

CAP CODES: DR, UR, UE, BU, RL, LL, LM

SELECT FAUX LEATHER: N/A

PILLOWS: N/A

FEATURES: Decorative wood legs

SELECT LEATHER: N/A

416 RAE	GRADE	SELECT			CUSTOM FABRIC				CUSTOM LEATHER / PLUS				AVAILABLE OPTIONS	DIMENSIONS				
		FAB	FAUX LTH	LTH	B-C	D-F, RE	G-N	P-Q	BL	DL	FL	HL		H	W	D	RD	WT
		SH	SW	SD	AH	SF												
NEW! 028416 High Leg Reclining Chair	COST	-	-	-	-	-	-	-	-	-	-	-	FN, FS	42.5	30.5	36.5	12	73
RESALE	-	-	-	739	859	969	1089	1209	1419	1629	1839	20		20	21	26	1	

General guidance, may not apply to all prefixes. Please refer to Product Info Guide for more detail by prefix.

ORDER FOB'S: 05, 06

STD FINISH: N/A

OPT FINISHES: N/A

BATTERY: N/A

SPECIAL INFO: Due to arm design, fabric patterns with a distinct up direction may appear "upside down" on the outside of the unit. The following covers are restricted from this style due to this issue: C1670 Northern Exposure

SELECT FABRIC:

B1808 Social Club
D2116 Rome

BACKS: Semi-attached, blown fiber

SEATS: Loose, box-border, Premier standard (SS)

CAP CODES: DR, UR, DP, NP, PS, UE, VS, BU, RL

SELECT FAUX LEATHER: N/A

PILLOWS: 18" knife-edge w/ welt (P1)

FEATURES: SUPREME-COMFORT™ mattress, welt trim on back, arms posts, seat, and front rail

SELECT LEATHER: N/A



418 LEAH	GRADE	SELECT			CUSTOM FABRIC				CUSTOM LEATHER / PLUS				AVAILABLE OPTIONS	DIMENSIONS				
		FAB	FAUX LTH	LTH	B-C	D-F, RE	G-N	P-Q	BL	DL	FL	HL		H	W	D	RD	WT
		SH	SW	SD	AH	SF												
510418 Queen Sleep Sofa	COST	-	-	-	-	-	-	-	-	-	-	-	DC, FP, MA, MT, P1, Z6	38	82	38.5	-	175
	RESALE	1829	-	-	1989	2149	2309	2469	-	-	-	-		21	68.5	20.5	27.5	3
520418 Full Sleep Sofa	COST	-	-	-	-	-	-	-	-	-	-	-	DC, FP, MA, MT, P1, Z6	38	73.5	38.5	-	161
	RESALE	1729	-	-	1889	2049	2209	2369	-	-	-	-		21	60.5	20.5	27.5	3
555418 Twin Sleep Chair	COST	-	-	-	-	-	-	-	-	-	-	-	DC, FP, MA, MT, P1, Z6	38	54	38.5	-	124
	RESALE	1619	-	-	1739	1859	1969	2089	-	-	-	-		21	40	20.5	27.5	2



General guidance, may not apply to all prefixes. Please refer to Product Info Guide for more detail by prefix.

ORDER FOB'S: 05, 06

STD FINISH: 007

OPT FINISHES: 021, 041, 071

BATTERY: N/A

SPECIAL INFO: N/A

SELECT FABRIC: N/A

BACKS: Tight, foam

SEATS: Loose (non-reversible), box-border, Premier standard (SS)

CAP CODES: DR, UR, DP, NP, PS, UE, VS, BU, RL

SELECT FAUX LEATHER: N/A

PILLOWS: N/A

FEATURES: Swivel base, decorative wood legs, welt trim on arms and seat

SELECT LEATHER: N/A

421 BELLEVUE	GRADE	SELECT			CUSTOM FABRIC				CUSTOM LEATHER / PLUS				AVAILABLE OPTIONS	DIMENSIONS				
		FAB	FAUX LTH	LTH	B-C	D-F, RE	G-N	P-Q	BL	DL	FL	HL		H	W	D	RD	WT
		SH	SW	SD	AH	SF												
210421 High Leg Swivel Chair	COST	-	-	-	-	-	-	-	-	-	-	-	DC, FN, Z6	37	33	36	-	68
RESALE	-	-	-	829	949	1069	1189	-	-	-	-	22		23.5	20	26	1	



General guidance, may not apply to all prefixes. Please refer to Product Info Guide for more detail by prefix.

ORDER FOB'S: 05, 06

STD FINISH: 142

OPT FINISHES: 021

BATTERY: N/A

SPECIAL INFO: N/A

SELECT FABRIC: N/A

BACKS: Attached, blown fiber

SEATS: Chaise (SS)

CAP CODES: DR, UR, DP, NP, PS, UE, VS, BU, RL, LL, LM

SELECT FAUX LEATHER: N/A

PILLOWS: N/A

FEATURES: Decorative wood arms and legs, welt trim on back borders

SELECT LEATHER: N/A

423 ELDORADO	GRADE	SELECT			CUSTOM FABRIC				CUSTOM LEATHER / PLUS				AVAILABLE OPTIONS	DIMENSIONS				
		FAB	FAUX LTH	LTH	B-C	D-F, RE	G-N	P-Q	BL	DL	FL	HL		H	W	D	RD	WT
		SH	SW	SD	AH	SF												
295423 High Leg Reclining Chair	COST	-	-	-	-	-	-	-	-	-	-	-	FN, FS	42	32.5	41	17	83
RESALE	-	-	-	1419	1539	1649	1769	1759	1969	2189	2399	20.5		20.5	20.5	25.5	1	

DISC!



General guidance, may not apply to all prefixes. Please refer to Product Info Guide for more detail by prefix.

ORDER FOB'S: 05, 06

STD FINISH: 007

OPT FINISHES: 021

BATTERY: N/A

SPECIAL INFO: N/A

SELECT FABRIC: N/A

BACKS: Tight, foam

SEATS: Attached, bullnose (SS)

CAP CODES: DR, UR, DP, NP, PS, UE, VS, BU, RL, LL

SELECT FAUX LEATHER: N/A

PILLOWS: N/A

FEATURES: Decorative wood legs, welt trim on back and arm posts

SELECT LEATHER: N/A

424 FLETCHER	GRADE	SELECT			CUSTOM FABRIC				CUSTOM LEATHER / PLUS				AVAILABLE OPTIONS	DIMENSIONS				
		FAB	FAUX LTH	LTH	B-C	D-F, RE	G-N	P-Q	BL	DL	FL	HL		H	W	D	RD	WT
		SH	SW	SD	AH	SF												
DISC! 295424 High Leg Reclining Chair	COST	-	-	-	-	-	-	-	-	-	-	-	FN, FS	40	35.5	36.5	15	89
	RESALE	-	-	-	939	1059	1169	1289	-	1649	1869	2079		19.5	21	20	26	1



General guidance, may not apply to all prefixes. Please refer to Product Info Guide for more detail by prefix.

ORDER FOB'S: 05, 06

STD FINISH: 007

OPT FINISHES: 021

BATTERY: N/A

SPECIAL INFO: N/A

SELECT FABRIC: N/A

BACKS: Chambered, semi-attached

SEATS: Premier standard (SS)

CAP CODES: DR, UR, UE, BU, RL

SELECT FAUX LEATHER: N/A

PILLOWS: N/A

FEATURES: N/A

SELECT LEATHER: N/A

425 ALMA	GRADE	SELECT			CUSTOM FABRIC				CUSTOM LEATHER / PLUS				AVAILABLE OPTIONS	DIMENSIONS				
		FAB	FAUX LTH	LTH	B-C	D-F, RE	G-N	P-Q	BL	DL	FL	HL		H	W	D	RD	WT
		SH	SW	SD	AH	SF												
225425 Swivel Gliding Chair	COST	-	-	-	-	-	-	-	-	-	-	-	DC, FN, Z6	36	32	37.5	-	105.5
	RESALE	-	-	-	939	1059	1169	1289	-	-	-	-		20	21.5	20	25.5	1



General guidance, may not apply to all prefixes. Please refer to Product Info Guide for more detail by prefix.

ORDER FOB'S: 05, 06

BACKS: Tight, tufted, semi-attached headrest, foam

PILLOWS: N/A

STD FINISH: 007

SEATS: Attached, box-border (SS)

OPT FINISHES: 021, 041, 071

CAP CODES: DR, UR, UE, BU, RL, LL, LM

FEATURES: Decorative wood legs, welt trim on wings, arms and seat

BATTERY: 088BP1

SPECIAL INFO: Ordering LG option changes the leg from the standard conical leg to a square tapered leg.

SELECT FABRIC: N/A

SELECT FAUX LEATHER: N/A

SELECT LEATHER: N/A

430 BRENTWOOD	GRADE	SELECT			CUSTOM FABRIC				CUSTOM LEATHER / PLUS				AVAILABLE OPTIONS	DIMENSIONS				
		FAB	FAUX LTH	LTH	B-C	D-F, RE	G-N	P-Q	BL	DL	FL	HL		H	W	D	RD	WT
		SH	SW	SD	AH	SF												
295430 High Leg Reclining Chair	COST	-	-	-	-	-	-	-	-	-	-	-	FN, FS, LG	43.5	33.5	35	16	82
	RESALE	-	-	-	1119	1239	1359	1469	1709	1919	2129	2339		21	22.5	20.5	25.5	1
29U430 High Leg Power Recliner w/ Headrest	COST	-	-	-	-	-	-	-	-	-	-	-	FN, FS, LG, LW	43.5	33.5	35	16	107.5
	RESALE	-	-	-	1549	1659	1779	1899	2129	2339	2559	2769		21	22.5	20.5	25.5	1



General guidance, may not apply to all prefixes. Please refer to Product Info Guide for more detail by prefix.

ORDER FOB'S: 05, 06

BACKS: Tight, foam

PILLOWS: N/A

STD FINISH: 007

SEATS: Attached, box-border (SS)

OPT FINISHES: 021, 041

CAP CODES: DR, UR, DP, NP, PS, UE, VS, BU, RL, LL, LM

FEATURES: Decorative wood legs

BATTERY: N/A

SPECIAL INFO: N/A

SELECT FABRIC: N/A

SELECT FAUX LEATHER: N/A

SELECT LEATHER: N/A

431 SCARLETT	GRADE	SELECT			CUSTOM FABRIC				CUSTOM LEATHER / PLUS				AVAILABLE OPTIONS	DIMENSIONS				
		FAB	FAUX LTH	LTH	B-C	D-F, RE	G-N	P-Q	BL	DL	FL	HL		H	W	D	RD	WT
		SH	SW	SD	AH	SF												
028431 High Leg Reclining Chair	COST	-	-	-	-	-	-	-	-	-	-	-	FN, FS	39	33	37	12	67
	RESALE	-	-	-	689	799	919	1039	1149	1369	1579	1789		19.5	21	21	26	1



General guidance, may not apply to all prefixes. Please refer to Product Info Guide for more detail by prefix.

ORDER FOB'S: 05, 06

BACKS: Tight, foam

PILLOWS: (2) 20" knife-edge (P1)

STD FINISH: 007

SEATS: Loose, box-border, Premier standard (SS)

OPT FINISHES: 021

CAP CODES: DR, UR, DP, NP, PS, UE, VS, BU, RL, LL, LM

FEATURES: Decorative wood legs, welt trim on backs, seats, arm posts, and front rail

BATTERY: N/A

SPECIAL INFO: N/A

SELECT FAUX LEATHER: N/A

SELECT LEATHER:

C1757 Bartaloni
C2121 Watari

LB2060 Sutton - 32, 54, 77, 87

435 MACKENZIE	GRADE	SELECT			CUSTOM FABRIC				CUSTOM LEATHER / PLUS				AVAILABLE OPTIONS	DIMENSIONS				
		FAB	FAUX LTH	LTH	B-C	D-F, RE	G-N	P-Q	BL	DL	FL	HL		H	W	D	RD	WT
		SH	SW	SD	AH	SF												
610435 Sofa	COST	-	-	-	-	-	-	-	-	-	-	-	DC, FN, FP, P1, Z6	36.5	87	38	-	123
	RESALE	1579	-	2279	1739	1899	2059	2219	2599	3129	3659	4199		22	67	22	26	3
510435 Queen Sleep Sofa	COST	-	-	-	-	-	-	-	-	-	-	-	DC, FN, FP, MA, MT, P1, Z6	36.5	87	38	-	193
	RESALE	2059	-	2759	2219	2379	2539	2699	3079	3609	4139	4669		22	67	22	26	3
630435 Loveseat	COST	-	-	-	-	-	-	-	-	-	-	-	DC, FN, FP, P1, Z6	36.5	64	38	-	100
	RESALE	1539	-	2239	1699	1859	2019	2169	2559	3089	3619	4149		22	45	22	26	2
230435 Chair	COST	-	-	-	-	-	-	-	-	-	-	-	DC, FN, Z6	37.5	42	37	-	72
	RESALE	949	-	1399	1069	1189	1299	1419	1499	1719	1929	2139		21	22	21	26	2
240435 Ottoman	COST	-	-	-	-	-	-	-	-	-	-	-	N/A	19.5	32	24	-	30
	RESALE	549	-	779	599	649	709	759	829	939	1049	1149		-	-	-	-	0.5



General guidance, may not apply to all prefixes. Please refer to Product Info Guide for more detail by prefix.

ORDER FOB'S: 05, 06

BACKS: Semi-attached, foam

PILLOWS: N/A

STD FINISH: 007

SEATS: Attached, box-border (SS)

OPT FINISHES: 021

CAP CODES: DR, UR, DP, NP, PS, UE, VS, BU, RL, LL, LM

FEATURES: Decorative wood legs, welt trim on the back, arm posts, seat, and footrest

BATTERY: N/A

SPECIAL INFO: Due to arm design, fabric patterns with a distinct up direction may appear "upside down" on the outside of the unit. The following covers are restricted from this style due to this issue: C1670 Northern Exposure

SELECT FABRIC: N/A

SELECT FAUX LEATHER: N/A

SELECT LEATHER: N/A

448 RILEY	GRADE	SELECT			CUSTOM FABRIC				CUSTOM LEATHER / PLUS				AVAILABLE OPTIONS	DIMENSIONS				
		FAB	FAUX LTH	LTH	B-C	D-F, RE	G-N	P-Q	BL	DL	FL	HL		H	W	D	RD	WT
		SH	SW	SD	AH	SF												
295448 High Leg Reclining Chair	COST	-	-	-	-	-	-	-	-	-	-	-	FN, FS	41	35.5	37	14	78
	RESALE	-	-	-	1059	1169	1289	1409	1709	1919	2129	2339		21	22.5	19	26	1



General guidance, may not apply to all prefixes. Please refer to Product Info Guide for more detail by prefix.

ORDER FOB'S: 05, 06
STD FINISH: 007
OPT FINISHES: 021, 041
BATTERY: N/A
SPECIAL INFO: N/A
SELECT FABRIC: N/A

BACKS: Tight, foam
SEATS: Attached, box-border (SS)
CAP CODES: DR, UR, DP, NP, PS, UE, VS, BU, RL, LL

PILLOWS: N/A
FEATURES: Decorative wood legs, welt trim on back, arm posts, and seat

SELECT FAUX LEATHER: N/A

SELECT LEATHER: N/A

450 HAVEN	GRADE	SELECT			CUSTOM FABRIC				CUSTOM LEATHER / PLUS				AVAILABLE OPTIONS	DIMENSIONS				
		FAB	FAUX LTH	LTH	B-C	D-F, RE	G-N	P-Q	BL	DL	FL	HL		H	W	D	RD	WT
		SH	SW	SD	AH	SF												
028450 High Leg Reclining Chair	COST	-	-	-	-	-	-	-	-	-	-	-	FN, FS	40	35	37	12	76
	RESALE	-	-	-	829	949	1069	1189	-	1539	1749	1959		19.5	21.5	21	25.5	1



General guidance, may not apply to all prefixes. Please refer to Product Info Guide for more detail by prefix.

ORDER FOB'S: 05, 06
STD FINISH: N/A
OPT FINISHES: N/A
BATTERY: N/A
SPECIAL INFO: Back cushion is not flippable due to its contoured design
SELECT FABRIC: N/A

BACKS: Loose, chambered blown fiber
SEATS: Loose, box-border Premier standard (SS)
CAP CODES: DR, UR, UE, BU, RL, LL, LM

PILLOWS: (2) 18" knife-edge w/ welt (P1)
FEATURES: Swivel base

SELECT FAUX LEATHER: N/A

SELECT LEATHER: N/A

456 OPAL	GRADE	SELECT			CUSTOM FABRIC				CUSTOM LEATHER / PLUS				AVAILABLE OPTIONS	DIMENSIONS				
		FAB	FAUX LTH	LTH	B-C	D-F, RE	G-N	P-Q	BL	DL	FL	HL		H	W	D	RD	WT
		SH	SW	SD	AH	SF												
215456 Swivel Chair	COST	-	-	-	-	-	-	-	-	-	-	-	DC, FP, P1, Z6	34.5	51	52	-	112
	RESALE	-	-	-	1119	1239	1359	1469	1739	1949	2159	2379		21	40	31	24.5	2



General guidance, may not apply to all prefixes. Please refer to Product Info Guide for more detail by prefix.

ORDER FOB'S: 05, 06

BACKS: Semi-attached, box-border, chambered blown fiber

PILLOWS: N/A

STD FINISH: 007

SEATS: Attached, box-border (SS)

OPT FINISHES: 021, 041, 071

CAP CODES: DR, UR, DP, NP, PS, UE, VS, BU, RL, LL, LM

FEATURES: Decorative wood legs.

BATTERY: 088BP1

SPECIAL INFO: N/A

SELECT FABRIC: N/A

SELECT FAUX LEATHER: N/A

SELECT LEATHER: N/A

457 AUDREY	GRADE	SELECT			CUSTOM FABRIC				CUSTOM LEATHER / PLUS				AVAILABLE OPTIONS	DIMENSIONS				
		FAB	FAUX LTH	LTH	B-C	D-F, RE	G-N	P-Q	BL	DL	FL	HL		H	W	D	RD	WT
		SH	SW	SD	AH	SF												
295457 High Leg Reclining Chair	COST	-	-	-	-	-	-	-	-	-	-	-	FN, FS	42	31.5	38.5	17	88
	RESALE	-	-	-	1019	1129	1249	1369	1449	1659	1879	2089		21	22	20.5	25.5	1
29U457 High Leg Power Recliner w/ Headrest	COST	-	-	-	-	-	-	-	-	-	-	-	FN, FS, LW	42	31.5	38.5	17	116
	RESALE	-	-	-	1439	1559	1669	1789	1879	2089	2299	2519		21	22	20.5	25.5	2



General guidance, may not apply to all prefixes. Please refer to Product Info Guide for more detail by prefix.

ORDER FOB'S: 05, 06

BACKS: Attached, foam

PILLOWS: N/A

STD FINISH: 007

SEATS: Attached, box-border (SS)

OPT FINISHES: 021, 041

CAP CODES: DR, UR, DP, NP, PS, UE, VS, BU, RL, LL, LM

FEATURES: Decorative wood legs, welt trim on the wings and arms.

BATTERY: 088BP1

SPECIAL INFO: N/A

SELECT FABRIC: N/A

SELECT FAUX LEATHER: N/A

SELECT LEATHER: N/A

458 RHEEVES	GRADE	SELECT			CUSTOM FABRIC				CUSTOM LEATHER / PLUS				AVAILABLE OPTIONS	DIMENSIONS				
		FAB	FAUX LTH	LTH	B-C	D-F, RE	G-N	P-Q	BL	DL	FL	HL		H	W	D	RD	WT
		SH	SW	SD	AH	SF												
295458 High Leg Reclining Chair	COST	-	-	-	-	-	-	-	-	-	-	-	FN, FS	43	33.5	36	18	91.5
	RESALE	-	-	-	1019	1129	1249	1369	1449	1659	1879	2089		21.5	21.5	20.5	26	1
29U458 High Leg Power Recliner w/ Headrest	COST	-	-	-	-	-	-	-	-	-	-	-	FN, FS, LW	43	33.5	36	18	114.5
	RESALE	-	-	-	1439	1559	1669	1789	1879	2089	2299	2519		21.5	21.5	20.5	26	2



General guidance, may not apply to all prefixes. Please refer to Product Info Guide for more detail by prefix.

ORDER FOB'S: 05, 06

BACKS: Semi-attached, blown fiber

PILLOWS: N/A

STD FINISH: 007

SEATS: Loose, box-border, Premier standard (SS)

OPT FINISHES: 021, 041, 071

CAP CODES: DR, UR, DP, NP, PS, UE, VS, BU, RL, LL

FEATURES: Swivel base, decorative wood legs, welt trim on back, arms, and seat

BATTERY: N/A

SPECIAL INFO: N/A

SELECT FABRIC: N/A

SELECT FAUX LEATHER: N/A

SELECT LEATHER: N/A

460 REEGAN	GRADE	SELECT			CUSTOM FABRIC				CUSTOM LEATHER / PLUS				AVAILABLE OPTIONS	DIMENSIONS				
		FAB	FAUX LTH	LTH	B-C	D-F, RE	G-N	P-Q	BL	DL	FL	HL		H	W	D	RD	WT
		SH	SW	SD	AH	SF												
210460 High Leg Swivel Chair	COST	-	-	-	-	-	-	-	-	-	-	-	DC, FN, Z6	36.5	30	35	-	73
RESALE	-	-	-	829	949	1069	1189	-	1469	1689	1899	21.5		21	19.5	25.5	1	



General guidance, may not apply to all prefixes. Please refer to Product Info Guide for more detail by prefix.

ORDER FOB'S: 05, 06

BACKS: Semi-attached, blown fiber

PILLOWS: N/A

STD FINISH: 007

SEATS: Loose, box-border, Premier standard (SS)

OPT FINISHES: 021

CAP CODES: DR, UR, DP, NP, PS, UE, VS, BU, RL

FEATURES: Swivel base, welt trim on back, arms, seat, and front rail

BATTERY: N/A

SPECIAL INFO: N/A

SELECT FABRIC: N/A

SELECT FAUX LEATHER: N/A

SELECT LEATHER: N/A

462 ROXIE	GRADE	SELECT			CUSTOM FABRIC				CUSTOM LEATHER / PLUS				AVAILABLE OPTIONS	DIMENSIONS				
		FAB	FAUX LTH	LTH	B-C	D-F, RE	G-N	P-Q	BL	DL	FL	HL		H	W	D	RD	WT
		SH	SW	SD	AH	SF												
225462 Swivel Gliding Chair	COST	-	-	-	-	-	-	-	-	-	-	-	DC, FN, Z6	37	37	37	-	108
RESALE	-	-	-	1059	1169	1289	1409	-	-	-	-	20.5		22	21	25	2	



General guidance, may not apply to all prefixes. Please refer to Product Info Guide for more detail by prefix.

ORDER FOB'S: 05, 06

BACKS: Semi-attached, foam

PILLOWS: N/A

STD FINISH: 007

SEATS: Attached, box-border (SS)

OPT FINISHES: 021

CAP CODES: DR, UR, DP, NP, PS, UE, VS, BU, RL, LL, LM

FEATURES: Decorative wood legs, welt trim on wings, backs, arm posts, and seat

BATTERY: 088BP1

SPECIAL INFO: Ordering NB, NH, or NS option adds small nails to the wings and arm posts.

SELECT FABRIC: N/A

SELECT FAUX LEATHER: N/A

SELECT LEATHER: N/A

471 CARLETON	GRADE	SELECT			CUSTOM FABRIC				CUSTOM LEATHER / PLUS				AVAILABLE OPTIONS	DIMENSIONS				
		FAB	FAUX LTH	LTH	B-C	D-F, RE	G-N	P-Q	BL	DL	FL	HL		H	W	D	RD	WT
		SH	SW	SD	AH	SF												
295471 High Leg Reclining Chair	COST	-	-	-	-	-	-	-	-	-	-	-	FN, FS, NB, NH, NS	42	36	39	16.5	90
	RESALE	-	-	-	1119	1239	1359	1469	1869	2079	2289	2499		20	22	20.5	25	1
29U471 High Leg Power Recliner w/ Headrest	COST	-	-	-	-	-	-	-	-	-	-	-	FN, FS, LW, NB, NH, NS	42	36	39	16.5	118
	RESALE	-	-	-	1549	1659	1779	1899	2289	2499	2719	2929		20	22	20.5	25	1



General guidance, may not apply to all prefixes. Please refer to Product Info Guide for more detail by prefix.

ORDER FOB'S: 05, 06

BACKS: Tight, foam

PILLOWS: N/A

STD FINISH: 007

SEATS: Loose, box-border, Premier standard (SS)

OPT FINISHES: 021

CAP CODES: DR, UR, DP, NP, PS, VS, LL

FEATURES: Swivel base, welt trim on back, arms, and seat

BATTERY: N/A

SPECIAL INFO: N/A

SELECT FABRIC: N/A

SELECT FAUX LEATHER: N/A

SELECT LEATHER: N/A

479 MIDTOWN	GRADE	SELECT			CUSTOM FABRIC				CUSTOM LEATHER / PLUS				AVAILABLE OPTIONS	DIMENSIONS				
		FAB	FAUX LTH	LTH	B-C	D-F, RE	G-N	P-Q	BL	DL	FL	HL		H	W	D	RD	WT
		SH	SW	SD	AH	SF												
225479 Swivel Gliding Chair	COST	-	-	-	-	-	-	-	-	-	-	-	DC, FN, Z6	40	32	36	-	104
	RESALE	-	-	-	1059	1169	1289	1409	-	1609	1819	2039		20.5	21.5	21	27	2

DISC!



General guidance, may not apply to all prefixes. Please refer to Product Info Guide for more detail by prefix.

ORDER FOB'S: 05, 06

BACKS: Semi-attached, blown fiber

PILLOWS: (2) 18" knife-edge w/ welt (P1)

STD FINISH: 007

SEATS: Loose, box-border, Premier standard (SS)

OPT FINISHES: 021, 041, 071

CAP CODES: DR, UR

FEATURES: Decorative wood legs, welt trim on arm posts

BATTERY: N/A

SPECIAL INFO: N/A

SELECT FAUX LEATHER: N/A

SELECT LEATHER: N/A

SELECT FABRIC:

C1812 Damon

491 NATALIE	GRADE	SELECT			CUSTOM FABRIC				CUSTOM LEATHER / PLUS				AVAILABLE OPTIONS	DIMENSIONS				
		FAB	FAUX LTH	LTH	B-C	D-F, RE	G-N	P-Q	BL	DL	FL	HL		H	W	D	RD	WT
		SH	SW	SD	AH	SF												
DISC! 610491 Sofa	COST	-	-	-	-	-	-	-	-	-	-	-	DC, FN, FP, P1, Z6	39	86	38	-	135
	RESALE	1309	-	-	1469	1629	1789	1949	-	-	-	-		21.5	68	20	27	3
DISC! 510491 Queen Sleep Sofa	COST	-	-	-	-	-	-	-	-	-	-	-	DC, FN, FP, MA, MT, P1, Z6	39	86	38	-	200
	RESALE	1789	-	-	1949	2109	2269	2429	-	-	-	-		21.5	68	20	27	3
DISC! 630491 Loveseat	COST	-	-	-	-	-	-	-	-	-	-	-	DC, FN, FP, P1, Z6	39	63.5	38	-	118
	RESALE	1269	-	-	1429	1589	1749	1909	-	-	-	-		21.5	45.5	20	27	2
DISC! 230491 Chair	COST	-	-	-	-	-	-	-	-	-	-	-	DC, FN, Z6	39	41	38	-	69
	RESALE	789	-	-	909	1029	1139	1259	-	-	-	-		21.5	23	20	27	2
DISC! 240491 Ottoman	COST	-	-	-	-	-	-	-	-	-	-	-	FN	19	31.5	23	-	27
	RESALE	439	-	-	489	549	599	649	-	-	-	-		-	-	-	-	0.5

General guidance, may not apply to all prefixes. Please refer to Product Info Guide for more detail by prefix.

ORDER FOB'S: 05, 06

BACKS: Semi-attached, blown fiber

PILLOWS: 20" knife-edge w/ welt (P1)

STD FINISH: N/A

SEATS: Loose, box-border, Premier standard (SS)

OPT FINISHES: N/A

CAP CODES: DR, UR, DP, NP, PS, VS, LL, LM

FEATURES: Welt trim on backs, arm posts, seats, and front rail

BATTERY: N/A

SPECIAL INFO: Due to exposed connector brackets, units not suitable for stand-alone pieces.

SELECT FABRIC:

SELECT FAUX LEATHER: N/A

SELECT LEATHER: N/A

D1807 Fairfax

D1905 York

D2099 i-Favorite



494 COLLINS	GRADE	SELECT			CUSTOM FABRIC				CUSTOM LEATHER / PLUS				AVAILABLE OPTIONS	DIMENSIONS				
		FAB	FAUX LTH	LTH	B-C	D-F, RE	G-N	P-Q	BL	DL	FL	HL		H	W	D	RD	WT
		SH	SW	SD	AH	SF												
60A494 Left-Arm SITTING Chair	COST	-	-	-	-	-	-	-	-	-	-	-	DC, FP, P1, Z6	37.5	32.5	39	-	60
	RESALE	779	-	-	899	1019	1129	1249	1319	1539	1749	1959		21	24	23.5	26	2

494 COLLINS	GRADE	SELECT			CUSTOM FABRIC				CUSTOM LEATHER / PLUS				AVAILABLE OPTIONS	DIMENSIONS				
		FAB	FAUX LTH	LTH	B-C	D-F, RE	G-N	P-Q	BL	DL	FL	HL		H	W	D	RD	WT
		SH	SW	SD	AH	SF												
60B494 Right-Arm SITTING Chair	COST	-	-	-	-	-	-	-	-	-	-	-	DC, FP, P1, Z6	37.5	32.5	39	-	60
	RESALE	779	-	-	899	1019	1129	1249	1319	1539	1749	1959		21	24	23.5	26	2
60C494 Rounded Corner Unit	COST	-	-	-	-	-	-	-	-	-	-	-	DC, FP, P1, Z6	37.5	67	39	-	79
	RESALE	989	-	-	1149	1309	1469	1629	1829	2369	2899	3429		21	-	25	-	2
6CC494 90 Degree Corner Unit	COST	-	-	-	-	-	-	-	-	-	-	-	DC, FP, P1, Z6	37.5	53	39	-	70
	RESALE	949	-	-	1109	1269	1429	1589	1779	2309	2839	3379		21	-	23.5	-	1
60D494 Left-Arm SITTING Loveseat	COST	-	-	-	-	-	-	-	-	-	-	-	DC, FP, P1, Z6	37.5	56.5	39	-	93
	RESALE	1119	-	-	1279	1439	1599	1759	2209	2739	3269	3799		21	48	23.5	26	2
60E494 Right-Arm SITTING Loveseat	COST	-	-	-	-	-	-	-	-	-	-	-	DC, FP, P1, Z6	37.5	56.5	39	-	93
	RESALE	1119	-	-	1279	1439	1599	1759	2209	2739	3269	3799		21	48	23.5	26	2
60M494 Sectional Armless Chair	COST	-	-	-	-	-	-	-	-	-	-	-	DC, Z6	37.5	24	39	-	46
	RESALE	659	-	-	779	899	1019	1129	1159	1379	1589	1799		21	24	23.5	-	1
6MM494 Sectional Armless Loveseat	COST	-	-	-	-	-	-	-	-	-	-	-	DC, Z6	37.5	63	39	-	90
	RESALE	1189	-	-	1339	1499	1659	1819	2099	2629	3159	3699		21	63	23.5	-	2
60L494 Left-Arm SITTING Chaise	COST	-	-	-	-	-	-	-	-	-	-	-	DC, FP, P1, Z6	37.5	32.5	64	-	86
	RESALE	1119	-	-	1279	1439	1599	1759	2099	2629	3159	3699		21	24	48	26	2
60R494 Right-Arm SITTING Chaise	COST	-	-	-	-	-	-	-	-	-	-	-	DC, FP, P1, Z6	37.5	32.5	64	-	86
	RESALE	1119	-	-	1279	1439	1599	1759	2099	2629	3159	3699		21	24	48	26	2
6SC494 Storage Console	COST	-	-	-	-	-	-	-	-	-	-	-	FN	25.5	10	38.5	-	59
	RESALE	799	-	-	859	909	959	1019	969	1079	1189	1289		-	-	-	-	1
6SP494 Armless Full Sleeper	COST	-	-	-	-	-	-	-	-	-	-	-	DC, MA, MT, Z6	37.5	63	39	-	142
	RESALE	1559	-	-	1719	1879	2039	2199	2469	2999	3539	4069		21	63	23.5	-	2
6SL494 Left-Arm SITTING Chaise w/ Storage	COST	-	-	-	-	-	-	-	-	-	-	-	DC, FP, P1, Z6	37.5	39	64	-	148
	RESALE	1279	-	-	1439	1599	1759	1919	2259	2789	3319	3859		21	30	48	26	2
6SR494 Right-Arm SITTING Chaise w/ Storage	COST	-	-	-	-	-	-	-	-	-	-	-	DC, FP, P1, Z6	37.5	39	64	-	148
	RESALE	1279	-	-	1439	1599	1759	1919	2259	2789	3319	3859		21	30	48	26	2



General guidance, may not apply to all prefixes. Please refer to Product Info Guide for more detail by prefix.

ORDER FOB'S: 05, 06

BACKS: Semi-attached, blown fiber

PILLOWS: (2) 20" knife-edge w/ welt (P1)

STD FINISH: N/A

SEATS: Loose, box-border, Premier standard (SS)

OPT FINISHES: N/A

CAP CODES: DR, UR, DP, NP, PS, VS, LL, LM

FEATURES: Welt trim on backs, arm posts, seats, and front rail

BATTERY: N/A

SPECIAL INFO: N/A

SELECT FAUX LEATHER: N/A

SELECT LEATHER: N/A

D1807 Fairfax
D1905 York
D2099 i-Favorite

494 COLLINS	GRADE	SELECT			CUSTOM FABRIC				CUSTOM LEATHER / PLUS				AVAILABLE OPTIONS	DIMENSIONS				
		FAB	FAUX LTH	LTH	B-C	D-F, RE	G-N	P-Q	BL	DL	FL	HL		H	W	D	RD	WT
		SH	SW	SD	AH	SF												
610494 Sofa	COST	-	-	-	-	-	-	-	-	-	-	-	DC, FP, P1, Z6	37.5	89	39	-	132
	RESALE	1579	-	-	1739	1899	2059	2219	2629	3159	3699	4229		21	72	23.5	26	3
630494 Loveseat	COST	-	-	-	-	-	-	-	-	-	-	-	DC, FP, P1, Z6	37.5	65	39	-	98
	RESALE	1539	-	-	1699	1859	2019	2169	2589	3119	3649	4189		21	48	23.5	26	2
230494 Chair	COST	-	-	-	-	-	-	-	-	-	-	-	DC, Z6	37.5	41	39	-	68
	RESALE	949	-	-	1069	1189	1299	1419	1619	1829	2049	2259		21	24	23.5	26	1
240494 Ottoman	COST	-	-	-	-	-	-	-	-	-	-	-	N/A	18.5	31.5	23.5	-	28
	RESALE	539	-	-	589	639	699	749	859	959	1069	1169		-	-	-	-	0.5



General guidance, may not apply to all prefixes. Please refer to Product Info Guide for more detail by prefix.

ORDER FOB'S: 05, 06

BACKS: Blown fiber

SWIVEL: 088123, 088124, 088126, 08812T

STD FINISH: 007

SEATS: Ultra plush chaise (SS)

TALL: 088210, 088266

OPT FINISHES: 021

CAP CODES: DR, UR, UE, BU, RL, LL, LM

FEATURES: N/A

BATTERY: 088BP1

SPECIAL INFO: N/A

SELECT FAUX LEATHER:

SELECT LEATHER:

C1852 Tiago
C2029 Easy

D1825 i-Raven Crest

LB1728 Goshen - 56, 78

502 JOSHUA	GRADE	SELECT			CUSTOM FABRIC				CUSTOM LEATHER / PLUS				AVAILABLE OPTIONS	DIMENSIONS				
		FAB	FAUX LTH	LTH	B-C	D-F, RE	G-N	P-Q	BL	DL	FL	HL		H	W	D	RD	WT
		SH	SW	SD	AH	SF												
010502 Rocking Recliner	COST	-	-	-	-	-	-	-	-	-	-	-	ES, FN, FS, H1, H3, L1, L3, LE, LS, SW	42.5	40	40	15	74
	RESALE	689	699	929	799	919	1039	1149	1039	1249	1459	1669		19.5	19	22	26	1
10U502 Power Rocking Recliner w/ Headrest	COST	-	-	-	-	-	-	-	-	-	-	-	FN, FS, LW, SL	42.5	38	40	15	101.5
	RESALE	1269	1279	1519	1389	1499	1619	1739	1619	1829	2049	2259		19.5	19	22	26	1

502 JOSHUA	GRADE	SELECT			CUSTOM FABRIC				CUSTOM LEATHER / PLUS				AVAILABLE OPTIONS	DIMENSIONS				
		FAB	FAUX LTH	LTH	B-C	D-F, RE	G-N	P-Q	BL	DL	FL	HL		H	W	D	RD	WT
		SH	SW	SD	AH	SF												
10X502 Power Rocking Recliner w/ Headrest & Lumbar	COST	-	-	-	-	-	-	-	-	-	-	-	FN, FS, LW, SL	42.5	38	40	15	106.5
	RESALE	1429	1439	1669	1549	1659	1779	1899	1779	1989	2209	2419		19.5	19	22	26	1
016502 Wall Recliner	COST	-	-	-	-	-	-	-	-	-	-	-	ES, FN, FS, H1, H3, L1, L3, LE, LS	42.5	40	40	8	81
	RESALE	719	729	959	829	949	1069	1189	1069	1279	1489	1709		19.5	19	22	26	1
16X502 Power Wall Recliner w/ Headrest & Lumbar	COST	-	-	-	-	-	-	-	-	-	-	-	FS, LW	42.5	38	40	8	116.5
	RESALE	1459	1469	1709	1579	1699	1809	1929	1809	2029	2239	2449		19.5	19	22	26	1



General guidance, may not apply to all prefixes. Please refer to Product Info Guide for more detail by prefix.

ORDER FOB'S: 05, 06

STD FINISH: N/A

OPT FINISHES: N/A

BATTERY: N/A

SPECIAL INFO: PLANNED STOCKED COVER(S): 1PH=D160662
Stocked units may be ordered as warehouse (FOB's 36, 45) or production (FOB's 05, 06)

SELECT FABRIC:
D1606 i-Halifax

BACKS: Blown fiber

SEATS: Standard lift (SS)

CAP CODES: DR, UR, UE, BU, RL

SELECT FAUX LEATHER: N/A

SWIVEL: N/A

TALL: N/A

FEATURES: Single occupant - 350-lb operating capacity, zero gravity position capability, storage pocket located on right-side sitting arm, battery back-up

SELECT LEATHER: N/A

512 PINNACLE	GRADE	SELECT			CUSTOM FABRIC				CUSTOM LEATHER / PLUS				AVAILABLE OPTIONS	DIMENSIONS				
		FAB	FAUX LTH	LTH	B-C	D-F, RE	G-N	P-Q	BL	DL	FL	HL		H	W	D	RD	WT
		SH	SW	SD	AH	SF												
1PH512 Platinum Power Lift Recliner w/ Headrest & Lumbar	COST	-	-	-	-	-	-	-	-	-	-	-	FS	45	33.5	39	12.5	152
	RESALE	1939	-	-	2059	2169	2289	2409	-	-	-	-		22	20	21	26	2
1PL512 Platinum Power Lift Recliner	COST	-	-	-	-	-	-	-	-	-	-	-	FS	45	33.5	39	12.5	135
	RESALE	1619	-	-	1739	1859	1969	2089	-	-	-	-		22	20	21	26	1



General guidance, may not apply to all prefixes. Please refer to Product Info Guide for more detail by prefix.

ORDER FOB'S: 05, 06

BACKS: Blown fiber

PILLOWS: N/A

STD FINISH: 007

SEATS: Standard chaise (SS)

OPT FINISHES: 021

CAP CODES: DR, UR, UE, BU, RL, LL, LM

FEATURES: N/A

BATTERY: 088BP2

SPECIAL INFO: N/A

SELECT FABRIC:

SELECT FAUX LEATHER: N/A

SELECT LEATHER:

D1606 i-Halifax

LB2064 Opulence - 74, 77

D1759 i-Saxton

D2140 i-Eugene

512 PINNACLE	GRADE	SELECT			CUSTOM FABRIC				CUSTOM LEATHER / PLUS				AVAILABLE OPTIONS	DIMENSIONS				
		FAB	FAUX LTH	LTH	B-C	D-F, RE	G-N	P-Q	BL	DL	FL	HL		H	W	D	RD	WT
		SH	SW	SD	AH	SF												
330512 Wall Reclining Sofa	COST	-	-	-	-	-	-	-	-	-	-	-	1H, 2E, 3H, FN, FS	41	81.5	38	7	192
	RESALE	1599	-	2099	1759	1919	2079	2239	2419	2949	3479	4019		20	68.5	20	23.5	3
33U512 Power Wall Reclining Sofa w/ Headrest	COST	-	-	-	-	-	-	-	-	-	-	-	FS, W2	42	81.5	38.5	7	213
	RESALE	2559	-	3059	2719	2879	3039	3199	3379	3909	4439	4969		19.5	65	20.5	23.5	3
33X512 Power Wall Reclining Sofa w/ Headrest & Lumbar	COST	-	-	-	-	-	-	-	-	-	-	-	FS, W2	42	81.5	38.5	7	223
	RESALE	2879	-	3379	3039	3199	3359	3519	3699	4229	4759	5289		19.5	65	20.5	23.5	3
320512 Wall Reclining Loveseat	COST	-	-	-	-	-	-	-	-	-	-	-	1H, 2E, 3H, FN, FS	41	57	38	7	144
	RESALE	1559	-	2059	1719	1879	2039	2199	2379	2909	3439	3969		20	44.5	20	23.5	2
32U512 Power Reclining Loveseat w/ Headrest	COST	-	-	-	-	-	-	-	-	-	-	-	FS, W2	42	56	38.5	7	178
	RESALE	2519	-	3019	2669	2829	2989	3149	3329	3869	4399	4929		19.5	43	20.5	23.5	2
32X512 Power Wall Reclining Loveseat w/ Headrest & Lumbar	COST	-	-	-	-	-	-	-	-	-	-	-	FS, W2	42	56	38.5	7	188
	RESALE	2829	-	3329	2989	3149	3309	3469	3649	4189	4719	5249		19.5	41	20.5	23.5	2
339512 Wall Reclining Loveseat w/ Console	COST	-	-	-	-	-	-	-	-	-	-	-	1H, 2E, 3H, CB, CC, CM, FN, FS	41	75.5	38	7	194
	RESALE	1709	-	2209	1869	2029	2189	2339	2529	3059	3589	4119		19.5	72	22	23.5	3
U39512 Power Wall Reclining Loveseat w/ Headrest & Console	COST	-	-	-	-	-	-	-	-	-	-	-	CB, CC, CM, FS, W2	41	75.5	38	7	213
	RESALE	2659	-	3159	2819	2979	3139	3299	3479	4019	4549	5079		19.5	72	22	23.5	3
X39512 Power Wall Reclining Loveseat w/ Console Headrest & Lumbar	COST	-	-	-	-	-	-	-	-	-	-	-	CB, CC, CM, FS, W2	41	75.5	38	7	225
	RESALE	2979	-	3479	3139	3299	3459	3619	3799	4329	4869	5399		19.5	72	22	23.5	3
30L512 Left-Arm SITTING Rocking Recliner	COST	-	-	-	-	-	-	-	-	-	-	-	FN, FS, L1, L3, LE	41.5	30	37.5	12	67
	RESALE	779	-	1019	899	1019	1129	1249	1119	1329	1549	1759		20	23.5	21	24	1
SC3512 Storage Console	COST	-	-	-	-	-	-	-	-	-	-	-	CB, CC, CM	35	14.5	33.5	-	49
	RESALE	629	-	839	689	739	789	839	899	999	1109	1219		25.5	-	-	-	1
30R512 Right-Arm SITTING Rocking Recliner	COST	-	-	-	-	-	-	-	-	-	-	-	ES, FN, FS, H1, H3, L3	41.5	30	37.5	12	67
	RESALE	779	-	1019	899	1019	1129	1249	1119	1329	1549	1759		20	23.5	21	24	1



General guidance, may not apply to all prefixes. Please refer to Product Info Guide for more detail by prefix.

ORDER FOB'S: 05, 06

BACKS: Blown fiber

SWIVEL: 088123, 088124, 088126, 08812T

STD FINISH: 007

SEATS: Standard chaise (SS)

TALL: 088210, 088266

OPT FINISHES: 021

CAP CODES: DR, UR, UE, BU, RL, LL, LM

FEATURES: N/A

BATTERY: 088BP1

SPECIAL INFO: N/A

SELECT FAUX LEATHER: N/A

SELECT LEATHER: LB2064 Opulence - 74, 77

D1606 i-Halifax
D1759 i-Saxton
D2140 i-Eugene

512 PINNACLE	GRADE	SELECT			CUSTOM FABRIC				CUSTOM LEATHER / PLUS				AVAILABLE OPTIONS	DIMENSIONS				
		FAB	FAUX LTH	LTH	B-C	D-F, RE	G-N	P-Q	BL	DL	FL	HL		H	W	D	RD	WT
		SH	SW	SD	AH	SF												
010512 Rocking Recliner	COST	-	-	-	-	-	-	-	-	-	-	-	ES, FN, FS, H1, H3, L1, L3, LE, LS, SW	41	33	38.5	12	71
	RESALE	789	-	999	909	1029	1139	1259	1109	1319	1539	1749		18.5	19	21.5	23.5	1
10U512 Power Rocking Recliner w/ Headrest	COST	-	-	-	-	-	-	-	-	-	-	-	FN, FS, LW, SL	41	31	38.5	12	85.5
	RESALE	1379	-	1589	1489	1609	1729	1839	1699	1909	2119	2329		18.5	19	21.5	23.5	1
10X512 Power Rocking Recliner w/ Headrest & Lumbar	COST	-	-	-	-	-	-	-	-	-	-	-	FN, FS, LW, SL	41	31	38.5	12	90.5
	RESALE	1539	-	1749	1649	1769	1889	1999	1859	2069	2279	2489		18.5	19	21.5	23.5	1
016512 Wall Recliner	COST	-	-	-	-	-	-	-	-	-	-	-	ES, FN, FS, H1, H3, L1, L3, LE, LS	41	33	38.5	7	78
	RESALE	819	-	1039	939	1059	1169	1289	1139	1359	1569	1779		18.5	19	21.5	23.5	1
16X512 Power Wall Recliner w/ Headrest & Lumbar	COST	-	-	-	-	-	-	-	-	-	-	-	FS, LW	41	31	38.5	7	90.5
	RESALE	1569	-	1779	1689	1799	1919	2039	1889	2099	2309	2529		18.5	19	21.5	23.5	1
017512 Swivel Gliding Recliner	COST	-	-	-	-	-	-	-	-	-	-	-	ES, FN, FS, H1, H3, L1, L3, LE, LS	41	33	38.5	11.5	105
	RESALE	949	-	1159	1069	1189	1299	1419	1269	1479	1699	1909		18.5	19	21.5	23.5	1



General guidance, may not apply to all prefixes. Please refer to Product Info Guide for more detail by prefix.

ORDER FOB'S: 05, 06

STD FINISH: N/A

OPT FINISHES: N/A

BATTERY: N/A

SPECIAL INFO: PLANNED STOCKED COVER(S): 1PH=D180657
Stocked units may be ordered as warehouse (FOB's 36, 45) or production (FOB's 05, 06)

SELECT FABRIC:
D1806 i-Catalyst

BACKS: Blown fiber/foam

SEATS: Standard lift (SS)

CAP CODES: DR, UR, UE, BU, RL

SELECT FAUX LEATHER: N/A

SWIVEL: N/A

TALL: N/A

FEATURES: Single occupant - 350-lb operating capacity, zero gravity position capability, storage pocket located on right-side sitting arm, battery back-up

SELECT LEATHER: N/A

519 ASTOR	GRADE	SELECT			CUSTOM FABRIC				CUSTOM LEATHER / PLUS				AVAILABLE OPTIONS	DIMENSIONS				
		FAB	FAUX LTH	LTH	B-C	D-F, RE	G-N	P-Q	BL	DL	FL	HL		H	W	D	RD	WT
		SH	SW	SD	AH	SF												
1PH519 Platinum Power Lift Recliner w/ Headrest & Lumbar	COST	-	-	-	-	-	-	-	-	-	-	-	FS	45.5	35	39	12.5	157
	RESALE	2119	-	-	2239	2359	2469	2589	-	-	-	-		22	19	21.5	28	2
1PL519 Platinum Power Lift Recliner	COST	-	-	-	-	-	-	-	-	-	-	-	FS	45.5	35	39	12.5	145
	RESALE	1799	-	-	1919	2039	2149	2269	-	-	-	-		22	19	21.5	28	1



General guidance, may not apply to all prefixes. Please refer to Product Info Guide for more detail by prefix.

ORDER FOB'S: 05, 06

STD FINISH: 007

OPT FINISHES: 021

BATTERY: 088BP1

SPECIAL INFO: N/A

SELECT FABRIC:
C2118 Cosdrew
D1806 i-Catalyst

BACKS: Blown fiber/foam

SEATS: Deep, standard chaise (SS)

CAP CODES: DR, UR, UE, BU, RL, LL, LM

SELECT FAUX LEATHER: N/A

SWIVEL: 088124, 08812T

TALL: N/A

FEATURES: Tall base

SELECT LEATHER:

LB1590 Cranbrook - 58, 79

519 ASTOR	GRADE	SELECT			CUSTOM FABRIC				CUSTOM LEATHER / PLUS				AVAILABLE OPTIONS	DIMENSIONS				
		FAB	FAUX LTH	LTH	B-C	D-F, RE	G-N	P-Q	BL	DL	FL	HL		H	W	D	RD	WT
		SH	SW	SD	AH	SF												
010519 Rocking Recliner	COST	-	-	-	-	-	-	-	-	-	-	-	ES, FN, FS, H1, H3, L1, L3, LE, LS, SW	44.5	37.5	41	14.5	80
	RESALE	959	-	1429	1079	1199	1309	1429	1539	1749	1959	2169		21	21	21	26	1
10U519 Power Rocking Recliner w/ Headrest	COST	-	-	-	-	-	-	-	-	-	-	-	FN, FS, LW, SL	44.5	35.5	41	15	104
	RESALE	1549	-	2019	1659	1779	1899	2019	2119	2329	2549	2759		21	21	21	26	1
10X519 Power Rocking Recliner w/ Headrest & Lumbar	COST	-	-	-	-	-	-	-	-	-	-	-	FN, FS, LW, SL	44.5	35.5	41	14.5	109
	RESALE	1709	-	2169	1819	1939	2059	2169	2279	2489	2709	2919		21	21	21	26	1
016519 Wall Recliner	COST	-	-	-	-	-	-	-	-	-	-	-	ES, FN, FS, H1, H3, L1, L3, LE, LS	44.5	37.5	41	7	87
	RESALE	989	-	1459	1109	1229	1339	1459	1569	1779	1989	2209		21	21	21	26	1

519 ASTOR	GRADE	SELECT			CUSTOM FABRIC				CUSTOM LEATHER / PLUS				AVAILABLE OPTIONS	DIMENSIONS				
		FAB	FAUX LTH	LTH	B-C	D-F, RE	G-N	P-Q	BL	DL	FL	HL		H	W	D	RD	WT
		SH	SW	SD	AH	SF												
16X519 Power Wall Recliner w/ Headrest & Lumbar	COST	-	-	-	-	-	-	-	-	-	-	-	FN, FS, LW	44.5	35.5	41	7	134
RESALE	1739	-	2209	1859	1969	2089	2209	2309	2529	2739	2949	21		21	21	26	1	

General guidance, may not apply to all prefixes. Please refer to Product Info Guide for more detail by prefix.

ORDER FOB'S: 05, 06

BACKS: Blown fiber

PILLOWS: N/A

STD FINISH: N/A

SEATS: 440 sculpted-bucket chaise (SS)



OPT FINISHES: N/A

CAP CODES: DR, UR, UE, BU, RL, LL, LM

FEATURES: N/A

BATTERY: 088BP1

SPECIAL INFO: N/A

SELECT FAUX LEATHER: N/A

SELECT LEATHER:

D2066 i-Kudos

LB1520 Yellowstone - 56, 78

D2095 Crocker

521 JAMES	GRADE	SELECT			CUSTOM FABRIC				CUSTOM LEATHER / PLUS				AVAILABLE OPTIONS	DIMENSIONS				
		FAB	FAUX LTH	LTH	B-C	D-F, RE	G-N	P-Q	BL	DL	FL	HL		H	W	D	RD	WT
		SH	SW	SD	AH	SF												
44A521 Left-Arm SITTING Recliner	COST	-	-	-	-	-	-	-	-	-	-	-	FS	41.5	33	39.5	4.5	77
	RESALE	789	-	1059	909	1029	1139	1259	1159	1379	1589	1799		20.5	23	21	26	2
U4A521 Power Left-Arm SITTING Recliner w/ Headrest	COST	-	-	-	-	-	-	-	-	-	-	-	FS, LW	41.5	33	39.5	4.5	94
	RESALE	1109	-	1379	1229	1339	1459	1579	1479	1699	1909	2119		20.5	23	21	26	2
X4A521 Power Left-Arm SITTING Recliner w/ Headrest and Lumbar	COST	-	-	-	-	-	-	-	-	-	-	-	FS, LW	41.5	33	39.5	4.5	99
	RESALE	1269	-	1539	1389	1499	1619	1739	1639	1859	2069	2279		20.5	23	21	26	2
44B521 Right-Arm SITTING Recliner	COST	-	-	-	-	-	-	-	-	-	-	-	FS	41.5	33	39.5	4.5	77
	RESALE	789	-	1059	909	1029	1139	1259	1159	1379	1589	1799		20.5	23	21	26	2
U4B521 Power Right-Arm SITTING Recliner w/ Headrest	COST	-	-	-	-	-	-	-	-	-	-	-	FS, RW	41.5	33	39.5	4.5	94
	RESALE	1109	-	1379	1229	1339	1459	1579	1479	1699	1909	2119		20.5	23	21	26	2
X4B521 Power Right-Arm SITTING Recliner w/ Headrest and Lumbar	COST	-	-	-	-	-	-	-	-	-	-	-	FS, RW	41.5	33	39.5	4.5	99
	RESALE	1269	-	1539	1389	1499	1619	1739	1639	1859	2069	2279		20.5	23	21	26	2
44C521 Rounded Corner Unit	COST	-	-	-	-	-	-	-	-	-	-	-	FS	41.5	61	39.5	-	65
	RESALE	979	-	1289	1139	1299	1459	1619	1609	2139	2669	3209		22.5	-	24	-	2
SC4521 Storage Console	COST	-	-	-	-	-	-	-	-	-	-	-	CB, CC, CM	38.5	14.5	38.5	-	56
	RESALE	629	-	859	689	739	789	839	909	1019	1119	1229		-	-	-	-	1
44D521 Left-Arm SITTING Reclining Loveseat	COST	-	-	-	-	-	-	-	-	-	-	-	FS	41.5	56.5	39.5	4.5	122
	RESALE	1209	-	1609	1369	1529	1689	1839	1929	2459	2989	3529		20.5	46.5	21	26	2
U4D521 Power Left-Arm SITTING Reclining Loveseat w/ Headrest	COST	-	-	-	-	-	-	-	-	-	-	-	FS, LW	41.5	56.5	39.5	4.5	139
	RESALE	1529	-	1929	1689	1839	1999	2159	2249	2779	3309	3839		20.5	46.5	21	26	2

521 JAMES	GRADE	SELECT			CUSTOM FABRIC				CUSTOM LEATHER / PLUS				AVAILABLE OPTIONS	DIMENSIONS				
		FAB	FAUX LTH	LTH	B-C	D-F, RE	G-N	P-Q	BL	DL	FL	HL		H	W	D	RD	WT
		SH	SW	SD	AH	SF												
X4D521 Power Left-Arm SITTING Reclining Loveseat w/ Headrest and Lumbar	COST	-	-	-	-	-	-	-	-	-	-	-	FS, LW	41.5	56.5	39.5	4.5	149
	RESALE	1689	-	2089	1839	1999	2159	2319	2409	2939	3469	3999		20.5	46.5	21	26	2
44E521 Right-Arm SITTING Reclining Loveseat	COST	-	-	-	-	-	-	-	-	-	-	-	FS	41.5	56.5	39.5	4.5	122
	RESALE	1209	-	1609	1369	1529	1689	1839	1929	2459	2989	3529		20.5	46.5	21	26	2
U4E521 Power Right-Arm SITTING Reclining Loveseat w/ Headrest	COST	-	-	-	-	-	-	-	-	-	-	-	FS, RW	41.5	56.5	39.5	4.5	139
	RESALE	1529	-	1929	1689	1839	1999	2159	2249	2779	3309	3839		20.5	46.5	21	26	2
X4E521 Power Right-Arm SITTING Reclining Loveseat w/ Headrest and Lumbar	COST	-	-	-	-	-	-	-	-	-	-	-	FS, RW	41.5	56.5	39.5	4.5	149
	RESALE	1689	-	2089	1839	1999	2159	2319	2409	2939	3469	3999		20.5	46.5	21	26	2
M44521 Armless Chair	COST	-	-	-	-	-	-	-	-	-	-	-	FS	41.5	23.5	39.5	-	45
	RESALE	589	-	829	709	819	939	1059	939	1149	1369	1579		20.5	23.5	21	-	1
44Q521 Left-Arm SITTING Reclining Chaise	COST	-	-	-	-	-	-	-	-	-	-	-	FS	41.5	37.5	68	9.5	95
	RESALE	1119	-	1529	1279	1439	1599	1759	1839	2379	2909	3439		20.5	27.5	48.5	26	2
U4Q521 Power Left-Arm SITTING Reclining Chaise w/ Headrest	COST	-	-	-	-	-	-	-	-	-	-	-	FS, LW	41.5	37.5	68	9.5	95
	RESALE	1439	-	1839	1599	1759	1919	2079	2159	2699	3229	3759		20.5	27.5	48.5	26	2
X4Q521 Power Left-Arm SITTING Reclining Chaise w/ Headrest and Lumbar	COST	-	-	-	-	-	-	-	-	-	-	-	FS, LW	41.5	37.5	68	9.5	100
	RESALE	1599	-	1999	1759	1919	2079	2239	2319	2859	3389	3919		20.5	27.5	48.5	26	2
44S521 Armless Recliner	COST	-	-	-	-	-	-	-	-	-	-	-	FS	41.5	23.5	39.5	4.5	60
	RESALE	699	-	939	809	929	1049	1159	1049	1259	1469	1689		20.5	23.5	21	26	1
U4S521 Power Armless Recliner w/ Headrest	COST	-	-	-	-	-	-	-	-	-	-	-	FS, RW	41.5	23.5	39.5	4.5	75
	RESALE	1019	-	1259	1129	1249	1369	1479	1369	1579	1789	1999		20.5	23.5	21	-	1
X4S521 Power Armless Recliner w/ Headrest and Lumbar	COST	-	-	-	-	-	-	-	-	-	-	-	FS, RW	41.5	23.5	39.5	4.5	80
	RESALE	1169	-	1419	1289	1409	1529	1639	1529	1739	1949	2159		20.5	23.5	21	-	1
44V521 Right-Arm SITTING Reclining Chaise	COST	-	-	-	-	-	-	-	-	-	-	-	FS	41.5	37.5	68	9.5	95
	RESALE	1119	-	1529	1279	1439	1599	1759	1839	2379	2909	3439		20.5	27.5	48.5	26	2
U4V521 Power Right-Arm SITTING Reclining Chaise w/ Headrest	COST	-	-	-	-	-	-	-	-	-	-	-	FS, RW	41.5	37.5	68	9.5	95
	RESALE	1439	-	1839	1599	1759	1919	2079	2159	2699	3229	3759		20.5	27.5	48.5	26	2
X4V521 Power Right-Arm SITTING Reclining Chaise w/ Headrest and Lumbar	COST	-	-	-	-	-	-	-	-	-	-	-	FS, RW	41.5	37.5	68	9.5	100
	RESALE	1599	-	1999	1759	1919	2079	2239	2319	2859	3389	3919		20.5	27.5	48.5	26	2

General guidance, may not apply to all prefixes. Please refer to Product Info Guide for more detail by prefix.



ORDER FOB'S: 05, 06

BACKS: Blown fiber

PILLOWS: N/A

STD FINISH: N/A

SEATS: 440 sculpted-bucket chaise (SS)

OPT FINISHES: N/A

CAP CODES: DR, UR, UE, BU, RL, LL, LM

FEATURES: N/A

BATTERY: 088BP2

SPECIAL INFO: N/A

SELECT FAUX LEATHER: N/A

SELECT LEATHER:

D2066 i-Kudos

LB1520 Yellowstone - 56, 78

D2095 Crocker

521 JAMES	GRADE	SELECT			CUSTOM FABRIC				CUSTOM LEATHER / PLUS				AVAILABLE OPTIONS	DIMENSIONS				
		FAB	FAUX LTH	LTH	B-C	D-F, RE	G-N	P-Q	BL	DL	FL	HL		H	W	D	RD	WT
		SH	SW	SD	AH	SF												
444521 Reclining Sofa	COST	-	-	-	-	-	-	-	-	-	-	-	FS	41.5	87	39	4	190
	RESALE	1559	-	2259	1719	1879	2039	2199	2579	3109	3639	4169		20.5	69	21	26	3
U44521 Power Reclining Sofa w/ Headrest	COST	-	-	-	-	-	-	-	-	-	-	-	FS, W2	41.5	87	39	4	224
	RESALE	2199	-	2899	2359	2519	2669	2829	3219	3749	4279	4809		20.5	69	21	26	3
X44521 Power Reclining Sofa w/ Headrest & Lumbar	COST	-	-	-	-	-	-	-	-	-	-	-	FS, W2	41.5	87	39	4	234
	RESALE	2519	-	3219	2669	2829	2989	3149	3539	4069	4599	5129		20.5	69	21	26	3
448521 Reclining Loveseat	COST	-	-	-	-	-	-	-	-	-	-	-	FS	41.5	64	39	4	152
	RESALE	1519	-	2219	1669	1829	1989	2149	2539	3069	3599	4129		20.5	46	21	26	2
U48521 Power Reclining Loveseat w/ Headrest	COST	-	-	-	-	-	-	-	-	-	-	-	FS, W2	41.5	64	39	4	186
	RESALE	2149	-	2859	2309	2469	2629	2789	3169	3709	4239	4769		20.5	46	21	26	2
X48521 Power Reclining Loveseat w/ Headrest & Lumbar	COST	-	-	-	-	-	-	-	-	-	-	-	FS, W2	41.5	64	39	4	196
	RESALE	2469	-	3169	2629	2789	2949	3109	3489	4029	4559	5089		20.5	46	21	26	2
449521 Reclining Loveseat w/ Console	COST	-	-	-	-	-	-	-	-	-	-	-	CB, CC, CM, FS	41.5	79	39	4	179
	RESALE	1659	-	2369	1819	1979	2139	2299	2689	3219	3749	4279		20.5	61	21	26	3
U49521 Power Reclining Loveseat w/ Headrest & Console	COST	-	-	-	-	-	-	-	-	-	-	-	CB, CC, CM, FS, W2	41.5	79	39	4	213
	RESALE	2299	-	2999	2459	2619	2779	2939	3319	3859	4389	4919		20.5	61	21	26	3
X49521 Power Reclining Loveseat w/ Headrest, Lumbar & Console	COST	-	-	-	-	-	-	-	-	-	-	-	CB, CC, CM, FS, W2	41.5	79	39	4	223
	RESALE	2619	-	3319	2779	2939	3099	3259	3639	4169	4709	5239		20.5	61	21	26	3



General guidance, may not apply to all prefixes. Please refer to Product Info Guide for more detail by prefix.

ORDER FOB'S: 05, 06

BACKS: Blown fiber

SWIVEL: 088123, 088124, 088126, 08812T

STD FINISH: 007

SEATS: Sculpted-bucket chaise (SS)

TALL: 088210, 088266

OPT FINISHES: 021

CAP CODES: DR, UR, UE, BU, RL, LL, LM

FEATURES: N/A

BATTERY: 088BP1

SPECIAL INFO: N/A

SELECT FAUX LEATHER: N/A

SELECT LEATHER:

D2066 i-Kudos

LB1520 Yellowstone - 56, 78

D2095 Crocker

521 JAMES	GRADE	SELECT			CUSTOM FABRIC				CUSTOM LEATHER / PLUS				AVAILABLE OPTIONS	DIMENSIONS				
		FAB	FAUX LTH	LTH	B-C	D-F, RE	G-N	P-Q	BL	DL	FL	HL		H	W	D	RD	WT
		SH	SW	SD	AH	SF												
010521 Rocking Recliner	COST	-	-	-	-	-	-	-	-	-	-	-	ES, FN, FS, H1, H3, L1, L3, LE, LS, SW	42.5	39	38	13.5	73
	RESALE	769	-	999	889	999	1119	1239	1109	1319	1539	1749		20	21.5	21	25	1
10U521 Power Rocking Recliner w/ Headrest	COST	-	-	-	-	-	-	-	-	-	-	-	FN, FS, LW, SL	42.5	37	38	13.5	93.5
	RESALE	1359	-	1589	1469	1589	1709	1819	1699	1909	2119	2329		20	21.5	21	25	1
10X521 Power Rocking Recliner w/ Headrest & Lumbar	COST	-	-	-	-	-	-	-	-	-	-	-	FN, FS, LW, SL	42.5	37	38	13.5	98.5
	RESALE	1519	-	1749	1629	1749	1869	1979	1859	2069	2279	2489		20	21.5	21	25	1
016521 Wall Recliner	COST	-	-	-	-	-	-	-	-	-	-	-	ES, FN, FS, H1, H3, L1, L3, LE, LS	42.5	39	38	5.5	80
	RESALE	799	-	1039	919	1039	1149	1269	1139	1359	1569	1779		20	21.5	21	25	1
16X521 Power Wall Recliner w/ Headrest & Lumbar	COST	-	-	-	-	-	-	-	-	-	-	-	FS, LW	42.5	37	38	5.5	118.5
	RESALE	1549	-	1779	1659	1779	1899	2019	1889	2099	2309	2529		20	21.5	21	25	1

General guidance, may not apply to all prefixes. Please refer to Product Info Guide for more detail by prefix.

ORDER FOB'S: 05, 06

BACKS: Blown fiber

PILLOWS: N/A

STD FINISH: N/A

SEATS: 440 hybrid-bucket chaise (SS)

OPT FINISHES: N/A

CAP CODES: DR, UR, UE, BU, RL, LL, LM

FEATURES: Padded outside arms

BATTERY: 088BP2

SPECIAL INFO: Drop down table surface only available in Sable finish.

SELECT FAUX LEATHER: N/A

SELECT LEATHER:

D2125 Playlist

LB1930 (WQL) Salvo - 32, 56, 77

LB2113 Roberto - 31, 76, 79



530 GREYSON MOTION	GRADE	SELECT			CUSTOM FABRIC				CUSTOM LEATHER / PLUS				AVAILABLE OPTIONS	DIMENSIONS				
		FAB	FAUX LTH	LTH	B-C	D-F, RE	G-N	P-Q	BL	DL	FL	HL		H	W	D	RD	WT
		SH	SW	SD	AH	SF												
444530 Reclining Sofa	COST	-	-	-	-	-	-	-	-	-	-	-	FS	41	85	39	5	185
	RESALE	1819	-	2769	1979	2139	2299	2459	3089	3619	4149	4689		21	66.5	21.5	26	3

530 GREYSON MOTION		GRADE	SELECT			CUSTOM FABRIC				CUSTOM LEATHER / PLUS				AVAILABLE OPTIONS	DIMENSIONS				
			FAB	FAUX LTH	LTH	B-C	D-F, RE	G-N	P-Q	BL	DL	FL	HL		H	W	D	RD	WT
			SH	SW	SD	AH	SF												
U44530	Power Reclining Sofa w/ Headrest	COST	-	-	-	-	-	-	-	-	-	-	-	FS, W2	41	85	39	5	227
		RESALE	2459	-	3409	2619	2779	2939	3099	3729	4259	4789	5319		21	66.5	21.5	26	3
X44530	Power Reclining Sofa w/ Headrest & Lumbar	COST	-	-	-	-	-	-	-	-	-	-	-	FS, W2	41	85	39	5	237
		RESALE	2779	-	3729	2939	3099	3259	3419	4049	4579	5109	5639		21	66.5	21.5	26	3
NEW! 446530	Reclining Sofa w/ Drop Down Table	COST	-	-	-	-	-	-	-	-	-	-	-	FS	41	85	39	5	-
		RESALE	2089	-	3039	2249	2409	2569	2729	3359	3889	4419	4949		21	66.5	21.5	26	3
NEW! U46530	Power Reclining Sofa w/ Headrest, Lumbar and Drop Down Table	COST	-	-	-	-	-	-	-	-	-	-	-	FS, W2	41	85	39	5	-
		RESALE	2729	-	3669	3209	3369	3529	3689	4309	4839	5379	5909		21	66.5	21.5	26	3
NEW! X46530	Power Reclining Sofa w/ Headrest, Lumbar and Drop Down Table	COST	-	-	-	-	-	-	-	-	-	-	-	FS, W2	41	85	39	5	-
		RESALE	3049	-	3989	3529	3689	3839	3999	4629	5159	5699	6229		21	66.5	21.5	26	3
448530	Reclining Loveseat	COST	-	-	-	-	-	-	-	-	-	-	-	FS	41	62.5	39	5	147
		RESALE	1779	-	2729	1939	2099	2259	2419	3049	3579	4109	4639		21	43.5	21.5	26	2
U48530	Power Reclining Loveseat w/ Headrest	COST	-	-	-	-	-	-	-	-	-	-	-	FS, W2	41	62.5	39	5	189
		RESALE	2419	-	3369	2579	2739	2899	3059	3689	4219	4749	5279		21	43.5	21.5	26	2
X48530	Power Reclining Loveseat w/ Headrest & Lumbar	COST	-	-	-	-	-	-	-	-	-	-	-	FS, W2	41	62.5	39	5	199
		RESALE	2739	-	3689	2899	3059	3219	3379	3999	4539	5069	5599		21	43.5	21.5	26	2
449530	Reclining Loveseat w/ Console	COST	-	-	-	-	-	-	-	-	-	-	-	CB, CC, CM, FS	41	77	39	5	172
		RESALE	1929	-	2879	2089	2249	2409	2569	3199	3729	4259	4789		21	58	21.5	26	3
U49530	Power Reclining Loveseat w/ Headrest & Console	COST	-	-	-	-	-	-	-	-	-	-	-	CB, CC, CM, FS, W2	41	77	39	5	214
		RESALE	2569	-	3519	2729	2889	3049	3209	3829	4369	4899	5429		21	58	21.5	26	3
X49530	Power Reclining Loveseat w/ Headrest, Lumbar & Console	COST	-	-	-	-	-	-	-	-	-	-	-	CB, CC, CM, FS, W2	41	77	39	5	224
		RESALE	2889	-	3829	3049	3209	3369	3529	4149	4689	5219	5749		21	58	21.5	26	3



General guidance, may not apply to all prefixes. Please refer to Product Info Guide for more detail by prefix.

ORDER FOB'S: 05, 06

BACKS: Blown fiber

SWIVEL: 088123, 088124, 088126, 08812T

STD FINISH: 007

SEATS: Deep, hybrid-bucket chaise (SS)

TALL: 088210, 088266

OPT FINISHES: 021

CAP CODES: DR, UR, UE, BU, RL, LL, LM

FEATURES: Padded outside arms

BATTERY: 088BP1

SPECIAL INFO: N/A

SELECT FAUX LEATHER: N/A

SELECT LEATHER:

D2125 Playlist

LB1930 (WQL) Salvo - 32, 56, 77
LB2113 Roberto - 31, 76, 79

530 GREYSON RECLINER	GRADE	SELECT			CUSTOM FABRIC				CUSTOM LEATHER / PLUS				AVAILABLE OPTIONS	DIMENSIONS				
		FAB	FAUX LTH	LTH	B-C	D-F, RE	G-N	P-Q	BL	DL	FL	HL		H	W	D	RD	WT
														SH	SW	SD	AH	SF
010530 Rocking Recliner	COST	-	-	-	-	-	-	-	-	-	-	-	ES, FN, FS, H1, H3, L1, L3, LE, LS, SW	43	38.5	41	14	95
	RESALE	899	-	1379	1019	1129	1249	1369	1479	1699	1909	2119		20.5	20	23	26.5	1
10U530 Power Rocking Recliner w/ Headrest	COST	-	-	-	-	-	-	-	-	-	-	-	FN, FS, LW, SL	43	36.5	41	13	112
	RESALE	1479	-	1959	1599	1719	1829	1949	2069	2279	2489	2709		20.5	20	23	26.5	1
10X530 Power Rocking Recliner w/ Headrest & Lumbar	COST	-	-	-	-	-	-	-	-	-	-	-	FN, FS, LW, SL	43	36.5	41	14	117
	RESALE	1639	-	2119	1759	1879	1989	2109	2229	2439	2649	2869		20.5	20	23	26.5	1
016530 Wall Recliner	COST	-	-	-	-	-	-	-	-	-	-	-	ES, FN, FS, H1, H3, L1, L3, LE, LS	43	38.5	41	6	102
	RESALE	929	-	1409	1049	1159	1279	1399	1519	1729	1939	2149		20.5	20	23	26.5	1
16X530 Power Wall Recliner w/ Headrest & Lumbar	COST	-	-	-	-	-	-	-	-	-	-	-	FS, LW	43	36.5	41	6	127
	RESALE	1669	-	2149	1789	1909	2029	2139	2259	2469	2689	2899		20.5	20	23	26.5	1



General guidance, may not apply to all prefixes. Please refer to Product Info Guide for more detail by prefix.

ORDER FOB'S: 05, 06

STD FINISH: N/A

OPT FINISHES: N/A

BATTERY: N/A

SPECIAL INFO: Heating performance will vary depending on cover selection. Thicker covers backed with padded material may impede full heat transfer.
 PLANNED STOCKED COVER(S): D160454
 Stocked units may be ordered as warehouse (FOB's 36, 45) or production (FOB's 03, 05, 06)

BACKS: Foam

SEATS: Standard chaise (SS)

CAP CODES: DR, UR, UE, BU, RL

SWIVEL: N/A

TALL: N/A

FEATURES: Single occupant - 500 lb operating capacity, storage pocket located on right-side-sitting arm, battery backup

SELECT FABRIC:

D1604 i-Outlier

SELECT FAUX LEATHER: N/A

SELECT LEATHER: N/A

562 CLAYTON	GRADE	SELECT			CUSTOM FABRIC				CUSTOM LEATHER / PLUS				AVAILABLE OPTIONS	DIMENSIONS				
		FAB	FAUX LTH	LTH	B-C	D-F, RE	G-N	P-Q	BL	DL	FL	HL		H	W	D	RD	WT
		SH	SW	SD	AH	SF												
1HM562 Gold Power Lift Recliner w/ Massage & Heat	COST	-	-	-	-	-	-	-	-	-	-	-	FS	45.5	42	40.5	13.5	143
	RESALE	2069	-	-	2189	2299	2419	2539	-	-	-	-		22	23	23.5	27	2



General guidance, may not apply to all prefixes. Please refer to Product Info Guide for more detail by prefix.

ORDER FOB'S: 05, 06

STD FINISH: 007

OPT FINISHES: 021

BATTERY: 088BP1

SPECIAL INFO: N/A

SELECT FABRIC:

C1754 Kemet
 C1812 Damon

BACKS: Blown fiber

SEATS: Original bucket chaise (SS)

CAP CODES: DR, UR, UE, BU, RL, LL, LM

SWIVEL: 088123, 088124, 088126, 08812T

TALL: 088210, 088266

FEATURES: N/A

SELECT FAUX LEATHER: N/A

SELECT LEATHER:

LB2062 Clifton - 78, 79

582 MAVERICK	GRADE	SELECT			CUSTOM FABRIC				CUSTOM LEATHER / PLUS				AVAILABLE OPTIONS	DIMENSIONS				
		FAB	FAUX LTH	LTH	B-C	D-F, RE	G-N	P-Q	BL	DL	FL	HL		H	W	D	RD	WT
		SH	SW	SD	AH	SF												
010582 Rocking Recliner	COST	-	-	-	-	-	-	-	-	-	-	-	ES, FN, FS, H1, H3, L1, L3, LE, LS, SW	42	38	39	13	75
	RESALE	879	-	1319	989	1109	1229	1339	1429	1639	1859	2069		21	19	22	25.5	1
10U582 Power Rocking Recliner w/ Headrest	COST	-	-	-	-	-	-	-	-	-	-	-	FN, FS, LW, SL	42	36	39	10	100
	RESALE	1459	-	1909	1579	1699	1809	1929	2019	2229	2439	2649		21	19	22	25.5	1
10X582 Power Rocking Recliner w/ Headrest & Lumbar	COST	-	-	-	-	-	-	-	-	-	-	-	FN, FS, LW, SL	42	36	39	13	105
	RESALE	1619	-	2069	1739	1859	1969	2089	2169	2389	2599	2809		21	19	22	25.5	1
016582 Wall Recliner	COST	-	-	-	-	-	-	-	-	-	-	-	ES, FN, FS, H1, H3, L1, L3, LE, LS	42	38	39	7	82
	RESALE	909	-	1359	1029	1139	1259	1379	1459	1669	1889	2099		21	19	22	25.5	1

582 MAVERICK	GRADE	SELECT			CUSTOM FABRIC				CUSTOM LEATHER / PLUS				AVAILABLE OPTIONS	DIMENSIONS				
		FAB	FAUX LTH	LTH	B-C	D-F, RE	G-N	P-Q	BL	DL	FL	HL		H	W	D	RD	WT
		SH	SW	SD	AH	SF												
16X582 Power Wall Recliner w/ Headrest & Lumbar	COST	-	-	-	-	-	-	-	-	-	-	-	FS, LW	42	36	39	7	129
RESALE	1649	-	2099	1769	1889	1999	2119	2209	2419	2629	2839	21		19	22	25.5	1	

General guidance, may not apply to all prefixes. Please refer to Product Info Guide for more detail by prefix.



ORDER FOB'S: 05, 06

BACKS: Semi-attached, blown fiber

PILLOWS: (2) 20" knife-edge w/ welt (P1)

STD FINISH: 007

SEATS: Loose, box-border, Premier standard (SS)

OPT FINISHES: 021, 041, 071

CAP CODES: DR, UR, UE, VS, BU, RL, LL

FEATURES: Decorative wood legs, welt trim on backs, arms, seats, and rails

BATTERY: N/A

SPECIAL INFO: N/A

SELECT FABRIC:

SELECT FAUX LEATHER: N/A

SELECT LEATHER: N/A

D1564 i-Hallandale
D2129 Zinnamon

593 KENNEDY	GRADE	SELECT			CUSTOM FABRIC				CUSTOM LEATHER / PLUS				AVAILABLE OPTIONS	DIMENSIONS				
		FAB	FAUX LTH	LTH	B-C	D-F, RE	G-N	P-Q	BL	DL	FL	HL		H	W	D	RD	WT
		SH	SW	SD	AH	SF												
610593 Sofa	COST	-	-	-	-	-	-	-	-	-	-	-	DC, FN, FP, P1, Z6	39	77	38	-	125
	RESALE	1369	-	-	1529	1689	1839	1999	-	3219	3749	4279		21.5	67	20.5	26	3
510593 Queen Sleep Sofa	COST	-	-	-	-	-	-	-	-	-	-	-	DC, FN, FP, MA, MT, P1, Z6	39	77	38	-	205
	RESALE	1839	-	-	1999	2159	2319	2479	-	3699	4229	4759		21.5	67	20.5	26	3
620593 Apartment-Size Sofa	COST	-	-	-	-	-	-	-	-	-	-	-	DC, FN, FP, P1, Z6	39	69	38	-	118
	RESALE	1369	-	-	1529	1689	1839	1999	-	3219	3749	4279		21.5	59	20.5	26	2
520593 Full Sleep Sofa	COST	-	-	-	-	-	-	-	-	-	-	-	DC, FN, FP, MA, MT, P1, Z6	39	69	38	-	188
	RESALE	1789	-	-	1949	2109	2269	2429	-	3639	4169	4709		21.5	59	20.5	26	2
630593 Loveseat	COST	-	-	-	-	-	-	-	-	-	-	-	DC, FN, FP, P1, Z6	39	54.5	38	-	110
	RESALE	1319	-	-	1479	1639	1799	1959	-	3169	3709	4239		21.5	44.5	38	26	2
230593 Chair	COST	-	-	-	-	-	-	-	-	-	-	-	DC, FN, Z6	39	32	38	-	71
	RESALE	819	-	-	939	1059	1169	1289	-	1949	2159	2379		21.5	22	20.5	26	1
240593 Ottoman	COST	-	-	-	-	-	-	-	-	-	-	-	FN	19	27	24	-	24
	RESALE	459	-	-	519	569	619	669	-	1049	1149	1259		-	-	-	-	0.5

General guidance, may not apply to all prefixes. Please refer to Product Info Guide for more detail by prefix.



ORDER FOB'S: 05, 06

BACKS: Loose, box-border, chambered, blown fiber

PILLOWS: (1) 12" x 21" box-border kidney (P1)

STD FINISH: 007

SEATS: Loose, box-border Premier standard (SS)

OPT FINISHES: 021, 041, 071

CAP CODES: DR, UR, DP, NP, PS, UE, VS, BU, RL, LL, LM

FEATURES: Decorative wood legs

BATTERY: N/A

SPECIAL INFO: N/A

SELECT FABRIC:

SELECT FAUX LEATHER: N/A

SELECT LEATHER:

C2042 Duffey

LB2060 Sutton - 32, 54, 77, 87

603 WILMETTE	GRADE	SELECT			CUSTOM FABRIC				CUSTOM LEATHER / PLUS				AVAILABLE OPTIONS	DIMENSIONS				
		FAB	FAUX LTH	LTH	B-C	D-F, RE	G-N	P-Q	BL	DL	FL	HL		H	W	D	RD	WT
		SH	SW	SD	AH	SF												
60W603 Left-Arm SITTING Sofa w/ Attached Corner	COST	-	-	-	-	-	-	-	-	-	-	-	DC, FN, FP, P1, Z6	34	107	36	-	144
	RESALE	1209	-	1809	1369	1529	1689	1839	2129	2659	3199	3729		20	89	20.5	25	3
60X603 Right-Arm SITTING Sofa w/ Attached Corner	COST	-	-	-	-	-	-	-	-	-	-	-	DC, FN, FP, P1, Z6	34	107	36	-	144
	RESALE	1209	-	1809	1369	1529	1689	1839	2129	2659	3199	3729		20	89	20.5	25	3
60Y603 Left-Arm SITTING Sofa	COST	-	-	-	-	-	-	-	-	-	-	-	DC, FN, FP, P1, Z6	34	73.5	36	-	97
	RESALE	1209	-	1809	1369	1529	1689	1839	2129	2659	3199	3729		20	67	20.5	25	3
60Z603 Right-Arm SITTING Sofa	COST	-	-	-	-	-	-	-	-	-	-	-	DC, FN, FP, P1, Z6	34	73.5	36	-	97
	RESALE	1209	-	1809	1369	1529	1689	1839	2129	2659	3199	3729		20	67	20.5	25	3

General guidance, may not apply to all prefixes. Please refer to Product Info Guide for more detail by prefix.



ORDER FOB'S: 05, 06

BACKS: Loose, box-border, chambered, blown fiber

PILLOWS: (2) 12" x 21" box-border kidney (P1)

STD FINISH: 007

SEATS: Loose, box-border Premier standard (SS)

OPT FINISHES: 021, 041, 071

CAP CODES: DR, UR, DP, NP, PS, UE, VS, BU, RL, LL, LM

FEATURES: Decorative wood legs

BATTERY: N/A

SPECIAL INFO: N/A

SELECT FABRIC:

SELECT FAUX LEATHER: N/A

SELECT LEATHER:

C2042 Duffey

LB2060 Sutton - 32, 54, 77, 87

603 WILMETTE	GRADE	SELECT			CUSTOM FABRIC				CUSTOM LEATHER / PLUS				AVAILABLE OPTIONS	DIMENSIONS				
		FAB	FAUX LTH	LTH	B-C	D-F, RE	G-N	P-Q	BL	DL	FL	HL		H	W	D	RD	WT
		SH	SW	SD	AH	SF												
610603 Sofa	COST	-	-	-	-	-	-	-	-	-	-	-	DC, FN, FP, P1, Z6	34	75.5	36	-	114
	RESALE	1219	-	1629	1379	1539	1699	1859	1949	2479	3019	3549		20	67	20.5	25	3
655603 Chair & a Half	COST	-	-	-	-	-	-	-	-	-	-	-	DC, FN, FP, P1, Z6	34	39	36	-	82
	RESALE	1059	-	1419	1169	1289	1409	1529	1529	1739	1949	2159		20	30.5	20.5	25	2

603 WILMETTE	GRADE	SELECT			CUSTOM FABRIC				CUSTOM LEATHER / PLUS				AVAILABLE OPTIONS	DIMENSIONS				
		FAB	FAUX LTH	LTH	B-C	D-F, RE	G-N	P-Q	BL	DL	FL	HL		H	W	D	RD	WT
		SH	SW	SD	AH	SF												
240603 Ottoman	COST	-	-	-	-	-	-	-	-	-	-	-	FN	18	37.5	24	-	27
	RESALE	439	-	609	489	549	599	649	659	769	879	979		18	-	36	-	0.5

General guidance, may not apply to all prefixes. Please refer to Product Info Guide for more detail by prefix.



ORDER FOB'S: 05, 06

BACKS: Loose, chambered blown fiber

PILLOWS: (2) 18" knife-edge w/ welt (P1)

STD FINISH: 007

SEATS: Loose, box-border Premier standard (SS)

OPT FINISHES: 021, 041

CAP CODES: DR, UR, UE, BU, RL, LL, LM

FEATURES: Decorative wood legs, welt trim on outside arms

BATTERY: N/A

SPECIAL INFO: N/A

SELECT FAUX LEATHER: N/A

SELECT LEATHER: N/A

D2010 i-Rene

606 NOAH	GRADE	SELECT			CUSTOM FABRIC				CUSTOM LEATHER / PLUS				AVAILABLE OPTIONS	DIMENSIONS				
		FAB	FAUX LTH	LTH	B-C	D-F, RE	G-N	P-Q	BL	DL	FL	HL		H	W	D	RD	WT
		SH	SW	SD	AH	SF												
610606 Sofa	COST	-	-	-	-	-	-	-	-	-	-	-	DC, FN, FP, P1, Z6	36.5	83	36	-	129
	RESALE	1319	-	-	1479	1639	1799	1959	2069	2599	3129	3659		20.5	72	22	25.5	3
630606 Loveseat	COST	-	-	-	-	-	-	-	-	-	-	-	DC, FN, FP, P1, Z6	36.5	60.5	36	-	95
	RESALE	1279	-	-	1439	1599	1759	1919	2029	2559	3089	3619		20.5	49.5	22	25.5	2
230606 Chair	COST	-	-	-	-	-	-	-	-	-	-	-	DC, FN, Z6	36.5	35	36	-	65
	RESALE	789	-	-	909	1029	1139	1259	1299	1519	1729	1939		20.5	24	22	25.5	1
240606 Ottoman	COST	-	-	-	-	-	-	-	-	-	-	-	FN	17.5	30	23	-	22.5
	RESALE	439	-	-	489	549	599	649	729	829	939	1049		-	-	-	-	0.5

General guidance, may not apply to all prefixes. Please refer to Product Info Guide for more detail by prefix.



ORDER FOB'S: 05, 06

BACKS: Semi-attached, blown fiber

PILLOWS: (2) 20" knife-edge pillows w/ welt (P1)

STD FINISH: 007

SEATS: Loose, box-border, Premier standard (SS)

OPT FINISHES: 021, 041, 071

CAP CODES: DR, UR, DP, NP, PS, UE, VS, BU, RL, LL, LM

FEATURES: Decorative wood legs

BATTERY: N/A

SPECIAL INFO: When upholstered in UR cap code fabrics, including select fabric Gail, the front rail will have 2 evenly spaced blind seams on 610/510 prefixes, and 1 evenly spaced blind seam on 620/520 prefixes.

SELECT FABRIC:

SELECT FAUX LEATHER: N/A

SELECT LEATHER:

D1970 Marteon
D2074 Gail
D2093 Artisia

LB2060 Sutton - 32, 54, 77, 87

613 OLSON	GRADE	SELECT			CUSTOM FABRIC				CUSTOM LEATHER / PLUS				AVAILABLE OPTIONS	DIMENSIONS				
		FAB	FAUX LTH	LTH	B-C	D-F, RE	G-N	P-Q	BL	DL	FL	HL		H	W	D	RD	WT
		SH	SW	SD	AH	SF												
610613 Sofa	COST	-	-	-	-	-	-	-	-	-	-	-	DC, FN, FP, P1, Z6	37	83.5	39.5	-	139
	RESALE	1419	-	1969	1579	1739	1899	2059	2289	2819	3359	3889		22	67.5	24	26	3
510613 Queen Sleep Sofa	COST	-	-	-	-	-	-	-	-	-	-	-	DC, FN, FP, MA, MT, P1, Z6	37	83.5	39.5	-	219
	RESALE	1899	-	2449	2059	2219	2379	2539	2769	3299	3829	4369		22	67.5	24	26	3
620613 Apartment-Size Sofa	COST	-	-	-	-	-	-	-	-	-	-	-	DC, FN, FP, P1, Z6	37	75.5	39.5	-	123
	RESALE	1419	-	1969	1579	1739	1899	2059	2289	2819	3359	3889		22	59.5	24	26	3
520613 Full Sleep Sofa	COST	-	-	-	-	-	-	-	-	-	-	-	DC, FN, FP, MA, MT, P1, Z6	37	75.5	39.5	-	209
	RESALE	1839	-	2399	1999	2159	2319	2479	2719	3249	3779	4309		22	59.5	24	26	3
655613 Chair & a Half	COST	-	-	-	-	-	-	-	-	-	-	-	DC, FN, FP, P1, Z6	37	56	39.5	-	107
	RESALE	1259	-	1759	1379	1489	1609	1729	1869	2079	2289	2499		22	39	24	26	2
555613 Twin Sleep Chair	COST	-	-	-	-	-	-	-	-	-	-	-	DC, FN, FP, MA, MT, P1, Z6	37	56	39.5	-	194
	RESALE	1579	-	2079	1699	1809	1929	2049	2189	2399	2609	2819		22	39	24	26	2



General guidance, may not apply to all prefixes. Please refer to Product Info Guide for more detail by prefix.

ORDER FOB'S: 05, 06

BACKS: Tight, foam

PILLOWS: (2) 20" knife-edge w/ welt (P1)

STD FINISH: 007

SEATS: Loose, box-border, Premier standard (SS)

OPT FINISHES: 021, 041, 071

CAP CODES: DR, UR, UE, BU, RL, LL, LM

FEATURES: Decorative wood legs, welt trim on backs, arms, and seats

BATTERY: N/A

SPECIAL INFO: N/A

SELECT FAUX LEATHER: N/A

SELECT LEATHER: N/A

SELECT FABRIC:

C2043 Sheldon

620 PIPER	GRADE	SELECT			CUSTOM FABRIC				CUSTOM LEATHER / PLUS				AVAILABLE OPTIONS	DIMENSIONS				
		FAB	FAUX LTH	LTH	B-C	D-F, RE	G-N	P-Q	BL	DL	FL	HL		H	W	D	RD	WT
		SH	SW	SD	AH	SF												
610620 Sofa	COST	-	-	-	-	-	-	-	-	-	-	-	DC, FN, FP, P1, Z6	37.5	82	37	-	137.5
	RESALE	1219	-	-	1379	1539	1699	1859	1999	2539	3069	3599		21	67.5	22.5	26	3
510620 Queen Sleep Sofa	COST	-	-	-	-	-	-	-	-	-	-	-	DC, FN, FP, MA, MT, P1, Z6	37.5	82	37	-	217.5
	RESALE	1699	-	-	1859	2019	2169	2329	2479	3019	3549	4079		21	67.5	22.5	26	3
630620 Loveseat	COST	-	-	-	-	-	-	-	-	-	-	-	DC, FN, FP, P1, Z6	37.5	59.5	37	-	112.5
	RESALE	1169	-	-	1329	1489	1649	1809	1959	2489	3029	3559		21	45	22.5	26	2
61S620 Sofa w/ Chaise	COST	-	-	-	-	-	-	-	-	-	-	-	DC, FN, FP, P1, Z6	37.5	82	61	-	164.5
	RESALE	1379	-	-	1539	1699	1859	2019	2159	2699	3229	3759		21	67.5	22.5	26	3
51S620 Queen Sleep Sofa w/ Chaise	COST	-	-	-	-	-	-	-	-	-	-	-	DC, FN, FP, MA, MT, P1, Z6	37.5	82	61	-	244.5
	RESALE	1859	-	-	2019	2169	2329	2489	2639	3169	3709	4239		21	67.5	22.5	26	3



General guidance, may not apply to all prefixes. Please refer to Product Info Guide for more detail by prefix.

ORDER FOB'S: 05, 06

BACKS: N/A

PILLOWS: N/A

STD FINISH: N/A

SEATS: N/A

OPT FINISHES: N/A

CAP CODES: DR, UR, DP, NP, PS, UE, VS, BU, RL, LL, LM

FEATURES: Box-border foam lift-top, storage, (4) casters

BATTERY: N/A

SPECIAL INFO: N/A

SELECT FAUX LEATHER: N/A

SELECT LEATHER: N/A

SELECT FABRIC:

D2009 Promise
D2124 i-Westvale
E1917 i-Adario

632 TAHOE	GRADE	SELECT			CUSTOM FABRIC				CUSTOM LEATHER / PLUS				AVAILABLE OPTIONS	DIMENSIONS				
		FAB	FAUX LTH	LTH	B-C	D-F, RE	G-N	P-Q	BL	DL	FL	HL		H	W	D	RD	WT
		SH	SW	SD	AH	SF												
240632 Ottoman	COST	-	-	-	-	-	-	-	-	-	-	-	N/A	21.5	38.5	38.5	-	87
	RESALE	699	-	-	749	799	859	909	1129	1239	1339	1449		-	-	-	-	0.5

General guidance, may not apply to all prefixes. Please refer to Product Info Guide for more detail by prefix.



ORDER FOB'S: 05, 06

STD FINISH: 021

OPT FINISHES: 007

BATTERY: N/A

BACKS: Loose, chambered blown fiber

SEATS: Loose, box-border Premier standard (SS)

CAP CODES: DR, UR, UE, BU, RL, LL, LM

PILLOWS: (2) 20" knife-edge w/ welt (P1)

FEATURES: 6AL, 6AR, 6SC feature (1) Lower storage drawer, decorative surface with hidden wireless charging, and slide-back top that exposes (2) electrical outlets, (1) USB-A port and (1) USB-C port.

SPECIAL INFO: Due to exposed connector brackets, units not suitable for stand-alone pieces. No charge for FN option on this style.

SELECT FABRIC:

SELECT FAUX LEATHER: N/A

SELECT LEATHER: N/A

D2009 Promise
D2124 i-Westvale
E1917 i-Adario

632 TAHOE	GRADE	SELECT			CUSTOM FABRIC				CUSTOM LEATHER / PLUS				AVAILABLE OPTIONS	DIMENSIONS				
		FAB	FAUX LTH	LTH	B-C	D-F, RE	G-N	P-Q	BL	DL	FL	HL		H	W	D	RD	WT
		SH	SW	SD	AH	SF												
6AL632 Left-Arm SITTING Storage Arm	COST	-	-	-	-	-	-	-	-	-	-	-	FN	-	10	38.5	-	59
	RESALE	779	-	-	829	889	939	989	969	1079	1189	1289		-	-	-	25.5	1
60A632 Left-Arm SITTING Chair	COST	-	-	-	-	-	-	-	-	-	-	-	DC, FP, P1, Z6	37	47	38.5	-	100
	RESALE	879	-	-	989	1109	1229	1339	1319	1539	1749	1959		21.5	37.5	23.5	25.5	2
60B632 Right-Arm SITTING Chair	COST	-	-	-	-	-	-	-	-	-	-	-	DC, FP, P1, Z6	37	47	38.5	-	100
	RESALE	879	-	-	989	1109	1229	1339	1319	1539	1749	1959		21.5	37.5	23.5	25.5	2
6AR632 Right-Arm SITTING Storage Arm	COST	-	-	-	-	-	-	-	-	-	-	-	FN	-	10	38.5	-	59
	RESALE	779	-	-	829	889	939	989	969	1079	1189	1289		-	-	-	25.5	1
6CC632 90 Degree Corner Unit	COST	-	-	-	-	-	-	-	-	-	-	-	DC, FP, P1, Z6	37	39.5	39.5	-	79
	RESALE	879	-	-	1039	1199	1359	1519	1169	1709	2239	2769		21.5	-	23.5	-	2
60M632 Sectional Armless Chair	COST	-	-	-	-	-	-	-	-	-	-	-	DC, Z6	37	37	-	-	72
	RESALE	759	-	-	879	989	1109	1229	1029	1239	1449	1659		21.5	36.5	23.5	-	2
6MM632 Armless Loveseat	COST	-	-	-	-	-	-	-	-	-	-	-	DC, Z6	37	74.5	38.5	-	111
	RESALE	1039	-	-	1199	1359	1519	1669	1519	2049	2579	3109		21.5	74	23.5	-	3
6SC632 Storage Console	COST	-	-	-	-	-	-	-	-	-	-	-	FN	25.5	10	38.5	-	59
	RESALE	779	-	-	829	889	939	989	969	1079	1189	1289		-	-	-	-	1

General guidance, may not apply to all prefixes. Please refer to Product Info Guide for more detail by prefix.



ORDER FOB'S: 05, 06

BACKS: Semi-attached, box-border, blown fiber

PILLOWS: (2) 20" knife-edge w/ welt (P1)

STD FINISH: 007

SEATS: Loose, box-border Premier standard (SS)

OPT FINISHES: 021, 041

CAP CODES: DR, UR, DP, NP, PS, UE, VS, BU, RL, LL, LM

FEATURES: Decorative wood legs

BATTERY: N/A

SPECIAL INFO: When upholstered in UR cap code fabrics, including select fabric Gail, the front rail will have 2 evenly spaced blind seams on 610/510 prefixes, and 1 evenly spaced blind seam on 620/520 prefixes.

SELECT FABRIC:

SELECT FAUX LEATHER: N/A

SELECT LEATHER:

D1970 Marteon
D2074 Gail
D2093 Artisia

LB2060 Sutton - 32, 54, 77, 87

636 SHILOH	GRADE	SELECT			CUSTOM FABRIC				CUSTOM LEATHER / PLUS				AVAILABLE OPTIONS	DIMENSIONS				
		FAB	FAUX LTH	LTH	B-C	D-F, RE	G-N	P-Q	BL	DL	FL	HL		H	W	D	RD	WT
		SH	SW	SD	AH	SF												
610636 Sofa	COST	-	-	-	-	-	-	-	-	-	-	-	DC, FN, FP, P1, Z6	37	80.5	39	-	155
	RESALE	1419	-	1969	1579	1739	1899	2059	2289	2819	3359	3889		22	67.5	22	26	3
510636 Queen Sleep Sofa	COST	-	-	-	-	-	-	-	-	-	-	-	DC, FN, FP, MA, MT, P1, Z6	37	80.5	39	-	235
	RESALE	1899	-	2449	2059	2219	2379	2539	2769	3299	3829	4369		22	67.5	22	26	3
620636 Apartment-Size Sofa	COST	-	-	-	-	-	-	-	-	-	-	-	DC, FN, FP, P1, Z6	37	72.5	39	-	135
	RESALE	1419	-	1969	1579	1739	1899	2059	2289	2819	3359	3889		22	59.5	22	26	3
520636 Full Sleep Sofa	COST	-	-	-	-	-	-	-	-	-	-	-	DC, FN, FP, MA, MT, P1, Z6	37	72.5	39	-	225
	RESALE	1839	-	2399	1999	2159	2319	2479	2719	3249	3779	4309		22	59.5	22	26	3
655636 Chair & a Half	COST	-	-	-	-	-	-	-	-	-	-	-	DC, FN, FP, P1, Z6	37	52.5	39	-	123
	RESALE	1259	-	1759	1379	1489	1609	1729	1869	2079	2289	2499		22	39	22	26	2
555636 Twin Sleep Chair	COST	-	-	-	-	-	-	-	-	-	-	-	DC, FN, FP, MA, MT, P1, Z6	37	52.5	39	-	210
	RESALE	1579	-	2079	1699	1809	1929	2049	2189	2399	2609	2819		22	39	22	26	2

General guidance, may not apply to all prefixes. Please refer to Product Info Guide for more detail by prefix.



ORDER FOB'S: 05, 06

BACKS: Loose, bullnose chambered blown fiber

PILLOWS: 18" knife-edge w/ welt (P1)

STD FINISH: 007

SEATS: Box-border, Premier standard (SS)

OPT FINISHES: 021, 041, 071

CAP CODES: DR, UR, UE, BU, RL, LL, LM

FEATURES: Decorative wood legs

BATTERY: N/A

SPECIAL INFO: N/A

SELECT FAUX LEATHER: N/A

SELECT LEATHER:

D1970 Marteon
D2074 Gail
D2093 Artisia

LB2060 Sutton - 32, 54, 77, 87

638 CHARLIE	GRADE	SELECT			CUSTOM FABRIC				CUSTOM LEATHER / PLUS				AVAILABLE OPTIONS	DIMENSIONS				
		FAB	FAUX LTH	LTH	B-C	D-F, RE	G-N	P-Q	BL	DL	FL	HL		H	W	D	RD	WT
		SH	SW	SD	AH	SF												
60A638 Left-Arm SITTING Chair	COST	-	-	-	-	-	-	-	-	-	-	-	DC, FN, FP, P1, Z6	37	37	38.5	-	75
	RESALE	749	-	1019	869	979	1099	1219	1119	1329	1549	1759		21.5	31	21.5	25	1
60B638 Right-Arm SITTING Chair	COST	-	-	-	-	-	-	-	-	-	-	-	DC, FN, FP, P1, Z6	37	37	38.5	-	75
	RESALE	749	-	1019	869	979	1099	1219	1119	1329	1549	1759		21.5	31	21.5	25	1
60C638 Rounded Corner Unit	COST	-	-	-	-	-	-	-	-	-	-	-	DC, FN, FP, P1, Z6	37	59.5	37	-	74
	RESALE	959	-	1239	1119	1279	1439	1599	1559	2089	2619	3149		21	-	22.5	-	2
60CC638 90 Degree Corner Unit	COST	-	-	-	-	-	-	-	-	-	-	-	DC, FN, FP, P1, Z6	37	52.5	37	-	62
	RESALE	919	-	1189	1079	1239	1399	1559	1499	2039	2569	3099		21	-	29.5	-	1
60D638 Left-Arm SITTING Loveseat	COST	-	-	-	-	-	-	-	-	-	-	-	DC, FN, FP, P1, Z6	37	68.5	38.5	-	114
	RESALE	1069	-	1459	1229	1389	1549	1709	1779	2309	2839	3379		21.5	62.5	21.5	25	2
60E638 Right-Arm SITTING Loveseat	COST	-	-	-	-	-	-	-	-	-	-	-	DC, FN, FP, P1, Z6	37	68.5	38.5	-	114
	RESALE	1069	-	1459	1229	1389	1549	1709	1779	2309	2839	3379		21.5	62.5	21.5	25	2
60L638 Left-Arm SITTING Chaise	COST	-	-	-	-	-	-	-	-	-	-	-	DC, FN, FP, P1, Z6	37	37.5	63.5	-	117
	RESALE	1069	-	1459	1229	1389	1549	1709	1779	2309	2839	3379		21.5	31.5	47	25	2
60R638 Right-Arm SITTING Chaise	COST	-	-	-	-	-	-	-	-	-	-	-	DC, FN, FP, P1, Z6	37	37.5	63.5	-	117
	RESALE	1069	-	1459	1229	1389	1549	1709	1779	2309	2839	3379		21.5	31.5	47	25	2
60M638 Sectional Armless Chair	COST	-	-	-	-	-	-	-	-	-	-	-	DC, FN, Z6	37	32	38	-	53
	RESALE	639	-	819	759	879	989	1109	929	1139	1359	1569		21.5	32	20.5	-	1
6MM638 Armless Loveseat	COST	-	-	-	-	-	-	-	-	-	-	-	DC, FN, Z6	37	62.5	38	-	91
	RESALE	959	-	1319	1119	1279	1439	1599	1639	2169	2709	3239		21.5	62.5	21	-	2
6SL638 Left-Arm SITTING Chaise w/ Storage	COST	-	-	-	-	-	-	-	-	-	-	-	DC, FN, FP, P1, Z6	37	37.5	63.5	-	162
	RESALE	1229	-	1619	1389	1549	1709	1869	1939	2469	2999	3539		21.5	31.5	47	25	2
6SR638 Right-Arm SITTING Chaise w/ Storage	COST	-	-	-	-	-	-	-	-	-	-	-	DC, FN, FP, P1, Z6	37	37.5	63.5	-	162
	RESALE	1229	-	1619	1389	1549	1709	1869	1939	2469	2999	3539		21.5	31.5	47	25	2
6SP638 Armless Full Sleeper	COST	-	-	-	-	-	-	-	-	-	-	-	DC, FN, MA, MT, Z6	37	62.5	38	-	150
	RESALE	1329	-	1699	1489	1649	1809	1969	2019	2549	3079	3609		21.5	62.5	21	-	2

General guidance, may not apply to all prefixes. Please refer to Product Info Guide for more detail by prefix.



ORDER FOB'S: 05, 06

BACKS: Loose, bullnose chambered blown fiber

PILLOWS: 18" knife-edge w/ welt (P1)

STD FINISH: 007

SEATS: Loose, box-border Premier standard (SS)

OPT FINISHES: 021, 041, 071

CAP CODES: DR, UR, UE, BU, RL, LL, LM

FEATURES: Decorative wood legs

BATTERY: N/A

SPECIAL INFO: When upholstered in UR cap code fabrics, including select fabric Gail, the front rail will have 2 evenly spaced blind seams on 610/510 prefixes, and 1 evenly spaced blind seam on 620/520 prefixes.

SELECT FABRIC:

SELECT FAUX LEATHER: N/A

SELECT LEATHER:

D1970 Marteon
D2074 Gail
D2093 Artisia

LB2060 Sutton - 32, 54, 77, 87

638 CHARLIE	GRADE	SELECT			CUSTOM FABRIC				CUSTOM LEATHER / PLUS				AVAILABLE OPTIONS	DIMENSIONS				
		FAB	FAUX LTH	LTH	B-C	D-F, RE	G-N	P-Q	BL	DL	FL	HL		H	W	D	RD	WT
		SH	SW	SD	AH	SF												
610638 Sofa	COST	-	-	-	-	-	-	-	-	-	-	-	DC, FN, FP, P1, Z6	37	79	38	-	145
	RESALE	1419	-	1969	1579	1739	1899	2059	2289	2819	3359	3889		21.5	67.5	21.5	25	3
510638 Queen Sleep Sofa	COST	-	-	-	-	-	-	-	-	-	-	-	DC, FN, FP, MA, MT, P1, Z6	37	79	38	-	225
	RESALE	1899	-	2449	2059	2219	2379	2539	2769	3299	3829	4369		21.5	67.5	21.5	25	3
620638 Apartment-Size Sofa	COST	-	-	-	-	-	-	-	-	-	-	-	DC, FN, FP, P1, Z6	37	71	38	-	125
	RESALE	1419	-	1969	1579	1739	1899	2059	2289	2819	3359	3889		21.5	59.5	21.5	25	3
520638 Full Sleep Sofa	COST	-	-	-	-	-	-	-	-	-	-	-	DC, FN, FP, MA, MT, P1, Z6	37	71	38	-	215
	RESALE	1839	-	2399	1999	2159	2319	2479	2719	3249	3779	4309		21.5	59.5	21.5	25	3
655638 Chair & a Half	COST	-	-	-	-	-	-	-	-	-	-	-	DC, FN, FP, P1, Z6	37	50.5	38	-	113
	RESALE	1259	-	1759	1379	1489	1609	1729	1869	2079	2289	2499		21.5	39	21.5	25	2
555638 Twin Sleep Chair	COST	-	-	-	-	-	-	-	-	-	-	-	DC, FN, FP, MA, MT, P1, Z6	37	50.5	38	-	200
	RESALE	1579	-	2079	1699	1809	1929	2049	2189	2399	2609	2819		21.5	39	21.5	25	2
240638 Ottoman	COST	-	-	-	-	-	-	-	-	-	-	-	FN	19	41	26.5	-	40
	RESALE	439	-	759	489	549	599	649	809	919	1029	1129		-	-	-	-	0.5

General guidance, may not apply to all prefixes. Please refer to Product Info Guide for more detail by prefix.

ORDER FOB'S: 05, 06

BACKS: Loose, chambered blown fiber

PILLOWS: 20" knife-edge w/ welt (P1)

STD FINISH: 007

SEATS: Loose, box-border t-seat, Premier standard (SS)



OPT FINISHES: 021, 041, 071

CAP CODES: DR, UR, UE, BU, RL, LL, LM

FEATURES: Decorative wood legs, welt trim on backs, arms, and seats

BATTERY: N/A

SPECIAL INFO: Due to exposed connector brackets, units not suitable for stand-alone pieces.

SELECT FABRIC:

SELECT FAUX LEATHER: N/A

SELECT LEATHER: N/A

D2101 Novan

663 PAXTON	GRADE	SELECT			CUSTOM FABRIC				CUSTOM LEATHER / PLUS				AVAILABLE OPTIONS	DIMENSIONS				
		FAB	FAUX LTH	LTH	B-C	D-F, RE	G-N	P-Q	BL	DL	FL	HL		H	W	D	RD	WT
		SH	SW	SD	AH	SF												
60A663 Left-Arm SITTING Chair	COST	-	-	-	-	-	-	-	-	-	-	-	DC, FN, FP, P1, Z6	38	45	42	-	101
	RESALE	909	-	-	1029	1139	1259	1379	1389	1599	1809	2029		20.5	36.5	25	25	2
60B663 Right-Arm SITTING Chair	COST	-	-	-	-	-	-	-	-	-	-	-	DC, FN, FP, P1, Z6	38	45	42	-	101
	RESALE	909	-	-	1029	1139	1259	1379	1389	1599	1809	2029		20.5	36.5	25	25	2
6CC663 90 Degree Corner Unit	COST	-	-	-	-	-	-	-	-	-	-	-	DC, FN, FP, P1, Z6	38	68	42	-	88
	RESALE	1059	-	-	1219	1379	1539	1699	1549	2079	2609	3139		20.5	-	25	-	2
60L663 Left-Arm SITTING Chaise	COST	-	-	-	-	-	-	-	-	-	-	-	DC, FN, FP, P1, Z6	38	45	66.5	-	135
	RESALE	1259	-	-	1419	1579	1739	1899	1879	2409	2939	3469		20.5	36.5	50	25	2
60M663 Sectional Armless Chair	COST	-	-	-	-	-	-	-	-	-	-	-	DC, FN, Z6	38	40	42	-	77
	RESALE	809	-	-	929	1049	1159	1279	1159	1379	1589	1799		20.5	40	25	-	2
60R663 Right-Arm SITTING Chaise	COST	-	-	-	-	-	-	-	-	-	-	-	DC, FN, FP, P1, Z6	38	45	66.5	-	135
	RESALE	1259	-	-	1419	1579	1739	1899	1879	2409	2939	3469		20.5	36.5	50	25	2



General guidance, may not apply to all prefixes. Please refer to Product Info Guide for more detail by prefix.

ORDER FOB'S: 05, 06

STD FINISH: 007

OPT FINISHES: 021, 041, 071

BATTERY: N/A

SPECIAL INFO: N/A

SELECT FABRIC:

D2101 Novan

BACKS: Loose, chambered blown fiber

SEATS: Loose, box-border t-seat, Premier standard (SS)

CAP CODES: DR, UR, UE, BU, RL, LL, LM

SELECT FAUX LEATHER: N/A

PILLOWS: (2) 20" knife-edge w/ welt (P1)

FEATURES: Decorative wood legs, welt trim on backs, arms, and seats

SELECT LEATHER: N/A

663 PAXTON	GRADE	SELECT			CUSTOM FABRIC				CUSTOM LEATHER / PLUS				AVAILABLE OPTIONS	DIMENSIONS				
		FAB	FAUX LTH	LTH	B-C	D-F, RE	G-N	P-Q	BL	DL	FL	HL		H	W	D	RD	WT
		SH	SW	SD	AH	SF												
610663 Sofa	COST	-	-	-	-	-	-	-	-	-	-	-	DC, FN, FP, P1, Z6	38	88	42	-	179
	RESALE	1709	-	-	1869	2029	2189	2339	2629	3159	3699	4229		20.5	72	25	25	3
630663 Loveseat	COST	-	-	-	-	-	-	-	-	-	-	-	DC, FN, FP, P1, Z6	38	64	42	-	154
	RESALE	1659	-	-	1819	1979	2139	2299	2589	3119	3649	4189		20.5	48	25	25	2
655663 Chair & a Half	COST	-	-	-	-	-	-	-	-	-	-	-	DC, FN, FP, P1, Z6	38	52	42	-	143
	RESALE	1549	-	-	1659	1779	1899	2019	2419	2629	2839	3059		20.5	36	25	25	2
240663 Ottoman	COST	-	-	-	-	-	-	-	-	-	-	-	FN	19	41	26.5	-	38
	RESALE	649	-	-	709	759	809	869	1109	1219	1319	1429		-	-	-	-	0.5

General guidance, may not apply to all prefixes. Please refer to Product Info Guide for more detail by prefix.

ORDER FOB'S: 05, 06

STD FINISH: N/A

OPT FINISHES: N/A

BATTERY: N/A

SPECIAL INFO: Due to exposed connector brackets, units not suitable for stand-alone pieces.

SELECT FABRIC:

D1807 Fairfax
D2101 Novan

BACKS: Loose, chambered blown fiber

SEATS: Loose, box-border t-seat, Premier standard (SS)

CAP CODES: DR, UR, UE, BU, RL, LL, LM

SELECT FAUX LEATHER: N/A

PILLOWS: 20" knife-edge w/ welt (P1)

FEATURES: Welt trim on backs, arms, and seats

SELECT LEATHER: N/A



665 ALANI	GRADE	SELECT			CUSTOM FABRIC				CUSTOM LEATHER / PLUS				AVAILABLE OPTIONS	DIMENSIONS				
		FAB	FAUX LTH	LTH	B-C	D-F, RE	G-N	P-Q	BL	DL	FL	HL		H	W	D	RD	WT
		SH	SW	SD	AH	SF												
60A665 Left-Arm SITTING Chair	COST	-	-	-	-	-	-	-	-	-	-	-	DC, FP, P1, Z6	38	46	42	-	104
	RESALE	909	-	-	1029	1139	1259	1379	1389	1599	1809	2029		21	36	24	26.5	2
60B665 Right-Arm SITTING Chair	COST	-	-	-	-	-	-	-	-	-	-	-	DC, FP, P1, Z6	38	46	42	-	104
	RESALE	909	-	-	1029	1139	1259	1379	1389	1599	1809	2029		21	36	24	26.5	2

665 ALANI	GRADE	SELECT			CUSTOM FABRIC				CUSTOM LEATHER / PLUS				AVAILABLE OPTIONS	DIMENSIONS				
		FAB	FAUX LTH	LTH	B-C	D-F, RE	G-N	P-Q	BL	DL	FL	HL		H	W	D	RD	WT
		SH	SW	SD	AH	SF												
6CC665 90 Degree Corner Unit	COST	-	-	-	-	-	-	-	-	-	-	-	DC, FP, P1, Z6	38	68	42	-	98
	RESALE	1059	-	-	1219	1379	1539	1699	1549	2079	2609	3139		21	-	25	-	2
60M665 Sectional Armless Chair	COST	-	-	-	-	-	-	-	-	-	-	-	DC, Z6	38	40.5	42	-	80
	RESALE	809	-	-	929	1049	1159	1279	1159	1379	1589	1799		21	40.5	24	-	2
60L665 Left-Arm SITTING Chaise	COST	-	-	-	-	-	-	-	-	-	-	-	DC, FP, P1, Z6	38	46	66	-	140
	RESALE	1259	-	-	1419	1579	1739	1899	1879	2409	2939	3469		21	36	48	26.5	2
60R665 Right-Arm SITTING Chaise	COST	-	-	-	-	-	-	-	-	-	-	-	DC, FP, P1, Z6	38	46	66	-	146
	RESALE	1259	-	-	1419	1579	1739	1899	1879	2409	2939	3469		21	36	48	26.5	2

General guidance, may not apply to all prefixes. Please refer to Product Info Guide for more detail by prefix.

ORDER FOB'S: 05, 06

BACKS: Box-border, semi-attached blown fiber **PILLOWS:** N/A

STD FINISH: N/A

SEATS: Box-border foam, loose (SS)

OPT FINISHES: N/A

CAP CODES: DR, UR, UE, BU, RL

FEATURES: N/A

BATTERY: N/A

SPECIAL INFO: N/A

SELECT FABRIC:

SELECT FAUX LEATHER: N/A

SELECT LEATHER: N/A

C2119 Longmont
C2122 Taber

NEW!



677 LAUREN	GRADE	SELECT			CUSTOM FABRIC				CUSTOM LEATHER / PLUS				AVAILABLE OPTIONS	DIMENSIONS				
		FAB	FAUX LTH	LTH	B-C	D-F, RE	G-N	P-Q	BL	DL	FL	HL		H	W	D	RD	WT
		SH	SW	SD	AH	SF												
NEW! 061677 Sofa	COST	-	-	-	-	-	-	-	-	-	-	-	N/A	38.5	78.5	39	-	132
	RESALE	879	-	-	1039	1199	1359	1519	-	-	-	-		21.5	67.5	22	25	-
NEW! 063677 Loveseat	COST	-	-	-	-	-	-	-	-	-	-	-	N/A	38.5	56	39	-	107
	RESALE	829	-	-	989	1149	1309	1469	-	-	-	-		21.5	45	22	25	-
NEW! 023677 Chair	COST	-	-	-	-	-	-	-	-	-	-	-	N/A	38.5	33.5	39	-	68
	RESALE	589	-	-	709	819	939	1059	-	-	-	-		21.5	22.5	22	25	-
NEW! 024677 Ottoman	COST	-	-	-	-	-	-	-	-	-	-	-	N/A	19.5	29	22	-	25
	RESALE	329	-	-	389	439	489	549	-	-	-	-		-	-	-	-	-

NEW!



General guidance, may not apply to all prefixes. Please refer to Product Info Guide for more detail by prefix.

ORDER FOB'S: 05, 06
BACKS: Semi-attached blown fiber, knife-edge
PILLOWS: N/A
STD FINISH: N/A
SEATS: Box-border foam, loose (SS)
OPT FINISHES: N/A
CAP CODES: DR, UR, UE, BU, RL
FEATURES: N/A
BATTERY: N/A
SPECIAL INFO: N/A
SELECT FABRIC: C2119 Longmont
 C2122 Taber
SELECT FAUX LEATHER: N/A
SELECT LEATHER: N/A

678 FLEETWOOD	GRADE	SELECT			CUSTOM FABRIC				CUSTOM LEATHER / PLUS				AVAILABLE OPTIONS	DIMENSIONS				
		FAB	FAUX LTH	LTH	B-C	D-F, RE	G-N	P-Q	BL	DL	FL	HL		H	W	D	RD	WT
		SH	SW	SD	AH	SF												
NEW! 061678 Sofa	COST	-	-	-	-	-	-	-	-	-	-	-	N/A	37	81	38	-	124
	RESALE	879	-	-	1039	1199	1359	1519	-	-	-	-		20.5	67.5	22	25	-
NEW! 063678 Loveseat	COST	-	-	-	-	-	-	-	-	-	-	N/A	37	58.5	38	-	99	
	RESALE	829	-	-	989	1149	1309	1469	-	-	-		-	20.5	45	22	25	-
NEW! 023678 Chair	COST	-	-	-	-	-	-	-	-	-	-	N/A	37	36	38	-	60	
	RESALE	589	-	-	709	819	939	1059	-	-	-		-	20.5	22	22	25	-
NEW! 024678 Ottoman	COST	-	-	-	-	-	-	-	-	-	-	N/A	19.5	29	22	-	25	
	RESALE	329	-	-	389	439	489	549	-	-	-		-	-	-	-	-	-

General guidance, may not apply to all prefixes. Please refer to Product Info Guide for more detail by prefix.



ORDER FOB'S: 05, 06
BACKS: Semi-attached, chambered blown fiber
PILLOWS: (2) 18" knife-edge w/ welt (P1)
STD FINISH: 007
SEATS: Loose, box-border, Premier standard (SS)
OPT FINISHES: 021, 041, 071
CAP CODES: DR, UR, DP, NP, PS, UE, VS, BU, RL
FEATURES: Decorative wood legs, welt trim on backs, arms, seats, and front rail
BATTERY: N/A
SPECIAL INFO: Ordering NB, NH, or NS option adds small nail head trim to the front arm posts and large nails to the front rail.
SELECT FABRIC: D2009 Promise
 D2071 i-Rockport
SELECT FAUX LEATHER: N/A
SELECT LEATHER: N/A

681 BEXLEY	GRADE	SELECT			CUSTOM FABRIC				CUSTOM LEATHER / PLUS				AVAILABLE OPTIONS	DIMENSIONS				
		FAB	FAUX LTH	LTH	B-C	D-F, RE	G-N	P-Q	BL	DL	FL	HL		H	W	D	RD	WT
		SH	SW	SD	AH	SF												
610681 Sofa	COST	-	-	-	-	-	-	-	-	-	-	-	DC, FN, FP, NB, NH, NS, P1, Z6	38	82	38.5	-	137
	RESALE	1489	-	-	1649	1809	1969	2129	-	-	-	-		21.5	67.5	20	27	3
510681 Queen Sleep Sofa	COST	-	-	-	-	-	-	-	-	-	-	-	DC, FN, FP, MA, MT, NB, NH, NS, P1, Z6	38	82	38.5	-	217
	RESALE	1969	-	-	2129	2289	2449	2609	-	-	-	-		21.5	67.5	20	27	3

681 BEXLEY	GRADE	SELECT			CUSTOM FABRIC				CUSTOM LEATHER / PLUS				AVAILABLE OPTIONS	DIMENSIONS				
		FAB	FAUX LTH	LTH	B-C	D-F, RE	G-N	P-Q	BL	DL	FL	HL		H	W	D	RD	WT
		SH	SW	SD	AH	SF												
630681 Loveseat	COST	-	-	-	-	-	-	-	-	-	-	-	DC, FN, FP, NB, NH, NS, P1, Z6	38	59.5	38.5	-	117
	RESALE	1449	-	-	1609	1769	1929	2089	-	-	-	-		21.5	45	20	27	2

General guidance, may not apply to all prefixes. Please refer to Product Info Guide for more detail by prefix.

ORDER FOB'S: 05, 06

BACKS: Semi-attached, chambered blown fiber

PILLOWS: 20" knife-edge w/ welt (P1)

STD FINISH: 007

SEATS: Loose, box-border, Premier standard (SS)

OPT FINISHES: 021

CAP CODES: DR, UR, DP, NP, PS, UE, VS, BU, RL, LL, LM

FEATURES: Decorative wood legs, welt trim on the backs, arms, seats, and front rail

BATTERY: N/A

SPECIAL INFO: Due to exposed connector brackets, units not suitable for stand-alone pieces.

SELECT FABRIC:

SELECT FAUX LEATHER: N/A

SELECT LEATHER: N/A

C1965 Nora
D2099 i-Favorite



694 MEYER	GRADE	SELECT			CUSTOM FABRIC				CUSTOM LEATHER / PLUS				AVAILABLE OPTIONS	DIMENSIONS				
		FAB	FAUX LTH	LTH	B-C	D-F, RE	G-N	P-Q	BL	DL	FL	HL		H	W	D	RD	WT
		SH	SW	SD	AH	SF												
60A694 Left-Arm SITTING Chair	COST	-	-	-	-	-	-	-	-	-	-	-	DC, FN, FP, P1, Z6	37.5	31	39	-	86
	RESALE	779	-	-	899	1019	1129	1249	1229	1439	1649	1869		22	24	23.5	26	2
60B694 Right-Arm SITTING Chair	COST	-	-	-	-	-	-	-	-	-	-	-	DC, FN, FP, P1, Z6	37.5	31	39	-	86
	RESALE	779	-	-	899	1019	1129	1249	1229	1439	1649	1869		22	24	23.5	26	2
60C694 Rounded Corner Unit	COST	-	-	-	-	-	-	-	-	-	-	-	DC, FN, FP, P1, Z6	37.5	67	39	-	85
	RESALE	989	-	-	1149	1309	1469	1629	1529	2059	2589	3119		22	-	25	-	2
60CC694 90 Degree Corner Unit	COST	-	-	-	-	-	-	-	-	-	-	-	DC, FN, FP, P1, Z6	37.5	53	39	-	80
	RESALE	949	-	-	1109	1269	1429	1589	1469	1999	2539	3069		22	-	23.5	-	1
60D694 Left-Arm SITTING Loveseat	COST	-	-	-	-	-	-	-	-	-	-	-	DC, FN, FP, P1, Z6	37.5	55	39	-	115
	RESALE	1119	-	-	1279	1439	1599	1759	1839	2379	2909	3439		22	48	23.5	26	2
60E694 Right-Arm SITTING Loveseat	COST	-	-	-	-	-	-	-	-	-	-	-	DC, FN, FP, P1, Z6	37.5	55	39	-	115
	RESALE	1119	-	-	1279	1439	1599	1759	1839	2379	2909	3439		22	48	23.5	26	2
60L694 Left-Arm SITTING Chaise	COST	-	-	-	-	-	-	-	-	-	-	-	DC, FN, FP, P1, Z6	37.5	31	64	-	105
	RESALE	1119	-	-	1279	1439	1599	1759	1729	2259	2789	3319		22	24	48	26	2
60M694 Sectional Armless Chair	COST	-	-	-	-	-	-	-	-	-	-	-	DC, FN, Z6	37.5	24	39	-	67
	RESALE	659	-	-	779	899	1019	1129	1049	1259	1469	1689		22	24	23.5	-	1
60MM694 Armless Loveseat	COST	-	-	-	-	-	-	-	-	-	-	-	DC, FN, Z6	37.5	63	39	-	111
	RESALE	1189	-	-	1339	1499	1659	1819	1739	2269	2799	3329		22	63	23.5	-	2
60R694 Right-Arm SITTING Chaise	COST	-	-	-	-	-	-	-	-	-	-	-	DC, FN, FP, Z6	37.5	31	64	-	105
	RESALE	1119	-	-	1279	1439	1599	1759	1729	2259	2789	3319		22	24	48	26	2

694 MEYER	GRADE	SELECT			CUSTOM FABRIC				CUSTOM LEATHER / PLUS				AVAILABLE OPTIONS	DIMENSIONS				
		FAB	FAUX LTH	LTH	B-C	D-F, RE	G-N	P-Q	BL	DL	FL	HL		H	W	D	RD	WT
		SH	SW	SD	AH	SF												
6SC694 Storage Console	COST	-	-	-	-	-	-	-	-	-	-	-	FN	25.5	10	38.5	-	59
	RESALE	799	-	-	859	909	959	1019	969	1079	1189	1289		-	-	-	-	1
6SL694 Left-Arm SITTING Chaise w/ Storage	COST	-	-	-	-	-	-	-	-	-	-	-	DC, FN, FP, P1, Z6	37.5	39	64	-	165
	RESALE	1279	-	-	1439	1599	1759	1919	1889	2419	2949	3479		22	30	48	26	2
6SR694 Right-Arm SITTING Chaise w/ Storage	COST	-	-	-	-	-	-	-	-	-	-	-	DC, FN, FP, P1, Z6	37.5	39	64	-	165
	RESALE	1279	-	-	1439	1599	1759	1919	1889	2419	2949	3479		22	30	48	26	2

General guidance, may not apply to all prefixes. Please refer to Product Info Guide for more detail by prefix.



ORDER FOB'S: 05, 06

STD FINISH: 007

OPT FINISHES: 021

BATTERY: N/A

SPECIAL INFO: N/A

SELECT FABRIC:

C1965 Nora
D2099 i-Favorite

BACKS: Semi-attached, chambered blown fiber

SEATS: Loose, box-border, Premier standard (SS)

CAP CODES: DR, UR, DP, NP, PS, UE, VS, BU, RL, LL, LM

SELECT FAUX LEATHER: N/A

PILLOWS: (2) 20" knife-edge w/ welt (P1)

FEATURES: Decorative wood legs, welt trim on the backs, arms, seats, and front rail

SELECT LEATHER: N/A

694 MEYER	GRADE	SELECT			CUSTOM FABRIC				CUSTOM LEATHER / PLUS				AVAILABLE OPTIONS	DIMENSIONS				
		FAB	FAUX LTH	LTH	B-C	D-F, RE	G-N	P-Q	BL	DL	FL	HL		H	W	D	RD	WT
		SH	SW	SD	AH	SF												
610694 Sofa	COST	-	-	-	-	-	-	-	-	-	-	-	DC, FN, FP, P1, Z6	37.5	86	39	-	166
	RESALE	1579	-	-	1739	1899	2059	2219	2629	3159	3699	4229		22	72	23.5	26	3
630694 Loveseat	COST	-	-	-	-	-	-	-	-	-	-	-	DC, FN, FP, P1, Z6	37.5	62	39	-	132
	RESALE	1539	-	-	1699	1859	2019	2169	2589	3119	3649	4189		22	48	23.5	26	2
230694 Chair	COST	-	-	-	-	-	-	-	-	-	-	-	DC, FN, Z6	37.5	38	39	-	102
	RESALE	949	-	-	1069	1189	1299	1419	1619	1829	2049	2259		22	24	23.5	26	1
240694 Ottoman	COST	-	-	-	-	-	-	-	-	-	-	-	FN	18	30.5	23.5	-	29
	RESALE	539	-	-	589	639	699	749	859	959	1069	1169		-	-	-	-	0.5



General guidance, may not apply to all prefixes. Please refer to Product Info Guide for more detail by prefix.

ORDER FOB'S: 05, 06

BACKS: Foam

SWIVEL: 088123, 088124, 088126, 08812T

STD FINISH: 007

SEATS: Faux box-border chaise seat (SS) and footrest.

TALL: 088210, 088266

OPT FINISHES: 021

CAP CODES: DR, UR, DP, NP, PS, UE, VS, BU, RL, LL, LM

FEATURES: N/A

BATTERY: 088BP1

SPECIAL INFO: N/A

SELECT FABRIC:

SELECT FAUX LEATHER: N/A

SELECT LEATHER: N/A

C2042 Duffey
C2043 Sheldon

700 WYNNE	GRADE	SELECT			CUSTOM FABRIC				CUSTOM LEATHER / PLUS				AVAILABLE OPTIONS	DIMENSIONS				
		FAB	FAUX LTH	LTH	B-C	D-F, RE	G-N	P-Q	BL	DL	FL	HL		H	W	D	RD	WT
		SH	SW	SD	AH	SF												
010700 Rocking Recliner	COST	-	-	-	-	-	-	-	-	-	-	-	ES, FN, FS, H1, H3, L1, L3, LE, LS, SW	42	31.5	37.5	11	81
	RESALE	789	-	-	909	1029	1139	1259	1099	1309	1529	1739		20	22	21.5	25	1
10U700 Power Rocking Recliner w/ Headrest	COST	-	-	-	-	-	-	-	-	-	-	-	FN, FS, LW, SL	42	29.5	37.5	13	100
	RESALE	1379	-	-	1489	1609	1729	1839	1689	1899	2109	2319		20	22	21.5	25	1
10X700 Power Rocking Recliner w/ Headrest & Lumbar	COST	-	-	-	-	-	-	-	-	-	-	-	FN, FS, LW, SL	42	29.5	37.5	13.5	106
	RESALE	1539	-	-	1649	1769	1889	1999	1839	2059	2269	2479		20	22	21.5	25	1
016700 Wall Recliner	COST	-	-	-	-	-	-	-	-	-	-	-	ES, FN, FS, H1, H3, L1, L3, LS, SW	42	31.5	37.5	4.5	91
	RESALE	819	-	-	939	1059	1169	1289	1129	1339	1559	1769		20	22	21.5	25	1
16X700 Power Wall Recliner w/ Headrest & Lumbar	COST	-	-	-	-	-	-	-	-	-	-	-	FS, LW	42	29.5	37.5	6.5	111
	RESALE	1569	-	-	1689	1799	1919	2039	1879	2089	2299	2519		20	22	21.5	25	1
017700 Swivel Gliding Recliner	COST	-	-	-	-	-	-	-	-	-	-	-	ES, FN, FS, H1, H3, L1, L3, LE, LS	42	31.5	37.5	11	115
	RESALE	949	-	-	1069	1189	1299	1419	1259	1469	1689	1899		20	22	21.5	25	1



General guidance, may not apply to all prefixes. Please refer to Product Info Guide for more detail by prefix.

ORDER FOB'S: 05, 06

BACKS: Blown fiber

SWIVEL: 088123, 088124, 088126, 08812T

STD FINISH: 007

SEATS: Standard chaise (SS)

TALL: 088210, 088266

OPT FINISHES: 021

CAP CODES: DR, UR, UE, BU, RL, LL, LM

FEATURES: N/A

BATTERY: 088BP1

SPECIAL INFO: N/A

SELECT FAUX LEATHER: N/A

SELECT LEATHER: N/A

SELECT FABRIC:

C1809 Donegal

704 REED	GRADE	SELECT			CUSTOM FABRIC				CUSTOM LEATHER / PLUS				AVAILABLE OPTIONS	DIMENSIONS				
		FAB	FAUX LTH	LTH	B-C	D-F, RE	G-N	P-Q	BL	DL	FL	HL		H	W	D	RD	WT
		SH	SW	SD	AH	SF												
010704 Rocking Recliner	COST	-	-	-	-	-	-	-	-	-	-	-	ES, FN, FS, H1, H3, L1, L3, LE, LS, SW	40.5	36	37.5	13	70
	RESALE	579	-	-	699	809	929	1049	939	1149	1369	1579		19	19	21	23.5	1
10U704 Power Rocking Recliner w/ Headrest	COST	-	-	-	-	-	-	-	-	-	-	-	FN, FS, LW, SL	40.5	34	37.5	13	93
	RESALE	1159	-	-	1279	1399	1519	1629	1529	1739	1949	2159		19	19	21	23.5	1
10X704 Power Rocking Recliner w/ Headrest & Lumbar	COST	-	-	-	-	-	-	-	-	-	-	-	FN, FS, LW, SL	40.5	34	37.5	13	98
	RESALE	1319	-	-	1439	1559	1669	1789	1689	1899	2109	2319		19	19	21	23.5	1
016704 Wall Recliner	COST	-	-	-	-	-	-	-	-	-	-	-	ES, FN, FS, H1, H3, L1, L3, LE, LS	40.5	36	37.5	7	80
	RESALE	609	-	-	729	839	959	1079	969	1189	1399	1609		19	19	21	23.5	1
16X704 Power Wall Recliner w/ Headrest & Lumbar	COST	-	-	-	-	-	-	-	-	-	-	-	FS, LW	40.5	34	37.5	7	108
	RESALE	1359	-	-	1469	1589	1709	1819	1719	1929	2139	2359		19	19	21	23.5	1

General guidance, may not apply to all prefixes. Please refer to Product Info Guide for more detail by prefix.



ORDER FOB'S: 05, 06

BACKS: Blown fiber/foam

PILLOWS: N/A

STD FINISH: N/A

SEATS: Standard (SS)

OPT FINISHES: N/A

CAP CODES: DR, UR, DP, NP, PS, UE, VS, BU, RL, LL, LM

FEATURES: Flange welt on the back, arms, and chaise

BATTERY: 088BP2

SPECIAL INFO: N/A

SELECT FAUX LEATHER: N/A

SELECT LEATHER: N/A

SELECT FABRIC:

C1757 Bartaloni
C1809 Donegal

706 JAY	GRADE	SELECT			CUSTOM FABRIC				CUSTOM LEATHER / PLUS				AVAILABLE OPTIONS	DIMENSIONS				
		FAB	FAUX LTH	LTH	B-C	D-F, RE	G-N	P-Q	BL	DL	FL	HL		H	W	D	RD	WT
		SH	SW	SD	AH	SF												
444706 Reclining Sofa	COST	-	-	-	-	-	-	-	-	-	-	-	FS	43	86.6	39	5	192
	RESALE	1399	-	-	1559	1719	1879	2039	2259	2789	3319	3859		20.6	67	23	26	3

706 JAY	GRADE	SELECT			CUSTOM FABRIC				CUSTOM LEATHER / PLUS				AVAILABLE OPTIONS	DIMENSIONS				
		FAB	FAUX LTH	LTH	B-C	D-F, RE	G-N	P-Q	BL	DL	FL	HL		H	W	D	RD	WT
		SH	SW	SD	AH	SF												
U44706 Power Reclining Sofa w/ Headrest	COST	-	-	-	-	-	-	-	-	-	-	-	FS, W2	43	86.5	39	5	232
	RESALE	2039	-	-	2199	2359	2519	2669	2899	3429	3959	4489		20.5	67	23	26	3
X44706 Power Reclining Sofa w/ Headrest & Lumbar	COST	-	-	-	-	-	-	-	-	-	-	-	FS, W2	43	86.5	39	5	242
	RESALE	2359	-	-	2519	2669	2829	2989	3219	3749	4279	4809		20.5	67	23	26	3
448706 Reclining Loveseat	COST	-	-	-	-	-	-	-	-	-	-	-	FS	43	63.5	39	5	147
	RESALE	1359	-	-	1519	1669	1829	1989	2219	2749	3279	3809		20.5	44	23	26	2
U48706 Power Reclining Loveseat w/ Headrest	COST	-	-	-	-	-	-	-	-	-	-	-	FS, W2	43	63.5	39	5	187
	RESALE	1989	-	-	2149	2309	2469	2629	2859	3389	3919	4449		20.5	44	23	26	2
X48706 Power Reclining Loveseat w/ Headrest & Lumbar	COST	-	-	-	-	-	-	-	-	-	-	-	FS, W2	43	63.5	39	5	197
	RESALE	2309	-	-	2469	2629	2789	2949	3169	3709	4239	4769		20.5	44	23	26	2
449706 Reclining Loveseat w/ Console	COST	-	-	-	-	-	-	-	-	-	-	-	CB, CC, CM, FS	43	78.5	39	5	171
	RESALE	1499	-	-	1659	1819	1979	2139	2369	2899	3429	3959		20.5	59	23	26	3
U49706 Power Reclining Loveseat w/ Headrest & Console	COST	-	-	-	-	-	-	-	-	-	-	-	CB, CC, CM, FS, W2	43	78.5	39	5	211
	RESALE	2139	-	-	2299	2459	2619	2779	2999	3539	4069	4599		20.5	59	23	26	3
X49706 Power Reclining Loveseat w/ Headrest, Lumbar & Console	COST	-	-	-	-	-	-	-	-	-	-	-	CB, CC, CM, FS, W2	43	78.5	39	5	221
	RESALE	2459	-	-	2619	2779	2939	3099	3319	3859	4389	4919		20.5	59	23	26	3



General guidance, may not apply to all prefixes. Please refer to Product Info Guide for more detail by prefix.

ORDER FOB'S: 05, 06

BACKS: Blown fiber/foam

SWIVEL: 088123, 088124, 088126, 08812T

STD FINISH: 007

SEATS: Ultra Plush chaise (SS)

TALL: 088210, 088266

OPT FINISHES: 021

CAP CODES: DR, UR, DP, NP, PS, UE, VS, BU, RL, LL, LM

FEATURES: Flange welt on the back, arms, and chaise

BATTERY: 088BP1

SPECIAL INFO: N/A

SELECT FABRIC:

SELECT FAUX LEATHER: N/A

SELECT LEATHER: N/A

C1757 Bartaloni
C1809 Donegal

706 JAY	GRADE	SELECT			CUSTOM FABRIC				CUSTOM LEATHER / PLUS				AVAILABLE OPTIONS	DIMENSIONS				
		FAB	FAUX LTH	LTH	B-C	D-F, RE	G-N	P-Q	BL	DL	FL	HL		H	W	D	RD	WT
		SH	SW	SD	AH	SF												
010706 Rocking Recliner	COST	-	-	-	-	-	-	-	-	-	-	-	ES, FN, FS, H1, H3, L1, L3, LE, LS, SW	42.5	39	38	11	79
	RESALE	689	-	-	799	919	1039	1149	1219	1429	1639	1859		20.5	21	20	24.5	1
10U706 Power Rocking Recliner w/ Headrest	COST	-	-	-	-	-	-	-	-	-	-	-	FN, FS, LW, SL	42.5	37	38	11	94
	RESALE	1269	-	-	1389	1499	1619	1739	1799	2019	2229	2439		20.5	21	20	24.5	1
10X706 Power Rocking Recliner w/ Headrest & Lumbar	COST	-	-	-	-	-	-	-	-	-	-	-	FN, FS, LW, SL	42.5	37	38	11	99
	RESALE	1429	-	-	1549	1659	1779	1899	1959	2169	2389	2599		20.5	21	20	24.5	1

706 JAY	GRADE	SELECT			CUSTOM FABRIC				CUSTOM LEATHER / PLUS				AVAILABLE OPTIONS	DIMENSIONS				
		FAB	FAUX LTH	LTH	B-C	D-F, RE	G-N	P-Q	BL	DL	FL	HL		H	W	D	RD	WT
														SH	SW	SD	AH	SF
016706 Wall Recliner	COST	-	-	-	-	-	-	-	-	-	-	-	ES, FN, FS, H1, H3, L1, L3, LE, LS	42.5	39	38	6	89
	RESALE	719	-	-	829	949	1069	1189	1249	1459	1669	1889		20.5	21	20	24.5	1
16X706 Power Wall Recliner w/ Headrest & Lumbar	COST	-	-	-	-	-	-	-	-	-	-	FS, LW	42.5	37	38	6	115	
	RESALE	1459	-	-	1579	1699	1809	1929	1989	2209	2419		2629	20.5	21	20	24.5	1



General guidance, may not apply to all prefixes. Please refer to Product Info Guide for more detail by prefix.

ORDER FOB'S: 05, 06

BACKS: Blown fiber

SWIVEL: 088123, 088124, 088126, 08812T

STD FINISH: 007

SEATS: Ultra Plush chaise (SS)

TALL: 088210, 088266

OPT FINISHES: 021

CAP CODES: DR, UR, UE, BU, RL, LL, LM

FEATURES: N/A

BATTERY: 088BP1

SPECIAL INFO: N/A

SELECT FAUX LEATHER: N/A

SELECT LEATHER:

C1625 Vance
D2075 Galloway

LB2064 Opulence - 74, 77

709 JASPER	GRADE	SELECT			CUSTOM FABRIC				CUSTOM LEATHER / PLUS				AVAILABLE OPTIONS	DIMENSIONS				
		FAB	FAUX LTH	LTH	B-C	D-F, RE	G-N	P-Q	BL	DL	FL	HL		H	W	D	RD	WT
														SH	SW	SD	AH	SF
010709 Rocking Recliner	COST	-	-	-	-	-	-	-	-	-	-	-	ES, FN, FS, H1, H3, L1, L3, LE, LS, SW	42	40	38.5	11	76
	RESALE	689	-	929	799	919	1039	1149	1039	1249	1459	1669		20	21.5	20	25.5	1
10U709 Power Rocking Recliner w/ Headrest	COST	-	-	-	-	-	-	-	-	-	-	-	FN, FS, LW, SL	42	38	38.5	11	95
	RESALE	1269	-	1519	1389	1499	1619	1739	1619	1829	2049	2259		20	21.5	20	25.5	1
10X709 Power Rocking Recliner w/ Headrest & Lumbar	COST	-	-	-	-	-	-	-	-	-	-	-	FN, FS, LW, SL	42	38	38.5	11	101
	RESALE	1429	-	1669	1549	1659	1779	1899	1779	1989	2209	2419		20	21.5	20	25.5	1
016709 Wall Recliner	COST	-	-	-	-	-	-	-	-	-	-	-	ES, FN, FS, H1, H3, L1, L3, LE, LS	42	40	38.5	5	86
	RESALE	719	-	959	829	949	1069	1189	1069	1279	1489	1709		20	21.5	20	25.5	1
16X709 Power Wall Recliner w/ Headrest & Lumbar	COST	-	-	-	-	-	-	-	-	-	-	-	FS, LW	42	38	38.5	5	106
	RESALE	1459	-	1709	1579	1699	1809	1929	1809	2029	2239	2449		20	21.5	20	25.5	1



General guidance, may not apply to all prefixes. Please refer to Product Info Guide for more detail by prefix.

ORDER FOB'S: 05, 06

BACKS: Foam

SWIVEL: 088123, 088124, 088126, 08812T

STD FINISH: 007

SEATS: Ultra Plush chaise (SS)

TALL: 088210, 088266

OPT FINISHES: 021

CAP CODES: DR, UR, UE, BU, RL, LL, LM

FEATURES: Padded outside arms.

BATTERY: 088BP1

SPECIAL INFO: N/A

SELECT FAUX LEATHER: N/A

SELECT LEATHER:

C1965 Nora
D2010 i-Rene

LB2026 Grandview - 51, 59, 75

712 SPARROW	GRADE	SELECT			CUSTOM FABRIC				CUSTOM LEATHER / PLUS				AVAILABLE OPTIONS	DIMENSIONS				
		FAB	FAUX LTH	LTH	B-C	D-F, RE	G-N	P-Q	BL	DL	FL	HL		H	W	D	RD	WT
		SH	SW	SD	AH	SF												
010712 Rocking Recliner	COST	-	-	-	-	-	-	-	-	-	-	-	ES, FN, FS, H1, H3, L1, L3, LE, LS, SW	40.5	33.5	38	13	71
	RESALE	639	-	929	759	879	989	1109	1039	1249	1459	1669		20	22.5	20.5	24	1
10U712 Power Rocking Recliner w/ Headrest	COST	-	-	-	-	-	-	-	-	-	-	-	FN, FS, LW, SL	40.5	31.5	38	13	90
	RESALE	1229	-	1519	1339	1459	1579	1699	1619	1829	2049	2259		20	22.5	20.5	24	1
10X712 Power Rocking Recliner w/ Headrest & Lumbar	COST	-	-	-	-	-	-	-	-	-	-	-	FN, FS, LW, SL	40.5	31.5	38	13	96
	RESALE	1389	-	1669	1499	1619	1739	1859	1779	1989	2209	2419		20	22.5	20.5	24	1
016712 Wall Recliner	COST	-	-	-	-	-	-	-	-	-	-	-	ES, FN, FS, H1, H3, L1, L3, LE, LS	40.5	33.5	38	3	81
	RESALE	669	-	959	789	909	1029	1139	1069	1279	1489	1709		20	22.5	20.5	24	1
16X712 Power Wall Recliner w/ Headrest & Lumbar	COST	-	-	-	-	-	-	-	-	-	-	-	FS, LW	40.5	31.5	38	3	101
	RESALE	1419	-	1709	1539	1649	1769	1889	1809	2029	2239	2449		20	22.5	20.5	24	1
017712 Swivel Gliding Recliner	COST	-	-	-	-	-	-	-	-	-	-	-	ES, FN, FS, H1, H3, L1, L3, LE, LS	40.5	33.5	38	13	105
	RESALE	799	-	1089	919	1039	1149	1269	1199	1409	1619	1829		20	22.5	20.5	24	1



General guidance, may not apply to all prefixes. Please refer to Product Info Guide for more detail by prefix.

ORDER FOB'S: 05, 06
STD FINISH: 007
OPT FINISHES: 021
BATTERY: 088BP1
SPECIAL INFO: N/A

BACKS: Foam
SEATS: Deep, standard chaise (SS)
CAP CODES: DR, UR, UE, BU, RL, LL, LM

SWIVEL: 088124, 08812T
TALL: N/A
FEATURES: Tall base

SELECT FABRIC:
 D2009 Promise
 D2027 i-Weekend

SELECT FAUX LEATHER: N/A

SELECT LEATHER:
 LB2060 Sutton - 77, 87

715 KODIE	GRADE	SELECT			CUSTOM FABRIC				CUSTOM LEATHER / PLUS				AVAILABLE OPTIONS	DIMENSIONS				
		FAB	FAUX LTH	LTH	B-C	D-F, RE	G-N	P-Q	BL	DL	FL	HL		H	W	D	RD	WT
														SH	SW	SD	AH	SF
010715 Rocking Recliner	COST	-	-	-	-	-	-	-	-	-	-	-	ES, FN, FS, H1, H3, L1, L3, LE, LS, SW	45	33.5	38.5	15	84.5
	RESALE	879	-	1149	989	1109	1229	1339	1259	1469	1689	1899		22	22	22	26.5	1
10U715 Power Rocking Recliner w/ Headrest	COST	-	-	-	-	-	-	-	-	-	-	-	FN, FS, LW, SL	45	31.5	38.5	15	103.5
	RESALE	1459	-	1739	1579	1699	1809	1929	1839	2059	2269	2479		22	22	22	26.5	1
10X715 Power Rocking Recliner w/ Headrest & Lumbar	COST	-	-	-	-	-	-	-	-	-	-	-	FN, FS, LW, SL	45	31.5	38.5	15	109.5
	RESALE	1619	-	1899	1739	1859	1969	2089	1999	2219	2429	2639		22	22	22	26.5	1
016715 Wall Recliner	COST	-	-	-	-	-	-	-	-	-	-	-	ES, FN, FS, H1, H3, L1, L3, LE, LS	45	33.5	38.5	5	94.5
	RESALE	909	-	1189	1029	1139	1259	1379	1289	1499	1719	1929		22	22	22	26.5	1
16X715 Power Wall Recliner w/ Headrest & Lumbar	COST	-	-	-	-	-	-	-	-	-	-	-	FN, FS, LW	45	31.5	38.5	5	114.5
	RESALE	1649	-	1929	1769	1889	1999	2119	2039	2249	2459	2669		22	22	22	26.5	1



General guidance, may not apply to all prefixes. Please refer to Product Info Guide for more detail by prefix.

ORDER FOB'S: 05, 06
STD FINISH: 007
OPT FINISHES: 021
BATTERY: 088BP1
SPECIAL INFO: N/A

BACKS: Foam headrest w/ fiber wrap, blown fiber lower back
SEATS: Hybrid bucket chaise seat, seat and chaise splits
CAP CODES: DR, UR, UE, BU, RL, LL, LM

SWIVEL: 088123, 088124, 088126, 08812T
TALL: 088210, 088266
FEATURES: N/A

SELECT FABRIC:
 C2035 Thane
 D2095 Crocker

SELECT FAUX LEATHER: N/A

SELECT LEATHER:
 LB2062 Clifton - 78, 79

717 FULTON	GRADE	SELECT			CUSTOM FABRIC				CUSTOM LEATHER / PLUS				AVAILABLE OPTIONS	DIMENSIONS				
		FAB	FAUX LTH	LTH	B-C	D-F, RE	G-N	P-Q	BL	DL	FL	HL		H	W	D	RD	WT
														SH	SW	SD	AH	SF
010717 Rocking Recliner	COST	-	-	-	-	-	-	-	-	-	-	-	ES, FN, FS, H1, H3, L1, L3, LE, LS, SW	44	37.5	38	14.5	82
	RESALE	789	-	1149	909	1029	1139	1259	1259	1469	1689	1899		21.5	21.5	22.5	26	1

717 FULTON	GRADE	SELECT			CUSTOM FABRIC				CUSTOM LEATHER / PLUS				AVAILABLE OPTIONS	DIMENSIONS				
		FAB	FAUX LTH	LTH	B-C	D-F, RE	G-N	P-Q	BL	DL	FL	HL		H	W	D	RD	WT
		SH	SW	SD	AH	SF												
10U717 Power Rocking Recliner w/ Headrest	COST	-	-	-	-	-	-	-	-	-	-	-	FN, FS, LW, SL	44	37.5	38	14.5	101
	RESALE	1379	-	1739	1489	1609	1729	1839	1839	2059	2269	2479		21.5	21.5	22.5	26	1
10X717 Power Rocking Recliner w/ Headrest & Lumbar	COST	-	-	-	-	-	-	-	-	-	-	-	FN, FS, LW, SL	44	37.5	38	14.5	107
	RESALE	1539	-	1899	1649	1769	1889	1999	1999	2219	2429	2639		21.5	21.5	22.5	26	1
016717 Wall Recliner	COST	-	-	-	-	-	-	-	-	-	-	-	ES, FN, FS, H1, H3, L1, L3, LE, LS	44	37.5	38	4.5	92
	RESALE	819	-	1189	939	1059	1169	1289	1289	1499	1719	1929		21.5	21.5	22.5	26	1
16X717 Power Wall Recliner w/ Headrest & Lumbar	COST	-	-	-	-	-	-	-	-	-	-	-	FS, LW	44	37.5	38	4.5	112
	RESALE	1569	-	1929	1689	1799	1919	2039	2039	2249	2459	2669		21.5	21.5	22.5	26	1

General guidance, may not apply to all prefixes. Please refer to Product Info Guide for more detail by prefix.

ORDER FOB'S: 05, 06

BACKS: Chambered blown fiber

PILLOWS: N/A

STD FINISH: N/A

SEATS: 444 sculpted-bucket chaise (SS)

OPT FINISHES: N/A

CAP CODES: DR, UR, UE, BU, RL, LL, LM

FEATURES: N/A

BATTERY: 088BP2

SPECIAL INFO: N/A

SELECT FABRIC:

SELECT FAUX LEATHER: N/A

SELECT LEATHER:

C1525 Roma

LB1648 Prestige - 54, 79



722 ROMAN	GRADE	SELECT			CUSTOM FABRIC				CUSTOM LEATHER / PLUS				AVAILABLE OPTIONS	DIMENSIONS				
		FAB	FAUX LTH	LTH	B-C	D-F, RE	G-N	P-Q	BL	DL	FL	HL		H	W	D	RD	WT
		SH	SW	SD	AH	SF												
443722 Reclining 2-seat Sofa	COST	-	-	-	-	-	-	-	-	-	-	-	FS	43	85	41	5	200
	RESALE	1429	-	1919	1589	1749	1909	2069	2239	2769	3299	3829		20	63	23	26	3
U43722 Power Reclining 2-seat Sofa w/ Headrest	COST	-	-	-	-	-	-	-	-	-	-	-	FS, W2	43	85	41	5	263
	RESALE	2069	-	2559	2229	2389	2549	2709	2879	3409	3939	4469		20	63	23	26	3
X43722 Power Reclining 2-Seat Sofa w/ Headrest and Lumbar	COST	-	-	-	-	-	-	-	-	-	-	-	FS, W2	43	85	41	5	273
	RESALE	2389	-	2879	2549	2709	2869	3029	3199	3729	4259	4789		20	63	23	26	3
445722 Reclining Chair & A Half	COST	-	-	-	-	-	-	-	-	-	-	-	FS	43	52.5	41	5	133
	RESALE	1219	-	1709	1329	1449	1569	1689	1809	2029	2239	2449		20	30	23	26	2
U45722 Power Reclining Chair & a Half w/ Headrest	COST	-	-	-	-	-	-	-	-	-	-	-	FS, LT, LW, RW	43	52.5	41	5	263
	RESALE	1539	-	2029	1649	1769	1889	1999	2129	2339	2559	2769		20	63	23	26	2
X45722 Power Reclining Chair and A Half w/ Headrest and Lumbar	COST	-	-	-	-	-	-	-	-	-	-	-	FS, LT, LW, RW	43	52.5	41	5	165
	RESALE	1699	-	2189	1809	1929	2049	2159	2289	2499	2719	2929		20	30	23	26	2

General guidance, may not apply to all prefixes. Please refer to Product Info Guide for more detail by prefix.

ORDER FOB'S: 05, 06

BACKS: Blown fiber

PILLOWS: N/A

STD FINISH: N/A

SEATS: 444 sculpted-bucket chaise (SS)



OPT FINISHES: N/A

CAP CODES: DR, UR, UE, BU, RL, LL, LM

FEATURES: N/A

BATTERY: 088BP1

SPECIAL INFO: N/A

SELECT FAUX LEATHER:

SELECT LEATHER:

D2124 i-Westvale

E1537 i-Northwest

LB1727 Intermingle - 55, 79

724 TROUPER	GRADE	SELECT			CUSTOM FABRIC				CUSTOM LEATHER / PLUS				AVAILABLE OPTIONS	DIMENSIONS				
		FAB	FAUX LTH	LTH	B-C	D-F, RE	G-N	P-Q	BL	DL	FL	HL		H	W	D	RD	WT
														SH	SW	SD	AH	SF
44A724 Left-Arm SITTING Recliner	COST	-	-	-	-	-	-	-	-	-	-	-	FS	42	30	40	4	80
	RESALE	789	799	1059	909	1029	1139	1259	1159	1379	1589	1799		20.5	22	21	26	2
U4A724 Power Left-Arm SITTING Recliner w/ Headrest	COST	-	-	-	-	-	-	-	-	-	-	-	FS, LW	42	30	40	4	97
	RESALE	1109	1119	1379	1229	1339	1459	1579	1479	1699	1909	2119		20.5	22	21	26	2
X4A724 Power Left-Arm SITTING Recliner w/ Headrest and Lumbar	COST	-	-	-	-	-	-	-	-	-	-	-	FS, LW	42	30	40	4	102
	RESALE	1269	1279	1539	1389	1499	1619	1739	1639	1859	2069	2279		20.5	22	21	26	2
44B724 Right-Arm SITTING Recliner	COST	-	-	-	-	-	-	-	-	-	-	-	FS	42	30	40	4	80
	RESALE	789	799	1059	909	1029	1139	1259	1159	1379	1589	1799		20.5	22	21	26	2
U4B724 Power Right-Arm SITTING Recliner w/ Headrest	COST	-	-	-	-	-	-	-	-	-	-	-	FS, RW	42	30	40	4	97
	RESALE	1109	1119	1379	1229	1339	1459	1579	1479	1699	1909	2119		20.5	22	21	26	2
X4B724 Power Right-Arm SITTING Recliner w/ Headrest and Lumbar	COST	-	-	-	-	-	-	-	-	-	-	-	FS, RW	42	30	40	4	102
	RESALE	1269	1279	1539	1389	1499	1619	1739	1639	1859	2069	2279		20.5	22	21	26	2
44C724 Rounded Corner Unit	COST	-	-	-	-	-	-	-	-	-	-	-	FS	42	62	38	-	72
	RESALE	979	999	1289	1139	1299	1459	1619	1609	2139	2669	3209		19.5	-	22	-	2
SC4724 Storage Console	COST	-	-	-	-	-	-	-	-	-	-	-	CB, CC, CM	38.5	14.5	37.5	-	55
	RESALE	629	639	859	689	739	789	839	909	1019	1119	1229		-	-	-	-	1
44D724 Left-Arm SITTING Reclining Loveseat	COST	-	-	-	-	-	-	-	-	-	-	-	FS	42	56	40	4	128
	RESALE	1209	1229	1609	1369	1529	1689	1839	1929	2459	2989	3529		20.5	45	20.5	26	2
U4D724 Power Left-Arm SITTING Reclining Loveseat w/ Headrest	COST	-	-	-	-	-	-	-	-	-	-	-	FS, LW	42	56	40	4	145
	RESALE	1529	1549	1929	1689	1839	1999	2159	2249	2779	3309	3839		20.5	45	20.5	26	2
X4D724 Power Left-Arm SITTING Reclining Loveseat w/ Headrest and Lumbar	COST	-	-	-	-	-	-	-	-	-	-	-	FS, LW	42	56	40	4	155
	RESALE	1689	1709	2089	1839	1999	2159	2319	2409	2939	3469	3999		20.5	45	20.5	26	2
44E724 Right-Arm SITTING Reclining Loveseat	COST	-	-	-	-	-	-	-	-	-	-	-	FS	42	56	40	4	128
	RESALE	1209	1229	1609	1369	1529	1689	1839	1929	2459	2989	3529		20.5	45	20.5	26	2
U4E724 Power Right-Arm SITTING Reclining Loveseat w/ Headrest	COST	-	-	-	-	-	-	-	-	-	-	-	FS, RW	42	56	40	4	145
	RESALE	1529	1549	1929	1689	1839	1999	2159	2249	2779	3309	3839		20.5	45	20.5	26	2

724 TROUPE	GRADE	SELECT			CUSTOM FABRIC				CUSTOM LEATHER / PLUS				AVAILABLE OPTIONS	DIMENSIONS				
		FAB	FAUX LTH	LTH	B-C	D-F, RE	G-N	P-Q	BL	DL	FL	HL		H	W	D	RD	WT
		SH	SW	SD	AH	SF												
X4E724 Power Right-Arm SITTING Reclining Loveseat w/ Headrest and Lumbar	COST	-	-	-	-	-	-	-	-	-	-	-	FS, RW	42	56	40	4	155
	RESALE	1689	1709	2089	1839	1999	2159	2319	2409	2939	3469	3999		20.5	45	20.5	26	2
M44724 Armless Chair	COST	-	-	-	-	-	-	-	-	-	-	-	FS	42	24	40	-	48
	RESALE	589	599	829	709	819	939	1059	939	1149	1369	1579		20.5	24	20.5	-	1
44S724 Armless Recliner	COST	-	-	-	-	-	-	-	-	-	-	-	FS	42	24	40	4	62
	RESALE	699	709	939	809	929	1049	1159	1049	1259	1469	1689		20.5	24	20.5	-	1
U4S724 Power Armless Recliner w/ Headrest	COST	-	-	-	-	-	-	-	-	-	-	-	FS, RW	42	24	40	4	77
	RESALE	1019	1029	1259	1129	1249	1369	1479	1369	1579	1789	1999		20.5	24	20.5	-	1
X4S724 Power Armless Recliner w/ Headrest and Lumbar	COST	-	-	-	-	-	-	-	-	-	-	-	FS, RW	42	24	40	4	82
	RESALE	1169	1189	1419	1289	1409	1529	1639	1529	1739	1949	2159		20.5	24	20.5	-	1
44Q724 Left-Arm SITTING Reclining Chaise	COST	-	-	-	-	-	-	-	-	-	-	-	FS	42	35	68	10	105
	RESALE	1119	1139	1529	1279	1439	1599	1759	1839	2379	2909	3439		20	26	49	26	2
U4Q724 Power Left-Arm SITTING Reclining Chaise w/ Headrest	COST	-	-	-	-	-	-	-	-	-	-	-	FS, LW	42	35	68	10	105
	RESALE	1439	1459	1839	1599	1759	1919	2079	2159	2699	3229	3759		20	26	49	26	2
X4Q724 Power Left-Arm SITTING Reclining Chaise w/ Headrest and Lumbar	COST	-	-	-	-	-	-	-	-	-	-	-	FS, LW	42	35	68	10	115
	RESALE	1599	1619	1999	1759	1919	2079	2239	2319	2859	3389	3919		20	26	49	26	2
44V724 Right-Arm SITTING Reclining Chaise	COST	-	-	-	-	-	-	-	-	-	-	-	FS	42	35	68	10	105
	RESALE	1119	1139	1529	1279	1439	1599	1759	1839	2379	2909	3439		20	26	49	26	2
U4V724 Power Right-Arm SITTING Reclining Chaise w/ Headrest	COST	-	-	-	-	-	-	-	-	-	-	-	FS, RW	42	35	68	10	105
	RESALE	1439	1459	1839	1599	1759	1919	2079	2159	2699	3229	3759		20	26	49	26	2
X4V724 Power Right-Arm SITTING Reclining Chaise w/ Headrest and Lumbar	COST	-	-	-	-	-	-	-	-	-	-	-	FS, RW	42	35	68	10	115
	RESALE	1599	1619	1999	1759	1919	2079	2239	2319	2859	3389	3919		20	26	49	26	2

General guidance, may not apply to all prefixes. Please refer to Product Info Guide for more detail by prefix.



ORDER FOB'S: 05, 06

BACKS: Blown fiber

PILLOWS: N/A

STD FINISH: N/A

SEATS: 444 sculpted-bucket chaise (SS)

OPT FINISHES: N/A

CAP CODES: DR, UR, UE, BU, RL, LL, LM

FEATURES: N/A

BATTERY: 088BP2

SPECIAL INFO: Drop down table surface only available in Sable finish.

SELECT FABRIC:

SELECT FAUX LEATHER:

SELECT LEATHER:

D2124 i-Westvale

E1537 i-Northwest

LB1727 Intermingle - 55, 79

724 TROUPER	GRADE	SELECT			CUSTOM FABRIC				CUSTOM LEATHER / PLUS				AVAILABLE OPTIONS	DIMENSIONS				
		FAB	FAUX LTH	LTH	B-C	D-F, RE	G-N	P-Q	BL	DL	FL	HL		H	W	D	RD	WT
		SH	SW	SD	AH	SF												
444724 Reclining Sofa	COST	-	-	-	-	-	-	-	-	-	-	-	FS	41.5	85	42	4	212
	RESALE	1729	1759	2259	1889	2049	2209	2369	2579	3109	3639	4169		20.6	67.6	20.6	26.6	3
U44724 Power Reclining Sofa w/ Headrest	COST	-	-	-	-	-	-	-	-	-	-	-	FS, W2	41.5	85	42	4	246
	RESALE	2369	2399	2899	2529	2689	2839	2999	3219	3749	4279	4809		20.5	67.5	20.5	26.5	3
X44724 Power Reclining Sofa w/ Headrest & Lumbar	COST	-	-	-	-	-	-	-	-	-	-	-	FS, W2	41.5	85	42	4	246
	RESALE	2689	2719	3219	2839	2999	3159	3319	3539	4069	4599	5129		20.5	67.5	20.5	26.5	3
NEW! 446724 Reclining Sofa w/ Drop Down Table	COST	-	-	-	-	-	-	-	-	-	-	-	FS	41.5	85	42	4	-
	RESALE	1989	2029	2529	2149	2309	2469	2629	2839	3379	3909	4439		20.6	67.6	20.6	26.6	3
NEW! U46724 Power Reclining Sofa w/ Headrest & Drop Down Table	COST	-	-	-	-	-	-	-	-	-	-	-	FS, W2	41.5	85	42	4	-
	RESALE	2629	2659	3159	3109	3269	3429	3589	3799	4329	4869	5399		20.5	67.5	20.5	26.5	3
NEW! X46724 Power Reclining Sofa w/ Headrest, Lumbar and Drop Down Table	COST	-	-	-	-	-	-	-	-	-	-	-	FS, W2	41.5	85	42	4	-
	RESALE	2949	2979	3479	3429	3589	3749	3909	4119	4649	5189	5719		20.5	67.5	20.5	26.5	3
448724 Reclining Loveseat	COST	-	-	-	-	-	-	-	-	-	-	-	FS	41.5	62	42	4	174
	RESALE	1689	1719	2219	1839	1999	2159	2319	2539	3069	3599	4129		20.5	44.5	20.5	26.5	2
U48724 Power Reclining Loveseat w/ Headrest	COST	-	-	-	-	-	-	-	-	-	-	-	FS, W2	41.5	62	42	4	174
	RESALE	2319	2359	2859	2479	2639	2799	2959	3169	3709	4239	4769		20.5	44.5	20.5	26.5	2
X48724 Power Reclining Loveseat w/ Headrest & Lumbar	COST	-	-	-	-	-	-	-	-	-	-	-	FS, W2	41.5	62	42	4	184
	RESALE	2639	2669	3169	2799	2959	3119	3279	3489	4029	4559	5089		20.5	44.5	20.5	26.5	2
449724 Reclining Loveseat w/ Console	COST	-	-	-	-	-	-	-	-	-	-	-	CB, CC, CM, FS	41.5	77	42	4	200
	RESALE	1829	1869	2369	1989	2149	2309	2469	2689	3219	3749	4279		20.5	59.5	20.5	26.5	3
U49724 Power Reclining Loveseat w/ Headrest & Console	COST	-	-	-	-	-	-	-	-	-	-	-	CB, CC, CM, FS, W2	41.5	77	42	4	234
	RESALE	2469	2499	2999	2629	2789	2949	3109	3319	3859	4389	4919		20.5	59.5	20.5	26.5	3
X49724 Power Reclining Loveseat w/ Headrest, Lumbar & Console	COST	-	-	-	-	-	-	-	-	-	-	-	CB, CC, CM, FS, W2	41.5	77	42	4	234
	RESALE	2789	2819	3319	2949	3109	3269	3429	3639	4169	4709	5239		20.5	59.5	20.5	26.5	3



General guidance, may not apply to all prefixes. Please refer to Product Info Guide for more detail by prefix.

ORDER FOB'S: 05, 06 **BACKS:** Blown fiber **SWIVEL:** 088123, 088124, 088126, 08812T
STD FINISH: 007 **SEATS:** Sculpted-bucket chaise (SS) **TALL:** 088210, 088266
OPT FINISHES: 021 **CAP CODES:** DR, UR, UE, BU, RL, LL, LM **FEATURES:** N/A
BATTERY: 088BP1
SPECIAL INFO: N/A
SELECT FABRIC: D2124 i-Westvale **SELECT FAUX LEATHER:** E1537 i-Northwest **SELECT LEATHER:** LB1727 Intermingle - 55, 79

724 TROUPER	GRADE	SELECT			CUSTOM FABRIC				CUSTOM LEATHER / PLUS				AVAILABLE OPTIONS	DIMENSIONS				
		FAB	FAUX LTH	LTH	B-C	D-F, RE	G-N	P-Q	BL	DL	FL	HL		H	W	D	RD	WT
														SH	SW	SD	AH	SF
010724 Rocking Recliner	COST	-	-	-	-	-	-	-	-	-	-	-	ES, FN, FS, H1, H3, L1, L3, LE, LS, SW	42	37	38	15.5	79
	RESALE	769	779	999	889	999	1119	1239	1109	1319	1539	1749		20	19.5	20.5	26	1
10U724 Power Rocking Recliner w/ Headrest	COST	-	-	-	-	-	-	-	-	-	-	-	FN, FS, LW, SL	42	35	38	14	99
	RESALE	1359	1369	1589	1469	1589	1709	1819	1699	1909	2119	2329		20	19.5	20.5	26	1
10X724 Power Rocking Recliner w/ Headrest & Lumbar	COST	-	-	-	-	-	-	-	-	-	-	-	FN, FS, LW, SL	42	35	38	15.5	104
	RESALE	1519	1529	1749	1629	1749	1869	1979	1859	2069	2279	2489		20	19.5	20.5	26	1
016724 Wall Recliner	COST	-	-	-	-	-	-	-	-	-	-	-	ES, FN, FS, H1, H3, L1, L3, LE, LS	42	37	38	7.5	89
	RESALE	799	809	1039	919	1039	1149	1269	1139	1359	1569	1779		20	19.5	20.5	26	1
16X724 Power Wall Recliner w/ Headrest & Lumbar	COST	-	-	-	-	-	-	-	-	-	-	-	FS, LW	42	35	38	7.5	114
	RESALE	1549	1559	1779	1659	1779	1899	2019	1889	2099	2309	2529		20	19.5	20.5	26	1



General guidance, may not apply to all prefixes. Please refer to Product Info Guide for more detail by prefix.

ORDER FOB'S: 05, 06 **BACKS:** Blown fiber, knife-edge **SWIVEL:** 088123, 088124, 088126, 08812T
STD FINISH: 007 **SEATS:** Standard chaise (SS) **TALL:** 088210, 088266
OPT FINISHES: 021 **CAP CODES:** DR, UR, UE, BU, RL, LL, LM **FEATURES:** N/A
BATTERY: 088BP1
SPECIAL INFO: N/A
SELECT FABRIC: C2067 Axe **SELECT FAUX LEATHER:** N/A **SELECT LEATHER:** N/A
D1604 i-Outlier

725 SHERMAN	GRADE	SELECT			CUSTOM FABRIC				CUSTOM LEATHER / PLUS				AVAILABLE OPTIONS	DIMENSIONS				
		FAB	FAUX LTH	LTH	B-C	D-F, RE	G-N	P-Q	BL	DL	FL	HL		H	W	D	RD	WT
														SH	SW	SD	AH	SF
010725 Rocking Recliner	COST	-	-	-	-	-	-	-	-	-	-	-	ES, FN, FS, H1, H3, L1, L3, LE, LS, SW	42	34.5	37	15.5	77
	RESALE	579	-	-	699	809	929	1049	959	1169	1389	1599		20	21.5	20.5	25	1

725 SHERMAN	GRADE	SELECT			CUSTOM FABRIC				CUSTOM LEATHER / PLUS				AVAILABLE OPTIONS	DIMENSIONS				
		FAB	FAUX LTH	LTH	B-C	D-F, RE	G-N	P-Q	BL	DL	FL	HL		H	W	D	RD	WT
		SH	SW	SD	AH	SF												
P10725 Power Rocking Recliner	COST	-	-	-	-	-	-	-	-	-	-	-	FN, FS, HW, LT, SL	42	32.5	37	15.5	87
	RESALE	789	-	-	909	1029	1139	1259	1169	1389	1599	1809		20	21.5	20.5	25	1
016725 Wall Recliner	COST	-	-	-	-	-	-	-	-	-	-	-	ES, FN, FS, H1, H3, L1, L3, LE, LS	42	34.5	37	5.5	87
	RESALE	609	-	-	729	839	959	1079	989	1209	1419	1629		20	21.5	20.5	25	1
P16725 Power Wall Recliner	COST	-	-	-	-	-	-	-	-	-	-	-	FN, FS, HW, LT	42	32.5	37	5.5	97
	RESALE	819	-	-	939	1059	1169	1289	1209	1419	1629	1839		20	21.5	20.5	25	1

General guidance, may not apply to all prefixes. Please refer to Product Info Guide for more detail by prefix.



ORDER FOB'S: 05, 06
STD FINISH: N/A
OPT FINISHES: N/A
BATTERY: 088BP2
SPECIAL INFO: N/A
SELECT FABRIC:
 D1604 i-Outlier
 D2100 i-George

BACKS: Blown fiber
SEATS: Standard chaise (SS)
CAP CODES: DR, UR, UE, BU, RL

PILLOWS: N/A
FEATURES: N/A

SELECT FAUX LEATHER: N/A

SELECT LEATHER: N/A

727 BROOKS	GRADE	SELECT			CUSTOM FABRIC				CUSTOM LEATHER / PLUS				AVAILABLE OPTIONS	DIMENSIONS				
		FAB	FAUX LTH	LTH	B-C	D-F, RE	G-N	P-Q	BL	DL	FL	HL		H	W	D	RD	WT
		SH	SW	SD	AH	SF												
444727 Reclining Sofa	COST	-	-	-	-	-	-	-	-	-	-	-	FS	41	84	40	5	196
	RESALE	1299	-	-	1459	1619	1779	1939	-	-	-	-		21.5	66	21	25.5	3
U44727 Power Reclining Sofa w/ Headrest	COST	-	-	-	-	-	-	-	-	-	-	-	FS, W2	41	84	40	5	223.5
	RESALE	1939	-	-	2099	2259	2419	2579	-	-	-	-		21.5	66	21	25.5	3
X44727 Power Reclining Sofa w/ Headrest & Lumbar	COST	-	-	-	-	-	-	-	-	-	-	-	FS, W2	41	84	40	5	233.5
	RESALE	2259	-	-	2419	2579	2739	2899	-	-	-	-		21.5	66	21	25.5	3
448727 Reclining Loveseat	COST	-	-	-	-	-	-	-	-	-	-	-	FS	41	63	40	5	165
	RESALE	1259	-	-	1419	1579	1739	1899	-	-	-	-		21.5	45	21	25.5	2
U48727 Power Reclining Loveseat w/ Headrest	COST	-	-	-	-	-	-	-	-	-	-	-	FS, W2	41	63	40	5	181.5
	RESALE	1899	-	-	2059	2219	2379	2539	-	-	-	-		21.5	45	21	25.5	2
X48727 Power Reclining Loveseat w/ Headrest & Lumbar	COST	-	-	-	-	-	-	-	-	-	-	-	FS, W2	41	63	40	5	191.5
	RESALE	2219	-	-	2379	2539	2699	2859	-	-	-	-		21.5	45	21	25.5	2
449727 Reclining Loveseat w/ Console	COST	-	-	-	-	-	-	-	-	-	-	-	CB, CC, CM, FS	41	78	40	5	192
	RESALE	1409	-	-	1569	1729	1889	2049	-	-	-	-		21.5	60	21	25.5	3
U49727 Power Reclining Loveseat w/ Headrest & Console	COST	-	-	-	-	-	-	-	-	-	-	-	CB, CC, CM, FS, W2	41	75.5	40	5	175
	RESALE	2049	-	-	2209	2369	2529	2689	-	-	-	-		21.5	57.5	21	25.5	3

727 BROOKS	GRADE	SELECT			CUSTOM FABRIC				CUSTOM LEATHER / PLUS				AVAILABLE OPTIONS	DIMENSIONS				
		FAB	FAUX LTH	LTH	B-C	D-F, RE	G-N	P-Q	BL	DL	FL	HL		H	W	D	RD	WT
		SH	SW	SD	AH	SF												
X49727 Power Reclining Loveseat w/ Headrest, Lumbar & Console	COST	-	-	-	-	-	-	-	-	-	-	-	CB, CC, CM, FS, W2	41	75.5	40	5	221.5
RESALE	2369	-	-	-	2529	2689	2839	2999	-	-	-	-		21.5	57.5	21	25.5	3



General guidance, may not apply to all prefixes. Please refer to Product Info Guide for more detail by prefix.

ORDER FOB'S: 05, 06

BACKS: Blown fiber

SWIVEL: 088123, 088124, 088126, 08812T

STD FINISH: 007

SEATS: Standard chaise (SS)

TALL: 088210, 088266

OPT FINISHES: 021

CAP CODES: DR, UR, UE, BU, RL, LL, LM

FEATURES: N/A

BATTERY: 088BP1

SPECIAL INFO: N/A

SELECT FAUX LEATHER: N/A

SELECT LEATHER: N/A

D1604 i-Outlier
D2100 i-George

727 BROOKS	GRADE	SELECT			CUSTOM FABRIC				CUSTOM LEATHER / PLUS				AVAILABLE OPTIONS	DIMENSIONS				
		FAB	FAUX LTH	LTH	B-C	D-F, RE	G-N	P-Q	BL	DL	FL	HL		H	W	D	RD	WT
		SH	SW	SD	AH	SF												
010727 Rocking Recliner	COST	-	-	-	-	-	-	-	-	-	-	-	ES, FN, FS, H1, H3, L1, L3, LE, LS, SW	40.5	35	37.5	14	73
	RESALE	639	-	-	759	879	989	1109	1149	1369	1579	1789		19	21	19.5	25	1
10U727 Power Rocking Recliner w/ Headrest	COST	-	-	-	-	-	-	-	-	-	-	-	FN, FS, LW, SL	40.5	33	37.5	16	92
	RESALE	1229	-	-	1339	1459	1579	1699	1739	1949	2159	2379		19	21	19.5	25	1
10X727 Power Rocking Recliner w/ Headrest & Lumbar	COST	-	-	-	-	-	-	-	-	-	-	-	FN, FS, LW, SL	40.5	33	37.5	16	98
	RESALE	1389	-	-	1499	1619	1739	1859	1899	2109	2319	2539		19	21	19.5	25	1
016727 Wall Recliner	COST	-	-	-	-	-	-	-	-	-	-	-	ES, FN, FS, H1, H3, L1, L3, LE, LS	40.5	35	37.5	5.5	78
	RESALE	669	-	-	789	909	1029	1139	1189	1399	1609	1819		19	21	19.5	25	1
16X727 Power Wall Recliner w/ Headrest & Lumbar	COST	-	-	-	-	-	-	-	-	-	-	-	FS, LW	40.5	33	37.5	9.5	103
	RESALE	1419	-	-	1539	1649	1769	1889	1929	2139	2359	2569		19	21	19.5	25	1



General guidance, may not apply to all prefixes. Please refer to Product Info Guide for more detail by prefix.

ORDER FOB'S: 05, 06

BACKS: Blown fiber

SWIVEL: 088123, 088124, 088126, 08812T

STD FINISH: 007

SEATS: Standard (SS)

TALL: 088210, 088266

OPT FINISHES: 021

CAP CODES: DR, UR, UE, BU, RL

FEATURES: N/A

BATTERY: 088BP1

SPECIAL INFO: N/A

SELECT FAUX LEATHER: N/A

SELECT LEATHER: N/A

C1882 Lukas

C2032 Reyson

734 COLLAGE	GRADE	SELECT			CUSTOM FABRIC				CUSTOM LEATHER / PLUS				AVAILABLE OPTIONS	DIMENSIONS				
		FAB	FAUX LTH	LTH	B-C	D-F, RE	G-N	P-Q	BL	DL	FL	HL		H	W	D	RD	WT
		SH	SW	SD	AH	SF												
010734 Rocking Recliner	COST	-	-	-	-	-	-	-	-	-	-	-	ES, FN, FS, H1, H3, L1, L3, LE, LS, SW	39.5	29.5	36	12	65
	RESALE	579	-	-	699	809	929	1049	-	-	-	-		18.5	18.5	18	23	1
P10734 Power Rocking Recliner	COST	-	-	-	-	-	-	-	-	-	-	-	FN, FS, HW, LT, SL	39.5	27.5	36	12	75
	RESALE	789	-	-	909	1029	1139	1259	-	-	-	-		18.5	18.5	18	23	1
016734 Wall Recliner	COST	-	-	-	-	-	-	-	-	-	-	-	ES, FN, FS, H1, H3, L1, L3, LE, LS	39.5	29.5	36	6	75
	RESALE	609	-	-	729	839	959	1079	-	-	-	-		18.5	18.5	18	23	1
P16734 Power Wall Recliner	COST	-	-	-	-	-	-	-	-	-	-	-	FS, HW, LT	39.5	27.5	36	6	85
	RESALE	819	-	-	939	1059	1169	1289	-	-	-	-		18.5	18.5	18	23	1

General guidance, may not apply to all prefixes. Please refer to Product Info Guide for more detail by prefix.



ORDER FOB'S: 05, 06

BACKS: Foam

PILLOWS: N/A

STD FINISH: 007

SEATS: Standard seat (SS)

OPT FINISHES: 021

CAP CODES: DR, UR, DP, NP, PS, UE, VS, BU, RL, LL, LM

FEATURES: N/A

BATTERY: 088BP2

SPECIAL INFO: N/A

SELECT FAUX LEATHER: N/A

SELECT LEATHER:

D2096 Defender

D2099 i-Favorite

LB2061 Gambit - 50, 75, 78

747 FINLEY	GRADE	SELECT			CUSTOM FABRIC				CUSTOM LEATHER / PLUS				AVAILABLE OPTIONS	DIMENSIONS				
		FAB	FAUX LTH	LTH	B-C	D-F, RE	G-N	P-Q	BL	DL	FL	HL		H	W	D	RD	WT
		SH	SW	SD	AH	SF												
330747 Wall Reclining Sofa	COST	-	-	-	-	-	-	-	-	-	-	-	1H, 2E, 3H, FN, FS	43	85	38	7.5	196
	RESALE	1819	-	2609	1979	2139	2299	2459	2929	3459	3989	4529		19.5	70.5	21.5	25	3
33U747 Power Wall Reclining Sofa w/ Headrest	COST	-	-	-	-	-	-	-	-	-	-	-	FS, W2	43	81	38	7.5	229
	RESALE	2779	-	3569	2939	3099	3259	3419	3889	4419	4949	5479		19.5	70.5	21.5	25	3

747 FINLEY	GRADE	SELECT			CUSTOM FABRIC				CUSTOM LEATHER / PLUS				AVAILABLE OPTIONS	DIMENSIONS				
		FAB	FAUX LTH	LTH	B-C	D-F, RE	G-N	P-Q	BL	DL	FL	HL		H	W	D	RD	WT
		SH	SW	SD	AH	SF												
33X747 Power Wall Reclining Sofa w/ Headrest & Lumbar	COST	-	-	-	-	-	-	-	-	-	-	-	FS, W2	43	81	38	7	239
	RESALE	3099	-	3889	3259	3419	3579	3739	4209	4739	5269	5799		19.5	70.5	21.5	25	3
320747 Wall Reclining Loveseat	COST	-	-	-	-	-	-	-	-	-	-	-	1H, 2E, 3H, FN, FS	43	61	38	7.5	161
	RESALE	1779	-	2569	1939	2099	2259	2419	2889	3419	3949	4479		19.5	46.5	21.5	25	2
32U747 Power Reclining Loveseat w/ Headrest	COST	-	-	-	-	-	-	-	-	-	-	-	FS, W2	43	61	38	7.5	193
	RESALE	2739	-	3529	2899	3059	3219	3379	3839	4379	4909	5439		19.5	46.5	21.5	25	2
32X747 Power Wall Reclining Loveseat w/ Headrest & Lumbar	COST	-	-	-	-	-	-	-	-	-	-	-	FS, W2	43	61	38	7.5	203
	RESALE	3059	-	3839	3219	3379	3539	3699	4159	4699	5229	5759		19.5	46.5	21.5	25	2
339747 Wall Reclining Loveseat w/ Console	COST	-	-	-	-	-	-	-	-	-	-	-	1H, 2E, 3H, CB, CC, CM, FN, FS	43	75.5	38	7.5	210
	RESALE	1929	-	2719	2089	2249	2409	2569	3039	3569	4099	4629		19.5	61	21.5	25	3
U39747 Power Wall Reclining Loveseat w/ Headrest & Console	COST	-	-	-	-	-	-	-	-	-	-	-	CB, CC, CM, FS, W2	43	71.5	38	7.5	229
	RESALE	2889	-	3669	3049	3209	3369	3529	3989	4529	5059	5589		19.5	61	21.5	25	3
X39747 Power Wall Reclining Loveseat w/ Console Headrest & Lumbar	COST	-	-	-	-	-	-	-	-	-	-	-	CB, CC, CM, FS, W2	43	71.5	38	7.5	241
	RESALE	3209	-	3989	3369	3529	3689	3839	4309	4839	5379	5909		19.5	61	21.5	25	3



General guidance, may not apply to all prefixes. Please refer to Product Info Guide for more detail by prefix.

ORDER FOB'S: 05, 06

BACKS: Foam

SWIVEL: 088123, 088124, 088126, 08812T

STD FINISH: 007

SEATS: Ultra Plush chaise (SS)

TALL: 088210, 088266

OPT FINISHES: 021

CAP CODES: DR, UR, DP, NP, PS, UE, VS, BU, RL, LL, LM

FEATURES: N/A

BATTERY: 088BP1

SPECIAL INFO: N/A

SELECT FAUX LEATHER: N/A

SELECT LEATHER:

D2096 Defender
D2099 i-Favorite

LB2061 Gambit - 50, 75, 78

747 FINLEY	GRADE	SELECT			CUSTOM FABRIC				CUSTOM LEATHER / PLUS				AVAILABLE OPTIONS	DIMENSIONS				
		FAB	FAUX LTH	LTH	B-C	D-F, RE	G-N	P-Q	BL	DL	FL	HL		H	W	D	RD	WT
		SH	SW	SD	AH	SF												
010747 Rocking Recliner	COST	-	-	-	-	-	-	-	-	-	-	-	ES, FN, FS, H1, H3, L1, L3, LE, LS, SW	43	34	39	13.5	82
	RESALE	839	-	1149	959	1079	1199	1309	1259	1469	1689	1899		19.5	21.5	20.5	25	1
10U747 Power Rocking Recliner w/ Headrest	COST	-	-	-	-	-	-	-	-	-	-	-	FS, LW, SL	43	32	39	13.5	102.5
	RESALE	1429	-	1739	1549	1659	1779	1899	1839	2059	2269	2479		19.5	21.5	20.5	25	1
10X747 Power Rocking Recliner w/ Headrest & Lumbar	COST	-	-	-	-	-	-	-	-	-	-	-	FS, LW, SL	43	32	39	13.5	107.5
	RESALE	1589	-	1899	1709	1819	1939	2059	1999	2219	2429	2639		19.5	21.5	20.5	25	1
016747 Wall Recliner	COST	-	-	-	-	-	-	-	-	-	-	-	ES, FN, FS, H1, H3, L1, L3, LE, LS	43	34	39	7	92
	RESALE	879	-	1189	989	1109	1229	1339	1289	1499	1719	1929		19.5	21.5	20.5	25	1

747 FINLEY	GRADE	SELECT			CUSTOM FABRIC				CUSTOM LEATHER / PLUS				AVAILABLE OPTIONS	DIMENSIONS				
		FAB	FAUX LTH	LTH	B-C	D-F, RE	G-N	P-Q	BL	DL	FL	HL		H	W	D	RD	WT
		SH	SW	SD	AH	SF												
16X747 Power Wall Recliner w/ Headrest & Lumbar	COST	-	-	-	-	-	-	-	-	-	-	-	FS, LW	43	32	39	7	123.5
	RESALE	1619	-	1929	1739	1859	1969	2089	2039	2249	2459	2669		19.5	21.5	20.5	25	1
017747 Swivel Gliding Recliner	COST	-	-	-	-	-	-	-	-	-	-	-	ES, FN, FS, H1, H3, L1, L3, LE, LS	43	34	39	12	116
	RESALE	999	-	1309	1119	1239	1359	1469	1419	1629	1839	2059		19.5	21.5	20.5	25	1

General guidance, may not apply to all prefixes. Please refer to Product Info Guide for more detail by prefix.



ORDER FOB'S: 05, 06

BACKS: Blown fiber

PILLOWS: N/A

STD FINISH: N/A

SEATS: 444 sculpted-bucket chaise (SS)

OPT FINISHES: N/A

CAP CODES: DR, UR, UE, BU, RL, LL, LM

FEATURES: N/A

BATTERY: 088BP2

SPECIAL INFO: N/A

SELECT FAUX LEATHER:

SELECT LEATHER:

D1905 York

D1855 i-Rivers

LB2112 Highbrow - 75, 78

755 DORIAN	GRADE	SELECT			CUSTOM FABRIC				CUSTOM LEATHER / PLUS				AVAILABLE OPTIONS	DIMENSIONS				
		FAB	FAUX LTH	LTH	B-C	D-F, RE	G-N	P-Q	BL	DL	FL	HL		H	W	D	RD	WT
		SH	SW	SD	AH	SF												
444755 Reclining Sofa	COST	-	-	-	-	-	-	-	-	-	-	-	FS	44	86	39.5	9	217.5
	RESALE	1729	1759	2609	1889	2049	2209	2369	2929	3459	3989	4529		20.5	68	21.5	26.5	3
U44755 Power Reclining Sofa w/ Headrest	COST	-	-	-	-	-	-	-	-	-	-	-	FS, W2	44	86	39.5	9	251.5
	RESALE	2369	2399	3249	2529	2689	2839	2999	3569	4099	4629	5159		20.5	68	21.5	26.5	3
X44755 Power Reclining Sofa w/ Headrest & Lumbar	COST	-	-	-	-	-	-	-	-	-	-	-	FS, W2	44	86	39.5	9	261.5
	RESALE	2689	2719	3569	2839	2999	3159	3319	3889	4419	4949	5479		20.5	68	21.5	26.5	3
448755 Reclining Loveseat	COST	-	-	-	-	-	-	-	-	-	-	-	FS	44	63	39.5	9	179.5
	RESALE	1689	1719	2569	1839	1999	2159	2319	2889	3419	3949	4479		20.5	45	21.5	26.5	2
U48755 Power Reclining Loveseat w/ Headrest	COST	-	-	-	-	-	-	-	-	-	-	-	FS, W2	44	63	39.5	9	213.5
	RESALE	2319	2359	3209	2479	2639	2799	2959	3529	4059	4589	5119		20.5	45	21.5	26.5	2
X48755 Power Reclining Loveseat w/ Headrest & Lumbar	COST	-	-	-	-	-	-	-	-	-	-	-	FS, W2	44	63	39.5	9	223.5
	RESALE	2639	2669	3529	2799	2959	3119	3279	3839	4379	4909	5439		20.5	45	21.5	26.5	2
449755 Reclining Loveseat w/ Console	COST	-	-	-	-	-	-	-	-	-	-	-	CB, CC, CM, FS	44	78	39.5	9	206.5
	RESALE	1829	1869	2719	1989	2149	2309	2469	3039	3569	4099	4629		20.5	60	21.5	26.5	3
U49755 Power Reclining Loveseat w/ Headrest & Console	COST	-	-	-	-	-	-	-	-	-	-	-	CB, CC, CM, FS, W2	44	78	39.5	9	240.5
	RESALE	2469	2499	3359	2629	2789	2949	3109	3669	4209	4739	5269		20.5	60	21.5	26.5	3
X49755 Power Reclining Loveseat w/ Headrest, Lumbar & Console	COST	-	-	-	-	-	-	-	-	-	-	-	CB, CC, CM, FS, W2	44	78	39.5	9	250.5
	RESALE	2789	2819	3669	2949	3109	3269	3429	3989	4529	5059	5589		20.5	60	21.5	26.5	3



General guidance, may not apply to all prefixes. Please refer to Product Info Guide for more detail by prefix.

ORDER FOB'S: 05, 06

BACKS: Blown fiber

SWIVEL: 088123, 088124, 088126, 08812T

STD FINISH: 007

SEATS: Sculpted-bucket chaise (SS)

TALL: 088210, 088266

OPT FINISHES: 021

CAP CODES: DR, UR, UE, BU, RL, LL, LM

FEATURES: N/A

BATTERY: 088BP1

SPECIAL INFO: N/A

SELECT FAUX LEATHER:

SELECT LEATHER:

D1905 York

D1855 i-Rivers

LB2112 Highbrow - 75, 78

755 DORIAN	GRADE	SELECT			CUSTOM FABRIC				CUSTOM LEATHER / PLUS				AVAILABLE OPTIONS	DIMENSIONS				
		FAB	FAUX LTH	LTH	B-C	D-F, RE	G-N	P-Q	BL	DL	FL	HL		H	W	D	RD	WT
		SH	SW	SD	AH	SF												
010755 Rocking Recliner	COST	-	-	-	-	-	-	-	-	-	-	-	ES, FN, FS, H1, H3, L1, L3, LE, LS, SW	43.5	38	39	13.5	91
	RESALE	839	859	1219	959	1079	1199	1309	1319	1539	1749	1959		19.5	20.5	21	25.5	1
10U755 Power Rocking Recliner w/ Headrest	COST	-	-	-	-	-	-	-	-	-	-	-	FN, FS, LW, SL	43.5	36	39	13.5	108
	RESALE	1429	1439	1799	1549	1659	1779	1899	1909	2119	2329	2549		19.5	20.5	21	25.5	1
10X755 Power Rocking Recliner w/ Headrest & Lumbar	COST	-	-	-	-	-	-	-	-	-	-	-	FN, FS, LW, SL	43.5	36	39	13.5	113
	RESALE	1589	1599	1959	1709	1819	1939	2059	2069	2279	2489	2709		19.5	20.5	21	25.5	1
016755 Wall Recliner	COST	-	-	-	-	-	-	-	-	-	-	-	ES, FN, FS, H1, H3, L1, L3, LE, LS	43.5	38	39	7	101
	RESALE	879	889	1249	989	1109	1229	1339	1359	1569	1779	1989		19.5	20.5	21	25.5	1
16X755 Power Wall Recliner w/ Headrest & Lumbar	COST	-	-	-	-	-	-	-	-	-	-	-	FS, LW	43.5	36	39	7	121
	RESALE	1619	1629	1989	1739	1859	1969	2089	2099	2309	2529	2739		19.5	20.5	21	25.5	1

General guidance, may not apply to all prefixes. Please refer to Product Info Guide for more detail by prefix.



ORDER FOB'S: 05, 06

BACKS: Foam

PILLOWS: N/A

STD FINISH: N/A

SEATS: 444 sculpted-bucket chaise (SS)

OPT FINISHES: N/A

CAP CODES: DR, UR, UE, BU, RL, LL, LM

FEATURES: N/A

BATTERY: 088BP2

SPECIAL INFO: Drop down table surface only available in Sable finish.

SELECT FAUX LEATHER:

SELECT LEATHER:

D2072 i-Nolina

D1855 i-Rivers

LB1930 (WQL) Salvo - 56, 59, 77
LB2112 Highbrow - 68, 76

757 APOLLO	GRADE	SELECT			CUSTOM FABRIC				CUSTOM LEATHER / PLUS				AVAILABLE OPTIONS	DIMENSIONS				
		FAB	FAUX LTH	LTH	B-C	D-F, RE	G-N	P-Q	BL	DL	FL	HL		H	W	D	RD	WT
		SH	SW	SD	AH	SF												
444757 Reclining Sofa	COST	-	-	-	-	-	-	-	-	-	-	-	FS	42	85.5	40	5	204.5
	RESALE	1729	1759	2469	1889	2049	2209	2369	2789	3319	3859	4389		20.5	67.5	22	25	3

757 APOLLO		GRADE	SELECT			CUSTOM FABRIC				CUSTOM LEATHER / PLUS				AVAILABLE OPTIONS	DIMENSIONS				
			FAB	FAUX LTH	LTH	B-C	D-F, RE	G-N	P-Q	BL	DL	FL	HL		H	W	D	RD	WT
			SH	SW	SD	AH	SF												
U44757	Power Reclining Sofa w/ Headrest	COST	-	-	-	-	-	-	-	-	-	-	-	FS, W2	42	85.5	40	5	228.5
		RESALE	2369	2399	3109	2529	2689	2839	2999	3429	3959	4489	5029		20.5	67.5	22	25	3
X44757	Power Reclining Sofa w/ Headrest & Lumbar	COST	-	-	-	-	-	-	-	-	-	-	-	FS, W2	42	85.5	40	5	238.5
		RESALE	2689	2719	3429	2839	2999	3159	3319	3749	4279	4809	5339		20.5	67.5	22	25	3
NEW! 446757	Reclining Sofa w/ Drop Down Table	COST	-	-	-	-	-	-	-	-	-	-	-	FS	42	85.5	40	5	-
		RESALE	1989	2029	2739	2149	2309	2469	2629	3059	3589	4119	4649		20.5	67.5	22	25	3
NEW! U46757	Power Reclining Sofa w/ Headrest & Drop Down Table	COST	-	-	-	-	-	-	-	-	-	-	-	FS, W2	42	85.5	40	5	-
		RESALE	2629	2659	3379	3109	3269	3429	3589	4019	4549	5079	5609		20.5	67.5	22	25	3
NEW! X46757	Power Reclining Sofa w/ Headrest, Lumbar and Drop Down Table	COST	-	-	-	-	-	-	-	-	-	-	-	FS, W2	42	85.5	40	5	-
		RESALE	2949	2979	3699	3429	3589	3749	3909	4329	4869	5399	5929		20.5	67.5	22	25	3
448757	Reclining Loveseat	COST	-	-	-	-	-	-	-	-	-	-	-	FS	42	62.5	40	5	166.5
		RESALE	1689	1719	2429	1839	1999	2159	2319	2749	3279	3809	4339		21	45.5	22	25.5	2
U48757	Power Reclining Loveseat w/ Headrest	COST	-	-	-	-	-	-	-	-	-	-	-	FS, W2	42	62.5	40	5	190.5
		RESALE	2319	2359	3069	2479	2639	2799	2959	3389	3919	4449	4979		21	45.5	22	25.5	2
X48757	Power Reclining Loveseat w/ Headrest & Lumbar	COST	-	-	-	-	-	-	-	-	-	-	-	FS, W2	42	62.5	40	5	200.5
		RESALE	2639	2669	3389	2799	2959	3119	3279	3709	4239	4769	5299		21	45.5	22	25.5	2
449757	Reclining Loveseat w/ Console	COST	-	-	-	-	-	-	-	-	-	-	-	CB, CC, CM, FS	42	77	40	5	193.5
		RESALE	1829	1869	2579	1989	2149	2309	2469	2899	3429	3959	4489		20.5	67.5	22	25	3
U49757	Power Reclining Loveseat w/ Headrest & Console	COST	-	-	-	-	-	-	-	-	-	-	-	CB, CC, CM, FS, W2	42	77	40	5	217.5
		RESALE	2469	2499	3219	2629	2789	2949	3109	3539	4069	4599	5129		20.5	67.5	22	25	3
X49757	Power Reclining Loveseat w/ Headrest, Lumbar & Console	COST	-	-	-	-	-	-	-	-	-	-	-	CB, CC, CM, FS, W2	42	77	40	5	227.5
		RESALE	2789	2819	3539	2949	3109	3269	3429	3859	4389	4919	5449		20.5	67.5	22	25	3



General guidance, may not apply to all prefixes. Please refer to Product Info Guide for more detail by prefix.

ORDER FOB'S: 05, 06 **BACKS:** Foam **SWIVEL:** 088123, 088124, 088126, 08812T
STD FINISH: 007 **SEATS:** Sculpted bucket chaise (SS) **TALL:** 088210, 088266
OPT FINISHES: 021 **CAP CODES:** DR, UR, UE, BU, RL, LL, LM **FEATURES:** N/A
BATTERY: 088BP1
SPECIAL INFO: N/A
SELECT FABRIC: D2072 i-Nolina **SELECT FAUX LEATHER:** D1855 i-Rivers **SELECT LEATHER:** LB1930 (WQL) Salvo - 56, 59, 77
 LB2112 Highbrow - 68, 76

757 APOLLO RECLINER	GRADE	SELECT			CUSTOM FABRIC				CUSTOM LEATHER / PLUS				AVAILABLE OPTIONS	DIMENSIONS				
		FAB	FAUX LTH	LTH	B-C	D-F, RE	G-N	P-Q	BL	DL	FL	HL		H	W	D	RD	WT
		SH	SW	SD	AH	SF												
010757 Rocking Recliner	COST	-	-	-	-	-	-	-	-	-	-	-	ES, FN, FS, H1, H3, L1, L3, LE, LS, SW	42	38	37	15	83
	RESALE	839	859	1149	959	1079	1199	1309	1259	1469	1689	1899		20	22	21	25	1
10U757 Power Rocking Recliner w/ Headrest	COST	-	-	-	-	-	-	-	-	-	-	-	FN, FS, LW, SL	42	36	37	15	102
	RESALE	1429	1439	1739	1549	1659	1779	1899	1839	2059	2269	2479		20	22	21	25	1
10X757 Power Rocking Recliner w/ Headrest & Lumbar	COST	-	-	-	-	-	-	-	-	-	-	-	FN, FS, LW, SL	42	36	37	15	108
	RESALE	1589	1599	1899	1709	1819	1939	2059	1999	2219	2429	2639		20	22	21	25	1
016757 Wall Recliner	COST	-	-	-	-	-	-	-	-	-	-	-	ES, FN, FS, H1, H3, L1, L3, LE, LS	42	38	37	5	93
	RESALE	879	889	1189	989	1109	1229	1339	1289	1499	1719	1929		20	22	21	25	1
16X757 Power Wall Recliner w/ Headrest & Lumbar	COST	-	-	-	-	-	-	-	-	-	-	-	FS, LW	42	36	37	5	113
	RESALE	1619	1629	1929	1739	1859	1969	2089	2039	2249	2459	2669		20	22	21	25	1

General guidance, may not apply to all prefixes. Please refer to Product Info Guide for more detail by prefix.

ORDER FOB'S: 05, 06 **BACKS:** Blown fiber **PILLOWS:** N/A
STD FINISH: N/A **SEATS:** Standard chaise (SS)
OPT FINISHES: N/A **CAP CODES:** DR, UR, UE, BU, RL, LL, LM **FEATURES:** N/A
BATTERY: 088BP1
SPECIAL INFO: N/A
SELECT FABRIC: D2027 i-Weekend **SELECT FAUX LEATHER:** D1855 i-Rivers **SELECT LEATHER:** LB1929 Topflight - 59, 76



759 MADDOX	GRADE	SELECT			CUSTOM FABRIC				CUSTOM LEATHER / PLUS				AVAILABLE OPTIONS	DIMENSIONS				
		FAB	FAUX LTH	LTH	B-C	D-F, RE	G-N	P-Q	BL	DL	FL	HL		H	W	D	RD	WT
		SH	SW	SD	AH	SF												
44A759 Left-Arm SITTING Recliner	COST	-	-	-	-	-	-	-	-	-	-	-	FS	42	40	40	4	102
	RESALE	799	809	1189	919	1039	1149	1269	1289	1499	1719	1929		21.5	32	22	25	2

759 MADDOX		GRADE	SELECT			CUSTOM FABRIC				CUSTOM LEATHER / PLUS				AVAILABLE OPTIONS	DIMENSIONS				
			FAB	FAUX LTH	LTH	B-C	D-F, RE	G-N	P-Q	BL	DL	FL	HL		H	W	D	RD	WT
			SH	SW	SD	AH	SF												
U4A759	Power Left-Arm SITTING Recliner w/ Headrest	COST	-	-	-	-	-	-	-	-	-	-	-	FS, LW	42	40	40	4	119
		RESALE	1119	1129	1499	1239	1359	1469	1589	1609	1819	2039	2249		21.5	32	22	25	2
X4A759	Power Left-Arm SITTING Recliner w/ Headrest and Lumbar	COST	-	-	-	-	-	-	-	-	-	-	-	FS, LW	42	40	40	4	127
		RESALE	1279	1289	1659	1399	1519	1629	1749	1769	1979	2199	2409		21.5	32	22	25	2
44B759	Right-Arm SITTING Recliner	COST	-	-	-	-	-	-	-	-	-	-	-	FS	42	40	40	4	102
		RESALE	799	809	1189	919	1039	1149	1269	1289	1499	1719	1929		21.5	32	22	25	2
U4B759	Power Right-Arm SITTING Recliner w/ Headrest	COST	-	-	-	-	-	-	-	-	-	-	-	FS, RW	42	40	40	4	119
		RESALE	1119	1129	1499	1239	1359	1469	1589	1609	1819	2039	2249		21.5	32	22	25	2
X4B759	Power Right-Arm SITTING Recliner w/ Headrest and Lumbar	COST	-	-	-	-	-	-	-	-	-	-	-	FS, RW	42	40	40	4	127
		RESALE	1279	1289	1659	1399	1519	1629	1749	1769	1979	2199	2409		21.5	32	22	25	2
44C759	Rounded Corner Unit	COST	-	-	-	-	-	-	-	-	-	-	-	FS	42	62	37	-	72
		RESALE	979	999	1149	1139	1299	1459	1619	1469	1999	2539	3069		21.5	-	22	-	2
M44759	Armless Chair	COST	-	-	-	-	-	-	-	-	-	-	-	FS	42	32	40	-	61
		RESALE	599	609	829	719	829	949	1069	939	1149	1369	1579		21.5	-	22	-	2
SC4759	Storage Console	COST	-	-	-	-	-	-	-	-	-	-	-	CB, CC, CM	38.5	14.5	37.5	-	58
		RESALE	629	639	859	689	739	789	839	909	1019	1119	1229		-	-	-	-	1
44S759	Armless Recliner	COST	-	-	-	-	-	-	-	-	-	-	-	FS	42	32	40	4	82
		RESALE	709	719	939	819	939	1059	1169	1049	1259	1469	1689		21.5	-	22	-	2
U4S759	Power Armless Recliner w/ Headrest	COST	-	-	-	-	-	-	-	-	-	-	-	FS, RW	42	32	40	4	97
		RESALE	1029	1039	1259	1139	1259	1379	1489	1369	1579	1789	1999		21.5	32	22	-	2
X4S759	Power Armless Recliner w/ Headrest and Lumbar	COST	-	-	-	-	-	-	-	-	-	-	-	FS, RW	42	32	40	4	102
		RESALE	1189	1199	1419	1299	1419	1539	1649	1529	1739	1949	2159		21.5	32	22	-	2
44Q759	Left-Arm SITTING Reclining Chaise	COST	-	-	-	-	-	-	-	-	-	-	-	FS	42	42	65.5	9	113
		RESALE	1129	1149	1639	1289	1449	1609	1769	1959	2489	3029	3559		21.5	33.5	49	25	2
U4Q759	Power Left-Arm SITTING Reclining Chaise w/ Headrest	COST	-	-	-	-	-	-	-	-	-	-	-	FS, LW	42	42	65.5	9	121
		RESALE	1449	1469	1959	1609	1769	1929	2089	2279	2809	3339	3879		21.5	33.5	49	25	2
X4Q759	Power Left-Arm SITTING Reclining Chaise w/ Headrest and Lumbar	COST	-	-	-	-	-	-	-	-	-	-	-	FS, LW	42	42	65.5	9	127
		RESALE	1609	1629	2119	1769	1929	2089	2249	2439	2969	3499	4039		21.5	33.5	49	25	2
44V759	Right-Arm SITTING Reclining Chaise	COST	-	-	-	-	-	-	-	-	-	-	-	FS	42	42	65.5	9	113
		RESALE	1129	1149	1639	1289	1449	1609	1769	1959	2489	3029	3559		21.5	33.5	49	25	2
U4V759	Power Right-Arm SITTING Reclining Chaise w/ Headrest	COST	-	-	-	-	-	-	-	-	-	-	-	FS, RW	42	42	65.5	9	121
		RESALE	1449	1469	1959	1609	1769	1929	2089	2279	2809	3339	3879		21.5	33.5	49	25	2
X4V759	Power Right-Arm SITTING Reclining Chaise w/ Headrest and Lumbar	COST	-	-	-	-	-	-	-	-	-	-	-	FS, RW	42	42	65.5	9	127
		RESALE	1609	1629	2119	1769	1929	2089	2249	2439	2969	3499	4039		21.5	33.5	49	25	2

General guidance, may not apply to all prefixes. Please refer to Product Info Guide for more detail by prefix.



ORDER FOB'S: 05, 06

STD FINISH: N/A

OPT FINISHES: N/A

BATTERY: 088BP2

SPECIAL INFO: N/A

SELECT FABRIC:

D2027 i-Weekend

BACKS: Blown fiber

SEATS: Standard chaise (SS)

CAP CODES: DR, UR, UE, BU, RL, LL, LM

SELECT FAUX LEATHER:

D1855 i-Rivers

PILLOWS: N/A

FEATURES: N/A

SELECT LEATHER:

LB1929 Topflight - 59, 76

759 MADDOX	GRADE	SELECT			CUSTOM FABRIC				CUSTOM LEATHER / PLUS				AVAILABLE OPTIONS	DIMENSIONS				
		FAB	FAUX LTH	LTH	B-C	D-F, RE	G-N	P-Q	BL	DL	FL	HL		H	W	D	RD	WT
		SH	SW	SD	AH	SF												
DISC! 443759 Reclining 2-seat Sofa	COST	-	-	-	-	-	-	-	-	-	-	-	FS	42	80	40	4	188
	RESALE	1429	1449	2069	1589	1749	1909	2069	2389	2919	3449	3979		21.5	63	22	25	3
DISC! U43759 Power Reclining 2-seat Sofa w/ Headrest	COST	-	-	-	-	-	-	-	-	-	-	-	FS, W2	42	80	40	4	212
	RESALE	2069	2089	2709	2229	2389	2549	2709	3029	3559	4089	4619		21.5	63	22	25	3
DISC! X43759 Power Reclining 2-Seat Sofa w/ Headrest and Lumbar	COST	-	-	-	-	-	-	-	-	-	-	-	FS, W2	42	80	40	4	222
	RESALE	2389	2409	3029	2549	2709	2869	3029	3339	3879	4409	4939		21.5	63	22	25	3
445759 Reclining Chair & A Half	COST	-	-	-	-	-	-	-	-	-	-	-	FS	42	48	40	4	108
	RESALE	1139	1159	1729	1259	1379	1489	1609	1829	2049	2259	2469		21.5	32	22	25	2
U45759 Power Reclining Chair & a Half w/ Headrest	COST	-	-	-	-	-	-	-	-	-	-	-	FS, LT, LW, RW	42	48	40	4	120
	RESALE	1459	1479	2049	1579	1699	1809	1929	2149	2369	2579	2789		21.5	32	22	25	2
X45759 Power Reclining Chair and A Half w/ Headrest and Lumbar	COST	-	-	-	-	-	-	-	-	-	-	-	FS, LT, LW, RW	42	48	40	4	126
	RESALE	1619	1639	2209	1739	1859	1969	2089	2309	2529	2739	2949		21.5	32	22	25	2



General guidance, may not apply to all prefixes. Please refer to Product Info Guide for more detail by prefix.

ORDER FOB'S: 05, 06 **BACKS:** Blown fiber **SWIVEL:** 088123, 088124, 088126, 08812T
STD FINISH: 007 **SEATS:** Standard chaise (SS) **TALL:** 088210, 088266
OPT FINISHES: 021 **CAP CODES:** DR, UR, UE, BU, RL, LL, LM **FEATURES:** N/A
BATTERY: 088BP1
SPECIAL INFO: N/A
SELECT FABRIC: D2027 i-Weekend **SELECT FAUX LEATHER:** D1855 i-Rivers **SELECT LEATHER:** LB1929 Topflight - 59, 76

759 MADDOX	GRADE	SELECT			CUSTOM FABRIC				CUSTOM LEATHER / PLUS				AVAILABLE OPTIONS	DIMENSIONS				
		FAB	FAUX LTH	LTH	B-C	D-F, RE	G-N	P-Q	BL	DL	FL	HL		H	W	D	RD	WT
														SH	SW	SD	AH	SF
010759 Rocking Recliner	COST	-	-	-	-	-	-	-	-	-	-	-	ES, FN, FS, H1, H3, L1, L3, LE, LS, SW	43	39	40.5	12	90
	RESALE	879	889	1319	989	1109	1229	1339	1429	1639	1859	2069		20	22	22	25	1
10U759 Power Rocking Recliner w/ Headrest	COST	-	-	-	-	-	-	-	-	-	-	-	FN, FS, LW, SL	43	37	40.5	12	109
	RESALE	1459	1469	1909	1579	1699	1809	1929	2019	2229	2439	2649		20	22	22	25	1
10X759 Power Rocking Recliner w/ Headrest & Lumbar	COST	-	-	-	-	-	-	-	-	-	-	-	FN, FS, LW, SL	43	37	40.5	12	115
	RESALE	1619	1629	2069	1739	1859	1969	2089	2169	2389	2599	2809		20	22	22	25	1
016759 Wall Recliner	COST	-	-	-	-	-	-	-	-	-	-	-	ES, FN, FS, H1, H3, L1, L3, LE, LS	43	39	40.5	2	100
	RESALE	909	919	1359	1029	1139	1259	1379	1459	1669	1889	2099		20	22	22	25	1
16X759 Power Wall Recliner w/ Headrest & Lumbar	COST	-	-	-	-	-	-	-	-	-	-	-	FS, LW	43	37	40.5	2	120
	RESALE	1649	1659	2099	1769	1889	1999	2119	2209	2419	2629	2839		20	22	22	25	1

General guidance, may not apply to all prefixes. Please refer to Product Info Guide for more detail by prefix.



ORDER FOB'S: 05, 06 **BACKS:** Blown fiber **PILLOWS:** N/A
STD FINISH: N/A **SEATS:** Ultra Plush chaise (SS) **FEATURES:** N/A
OPT FINISHES: N/A **CAP CODES:** DR, UR, UE, BU, RL
BATTERY: 088BP2
SPECIAL INFO: N/A **SELECT FAUX LEATHER:** N/A **SELECT LEATHER:** N/A
SELECT FABRIC: B1808 Social Club
C1754 Kemet

761 JOEL	GRADE	SELECT			CUSTOM FABRIC				CUSTOM LEATHER / PLUS				AVAILABLE OPTIONS	DIMENSIONS				
		FAB	FAUX LTH	LTH	B-C	D-F, RE	G-N	P-Q	BL	DL	FL	HL		H	W	D	RD	WT
														SH	SW	SD	AH	SF
444761 Reclining Sofa	COST	-	-	-	-	-	-	-	-	-	-	-	FS	43	90	40	5	201
	RESALE	1429	-	-	1589	1749	1909	2069	-	-	-	-		21.5	67.5	21.5	26	3

761 JOEL	GRADE	SELECT			CUSTOM FABRIC				CUSTOM LEATHER / PLUS				AVAILABLE OPTIONS	DIMENSIONS				
		FAB	FAUX LTH	LTH	B-C	D-F, RE	G-N	P-Q	BL	DL	FL	HL		H	W	D	RD	WT
		SH	SW	SD	AH	SF												
U44761 Power Reclining Sofa w/ Headrest	COST	-	-	-	-	-	-	-	-	-	-	-	FS, W2	43	90	40	5	224.5
	RESALE	2069	-	-	2229	2389	2549	2709	-	-	-	-		21.5	67.5	21.5	26	3
X44761 Power Reclining Sofa w/ Headrest & Lumbar	COST	-	-	-	-	-	-	-	-	-	-	-	FS, W2	43	90	40	5	234.5
	RESALE	2389	-	-	2549	2709	2869	3029	-	-	-	-		21.5	67.5	21.5	26	3
448761 Reclining Loveseat	COST	-	-	-	-	-	-	-	-	-	-	-	FS	43	67	40	5	163
	RESALE	1389	-	-	1549	1709	1869	2029	-	-	-	-		21.5	44.5	21.5	26	2
U48761 Power Reclining Loveseat w/ Headrest	COST	-	-	-	-	-	-	-	-	-	-	-	FS, W2	43	67	40	5	186.5
	RESALE	2029	-	-	2189	2339	2499	2659	-	-	-	-		21.5	44.5	21.5	26	2
X48761 Power Reclining Loveseat w/ Headrest & Lumbar	COST	-	-	-	-	-	-	-	-	-	-	-	FS, W2	43	67	40	5	196.5
	RESALE	2339	-	-	2499	2659	2819	2979	-	-	-	-		21.5	44.5	21.5	26	2
449761 Reclining Loveseat w/ Console	COST	-	-	-	-	-	-	-	-	-	-	-	CB, CC, CM, FS	43	81.5	40	5	190
	RESALE	1539	-	-	1699	1859	2019	2169	-	-	-	-		21.5	59	21.5	26	3
U49761 Power Reclining Loveseat w/ Headrest & Console	COST	-	-	-	-	-	-	-	-	-	-	-	CB, CC, CM, FS, W2	43	81.5	40	5	180
	RESALE	2169	-	-	2329	2489	2649	2809	-	-	-	-		21.5	59	21.5	26	3
X49761 Power Reclining Loveseat w/ Headrest, Lumbar & Console	COST	-	-	-	-	-	-	-	-	-	-	-	CB, CC, CM, FS, W2	43	81.5	40	5	226.5
	RESALE	2489	-	-	2649	2809	2969	3129	-	-	-	-		21.5	59	21.5	26	3



General guidance, may not apply to all prefixes. Please refer to Product Info Guide for more detail by prefix.

ORDER FOB'S: 05, 06

BACKS: Blown fiber

SWIVEL: 088123, 088124, 088126, 08812T

STD FINISH: 007

SEATS: Ultra Plush chaise (SS)

TALL: 088210, 088266

OPT FINISHES: 021

CAP CODES: DR, UR, UE, BU, RL

FEATURES: N/A

BATTERY: 088BP1

SPECIAL INFO: N/A

SELECT FABRIC:

SELECT FAUX LEATHER: N/A

SELECT LEATHER: N/A

B1808 Social Club
C1754 Kemet

761 JOEL	GRADE	SELECT			CUSTOM FABRIC				CUSTOM LEATHER / PLUS				AVAILABLE OPTIONS	DIMENSIONS				
		FAB	FAUX LTH	LTH	B-C	D-F, RE	G-N	P-Q	BL	DL	FL	HL		H	W	D	RD	WT
		SH	SW	SD	AH	SF												
010761 Rocking Recliner	COST	-	-	-	-	-	-	-	-	-	-	-	ES, FN, FS, H1, H3, L1, L3, LE, LS, SW	42	40	39	16	77
	RESALE	689	-	-	799	919	1039	1149	-	-	-	-		20	21	20	25	1
10U761 Power Rocking Recliner w/ Headrest	COST	-	-	-	-	-	-	-	-	-	-	-	FN, FS, LW, SL	42	38	39	16	93
	RESALE	1269	-	-	1389	1499	1619	1739	-	-	-	-		20	21	20	25	1
10X761 Power Rocking Recliner w/ Headrest & Lumbar	COST	-	-	-	-	-	-	-	-	-	-	-	FN, FS, LW, SL	42	38	39	16	98
	RESALE	1429	-	-	1549	1659	1779	1899	-	-	-	-		20	21	20	25	1

761 JOEL	GRADE	SELECT			CUSTOM FABRIC				CUSTOM LEATHER / PLUS				AVAILABLE OPTIONS	DIMENSIONS				
		FAB	FAUX LTH	LTH	B-C	D-F, RE	G-N	P-Q	BL	DL	FL	HL		H	W	D	RD	WT
		SH	SW	SD	AH	SF												
016761 Wall Recliner	COST	-	-	-	-	-	-	-	-	-	-	-	ES, FN, FS, H1, H3, L1, L3, LE, LS	42	40	39	7	87
	RESALE	719	-	-	829	949	1069	1189	-	-	-	-		20	21	20	25	1
16X761 Power Wall Recliner w/ Headrest & Lumbar	COST	-	-	-	-	-	-	-	-	-	-	-	FS, LW	42	38	39	7	119
	RESALE	1459	-	-	1579	1699	1809	1929	-	-	-	-		20	21	20	25	1



General guidance, may not apply to all prefixes. Please refer to Product Info Guide for more detail by prefix.

ORDER FOB'S: 05, 06

STD FINISH: 007

OPT FINISHES: 021

BATTERY: 088BP1

SPECIAL INFO: N/A

SELECT FABRIC:
E1652 i-Liv

BACKS: Foam and blown fiber

SEATS: Standard seat (SS)

CAP CODES: DR, UR, UE, BU, RL, LL, LM

SELECT FAUX LEATHER:
D1825 i-Raven Crest

SWIVEL: 088126, 08812T

TALL: 088210, 088266

FEATURES: Wireless remote, (1) Silver cupholder, (2) push-to-open storage bins on outside arms, (1) wireless charging tray, and (1) accessory grommet, and (1) removable tablet/device holder

SELECT LEATHER:
LB1804 Elite - 59, 74

762 NEO	GRADE	SELECT			CUSTOM FABRIC				CUSTOM LEATHER / PLUS				AVAILABLE OPTIONS	DIMENSIONS				
		FAB	FAUX LTH	LTH	B-C	D-F, RE	G-N	P-Q	BL	DL	FL	HL		H	W	D	RD	WT
		SH	SW	SD	AH	SF												
10X762 Power Rocking Recliner w/ Headrest & Lumbar	COST	-	-	-	-	-	-	-	-	-	-	-	FN, FS, LW, SL	42	35.5	39	13	138
	RESALE	1809	1819	2259	1929	2049	2159	2279	2369	2579	2789	2999		21	22	23.5	24.5	1
16X762 Power Wall Recliner w/ Headrest & Lumbar	COST	-	-	-	-	-	-	-	-	-	-	-	FS, LW	42	35.5	39	3	134
	RESALE	1839	1859	2289	1959	2079	2199	2309	2399	2609	2819	3039		21	22	23.5	24.5	1



General guidance, may not apply to all prefixes. Please refer to Product Info Guide for more detail by prefix.

ORDER FOB'S: 05, 06

BACKS: Blown fiber

SWIVEL: 088123, 088124, 088126, 08812T

STD FINISH: 007

SEATS: Sculpted-bucket chaise (SS)

TALL: 088210, 088266

OPT FINISHES: 021

CAP CODES: DR, UR, NP, UE, VS, BU, RL, LL, LM

FEATURES: Welt trim on back, arm posts, and chaise

BATTERY: 088BP1

SPECIAL INFO: N/A

SELECT FAUX LEATHER: N/A

SELECT LEATHER: LB2061 Gambit - 32, 59, 78

C1700 Nico
D2010 i-Rene

765 ROWAN	GRADE	SELECT			CUSTOM FABRIC				CUSTOM LEATHER / PLUS				AVAILABLE OPTIONS	DIMENSIONS				
		FAB	FAUX LTH	LTH	B-C	D-F, RE	G-N	P-Q	BL	DL	FL	HL		H	W	D	RD	WT
														SH	SW	SD	AH	SF
010765 Rocking Recliner	COST	-	-	-	-	-	-	-	-	-	-	-	ES, FN, FS, H1, H3, L1, L3, LE, LS, SW	41	34	39	11.5	70
	RESALE	689	-	999	799	919	1039	1149	1109	1319	1539	1749		20	22.5	21	25	1
10U765 Power Rocking Recliner w/ Headrest	COST	-	-	-	-	-	-	-	-	-	-	-	FN, FS, LW, SL	41	32	39	11.5	91
	RESALE	1269	-	1589	1389	1499	1619	1739	1699	1909	2119	2329		20	22.5	21	25	1
10X765 Power Rocking Recliner w/ Headrest & Lumbar	COST	-	-	-	-	-	-	-	-	-	-	-	FN, FS, LW, SL	41	32	39	11.5	96
	RESALE	1429	-	1749	1549	1659	1779	1899	1859	2069	2279	2489		20	22.5	21	25	1
016765 Wall Recliner	COST	-	-	-	-	-	-	-	-	-	-	-	ES, FN, FS, H1, H3, L1, L3, LE, LS	41	34	39	6	77
	RESALE	719	-	1039	829	949	1069	1189	1139	1359	1569	1779		20	22.5	21	25	1
16X765 Power Wall Recliner w/ Headrest & Lumbar	COST	-	-	-	-	-	-	-	-	-	-	-	FS, LW	41	32	39	6	106
	RESALE	1459	-	1779	1579	1699	1809	1929	1889	2099	2309	2529		20	22.5	21	25	1

General guidance, may not apply to all prefixes. Please refer to Product Info Guide for more detail by prefix.



ORDER FOB'S: 05, 06

BACKS: Blown fiber

PILLOWS: N/A

STD FINISH: 007

SEATS: Standard chaise (SS)

OPT FINISHES: 021

CAP CODES: DR, UR, UE, BU, RL, LL, LM

FEATURES: N/A

BATTERY: 088BP2

SPECIAL INFO: Drop down table surface only available in Sable finish.

SELECT FAUX LEATHER: N/A

SELECT LEATHER: N/A

B1538 Seamount
D2116 Rome

766 MORRISON	GRADE	SELECT			CUSTOM FABRIC				CUSTOM LEATHER / PLUS				AVAILABLE OPTIONS	DIMENSIONS				
		FAB	FAUX LTH	LTH	B-C	D-F, RE	G-N	P-Q	BL	DL	FL	HL		H	W	D	RD	WT
														SH	SW	SD	AH	SF
444766 Reclining Sofa	COST	-	-	-	-	-	-	-	-	-	-	-	FS	42	86	39.5	5	194
	RESALE	1399	-	-	1559	1719	1879	2039	2259	2789	3319	3859		20.5	65.5	21.5	26	3

766 MORRISON		GRADE	SELECT			CUSTOM FABRIC				CUSTOM LEATHER / PLUS				AVAILABLE OPTIONS	DIMENSIONS				
			FAB	FAUX LTH	LTH	B-C	D-F, RE	G-N	P-Q	BL	DL	FL	HL		H	W	D	RD	WT
			SH	SW	SD	AH	SF												
U44766	Power Reclining Sofa w/ Headrest	COST	-	-	-	-	-	-	-	-	-	-	-	FS, W2	42	86	39.5	5	228
		RESALE	2039	-	-	2199	2359	2519	2669	2899	3429	3959	4489		20.5	65.5	21.5	26	3
X44766	Power Reclining Sofa w/ Headrest & Lumbar	COST	-	-	-	-	-	-	-	-	-	-	-	FS, W2	42	86	39.5	5	238
		RESALE	2359	-	-	2519	2669	2829	2989	3219	3749	4279	4809		20.5	65.5	21.5	26	3
NEW! 446766	Reclining Sofa w/ Drop Down Table	COST	-	-	-	-	-	-	-	-	-	-	-	FS	42	86	39.5	5	-
		RESALE	1659	-	-	1819	1979	2139	2299	2529	3059	3589	4119		20.5	65.5	21.5	26	3
NEW! U46766	Power Reclining Sofa w/ Headrest & Drop Down Table	COST	-	-	-	-	-	-	-	-	-	-	-	FS, W2	42	86	39.5	5	-
		RESALE	2299	-	-	2779	2939	3099	3259	3479	4019	4549	5079		20.5	65.5	21.5	26	3
NEW! X46766	Power Reclining Sofa w/ Headrest, Lumbar and Drop Down Table	COST	-	-	-	-	-	-	-	-	-	-	-	FS, W2	42	86	39.5	5	-
		RESALE	2619	-	-	3099	3259	3419	3579	3799	4329	4869	5399		20.5	65.5	21.5	26	3
448766	Reclining Loveseat	COST	-	-	-	-	-	-	-	-	-	-	-	FS	42	63.5	39.5	5	156
		RESALE	1359	-	-	1519	1669	1829	1989	2219	2749	3279	3809		20.5	45	21.5	26	2
U48766	Power Reclining Loveseat w/ Headrest	COST	-	-	-	-	-	-	-	-	-	-	-	FS, W2	42	63.5	39.5	5	190
		RESALE	1989	-	-	2149	2309	2469	2629	2859	3389	3919	4449		20.5	45	21.5	26	2
X48766	Power Reclining Loveseat w/ Headrest & Lumbar	COST	-	-	-	-	-	-	-	-	-	-	-	FS, W2	42	63.5	39.5	5	200
		RESALE	2309	-	-	2469	2629	2789	2949	3169	3709	4239	4769		20.5	45	21.5	26	2
449766	Reclining Loveseat w/ Console	COST	-	-	-	-	-	-	-	-	-	-	-	CB, CC, CM, FS	42	78.5	39.5	5	183
		RESALE	1499	-	-	1659	1819	1979	2139	2369	2899	3429	3959		20.5	60	21.5	26	3
U49766	Power Reclining Loveseat w/ Headrest & Console	COST	-	-	-	-	-	-	-	-	-	-	-	CB, CC, CM, FS, W2	42	78.5	39.5	5	220
		RESALE	2139	-	-	2299	2459	2619	2779	2999	3539	4069	4599		20.5	60	21.5	26	3
X49766	Power Reclining Loveseat w/ Headrest, Lumbar & Console	COST	-	-	-	-	-	-	-	-	-	-	-	CB, CC, CM, FS, W2	42	78.5	39.5	5	230
		RESALE	2459	-	-	2619	2779	2939	3099	3319	3859	4389	4919		20.5	60	21.5	26	3



General guidance, may not apply to all prefixes. Please refer to Product Info Guide for more detail by prefix.

ORDER FOB'S: 05, 06

BACKS: Blown fiber

SWIVEL: 088123, 088124, 088126, 08812T

STD FINISH: 007

SEATS: Ultra Plush chaise (SS)

TALL: 088210, 088266

OPT FINISHES: 021

CAP CODES: DR, UR, UE, BU, RL, LL, LM

FEATURES: N/A

BATTERY: 088BP1

SPECIAL INFO: N/A

SELECT FAUX LEATHER: N/A

SELECT LEATHER: N/A

SELECT FABRIC:
B1538 Seamount
D2116 Rome

766 MORRISON	GRADE	SELECT			CUSTOM FABRIC				CUSTOM LEATHER / PLUS				AVAILABLE OPTIONS	DIMENSIONS				
		FAB	FAUX LTH	LTH	B-C	D-F, RE	G-N	P-Q	BL	DL	FL	HL		H	W	D	RD	WT
		SH	SW	SD	AH	SF												
010766 Rocking Recliner	COST	-	-	-	-	-	-	-	-	-	-	-	ES, FN, FS, H1, H3, L1, L3, LE, LS, SW	42.5	37	38	15	80
	RESALE	689	-	-	799	919	1039	1149	1099	1309	1529	1739		20	19	20.5	26	1
10U766 Power Rocking Recliner w/ Headrest	COST	-	-	-	-	-	-	-	-	-	-	-	FN, FS, LW, SL	42.5	35	38	14	100
	RESALE	1269	-	-	1389	1499	1619	1739	1689	1899	2109	2319		20	19	20.5	26	1
10X766 Power Rocking Recliner w/ Headrest & Lumbar	COST	-	-	-	-	-	-	-	-	-	-	-	FN, FS, LW, SL	42.5	35	38	15	105
	RESALE	1429	-	-	1549	1659	1779	1899	1839	2059	2269	2479		20	19	20.5	26	1
016766 Wall Recliner	COST	-	-	-	-	-	-	-	-	-	-	-	ES, FN, FS, H1, H3, L1, L3, LE, LS	42.5	37	38	7.5	90
	RESALE	719	-	-	829	949	1069	1189	1129	1339	1559	1769		20	19	20.5	26	1
16X766 Power Wall Recliner w/ Headrest & Lumbar	COST	-	-	-	-	-	-	-	-	-	-	-	FS, LW	42.5	35	38	7.5	115
	RESALE	1459	-	-	1579	1699	1809	1929	1879	2089	2299	2519		20	19	20.5	26	1



General guidance, may not apply to all prefixes. Please refer to Product Info Guide for more detail by prefix.

ORDER FOB'S: 05, 06

BACKS: Foam

PILLOWS: N/A

STD FINISH: N/A

SEATS: Faux box-border chaise (SS)

FEATURES: N/A

OPT FINISHES: N/A

CAP CODES: DR, UR, UE, BU, RL, LL, LM

BATTERY: 088BP1

SPECIAL INFO: N/A

SELECT FAUX LEATHER: N/A

SELECT LEATHER:

C1965 Nora
D1970 Marteon

LB1929 Topflight - 35, 79

769 AVA	GRADE	SELECT			CUSTOM FABRIC				CUSTOM LEATHER / PLUS				AVAILABLE OPTIONS	DIMENSIONS				
		FAB	FAUX LTH	LTH	B-C	D-F, RE	G-N	P-Q	BL	DL	FL	HL		H	W	D	RD	WT
		SH	SW	SD	AH	SF												
44A769 Left-Arm SITTING Recliner	COST	-	-	-	-	-	-	-	-	-	-	-	FS	42	32	39	5	79
	RESALE	759	-	1019	879	989	1109	1229	1119	1329	1549	1759		21	23.5	22.5	25	2

769 AVA	GRADE	SELECT			CUSTOM FABRIC				CUSTOM LEATHER / PLUS				AVAILABLE OPTIONS	DIMENSIONS				
		FAB	FAUX LTH	LTH	B-C	D-F, RE	G-N	P-Q	BL	DL	FL	HL		H	W	D	RD	WT
		SH	SW	SD	AH	SF												
U4A769 Power Left-Arm SITTING Recliner w/ Headrest	COST	-	-	-	-	-	-	-	-	-	-	-	FS, LW	42	32	41	5	91
	RESALE	1079	-	1329	1199	1309	1429	1549	1439	1649	1869	2079		21	23.5	22.5	25	2
X4A769 Power Left-Arm SITTING Recliner w/ Headrest and Lumbar	COST	-	-	-	-	-	-	-	-	-	-	-	FS, LW	42	32	41	5	96
	RESALE	1239	-	1489	1359	1469	1589	1709	1599	1809	2029	2239		21	23.5	22.5	25	2
44B769 Right-Arm SITTING Recliner	COST	-	-	-	-	-	-	-	-	-	-	-	FS	42	32	39	5	79
	RESALE	759	-	1019	879	989	1109	1229	1119	1329	1549	1759		21	23.5	22.5	25	2
U4B769 Power Right-Arm SITTING Recliner w/ Headrest	COST	-	-	-	-	-	-	-	-	-	-	-	FS, RW	42	32	41	5	91
	RESALE	1079	-	1329	1199	1309	1429	1549	1439	1649	1869	2079		21	23.5	22.5	25	2
X4B769 Power Right-Arm SITTING Recliner w/ Headrest and Lumbar	COST	-	-	-	-	-	-	-	-	-	-	-	FS, RW	42	32	41	5	96
	RESALE	1239	-	1489	1359	1469	1589	1709	1599	1809	2029	2239		21	23.5	22.5	25	2
44C769 Rounded Corner Unit	COST	-	-	-	-	-	-	-	-	-	-	-	FS	42	60	41	-	65
	RESALE	859	-	1159	1019	1169	1329	1489	1479	2019	2549	3079		21	-	26	25	2
44D769 Left-Arm SITTING Reclining Loveseat	COST	-	-	-	-	-	-	-	-	-	-	-	FS	42	54.5	39	5	122
	RESALE	1139	-	1549	1299	1459	1619	1779	1869	2399	2929	3459		21	48.5	22.5	25	2
U4D769 Power Left-Arm SITTING Reclining Loveseat w/ Headrest	COST	-	-	-	-	-	-	-	-	-	-	-	FS, LW	42	54.5	41	5	134
	RESALE	1459	-	1869	1619	1779	1939	2099	2189	2719	3249	3779		21	48.5	22.5	25	2
X4D769 Power Left-Arm SITTING Reclining Loveseat w/ Headrest and Lumbar	COST	-	-	-	-	-	-	-	-	-	-	-	FS, LW	42	54.5	41	5	144
	RESALE	1619	-	2029	1779	1939	2099	2259	2339	2879	3409	3939		21	48.5	22.5	25	2
44E769 Right-Arm SITTING Reclining Loveseat	COST	-	-	-	-	-	-	-	-	-	-	-	FS	42	54.5	39	5	122
	RESALE	1139	-	1549	1299	1459	1619	1779	1869	2399	2929	3459		21	48.5	22.5	25	2
U4E769 Power Right-Arm SITTING Reclining Loveseat w/ Headrest	COST	-	-	-	-	-	-	-	-	-	-	-	FS, RW	42	54.5	41	5	134
	RESALE	1459	-	1869	1619	1779	1939	2099	2189	2719	3249	3779		21	48.5	22.5	25	2
X4E769 Power Right-Arm SITTING Reclining Loveseat w/ Headrest and Lumbar	COST	-	-	-	-	-	-	-	-	-	-	-	FS, RW	42	54.5	41	5	144
	RESALE	1619	-	2029	1779	1939	2099	2259	2339	2879	3409	3939		21	48.5	22.5	25	2
M44769 Armless Chair	COST	-	-	-	-	-	-	-	-	-	-	-	FS	42	24	41	-	43
	RESALE	559	-	799	669	789	909	1029	909	1119	1329	1549		21	25	22.5	25	1
SC4769 Storage Console	COST	-	-	-	-	-	-	-	-	-	-	-	CB, CC, CM	38.5	14.5	37.5	-	61
	RESALE	629	-	859	689	739	789	839	909	1019	1119	1229		-	-	-	-	1
44S769 Armless Recliner	COST	-	-	-	-	-	-	-	-	-	-	-	FS	42	24	41	4	62
	RESALE	659	-	909	779	899	1019	1129	1019	1229	1439	1649		21	25	22.5	25	1
U4S769 Power Armless Recliner w/ Headrest	COST	-	-	-	-	-	-	-	-	-	-	-	FS, RW	42	24	41	4	77
	RESALE	979	-	1229	1099	1219	1329	1449	1329	1549	1759	1969		21	24	22.5	-	1
X4S769 Power Armless Recliner w/ Headrest and Lumbar	COST	-	-	-	-	-	-	-	-	-	-	-	FS, RW	42	24	41	4	82
	RESALE	1139	-	1389	1259	1379	1489	1609	1489	1709	1919	2129		21	24	22.5	-	1
44Q769 Left-Arm SITTING Reclining Chaise	COST	-	-	-	-	-	-	-	-	-	-	-	FS	42	35	67	8	115
	RESALE	1069	-	1469	1229	1389	1549	1709	1789	2319	2859	3389		21	26	50	25	2

769 AVA	GRADE	SELECT			CUSTOM FABRIC				CUSTOM LEATHER / PLUS				AVAILABLE OPTIONS	DIMENSIONS				
		FAB	FAUX LTH	LTH	B-C	D-F, RE	G-N	P-Q	BL	DL	FL	HL		H	W	D	RD	WT
		SH	SW	SD	AH	SF												
U4Q769 Power Left-Arm SITTING Reclining Chaise w/ Headrest	COST	-	-	-	-	-	-	-	-	-	-	-	FS, LW	42	35	67	8	115
	RESALE	1389	-	1789	1549	1709	1869	2029	2109	2639	3169	3709		21	26	50	25	2
X4Q769 Power Left-Arm SITTING Reclining Chaise w/ Headrest and Lumbar	COST	-	-	-	-	-	-	-	-	-	-	-	FS, LW	42	35	67	8	120
	RESALE	1549	-	1949	1709	1869	2029	2189	2269	2799	3329	3869		21	26	50	25	2
44V769 Right-Arm SITTING Reclining Chaise	COST	-	-	-	-	-	-	-	-	-	-	-	FS	42	35	67	8	115
	RESALE	1069	-	1469	1229	1389	1549	1709	1789	2319	2859	3389		21	26	50	25	2
U4V769 Power Right-Arm SITTING Reclining Chaise w/ Headrest	COST	-	-	-	-	-	-	-	-	-	-	-	FS, RW	42	35	67	8	115
	RESALE	1389	-	1789	1549	1709	1869	2029	2109	2639	3169	3709		21	26	50	25	2
X4V769 Power Right-Arm SITTING Reclining Chaise w/ Headrest and Lumbar	COST	-	-	-	-	-	-	-	-	-	-	-	FS, RW	42	35	67	8	120
	RESALE	1549	-	1949	1709	1869	2029	2189	2269	2799	3329	3869		21	26	50	25	2

General guidance, may not apply to all prefixes. Please refer to Product Info Guide for more detail by prefix.



ORDER FOB'S: 05, 06
STD FINISH: N/A
OPT FINISHES: N/A
BATTERY: 088BP2
SPECIAL INFO: N/A

BACKS: Foam
SEATS: Faux box border chaise (SS)
CAP CODES: DR, UR, UE, BU, RL, LL, LM

PILLOWS: N/A
FEATURES: N/A

SELECT FABRIC:
 C1965 Nora
 D1970 Marteon

SELECT FAUX LEATHER: N/A

SELECT LEATHER:
 LB1929 Topflight - 35, 79

769 AVA	GRADE	SELECT			CUSTOM FABRIC				CUSTOM LEATHER / PLUS				AVAILABLE OPTIONS	DIMENSIONS				
		FAB	FAUX LTH	LTH	B-C	D-F, RE	G-N	P-Q	BL	DL	FL	HL		H	W	D	RD	WT
		SH	SW	SD	AH	SF												
444769 Reclining Sofa	COST	-	-	-	-	-	-	-	-	-	-	-	FS	42	86	44.5	5	200
	RESALE	1689	-	2329	1839	1999	2159	2319	2649	3189	3719	4249		21.5	69.5	22.5	25.5	3
U44769 Power Reclining Sofa w/ Headrest	COST	-	-	-	-	-	-	-	-	-	-	-	FS, W2	42	86	44.5	5	186
	RESALE	2319	-	2969	2479	2639	2799	2959	3289	3819	4359	4889		21.5	46.5	22.5	25.5	3
X44769 Power Reclining Sofa w/ Headrest & Lumbar	COST	-	-	-	-	-	-	-	-	-	-	-	FS, W2	42	86	44.5	5	234
	RESALE	2639	-	3289	2799	2959	3119	3279	3609	4139	4669	5209		21.5	69.5	22.5	25.5	3
448769 Reclining Loveseat	COST	-	-	-	-	-	-	-	-	-	-	-	FS	42	63	44.5	5	162
	RESALE	1639	-	2289	1799	1959	2119	2279	2609	3139	3669	4209		21.5	46.5	22.5	25.5	2
U48769 Power Reclining Loveseat w/ Headrest	COST	-	-	-	-	-	-	-	-	-	-	-	FS, W2	42	63	44.5	5	186
	RESALE	2279	-	2929	2439	2599	2759	2919	3249	3779	4309	4839		21.5	46.5	22.5	25.5	2
X48769 Power Reclining Loveseat w/ Headrest & Lumbar	COST	-	-	-	-	-	-	-	-	-	-	-	FS, W2	42	63	44.5	5	196
	RESALE	2599	-	3249	2759	2919	3079	3239	3569	4099	4629	5159		21.5	46.5	22.5	25.5	2

769 AVA	GRADE	SELECT			CUSTOM FABRIC				CUSTOM LEATHER / PLUS				AVAILABLE OPTIONS	DIMENSIONS				
		FAB	FAUX LTH	LTH	B-C	D-F, RE	G-N	P-Q	BL	DL	FL	HL		H	W	D	RD	WT
		SH	SW	SD	AH	SF												
449769 Reclining Loveseat w/ Console	COST	-	-	-	-	-	-	-	-	-	-	-	CB, CC, CM, FS	42	77.5	44.5	5	189
	RESALE	1789	-	2439	1949	2109	2269	2429	2759	3289	3819	4359		21.5	61	22.5	25.5	3
U49769 Power Reclining Loveseat w/ Headrest & Console	COST	-	-	-	-	-	-	-	-	-	-	-	CB, CC, CM, FS, W2	42	77.5	44.5	5	213
	RESALE	2429	-	3079	2589	2749	2909	3069	3399	3929	4459	4989		21.5	61	22.5	25.5	3
X49769 Power Reclining Loveseat w/ Headrest, Lumbar & Console	COST	-	-	-	-	-	-	-	-	-	-	-	CB, CC, CM, FS, W2	42	77.5	44.5	5	223
	RESALE	2749	-	3399	2909	3069	3229	3389	3719	4249	4779	5309		21.5	61	22.5	25.5	3



General guidance, may not apply to all prefixes. Please refer to Product Info Guide for more detail by prefix.

ORDER FOB'S: 05, 06

BACKS: Foam

SWIVEL: 088123, 088124, 088126, 08812T

STD FINISH: 007

SEATS: Faux box-border chaise (SS)

TALL: 088210, 088266

OPT FINISHES: 021

CAP CODES: DR, UR, UE, BU, RL, LL, LM

FEATURES: N/A

BATTERY: 088BP1

SPECIAL INFO: N/A

SELECT FABRIC:

SELECT FAUX LEATHER: N/A

SELECT LEATHER:

C1965 Nora
D1970 Marteon

LB1929 Topflight - 35, 79

769 AVA	GRADE	SELECT			CUSTOM FABRIC				CUSTOM LEATHER / PLUS				AVAILABLE OPTIONS	DIMENSIONS				
		FAB	FAUX LTH	LTH	B-C	D-F, RE	G-N	P-Q	BL	DL	FL	HL		H	W	D	RD	WT
		SH	SW	SD	AH	SF												
010769 Rocking Recliner	COST	-	-	-	-	-	-	-	-	-	-	-	ES, FN, FS, H1, H3, L1, L3, LE, LS, SW	42.5	37	37.5	16	74
	RESALE	789	-	1109	909	1029	1139	1259	1219	1429	1639	1859		19.5	22	20.5	25	1
10U769 Power Rocking Recliner w/ Headrest	COST	-	-	-	-	-	-	-	-	-	-	-	FN, FS, LW, SL	42.5	35	37.5	16	93
	RESALE	1379	-	1699	1489	1609	1729	1839	1799	2019	2229	2439		19.5	22	20.5	25	1
10X769 Power Rocking Recliner w/ Headrest & Lumbar	COST	-	-	-	-	-	-	-	-	-	-	-	FN, FS, LW, SL	42.5	35	37.5	16	99
	RESALE	1539	-	1859	1649	1769	1889	1999	1959	2169	2389	2599		19.5	22	20.5	25	1
016769 Wall Recliner	COST	-	-	-	-	-	-	-	-	-	-	-	ES, FN, FS, H1, H3, L1, L3, LE, LS	42.5	37	37.5	6	84
	RESALE	819	-	1139	939	1059	1169	1289	1249	1459	1669	1889		19.5	22	20.5	25	1
16X769 Power Wall Recliner w/ Headrest & Lumbar	COST	-	-	-	-	-	-	-	-	-	-	-	FS, LW	42.5	35	37.5	6	104
	RESALE	1569	-	1889	1689	1799	1919	2039	1989	2209	2419	2629		19.5	22	20.5	25	1

DISC!



General guidance, may not apply to all prefixes. Please refer to Product Info Guide for more detail by prefix.

ORDER FOB'S: 05, 06

BACKS: Foam

PILLOWS: N/A

STD FINISH: N/A

SEATS: Faux box-border chaise (SS)

OPT FINISHES: N/A

CAP CODES: DR, UR, UE, BU, RL

FEATURES: Welt trim on arms

BATTERY: 088BP2

SPECIAL INFO: N/A

SELECT FABRIC:

SELECT FAUX LEATHER: N/A

SELECT LEATHER: N/A

C1659 McKittrick

774 ROBIN	GRADE	SELECT			CUSTOM FABRIC				CUSTOM LEATHER / PLUS				AVAILABLE OPTIONS	DIMENSIONS				
		FAB	FAUX LTH	LTH	B-C	D-F, RE	G-N	P-Q	BL	DL	FL	HL		H	W	D	RD	WT
		SH	SW	SD	AH	SF												
DISC! 444774 Reclining Sofa	COST	-	-	-	-	-	-	-	-	-	-	-	FS	42.5	87	42	4	200
	RESALE	1429	-	-	1589	1749	1909	2069	-	-	-	-		21.5	69	21.5	26	3
DISC! U44774 Power Reclining Sofa w/ Headrest	COST	-	-	-	-	-	-	-	-	-	-	-	FS, W2	42.5	87	42	4	264
	RESALE	2069	-	-	2229	2389	2549	2709	-	-	-	-		21.5	69	21.5	26	3
DISC! X44774 Power Reclining Sofa w/ Headrest & Lumbar	COST	-	-	-	-	-	-	-	-	-	-	-	FS, W2	42.5	87	42	4	274
	RESALE	2389	-	-	2549	2709	2869	3029	-	-	-	-		21.5	69	21.5	26	3
DISC! 448774 Reclining Loveseat	COST	-	-	-	-	-	-	-	-	-	-	-	FS	42.5	63.5	42	4	162
	RESALE	1389	-	-	1549	1709	1869	2029	-	-	-	-		21.5	45.5	21.5	26	2
DISC! U48774 Power Reclining Loveseat w/ Headrest	COST	-	-	-	-	-	-	-	-	-	-	-	FS, W2	42.5	63.5	42	4	226
	RESALE	2029	-	-	2189	2339	2499	2659	-	-	-	-		21.5	45.5	21.5	26	2
DISC! X48774 Power Reclining Loveseat w/ Headrest & Lumbar	COST	-	-	-	-	-	-	-	-	-	-	-	FS, W2	42.5	63.5	42	4	236
	RESALE	2339	-	-	2499	2659	2819	2979	-	-	-	-		21.5	45.5	21.5	26	2

DISC!



General guidance, may not apply to all prefixes. Please refer to Product Info Guide for more detail by prefix.

ORDER FOB'S: 05, 06

BACKS: Polyurethane foam

PILLOWS: N/A

STD FINISH: N/A

SEATS: Faux box-border chaise (SS)

OPT FINISHES: N/A

CAP CODES: DR, UR, DP, NP, PS, UE, BU, RL

FEATURES: Welt trim on arms

BATTERY: 088BP1

SPECIAL INFO: N/A

SELECT FABRIC:

SELECT FAUX LEATHER: N/A

SELECT LEATHER: N/A

C1659 McKittrick

774 ROBIN	GRADE	SELECT			CUSTOM FABRIC				CUSTOM LEATHER / PLUS				AVAILABLE OPTIONS	DIMENSIONS				
		FAB	FAUX LTH	LTH	B-C	D-F, RE	G-N	P-Q	BL	DL	FL	HL		H	W	D	RD	WT
		SH	SW	SD	AH	SF												
DISC! 445774 Reclining Chair & A Half	COST	-	-	-	-	-	-	-	-	-	-	-	FS	42.5	49	42	4	102
	RESALE	1219	-	-	1329	1449	1569	1689	-	-	-	-		21.5	31	21.5	26	2
DISC! U45774 Power Reclining Chair & a Half w/ Headrest	COST	-	-	-	-	-	-	-	-	-	-	-	FS, LT, LW, RW	42.5	49	42	4	102
	RESALE	1539	-	-	1649	1769	1889	1999	-	-	-	-		21.5	31	21.5	26	2
DISC! X45774 Power Reclining Chair and A Half w/ Headrest and Lumbar	COST	-	-	-	-	-	-	-	-	-	-	-	FS, LT, LW, RW	42.5	49	42	4	112
	RESALE	1699	-	-	1809	1929	2049	2159	-	-	-	-		21.5	31	21.5	26	2



General guidance, may not apply to all prefixes. Please refer to Product Info Guide for more detail by prefix.

ORDER FOB'S: 05, 06

BACKS: Blown fiber

SWIVEL: N/A

STD FINISH: 007

SEATS: Summit deep chaise w/ higher density foam (SS)

TALL: N/A

OPT FINISHES: 021

CAP CODES: DR, UR, UE, BU, RL, LL, LM

FEATURES: Tall base, longer legrest, elongated comfort selector

BATTERY: 088BP1

SPECIAL INFO: N/A

SELECT FABRIC:

SELECT FAUX LEATHER: N/A

SELECT LEATHER:

D1604 i-Outlier

LB1648 Prestige - 09, 79

776 REDWOOD	GRADE	SELECT			CUSTOM FABRIC				CUSTOM LEATHER / PLUS				AVAILABLE OPTIONS	DIMENSIONS				
		FAB	FAUX LTH	LTH	B-C	D-F, RE	G-N	P-Q	BL	DL	FL	HL		H	W	D	RD	WT
		SH	SW	SD	AH	SF												
010776 Rocking Recliner	COST	-	-	-	-	-	-	-	-	-	-	-	FN, FS, H1, H3, L1, L3, LE	46.5	44	45	15	113
	RESALE	1089	-	1529	1209	1319	1439	1559	1629	1839	2059	2269		21.5	24	23.5	28.5	2
10U776 Power Rocking Recliner w/ Headrest	COST	-	-	-	-	-	-	-	-	-	-	-	FN, FS, LW	46.5	42	45	15	134
	RESALE	1669	-	2109	1789	1909	2029	2139	2219	2429	2639	2859		21.5	24	23.5	28.5	2
10X776 Power Rocking Recliner w/ Headrest & Lumbar	COST	-	-	-	-	-	-	-	-	-	-	-	FN, FS, LW	46.5	42	45	15	139
	RESALE	1829	-	2269	1949	2069	2189	2299	2379	2589	2799	3019		21.5	24	23.5	28.5	2

776 REDWOOD	GRADE	SELECT			CUSTOM FABRIC				CUSTOM LEATHER / PLUS				AVAILABLE OPTIONS	DIMENSIONS				
		FAB	FAUX LTH	LTH	B-C	D-F, RE	G-N	P-Q	BL	DL	FL	HL		H	W	D	RD	WT
		SH	SW	SD	AH	SF												
016776 Wall Recliner	COST	-	-	-	-	-	-	-	-	-	-	-	FN, FS, H1, H3, L1, L3, LE	46.5	44	45	7	123
	RESALE	1119	-	1559	1239	1359	1469	1589	1659	1879	2089	2299		21.5	24	23.5	28.5	2
16X776 Power Wall Recliner w/ Headrest & Lumbar	COST	-	-	-	-	-	-	-	-	-	-	-	FN, FS, LW	46.5	42	45	7	150
	RESALE	1869	-	2299	1979	2099	2219	2329	2409	2619	2829	3049		21.5	24	23.5	28.5	2



General guidance, may not apply to all prefixes. Please refer to Product Info Guide for more detail by prefix.

ORDER FOB'S: 05, 06

STD FINISH: 007

OPT FINISHES: 021

BATTERY: 088BP1

SPECIAL INFO: N/A

SELECT FABRIC:

C1525 Roma

BACKS: Blown fiber

SEATS: Summit deep chaise w/ higher density foam (SS)

CAP CODES: DR, UR, UE, BU, RL, LL, LM

SELECT LEATHER:

D1855 i-Rivers

SWIVEL: N/A

TALL: N/A

FEATURES: Tall base, longer legrest, elongated comfort selector

SELECT LEATHER:

LB1601 Delray - 75, 79

777 RANDELL	GRADE	SELECT			CUSTOM FABRIC				CUSTOM LEATHER / PLUS				AVAILABLE OPTIONS	DIMENSIONS				
		FAB	FAUX LTH	LTH	B-C	D-F, RE	G-N	P-Q	BL	DL	FL	HL		H	W	D	RD	WT
		SH	SW	SD	AH	SF												
010777 Rocking Recliner	COST	-	-	-	-	-	-	-	-	-	-	-	FN, FS, H1, H3, L1, L3, LE	46.5	45.5	41.5	16.5	98
	RESALE	1089	1099	1529	1209	1319	1439	1559	1629	1839	2059	2269		21.5	24	22	27	2
10U777 Power Rocking Recliner w/ Headrest	COST	-	-	-	-	-	-	-	-	-	-	-	FN, FS, LW	46.5	43.5	41.5	16.5	119
	RESALE	1669	1689	2109	1789	1909	2029	2139	2219	2429	2639	2859		21.5	24	22	27	2
10X777 Power Rocking Recliner w/ Headrest & Lumbar	COST	-	-	-	-	-	-	-	-	-	-	-	FN, FS, LW	46.5	43.5	41.5	16.5	124
	RESALE	1829	1839	2269	1949	2069	2189	2299	2379	2589	2799	3019		21.5	24	22	27	2
016777 Wall Recliner	COST	-	-	-	-	-	-	-	-	-	-	-	FN, FS, H1, H3, L1, L3, LE	46.5	45.5	41.5	7	108
	RESALE	1119	1129	1559	1239	1359	1469	1589	1659	1879	2089	2299		21.5	24	22	27	2
16X777 Power Wall Recliner w/ Headrest & Lumbar	COST	-	-	-	-	-	-	-	-	-	-	-	FN, FS, LW	46.5	43.5	41.5	7	135
	RESALE	1869	1879	2299	1979	2099	2219	2329	2409	2619	2829	3049		21.5	24	22	27	2



General guidance, may not apply to all prefixes. Please refer to Product Info Guide for more detail by prefix.

ORDER FOB'S: 05, 06

BACKS: Foam

PILLOWS: N/A

STD FINISH: N/A

SEATS: Standard chaise (SS)

OPT FINISHES: N/A

CAP CODES: DR, UR, UE, BU, RL, LL, LM

FEATURES: N/A

BATTERY: 088BP2

SPECIAL INFO: N/A

SELECT FABRIC:

SELECT FAUX LEATHER: N/A

SELECT LEATHER:

D2107 Westcott

LB1851 Camaraderie - 58, 75

781 EMMONS MOTION	GRADE	SELECT			CUSTOM FABRIC				CUSTOM LEATHER / PLUS				AVAILABLE OPTIONS	DIMENSIONS				
		FAB	FAUX LTH	LTH	B-C	D-F, RE	G-N	P-Q	BL	DL	FL	HL		H	W	D	RD	WT
		SH	SW	SD	AH	SF												
444781 Reclining Sofa	COST	-	-	-	-	-	-	-	-	-	-	-	FS	43	83.5	40.5	5	206
	RESALE	1689	-	2329	1839	1999	2159	2319	2649	3189	3719	4249		22	69	23	25.5	3
U44781 Power Reclining Sofa w/ Headrest	COST	-	-	-	-	-	-	-	-	-	-	-	FS, W2	43	83.5	40.5	5	229.5
	RESALE	2319	-	2969	2479	2639	2799	2959	3289	3819	4359	4889		22	69	23	25.5	3
X44781 Power Reclining Sofa w/ Headrest & Lumbar	COST	-	-	-	-	-	-	-	-	-	-	-	FS, W2	43	83.5	40.5	5	239.5
	RESALE	2639	-	3289	2799	2959	3119	3279	3609	4139	4669	5209		22	69	23	25.5	3
448781 Reclining Loveseat	COST	-	-	-	-	-	-	-	-	-	-	-	FS	43	60.5	40.5	5	168
	RESALE	1639	-	2289	1799	1959	2119	2279	2609	3139	3669	4209		22	46	23	25.5	2
U48781 Power Reclining Loveseat w/ Headrest	COST	-	-	-	-	-	-	-	-	-	-	-	FS, W2	43	60.5	40.5	5	191.5
	RESALE	2279	-	2929	2439	2599	2759	2919	3249	3779	4309	4839		22	46	23	25.5	2
X48781 Power Reclining Loveseat w/ Headrest & Lumbar	COST	-	-	-	-	-	-	-	-	-	-	-	FS, W2	43	60.5	40.5	5	201.5
	RESALE	2599	-	3249	2759	2919	3079	3239	3569	4099	4629	5159		22	46	23	25.5	2
449781 Reclining Loveseat w/ Console	COST	-	-	-	-	-	-	-	-	-	-	-	CB, CC, CM, FS	43	75	40.5	5	195
	RESALE	1789	-	2439	1949	2109	2269	2429	2759	3289	3819	4359		22	60.5	23	25.5	3
U49781 Power Reclining Loveseat w/ Headrest & Console	COST	-	-	-	-	-	-	-	-	-	-	-	CB, CC, CM, FS, W2	43	75	40.5	5	185
	RESALE	2429	-	3079	2589	2749	2909	3069	3399	3929	4459	4989		22	60.5	23	25.5	3
X49781 Power Reclining Loveseat w/ Headrest, Lumbar & Console	COST	-	-	-	-	-	-	-	-	-	-	-	CB, CC, CM, FS, W2	43	75	40.5	5	231.5
	RESALE	2749	-	3399	2909	3069	3229	3389	3719	4249	4779	5309		22	60.5	23	25.5	3



General guidance, may not apply to all prefixes. Please refer to Product Info Guide for more detail by prefix.

ORDER FOB'S: 05, 06

BACKS: Foam

SWIVEL: 088123, 088124, 088126, 08812T

STD FINISH: 007

SEATS: Standard chaise (SS)

TALL: 088210, 088266

OPT FINISHES: 021

CAP CODES: DR, UR, UE, BU, RL, LL, LM

FEATURES: N/A

BATTERY: 088BP1

SPECIAL INFO: N/A

SELECT FAUX LEATHER: N/A

SELECT LEATHER:

D2107 Westcott

LB1851 Camaraderie - 58, 75

781 EMMONS RECLINER	GRADE	SELECT			CUSTOM FABRIC				CUSTOM LEATHER / PLUS				AVAILABLE OPTIONS	DIMENSIONS				
		FAB	FAUX LTH	LTH	B-C	D-F, RE	G-N	P-Q	BL	DL	FL	HL		H	W	D	RD	WT
		SH	SW	SD	AH	SF												
010781 Rocking Recliner	COST	-	-	-	-	-	-	-	-	-	-	-	ES, FN, FS, H1, H3, L1, L3, LE, LS, SW	42	35.5	38.5	15.5	87
	RESALE	789	-	1109	909	1029	1139	1259	1219	1429	1639	1859		20	22	22.5	25.5	1
10U781 Power Rocking Recliner w/ Headrest	COST	-	-	-	-	-	-	-	-	-	-	-	FN, FS, LW, SL	42	33.5	38.5	15.5	106
	RESALE	1379	-	1699	1489	1609	1729	1839	1799	2019	2229	2439		20	22	22.5	25.5	1
10X781 Power Rocking Recliner w/ Headrest & Lumbar	COST	-	-	-	-	-	-	-	-	-	-	-	FN, FS, LW, SL	42	33.5	38.5	15.5	112
	RESALE	1539	-	1859	1649	1769	1889	1999	1959	2169	2389	2599		20	22	22.5	25.5	1
016781 Wall Recliner	COST	-	-	-	-	-	-	-	-	-	-	-	ES, FN, FS, H1, H3, L1, L3, LE, LS	42	35.5	38.5	5.5	97
	RESALE	819	-	1139	939	1059	1169	1289	1249	1459	1669	1889		20	22	22.5	25.5	1
16X781 Power Wall Recliner w/ Headrest & Lumbar	COST	-	-	-	-	-	-	-	-	-	-	-	FS, LW	42	33.5	38.5	5.5	117
	RESALE	1569	-	1889	1689	1799	1919	2039	1989	2209	2419	2629		20	22	22.5	25.5	1



General guidance, may not apply to all prefixes. Please refer to Product Info Guide for more detail by prefix.

ORDER FOB'S: 05, 06

BACKS: Foam & blown fiber

SWIVEL: 088123, 088124, 088126, 08812T

STD FINISH: 007

SEATS: Standard chaise (SS)

TALL: 088210, 088266

OPT FINISHES: 021

CAP CODES: DR, UR, UE, BU, RL, LL, LM

FEATURES: N/A

BATTERY: 088BP1

SPECIAL INFO: N/A

SELECT FAUX LEATHER: N/A

SELECT LEATHER:

D2099 i-Favorite
D2123 Ayla

LB2063 Dean - 76, 79

782 KELLS	GRADE	SELECT			CUSTOM FABRIC				CUSTOM LEATHER / PLUS				AVAILABLE OPTIONS	DIMENSIONS				
		FAB	FAUX LTH	LTH	B-C	D-F, RE	G-N	P-Q	BL	DL	FL	HL		H	W	D	RD	WT
		SH	SW	SD	AH	SF												
010782 Rocking Recliner	COST	-	-	-	-	-	-	-	-	-	-	-	ES, FN, FS, H1, H3, L1, L3, LE, LS, SW	42	34	37.5	15	80
	RESALE	689	-	999	799	919	1039	1149	1109	1319	1539	1749		20	22	22	24.5	1

782 KELLS	GRADE	SELECT			CUSTOM FABRIC				CUSTOM LEATHER / PLUS				AVAILABLE OPTIONS	DIMENSIONS				
		FAB	FAUX LTH	LTH	B-C	D-F, RE	G-N	P-Q	BL	DL	FL	HL		H	W	D	RD	WT
		SH	SW	SD	AH	SF												
10U782 Power Rocking Recliner w/ Headrest	COST	-	-	-	-	-	-	-	-	-	-	-	FN, FS, LW, SL	42	32	37.5	15	99
	RESALE	1269	-	1589	1389	1499	1619	1739	1699	1909	2119	2329		20	22	22	24.5	1
10X782 Power Rocking Recliner w/ Headrest & Lumbar	COST	-	-	-	-	-	-	-	-	-	-	-	FN, FS, LW, SL	42	32	37.5	15	105
	RESALE	1429	-	1749	1549	1659	1779	1899	1859	2069	2279	2489		20	22	22	24.5	1
016782 Wall Recliner	COST	-	-	-	-	-	-	-	-	-	-	-	ES, FN, FS, H1, H3, L1, L3, LE, LS	42	34	37.5	5	90
	RESALE	719	-	1039	829	949	1069	1189	1139	1359	1569	1779		20	22	22	24.5	1
16X782 Power Wall Recliner w/ Headrest & Lumbar	COST	-	-	-	-	-	-	-	-	-	-	-	FS, LW	42	32	37.5	5	110
	RESALE	1459	-	1779	1579	1699	1809	1929	1889	2099	2309	2529		20	22	22	24.5	1



General guidance, may not apply to all prefixes. Please refer to Product Info Guide for more detail by prefix.

ORDER FOB'S: 05, 06

STD FINISH: N/A

OPT FINISHES: N/A

BATTERY: N/A

SPECIAL INFO: PLANNED STOCKED COVER: D182535 and D182573 i-Raven Crest Stocked units may be ordered as warehouse (FOB's 36, 45) or production (FOB's 05, 06)

SELECT FABRIC: N/A

BACKS: Blown fiber

SEATS: Standard chaise (SS)

CAP CODES: DR, UR, UE, BU, RL

SELECT FAUX LEATHER:

D1825 i-Raven Crest

PILLOWS: N/A

FEATURES: Single occupant - 300-lb operating capacity, battery back-up, side pocket

SELECT LEATHER: N/A

786 LIAM	GRADE	SELECT			CUSTOM FABRIC				CUSTOM LEATHER / PLUS				AVAILABLE OPTIONS	DIMENSIONS				
		FAB	FAUX LTH	LTH	B-C	D-F, RE	G-N	P-Q	BL	DL	FL	HL		H	W	D	RD	WT
		SH	SW	SD	AH	SF												
3BL786 Bronze Power Lift Recliner	COST	-	-	-	-	-	-	-	-	-	-	-	FS	43	32	37.5	14.5	105
	RESALE	-	999	-	1119	1239	1359	1469	-	-	-	-		19.5	21	21	23.5	1



General guidance, may not apply to all prefixes. Please refer to Product Info Guide for more detail by prefix.

ORDER FOB'S: 05, 06

BACKS: Blown fiber

PILLOWS: N/A

STD FINISH: 007

SEATS: Standard chaise (SS)

OPT FINISHES: 021

CAP CODES: DR, UR, UE, BU, RL, LL, LM

FEATURES: N/A

BATTERY: 088BP2

SPECIAL INFO: N/A

SELECT FABRIC:

SELECT FAUX LEATHER:

SELECT LEATHER: N/A

C1852 Tiago

D1825 i-Raven Crest

786 LIAM	GRADE	SELECT			CUSTOM FABRIC				CUSTOM LEATHER / PLUS				AVAILABLE OPTIONS	DIMENSIONS				
		FAB	FAUX LTH	LTH	B-C	D-F, RE	G-N	P-Q	BL	DL	FL	HL		H	W	D	RD	WT
		SH	SW	SD	AH	SF												
330786 Wall Reclining Sofa	COST	-	-	-	-	-	-	-	-	-	-	-	1H, 2E, 3H, FN, FS	41	86	39	8	185
	RESALE	1559	1589	-	1719	1879	2039	2199	2259	2789	3319	3859		20	71	21	24	3
33U786 Power Wall Reclining Sofa w/ Headrest	COST	-	-	-	-	-	-	-	-	-	-	-	FS, W2	41	83	39	12	223
	RESALE	2519	2549	-	2669	2829	2989	3149	3219	3749	4279	4809		20	71	21	24	3
33X786 Power Wall Reclining Sofa w/ Headrest & Lumbar	COST	-	-	-	-	-	-	-	-	-	-	-	FS, W2	41	83	39	12	245
	RESALE	2829	2869	-	2989	3149	3309	3469	3539	4069	4599	5129		20	71	21	24	3
320786 Wall Reclining Loveseat	COST	-	-	-	-	-	-	-	-	-	-	-	1H, 2E, 3H, FN, FS	41	62	39	8	150
	RESALE	1519	1549	-	1669	1829	1989	2149	2219	2749	3279	3809		20	47	21	24	2
32U786 Power Wall Reclining Loveseat w/ Headrest	COST	-	-	-	-	-	-	-	-	-	-	-	FS, W2	41	62	39	12	188
	RESALE	2469	2499	-	2629	2789	2949	3109	3169	3709	4239	4769		20	47	21	24	2
32X786 Power Wall Reclining Loveseat w/ Headrest & Lumbar	COST	-	-	-	-	-	-	-	-	-	-	-	FS, W2	41	62	39	12	200
	RESALE	2789	2819	-	2949	3109	3269	3429	3489	4029	4559	5089		20	47	21	24	2
339786 Wall Reclining Loveseat w/ Console	COST	-	-	-	-	-	-	-	-	-	-	-	1H, 2E, 3H, CB, CC, CM, FN, FS	41	76.5	39	8	199
	RESALE	1659	1699	-	1819	1979	2139	2299	2369	2899	3429	3959		20	61.5	21	24	3
U39786 Power Wall Reclining Loveseat w/ Headrest & Console	COST	-	-	-	-	-	-	-	-	-	-	-	CB, CC, CM, FS, W2	41	73.5	39	12	218
	RESALE	2619	2649	-	2779	2939	3099	3259	3319	3859	4389	4919		20	61.5	21	24	3
X39786 Power Wall Reclining Loveseat w/ Console Headrest & Lumbar	COST	-	-	-	-	-	-	-	-	-	-	-	CB, CC, CM, FS, W2	41	73.5	39	12	230
	RESALE	2939	2969	-	3099	3259	3419	3579	3639	4169	4709	5239		20	61.5	21	24	3



General guidance, may not apply to all prefixes. Please refer to Product Info Guide for more detail by prefix.

ORDER FOB'S: 05, 06

BACKS: Blown fiber

SWIVEL: 088123, 088124, 088126, 08812T

STD FINISH: 007

SEATS: Standard chaise (SS)

TALL: 088210, 088266

OPT FINISHES: 021

CAP CODES: DR, UR, UE, BU, RL, LL, LM

FEATURES: N/A

BATTERY: 088BP1

SPECIAL INFO: N/A

SELECT FAUX LEATHER:

SELECT LEATHER:

C1852 Tiago

D1825 i-Raven Crest

LB1849 (WQL) Lota - 64, 78

786 LIAM	GRADE	SELECT			CUSTOM FABRIC				CUSTOM LEATHER / PLUS				AVAILABLE OPTIONS	DIMENSIONS				
		FAB	FAUX LTH	LTH	B-C	D-F, RE	G-N	P-Q	BL	DL	FL	HL		H	W	D	RD	WT
		SH	SW	SD	AH	SF												
010786 Rocking Recliner	COST	-	-	-	-	-	-	-	-	-	-	-	ES, FN, FS, H1, H3, L1, L3, LE, LS, SW	43	34	39	14	76
	RESALE	659	669	929	779	899	1019	1129	1039	1249	1459	1669		20	22	20	24.5	1
10U786 Power Rocking Recliner w/ Headrest	COST	-	-	-	-	-	-	-	-	-	-	-	FN, FS, LW, SL	43	32	39	14	95
	RESALE	1249	1259	1519	1369	1479	1599	1719	1619	1829	2049	2259		20	22	20	24.5	1
10X786 Power Rocking Recliner w/ Headrest & Lumbar	COST	-	-	-	-	-	-	-	-	-	-	-	FN, FS, LW, SL	43	32	39	14	101
	RESALE	1409	1419	1669	1529	1639	1759	1879	1779	1989	2209	2419		20	22	20	24.5	1
016786 Wall Recliner	COST	-	-	-	-	-	-	-	-	-	-	-	ES, FN, FS, H1, H3, L1, L3, LE, LS	43	34	39	8	86
	RESALE	699	709	959	809	929	1049	1159	1069	1279	1489	1709		20	22	20	24.5	1
16X786 Power Wall Recliner w/ Headrest & Lumbar	COST	-	-	-	-	-	-	-	-	-	-	-	FS, LW	43	32	39	8	106
	RESALE	1439	1449	1709	1559	1669	1789	1909	1809	2029	2239	2449		20	22	20	24.5	1



General guidance, may not apply to all prefixes. Please refer to Product Info Guide for more detail by prefix.

ORDER FOB'S: 05, 06

BACKS: Foam

SWIVEL: 088123, 088124, 088126, 08812T

STD FINISH: 007

SEATS: Standard chaise (SS)

TALL: 088210, 088266

OPT FINISHES: 021

CAP CODES: DR, UR, UE, BU, RL, LL, LM

FEATURES: Padded outside arms

BATTERY: 088BP1

SPECIAL INFO: N/A

SELECT FAUX LEATHER: N/A

SELECT LEATHER:

D1490 i-Benavento
D1905 York
D2038 Picchu

LB1804 Elite - 32, 59

787 LENNON	GRADE	SELECT			CUSTOM FABRIC				CUSTOM LEATHER / PLUS				AVAILABLE OPTIONS	DIMENSIONS				
		FAB	FAUX LTH	LTH	B-C	D-F, RE	G-N	P-Q	BL	DL	FL	HL		H	W	D	RD	WT
		SH	SW	SD	AH	SF												
DISC! 010787 Rocking Recliner	COST	-	-	-	-	-	-	-	-	-	-	-	ES, FN, FS, H1, H3, L1, L3, LE, LS, SW	43	32.5	39.5	14	79
	RESALE	809	-	1109	929	1049	1159	1279	1219	1429	1639	1859		20	21	21	24.5	1

DISC!

787 LENNON	GRADE	SELECT			CUSTOM FABRIC				CUSTOM LEATHER / PLUS				AVAILABLE OPTIONS	DIMENSIONS				
		FAB	FAUX LTH	LTH	B-C	D-F, RE	G-N	P-Q	BL	DL	FL	HL		H	W	D	RD	WT
		SH	SW	SD	AH	SF												
DISC! 10U787 Power Rocking Recliner w/ Headrest	COST	-	-	-	-	-	-	-	-	-	-	-	FN, FS, LW, SL	43	30.5	39.5	14	98
	RESALE	1399	-	1699	1519	1629	1749	1869	1799	2019	2229	2439		20	21	21	24.5	1
DISC! 10X787 Power Rocking Recliner w/ Headrest & Lumbar	COST	-	-	-	-	-	-	-	-	-	-	-	FN, FS, LW, SL	43	30.5	39.5	14	104
	RESALE	1559	-	1859	1669	1789	1909	2029	1959	2169	2389	2599		20	21	21	24.5	1
DISC! 016787 Wall Recliner	COST	-	-	-	-	-	-	-	-	-	-	-	ES, FN, FS, H1, H3, L1, L3, LE, LS	43	32.5	39.5	7	89
	RESALE	839	-	1139	959	1079	1199	1309	1249	1459	1669	1889		20	21	21	24.5	1
DISC! 16X787 Power Wall Recliner w/ Headrest & Lumbar	COST	-	-	-	-	-	-	-	-	-	-	-	FS, LW	43	30.5	39.5	7	109
	RESALE	1589	-	1889	1709	1819	1939	2059	1989	2209	2419	2629		20	21	21	24.5	1



General guidance, may not apply to all prefixes. Please refer to Product Info Guide for more detail by prefix.

ORDER FOB'S: 05, 06

STD FINISH: N/A

OPT FINISHES: N/A

BATTERY: N/A

SPECIAL INFO: PLANNED STOCKED COVER: D160654 i-Halifax
Stocked units may be ordered as warehouse (FOB's 36, 45) or production (FOB's 05, 06)

SELECT FABRIC:
D1606 i-Halifax

BACKS: Blown fiber

SEATS: Standard chaise (SS)

CAP CODES: DR, UR, UE, BU, RL

SELECT FAUX LEATHER: N/A

SWIVEL: N/A

TALL: N/A

FEATURES: Single occupant - 300-lb operating capacity, battery back-up, side pocket.

SELECT LEATHER: N/A

793 JEAN	GRADE	SELECT			CUSTOM FABRIC				CUSTOM LEATHER / PLUS				AVAILABLE OPTIONS	DIMENSIONS				
		FAB	FAUX LTH	LTH	B-C	D-F, RE	G-N	P-Q	BL	DL	FL	HL		H	W	D	RD	WT
		SH	SW	SD	AH	SF												
3BL793 Bronze Power Lift Recliner	COST	-	-	-	-	-	-	-	-	-	-	-	FS	40.5	32.5	38	13.5	102
	RESALE	809	-	-	929	1049	1159	1279	-	-	-	-		19	21	21	23.5	1



General guidance, may not apply to all prefixes. Please refer to Product Info Guide for more detail by prefix.

ORDER FOB'S: 05, 06

BACKS: Foam

SWIVEL: N/A

STD FINISH: N/A

SEATS: Standard chaise (SS)

TALL: N/A

OPT FINISHES: N/A

CAP CODES: DR, UR, UE, BU, RL

FEATURES: Single occupant - 300-lb operating capacity, battery back-up, side pocket.

BATTERY: N/A

SPECIAL INFO: PLANNED STOCKED COVERS: D207131 i-Rockport
Stocked units may be ordered as warehouse (FOB's 36, 45) or production (FOB's 05, 06)

SELECT FABRIC:
D2071 i-Rockport

SELECT FAUX LEATHER: N/A

SELECT LEATHER: N/A

794 BILLIE	GRADE	SELECT			CUSTOM FABRIC				CUSTOM LEATHER / PLUS				AVAILABLE OPTIONS	DIMENSIONS				
		FAB	FAUX LTH	LTH	B-C	D-F, RE	G-N	P-Q	BL	DL	FL	HL		H	W	D	RD	WT
		SH	SW	SD	AH	SF												
3BL794 Bronze Power Lift Recliner	COST	-	-	-	-	-	-	-	-	-	-	-	FS	39	32	37.5	14	103
RESALE	899	-	-	-	1019	1129	1249	1369	-	-	-	-		19	20.5	21	24	1



General guidance, may not apply to all prefixes. Please refer to Product Info Guide for more detail by prefix.

ORDER FOB'S: 05, 06

BACKS: Blown fiber

SWIVEL: 088123, 088124, 088126, 08812T

STD FINISH: 007

SEATS: Standard chaise (SS)

TALL: 088210, 088266

OPT FINISHES: 021

CAP CODES: DR, UR, UE, BU, RL, LL, LM

FEATURES: Open bent wood arms with top pads

BATTERY: 088BP1

SPECIAL INFO: N/A

SELECT FABRIC:
D1807 Fairfax

SELECT FAUX LEATHER: N/A

SELECT LEATHER: N/A

799 HARBOR TOWN	GRADE	SELECT			CUSTOM FABRIC				CUSTOM LEATHER / PLUS				AVAILABLE OPTIONS	DIMENSIONS				
		FAB	FAUX LTH	LTH	B-C	D-F, RE	G-N	P-Q	BL	DL	FL	HL		H	W	D	RD	WT
		SH	SW	SD	AH	SF												
010799 Rocking Recliner	COST	-	-	-	-	-	-	-	-	-	-	-	ES, FN, FS, H1, H3, L1, L3, LE, LS, SW	41	30	37	11.5	73
	RESALE	839	-	-	959	1079	1199	1309	1149	1369	1579	1789		19	23	19.5	23	1
P10799 Power Rocking Recliner	COST	-	-	-	-	-	-	-	-	-	-	-	FN, FS, HW, LT, SL	41	28	37	11.5	83
	RESALE	1059	-	-	1169	1289	1409	1529	1369	1579	1789	1999		19	23	19.5	23	1
016799 Wall Recliner	COST	-	-	-	-	-	-	-	-	-	-	-	ES, FN, FS, H1, H3, L1, L3, LE, LS	41	30	37	6	80
	RESALE	879	-	-	989	1109	1229	1339	1189	1399	1609	1819		19	23	19.5	23	1
P16799 Power Wall Recliner	COST	-	-	-	-	-	-	-	-	-	-	-	FN, FS, HW, LT	41	28	37	6	93
	RESALE	1089	-	-	1209	1319	1439	1559	1399	1609	1819	2039		19	23	19.5	23	1
017799 Swivel Gliding Recliner	COST	-	-	-	-	-	-	-	-	-	-	-	ES, FN, FS, H1, H3, L1, L3, LE, LS	41	30	37	11.5	107
	RESALE	999	-	-	1119	1239	1359	1469	1309	1529	1739	1949		19	23	19.5	23	1

General guidance, may not apply to all prefixes. Please refer to Product Info Guide for more detail by prefix.



ORDER FOB'S: 05, 06

STD FINISH: N/A

OPT FINISHES: N/A

BATTERY: 088BP1

SPECIAL INFO: N/A

SELECT FABRIC:

B1808 Social Club
C2029 Easy

BACKS: Blown fiber, knife-edge

SEATS: Ultra Plush chaise (SS)

CAP CODES: DR, UR, UE, BU, RL, LL, LM

SELECT FAUX LEATHER: N/A

PILLOWS: N/A

FEATURES: N/A

SELECT LEATHER:

LB2063 Dean - 32, 57, 77

800 PALMER	GRADE	SELECT			CUSTOM FABRIC				CUSTOM LEATHER / PLUS				AVAILABLE OPTIONS	DIMENSIONS				
		FAB	FAUX LTH	LTH	B-C	D-F, RE	G-N	P-Q	BL	DL	FL	HL		H	W	D	RD	WT
		SH	SW	SD	AH	SF												
44A800 Left-Arm SITTING Recliner	COST	-	-	-	-	-	-	-	-	-	-	-	FS	43	42.5	38	4.5	89
	RESALE	769	-	1089	889	999	1119	1239	1199	1409	1619	1829		21	32	22	25	2
U4A800 Power Left-Arm SITTING Recliner w/ Headrest	COST	-	-	-	-	-	-	-	-	-	-	-	FS, LW	43	42.5	38	4.5	101
	RESALE	1089	-	1409	1209	1319	1439	1559	1519	1729	1939	2149		21	32	22	25	2
X4A800 Power Left-Arm SITTING Recliner w/ Headrest and Lumbar	COST	-	-	-	-	-	-	-	-	-	-	-	FS, LW	43	42.5	38	4.5	106
	RESALE	1249	-	1569	1369	1479	1599	1719	1669	1889	2099	2309		21	32	22	25	2
44B800 Right-Arm SITTING Recliner	COST	-	-	-	-	-	-	-	-	-	-	-	FS	43	42.5	38	4.5	89
	RESALE	769	-	1089	889	999	1119	1239	1199	1409	1619	1829		22	32	22	25	2
U4B800 Power Right-Arm SITTING Recliner w/ Headrest	COST	-	-	-	-	-	-	-	-	-	-	-	FS, RW	43	42.5	38	4.5	101
	RESALE	1089	-	1409	1209	1319	1439	1559	1519	1729	1939	2149		21	32	22	25	2
X4B800 Power Right-Arm SITTING Recliner w/ Headrest and Lumbar	COST	-	-	-	-	-	-	-	-	-	-	-	FS, RW	43	42.5	38	4.5	106
	RESALE	1249	-	1569	1369	1479	1599	1719	1669	1889	2099	2309		21	32	22	25	2
44C800 Rounded Corner Unit	COST	-	-	-	-	-	-	-	-	-	-	-	FS	43	59	38	-	66.5
	RESALE	779	-	1069	939	1099	1259	1419	1389	1919	2449	2979		21	-	22	-	2
M44800 Armless Chair	COST	-	-	-	-	-	-	-	-	-	-	-	FS	43	33.5	38	-	54
	RESALE	559	-	809	669	789	909	1029	919	1129	1339	1559		21	33.5	22	-	2
SC4800 Storage Console	COST	-	-	-	-	-	-	-	-	-	-	-	CB, CC, CM	38.5	14.5	38.5	-	56
	RESALE	629	-	859	689	739	789	839	909	1019	1119	1229		-	-	-	-	1
44S800 Armless Recliner	COST	-	-	-	-	-	-	-	-	-	-	-	FS	43	33.5	38	4.5	69
	RESALE	659	-	919	779	899	1019	1129	1029	1239	1449	1659		21	33.5	22	-	2
U4S800 Power Armless Recliner w/ Headrest	COST	-	-	-	-	-	-	-	-	-	-	-	FS, RW	43	33.5	38	4.5	84
	RESALE	979	-	1239	1099	1219	1329	1449	1339	1559	1769	1979		21	33.5	22	25	2
X4S800 Power Armless Recliner w/ Headrest and Lumbar	COST	-	-	-	-	-	-	-	-	-	-	-	FS, RW	43	33.5	38	4.5	89
	RESALE	1139	-	1399	1259	1379	1489	1609	1499	1719	1929	2139		21	33.5	22	25	2
44Q800 Left-Arm SITTING Reclining Chaise	COST	-	-	-	-	-	-	-	-	-	-	-	FS	43	42.5	66.5	8.5	116
	RESALE	1019	-	1469	1169	1329	1489	1649	1789	2319	2859	3389		21	32	48	25	2

800 PALMER	GRADE	SELECT			CUSTOM FABRIC				CUSTOM LEATHER / PLUS				AVAILABLE OPTIONS	DIMENSIONS				
		FAB	FAUX LTH	LTH	B-C	D-F, RE	G-N	P-Q	BL	DL	FL	HL		H	W	D	RD	WT
		SH	SW	SD	AH	SF												
U4Q800 Power Left-Arm SITTING Reclining Chaise w/ Headrest	COST	-	-	-	-	-	-	-	-	-	-	-	FS, LW	43	42.5	66.5	8.5	116
	RESALE	1329	-	1789	1489	1649	1809	1969	2109	2639	3169	3709		21	32	48	25	2
X4Q800 Power Left-Arm SITTING Reclining Chaise w/ Headrest and Lumbar	COST	-	-	-	-	-	-	-	-	-	-	-	FS, LW	43	42.5	66.5	8.5	121
	RESALE	1489	-	1949	1649	1809	1969	2129	2269	2799	3329	3869		21	32	48	25	2
44V800 Right-Arm SITTING Reclining Chaise	COST	-	-	-	-	-	-	-	-	-	-	-	FS	43	42.5	66.5	8.5	116
	RESALE	1019	-	1469	1169	1329	1489	1649	1789	2319	2859	3389		21	32	48	25	2
U4V800 Power Right-Arm SITTING Reclining Chaise w/ Headrest	COST	-	-	-	-	-	-	-	-	-	-	-	FS, RW	43	42.5	66.5	8.5	116
	RESALE	1329	-	1789	1489	1649	1809	1969	2109	2639	3169	3709		21	32	48	25	2
X4V800 Power Right-Arm SITTING Reclining Chaise w/ Headrest and Lumbar	COST	-	-	-	-	-	-	-	-	-	-	-	FS, RW	43	42.5	66.5	8.5	121
	RESALE	1489	-	1949	1649	1809	1969	2129	2269	2799	3329	3869		21	32	48	25	2
445800 Reclining Chair & A Half	COST	-	-	-	-	-	-	-	-	-	-	-	FS	43	51.5	38	4.5	97
	RESALE	1049	-	1689	1159	1279	1399	1519	1789	1999	2219	2429		21	31	22	25	2
U45800 Power Reclining Chair & a Half w/ Headrest	COST	-	-	-	-	-	-	-	-	-	-	-	FS, LW, RW	43	54.5	38	4.5	100
	RESALE	1369	-	1999	1479	1599	1719	1829	2109	2319	2539	2749		21	31	22	25	2
X45800 Power Reclining Chair and A Half w/ Headrest and Lumbar	COST	-	-	-	-	-	-	-	-	-	-	-	FS, LW, RW	43	54.5	38	4.5	105
	RESALE	1529	-	2159	1639	1759	1879	1989	2269	2479	2699	2909		21	31	22	25	2

General guidance, may not apply to all prefixes. Please refer to Product Info Guide for more detail by prefix.



ORDER FOB'S: 05, 06
STD FINISH: N/A
OPT FINISHES: N/A
BATTERY: 088BP2
SPECIAL INFO: N/A
SELECT FABRIC:

D2034 Doritt
D2066 i-Kudos

BACKS: Blown fiber
SEATS: Ultra Plush chaise (SS)
CAP CODES: DR, UR, UE, BU, RL, LL, LM
SELECT FAUX LEATHER: N/A

PILLOWS: N/A
FEATURES: N/A
SELECT LEATHER:

LB2062 Clifton - 78, 79

802 CASSIAN	GRADE	SELECT			CUSTOM FABRIC				CUSTOM LEATHER / PLUS				AVAILABLE OPTIONS	DIMENSIONS				
		FAB	FAUX LTH	LTH	B-C	D-F, RE	G-N	P-Q	BL	DL	FL	HL		H	W	D	RD	WT
		SH	SW	SD	AH	SF												
444802 Reclining Sofa	COST	-	-	-	-	-	-	-	-	-	-	-	FS	42.5	86	40	5	202
	RESALE	1599	-	2259	1759	1919	2079	2239	2579	3109	3639	4169		20.5	68	23	25.5	3
U44802 Power Reclining Sofa w/ Headrest	COST	-	-	-	-	-	-	-	-	-	-	-	FS, W2	42.5	86	40	5	225.5
	RESALE	2239	-	2899	2399	2559	2719	2879	3219	3749	4279	4809		20.5	68	23	25.5	3
X44802 Power Reclining Sofa w/ Headrest & Lumbar	COST	-	-	-	-	-	-	-	-	-	-	-	FS, W2	42.5	86	40	5	235.5
	RESALE	2559	-	3219	2719	2879	3039	3199	3539	4069	4599	5129		20.5	68	23	25.5	3

802 CASSIAN	GRADE	SELECT			CUSTOM FABRIC				CUSTOM LEATHER / PLUS				AVAILABLE OPTIONS	DIMENSIONS				
		FAB	FAUX LTH	LTH	B-C	D-F, RE	G-N	P-Q	BL	DL	FL	HL		H	W	D	RD	WT
		SH	SW	SD	AH	SF												
448802 Reclining Loveseat	COST	-	-	-	-	-	-	-	-	-	-	-	FS	42.5	63	40	5	164
	RESALE	1559	-	2219	1719	1879	2039	2199	2539	3069	3599	4129		20.5	45	23	25.5	2
U48802 Power Reclining Loveseat w/ Headrest	COST	-	-	-	-	-	-	-	-	-	-	-	FS, W2	42.5	63	40	5	187.5
	RESALE	2199	-	2859	2359	2519	2669	2829	3169	3709	4239	4769		20.5	45	23	25.5	2
X48802 Power Reclining Loveseat w/ Headrest & Lumbar	COST	-	-	-	-	-	-	-	-	-	-	-	FS, W2	42.5	63	40	5	197.5
	RESALE	2519	-	3169	2669	2829	2989	3149	3489	4029	4559	5089		20.5	45	23	25.5	2
449802 Reclining Loveseat w/ Console	COST	-	-	-	-	-	-	-	-	-	-	-	CB, CC, CM, FS	42.5	77.5	40	5	191
	RESALE	1709	-	2369	1869	2029	2189	2339	2689	3219	3749	4279		20.5	59.5	23	25.5	3
U49802 Power Reclining Loveseat w/ Headrest & Console	COST	-	-	-	-	-	-	-	-	-	-	-	CB, CC, CM, FS, W2	42.5	77.5	40	5	181
	RESALE	2339	-	2999	2499	2659	2819	2979	3319	3859	4389	4919		20.5	59.5	23	25.5	3
X49802 Power Reclining Loveseat w/ Headrest, Lumbar & Console	COST	-	-	-	-	-	-	-	-	-	-	-	CB, CC, CM, FS, W2	42.5	77.5	40	5	227.5
	RESALE	2659	-	3319	2819	2979	3139	3299	3639	4169	4709	5239		20.5	59.5	23	25.5	3

General guidance, may not apply to all prefixes. Please refer to Product Info Guide for more detail by prefix.



ORDER FOB'S: 05, 06

BACKS: Blown fiber

SWIVEL: 088123, 088124, 088126, 08812T

STD FINISH: 007

SEATS: Ultra Plush chaise (SS)

TALL: 088210, 088266

OPT FINISHES: 021

CAP CODES: DR, UR, UE, BU, RL, LL, LM

FEATURES: N/A

BATTERY: 088BP1

SPECIAL INFO: N/A

SELECT FAUX LEATHER: N/A

SELECT LEATHER:

D2034 Doritt

LB2062 Clifton - 78, 79

D2066 i-Kudos

802 CASSIAN	GRADE	SELECT			CUSTOM FABRIC				CUSTOM LEATHER / PLUS				AVAILABLE OPTIONS	DIMENSIONS				
		FAB	FAUX LTH	LTH	B-C	D-F, RE	G-N	P-Q	BL	DL	FL	HL		H	W	D	RD	WT
		SH	SW	SD	AH	SF												
010802 Rocking Recliner	COST	-	-	-	-	-	-	-	-	-	-	-	ES, FN, FS, H1, H3, L1, L3, LE, LS, SW	42.5	36	38	11.5	78
	RESALE	789	-	1109	909	1029	1139	1259	1219	1429	1639	1859		20	21	21	24.5	1
10U802 Power Rocking Recliner w/ Headrest	COST	-	-	-	-	-	-	-	-	-	-	-	FN, FS, LW, SL	42.5	34	38	13.5	97
	RESALE	1379	-	1699	1489	1609	1729	1839	1799	2019	2229	2439		20	21	21	24.5	1
10X802 Power Rocking Recliner w/ Headrest & Lumbar	COST	-	-	-	-	-	-	-	-	-	-	-	FN, FS, LW, SL	42.5	34	38	14	103
	RESALE	1539	-	1859	1649	1769	1889	1999	1959	2169	2389	2599		20	21	21	24.5	1
016802 Wall Recliner	COST	-	-	-	-	-	-	-	-	-	-	-	ES, FN, FS, H1, H3, L1, L3, LE, LS	42.5	36	38	5	88
	RESALE	819	-	1139	939	1059	1169	1289	1249	1459	1669	1889		20	21	21	24.5	1
16X802 Power Wall Recliner w/ Headrest & Lumbar	COST	-	-	-	-	-	-	-	-	-	-	-	FS, LW	42.5	34	38	7	108
	RESALE	1569	-	1889	1689	1799	1919	2039	1989	2209	2419	2629		20	21	21	24.5	1

General guidance, may not apply to all prefixes. Please refer to Product Info Guide for more detail by prefix.



ORDER FOB'S: 05, 06

STD FINISH: N/A

OPT FINISHES: N/A

BATTERY: 088BP2

SPECIAL INFO: N/A

SELECT FABRIC:

D2068 i-Beverly
D2092 Ross

BACKS: Blown fiber, knife-edge

SEATS: Standard chaise (SS)

CAP CODES: DR, UR, UE, BU, RL, LL, LM

SELECT FAUX LEATHER: N/A

PILLOWS: N/A

FEATURES: Flange welt trim on arms

SELECT LEATHER:

LB2061 Gambit - 32, 75

803 CADE MOTION	GRADE	SELECT			CUSTOM FABRIC				CUSTOM LEATHER / PLUS				AVAILABLE OPTIONS	DIMENSIONS				
		FAB	FAUX LTH	LTH	B-C	D-F, RE	G-N	P-Q	BL	DL	FL	HL		H	W	D	RD	WT
		SH	SW	SD	AH	SF												
444803 Reclining Sofa	COST	-	-	-	-	-	-	-	-	-	-	-	FS	42	83	39	6	195
	RESALE	1359	-	1919	1519	1669	1829	1989	2239	2769	3299	3829		20.5	69	22.5	25.5	3
U44803 Power Reclining Sofa w/ Headrest	COST	-	-	-	-	-	-	-	-	-	-	-	FS, W2	42	83	39	6	218.5
	RESALE	1989	-	2559	2149	2309	2469	2629	2879	3409	3939	4469		20.5	69	22.5	25.5	3
X44803 Power Reclining Sofa w/ Headrest & Lumbar	COST	-	-	-	-	-	-	-	-	-	-	-	FS, W2	42	83	39	6	228.5
	RESALE	2309	-	2879	2469	2629	2789	2949	3199	3729	4259	4789		20.5	69	22.5	25.5	3
448803 Reclining Loveseat	COST	-	-	-	-	-	-	-	-	-	-	-	FS	42	60	39	6	157
	RESALE	1309	-	1879	1469	1629	1789	1949	2199	2729	3259	3789		20.5	46	22.5	25.5	2
U48803 Power Reclining Loveseat w/ Headrest	COST	-	-	-	-	-	-	-	-	-	-	-	FS, W2	42	60	39	6	180.5
	RESALE	1949	-	2519	2109	2269	2429	2589	2829	3369	3899	4429		20.5	46	22.5	25.5	2
X48803 Power Reclining Loveseat w/ Headrest & Lumbar	COST	-	-	-	-	-	-	-	-	-	-	-	FS, W2	42	60	39	6	190.5
	RESALE	2269	-	2829	2429	2589	2749	2909	3149	3689	4219	4749		20.5	46	22.5	25.5	2
449803 Reclining Loveseat w/ Console	COST	-	-	-	-	-	-	-	-	-	-	-	CB, CC, CM, FS	42	74.5	39	6	184
	RESALE	1459	-	2029	1619	1779	1939	2099	2339	2879	3409	3939		20.5	60.5	22.5	25.5	3
U49803 Power Reclining Loveseat w/ Headrest & Console	COST	-	-	-	-	-	-	-	-	-	-	-	CB, CC, CM, FS, W2	42	74.5	39	6	174
	RESALE	2099	-	2659	2259	2419	2579	2739	2979	3519	4049	4579		20.5	60.5	22.5	25.5	3
X49803 Power Reclining Loveseat w/ Headrest, Lumbar & Console	COST	-	-	-	-	-	-	-	-	-	-	-	CB, CC, CM, FS, W2	42	74.5	39	6	220.5
	RESALE	2419	-	2979	2579	2739	2899	3059	3299	3829	4369	4899		20.5	60.5	22.5	25.5	3



General guidance, may not apply to all prefixes. Please refer to Product Info Guide for more detail by prefix.

ORDER FOB'S: 05, 06

BACKS: Blown fiber, knife-edge

SWIVEL: 088123, 088124, 088126, 08812T

STD FINISH: 007

SEATS: Standard chaise (SS)

TALL: 088210, 088266

OPT FINISHES: 021

CAP CODES: DR, UR, UE, BU, RL, LL, LM

FEATURES: Flange welt trim on arms

BATTERY: 088BP1

SPECIAL INFO: N/A

SELECT FAUX LEATHER: N/A

SELECT LEATHER: LB2061 Gambit - 32, 75

D2068 i-Beverley
D2092 Ross

803 CADE RECLINER	GRADE	SELECT			CUSTOM FABRIC				CUSTOM LEATHER / PLUS				AVAILABLE OPTIONS	DIMENSIONS				
		FAB	FAUX LTH	LTH	B-C	D-F, RE	G-N	P-Q	BL	DL	FL	HL		H	W	D	RD	WT
		SH	SW	SD	AH	SF												
010803 Rocking Recliner	COST	-	-	-	-	-	-	-	-	-	-	-	ES, FN, FS, H1, H3, L1, L3, LE, LS, SW	41	33.5	37	11.5	74
	RESALE	659	-	829	779	899	1019	1129	939	1149	1369	1579		19.5	22.5	21	25.5	1
10U803 Power Rocking Recliner w/ Headrest	COST	-	-	-	-	-	-	-	-	-	-	-	FN, FS, LW, RW, SL	41	31.5	37	11.5	93
	RESALE	1249	-	1419	1369	1479	1599	1719	1529	1739	1949	2159		19.5	22.5	21	25.5	1
10X803 Power Rocking Recliner w/ Headrest & Lumbar	COST	-	-	-	-	-	-	-	-	-	-	-	FN, FS, LW, RW, SL	41	31.5	37	11.5	99
	RESALE	1409	-	1579	1529	1639	1759	1879	1689	1899	2109	2319		19.5	22.5	21	25.5	1
016803 Wall Recliner	COST	-	-	-	-	-	-	-	-	-	-	-	ES, FN, FS, H1, H3, L1, L3, LE, LS	41	33.5	37	1.5	84
	RESALE	699	-	869	809	929	1049	1159	969	1189	1399	1609		19.5	22.5	21	25.5	1
16X803 Power Wall Recliner w/ Headrest & Lumbar	COST	-	-	-	-	-	-	-	-	-	-	-	FS, LW	41	31.5	37	1.5	99
	RESALE	1439	-	1609	1559	1669	1789	1909	1719	1929	2139	2359		19.5	22.5	21	25.5	1

General guidance, may not apply to all prefixes. Please refer to Product Info Guide for more detail by prefix.

ORDER FOB'S: 05, 06

BACKS: Foam, knife-edge

PILLOWS: N/A

STD FINISH: 007

SEATS: Standard chaise (SS)

OPT FINISHES: 021

CAP CODES: DR, UR, UE, BU, RL, LL, LM

FEATURES: Welt trim on arms and backs.

BATTERY: 088BP2

SPECIAL INFO: Drop down table surface only available in Sable finish.

SELECT FAUX LEATHER: N/A

SELECT LEATHER: LB1929 Topflight - 76, 79

D2027 i-Weekend
D2072 i-Nolina

NEW!



804 BELMONT MOTION	GRADE	SELECT			CUSTOM FABRIC				CUSTOM LEATHER / PLUS				AVAILABLE OPTIONS	DIMENSIONS				
		FAB	FAUX LTH	LTH	B-C	D-F, RE	G-N	P-Q	BL	DL	FL	HL		H	W	D	RD	WT
		SH	SW	SD	AH	SF												
NEW! 330804 Wall Reclining Sofa	COST	-	-	-	-	-	-	-	-	-	-	-	1H, 2E, 3H, FN, FS	44	87	38	7	187
	RESALE	1619	-	2259	1779	1939	2099	2259	2579	3109	3639	4169		20	71	20.5	25.5	3

804 BELMONT MOTION		GRADE	SELECT			CUSTOM FABRIC				CUSTOM LEATHER / PLUS				AVAILABLE OPTIONS	DIMENSIONS				
			FAB	FAUX LTH	LTH	B-C	D-F, RE	G-N	P-Q	BL	DL	FL	HL		H	W	D	RD	WT
			SH	SW	SD	AH	SF												
NEW!	33U804	Power Wall Reclining Sofa w/ Headrest	COST	-	-	-	-	-	-	-	-	-	-	FS, W2	44	83	38	13.5	235
			RESALE	2579	-	3219	2739	2899	3059	3219	3539	4069	4599		5129	20	71	20.5	25.5
NEW!	33X804	Power Wall Reclining Sofa w/ Headrest & Lumbar	COST	-	-	-	-	-	-	-	-	-	-	FS, W2	44	83	38	13.5	247
			RESALE	2899	-	3539	3059	3219	3379	3539	3859	4389	4919		5449	20	71	20.5	25.5
NEW!	360804	Wall Reclining Sofa w/ Drop Down Table	COST	-	-	-	-	-	-	-	-	-	-	1H, 2E, 3H, FN, FS	44	87	38	7	187
			RESALE	1939	-	2579	2099	2259	2419	2579	2899	3429	3959		4489	20	71	20.5	25.5
NEW!	36U804	Power Wall Reclining Sofa w/ Headrest & Drop Down Table	COST	-	-	-	-	-	-	-	-	-	-	FS, W2	44	87	38	13.5	235
			RESALE	2899	-	3539	3059	3219	3379	3539	3859	4389	4919		5449	20	71	20.5	25.5
NEW!	36X804	Power Wall Reclining Sofa w/ Headrest, Lumbar & Drop Down Table	COST	-	-	-	-	-	-	-	-	-	-	FS, W2	44	87	38	13.5	247
			RESALE	3219	-	3859	3379	3539	3699	3859	4169	4709	5239		5769	20	71	20.5	25.5
NEW!	320804	Wall Reclining Loveseat	COST	-	-	-	-	-	-	-	-	-	-	1H, 2E, 3H, FN, FS	44	63	38	7	152
			RESALE	1579	-	2219	1739	1899	2059	2219	2539	3069	3599		4129	20	47	20.5	25.5
NEW!	32U804	Power Wall Reclining Loveseat w/ Headrest	COST	-	-	-	-	-	-	-	-	-	-	FS, W2	44	59	38	13.5	190
			RESALE	2539	-	3169	2699	2859	3019	3169	3489	4029	4559		5089	20	47	20.5	25.5
NEW!	32X804	Power Wall Reclining Loveseat w/ Headrest & Lumbar	COST	-	-	-	-	-	-	-	-	-	-	FS, W2	44	59	38	13.5	202
			RESALE	2859	-	3489	3019	3169	3329	3489	3809	4339	4879		5409	20	47	20.5	25.5
NEW!	339804	Wall Reclining Loveseat w/ Console	COST	-	-	-	-	-	-	-	-	-	-	1H, 2E, 3H, CB, CC, CM, FN, FS	44	77.5	38	7	201
			RESALE	1729	-	2369	1889	2049	2209	2369	2689	3219	3749		4279	20	61.5	20.5	25.5
NEW!	U39804	Power Wall Reclining Loveseat w/ Headrest & Console	COST	-	-	-	-	-	-	-	-	-	-	CB, CC, CM, FS, W2	44	73.5	38	13.5	220
			RESALE	2689	-	3319	2839	2999	3159	3319	3639	4169	4709		5239	20	61.5	20.5	25.5
NEW!	X39804	Power Wall Reclining Loveseat w/ Console Headrest & Lumbar	COST	-	-	-	-	-	-	-	-	-	-	CB, CC, CM, FS, W2	44	73.5	38	13.5	232
			RESALE	2999	-	3639	3159	3319	3479	3639	3959	4489	5029		5559	20	61.5	20.5	25.5



General guidance, may not apply to all prefixes. Please refer to Product Info Guide for more detail by prefix.

ORDER FOB'S: 05, 06

BACKS: Foam, knife-edge

SWIVEL: 088123, 088124, 088126, 08812T

STD FINISH: 007

SEATS: Standard chaise (SS)

TALL: 088210, 088266

OPT FINISHES: 021

CAP CODES: DR, UR, UE, BU, RL, LL, LM

FEATURES: Welt trim on arms and back

BATTERY: 088BP1

SPECIAL INFO: N/A

SELECT FAUX LEATHER: N/A

SELECT LEATHER:

D2027 i-Weekend

D2072 i-Nolina

LB1929 Topflight - 76, 79

804 BELMONT RECLINER	GRADE	SELECT			CUSTOM FABRIC				CUSTOM LEATHER / PLUS				AVAILABLE OPTIONS	DIMENSIONS				
		FAB	FAUX LTH	LTH	B-C	D-F, RE	G-N	P-Q	BL	DL	FL	HL		H	W	D	RD	WT
		SH	SW	SD	AH	SF												
010804 Rocking Recliner	COST	-	-	-	-	-	-	-	-	-	-	-	ES, FN, FS, H1, H3, L1, L3, LE, LS, SW	43	36	36	15	78
	RESALE	689	-	1099	799	919	1039	1149	1209	1419	1629	1839		20	21.5	20.5	24.5	1
10U804 Power Rocking Recliner w/ Headrest	COST	-	-	-	-	-	-	-	-	-	-	-	FN, FS, LW, SL	43	34	36	15	97
	RESALE	1269	-	1689	1389	1499	1619	1739	1789	1999	2219	2429		20	21.5	20.5	24.5	1
10X804 Power Rocking Recliner w/ Headrest & Lumbar	COST	-	-	-	-	-	-	-	-	-	-	-	FN, FS, LW, SL	43	34	36	15	103
	RESALE	1429	-	1839	1549	1659	1779	1899	1949	2159	2379	2589		20	21.5	20.5	24.5	1
016804 Wall Recliner	COST	-	-	-	-	-	-	-	-	-	-	-	ES, FN, FS, H1, H3, L1, L3, LE, LS	43	36	36	5	88
	RESALE	719	-	1129	829	949	1069	1189	1239	1449	1659	1879		20	21.5	20.5	24.5	1
16X804 Power Wall Recliner w/ Headrest & Lumbar	COST	-	-	-	-	-	-	-	-	-	-	-	FS, LW	43	34	36	5	108
	RESALE	1459	-	1879	1579	1699	1809	1929	1979	2199	2409	2619		20	21.5	20.5	24.5	1



General guidance, may not apply to all prefixes. Please refer to Product Info Guide for more detail by prefix.

ORDER FOB'S: 05, 06

BACKS: Foam, box-border w/ rollover headrest

SWIVEL: 088124, 08812T

STD FINISH: 007

SEATS: Summit deep chaise w/ higher density foam (SS)

TALL: N/A

OPT FINISHES: 021

CAP CODES: DR, UR, UE, BU, RL, LL, LM

FEATURES: Exposed wing, Tall base, longer legrest, elongated comfort selector, (2) removeable silver metal cup holders housed in (2) tilt-out compartments

BATTERY: 088BP1

SPECIAL INFO: N/A

SELECT FABRIC:

SELECT FAUX LEATHER:

SELECT LEATHER:

D2066 i-Kudos

D1855 i-Rivers

LB2113 Roberto - 76, 79

805 ACE	GRADE	SELECT			CUSTOM FABRIC				CUSTOM LEATHER / PLUS				AVAILABLE OPTIONS	DIMENSIONS				
		FAB	FAUX LTH	LTH	B-C	D-F, RE	G-N	P-Q	BL	DL	FL	HL		H	W	D	RD	WT
		SH	SW	SD	AH	SF												
010805 Rocking Recliner	COST	-	-	-	-	-	-	-	-	-	-	-	FN, FS, H1, H3, L1, L3, LE	47	45.5	44	18	128
	RESALE	1129	1139	1559	1249	1369	1479	1599	1659	1879	2089	2299		21.5	24	23.5	27	2
10U805 Power Rocking Recliner w/ Headrest	COST	-	-	-	-	-	-	-	-	-	-	-	FN, FS, LW	47	43.5	44	15.5	147
	RESALE	1719	1729	2139	1829	1949	2069	2189	2249	2459	2669	2889		21.5	24	23.5	27	2
10X805 Power Rocking Recliner w/ Headrest & Lumbar	COST	-	-	-	-	-	-	-	-	-	-	-	FN, FS, LW	47	43.5	44	15.5	153
	RESALE	1879	1889	2299	1989	2109	2229	2339	2409	2619	2829	3049		21.5	24	23.5	27	2
016805 Wall Recliner	COST	-	-	-	-	-	-	-	-	-	-	-	FN, FS, H1, H3, L1, L3, LE	47	45.5	44	11.5	138
	RESALE	1159	1169	1589	1279	1399	1519	1629	1699	1909	2119	2329		21.5	24	23.5	27	2
16X805 Power Wall Recliner w/ Headrest & Lumbar	COST	-	-	-	-	-	-	-	-	-	-	-	FN, FS, LW	47	43.5	44	18	158
	RESALE	1909	1919	2329	2029	2139	2259	2379	2439	2649	2869	3079		21.5	24	23.5	27	2

General guidance, may not apply to all prefixes. Please refer to Product Info Guide for more detail by prefix.



ORDER FOB'S: 05, 06

BACKS: Foam, box-border

PILLOWS: N/A

STD FINISH: 007

SEATS: Sculpted bucket chaise

OPT FINISHES: 021

CAP CODES: DR, UR, UE, BU, RL, LL, LM

FEATURES: Padded outside arms

BATTERY: 088BP2

SPECIAL INFO: Drop down table surface only available in Sable finish.

SELECT FABRIC:

SELECT FAUX LEATHER:

SELECT LEATHER:

D2072 i-Nolina
D2107 Westcott

E2036 Omni

LB2112 Highbrow - 58, 75, 78

807 BARON MOTION	GRADE	SELECT			CUSTOM FABRIC				CUSTOM LEATHER / PLUS				AVAILABLE OPTIONS	DIMENSIONS				
		FAB	FAUX LTH	LTH	B-C	D-F, RE	G-N	P-Q	BL	DL	FL	HL		H	W	D	RD	WT
		SH	SW	SD	AH	SF												
330807 Wall Reclining Sofa	COST	-	-	-	-	-	-	-	-	-	-	-	1H, 2E, 3H, FN, FS	43	85.5	38.5	7	204
	RESALE	1729	1759	2469	1889	2049	2209	2369	2789	3319	3859	4389		20	71	21	25.5	3
33U807 Power Wall Reclining Sofa w/ Headrest	COST	-	-	-	-	-	-	-	-	-	-	-	FS, W2	43	81.5	38.5	13.5	252
	RESALE	2689	2719	3429	2839	2999	3159	3319	3749	4279	4809	5339		20	71	21	25.5	3
33X807 Power Wall Reclining Sofa w/ Headrest & Lumbar	COST	-	-	-	-	-	-	-	-	-	-	-	FS, W2	43	81.5	38.5	13.5	264
	RESALE	2999	3039	3749	3159	3319	3479	3639	4069	4599	5129	5659		20	71	21	25.5	3
NEW! 360807 Wall Reclining Sofa w/ Drop Down Table	COST	-	-	-	-	-	-	-	-	-	-	-	1H, 2E, 3H, FN, FS	43	85.5	38.5	7	-
	RESALE	2049	2079	2789	2209	2369	2529	2689	3109	3639	4169	4709		20	71	21	25.5	3
NEW! 36U807 Power Wall Reclining Sofa w/ Headrest & Drop Down Table	COST	-	-	-	-	-	-	-	-	-	-	-	FS, W2	43	81.5	38.5	13.5	-
	RESALE	2999	3039	3749	3159	3319	3479	3639	4069	4599	5129	5659		20	71	21	25.5	3
NEW! 36X807 Power Wall Reclining Sofa w/ Headrest, Lumbar & Drop Down Table	COST	-	-	-	-	-	-	-	-	-	-	-	FS, W2	43	81.5	38.5	13.5	-
	RESALE	3319	3359	4069	3479	3639	3799	3959	4389	4919	5449	5979		20	71	21	25.5	3
320807 Wall Reclining Loveseat	COST	-	-	-	-	-	-	-	-	-	-	-	1H, 2E, 3H, FN, FS	43	61.5	38.5	7	169
	RESALE	1689	1719	2429	1839	1999	2159	2319	2749	3279	3809	4339		20	47	21	25.5	2
32U807 Power Wall Reclining Loveseat w/ Headrest	COST	-	-	-	-	-	-	-	-	-	-	-	FS, W2	43	57.5	38.5	13.5	207
	RESALE	2639	2669	3389	2799	2959	3119	3279	3709	4239	4769	5299		20	47	21	25.5	2
32X807 Power Wall Reclining Loveseat w/ Headrest & Lumbar	COST	-	-	-	-	-	-	-	-	-	-	-	FS, W2	43	57.5	38.5	13.5	219
	RESALE	2959	2989	3709	3119	3279	3439	3599	4029	4559	5089	5619		20	47	21	25.5	2
339807 Wall Reclining Loveseat w/ Console	COST	-	-	-	-	-	-	-	-	-	-	-	1H, 2E, 3H, CB, CC, CM, FN, FS	43	76	38.5	7	218
	RESALE	1829	1869	2579	1989	2149	2309	2469	2899	3429	3959	4489		20	61.5	21	25.5	3
U39807 Power Wall Reclining Loveseat w/ Headrest & Console	COST	-	-	-	-	-	-	-	-	-	-	-	CB, CC, CM, FS, W2	43	76	38.5	13.5	237
	RESALE	2789	2819	3539	2949	3109	3269	3429	3859	4389	4919	5449		20	61.5	21	25.5	3
X39807 Power Wall Reclining Loveseat w/ Console Headrest & Lumbar	COST	-	-	-	-	-	-	-	-	-	-	-	CB, CC, CM, FS, W2	43	72	38.5	13.5	249
	RESALE	3109	3139	3859	3269	3429	3589	3749	4169	4709	5239	5769		20	61.5	21	25.5	3



General guidance, may not apply to all prefixes. Please refer to Product Info Guide for more detail by prefix.

ORDER FOB'S: 05, 06

BACKS: Foam, box-border

SWIVEL: 088123, 088124, 088126, 08812T

STD FINISH: 007

SEATS: Sculpted bucket chaise (SS)

TALL: 088210, 088266

OPT FINISHES: 021

CAP CODES: DR, UR, UE, BU, RL, LL, LM

FEATURES: Padded outside arms

BATTERY: 088BP1

SPECIAL INFO: N/A

SELECT FAUX LEATHER:

SELECT LEATHER:

D2072 i-Nolina
D2107 Westcott

E2036 Omni

LB2112 Highbrow - 58, 75, 78

807 BARON RECLINER	GRADE	SELECT			CUSTOM FABRIC				CUSTOM LEATHER / PLUS				AVAILABLE OPTIONS	DIMENSIONS				
		FAB	FAUX LTH	LTH	B-C	D-F, RE	G-N	P-Q	BL	DL	FL	HL		H	W	D	RD	WT
														SH	SW	SD	AH	SF
010807 Rocking Recliner	COST	-	-	-	-	-	-	-	-	-	-	-	ES, FN, FS, H1, H3, L1, L3, LE, LS, SW	43	33.5	38.5	15	81
	RESALE	789	799	1109	909	1029	1139	1259	1219	1429	1639	1859		20	22	21	25.5	1
10U807 Power Rocking Recliner w/ Headrest	COST	-	-	-	-	-	-	-	-	-	-	-	FN, FS, LW, SL	43	31.5	38.5	15	100
	RESALE	1379	1389	1699	1489	1609	1729	1839	1799	2019	2229	2439		20	22	21	25.5	1
10X807 Power Rocking Recliner w/ Headrest & Lumbar	COST	-	-	-	-	-	-	-	-	-	-	-	FN, FS, LW, SL	43	31.5	38.5	15	106
	RESALE	1539	1549	1859	1649	1769	1889	1999	1959	2169	2389	2599		20	22	21	25.5	1
016807 Wall Recliner	COST	-	-	-	-	-	-	-	-	-	-	-	ES, FN, FS, H1, H3, L1, L3, LE, LS	43	33.5	38.5	5	91
	RESALE	819	829	1139	939	1059	1169	1289	1249	1459	1669	1889		20	22	21	25.5	1
16X807 Power Wall Recliner w/ Headrest & Lumbar	COST	-	-	-	-	-	-	-	-	-	-	-	FS, LW	43	31.5	38.5	5	111
	RESALE	1569	1579	1889	1689	1799	1919	2039	1989	2209	2419	2629		20	22	21	25.5	1

General guidance, may not apply to all prefixes. Please refer to Product Info Guide for more detail by prefix.

ORDER FOB'S: 06

BACKS: Foam, box-border

PILLOWS: N/A

STD FINISH: 007

SEATS: Faux box-border chaise (SS)

OPT FINISHES: 021

CAP CODES: DR, UR, UE, BU, RL, LL

FEATURES: Decorative wood legs

BATTERY: 088BP1

SPECIAL INFO: N/A

SELECT FAUX LEATHER: N/A

SELECT LEATHER:

D2071 i-Rockport
E1917 i-Adario

LB2062 Clifton - 19, 29, 79



810 QUINAULT	GRADE	SELECT			CUSTOM FABRIC				CUSTOM LEATHER / PLUS				AVAILABLE OPTIONS	DIMENSIONS				
		FAB	FAUX LTH	LTH	B-C	D-F, RE	G-N	P-Q	BL	DL	FL	HL		H	W	D	RD	WT
														SH	SW	SD	AH	SF
84U810 Power Reclining Sofa w/ Headrest	COST	-	-	-	-	-	-	-	-	-	-	-	FN, FS	39.5	79	34	8.5	259
	RESALE	2079	-	2819	2239	2399	2559	2719	3139	3669	4209	4739		19	69.5	20.5	23	3

810 QUINAULT	GRADE	SELECT			CUSTOM FABRIC				CUSTOM LEATHER / PLUS				AVAILABLE OPTIONS	DIMENSIONS				
		FAB	FAUX LTH	LTH	B-C	D-F, RE	G-N	P-Q	BL	DL	FL	HL		H	W	D	RD	WT
		SH	SW	SD	AH	SF												
88U810 Power Reclining Loveseat w/ Headrest	COST	-	-	-	-	-	-	-	-	-	-	-	FN, FS	39.5	57	34	8.5	198
	RESALE	2039	-	2779	2199	2359	2519	2669	3099	3629	4159	4699		19	48	20.5	23	2
81U810 Power Reclining Chair w/ Headrest	COST	-	-	-	-	-	-	-	-	-	-	-	FN, FS, LT	39.5	33	34	8.5	119
	RESALE	1269	-	1739	1389	1499	1619	1739	1839	2059	2269	2479		19	24	20.5	23	2

General guidance, may not apply to all prefixes. Please refer to Product Info Guide for more detail by prefix.



ORDER FOB'S: 05, 06

BACKS: Foam, box-border

PILLOWS: N/A

STD FINISH: 007

SEATS: Waterfall chaise (SS)

OPT FINISHES: 021

CAP CODES: DR, UR, UE, BU, RL, LL, LM

FEATURES: N/A

BATTERY: 088BP1

SPECIAL INFO: 8SC Storage Console only available in 021 Coffee Finish.

SELECT FABRIC:

SELECT FAUX LEATHER: N/A

SELECT LEATHER:

D2074 Gail

LB2063 Dean - 76, 79

D2096 Defender

811 ACADIA MODULAR	GRADE	SELECT			CUSTOM FABRIC				CUSTOM LEATHER / PLUS				AVAILABLE OPTIONS	DIMENSIONS				
		FAB	FAUX LTH	LTH	B-C	D-F, RE	G-N	P-Q	BL	DL	FL	HL		H	W	D	RD	WT
		SH	SW	SD	AH	SF												
8AU811 Power Left-Arm SITTING Recliner w/ Headrest	COST	-	-	-	-	-	-	-	-	-	-	-	FN, FS	43	44.5	40	8.5	144
	RESALE	1199	-	1549	1309	1429	1549	1659	1649	1869	2079	2289		21	33.5	21	26	2
8BU811 Power Right-Arm SITTING Recliner w/ Headrest	COST	-	-	-	-	-	-	-	-	-	-	-	FN, FS	43	44.5	40	8.5	144
	RESALE	1199	-	1549	1309	1429	1549	1659	1649	1869	2079	2289		21	33.5	21	26	2
8C0811 Rounded Corner Unit	COST	-	-	-	-	-	-	-	-	-	-	-	FS	43	68.5	40	-	75
	RESALE	879	-	1169	1039	1199	1359	1519	1489	2029	2559	3089		21	-	24	-	2
8M0811 Armless Chair	COST	-	-	-	-	-	-	-	-	-	-	-	FS	43	35	40	-	60
	RESALE	719	-	909	829	949	1069	1189	1019	1229	1439	1649		21	-	21	-	2
8SU811 Power Armless Recliner w/ Headrest	COST	-	-	-	-	-	-	-	-	-	-	-	FS	43	35	40	8.5	109
	RESALE	1139	-	1329	1259	1379	1489	1609	1439	1649	1869	2079		21	-	21	-	2
8SC811 Storage Console	COST	-	-	-	-	-	-	-	-	-	-	-	N/A	39	13	39	-	61
	RESALE	649	-	879	709	759	809	869	929	1039	1139	1249		-	-	-	-	1



General guidance, may not apply to all prefixes. Please refer to Product Info Guide for more detail by prefix.

ORDER FOB'S: 06
STD FINISH: 007
OPT FINISHES: 021
BATTERY: 088BP1
SPECIAL INFO: N/A
SELECT FABRIC:
 D2096 Defender
 D20741 Gail

BACKS: Foam, box-border
SEATS: Waterfall chaise (SS)
CAP CODES: DR, UR, UE, BU, RL, LL, LM

PILLOWS: N/A
FEATURES: Decorative wood legs

SELECT FAUX LEATHER: N/A

SELECT LEATHER:
 LB2063 Dean - 76, 79

811 ACADIA	GRADE	SELECT			CUSTOM FABRIC				CUSTOM LEATHER / PLUS				AVAILABLE OPTIONS	DIMENSIONS				
		FAB	FAUX LTH	LTH	B-C	D-F, RE	G-N	P-Q	BL	DL	FL	HL		H	W	D	RD	WT
														SH	SW	SD	AH	SF
84U811 Power Reclining Sofa w/ Headrest	COST	-	-	-	-	-	-	-	-	-	-	-	FN, FS	43	84	40	8.5	268
	RESALE	2239	-	2979	2399	2559	2719	2879	3299	3829	4369	4899		21	69.5	21	26	3
88U811 Power Reclining Loveseat w/ Headrest	COST	-	-	-	-	-	-	-	-	-	-	-	FN, FS	43	61.5	40	8.5	229
	RESALE	2199	-	2939	2359	2519	2669	2829	3259	3789	4319	4859		21	48	21	26	2
81U811 Power Reclining Chair w/ Headrest	COST	-	-	-	-	-	-	-	-	-	-	-	FN, FS, LT	43	39	40	8.5	140
	RESALE	1369	-	1829	1479	1599	1719	1829	1939	2149	2369	2579		21	23.5	21	26	2

General guidance, may not apply to all prefixes. Please refer to Product Info Guide for more detail by prefix.



ORDER FOB'S: 06
STD FINISH: 007
OPT FINISHES: 021
BATTERY: 088BP1
SPECIAL INFO: 8SC Storage Console only available in 021 Coffee Finish.
SELECT FABRIC:
 D2072 i-Nolina
 E2040 i-Gellar

BACKS: Foam, box-border
SEATS: Standard chaise (SS)
CAP CODES: DR, UR, UE, BU, RL, LL, LM

PILLOWS: N/A
FEATURES: Decorative wood legs

SELECT FAUX LEATHER: N/A

SELECT LEATHER:
 LB2060 Sutton - 32, 54, 77

812 ARMITAGE	GRADE	SELECT			CUSTOM FABRIC				CUSTOM LEATHER / PLUS				AVAILABLE OPTIONS	DIMENSIONS				
		FAB	FAUX LTH	LTH	B-C	D-F, RE	G-N	P-Q	BL	DL	FL	HL		H	W	D	RD	WT
														SH	SW	SD	AH	SF
8AU812 Power Left-Arm SITTING Recliner w/ Headrest	COST	-	-	-	-	-	-	-	-	-	-	-	FN, FS	42	45	38.5	8	157
	RESALE	1319	-	1599	1439	1559	1669	1789	1709	1919	2129	2339		19.5	34	22	24.5	2
8BU812 Power Right-Arm SITTING Recliner w/ Headrest	COST	-	-	-	-	-	-	-	-	-	-	-	FN, FS	42	45	38.5	8	157
	RESALE	1319	-	1599	1439	1559	1669	1789	1709	1919	2129	2339		19.5	34	22	24.5	2
8C0812 Rounded Corner Unit	COST	-	-	-	-	-	-	-	-	-	-	-	FS	34.5	68.5	38	-	84
	RESALE	899	-	1169	1059	1219	1379	1539	1489	2029	2559	3089		19.5	-	22	-	2

812 ARMITAGE	GRADE	SELECT			CUSTOM FABRIC				CUSTOM LEATHER / PLUS				AVAILABLE OPTIONS	DIMENSIONS				
		FAB	FAUX LTH	LTH	B-C	D-F, RE	G-N	P-Q	BL	DL	FL	HL		H	W	D	RD	WT
		SH	SW	SD	AH	SF												
8M0812 Armless Chair	COST	-	-	-	-	-	-	-	-	-	-	-	FS	34.5	34	38.5	-	58
	RESALE	739	-	959	859	969	1089	1209	1069	1279	1489	1709		19.5	34	22	-	1
8SU812 Power Armless Recliner w/ Headrest	COST	-	-	-	-	-	-	-	-	-	-	-	FS	42	34	38.5	8	121
	RESALE	1159	-	1389	1279	1399	1519	1629	1489	1709	1919	2129		19.5	34	22	24.5	1
8SC812 Storage Console	COST	-	-	-	-	-	-	-	-	-	-	-	N/A	29.5	13	38	-	55
	RESALE	649	-	879	709	759	809	869	929	1039	1139	1249		-	-	-	-	1
85U812 Power Reclining Chair & a Half w/ Headrest	COST	-	-	-	-	-	-	-	-	-	-	-	FN, FS, LT	42	55.5	38.5	8	192
	RESALE	1579	-	1899	1699	1809	1929	2049	1999	2219	2429	2639		19.5	34	22	24.5	2

General guidance, may not apply to all prefixes. Please refer to Product Info Guide for more detail by prefix.

ORDER FOB'S: 05, 06

BACKS: Foam, box-border

PILLOWS: N/A

STD FINISH: 007

SEATS: Standard chaise (SS)

OPT FINISHES: 021

CAP CODES: DR, UR, UE, BU, RL, LL, LM

FEATURES: Decorative wood legs, welt trim on arm posts

BATTERY: 088BP1

SPECIAL INFO: NP, PS cap codes also available on the 81U prefix only.

SELECT FABRIC:

SELECT FAUX LEATHER: N/A

SELECT LEATHER:

D2010 i-Rene
D2068 i-Beverley

LB2060 Sutton - 77, 87



813 CLYBOURN	GRADE	SELECT			CUSTOM FABRIC				CUSTOM LEATHER / PLUS				AVAILABLE OPTIONS	DIMENSIONS				
		FAB	FAUX LTH	LTH	B-C	D-F, RE	G-N	P-Q	BL	DL	FL	HL		H	W	D	RD	WT
		SH	SW	SD	AH	SF												
84U813 Power Reclining Sofa w/ Headrest	COST	-	-	-	-	-	-	-	-	-	-	-	FN, FS	41	86	39	8.5	271
	RESALE	2189	-	2979	2339	2499	2659	2819	3299	3829	4369	4899		21	68	21.5	26.5	3
88U813 Power Reclining Loveseat w/ Headrest	COST	-	-	-	-	-	-	-	-	-	-	-	FN, FS	41	64	39	8.5	210
	RESALE	2139	-	2939	2299	2459	2619	2779	3259	3789	4319	4859		21	48	21.5	26.5	2
81U813 Power Reclining Chair w/ Headrest	COST	-	-	-	-	-	-	-	-	-	-	-	FN, FS, LT	41	40	39	8.5	131
	RESALE	1329	-	1829	1449	1569	1689	1799	1939	2149	2369	2579		21	24	21.5	26.5	1



General guidance, may not apply to all prefixes. Please refer to Product Info Guide for more detail by prefix.

ORDER FOB'S: 05, 06

BACKS: Blown fiber knife-edge

SWIVEL: 088123, 088124, 088126, 08812T

STD FINISH: 007

SEATS: Standard chaise (SS)

TALL: 088210, 088266

OPT FINISHES: 021

CAP CODES: DR, UR, UE, BU, RL, LL, LM

FEATURES: N/A

BATTERY: 088BP1

SPECIAL INFO: N/A

SELECT FAUX LEATHER: N/A

SELECT LEATHER: LB2063 Dean - 32, 57, 77

SELECT FABRIC: B1808 Social Club
C2029 Easy

820 NORTON	GRADE	SELECT			CUSTOM FABRIC				CUSTOM LEATHER / PLUS				AVAILABLE OPTIONS	DIMENSIONS				
		FAB	FAUX LTH	LTH	B-C	D-F, RE	G-N	P-Q	BL	DL	FL	HL		H	W	D	RD	WT
		SH	SW	SD	AH	SF												
010820 Rocking Recliner	COST	-	-	-	-	-	-	-	-	-	-	-	ES, FN, FS, H1, H3, L1, L3, LE, LS, SW	41.5	35.5	37	15	71
	RESALE	579	-	929	699	809	929	1049	1039	1249	1459	1669		19.5	22	20.5	25.5	1
10U820 Power Rocking Recliner w/ Headrest	COST	-	-	-	-	-	-	-	-	-	-	-	FN, FS, LW, SL	41.5	33.5	37	13	90
	RESALE	1159	-	1519	1279	1399	1519	1629	1619	1829	2049	2259		19.5	22	20.5	25.5	1
10X820 Power Rocking Recliner w/ Headrest & Lumbar	COST	-	-	-	-	-	-	-	-	-	-	-	FN, FS, LW, SL	41.5	33.5	37	13	96
	RESALE	1319	-	1669	1439	1559	1669	1789	1779	1989	2209	2419		19.5	22	20.5	25.5	1
016820 Wall Recliner	COST	-	-	-	-	-	-	-	-	-	-	-	ES, FN, FS, H1, H3, L1, L3, LE, LS	41.5	35.5	37	8.5	81
	RESALE	609	-	959	729	839	959	1079	1069	1279	1489	1709		19.5	22	20.5	25.5	1
16X820 Power Wall Recliner w/ Headrest & Lumbar	COST	-	-	-	-	-	-	-	-	-	-	-	FS, LW	41.5	33.5	37	8.5	101
	RESALE	1359	-	1709	1469	1589	1709	1819	1809	2029	2239	2449		19.5	22	20.5	25.5	1

NEW!



General guidance, may not apply to all prefixes. Please refer to Product Info Guide for more detail by prefix.

ORDER FOB'S: 05, 06

BACKS: Blown fiber knife-edge

SWIVEL: 088123, 088126, 08812T

STD FINISH: 007

SEATS: Sculpted bucket chaise (SS)

TALL: 088210, 088266

OPT FINISHES: 021

CAP CODES: DR, UR, UE, BU, RL, LL, LM

FEATURES: (2) removeable silver metal cup holders housed in (2) tilt-out compartments.

BATTERY: 088BP1

SPECIAL INFO: N/A

SELECT FAUX LEATHER: N/A

SELECT LEATHER: LB2136 Bellingham - 59, 79

SELECT FABRIC: D1604 i-Outlier
D2129 Zinnamon

826 SAMMY	GRADE	SELECT			CUSTOM FABRIC				CUSTOM LEATHER / PLUS				AVAILABLE OPTIONS	DIMENSIONS				
		FAB	FAUX LTH	LTH	B-C	D-F, RE	G-N	P-Q	BL	DL	FL	HL		H	W	D	RD	WT
		SH	SW	SD	AH	SF												
NEW! 010826 Rocking Recliner	COST	-	-	-	-	-	-	-	-	-	-	-	ES, FN, FS, H1, H3, L1, L3, LE, LS, SW	43	39.5	39.5	16	96
	RESALE	839	-	1149	959	1079	1199	1309	1259	1469	1689	1899		20.5	21	20.5	26	1

826 SAMMY			GRADE	SELECT			CUSTOM FABRIC				CUSTOM LEATHER / PLUS				AVAILABLE OPTIONS	DIMENSIONS				
				FAB	FAUX LTH	LTH	B-C	D-F, RE	G-N	P-Q	BL	DL	FL	HL		H	W	D	RD	WT
				SH	SW	SD	AH	SF												
NEW!	10U826	Power Rocking Recliner w/ Headrest	COST	-	-	-	-	-	-	-	-	-	-	-	FN, FS, LW, SL	43	37.5	39.5	13.5	115
			RESALE	1429	-	1739	1549	1659	1779	1899	1839	2059	2269	2479		20.5	21	20.5	26	1
NEW!	10X826	Power Rocking Recliner w/ Headrest & Lumbar	COST	-	-	-	-	-	-	-	-	-	-	-	FN, FS, LW, SL	43	37.5	39.5	13.5	121
			RESALE	1589	-	1899	1709	1819	1939	2059	1999	2219	2429	2639		20.5	21	20.5	26	1
NEW!	016826	Wall Recliner	COST	-	-	-	-	-	-	-	-	-	-	-	ES, FN, FS, H1, H3, L1, L3, LE, LS	43	39.5	39.5	9.5	106
			RESALE	879	-	1189	989	1109	1229	1339	1289	1499	1719	1929		20.5	21	20.5	26	1
NEW!	16X826	Power Wall Recliner w/ Headrest & Lumbar	COST	-	-	-	-	-	-	-	-	-	-	-	FS, LW	43	37.5	39.5	16	126
			RESALE	1619	-	1929	1739	1859	1969	2089	2039	2249	2459	2669		20.5	21	20.5	26	1

NEW!



General guidance, may not apply to all prefixes. Please refer to Product Info Guide for more detail by prefix.

ORDER FOB'S: 05, 06

STD FINISH: 007

OPT FINISHES: 021

BATTERY: 088BP1

SPECIAL INFO: N/A

SELECT FABRIC:

C1967 Lunar

C2118 Cosdrew

BACKS: Blown fiber knife-edge

SEATS: Ultra Plush chaise (SS)

CAP CODES: DR, UR, UE, BU, RL, LL, LM

SELECT FAUX LEATHER: N/A

SWIVEL: 088123, 088126, 08812T

TALL: 088210, 088266

FEATURES: N/A

SELECT LEATHER: N/A

827 PARSENS			GRADE	SELECT			CUSTOM FABRIC				CUSTOM LEATHER / PLUS				AVAILABLE OPTIONS	DIMENSIONS				
				FAB	FAUX LTH	LTH	B-C	D-F, RE	G-N	P-Q	BL	DL	FL	HL		H	W	D	RD	WT
				SH	SW	SD	AH	SF												
NEW!	010827	Rocking Recliner	COST	-	-	-	-	-	-	-	-	-	-	-	ES, FN, FS, H1, H3, L1, L3, LE, LS, SW	43	35	37	16	72
			RESALE	619	-	-	739	859	969	1089	1099	1309	1529	1739		20	20.5	20	26	1
NEW!	10U827	Power Rocking Recliner w/ Headrest	COST	-	-	-	-	-	-	-	-	-	-	-	FN, FS, LW, SL	43	33	37	13.5	91
			RESALE	1209	-	-	1319	1439	1559	1669	1689	1899	2109	2319		20	20.5	20	26	1
NEW!	10X827	Power Rocking Recliner w/ Headrest & Lumbar	COST	-	-	-	-	-	-	-	-	-	-	-	FN, FS, LW, SL	43	33	37	13.5	97
			RESALE	1369	-	-	1479	1599	1719	1829	1839	2059	2269	2479		20	20.5	20	26	1
NEW!	016827	Wall Recliner	COST	-	-	-	-	-	-	-	-	-	-	-	ES, FN, FS, H1, H3, L1, L3, LE, LS	43	35	37	9.5	82
			RESALE	649	-	-	769	889	999	1119	1129	1339	1559	1769		20	20.5	20	26	1
NEW!	16X827	Power Wall Recliner w/ Headrest & Lumbar	COST	-	-	-	-	-	-	-	-	-	-	-	FS, LW	43	33	37	16	102
			RESALE	1399	-	-	1519	1629	1749	1869	1879	2089	2299	2519		20	20.5	20	26	1

NEW!



General guidance, may not apply to all prefixes. Please refer to Product Info Guide for more detail by prefix.

ORDER FOB'S: 05, 06

STD FINISH: N/A

OPT FINISHES: N/A

BATTERY: 088BP2

SPECIAL INFO: Drop down table surface only available in Sable finish. Optional Nail Head change (NB, NS) is NO CHARGE on this style.

SELECT FABRIC:

C2121 Watari
D2071 i-Rockport

BACKS: Foam box-border

SEATS: Sculpted Bucket Chaise (SS)

CAP CODES: DR, UR, DP, NP, PS, UE, VS, BU, RL, LL, LM

PILLOWS: N/A

FEATURES: Nail Head trim, exposed wing, welt trim on front arm posts and outside wings.

SELECT FAUX LEATHER:

D2128 Winslow

SELECT LEATHER:

LB2137 Rhythmic - 58, 77

828 DUTTON MOTION	GRADE	SELECT			CUSTOM FABRIC				CUSTOM LEATHER / PLUS				AVAILABLE OPTIONS	DIMENSIONS				
		FAB	FAUX LTH	LTH	B-C	D-F, RE	G-N	P-Q	BL	DL	FL	HL		H	W	D	RD	WT
		SH	SW	SD	AH	SF												
NEW! 444828 Reclining Sofa	COST	-	-	-	-	-	-	-	-	-	-	-	FS, NB, NN, NS	42.5	87	41	5	201
	RESALE	1689	1719	2469	1839	1999	2159	2319	2789	3319	3859	4389		20.5	69	22.5	25.5	-
NEW! U44828 Power Reclining Sofa w/ Headrest	COST	-	-	-	-	-	-	-	-	-	-	-	FS, NB, NN, NS, W2	42.5	87	41	5	224.5
	RESALE	2319	2359	3109	2479	2639	2799	2959	3429	3959	4489	5029		20.5	69	22.5	25.5	-
NEW! X44828 Power Reclining Sofa w/ Headrest & Lumbar	COST	-	-	-	-	-	-	-	-	-	-	-	FS, NB, NN, NS, W2	42.5	87	41	5	234.5
	RESALE	2639	2669	3429	2799	2959	3119	3279	3749	4279	4809	5339		20.5	69	22.5	25.5	-
NEW! 446828 Reclining Sofa w/ Drop Down Table	COST	-	-	-	-	-	-	-	-	-	-	-	FS, NB, NN, NS	42.5	87	41	5	-
	RESALE	1949	1979	2739	2109	2269	2429	2589	3059	3589	4119	4649		20.5	69	22.5	25.5	3
NEW! U46828 Power Reclining Sofa w/ Headrest & Drop Down Table	COST	-	-	-	-	-	-	-	-	-	-	-	FS, NB, NN, NS, W2	42.5	87	41	5	-
	RESALE	2589	2619	3379	3069	3229	3389	3549	4019	4549	5079	5609		20.5	69	22.5	25.5	3
NEW! X46828 Power Reclining Sofa w/ Headrest, Lumbar and Drop Down Table	COST	-	-	-	-	-	-	-	-	-	-	-	FS, NB, NS, W2	42.5	87	41	5	-
	RESALE	2909	2939	3699	3389	3549	3709	3869	4329	4869	5399	5929		20.5	69	22.5	25.5	3
NEW! 448828 Reclining Loveseat	COST	-	-	-	-	-	-	-	-	-	-	-	FS, NB, NN, NS	42.5	64	41	5	163
	RESALE	1639	1669	2429	1799	1959	2119	2279	2749	3279	3809	4339		20.5	46	22.5	25.5	-
NEW! U48828 Power Reclining Loveseat w/ Headrest	COST	-	-	-	-	-	-	-	-	-	-	-	FS, NB, NN, NS, W2	42.5	64	41	5	186.5
	RESALE	2279	2309	3069	2439	2599	2759	2919	3389	3919	4449	4979		20.5	46	22.5	25.5	-
NEW! X48828 Power Reclining Loveseat w/ Headrest & Lumbar	COST	-	-	-	-	-	-	-	-	-	-	-	FS, NB, NN, NS, W2	42.5	64	41	5	196.5
	RESALE	2599	2629	3389	2759	2919	3079	3239	3709	4239	4769	5299		20.5	46	22.5	25.5	-
NEW! 449828 Reclining Loveseat w/ Console	COST	-	-	-	-	-	-	-	-	-	-	-	CB, CC, CM, FS, NB, NN, NS	42.5	78.5	41	5	190
	RESALE	1789	1819	2579	1949	2109	2269	2429	2899	3429	3959	4489		20.5	60.5	22.5	25.5	-
NEW! U49828 Power Reclining Loveseat w/ Headrest & Console	COST	-	-	-	-	-	-	-	-	-	-	-	CB, CC, CM, FS, NB, NN, NS, W2	42.5	78.5	41	5	216.5
	RESALE	2429	2459	3219	2589	2749	2909	3069	3539	4069	4599	5129		20.5	60.5	22.5	25.5	-
NEW! X49828 Power Reclining Loveseat w/ Headrest, Lumbar & Console	COST	-	-	-	-	-	-	-	-	-	-	-	CB, CC, CM, FS, NB, NN, NS, W2	42.5	78.5	41	5	226.5
	RESALE	2749	2779	3539	2909	3069	3229	3389	3859	4389	4919	5449		20.5	60.5	22.5	25.5	-

NEW!



General guidance, may not apply to all prefixes. Please refer to Product Info Guide for more detail by prefix.

ORDER FOB'S: 05, 06

BACKS: Foam box-border

SWIVEL: 088123, 088124, 088126, 08812T

STD FINISH: 007

SEATS: Sculpted Bucket Chaise (SS)

TALL: 088210, 088266

OPT FINISHES: 021

CAP CODES: DR, UR, DP, NP, PS, UE, VS, BU, RL, LL, LM

FEATURES: Nail head trim, exposed wing, welt trim on front arm posts and outside wings.

BATTERY: 088BP1

SPECIAL INFO: Optional Nail Head change (NB, NS) is NO CHARGE on this style.

SELECT FABRIC:

SELECT FAUX LEATHER:

SELECT LEATHER:

C2121 Watari
D2071 i-Rockport

D2128 Winslow

LB2137 Rhythmic - 58, 77

828 DUTTON RECLINER	GRADE	SELECT			CUSTOM FABRIC				CUSTOM LEATHER / PLUS				AVAILABLE OPTIONS	DIMENSIONS				
		FAB	FAUX LTH	LTH	B-C	D-F, RE	G-N	P-Q	BL	DL	FL	HL		H	W	D	RD	WT
		SH	SW	SD	AH	SF												
NEW! 010828 Rocking Recliner	COST	-	-	-	-	-	-	-	-	-	-	-	ES, FN, FS, H1, H3, L1, L3, LE, LS, NB, NN, NS, SW	42.5	38.5	37	15	84
	RESALE	839	859	1149	959	1079	1199	1309	1259	1469	1689	1899		20.5	22	20.5	26	1
NEW! 10U828 Power Rocking Recliner w/ Headrest	COST	-	-	-	-	-	-	-	-	-	-	-	FN, FS, LW, NB, NN, NS, SL	42.5	36.5	37	12.5	103
	RESALE	1429	1439	1739	1549	1659	1779	1899	1839	2059	2269	2479		20.5	22	20.5	26	1
NEW! 10X828 Power Rocking Recliner w/ Headrest & Lumbar	COST	-	-	-	-	-	-	-	-	-	-	-	FN, FS, LW, NB, NN, NS, SL	42.5	36.5	37	12.5	109
	RESALE	1589	1599	1899	1709	1819	1939	2059	1999	2219	2429	2639		20.5	22	20.5	26	1
NEW! 016828 Wall Recliner	COST	-	-	-	-	-	-	-	-	-	-	-	ES, FN, FS, H1, H3, L1, L3, LE, LS, NB, NN, NS	42.5	38.5	37	8.5	94
	RESALE	879	889	1189	989	1109	1229	1339	1289	1499	1719	1929		20.5	22	20.5	26	1
NEW! 16X828 Power Wall Recliner w/ Headrest & Lumbar	COST	-	-	-	-	-	-	-	-	-	-	-	FS, LW, NB, NN, NS	42.5	36.5	37	15	114
	RESALE	1619	1629	1929	1739	1859	1969	2089	2039	2249	2459	2669		20.5	22	20.5	26	1

General guidance, may not apply to all prefixes. Please refer to Product Info Guide for more detail by prefix.

ORDER FOB'S: 05, 06

BACKS: Semi-attached, chambered blown fiber

PILLOWS: (2) 20" knife-edge w/ welt (P1)

STD FINISH: 007

SEATS: Attached, box-border (SS)

OPT FINISHES: 021, 041

CAP CODES: DR, UR, DP, NP, PS, UE, VS, BU, RL, LL, LM

FEATURES: Decorative wood legs, padded outside arms and back, welt trim on backs, arm posts, seats, and footrests

BATTERY: 0881YC

SPECIAL INFO: N/A

SELECT FABRIC:

SELECT FAUX LEATHER: N/A

SELECT LEATHER: N/A

C1700 Nico



893 COLBY	GRADE	SELECT			CUSTOM FABRIC				CUSTOM LEATHER / PLUS				AVAILABLE OPTIONS	DIMENSIONS				
		FAB	FAUX LTH	LTH	B-C	D-F, RE	G-N	P-Q	BL	DL	FL	HL		H	W	D	RD	WT
		SH	SW	SD	AH	SF												
P91893 Duo® Reclining Sofa	COST	-	-	-	-	-	-	-	-	-	-	-	FN, FP, P1	41	83	39.5	-	218
	RESALE	2399	-	-	2559	2719	2879	3039	3469	3999	4539	5069		21.5	67	21	28.5	3

893 COLBY	GRADE	SELECT			CUSTOM FABRIC				CUSTOM LEATHER / PLUS				AVAILABLE OPTIONS	DIMENSIONS				
		FAB	FAUX LTH	LTH	B-C	D-F, RE	G-N	P-Q	BL	DL	FL	HL		H	W	D	RD	WT
		SH	SW	SD	AH	SF												
P93893 Duo® Reclining Loveseat	COST	-	-	-	-	-	-	-	-	-	-	-	FN, FP, P1	41	61	39.5	-	182
	RESALE	2359	-	-	2519	2669	2829	2989	3429	3959	4489	5029		21.5	45	21	28.5	2
P94893 Duo® Reclining Chair	COST	-	-	-	-	-	-	-	-	-	-	-	FN, LT	41	39	39.5	-	112
	RESALE	1589	-	-	1709	1819	1939	2059	2069	2279	2489	2709		21.5	22	21	28.5	1

General guidance, may not apply to all prefixes. Please refer to Product Info Guide for more detail by prefix.



ORDER FOB'S: 05, 06
STD FINISH: 007
OPT FINISHES: 021, 041
BATTERY: 0881YC
SPECIAL INFO: N/A

BACKS: Tight, foam
SEATS: Attached, box-border (SS)
CAP CODES: DR, UR, UE, BU, RL, LL, LM

PILLOWS: (2) 20" knife-edge w/ welt (P1)

FEATURES: Decorative wood legs, padded outside arms and back, welt trim on backs, arm posts, and seats

SELECT FABRIC:
 B1808 Social Club

SELECT FAUX LEATHER: N/A

SELECT LEATHER: N/A

899 BENNETT	GRADE	SELECT			CUSTOM FABRIC				CUSTOM LEATHER / PLUS				AVAILABLE OPTIONS	DIMENSIONS				
		FAB	FAUX LTH	LTH	B-C	D-F, RE	G-N	P-Q	BL	DL	FL	HL		H	W	D	RD	WT
		SH	SW	SD	AH	SF												
P91899 Duo® Reclining Sofa	COST	-	-	-	-	-	-	-	-	-	-	-	FN, FP, P1	39.5	82.5	39	-	220
	RESALE	2399	-	-	2559	2719	2879	3039	3309	3839	4379	4909		21	66.5	22.5	27	3
P93899 Duo® Reclining Loveseat	COST	-	-	-	-	-	-	-	-	-	-	-	FN, FP, P1	39.5	60	39	-	155
	RESALE	2359	-	-	2519	2669	2829	2989	3269	3799	4329	4869		21	44	22.5	27	3
P94899 Duo® Reclining Chair	COST	-	-	-	-	-	-	-	-	-	-	-	FN, LT	39.5	37.5	39	-	107
	RESALE	1589	-	-	1709	1819	1939	2059	2019	2229	2439	2649		21	21.5	22.5	27	2



General guidance, may not apply to all prefixes. Please refer to Product Info Guide for more detail by prefix.

ORDER FOB'S: 05, 06
STD FINISH: 007
OPT FINISHES: N/A
BATTERY: N/A
SPECIAL INFO: N/A
SELECT FABRIC: N/A

BACKS: Tight, foam
SEATS: Attached, bullnose (SS)
CAP CODES: DR, UR

PILLOWS: N/A

FEATURES: Decorative wood legs, welt trim on wings, arm posts, and seat

SELECT FAUX LEATHER: N/A

SELECT LEATHER: N/A

916 KIMBERLY	GRADE	SELECT			CUSTOM FABRIC				CUSTOM LEATHER / PLUS				AVAILABLE OPTIONS	DIMENSIONS				
		FAB	FAUX LTH	LTH	B-C	D-F, RE	G-N	P-Q	BL	DL	FL	HL		H	W	D	RD	WT
		SH	SW	SD	AH	SF												
028916 High Leg Reclining Chair	COST	-	-	-	-	-	-	-	-	-	-	-	FS	41	29.5	37.5	-	68
RESALE	-	-	-	689	799	919	1039	-	-	-	-	19		20.5	20.5	23.5	1	



General guidance, may not apply to all prefixes. Please refer to Product Info Guide for more detail by prefix.

ORDER FOB'S: 05, 06
STD FINISH: 007
OPT FINISHES: 021, 041
BATTERY: N/A
SPECIAL INFO: N/A
SELECT FABRIC: N/A

BACKS: Tight, foam
SEATS: Attached, bullnose (SS)
CAP CODES: DR, UR, DP, NP, PS, UE, VS, BU, RL

PILLOWS: N/A

FEATURES: Decorative wood legs, welt trim on arm posts

SELECT FAUX LEATHER: N/A

SELECT LEATHER: N/A

931 CHARLOTTE	GRADE	SELECT			CUSTOM FABRIC				CUSTOM LEATHER / PLUS				AVAILABLE OPTIONS	DIMENSIONS				
		FAB	FAUX LTH	LTH	B-C	D-F, RE	G-N	P-Q	BL	DL	FL	HL		H	W	D	RD	WT
		SH	SW	SD	AH	SF												
028931 High Leg Reclining Chair	COST	-	-	-	-	-	-	-	-	-	-	-	FN, FS	38.5	33	35	12.5	77
RESALE	-	-	-	689	799	919	1039	-	-	-	-	19.5		20	22	25.5	1	

NEW!



General guidance, may not apply to all prefixes. Please refer to Product Info Guide for more detail by prefix.

ORDER FOB'S: 05, 06

STD FINISH: N/A

OPT FINISHES: N/A

BACKS: Foam

SEATS: Standard chaise (SS)

CAP CODES: DR, UR, LM

PILLOWS: N/A

FEATURES: Center back folds down to access wood table surface in Sable finish, (2) silver metal cup holders. (1) removable silver cup holder in each arm, (2) flip-top storage compartments in the arms. (2) speakers in both RSS and LSS upper backs, subwoofer in both arms, audio controls within both flip top storage compartments.

BATTERY: N/A

SPECIAL INFO: N/A

SELECT FABRIC:

D2099 i-Favorite
D2124 i-Westvale

SELECT FAUX LEATHER: N/A

SELECT LEATHER:

LB2141 Chic - 59, 76

A86 OVATION AUDIO MOTION	GRADE	SELECT			CUSTOM FABRIC				CUSTOM LEATHER / PLUS				AVAILABLE OPTIONS	DIMENSIONS				
		FAB	FAUX LTH	LTH	B-C	D-F, RE	G-N	P-Q	BL	DL	FL	HL		H	W	D	RD	WT
		SH	SW	SD	AH	SF												
NEW! 36XA86 Power Wall Reclining Sofa w/ Headrest, Lumbar & Drop Down Table	COST	-	-	-	-	-	-	-	-	-	-	-	FS	42	86	40	9	303
	RESALE	4189	-	4719	4339	4499	4659	4819	-	-	-	-		20	70	22	25.5	3
NEW! X39A86 Power Wall Reclining Loveseat w/ Console Headrest & Lumbar	COST	-	-	-	-	-	-	-	-	-	-	-	FS	42	76.5	40	9	295
	RESALE	3969	-	4499	4129	4289	4449	4609	-	-	-	-		20	61	22	25.5	3

NEW!



General guidance, may not apply to all prefixes. Please refer to Product Info Guide for more detail by prefix.

ORDER FOB'S: 05, 06

STD FINISH: 007

OPT FINISHES: 021

BATTERY: N/A

SPECIAL INFO: N/A

SELECT FABRIC:

D2099 i-Favorite
D2124 i-Westvale

BACKS: Foam

SEATS: Standard chaise (SS)

CAP CODES: DR, UR, LM

SELECT FAUX LEATHER: N/A

SWIVEL: 088126, 08812T

TALL: 088210, 088266

FEATURES: (2) removable silver cup holders, (2) flip-top storage arm compartments. (2) speakers in the upper back, subwoofer in the RSS arm, audio controls within RSS flip top arm compartment and storage in the LSS flip top arm compartment.

SELECT LEATHER:

LB2141 Chic - 59, 76

A86	OVATION AUDIO RECLINER		GRADE	SELECT			CUSTOM FABRIC				CUSTOM LEATHER / PLUS				AVAILABLE OPTIONS	DIMENSIONS				
				FAB	FAUX LTH	LTH	B-C	D-F, RE	G-N	P-Q	BL	DL	FL	HL		H	W	D	RD	WT
				SH	SW	SD	AH	SF												
NEW!	10XA86	Power Rocking Recliner w/ Headrest & Lumbar	COST	-	-	-	-	-	-	-	-	-	-	-	FN, FS, SL	41	37.5	41	13.5	132
			RESALE	2079	-	2609	2199	2309	2429	2549	-	-	-	-		20.5	22	22.5	25.5	1
NEW!	16XA86	Power Wall Recliner w/ Headrest & Lumbar	COST	-	-	-	-	-	-	-	-	-	-	-	FS	41	37.5	41	16	137
			RESALE	2109	-	2639	2229	2339	2459	2579	-	-	-	-		20.5	22	22.5	25.5	1