



cepedas

M É X I C O S.A de C.V

TRANSLAS [®]
DUTCH WELDING TECHNOLOGY

EXTRACCIÓN

SIN HUMOS ,SOLO AIRE LIMPIO



ACERCA DE **TRANSLAS**

Translas es un fabricante holandés de antorchas de soldadura desde 1960. Una empresa fundada por soldadores y para soldadores, con una pasión por la innovación y las nuevas tecnologías, se esfuerza continuamente por desarrollar productos innovadores con un diseño distintivo, calidad y funcionalidad.

La seguridad del soldador es extremadamente importante para Translas. El objetivo de la empresa es reducir globalmente la exposición de los soldadores a los humos de soldadura y proporcionar un entorno de trabajo más saludable y seguro. Algunos de los productos pioneros incluyen antorchas de soldadura con un módulo incorporado para extraer con seguridad los humos de soldadura en la fuente y equipos de extracción humos portátiles de alto rendimiento.

www.translas.com

TABLA DE CONTENIDO

EXTRACCIÓN SEGURA Y EFICAZ DE LOS HUMOS DE SOLDADURA DIRECTAMENTE EN LA FUENTE.

ACERCA DE TRANSLAS	2
ACERCA DE LOS HUMOS DE SOLDADURA	4
8XE MIG EXTRACTOR	5
8XC COBOT MIG EXTRACTOR	28
8TE TIG EXTRACTOR	42
CLEARO2	56



Catálogo De Extracción

Escanea el código QR con su smartphone



ACERCA DE LOS HUMOS DE SOLDADURA

Los humos de soldadura contienen vapores, una mezcla de subproductos gaseosos transportados por el aire y partículas finas. La composición de la mezcla depende del método de soldadura y de los productos a soldar. Los vapores y gases que se liberan durante el proceso de soldadura pueden provocar graves problemas de salud. La exposición a corto plazo puede provocar náuseas, mareos o irritación de los ojos, la nariz y la garganta. La exposición prolongada es como inhalar polvo de metal ultrafino que puede provocar cáncer de pulmón, daño cerebral y daño renal.

Ciertos gases como el helio, el dióxido de carbono y el argón reemplazan al oxígeno; el argón representa un peligro de asfixia, especialmente en áreas de trabajo cerradas. Por este motivo, Translas, fabricante de antorchas de soldadura, ha desarrollado antorchas de soldadura con extracción de humos integrada – 8XE MIG, 8XR Cobot y 8TE TIG Extractors – que extraen hasta el 98% de los humos de soldadura directamente en la fuente.

AIRE LIMPIO

- ✓ **EXTRACCIÓN Y FILTRADO EN LA FUENTE.**
- ✓ **DESARROLLADO PARA EL PROCESO DE SOLDADURA.**
- ✓ **LÍNEA COMPLETA PARA SU FÁBRICA/TALLER.**
- ✓ **EQUIPOS PROBADOS DE ALTA CALIDAD.**
- ✓ **UNIDADES FÁCILES DE USAR, LISTAS PARA USAR**

TRANSLAS [®]
DUTCH TORCH TECHNOLOGY

8XE MIG EXTRACTOR

EXTRACCIÓN

SIN HUMOS ,SOLO AIRE LIMPIO





8XE MIG EXTRACTOR



MIG
EXTRACTOR

AIRE LIMPIO



8XE MIG EXTRACTOR

EXTRACCIÓN SEGURA Y EFICAZ DE LOS HUMOS DE SOLDADURA DIRECTAMENTE EN LA FUENTE.

8XE MIG Extractor integra la estructura de extracción de humos más eficiente de toda la industria de la soldadura. El 8XE MIG Extractor está disponible en 3 ángulos diferentes: recto, 30° y 45° que recto y , combinado con las unidades de extracción ClearO2100 y 200 , captura hasta el 98 % de los humos de soldadura directamente donde se originan. Proporciona la solución más segura y eficaz para que los soldadores y otros trabajadores para que respiren AIRE LIMPIO y tengan un entorno de trabajo más saludable.

AIRE LIMPIO

EXTRACCIÓN EN EL ORIGEN ROBUSTA CONEXIÓN ENTRE EL CUELLO DE Y EL TUBO METÁLICO.



El nuevo porta tobera proporciona una conexión robusta entre el cuello y el tubo metálico exterior. Está diseñado para soportar los impactos más fuertes en cualquier entorno industrial.

TOBERA DE DISEÑO EXCLUSIVO CON ÓPTIMO RENDIMIENTO Y DURABILIDAD.

La tobera tiene un exclusivo diseño que proporciona los mejores resultados. Los orificios, el grosor de las paredes y agarre se han desarrollado a conciencia para lograr un funcionamiento y un rendimiento óptimos.





8XE MIG EXTRACTOR

MIG
EXTRACTOR

CARACTERÍSTICAS DEL PRODUCTO

- ✓ RESULTADOS MEDIDOS POR EL INSTITUTO HOLANDÉS DE INVESTIGACIÓN (TNO) EN SU "WORST CASE ROOM".
- ✓ PUNTAS DE CONTACTO EXCLUSIVAS PARA UNA MÁXIMA DURABILIDAD.
- ✓ VARIAS TOBERAS DISPONIBLES PARA EL MEJOR RESULTADO EN DISTINTAS APLICACIONES.
- ✓ DISEÑADO PARA MAYOR MOVIMIENTO ANGULAR.
- ✓ FABRICADO EN PLÁSTICO DSM MUY RESISTENTE.
- ✓ EL CUELLO ES FIJO EN DOS PUNTOS.
- ✓ PATENTADA
- ✓ LIGERA
- ✓ ROBUSTA

Reduce los humos de soldadura hasta en un **98%**

La presión más baja del mercado

RÓTULA ERGONÓMICA: ÁNGULO DE 30° Y ROTACIÓN DE 360°.

La rótula del 8XE tiene un movimiento angular vertical de 30° combinado con un giro de 360°. Permite una excelente ergonomía y evita las torsiones de los cables y mangueras, con lo que previene las fugas y roturas. Ofrece una excelente ergonomía que maximiza el confort y minimiza la fatiga.



EXTRACCIÓN





8XE MIG EXTRACTOR LINE

MIG
EXTRACTOR



8XE MIG EXTRACTOR

200 REFRIGERADA
POR GAS

MINI

CO2 - 230 AMP

Mezcla - 200 AMP

Ciclo de servicio - 100%

Peso*: 2.4 lb - 1.09KG



8XE MIG EXTRACTOR

250 REFRIGERADA
POR GAS

MINI

CO2 - 280 AMP

Mezcla - 250 AMP

Ciclo de servicio - 100%

Peso*: 2.9 lb - 1.34KG



8XE MIG EXTRACTOR

400 REFRIGERADA
POR GAS

CO2 - 420 AMP

Mezcla - 400 AMP

Ciclo de servicio - 100%

Peso*: 3.28 lb - 1.48KG



8XE MIG EXTRACTOR

500 REFRIGERADA
POR AGUA

CO2 - 550 AMP

Mezcla - 500 AMP

Ciclo de servicio - 100%

Peso*: 3.7 lb - 1.68KG

EXTRACCIÓN

* El peso se mide con la antorcha colgada a un metro del suelo.



8XE MINI 200 MIG EXTRACTOR - USA

CO2 - 230 AMP, MEZCLA - 200 AMP, CICLO DE SERVICIO - 100%

REFRIGERADA POR GAS

MIG
EXTRACTOR

AIRE LIMPIO

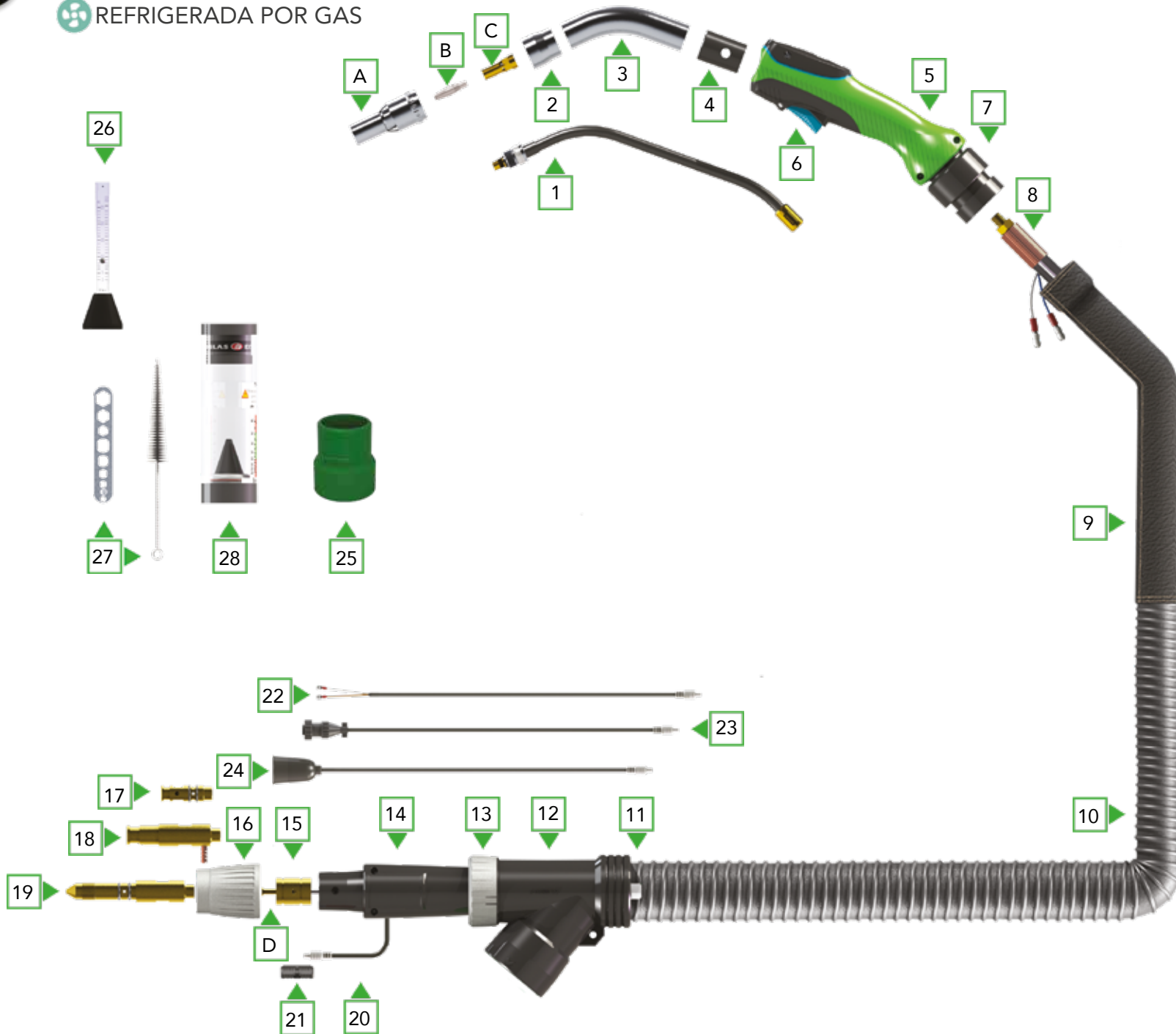

PART NO.	DESCRIPTION	PACK QTY
COMPLETE TORCHES		
8XO1001305000	8XE MINI Extractor USA 200AMP 10ft (3mtr) air cooled - 45° (standard)	1
8XO1001405000	8XE MINI Extractor USA 200AMP 13ft (4mtr) air cooled - 45° (standard)	1
8XO1001505000	8XE MINI Extractor USA 200AMP 16ft (5mtr) air cooled - 45° (standard)	1
8XO1001605000	8XE MINI Extractor USA 200AMP 20ft (6mtr) air cooled - 45° (standard)	1
8XO1501305000	8XE MINI Extractor USA 200AMP 10ft (3mtr) air cooled - straight	1
8XO1501405000	8XE MINI Extractor USA 200AMP 13ft (4mtr) air cooled - straight	1
8XO1501505000	8XE MINI Extractor USA 200AMP 16ft (5mtr) air cooled - straight	1
8XO1501605000	8XE MINI Extractor USA 200AMP 20ft (6mtr) air cooled - straight	1

ITEM	PART NO.	DESCRIPTION	PACK QTY
CONSUMABLES			
A	3937000	Nozzle conical 12mm	5
	3937001	Nozzle conical 14mm special	5
	3937002	Nozzle conical 14mm	5
B	399008	Contact Tip 8XC/8XE - .030 (0.8)	25
	399010	Contact Tip 8XC/8XE - .040 (1.0)	25
	399012	Contact Tip 8XC/8XE - .045 (1.2)	25
	3990102	Contact Tip 8XC/8XE - .040 (1.0) Alu	25
	3990122	Contact Tip 8XC/8XE - .045 (1.2) Alu	25
	3990091	Contact Tip 8XC/8XE - .035 (0.9) CuCrZr	25
	3990101	Contact Tip 8XC/8XE - .040 (1.0) CuCrZr	25
	3990121	Contact Tip 8XC/8XE - .045 (1.2) CuCrZr	25
C	39327110	Tip adapter	10
D	301535-USA	Plastic coated liner blue 10ft (3mtr) - for .030 wire	1
	301545-USA	Plastic coated liner blue 13ft (4mtr) - for .030 wire	1
	301555-USA	Plastic coated liner blue 16ft (5mtr) - for .030 wire	1
	301565-USA	Plastic coated liner blue 20ft (6mtr) - for .030 wire	1
	302535-USA	Plastic coated liner red 10ft (3mtr) - for .035 to .045 wire	1
	302545-USA	Plastic coated liner red 13ft (4mtr) - for .035 to .045 wire	1
	302555-USA	Plastic coated liner red 16ft (5mtr) - for .035 to .045 wire	1
	302565-USA	Plastic coated liner red 20ft (6mtr) - for .035 to .045 wire	1



ITEM	PART NO.	DESCRIPTION	PACK QTY
SPARE PARTS			
1	39301045	Swanneck 45°	1
	39301000	Swan neck straight	1
	3950005	PEEK ring to fix nozzle holder (not shown)	5
2	3950000	Nozzle holder	1
3	3950045	Metal neck 45°	1
	3950050	Metal neck straight	1
4	3950500	Adapter to fit MINI neck	1
5	391000	Handle green/black complete with trigger	1
6	3912009	Trigger with spring	1
	391250	Micro switch complete (not shown)	1
7	381900	Cable support set with ball-and-socket joint	1
8	259163X8	Cable assembly 10ft (3mtr)	1
	259164X8	Cable assembly 13ft (4mtr)	1
	259165X8	Cable assembly 16ft (5mtr)	1
	259166X8	Cable assembly 20ft (6mtr)	1
9	260019	Leather-sheathing with velcro 6ft (2mtr)	1
10	340303	Fume extraction hose 10ft (3mtr)	1
	340304	Fume extraction hose 13ft (4mtr)	1
	340305	Fume extraction hose 16ft (5mtr)	1
	340306	Fume extraction hose 20ft (6mtr)	1
11	398031	Hose connection	1
12	398100	Housing (Y-shape) for fume extraction hose	1
13	398015	Connection ring	1
14	398010	Housing set for central connector	1
15	3059001	Central connector	1
16	398200	Adaptor nut	1
17	3059100	Tweco tail	1
18	3059200S	Lincoln tail complete with gas hose	1
19	3059150	Miller tail	1
20	349200	Switch cable 45cm (Quick connect)	1
21	306545	Locking clip (Quick connect)	5
22	349130	Tweco swith cable end (Quick connect)	1
23	349120	Miller swith cable end (Quick connect)	1
24	349110	Lincoln swith cable end (Quick connect)	1
25	398110	Hose adapter	1
26	406050	Gasflow meter	1
27	371208	Tool set (brush and multitool)	1
28	371350	Airflow meter MINI Extractor	1
-	320300	Ceramic dry film spray 400 ml (not shown)	12



8XE MINI 250 MIG EXTRACTOR - USA

CO2 - 280 AMP, MEZCLA - 250 AMP, CICLO DE SERVICIO - 100%

REFRIGERADA POR GAS

MIG

EXTRACTOR

AIRE LIMPIO

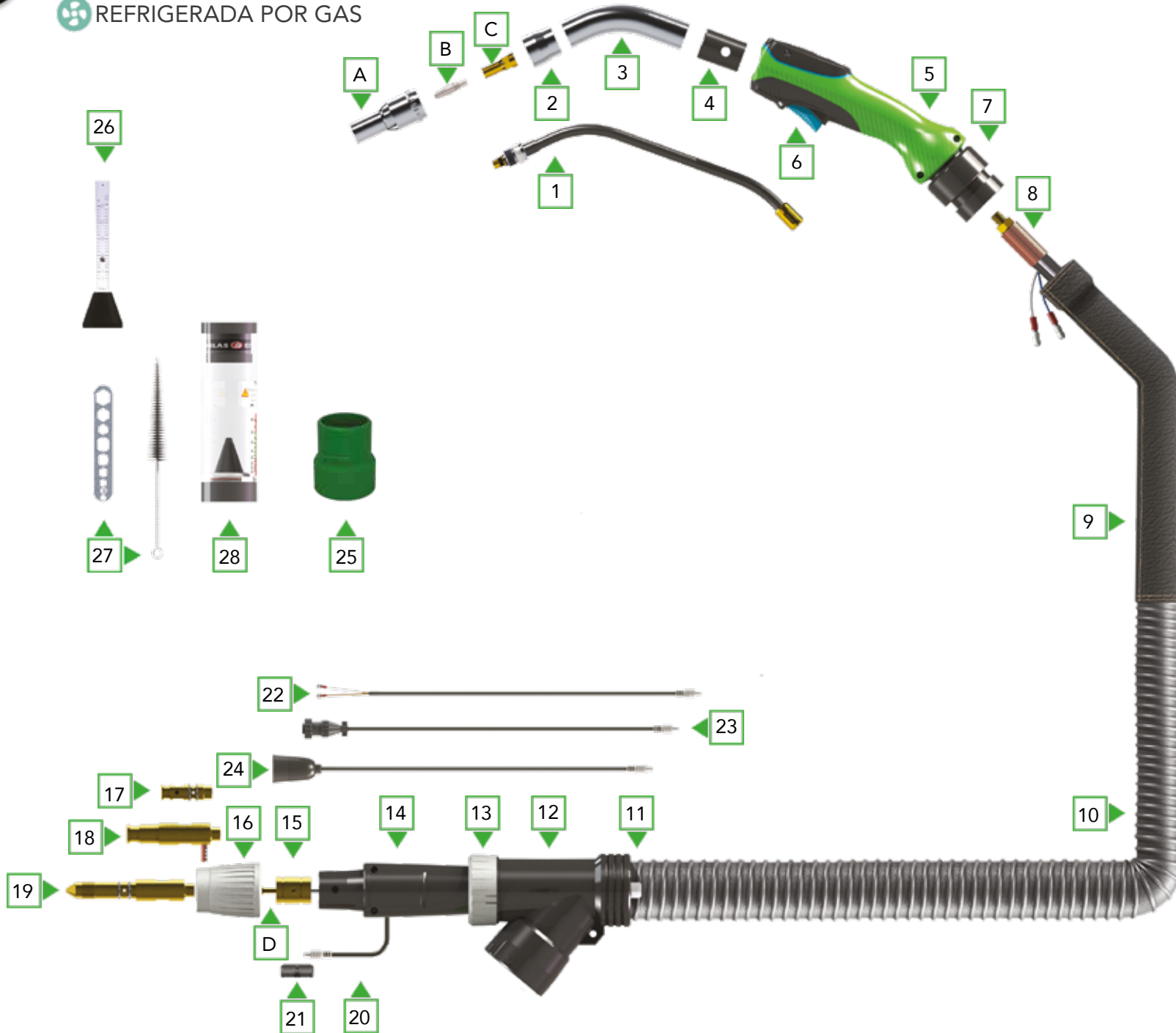

PART NO.	DESCRIPTION	PACK QTY
COMPLETE TORCHES		
8XO1000305000	8XE MINI Extractor USA 250AMP 10ft (3mtr) air cooled - 45° (standard)	1
8XO1000405000	8XE MINI Extractor USA 250AMP 13ft (4mtr) air cooled - 45° (standard)	1
8XO1000505000	8XE MINI Extractor USA 250AMP 16ft (5mtr) air cooled - 45° (standard)	1
8XO1000605000	8XE MINI Extractor USA 250AMP 20ft (6mtr) air cooled - 45° (standard)	1
8XO1500305000	8XE MINI Extractor USA 250AMP 10ft (3mtr) air cooled - straight	1
8XO1500405000	8XE MINI Extractor USA 250AMP 13ft (4mtr) air cooled - straight	1
8XO1500505000	8XE MINI Extractor USA 250AMP 16ft (5mtr) air cooled - straight	1
8XO1500605000	8XE MINI Extractor USA 250AMP 20ft (6mtr) air cooled - straight	1

ITEM	PART NO.	DESCRIPTION	PACK QTY
CONSUMABLES			
A	3937000	Nozzle conical 12mm	5
	3937001	Nozzle conical 14mm special	5
	3937002	Nozzle conical 14mm	5
B	399008	Contact Tip 8XC/8XE - .030 (0.8)	25
	399010	Contact Tip 8XC/8XE - .040 (1.0)	25
	399012	Contact Tip 8XC/8XE - .045 (1.2)	25
	3990102	Contact Tip 8XC/8XE - .040 (1.0) Alu	25
	3990122	Contact Tip 8XC/8XE - .045 (1.2) Alu	25
	3990091	Contact Tip 8XC/8XE - .035 (0.9) CuCrZr	25
	3990101	Contact Tip 8XC/8XE - .040 (1.0) CuCrZr	25
	3990121	Contact Tip 8XC/8XE - .045 (1.2) CuCrZr	25
C	39327110	Tip adapter	10
D	301535-USA	Plastic coated liner blue 10ft (3mtr) - for .030 wire	1
	301545-USA	Plastic coated liner blue 13ft (4mtr) - for .030 wire	1
	301555-USA	Plastic coated liner blue 16ft (5mtr) - for .030 wire	1
	301565-USA	Plastic coated liner blue 20ft (6mtr) - for .030 wire	1
	302535-USA	Plastic coated liner red 10ft (3mtr) - for .035 to .045 wire	1
	302545-USA	Plastic coated liner red 13ft (4mtr) - for .035 to .045 wire	1
	302555-USA	Plastic coated liner red 16ft (5mtr) - for .035 to .045 wire	1
	302565-USA	Plastic coated liner red 20ft (6mtr) - for .035 to .045 wire	1

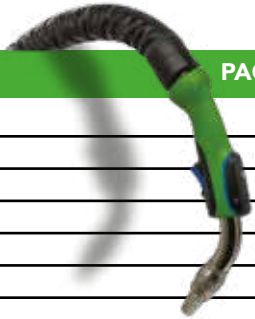

ITEM	PART NO.	DESCRIPTION	PACK QTY
SPARE PARTS			
1	39301045	Swanneck 45°	1
	39301000	Swan neck straight	1
	3950005	PEEK ring to fix nozzle holder (not shown)	5
2	3950000	Nozzle holder	1
3	3950045	Metal neck 45°	1
	3950050	Metal neck straight	1
4	3950500	Adapter to fit MINI neck	1
5	391000	Handle green/black complete with trigger	1
6	3912009	Trigger with spring	1
	391250	Micro switch complete (not shown)	1
7	381900	Cable support set with ball-and-socket joint	1
8	259263X8	Cable assembly 10ft (3mtr)	1
	259264X8	Cable assembly 13ft (4mtr)	1
	259265X8	Cable assembly 16ft (5mtr)	1
	259266X8	Cable assembly 20ft (6mtr)	1
9	260019	Leather-sheathing with velcro 6ft (2mtr)	1
10	340303	Fume extraction hose 10ft (3mtr)	1
	340304	Fume extraction hose 13ft (4mtr)	1
	340305	Fume extraction hose 16ft (5mtr)	1
	340306	Fume extraction hose 20ft (6mtr)	1
11	398031	Hose connection	1
12	398100	Housing (Y-shape) for fume extraction hose	1
13	398015	Connection ring	1
14	398010	Housing set for central connector	1
15	3059001	Central connector	1
16	398200	Adaptor nut	1
17	3059100	Tweco tail	1
18	3059200S	Lincoln tail complete with gas hose	1
19	3059150	Miller tail	1
20	349200	Switch cable 45cm (Quick connect)	1
21	306545	Locking clip (Quick connect)	5
22	349130	Tweco swith cable end (Quick connect)	1
23	349120	Miller swith cable end (Quick connect)	1
24	349110	Lincoln swith cable end (Quick connect)	1
25	398110	Hose adapter	1
26	406050	Gasflow meter	1
27	371208	Tool set (brush and multitool)	1
28	371350	Airflow meter MINI Extractor	1
-	320300	Ceramic dry film spray 400 ml (not shown)	12



8XE MIG 400 EXTRACTOR - USA

CO2 - 420 AMP, MEZCLA - 400 AMP, CICLO DE SERVICIO - 100%

REFRIGERADA POR GAS

MIG
EXTRACTOR

AIRE LIMPIO

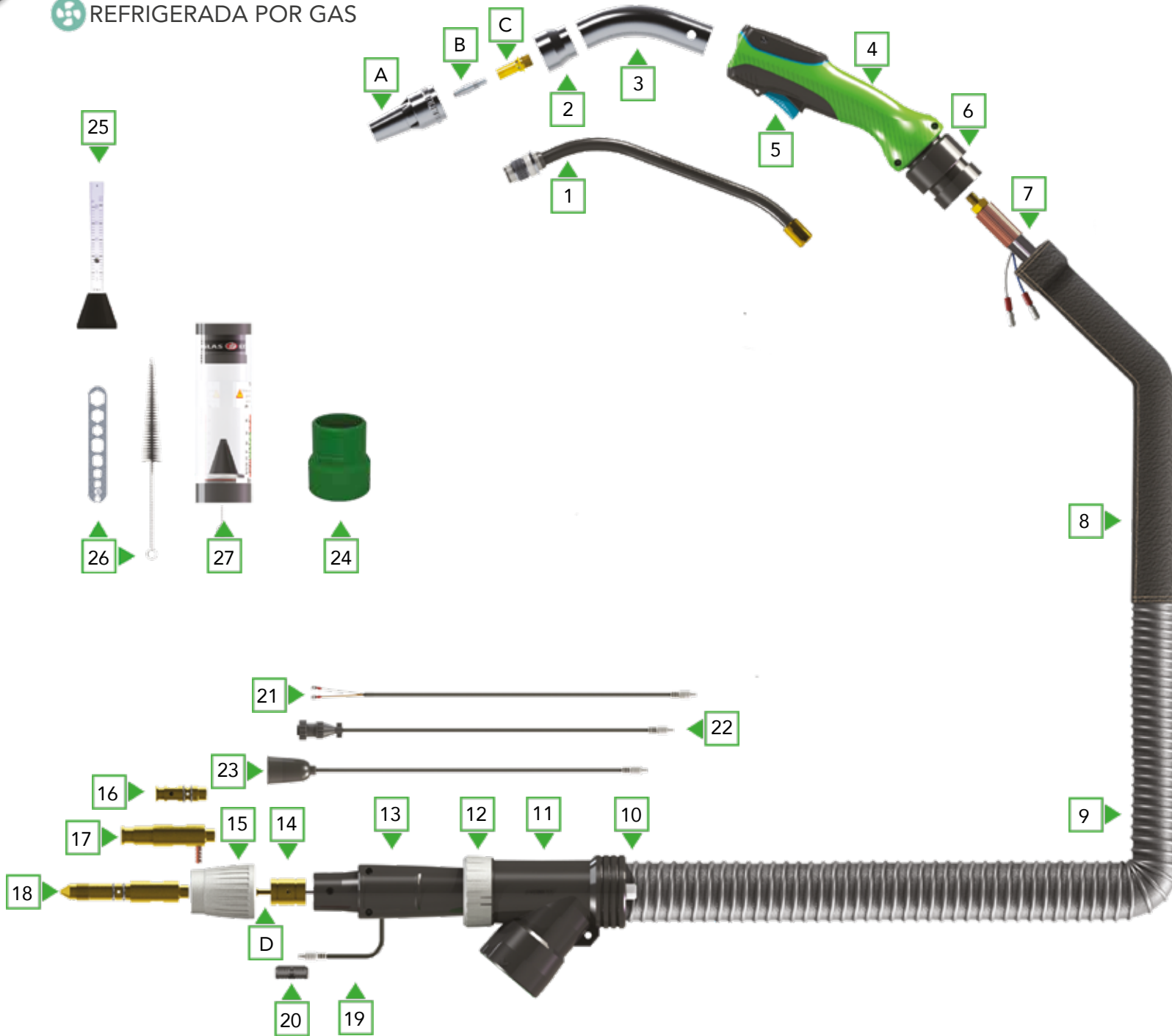

PART NO.	DESCRIPTION	PACK QTY
COMPLETE TORCHES		
8XO4028405000	8XE Extractor USA 400AMP 10ft (3mtr) air cooled - 45° (standard)	1
8XO4028405000	8XE Extractor USA 400AMP 13ft (4mtr) air cooled - 45° (standard)	1
8XO4028505000	8XE Extractor USA 400AMP 16ft (5mtr) air cooled - 45° (standard)	1
8XO4028605000	8XE Extractor USA 400AMP 20ft (6mtr) air cooled - 45° (standard)	1
8XO4528305000	8XE Extractor USA 400AMP 10ft (3mtr) air cooled - straight	1
8XO4528405000	8XE Extractor USA 400AMP 13ft (4mtr) air cooled - straight	1
8XO4528505000	8XE Extractor USA 400AMP 16ft (5mtr) air cooled - straight	1
8XO4528605000	8XE Extractor USA 400AMP 20ft (6mtr) air cooled - straight	1

ITEM	PART NO.	DESCRIPTION	PACK QTY
CONSUMABLES			
A	3937041	Nozzle conical .55 (14mm Special)	5
	3937045	Nozzle conical .67 (17mm Special)	5
B	399010	Contact Tip 8XC/8XE - 0.40 (1.0)	25
	399012	Contact Tip 8XC/8XE - 0.45 (1.2)	25
	399016	Contact Tip 8XC/8XE - 0.62 (1.6)	25
	3990102	Contact Tip 8XC/8XE - 0.40 (1.0) Alu	25
	3990122	Contact Tip 8XC/8XE - 0.45 (1.2) Alu	25
	3990091	Contact Tip 8XC/8XE - 0.35 (0.9) CuCrZr	25
	3990101	Contact Tip 8XC/8XE - 0.40 (1.0) CuCrZr	25
	3990121	Contact Tip 8XC/8XE - 0.45 (1.2) CuCrZr	25
	3990161	Contact Tip 8XC/8XE - 0.62 (1.6) CuCrZr	25
	3990201	Contact Tip 8XC/8XE - 0.78 (2.0) CuCrZr	25
	3990241	Contact Tip 8XC/8XE - 0.95 (2.4) CuCrZr	25
C	39327310	Tip adapter	10
D	303793-USA	Plastic coated liner black 10ft (3mtr) - for .040 to .045 wire	1
	303794-USA	Plastic coated liner black 13ft (4mtr) - for .040 to .045 wire	1
	303795-USA	Plastic coated liner black 16ft (5mtr) - for .040 to .045 wire	1
	303796-USA	Plastic coated liner black 20ft (6mtr) - for .040 to .045 wire	1
	303763-USA	Plastic coated liner grey 10ft (3mtr) - for .062 wire	1
	303764-USA	Plastic coated liner grey 13ft (4mtr) - for .062 wire	1
	303765-USA	Plastic coated liner grey 16ft (5mtr) - for .062 wire	1
	303766-USA	Plastic coated liner grey 20ft (6mtr) - for .062 wire	1
	303803-USA	Plastic coated liner green 10ft (3mtr) - for .078 to .095 wire	1
	303804-USA	Plastic coated liner green 13ft (4mtr) - for .078 to .095 wire	1
	303805-USA	Plastic coated liner green 16ft (5mtr) - for .078 to .095 wire	1
	303806-USA	Plastic coated liner green 20ft (6mtr) - for .078 to .095 wire	1



ITEM	PART NO.	DESCRIPTION	PACK QTY
SPARE PARTS			
1	39302145	Swanneck 45°	1
	39302100	Swan neck straight	1
	3950205	PEEK ring to fix nozzle holder (not shown)	5
2	3950200	Nozzle holder	1
3	3950245	Metal neck 45°	1
	3950250	Metal neck straight	1
4	391000	Handle green/black complete with trigger	1
5	3912009	Trigger with spring	1
	391250	Micro switch complete (not shown)	1
6	381920	Cable support set with ball-and-socket joint	1
7	259463X8U	Cable assembly 10ft (3mtr)	1
	259464X8U	Cable assembly 13ft (4mtr)	1
	259465X8U	Cable assembly 16ft (5mtr)	1
	259466X8U	Cable assembly 20ft (6mtr)	1
8	260018	Leather-sheathing with velcro 6ft (2mtr)	1
9	3402032	Fume extraction hose 10ft (3mtr)	1
	3402042	Fume extraction hose 13ft (4mtr)	1
	3402052	Fume extraction hose 16ft (5mtr)	1
	3402062	Fume extraction hose 20ft (6mtr)	1
10	398030	Hose connection	1
11	398100	Housing (Y-shape) for fume extraction hose	1
12	398015	Connection ring	1
13	398010	Housing set for central connector	1
14	30590012	Central connector	1
15	398200	Adaptor nut	1
16	3059100	Tweco tail	1
17	3059200S	Lincoln tail complete with gas hose	1
18	3059150	Miller tail	1
19	349200	Switch cable 45cm (Quick connect)	1
20	306545	Locking clip (Quick connect)	5
21	349130	Tweco swith cable end (Quick connect)	1
22	349120	Miller swith cable end (Quick connect)	1
23	349110	Lincoln swith cable end (Quick connect)	1
24	398110	Hose adapter	1
25	406050	Gasflow meter	1
26	371208	Tool set (brush and multitool)	1
27	371300	Airflow meter Extractor	1
-	320300	Ceramic dry film spray 400 ml (not shown)	12



8XE MIG 500 EXTRACTOR - USA

CO2 - 550 AMP, MEZCLA - 500 AMP, CICLO DE SERVICIO - 100%

REFRIGERADA POR AGUA

MIG

EXTRACTOR

AIRE LIMPIO

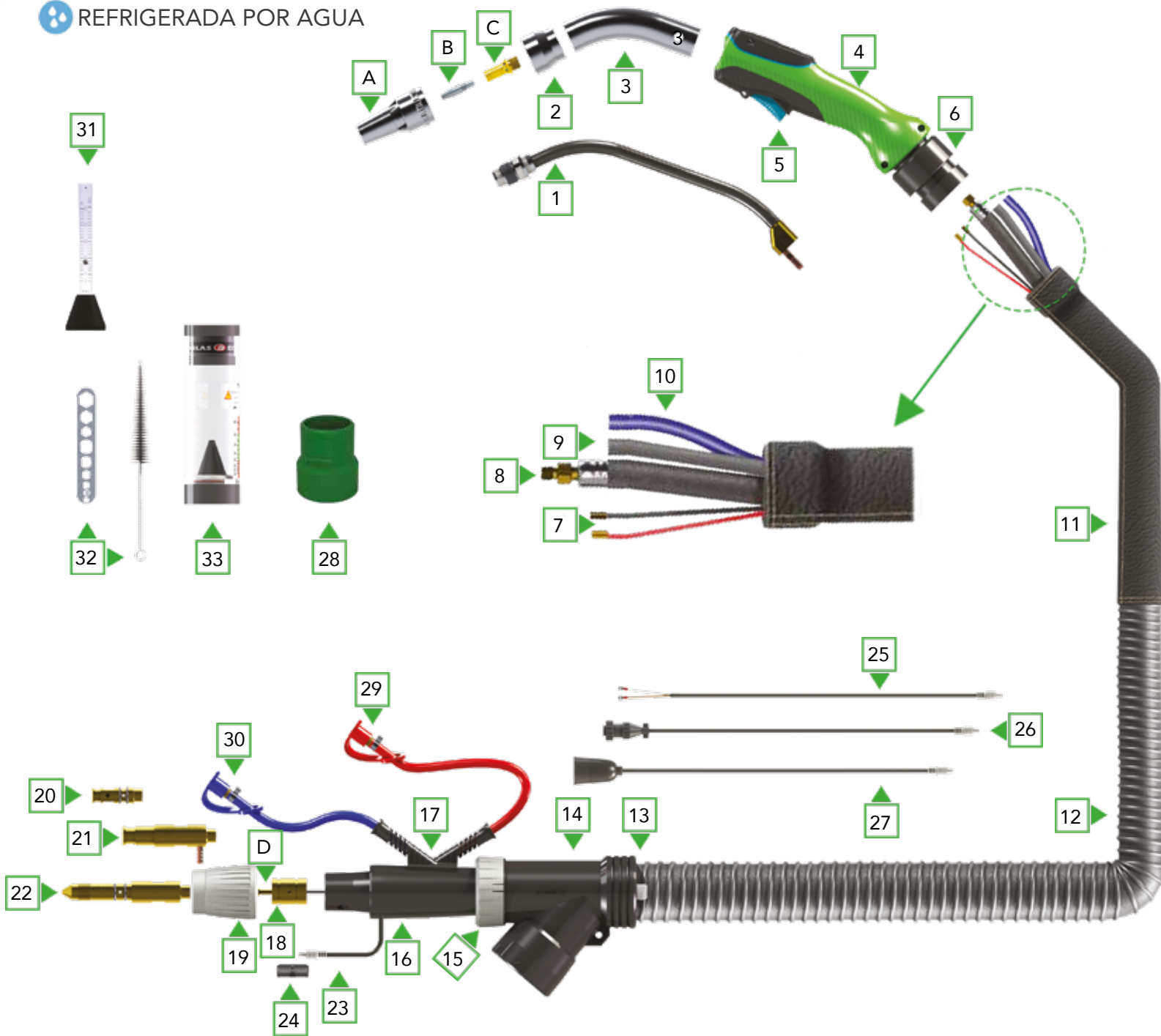

PART NO.	DESCRIPTION	PACK QTY
COMPLETE TORCHES		
8XO5060305000	8XE Extractor USA 500AMP 10ft (3mtr) water cooled - 45° (standard)	1
8XO5060405000	8XE Extractor USA 500AMP 13ft (4mtr) water cooled - 45° (standard)	1
8XO5060505000	8XE Extractor USA 500AMP 16ft (5mtr) water cooled - 45° (standard)	1
8XO5060605000	8XE Extractor USA 500AMP 20ft (6mtr) water cooled - 45° (standard)	1
8XO5560305000	8XE Extractor USA 500AMP 10ft (3mtr) water cooled - straight	1
8XO5560405000	8XE Extractor USA 500AMP 13ft (4mtr) water cooled - straight	1
8XO5560505000	8XE Extractor USA 500AMP 16ft (5mtr) water cooled - straight	1
8XO5560605000	8XE Extractor USA 500AMP 20ft (6mtr) water cooled - straight	1

ITEM	PART NO.	DESCRIPTION	PACK QTY
CONSUMABLES			
A	3937041	Nozzle conical .55 (14mm Special)	5
	3937045	Nozzle conical .67 (17mm Special)	5
B	399010	Contact Tip 8XC/8XE - 0.40 (1.0)	25
	399012	Contact Tip 8XC/8XE - 0.45 (1.2)	25
	399016	Contact Tip 8XC/8XE - 0.62 (1.6)	25
	3990102	Contact Tip 8XC/8XE - 0.40(1.0) Alu	25
	3990122	Contact Tip 8XC/8XE - 0.45 (1.2) Alu	25
	3990091	Contact Tip 8XC/8XE - 0.35 (0.9) CuCrZr	25
	3990101	Contact Tip 8XC/8XE - 0.40 (1.0) CuCrZr	25
	3990121	Contact Tip 8XC/8XE - 0.45 (1.2) CuCrZr	25
	3990161	Contact Tip 8XC/8XE - 0.62 (1.6) CuCrZr	25
C	39327210	Tip adapter	10
D	302535-USA	Plastic coated liner red 10ft (3mtr) - for .035 to .045 wire	1
	302545-USA	Plastic coated liner red 13ft (4mtr) - for .035 to .045 wire	1
	302555-USA	Plastic coated liner red 16ft (5mtr) - for .035 to .045 wire	1
	302565-USA	Plastic coated liner red 20ft (6mtr) - for .035 to .045 wire	1
	303635-USA	Plastic coated liner yellow 10ft (3mtr) - for .062 wire	1
	303645-USA	Plastic coated liner yellow 13ft (4mtr) - for .062 wire	1
	303655-USA	Plastic coated liner yellow 16ft (5mtr) - for .062 wire	1
	303665-USA	Plastic coated liner yellow 20ft (6mtr) - for .062 wire	1

ITEM	PART NO.	DESCRIPTION	PACK QTY
SPARE PARTS			
1	39303045	Swanneck 45°	1
	39303000	Swan neck straight	1
	3950205	PEEK ring to fix nozzle holder (not shown)	5
2	3950200	Nozzle holder	1
3	3950245	Metal neck 45°	1
	3950250	Metal neck straight	1

ITEM	PART NO.	DESCRIPTION	PACK QTY
SPARE PARTS			
4	391000	Handle green/black complete with trigger	1
5	3912009	Trigger with spring	1
	391250	Micro switch complete (not shown)	1
6	381920	Cable support set with ball-and-socket joint	1
7	306505	Switch cable 1x0,75mm ² per mtr	100
8	258513X8	Power/water cable 10ft (3mtr)	1
	258514X8	Power/water cable 13ft (4mtr)	1
	258515X8	Power/water cable 16ft (5mtr)	1
	258516X8	Power/water cable 20ft (6mtr)	1
9	2585313XE	Outer liner 10ft (3mtr)	1
	2585314XE	Outer liner 13ft (4mtr)	1
	2585315XE	Outer liner 16ft (5mtr)	1
	2585316XE	Outer liner 20ft (6mtr)	1
10	258535	Water inlet hose blue per mtr	100
	258566	Water outlet hose red per mtr	100
11	260018	Leather-sheathing with velcro 6ft (2mtr)	1
12	3402032	Fume extraction hose 10ft (3mtr)	1
	3402042	Fume extraction hose 13ft (4mtr)	1
	3402052	Fume extraction hose 16ft (5mtr)	1
	3402062	Fume extraction hose 20ft (6mtr)	1
13	398030	Hose connection	1
14	398100	Housing (Y-shape) for fume extraction hose	1
15	398015	Connection ring	1
16	398010	Housing set for central connector	1
17	350881	Water hose guide	1
18	3059002	Central connector	1
19	398200	Adaptor nut	1
20	3059100	Tweco tail	1
21	3059200S	Lincoln tail complete with gas hose	1
22	3059150	Miller tail	1
23	349200	Switch cable 45cm (Quick connect)	1
24	306545	Locking clip (Quick connect)	5
25	349130	Tweco swith cable end (Quick connect)	1
26	349120	Miller swith cable end (Quick connect)	1
27	349110	Lincoln swith cable end (Quick connect)	1
28	398110	Hose adapter	1
29	258701	Waterstop red	10
30	258702	Waterstop blue	10
31	406050	Gasflow metre	1
32	371208	Tool set (brush and multitool)	1
33	371300	Airflow meter Extractor	1
	320300	Ceramic dry film spray 400 ml (not shown)	12



8XE MINI 200 MIG EXTRACTOR (EURO)

CO2 - 230 AMP, MEZCLA - 200 AMP, CICLO DE SERVICIO - 100%

REFRIGERADA POR GAS

MIG
EXTRACTOR

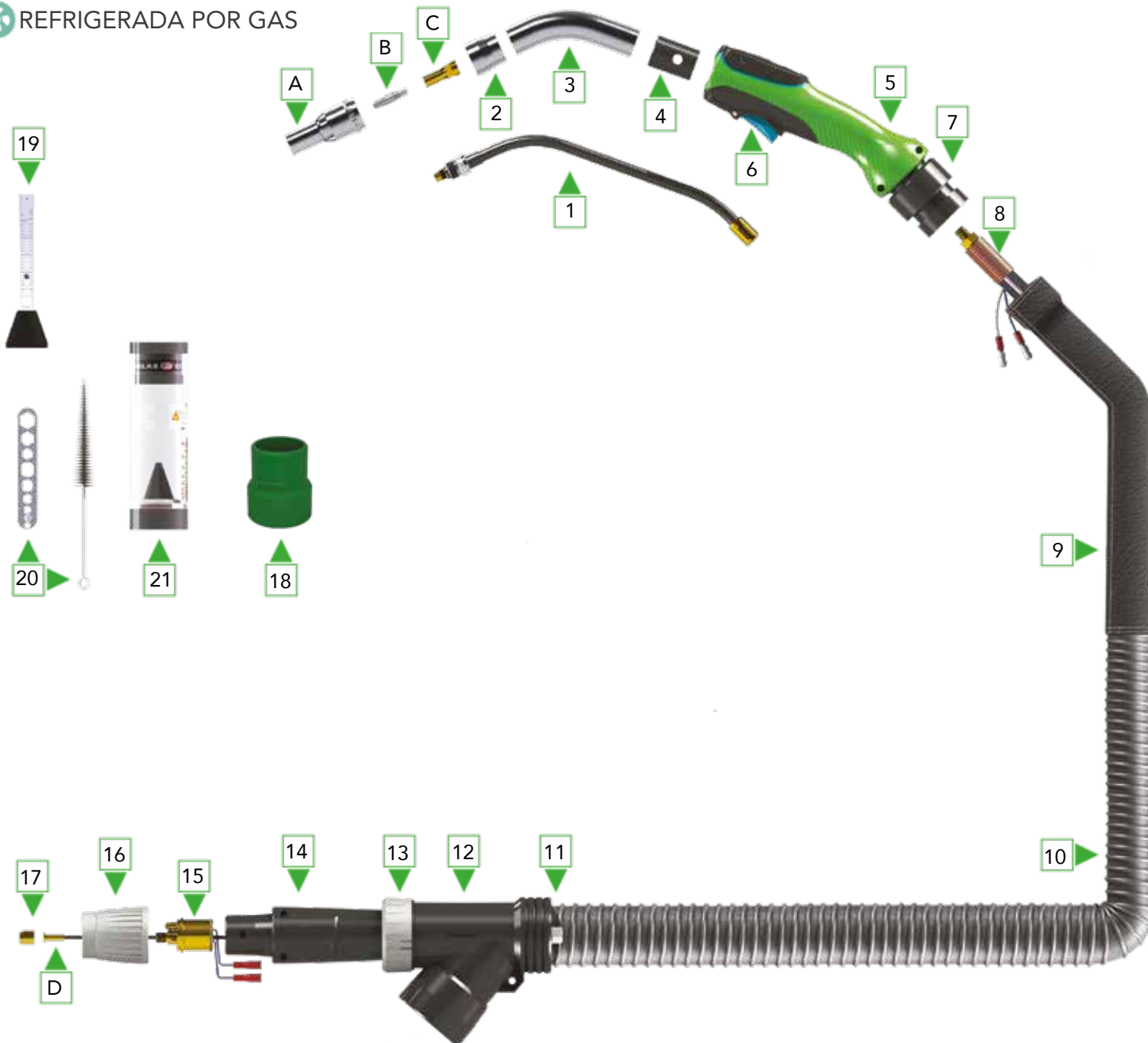

AIRE LIMPIO



PART NO.	DESCRIPTION	PACK QTY
COMPLETE TORCHES		
8XE1001301000	8XE MINI Extractor 200AMP 10ft (3mtr) air cooled - 45° (standard)	1
8XE1001401000	8XE MINI Extractor 200AMP 13ft (4mtr) air cooled - 45° (standard)	1
8XE1001501000	8XE MINI Extractor 200AMP 16ft (5mtr) air cooled - 45° (standard)	1
8XE1101301000	8XE MINI Extractor 200AMP 10ft (3mtr) air cooled - 30°	1
8XE1101401000	8XE MINI Extractor 200AMP 13ft (4mtr) air cooled - 30°	1
8XE1101501000	8XE MINI Extractor 200AMP 16ft (5mtr) air cooled - 30°	1

ITEM	PART NO.	DESCRIPTION	PACK QTY
CONSUMABLES			
A	3937000	Nozzle conical 12mm	5
	3937001	Nozzle conical 14mm special	5
	3937002	Nozzle conical 14mm	5
B	399008	Contact Tip 8XC/8XE - .030 (0.8)	25
	399010	Contact Tip 8XC/8XE - .040 (1.0)	25
	399012	Contact Tip 8XC/8XE - .045 (1.2)	25
	3990102	Contact Tip 8XC/8XE - .040 (1.0) Alu	25
	3990122	Contact Tip 8XC/8XE - .045 (1.2) Alu	25
	3990101	Contact Tip 8XC/8XE - .040 (1.0) CuCrZr	25
	3990121	Contact Tip 8XC/8XE - .045 (1.2) CuCrZr	25
C	39327110	Tip adapter	10
D	301535	Plastic coated liner blue 10ft (3mtr) - for .030 wire	1
	301545	Plastic coated liner blue 13ft (4mtr) - for .030 wire	1
	301555	Plastic coated liner blue 16ft (5mtr) - for .030 wire	1
	302535	Plastic coated liner red 10ft (3mtr) - for .030 wire	1
	302545	Plastic coated liner red 13ft (4mtr) - for .030 wire	1
	302555	Plastic coated liner red 16ft (5mtr) - for .030 wire	1
	301538	Teflon liner blue 10ft (3mtr) - for .030 wire	1
	301548	Teflon liner blue 13ft (4mtr) - for .030 wire	1
	301558	Teflon liner blue 16ft (5mtr) - for .030 wire	1
	302538	Teflon liner red 10ft (3mtr) - for .030 wire	1
	302548	Teflon liner red 13ft (4mtr) - for .030 wire	1
	302558	Teflon liner red 16ft (5mtr) - for .030 wire	1



ITEM	PART NO.	DESCRIPTION	PACK QTY
SPARE PARTS			
1	39301045	Swanneck 45°	1
	39301030	Swanneck 30°	1
	3950005	PEEK ring to fix nozzle holder (not shown)	5
2	3950000	Nozzle holder	1
3	3950045	Metal neck 45°	1
	3950046	Metal neck 30°	1
4	3950500	Adapter to fit MINI neck	1
5	391000	Handle green/black complete with trigger	1
6	3912009	Trigger with spring	1
	391250	Micro switch complete (not shown)	1
7	381900	Cable support set with ball-and-socket joint	1
8	259163X8	Cable assembly 10ft (3mtr)	1
	259164X8	Cable assembly 13ft (4mtr)	1
	259165X8	Cable assembly 16ft (5mtr)	1
9	260019	Leather-sheathing with Velcro 10ft (3mtr)	1
10	340303	Fume extraction hose 30-38mm 10ft (3mtr)	1
	340304	Fume extraction hose 30-38mm 13ft (4mtr)	1
	340305	Fume extraction hose 30-38mm 16ft (5mtr)	1
11	398031	Hose connection	1
12	398100	Housing (Y-shape) for fume extraction hose	1
13	398015	Connection ring	1
14	398010	Housing set for central connector	1
15	305298E23	Central connector Euro	1
16	8M9420	Adaptor nut	2
17	305315	Liner positioner nut	10
18	398110	Hose adapter	1
19	406050	Gasflow meter	1
20	371208	Tool set (brush and multitool)	1
21	371350	Airflow meter MINI Extractor	1
-	320300	Ceramic dry film spray 400 ml (not shown)	12

EXTRACCIÓN



8XE MINI 250 MIG EXTRACTOR (EURO)

CO2 - 280 AMP, MEZCLA - 250 AMP, CICLO DE SERVICIO - 100%

REFRIGERADA POR GAS

MIG
EXTRACTOR

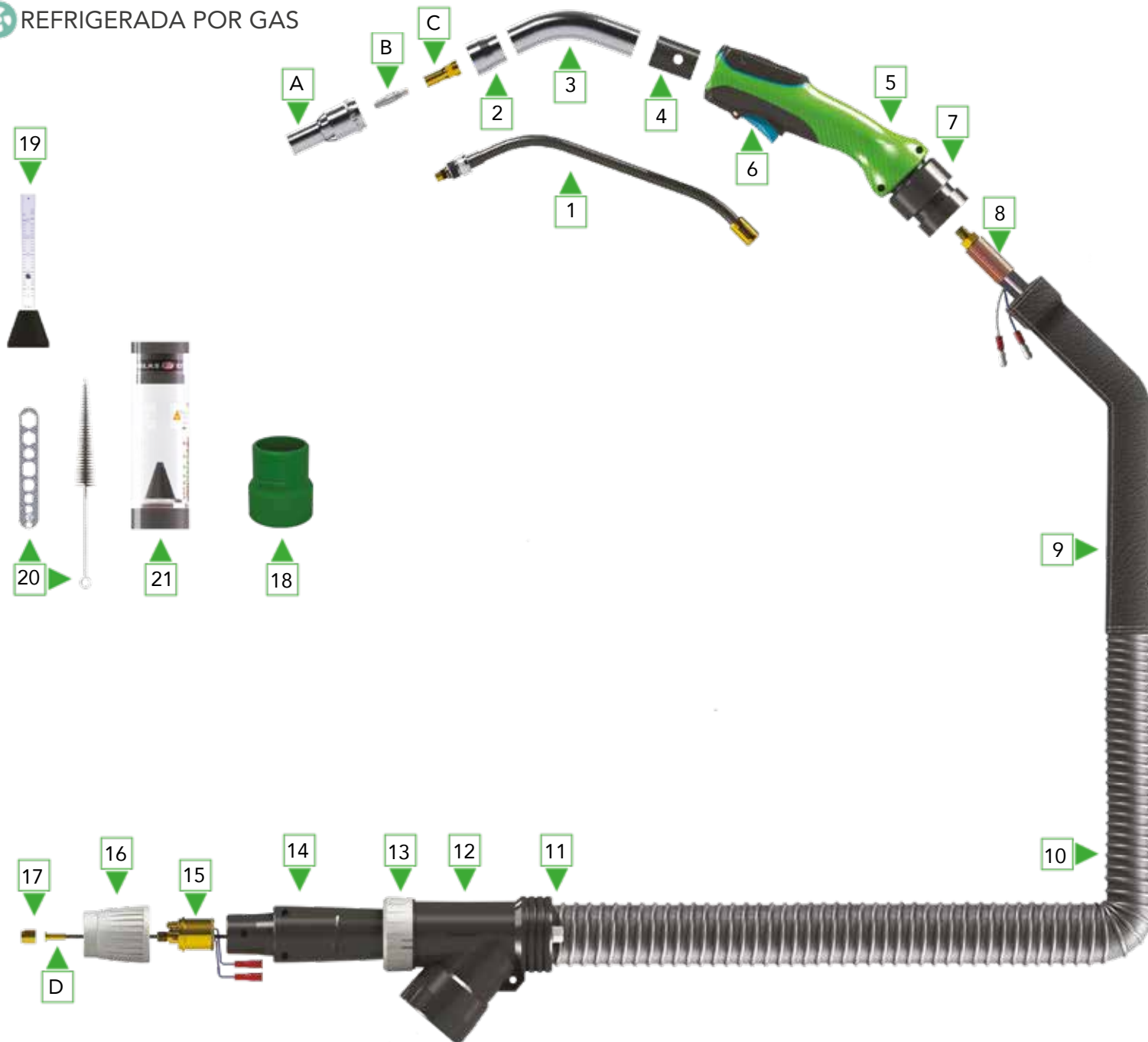

AIRE LIMPIO

PART NO.	DESCRIPTION	PACK QTY
COMPLETE TORCHES		
8XO1000301000	8XE MINI Extractor 250AMP 10ft (3mtr) air cooled - 45° (standard)	1
8XO1000401000	8XE MINI Extractor 250AMP 13ft (4mtr) air cooled - 45° (standard)	1
8XO1000501000	8XE MINI Extractor 250AMP 16ft (5mtr) air cooled - 45° (standard)	1
8XO1500301000	8XE MINI Extractor 250AMP 10ft (3mtr) air cooled - Straight	1
8XO1500401000	8XE MINI Extractor 250AMP 13ft (4mtr) air cooled - Straight	1
8XO1500501000	8XE MINI Extractor 250AMP 16ft (5mtr) air cooled - Straight	1

ITEM	PART NO.	DESCRIPTION	PACK QTY
CONSUMABLES			
A	3937000	Nozzle conical 12mm	5
	3937001	Nozzle conical 14mm special	5
	3937002	Nozzle conical 14mm	5
B	399008	Contact Tip 8XC/8XE - .030 (0.8)	25
	399010	Contact Tip 8XC/8XE - .040 (1.0)	25
	399012	Contact Tip 8XC/8XE - .045 (1.2)	25
	3990102	Contact Tip 8XC/8XE - .040 (1.0) Alu	25
	3990122	Contact Tip 8XC/8XE - .045 (1.2) Alu	25
	3990091	Contact Tip 8XC/8XE - 0.35 (0.9) CuCrZr	25
	3990101	Contact Tip 8XC/8XE - .040 (1.0) CuCrZr	25
	3990121	Contact Tip 8XC/8XE - .045 (1.2) CuCrZr	25
C	39327110	Tip adapter	10
D	301535	Plastic coated liner blue 10ft (3mtr) - for .030 wire	1
	301545	Plastic coated liner blue 13ft (4mtr) - for .030 wire	1
	301555	Plastic coated liner blue 16ft (5mtr) - for .030 wire	1
	302535	Plastic coated liner red 10ft (3mtr) - for .030 wire	1
	302545	Plastic coated liner red 13ft (4mtr) - for .030 wire	1
	302555	Plastic coated liner red 16ft (5mtr) - for .030 wire	1
	301538	Teflon liner blue 10ft (3mtr) - for .030 wire	1
	301548	Teflon liner blue 13ft (4mtr) - for .030 wire	1
	301558	Teflon liner blue 16ft (5mtr) - for .030 wire	1
	302538	Teflon liner red 10ft (3mtr) - for .030 wire	1
	302548	Teflon liner red 13ft (4mtr) - for .030 wire	1
	302558	Teflon liner red 16ft (5mtr) - for .030 wire	1

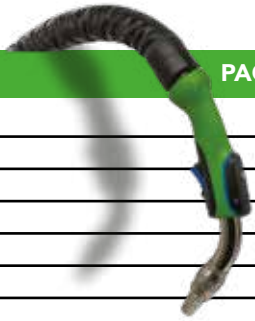

ITEM	PART NO.	DESCRIPTION	PACK QTY
SPARE PARTS			
1	39301045	Swanneck 45°	1
	39301000	Swanneck straight	1
	3950005	PEEK ring to fix nozzle holder (not shown)	5
2	3950000	Nozzle holder	1
3	3950045	Metal neck 45°	1
	3950050	Metal neck straight	1
4	3950500	Adapter to fit MINI neck	1
5	391000	Handle green/black complete with trigger	1
6	3912009	Trigger with spring	1
	391250	Micro switch complete (not shown)	1
7	381900	Cable support set with ball-and-socket joint	1
8	259263X8	Cable assembly 10ft (3mtr)	1
	259264X8	Cable assembly 13ft (4mtr)	1
	259265X8	Cable assembly 16ft (5mtr)	1
9	260019	Leather-sheathing with Velcro 6ft (2mtr)	1
10	340303	Fume extraction hose 32-38mm 10ft (3mtr)	1
	340304	Fume extraction hose 32-38mm 13ft (4mtr)	1
	340305	Fume extraction hose 32-38mm 16ft (5mtr)	1
11	398031	Hose connection	1
12	398100	Housing (Y-shape) for fume extraction hose	1
13	398015	Connection ring	1
14	398010	Housing set for central connector	1
15	305298E23	Central connector Euro	1
16	8M9420	Adaptor nut	2
17	305315	Liner positioner nut	10
18	398110	Hose adapter	1
29	406050	Gasflow meter	1
20	371208	Tool set (brush and multitool)	1
21	371350	Airflow meter MINI Extractor	1
-	320300	Ceramic dry film spray 400 ml (not shown)	12



8XE MIG 400 EXTRACTOR (EURO)

CO2 - 420 AMP, MEZCLA - 400 AMP, CICLO DE SERVICIO - 100%

REFRIGERADA POR GAS

MIG
EXTRACTOR

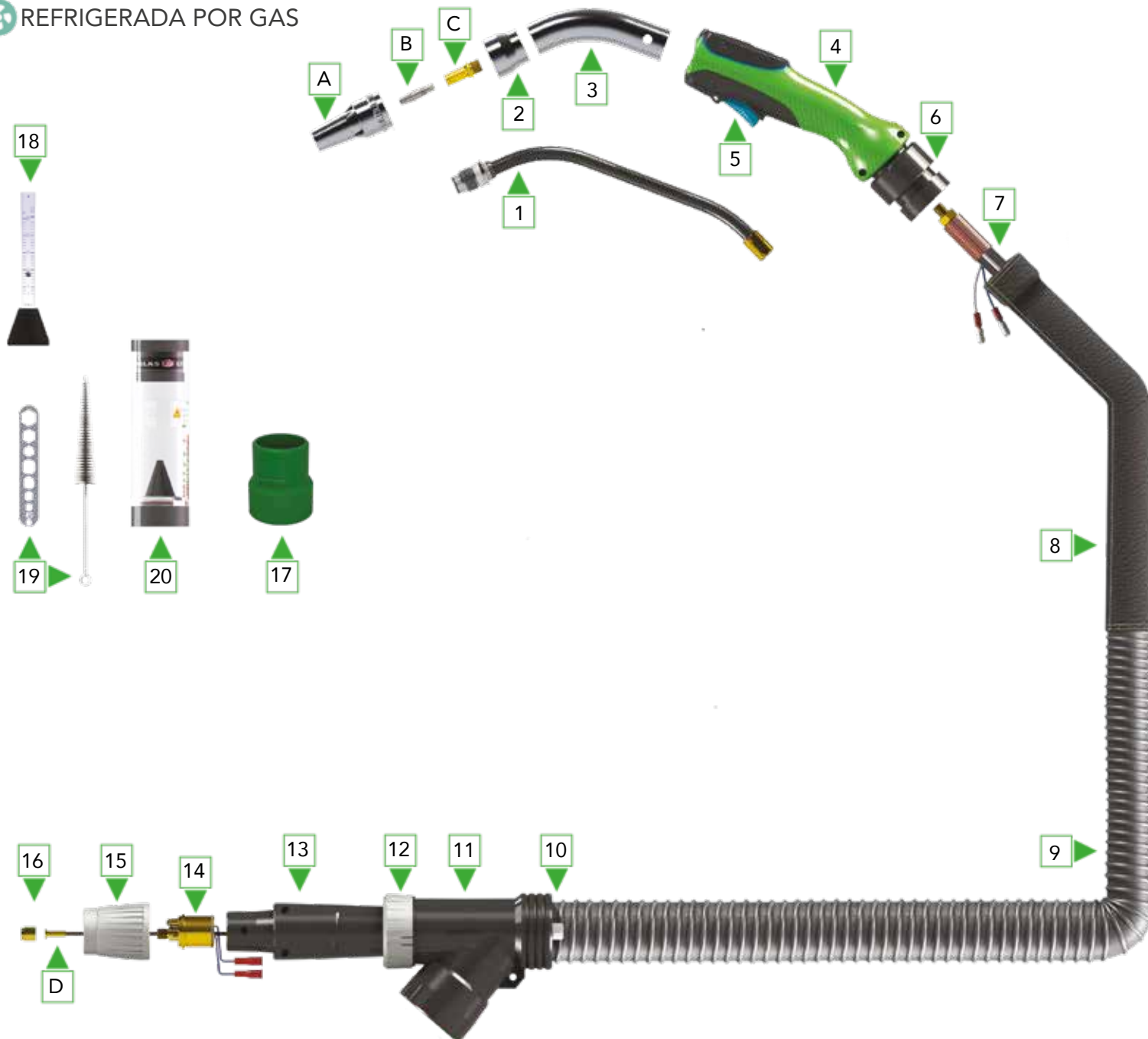

AIRE LIMPIO



PART NO.	DESCRIPTION	PACK QTY
COMPLETE TORCHES		
8XO4028301000	8XE Extractor 400AMP 10ft (3mtr) air cooled - 45° (standard)	1
8XO4028401000	8XE Extractor 400AMP 13ft (4mtr) air cooled - 45° (standard)	1
8XO4028501000	8XE Extractor 400AMP 16ft (5mtr) air cooled- 45° (standard)	1
8XO4528301000	8XE Extractor 400AMP 10ft (3mtr) air cooled - Straight	1
8XO4528401000	8XE Extractor 400AMP 13ft (4mtr) air cooled - Straight	1
8XO4528501000	8XE Extractor 400AMP 16ft (5mtr) air cooled - Straight	1

ITEM	PART NO.	DESCRIPTION	PACK QTY
CONSUMABLES			
A	3937041	Nozzle 8XR/8XE Extractor 14mm special	5
	3937045	Nozzle 8XR/8XE Extractor 17mm special	5
B	399010	Contact Tip 8XC/8XE - 0.40 (1.0)	25
	399012	Contact Tip 8XC/8XE - 0.45 (1.2)	25
	399016	Contact Tip 8XC/8XE - 0.62 (1.6)	25
	3990102	Contact Tip 8XC/8XE - 0.40 (1.0) Alu	25
	3990122	Contact Tip 8XC/8XE - 0.45 (1.2) Alu	25
	3990091	Contact Tip 8XC/8XE - 0.35 (0.9) CuCrZr	25
	3990101	Contact Tip 8XC/8XE - 0.40 (1.0) CuCrZr	25
	3990121	Contact Tip 8XC/8XE - 0.45 (1.2) CuCrZr	25
	3990161	Contact Tip 8XC/8XE - 0.62 (1.6) CuCrZr	25
C	39327310	Tip adapter	10
D	303793	Plastic coated liner black 10ft (3mtr) - for .040 to .045 wire	1
	303794	Plastic coated liner black 13ft (4mtr) - for .040 to .045 wire	1
	303795	Plastic coated liner black 16ft (5mtr) - for .040 to .045 wire	1
	303763	Plastic coated liner grey 10ft (3mtr) - for .062 wire	1
	303764	Plastic coated liner grey 13ft (4mtr) - for .062 wire	1
	303765	Plastic coated liner grey 16ft (5mtr) - for .062 wire	1
	304830	Graphite liner black 10ft (3mtr) combiliner - for 1.0/1.2mm wire	1
	304831	Graphite liner black 13ft (4mtr) combiliner - for 1.0/1.2mm wire	1
	304832	Graphite liner black 16ft (5mtr) combiliner - for 1.0/1.2mm wire	1
	3048351	Graphite liner black 10ft (3mtr) combiliner - for 1.6mm wire	1
	3048361	Graphite liner black 13ft (4mtr) combiliner - for 1.6mm wire	1
	3048371	Graphite liner black 16ft (5mtr) combiliner - for 1.6mm wire	1



ITEM	PART NO.	DESCRIPTION	PACK QTY
SPARE PARTS			
1	39302145	Swanneck 45°	1
	39302100	Swanneck straight	1
	3950205	PEEK ring to fix nozzle holder (not shown)	5
2	3950200	Nozzle holder	1
3	3950245	Metal neck 45°	1
	3950250	Metal neck Straight	1
4	391000	Handle green/black complete with trigger	1
5	3912009	Trigger with spring	1
	391250	Micro switch complete (not shown)	1
6	381920	Cable support set with ball-and-socket joint	1
7	259463X8	Cable assembly 10ft (3mtr)	1
	259464X8	Cable assembly 13ft (4mtr)	1
	259465X8	Cable assembly 16ft (5mtr)	1
8	260018	Leather-sheathing with Velcro 6ft (2mtr)	1
9	3402032	Fume extraction hose 36-44mm 10ft (3mtr)	1
	3402042	Fume extraction hose 36-44mm 13ft (4mtr)	1
	3402052	Fume extraction hose 36-44mm 16ft (5mtr)	1
10	398030	Hose connection	1
11	398100	Housing (Y-shape) for fume extraction hose	1
12	398015	Connection ring	1
13	398010	Housing set for central connector	1
14	3052988	Central connector Euro	1
15	8M9420	Adaptor nut	2
16	305315	Liner positioner nut	10
17	398110	Hose adapter	1
18	406050	Gasflow meter	1
19	371208	Tool set (brush and multitool)	1
20	371300	Airflow meter Extractor	1
-	320300	Ceramic dry film spray 400 ml (not shown)	12



8XE 500 MIG EXTRACTOR (EURO)

CO2 - 550 AMP, MEZCLA - 500 AMP, CICLO DE SERVICIO - 100%

REFRIGERADA POR AGUA

MIG

EXTRACTOR

AIRE LIMPIO

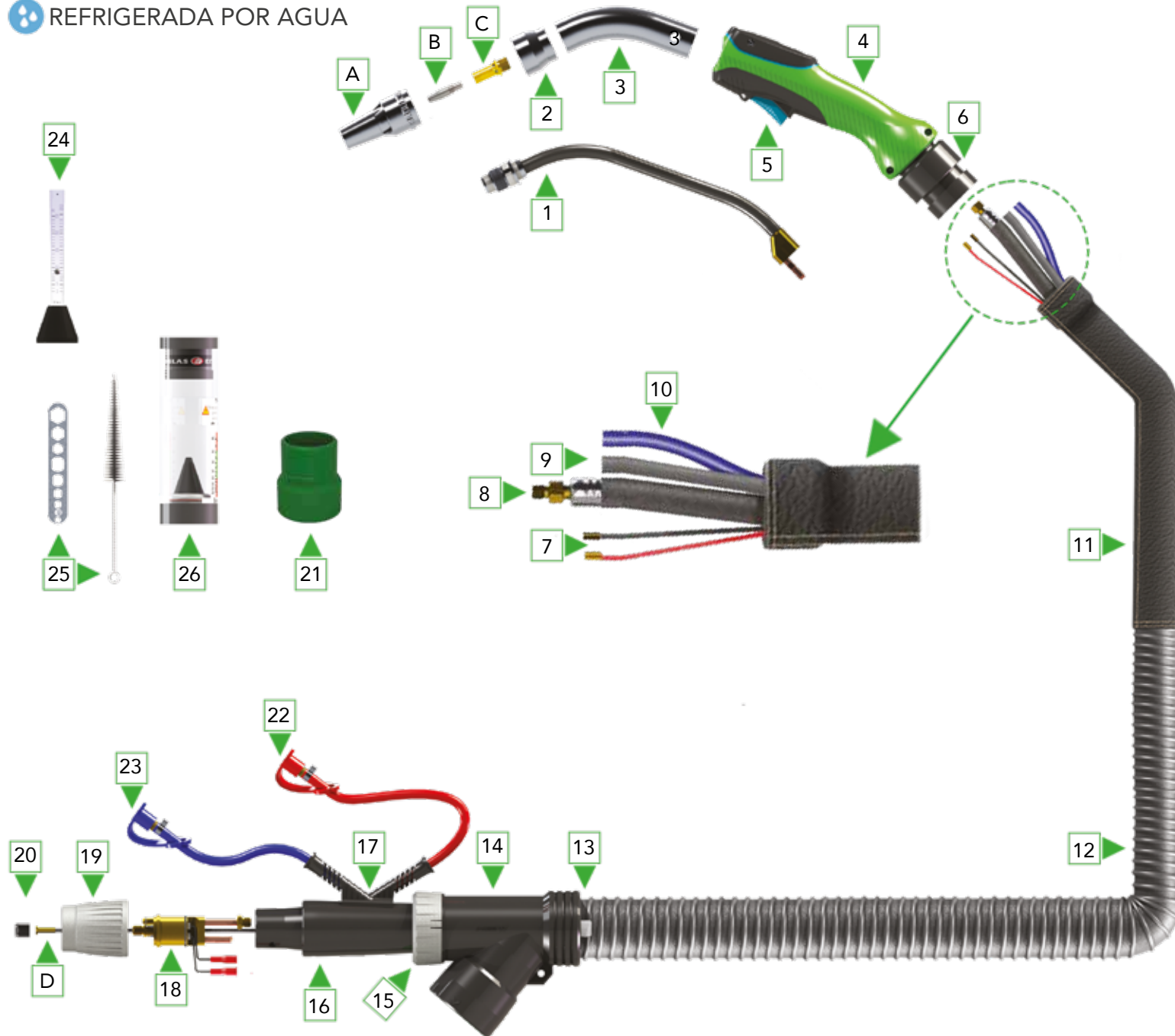

PART NO.	DESCRIPTION	PACK QTY
COMPLETE TORCHES		
8XO5060301000	8XE Extractor 500AMP 10ft (3mtr) water cooled - 45° (standard)	1
8XO5060401000	8XE Extractor 500AMP 13ft (4mtr) water cooled - 45° (standard)	1
8XO5060501000	8XE Extractor 500AMP 16ft (5mtr) water cooled - 45° (standard)	1
8XO5560301000	8XE Extractor 500AMP 10ft (3mtr) water cooled - Straight	1
8XO5560401000	8XE Extractor 500AMP 13ft (4mtr) water cooled - Straight	1
8XO5560501000	8XE Extractor 500AMP 16ft (5mtr) water cooled - Straight	1

ITEM	PART NO.	DESCRIPTION	PACK QTY
CONSUMABLES			
A	3937041	Nozzle 8XC/8XE Extractor 14mm special	5
	3937045	Nozzle 8XC/8XE Extractor 17mm special	5
B	399010	Contact Tip 8XC/8XE - 0.40 (1.0)	25
	399012	Contact Tip 8XC/8XE - 0.45 (1.2)	25
	399016	Contact Tip 8XC/8XE - 0.62 (1.6)	25
	3990102	Contact Tip 8XC/8XE - 0.40 (1.0) Alu	25
	3990122	Contact Tip 8XC/8XE - 0.45 (1.2) Alu	25
	3990091	Contact Tip 8XC/8XE - 0.35 (0.9) CuCrZr	25
	3990091	Contact Tip 8XC/8XE - 0.35 (0.9) CuCrZr	25
	3990101	Contact Tip 8XC/8XE - 0.40 (1.0) CuCrZr	25
	3990121	Contact Tip 8XC/8XE - 0.45 (1.2) CuCrZr	25
	3990161	Contact Tip 8XC/8XE - 0.62 (1.6) CuCrZr	25
C	39327210	Tip adapter	10
D	301535	Plastic coated liner blue 10ft (3mtr) - for 0.8mm wire	1
	301545	Plastic coated liner blue 13ft (4mtr) - for 0.8mm wire	1
	302555	Plastic coated liner red 16ft (5mtr) - for 1,0/1,2mm wire	1
	303635	Plastic coated liner red 10ft (3mtr) - for 1.6mm wire	1
	303645	Plastic coated liner red 13ft (4mtr) - for 1.6mm wire	1
	303655	Plastic coated liner red 16ft (5mtr) - for 1.6mm wire	1
	302538	Teflon red 10ft (3mtr) - for 1.0-1.2mm aluminium wire	1
	302548	Teflon red 13ft (4mtr) - for 1.0-1.2mm aluminium wire	1
	302558	Teflon red 16ft (5mtr) - for 1,0-1.2mm aluminium wire	1
	303638	Teflon red 10ft (3mtr) - for 1.6mm aluminium wire	1
	303648	Teflon red 13ft (4mtr) - for 1.6mm aluminium wire	1
	303658	Teflon red 16ft (5mtr) - for 1.6mm aluminium wire	1
	304830	Graphite liner black 10ft (3mtr) combiliner- for 1.0/1.2mm wire	1
	304831	Graphite liner black 13ft (4mtr) combiliner- for 1.0/1.2mm wire	1
	304832	Graphite liner black 16ft (5mtr) combiliner- for 1.0/1.2mm wire	1
	3048351	Graphite liner black 10ft (3mtr) combiliner- for 1.6mm wire	1
	3048361	Graphite liner black 13ft (4mtr) combiliner- for 1.6mm wire	1
	3048371	Graphite liner black 16ft (5mtr) combiliner- for 1.6mm wire	1



ITEM	PART NO.	DESCRIPTION	PACK QTY
SPARE PARTS			
1	39303045	Swanneck 45°	1
	39303000	Swanneck straight	1
	3950205	PEEK ring to fix nozzle holder (not shown)	5
2	3950200	Nozzle holder	1
3	3950245	Metal neck 45°	1
	39502250	Metal neck straight	1
4	391000	Handle green/black complete with trigger	1
5	3912009	Trigger with spring	1
	391250	Micro switch complete (not shown)	1
6	381920	Cable support set with ball-and-socket join	1
7	306505	Switch cable 1x0,75mm ² per mtr	100
8	258513X8	Power/water cable 10ft (3mtr)	1
	258514X8	Power/water cable 13ft (4mtr)	1
	258515X8	Power/water cable 5mtr	1
9	2585313XE	Outer liner 10ft (3mtr)	1
	2585314XE	Outer liner 13ft (4mtr)	1
	2585315XE	Outer liner 16ft (5mtr)	1
10	258535	Water inlet hose 5x8mm blue per mtr	100
	258566	Water outlet hose 5x8mm red per mtr	100
11	260018	Leather-sheathing with Velcro 6ft (3mtr)	1
12	3402032	Fume extraction hose 36-44mm 10ft (2mtr)	1
	3402042	Fume extraction hose 36-44mm 13ft (4mtr)	1
	3402052	Fume extraction hose 36-44mm 16ft (5mtr)	1
13	398030	Hose connection	1
14	398100	Housing (Y-shape) for fume extraction hose	1
15	398015	Connection ring	1
16	398010	Housing set for central connector	1
17	350881	Water hose guide	1
18	305304E23	Central connector Euro	1
19	8M9420	Adaptor nut	2
20	305315	Liner positioner nut	10
21	398110	Hose adapter	1
22	258701	Waterstop red	10
23	258702	Waterstop bluer	10
24	406050	Gasflow meter	1
25	371208	Tool set (brush and multitool)	1
26	371300	Airflow meter Extractor	1
-	320300	Ceramic dry film spray 400 ml (not shown)	12

EXTRACCIÓN



8XE MIG EXTRACTOR

CONSUMIBLES QUE SE ADAPTAN A SU APLICACIÓN DE SOLDADURA



PUNTAS DE CONTACTO

Las puntas de contacto especiales para la serie 8XE MIG Extractor está diseñada para prolongar su vida útil y se pueden colocar y quitar manualmente sin necesidad de herramientas

Opciones A Elegir :

- SECu para soldaduras diarias o CuCrZr para un mejor rendimiento.
- Disponible de 0,8 -2,4mm
- Punta especial para soldadura de aluminio



OPCIONES DE TOBERAS

Varios tipo de toberas están disponibles y se pueden cambiar muy fácilmente para adaptarse a cualquier aplicación de soldadura y proporcionar los mejores resultados.

MINI EXTRACTOR .47" (12mm)

Ofrece una cobertura más completa del gas protector en materiales de espesor medio en aplicaciones de unión a tope, solapada y de esquina exterior.

8XE REGULAR / MINI .55" (14mm-Especial)

Cuando el espacio es limitado y el ajuste es estrecho, esta boquilla ofrece mejor acceso y una cobertura de gas protector más óptima para evitar la porosidad. disponible en todas las antorchas 8XE.

8XE REGULAR .67" (17mm-Especial)

Para aplicaciones de juntas a tope y solapadas de mayor espesor, alta corriente y alto depósito, esta tobera ofrece una excelente cobertura de gas protector para evitar la porosidad.

MÓDULOS DE CUBIERTA SUPERIOR

El alivio de presión es una opción disponible bajo pedido.



Estándar

Alivio de presión



AIRE LIMPIO



8XE MIG EXTRACTOR

CONSUMIBLES QUE SE ADAPTAN A SU APLICACIÓN DE SOLDADURA

MIG
EXTRACTOR

CONECTORES DEL HILO DE SOLDADURA

Hay conectores de alimentación de alambre. Disponemos de conectores para cualquier tipo de máquina, incluyendo Tweco, Miller, Lincoln y ESAB (Euro). Gracias al diseño de la carcasa puede cambiar entre los tipos de conectores con facilidad.



MANTENIMIENTO



CAUDALÍMETRO

Utilice siempre el caudalímetro para garantizar la máxima eficacia de extracción.



MEDIDOR DE GAS

El contador de gas se utiliza para aplicar la cantidad precisa de gas protector en torno al cordón y obtener una soldadura de la mejor calidad.



SPRAY ANTIPROYECCIONES CERÁMICO

Prolongue la vida de su pistola y recambios aplicando el aerosol cerámico al 8XE Extractor.

SIRGAS

Elija la sirga correcta para el diámetro y tipo de hilo que utilice.

Negro: Hilos de 1,0-1,2mm (0,039-0,047")



Gris: Hilo de 1,6 mm (0,062")



Verde: Hilos de .078" - .094"



Todos los sirgas de camisa son adecuados para aplicaciones de acero inoxidable.

Azul: Hilos de .023" - .031"



Rojo: Hilos de .035" - .045"



Amarillo: Hilos .062"



EXTRACCIÓN



TRANSLAS 
DUTCH WELDING TECHNOLOGY

8TE TIG EXTRACTOR

EXTRACCIÓN

PARTÍCULAS NOCIVAS ELIMINADAS, SOLO AIRE LIMPO





8TE TIG EXTRACTOR



AIRE LIMPIO

EXTRACCIÓN EN EL ORIGEN

El 8TE TIG Extractor integra una vanguardista extracción de humos directamente donde se originan para el proceso de soldadura TIG.

¿LO SABÍA?

La soldadura de acero inoxidable y aluminio produce las partículas más tóxicas que se encuentran en los humos nocivos de la soldadura debido al cromo hexavalente y al manganeso .

VARIOS MÓDULOS DE INTERRUPTOR DISPONIBLES.

Colocado a aproximadamente 5 grados, el módulo de interruptor elimina cualquier tensión en los dedos y minimiza el riesgo de calambres debido a los movimientos repetitivos del proceso de soldadura.

Reduce los humos de soldadura hasta en un

98%

Consumibles de TIG estándar

MANGUERA EXTREMADAMENTE FLEXIBLE

El 8TE Extractor tiene una manguera de vacío extremadamente flexible, específicamente en el primer metro a partir del mango.

AIRE LIMPIO



EXTRACCIÓN



8TE TIG EXTRACTOR

TIG EXTRACTOR

LOS NUEVOS 8TE-17 Y 8TE-30 TIG EXTRACTOR

Nuestros TIG Extractors protegen a los soldadores así como los demás trabajadores de los humos nocivos y de las partículas tóxicas como el aluminio, el cromo, el hierro, el manganeso y el níquel que se liberan durante el proceso de soldadura.

MISMA EMPUÑADURA QUE LA ANTORCHA CONVENCIONAL 8XT.

El mango del 8TE TIG Extractor tiene una exclusiva forma ergonómica diseñada para adaptarse a la forma de la mano del soldador, encajando perfectamente entre los dedos pulgar e índice. La empuñadura está hecha de una duradera pero suave goma de TPE 2K.. Tanto la forma ergonómica como el material de la empuñadura contribuyen a la excelente estabilidad de la antorcha durante la soldadura.



CLEARO2 T100 / T200

Las unidades de extracción portátiles ClearO2 T100 / T200 que ofrece Translas están especialmente diseñadas para producir los mejores resultados al trabajar con el 8TE Extractor: hasta un 95 % de extracción de los humos de soldadura directamente donde se originan.



CARACTERÍSTICAS DEL PRODUCTO

- ✓ CAPTURA EN ORIGEN – EXTRACCIÓN DE HUMOS EN EL ANTORCHA.
- ✓ EXTRAE HASTA EL 95 % DE LOS HUMOS DE SOLDADURA PERJUDICIALES Y LAS PARTÍCULAS TÓXICAS DIRECTAMENTE DONDE SE ORIGINAN ANTES DE QUE SE DISPERSEN.
- ✓ EMPUÑADURA ERGONÓMICA PARA UNA MAYOR COMODIDAD Y ESTABILIDAD DURANTE TODO EL PROCESO DE SOLDADURA.
- ✓ BOQUILLA EXTRACTORA DE PPS CON ESCUDO CONTRA LA RADIACIÓN DEL ALUMINIO, REPUESTOS INTERCAMBIABLES.
- ✓ MANGUERA DE SUCCIÓN EXTREMADAMENTE FLEXIBLE.
- ✓ OPCIONAL: MANGUERA CON PROTECCIÓN RETARDANTE DE LLAMA.
- ✓ CONEXIÓN PARA ACOPLE GIRATORIO.
- ✓ SOPORTE PARA EL CABLE DETRÁS DE LA PIEZA EN Y.
- ✓ FLUJO DE SUCCIÓN EFECTIVO 18-20 M³.
- ✓ CAUDALÍMETRO PUEDE SER USADO EN TODA LA LINEA 8TE.

CHAPA PROTECTORA DE LA PLACA DE CIRCUITO IMPRESO.

El módulo PCB está fijo y completamente cubierto que lo protege del HF y a salvo de residuos y suciedad. Los exclusivos contactos de muelle dorados garantizan una conexión perfecta con el equipo de soldadura.



EXTRACCIÓN



EXTRACCIÓN



LÍNEA 8TE TIG EXTRACTOR

TIG
EXTRACTOR



8TE TIG EXTRACTOR

17 REFRIGERADA POR GAS

DC - 140 AMP
AC/DC - 100 AMP
Ciclo de servicio - 35%



8TE TIG EXTRACTOR

30 REFRIGERADA POR AGUA

DC - 320 AMP
AC/DC - 230 AMP
Ciclo de servicio - 100%



8TE TIG EXTRACTOR

35 REFRIGERADA POR AGUA

DC - 320 AMP
AC/DC - 230 AMP
Ciclo de servicio - 100%

EXTRACCIÓN



8TE-17 TIG EXTRACTOR

DC - 140 AMP, AC/DC - 100 AMP, DUTY CYCLE - 35%



AIRE LIMPIO

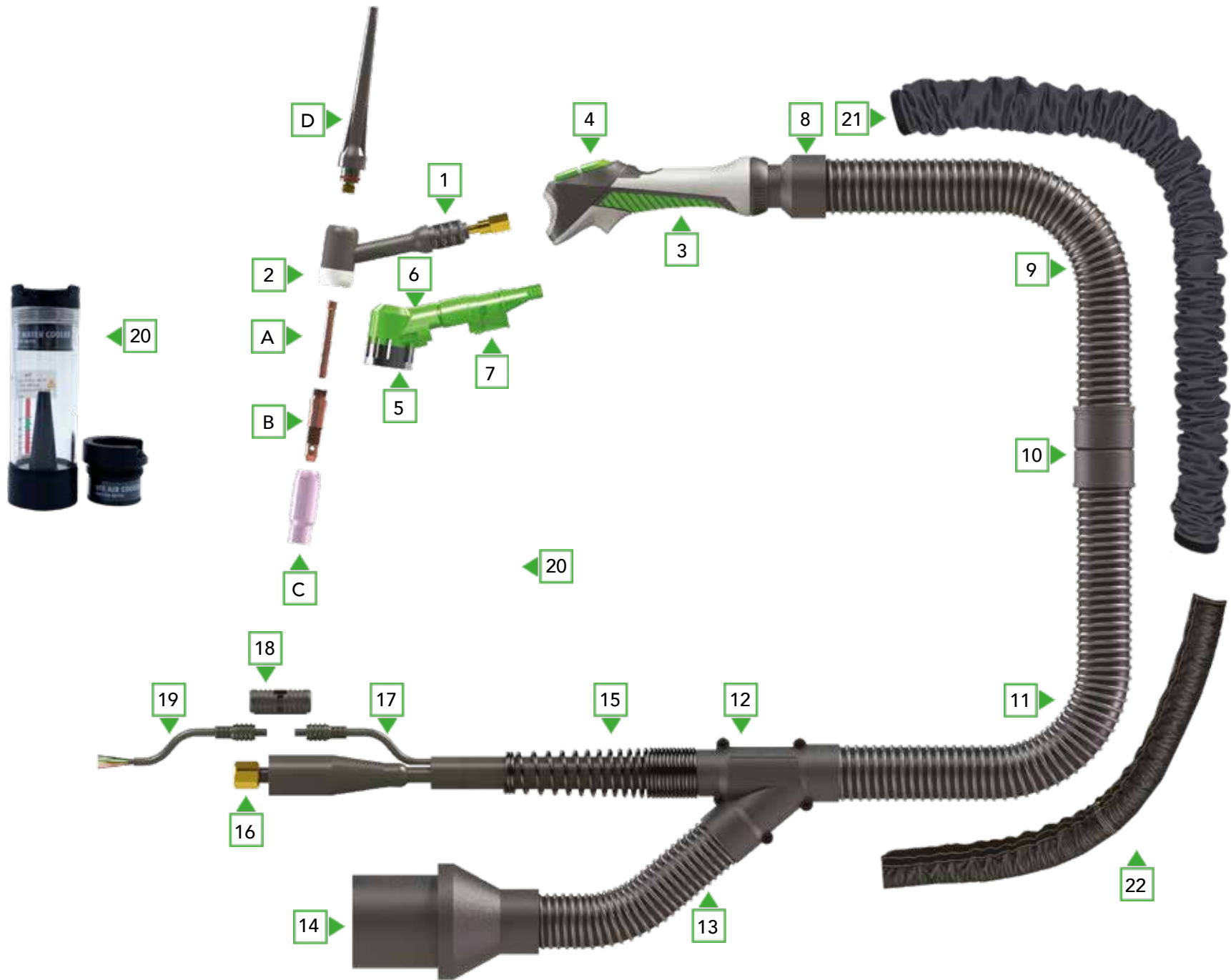

PART NO.	DESCRIPTION	PACK QTY
COMPLETE TORCHES		
8TE20010504350	8TE-17 Tig Extractor 13ft (4mtr) 10-25mm ² +1/4'G	1
8TE20010508350	8TE-17 Tig Extractor 26ft (8mtr) 10-25mm ² +1/4'G	1
8TE20010504370	8TE-17 Tig Extractor 13ft (4mtr) 35-50mm ² +1/4'G	1
8TE20010508370	8TE-17 Tig Extractor 26ft (8mtr) 35-50mm ² +1/4'G	1
8TE20010504340	8TE-17 Tig Extractor 13ft (4mtr) CA Fronius 35-50mm ²	1
8TE20010508340	8TE-17 Tig Extractor 26ft (8mtr) CA Fronius 35-50mm ²	1
8TE20010504000	8TE-17 Tig Extractor 13ft (4mtr) M12x1	1
8TE20010508000	8TE-17 Tig Extractor 26ft (8mtr) M12x1	1
8TE20010504210	8TE-17 Tig Extractor 13ft (4mtr) 1/4'G	1
8TE20010508210	8TE-17 Tig Extractor 26ft (8mtr) 1/4'G	1
8TE20010504220	8TE-17 Tig Extractor 13ft (4mtr) 3/8'G	1
8TE20010508220	8TE-17 Tig Extractor 26ft (8mtr) 3/8'G	1

Las antorchas 8TE vienen de serie con un módulo interruptor de un botón y lo cable de señal sin enchufe. Para otras opciones de interruptor y conectores consulte las páginas 40 y 41.

ITEM	PART NO.	DESCRIPTION	PACK QTY
CONSUMABLES			
A	500664	10N22 Collet 1.0mm	5
	006666	10N23 Collet 1.6mm	5
	500668	70062 Collet 2.0mm	5
	500670	10N24 Collet 2.4mm	5
	500674	10N25 Collet 3.2mm	5
	500676	54N20 Collet 4.0mm	5
B	500764	10N30 Collet body 1.0mm	5
	500766	10N31 Collet body 1.6mm	5
	500768	70064 Collet body 2.0mm	5
	500770	10N32 Collet body 2.4mm	5
	500774	10N28 Collet body 3.2mm	5
	500776	406488 Collet body 4.0mm	5
C	500520	10N50 Ceramic cup 6.4mm	10
	500522	10N49 Ceramic cup 7.9mm	10
	500524	10N48 Ceramic cup 9.5mm	10
	500526	10N47 Ceramic cup 11.1mm	10
	500530	10N46 Ceramic cup 12.7mm	10
	500530	10N45 Ceramic cup 16.0mm	10
	500532	10N44 Ceramic cup 19.0mm	10
D	500346	57Y02 Back cap long	5
	500347	300M Back cap medium	5



ITEM	PART NO.	DESCRIPTION	PACK QTY
SPARE PARTS			
1	520200	Gun body air cooled	1
2	500402	18CG Heat shield	5
3	8X9987	Handle green complete with 1-button switch	1
	580150	Inside handle stop (Not shown)	1
	580160	Inside hose stop (Not shown)	2
4	8X9518	Switch module green 1-button complete	1
		For other switch options we refer to page 41	
5	581010	Heat shield aluminium	1
6	5803502	Suction head	1
7	5801002	Torchbody adaptor	1
8	581050	Ball-and-socket joint	1
9	580400	Suction hose front 3ft (1mtr) black	1
	442352	Suction hose cover 3ft (1mtr) (not shown)	1
10	5810602	Connection part for 25mm hose (for 13ft/4mtr gun)	1
	5810622	Connection part for 30mm hose (for 26ft/8mtr gun)	1
11	340102	Suction hose 25mm black p/mtr (for 13ft/4mtr gun)	1mtr
	340505	Suction hose 30mm black p/mtr (for 26ft/8mtr gun)	1mtr
12	5802002	Y-Piece set	1
	5802202	Inside stop to block suction smoke (Not shown)	1
	580250	Adaptor to fit 30mm hose on Y-Piece (When torch is 8mtr)	1
13	340102	Suction hose 25mm black p/mtr	1mtr
14	581068	Adaptor Suction hose 25mm -> 56mm	1
	581069	Adaptor Suction hose 25mm -> 38mm	1
15	580215	Spring 27mm for Y-Piece	1
16		Power/Water cable On request as this is depending on machine connection	1
17	306550	Switch cable 13ft (4mtr) (QuickConnect)	1
	306552	Switch cable 26ft (8mtr) (QuickConnect)	1
18	306545	Locking clip (QuickConnect)	1
19	306559	Switch cable end without plug (QuickConnect)	1
20	585000	Airflow meter Extractor	1
21	442352	Hose Cover (Optional)	1
22	5820004	Leather cover for 13ft (4mtr) gun (optional)	1
23	260027	Leather cover for 26ft (8mtr) gun (optional)	1

For other Switch cable ends with plug, we refer to Page 41



8TE-30 TIG EXTRACTOR

DC - 320 AMP, AC/DC - 330 AMP, DUTY CYCLE - 100%



WATER COOLED

AIRE LIMPIO

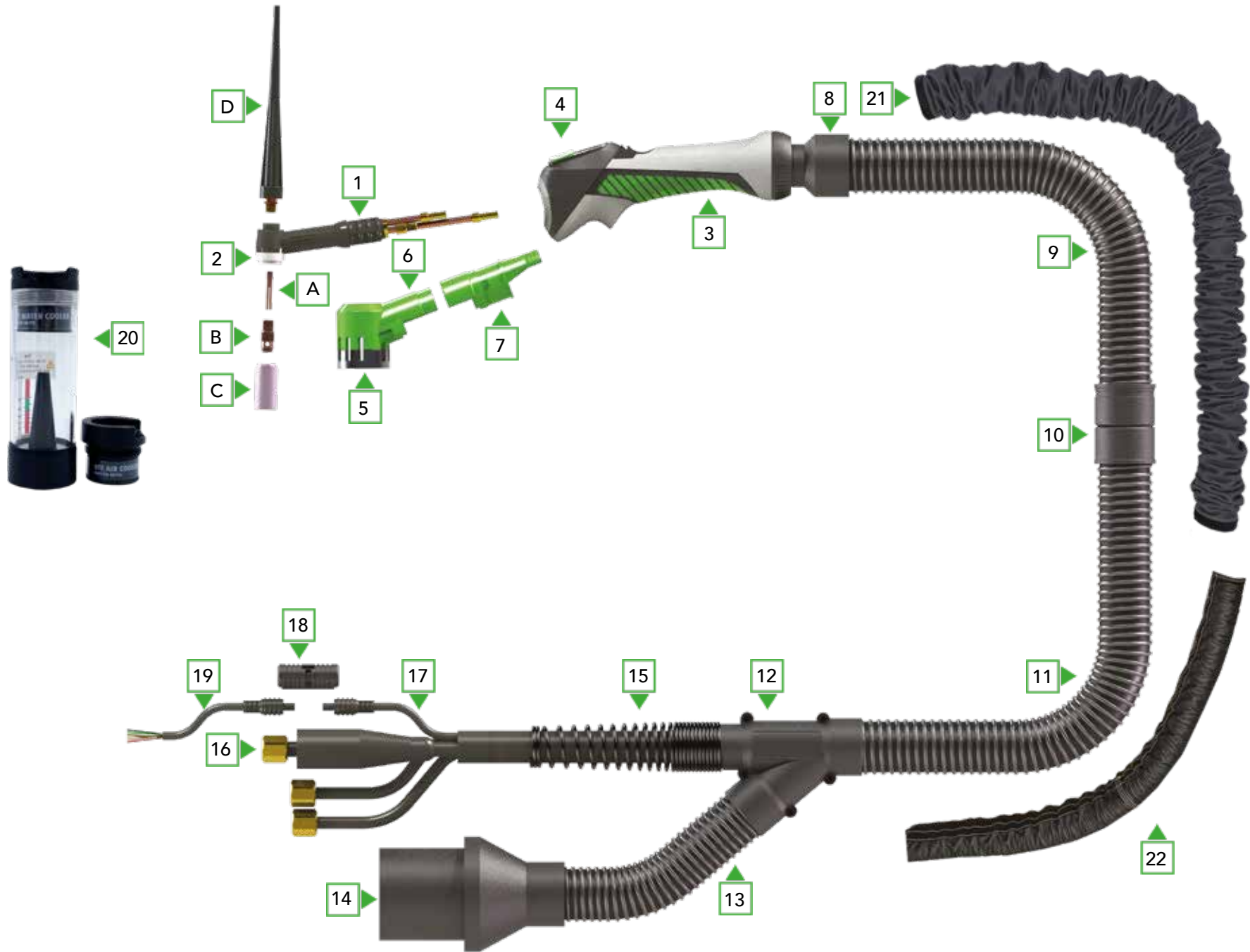

PART NO.	DESCRIPTION	PACK QTY
COMPLETE TORCHES		
8TE60014704650	8TE-30 Tig Extractor 13ft (4mtr) 35-50mm ² +tules+1/4'G	1
8TE60014708650	8TE-30 Tig Extractor 26ft (8mtr) 35-50mm ² +tules+1/4'G	1
8TE60014704990	8TE-30 Tig Extractor 13ft (4mtr) CA Fronius 35-50mm ² +tules	1
8TE60014708990	8TE-30 Tig Extractor 26ft (8mtr) CA Fronius 35-50mm ² +tules	1
8TE60014704600	8TE-30 Tig Extractor 13ft (4mtr) M12x1+3/8'G+1/4'G	1
8TE60014708600	8TE-30 Tig Extractor 26ft (8mtr) M12x1+3/8'G+1/4'G	1
8TE60014704800	8TE-30 Tig Extractor 13ft (4mtr) 3/8'G+3/8'G+1/4'G	1
8TE60014708800	8TE-30 Tig Extractor 26ft (8mtr) 3/8'G+3/8'G+1/4'GG	1

Las antorchas 8TE vienen de serie con un módulo interruptor de un botón y lo cable de signal sin enchufe. Para otras opciones de interruptor y conectores consulte las páginas 40 y 41.

ITEM	PART NO.	DESCRIPTION	PACK QTY
CONSUMABLES			
A	500650	13N20 Collet 0.5mm	5
	500652	13N21 Collet 1.0mm	5
	500654	13N22 Collet 1.6mm	5
	500656	70066 Collet 2.0mm	5
	500658	13N23 Collet 2.4mm (standard)	5
	500660	13N24 Collet 3.2mm	5
B	500750	13N25 Collet body 0.5mm	5
	500752	13N26 Collet body 1.0mm	5
	500754	13N27 Collet body 1.6mm	5
	500756	70067 Collet body 2.0mm	5
	500758	13N28 Collet body 2.4mm (standard)	5
	500760	13N29 Collet body 3.2mm	5
C	500500	13N08 Ceramic cup 6.4mm Gr. 4	10
	500502	13N09 Ceramic cup 7.9mm Gr. 5	10
	500504	13N10 Ceramic cup 9.5mm Gr. 6 (standard)	10
	500506	13N11 Ceramic cup 11.1mm Gr. 7	10
	500508	13N12 Ceramic cup 12.7mm Gr. 8	10
	500510	13N13 Ceramic cup 15.9mm Gr. 10	10
D	500344	41V35 Back cap medium	5
	500340	41V24 Back cap long (standard)	5



ITEM	PART NO.	DESCRIPTION	PACK QTY
SPARE PARTS			
1	520700	Gun body water cooled	1
2	500400	598882 Heat shield	5
3	8X9987	Handle green complete with 1-button switch	1
	580150	Inside handle stop (Not shown)	1
	580160	Inside hose stop (Not shown)	2
4	8X9518	Switch module green 1-button complete	1
		For other switch options we refer to page 41	
5	581000	Heat shield aluminium	1
6	5803002	Suction head	1
7	5801002	Torchbody adaptor	1
8	581050	Ball-and-socket joint	1
9	580400	Suction hose front 3ft (1mtr) black	1
	442352	Suction hose cover 3ft (1mtr) (not shown)	1
10	5810602	Connection part for 25mm hose (for 13ft/4mtr gun)	1
	5810622	Connection part for 30mm hose (for 26ft/8mtr gun)	1
11	340102	Suction hose 25mm black p/mtr (for 13ft/4mtr gun)	1mtr
	340505	Suction hose 30mm black p/mtr (for 26ft/8mtr gun)	1mtr
12	5802002	Y-Piece set	1
	5802202	Inside stop to block suction smoke (Not shown)	1
	580250	Adaptor to fit 30mm hose on Y-Piece (for 26ft/8mtr gun)	1
13	340102	Suction hose 25mm black p/mtr	1mtr
14	581068	Adaptor Suction hose 25mm -> 56mm	1
	581069	Adaptor Suction hose 25mm -> 38mm	1
15	580215	Spring 27mm for Y-Piece	1
16		Power/Water cable On request as this is depending on machine connection	1
17	306550	Switch cable 13ft (4mtr) (QuickConnect)	1
	306552	Switch cable 26ft (8mtr) (QuickConnect)	1
18	306545	Locking clip (QuickConnect)	1
19	306559	Switch cable end without plug (QuickConnect)	1
20	585000	Airflow meter Extractor	1
21	442352	Hose Cover (Optional)	1
22	5820004	Leather cover for 13ft (4mtr) gun (optional)	1
23	260027	Leather cover for 26ft (8mtr) gun (optional)	1

For other Switch cable ends with plug, we refer to Page 41

8TE-35 TIG EXTRACTOR

DC - 320 AMP, AC/DC - 330 AMP, DUTY CYCLE - 100%



WATER COOLED

AIRE LIMPIO

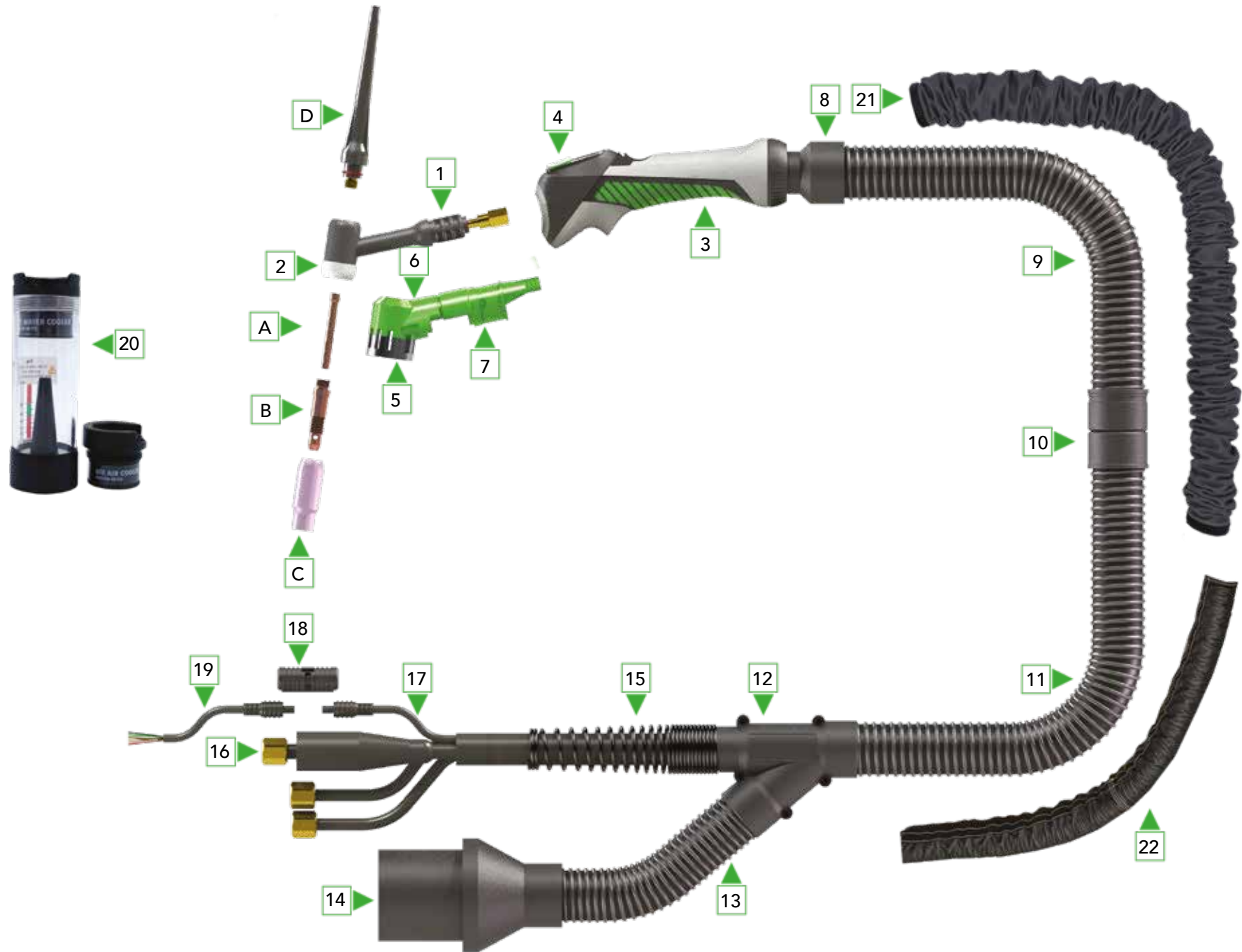

PART NO.	DESCRIPTION	PACK QTY
COMPLETE TORCHES		
8TE65014704650	8TE-35 Tig Extractor 13ft (4mtr) 35-50mm ² +tules+1/4'G	1
8TE65014708650	8TE-35 Tig Extractor 26ft (8mtr) 35-50mm ² +tules+1/4'G	1
8TE65014704990	8TE-35 Tig Extractor 13ft (4mtr) CA Fronius 35-50mm ² +tules	1
8TE65014708990	8TE-35 Tig Extractor 26ft (8mtr) CA Fronius 35-50mm ² +tules	1
8TE65014704600	8TE-35 Tig Extractor 13ft (4mtr) M12x1+3/8'G+1/4'G	1
8TE65014708600	8TE-35 Tig Extractor 26ft (8mtr) M12x1+3/8'G+1/4'G	1
8TE65014704800	8TE-35 Tig Extractor 13ft (4mtr) 3/8'G+3/8'G+1/4'G	1
8TE65014708800	8TE-35 Tig Extractor 26ft (8mtr) 3/8'G+3/8'G+1/4'GG	1

Las antorchas 8TE vienen de serie con un módulo interruptor de un botón y lo cable de signal sin enchufe. Para otras opciones de interruptor y conectores consulte las páginas 40 y 41.

ITEM	PART NO.	DESCRIPTION	PACK QTY
CONSUMABLES			
A	500664	10N22 Collet 1.0mm	5
	006666	10N23 Collet 1.6mm	5
	500668	70062 Collet 2.0mm	5
	500670	10N24 Collet 2.4mm	5
	500674	10N25 Collet 3.2mm	5
	500676	54N20 Collet 4.0mm	5
B	500764	10N30 Collet body 1.0mm	5
	500766	10N31 Collet body 1.6mm	5
	500768	70064 Collet body 2.0mm	5
	500770	10N32 Collet body 2.4mm	5
	500774	10N28 Collet body 3.2mm	5
	500776	406488 Collet body 4.0mm	5
C	500520	10N50 Ceramic cup 6.4mm	10
	500522	10N49 Ceramic cup 7.9mm	10
	500524	10N48 Ceramic cup 9.5mm	10
	500526	10N47 Ceramic cup 11.1mm	10
	500530	10N46 Ceramic cup 12.7mm	10
	500530	10N45 Ceramic cup 16.0mm	10
	500532	10N44 Ceramic cup 19.0mm	10
D	500346	57Y02 Back cap long	5
	500347	300M Back cap medium	5



ITEM	PART NO.	DESCRIPTION	PACK QTY
SPARE PARTS			
1	520701	Torch body water cooled	1
2	500402	18CG Heat shield	5
3	8X9987	Handle green complete with 1-button switch	1
	580150	Inside handle stop (Not shown)	1
	580160	Inside hose stop (Not shown)	2
4	8X9518	Switch module green 1-button complete	1
		For other switch options we refer to page 41	
5	581000	Heat shield aluminium	1
6	5804102	Suction head	1
7	5801002	Torchbody adaptor	1
8	581050	Ball-and-socket joint	1
9	580400	Suction hose front 1mtr black	1
	442352	Suction hose cover 1mtr (Not shown)	1
10	5810602	Connection part for 25mm hose (When torch is 4mtr)	1
	5810622	Connection part for 30mm hose (When torch is 8mtr)	1
11	340102	Suction hose 25mm black p/mtr (When torch is 4mtr)	1mtr
	340505	Suction hose 30mm black p/mtr (When torch is 8mtr)	1mtr
12	5802002	Y-Piece set	1
	5802202	Inside stop to block suction smoke (Not shown)	1
	580250	Adaptor to fit 30mm hose on Y-Piece (When torch is 8mtr)	1
13	340102	Suction hose 25mm black p/mtr	1mtr
14	581068	Adaptor Suction hose 25mm -> 56mm	1
	581069	Adaptor Suction hose 25mm -> 38mm	1
15	580215	Spring 27mm for Y-Piece	1
16		Power/Water cable On request as this is depending on machine connection	1
17	306550	Switch cable 4mtr (QuickConnect)	1
	306552	Switch cable 8mtr (QuickConnect)	1
18	306545	Locking clip (QuickConnect)	1
19	306559	Switch cable end without plug (QuickConnect)	1
20	585000	Airflow meter Extractor	1
21	442352	Hose Cover (Optional)	1
22	5820004	Leather Cover for 4mtr torch (optional)	1
23	260027	Leather Cover for 8mtr torch (optional)	1

For other Switch cable ends with plug, we refer to Page 41



8TE TIG EXTRACTOR



CONECTORES DEL CABLE DEL INTERRUPTOR



FICHA DE CONFIGURACIÓN

En esta ficha de configuración puede seleccionar fácilmente el conector aplicable a diferentes tipos de máquinas de soldar. También puede seleccionar los tipos de interruptores,

ARTÍCULO	NÚM. PIEZA	MARCA DE EQUIPO	TIPO DE CONECTOR	REF. POR GAS	REF. POR AGUA	UN BOTÓN	DOS BOTONES	TRES BOTONES	CUATRO BOTONES	UN BOTÓN +POTENC.
1	507541	Cebora	10-pins Cebora	<input checked="" type="checkbox"/>	<input checked="" type="checkbox"/>	<input checked="" type="checkbox"/>		<input checked="" type="checkbox"/>		<input checked="" type="checkbox"/>
	507549	Cebora	10-pins Cebora	<input checked="" type="checkbox"/>	<input checked="" type="checkbox"/>	<input checked="" type="checkbox"/>				<input checked="" type="checkbox"/>
2	507450	Esab	2-pins Amphenol	<input checked="" type="checkbox"/>	<input checked="" type="checkbox"/>	<input checked="" type="checkbox"/>				
	5004623	EWM	5-pins Tüchel	<input checked="" type="checkbox"/>	<input checked="" type="checkbox"/>	<input checked="" type="checkbox"/>	<input checked="" type="checkbox"/>			
4	507714	EWM	8-pins UTG	<input checked="" type="checkbox"/>	<input checked="" type="checkbox"/>	<input checked="" type="checkbox"/>	<input checked="" type="checkbox"/>	<input checked="" type="checkbox"/>	<input checked="" type="checkbox"/>	<input checked="" type="checkbox"/>
	507552	Jäckle	5-pins Tüchel	<input checked="" type="checkbox"/>	<input checked="" type="checkbox"/>	<input checked="" type="checkbox"/>	<input checked="" type="checkbox"/>			
3	507550	Jäckle	5-pins Tüchel	<input checked="" type="checkbox"/>	<input checked="" type="checkbox"/>	<input checked="" type="checkbox"/>		<input checked="" type="checkbox"/>	<input checked="" type="checkbox"/>	
	507561	Jäckle	7-pins Tüchel	<input checked="" type="checkbox"/>	<input checked="" type="checkbox"/>					<input checked="" type="checkbox"/>
6	50048227	Fronius	9-pins Fronius	<input checked="" type="checkbox"/>	<input checked="" type="checkbox"/>	<input checked="" type="checkbox"/>	<input checked="" type="checkbox"/>	<input checked="" type="checkbox"/>		
	50048247	Fronius	9-pins Fronius	<input checked="" type="checkbox"/>	<input checked="" type="checkbox"/>				<input checked="" type="checkbox"/>	
7	507435	Kemppi	4-pins Amphenol	<input checked="" type="checkbox"/>	<input checked="" type="checkbox"/>	<input checked="" type="checkbox"/>				
	5075371	Kemppi	7-pins Amphenol MLS	<input checked="" type="checkbox"/>		<input checked="" type="checkbox"/>		<input checked="" type="checkbox"/>		
8	5075372	Kemppi	7-pins Amphenol MLS		<input checked="" type="checkbox"/>	<input checked="" type="checkbox"/>		<input checked="" type="checkbox"/>		
	5075373	Kemppi	7-pins Amphenol MLS	<input checked="" type="checkbox"/>						<input checked="" type="checkbox"/>
	5075374	Kemppi	7-pins Amphenol MLS		<input checked="" type="checkbox"/>					<input checked="" type="checkbox"/>
	507611	Migatronic	7-pins Amphenol	<input checked="" type="checkbox"/>		<input checked="" type="checkbox"/>				<input checked="" type="checkbox"/>
9	507621	Migatronic	7-pins Amphenol		<input checked="" type="checkbox"/>	<input checked="" type="checkbox"/>				<input checked="" type="checkbox"/>
	507612	Rehm	7-pins Amphenol	<input checked="" type="checkbox"/>		<input checked="" type="checkbox"/>	<input checked="" type="checkbox"/>	<input checked="" type="checkbox"/>		
9	507613	Rehm	7-pins Amphenol		<input checked="" type="checkbox"/>	<input checked="" type="checkbox"/>	<input checked="" type="checkbox"/>			
	507615	Rehm	7-pins Amphenol	<input checked="" type="checkbox"/>	<input checked="" type="checkbox"/>					<input checked="" type="checkbox"/>



8TE TIG EXTRACTOR

TIG EXTRACTOR

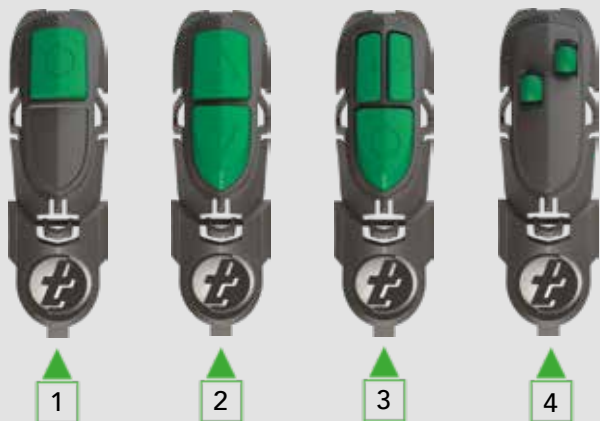

OPCIONES DE MÓDULOS DE INTERRUPTORES

ITEM	PART NO.	DESCRIPTION	PACK QTY
1	8X9518	Módulo de 1 botón	1
2	8X9528	Módulo de 2 botones	1
3	8X9538	Módulo de 3 botones	1
4	8X9558	Módulo de 4 botones	1



CONSUMIBLES TIG

Todas los consumibles están disponibles en stock y son intercambiables con los consumibles TIG estándar.



CONEXIONES

Suministramos casi todos los terminales de conexión de cable de corriente .



TOBERAS CERÁMICAS

Disponible gama completa de toberas de cerámica.



EXTRACCIÓN



TRANSLAS  WWW.TRAI

 CLEAR

 CLEAR

START STOP RESET/LOCK

TRANSLAS 
DUTCH WELDING TECHNOLOGY

CLEARO2 



UNIDADES HI-VAC

EXTRACCIÓN

SIN SALIDA DE HUMOS, SOLO AIRE LIMPIO





UNIDADES HI-VAC

EXTRACCIÓN DE HUMOS INTEGRADA



**CLEARO2
UNIDADES**



**DISEÑADAS PARA LAS ANTORCHAS
EXTRACTORAS 8XE MIG, 8XC COBOT
Y 8TE TIG DE TRANSLAS**

Potentes, Flexibles y Móviles.

Las unidades de extracción portátiles ClearO2 de Translas fueron especialmente diseñados para trabajar con las antorchas 8XE Extractores MIG, 8XR Cobot y 8TE TIG para ofrecer lo mejores resultados: hasta un 98 % de extracción de humos de soldadura directamente en la fuente. Las unidades de extracción son portátiles y lista para utilizar, diseñados para la máxima comodidad para el soldador durante el trabajo.



AIRE LIMPIO



LIMPIEZA AUTOMÁTICA DEL FILTRO

La serie ClearO2 tiene una función de limpieza automática mediante inversión de presión por aire comprimido. En el momento en que la presión en el filtro es demasiado alto el equipo comienza a limpiar los filtros automáticamente. Se puede realizar una función de limpieza manual pulsando un solo botón. Con una gran área de filtrado, las unidades ClearO2 alto vacio son las unidades más eficientes de su tamaño



POTENTE FILTRACIÓN

Con la combinación de un extractor 8XE MIG, 8XC Cobot, 8TE TIG y una unidad ClearO2, los humos capturados se filtran con una eficiencia superior al 99,8 % según la IFA. Esta potente solución es adecuada para entornos de soldadura de alta producción.



GRAN ÁREA DE FILTRADO

Es una de las unidades más eficientes de su clase gracias a su área de filtrado de 5m².



UNIDADES HI-VAC

EXTRACCIÓN DE HUMOS INTEGRADA



CLEAR02
UNIDADES



SISTEMA DE MOTOR EFICIENTE

El motor eléctrico del equipo está diseñado para trabajar continuamente. Debido a la función de limpieza automática y a sistema de motor simplificado, el mantenimiento de las unidades es mínimo, haciéndolos duraderos y ahorrando tiempo.

La función de arranque/parada automática fue diseñada para preservar la energía y sincronizar las unidades con las antorchas Translas extractor .

Hay dos opciones de arranque/parada: una pinza que detecta la señal en el cable de tierra del equipo de soldadura y un soporte de antorcha que en el momento en que la antorcha está fuera del soporte el equipo se pone en marcha automáticamente . Para ambas opciones, después de terminar la soldadura el equipo deja de funcionar después de unos 20 segundos.

LIGERAS Y
MÓVILES

IFA
99.8%

SOLO GENERAN
65dB



OPCIONES DE INICIO/PARADA AUTOMÁTICAS

Estas opciones están diseñadas para funcionar exclusivamente con las antorchas extractoras 8XE MIG, 8XC Cobot y 8TE TIG con la función de inicio/parada automáticos de la abrazadera.

- ✓ DISEÑADAS PARA LAS ANTORCHAS EXTRACTORAS 8XE MIG, 8XC COBOT Y 8TE TIG
- ✓ MÓVILES, CON RUEDAS O CANCAMOS DE IZAJE
- ✓ EQUIPOS PARA 1 Y 2 SOLDADORES
- ✓ ADECUADAS PARA SU USO EN ENTORNOS DE ALTA PRODUCCIÓN
- ✓ EFICIENTE Y SILENCIOSO (MENOS DE 65DB)

EXTRACCIÓN





MIG CLEARO2 UNIDADES

EXTRACCIÓN DE HUMOS INTEGRADA



CLEARO2
UNIDADES



**W
100** EQUIPO
CLEARO2



**W
200** EQUIPO
CLEARO2

MIG HI-VAC UNIDADES

MIG HI-VAC UNIDADES

EXTRACCIÓN



MIG CLEARO2 W100/150

EXTRACCIÓN DE HUMOS INTEGRADA

PARA UN SOLDADOR



CLEARO2
UNIDADES

AIRE LIMPIO



Dimensiones	(Largo x ancho x alto) 29" x 16" x 22"/26" (700 x 440 x 585 / 630mm)
Despliegue	Móvil sobre 4 ruedas. Dos de ellas giratorias con bloqueo
Alimentación	220-240V (W100) 575V-600V (W110) 380-480V (W150)
Potencia del motor	1.5 KW/2 HP (16 Amps)
Flujo de aspiración	Máx 106 CFM (soplado directo)
Flujo de aspiración eficaz	Máx 38 CFM (Translas Extractors)
Presión de trabajo	Máx. 36,000 Pa (control eléctrico) static pressure
Superficie de filtrado	Superficie de filtrado activa de 54 sqft, eficiencia del filtrado: IFA > 99.8%
Temperatura operacional	0 to +50°C
CC máx	DC: 100%
Entrada	2" - 51 mm
Peso	99 lbs - Ca. 45 kg
Nivel de ruido	Máx. dB(A) <65Db(A) (con un flujo de aspiración del 100 %)
Método de filtrado	Filtro desechable
Certificaciones	CE, W3, and CSA

N.º DE SERIE	DESCRIPCIÓN	CANT. DEL PAQUETE
CLEARO2 W100		
3746100100000	Equipo ClearO2 W100 220-240V 50-60Hz 1.5 kW	1
3746110100000	Equipo ClearO2 W110 575-600V 50-60Hz 1.5 kW	1
3746150100000	Equipo ClearO2 W150 380-480V 50-60Hz 1.5 kW	1

Nota: Aire comprimido - Las unidades ClearO2 deben estar conectadas en todo momento a aire comprimido limpio y seco regulado (80 PSI) para la autolimpieza utilizando una línea de aire estándar. Hay un consumo de aire de 21 cfm para cada pulso.



MIG CLEARO2 W200

EXTRACCIÓN DE HUMOS INTEGRADA

PARA DOS SOLDADORES



CLEARO2
UNIDADES



Dimensiones	(Largo x ancho x alto) 32" x 21" x 27"/31" (700 x 530 x 560 / 630mm)
Despliegue	Móvil sobre 4 ruedas. Dos de ellas giratorias con bloqueo
Alimentación	380-480V (W200) 575V-600V (W210)
Potencia del motor	Máx 4 HP (16 Amps)
Flujo de aspiración	Máx . 147 CFM (soplado directo)
Flujo de aspiración eficaz	Máx 38 CFM (Translas Extractors)
Presión de trabajo	Máx. 45000 Pa (control eléctrico)
Superficie de filtrado	Superficie de filtrado activa de 54 sqft, eficiencia del filtrado: IFA > 99.8%
Temperatura operacional	0 to +50°C
CC máx	100% (VFD)
Entrada	2 x 2" - 51 mm
Peso	128 lbs - Ca. 58 kg
Nivel de ruido	Máx . dB(A) <65dB(A) (con un flujo de aspiración del 100 %)
Método de filtrado	Filtro desechable
Certificaciones	CE, W3, and CSA

EXTRACCIÓN

N.º DE SERIE	DESCRIPCIÓN	CANT. DEL PAQUETE
CLEARO2 W200		
3746200100000	Equipo ClearO2 W200 380-480V 50-60Hz 3 kW	1
3746210100000	Equipo ClearO2W210 575-600V 50-60Hz 3 kW	1
3746220100000	Equipo ClearO2 W220 575-600V 50-60Hz 4 kW	1
3746230100000	Equipo ClearO2 W230 380-480V 50-60Hz 4 kW	1

Nota: Aire comprimido - Las unidades ClearO2 deben estar conectadas en todo momento a aire comprimido limpio y seco regulado (80 PSI) para la autolimpieza utilizando una línea de aire estándar. Hay un consumo de aire de 21 cfm para cada pulso.





EXTRACCIÓN DE HUMOS INTEGRADA

PARA DOS SOLDADORES



CLEAR2
UNIDADES

MIG HI-VAC UNIDADES



T
100 EQUIPO
CLEARO2

MIG HI-VAC UNIDADES



T
200 EQUIPO
CLEARO2

EXTRACCIÓN



TIG CLEARO2 T100

EXTRACCIÓN DE HUMOS INTEGRADA

PARA UN SOLDADOR



CLEARO2
UNIDADES

AIRE LIMPIO



Dimensiones	(Largo x ancho x alto) 20" x 12" x 15" (620 x 380 x 465mm)
Alimentación	230V/50Hz
Potencia del motor	1.2 KW
Flujo de aspiración	Máx 125m3/h
Flujo de aspiración eficaz	Máx 38 CFM (Translas Extractors)
Presión de trabajo	Máx 30,000Pa
Superficie de filtrado	Superficie de filtrado activa de 26 sqft, - 2,5m2
Eficiencia del filtrado	IFA > 99.8%
Entrada	2" (Opcional 1.7") - 51mm (opcional 44mm)
Peso	66 lbs - Ca. 30 kg
Nivel de ruido	Máx. dB(A) <65Db(A) (con un flujo de aspiración del 100 %)
Método de filtrado	Filtro desechable
Certificaciones	CSA, CE

W3 está en construcción.

Opción: Cable de arranque/parada

N.º DE SERIE	DESCRIPCIÓN	CANT. DEL PAQUETE
ClearO2 T100		
3756100130000	Equipo ClearO2 T100 230V 50Hz 1.2kW	1



TIG CLEARO2 T200

EXTRACCIÓN DE HUMOS INTEGRADA

PARA DOS SOLDADORES



**CLEARO2
UNIDADES**



Dimensiones	(Largo x ancho x alto) 29" x 16" x 22"/26" - 700 x 440 x 585/630mm
Despliegue	Móvil sobre 4 ruedas. Dos de ellas giratorias con bloqueo
Alimentación	220-240V (W100) 575V-600V (W110) 380-480V (W150)
Potencia del motor	1.5 KW/2 HP (16 Amps)
Flujo de aspiración	Máx 106 CFM (soplado directo)
Flujo de aspiración eficaz	Máx 38 CFM (Translas Extractors)
Presión de trabajo	Máx. 36,000 Pa (control eléctrico) static pressure
Superficie de filtrado	Superficie de filtrado activa de 54 sqft, eficiencia del filtrado: IFA > 99.8%
Temperatura operacional	0 to +50°C
CC máx	DC: 100%
Entrada	2" - 51 mm
Peso	99 lbs - Ca. 45 kg
Nivel de ruido	Máx. dB(A) <65Db(A) (con un flujo de aspiración del 100 %)
Método de filtrado	Filtro desechable
Certificaciones	CE, W3, and CSA

EXTRACCIÓN

N.º DE SERIE	DESCRIPCIÓN	CANT. DEL PAQUETE
CLEARO2 T200		
3756200100000	Equipo ClearO2 W200 220-240V 50-60Hz 1.5kW	1

Nota: Aire comprimido - Las unidades ClearO2 deben estar conectadas en todo momento a aire comprimido limpio y seco regulado (80 PSI) para la autolimpieza utilizando una línea de aire estándar. Hay un consumo de aire de 21 cfm para cada pulso.



PIEZAS DE RECAMBIO PARA HI-VAC UNIDADES EXTRACCIÓN DE HUMOS INTEGRADA

AIRE LIMPIO



N.º DE SERIE	DESCRIPCIÓN	CANT. DEL PAQUETE
374012	Gun holder ø40mm for automatic start/stop 16ft (5mtr) ClearO2	1
374013	Gun holder ø40mm for automatic start/stop 33ft (10mtr) ClearO2	1
374014	Gun holder ø50mm for automatic start/stop 16ft (5mtr) ClearO2	1
374015	Gun holder ø50mm for automatic start/stop 33ft (10mtr) ClearO2	1

N.º DE SERIE	DESCRIPCIÓN	CANT. DEL PAQUETE
374010	Sensing cable auto start / stop 13ft (4mtr) W-serie	1

N.º DE SERIE	DESCRIPCIÓN	CANT. DEL PAQUETE
3740103	Extension cable auto start / stop incl. 5-p plug W-serie 10ft (3mtr)	1
3740105	Extension cable auto start / stop incl. 5-p plug W-serie 16ft (5mtr)	1
3740110	Extension cable auto start / stop incl. 5-p plug W-serie 33ft (10mtr)	1

N.º DE SERIE	DESCRIPCIÓN	CANT. DEL PAQUETE
37422505	ClearO2 suction hose green ø2" 16ft (5mtr)	1

N.º DE SERIE	DESCRIPCIÓN	CANT. DEL PAQUETE
374099	Ball valve to reduce the suction flow	1

N.º DE SERIE	DESCRIPCIÓN	CANT. DEL PAQUETE
374106	Pressure reducing value 5 - 15 bar 1/4"-NP7.2 (80 PSI)	1



PIEZAS DE RECAMBIO PARA HI-VAC UNIDADES EXTRACCIÓN DE HUMOS INTEGRADA

CLEARO2
UNIDADES



N.º DE SERIE	DESCRIPCIÓN	CANT. DEL PAQUETE
374020	Filter - 64 Sq Ft (5m2)	1



N.º DE SERIE	DESCRIPCIÓN	CANT. DEL PAQUETE
374025	Filtermat W-series ClearO2 (set/5pc)	1



N.º DE SERIE	DESCRIPCIÓN	CANT. DEL PAQUETE
398110	Coupler for suction hose ø2" side 8XE	1



N.º DE SERIE	DESCRIPCIÓN	CANT. DEL PAQUETE
374130	Coupler to extend the suction hose ø2"	1



N.º DE SERIE	DESCRIPCIÓN	CANT. DEL PAQUETE
374017	Extraction hood small with magnet base for ClearO2	1



N.º DE SERIE	DESCRIPCIÓN	CANT. DEL PAQUETE
374149	Y-Branch Adapter for T200	1

EXTRACCIÓN

cepedas

M É X I C O S.A de C.V

www.cepedasparts.com



(55) 10558305



CEPEDAS MEXICO
OTAVALO 91-1, Linda Vista, CDMX



ventas@cepedasparts.com



WWW.TRANSLAS.COM