

Bending Fatigue Strength Improvement of Carburized Aerospace Gears

A. M. Freborg, B. L. Ferguson, Z. Li
Deformation Control Technology, Inc., Cleveland, Ohio

D. X. Schwam
Case Western Reserve University, Cleveland, Ohio

Abstract

It is well established that carburization of low alloy steels promotes compressive residual surface stress upon quenching, and that compressive surface stresses enhance fatigue life. In an effort to build upon these established facts, a US Army sponsored project is in-progress to improve helicopter gear fatigue life through innovative quenching and the achievement of deeper compressive surface stress. The Army has established a goal to improve the power density and life of helicopter transmissions. Using Pyrowear[®] 53 alloy steel, notched test bars and full test gears have been heat treated by carburizing, quenching, deep freezing and tempering. The quench methods examined were conventional oil quenching and intensive quenching. Bending fatigue results for these pieces are discussed in conjunction with heat treatment simulation predictions and x-ray analysis of combined heat treatment residual and gear loading stresses.

Introduction

The steel alloy Pyrowear[®] 53 is being increasingly used in helicopter transmission gear applications for the US Army, based primarily on its resistance to tempering at high temperatures and excellent fatigue strength. These attributes are critical in attack helicopter applications, where the transmission assembly is required to function under severe conditions wherein loss of gear lubrication can occur. The assembly must be able to operate without breakdown for a 30 minute time period in the absence of internal lubrication or cooling, and thus the need for a highly temper resistant alloy.

Pyrowear[®] 53 has a unique alloy content, as indicated in the alloy chemistry data presented in Table 1.

Table 1: Pyrowear[®] Alloy 53 – Base Composition

C	Mn	Si	Cr	Ni	Mo	Cu	V
0.10	0.35	1.00	1.00	2.00	3.25	2.00	0.10

The alloy content for this material is specifically designed to achieve resistance to softening at high temperatures and retain hot hardness in the carburized case, while maintaining high core impact strength and fracture toughness.

A variety of innovative processing techniques continue to be advanced to enhance material performance through manufacturing, processing and finishing. For applications where part life is limited by fatigue, significant life enhancement can be realized by introducing compressive stresses in the part surface, and by eliminating stress concentration factors.

Of primary interest in this project was the investigation and application of a novel heat treatment process called Intensive Quenching[®] to facilitate enhanced residual surface compressive stresses, with consequent material fatigue life improvement. [1,2,3] Developed by Dr. Nikolai Kobasko, the Intensive Quenching (IQ) process is an alternative way of quenching steel parts to achieve deep residual compression in part surfaces. The technology is based in-part on the achievement of a large thermal gradient in the part by rapid surface cooling. In non-carburized parts, the process has been shown to provide an extremely rapid and uniform transformation to martensite in the part surface layers while the core remains austenitic. This condition creates a very hard shell on the part that is under a state of compression. As the hot austenitic core cools and thermally contracts, the level of surface compression is deepened significantly. When the core subsequently transforms from austenite and expands, there is some reduction in the level of surface compression, but the final level of surface compression in the IQ treated component remains much higher than that of a conventionally quenched component.[4,5,6,7]

For this program, the premise for adapting this technology to carburized Pyrowear 53 was explored, with goal of achieving comparable or improved surface compression enhancement as witnessed in non-carburized material. While carburization is designed to achieve surface compression in quenched parts by delaying formation of surface martensite, the potential for

intensive quenching to foster additional enhancement was a key factor of this investigation.

Material Characterization for Heat Treatment Analysis

Proper mechanical and kinetics material property data are critical to the accurate application of any simulation technology to process modeling. For heat treat simulation, the required mechanical characterization includes material stress-strain behavior by phase over the range of strain rates and temperatures encountered during a given heat treat process. Linkage with corresponding phase transformation models then provides the general capability for the overall material model. The heat treatment simulation software DANTE[®] links both the mechanical behavior model and the phase transformation kinetics models to accurately predict the material response to heat treatment, specifically with respect to metallurgical phase volume fraction, residual stress, and distortion.[8,9,10]

In defining material behavior, DANTE's material model incorporates both rate dependent and independent yielding, kinematic and isotropic hardening, and recovery – all as functions of temperature and metallurgical phase. Isothermal, strain rate controlled tension and compression tests were run to characterize the stress-strain behavior of Pyrowear 53 as a function of temperature and carbon level. From these stress-strain data, the mechanical parameters for DANTE's mechanical model were determined and entered into the steel database.

The function of the kinetics model is to define the phase transformation behavior of the given steel within the heating and cooling temperatures and rates of the process. For the DANTE software, a complex set of differential equations is used to describe the phase transformation behavior for both diffusive (i.e. austenite formation or austenite decomposition to ferrite, pearlite, or bainite), and non-diffusive (i.e. austenite decomposing to martensite) transformation processes. This set of equations is then coupled with the equations governing the mechanical and thermal behavior of the material being subjected to the process scenario under consideration. Mechanical property data for the carburized Pyrowear 53 material were obtained by tensile and compression tests conducted at a variety of strain rates and temperatures, for varying carbon levels. [11]

Phase transformation data for the kinetics models are obtained principally by dilatometry. For the Pyrowear material, samples were through-carburized to four carbon levels (0.1, 0.3, 0.5 and 0.8 percent by weight), and then provided to Oak Ridge National Laboratory for testing using their high speed quenching dilatometer.

Steel phase transformation kinetics are most commonly presented in the form of isothermal Time-Temperature-Transformation (TTT) or Continuous Cooling Transformation (CCT) diagrams. For the subject Pyrowear steel, Carpenter Technology Corporation was able to provide a simple TTT diagram and critical temperatures. From this figure, several

important heat treating characteristics of Pyrowear 53 were evident. The supplied data indicated that the steel is highly resistant to diffusive phase transformation, with the ferrite/pearlite nose occurring at 704° C (1300° F) after quickly cooling from the austenite range and holding for 15 minutes. This helps to explain the high hardenability of this steel. The specified core martensite start temperature is 510° C (950° F), and the associated carburized case martensite start temperature is 130° C (265°F).[1,2] Consequently, phase transformation kinetics characterization for simulation focused primarily on the austenite-to-martensite transformation. The material kinetics parameters were implemented into the DANTE steel database after determination by mathematical fitting of dilatometric data. The dilatometer samples consisted of a series of through-carburized rhin walled tubes that were evaluated on ORNL's quenching dilatometer.[11]

Sound material data, linking mechanics with phase transformation predictive capability, is essential for accurate implementation of simulation technology to process modeling. The robust design of the DANTE material constitutive model, coupled with the detailed Pyrowear 53 material characterization data, provided a solid foundation for the process simulation work required in this project.

Objectives and Program Outline

The primary objective of the Phase I effort was to demonstrate the potential for improving the bending fatigue strength of Pyrowear 53 steel used for helicopter transmission gears by heat treatment. The Army's Rotorcraft Force Modernization Fleet requires a substantial increase in main gearbox power density, with minimal impact on the gearbox interface.

In lieu of redesigning gears and increasing gearbox size and transmission weight, the program focused on achieving the higher power density requirement through application of an innovative heat treating process. To achieve this objective and demonstrate technical, engineering and commercial feasibility for the innovation, an evaluation program consisting of a combination of process simulation and physical experiments was defined. The principal goal was to establish two independent material populations based solely on differences in heat treatment, with simulation, physical testing and bending fatigue evaluation used to characterize improvement, based principally on the effect of enhanced residual surface compressive stresses. The program is outlined as follows:

- Define Heat Treatments to be Examined (Isolation of Heat Treating Effects with Respect to Residual Stress)
- Establish Testing Program for Feasibility Assessment
- Predictive Materials Engineering – Simulate Heat Treatments
- Processing and Testing of Simple Coupons
- Evaluate Results
- Assess Process Sensitivity & Enhance Process Control
- Evaluation and testing of Refined Process
- Implement Analysis and Physical Testing in Full Gear Components

Analysis and Testing Program

Phase I – Feasibility Assessment

To demonstrate the potential for improving the bending fatigue strength of Pyrowear 53 steel for helicopter transmission gears by heat treatment, twenty-five kg (55 lbs.) of 60.3 mm (2 3/8”) diameter Pyrowear 53 bar stock was donated from DCT’s inventory. A general processing and testing program for the material was then established, as summarized in Table 2.

Table 2: Test Matrix for Phase I Feasibility Assessment

Process Route	Heat Treat	Surface	Bending Fatigue Samples	Metallurgical Testing
1	Oil Quench	Milled and Superfinish Polished	18	Microstructure, Microhardness, X-ray
2	Intensive Quench	Milled and Superfinish Polished	18	Microstructure, Microhardness, X-ray

Sample Processing and Preparation

Rectangular test bar blanks were machined from the bar stock with the length of the test bar being coincident with the bar stock rolling direction. In discussion with gear engineering experts at the Army Gear Research Laboratory at NASA-Glenn and Bell Helicopter, a modified “V” notch geometry for the 3-point bending fatigue sample was defined; the notch geometry was consistent with notched flexure fatigue specimens used by Bell Helicopter. The modified “V” notch has a 60° included angle with a 1.16 mm radius (0.0455”) to simulate a typical gear tooth root geometry. The test specimen configuration is shown in Figure 1.

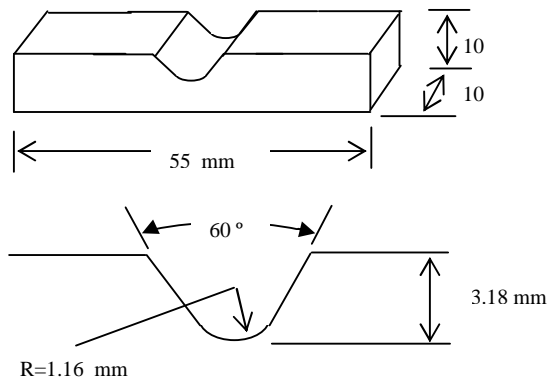

Figure 1. Modified “V-notch” Sample Configuration.

To most accurately capture the combined carburizing and geometry effects of a Pyrowear gear, the notched test bars were carburized only on the top surface (including the notch), as shown schematically in Figure 2. To accomplish the localized carburization, the sides and bottom surfaces of the

bending fatigue samples were masked with copper plating. This is standard practice for blocking carburization of selected surfaces on aerospace parts.

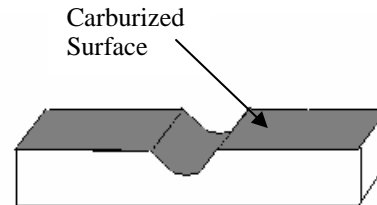

Figure 2. Schematic of Test Sample showing the Carburized Surface

Process Simulation

Prior to physical heat treating, a series of heat treat models was run to characterize the respective processes to be applied to the test pieces. The use of a simulation tool provided a rapid, non-destructive and cost effective means of assessing both the internal metallurgical behavior during and after processing, as well as the mechanical response, in terms of residual stress, hardness, and dimensional change. For this task, the heat treatment simulation software DANTE® was used to characterize the carburization and two quench hardening processes selected for the program.

The Pyrowear 53 material was carburized to a carbon level of 0.80% and an effective case depth of 0.5 mm. The DANTE® simulation employed a carburization cycle with applied carbon potential as prescribed directly from the gear OEM’s. The 3-D mesh for the simulation is shown in Figure 3.

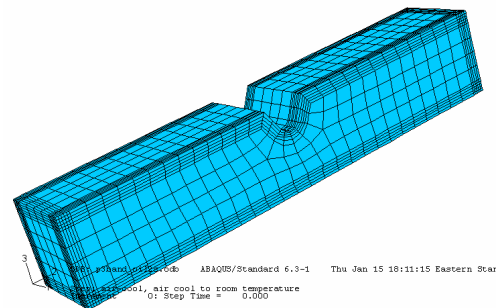

Figure 3. Finite Element Mesh of Test Sample.

Simulations were also performed to assess the probable effects on residual stress and hardness between oil and intensive quenching processes. Table 3 summarizes the process steps for each of the evaluated quenching operations after carburization. Simulation of the quenching was performed through application of heat transfer coefficients for the oil or intensive quenching, and the subsequent cryogenic treatment. The DANTE® tempering model was also employed for the temper operation. The simulation indicated a marked enhancement in both surface and subsurface residual compression for intensive quenching. Therefore, physical

processing and testing was initiated on the Pyrowear bend test coupons. Predictions of hardness and residual stress are compared against measured values in the next section.

Physical Characterization

Upon completion of the heat treatments on the Pyrowear notch bar specimens, microhardness profiles were measured at the sample notch, beginning at a depth of 0.005" (0.13 mm). A plot comparing the resulting hardness profiles for the two heat treatments is presented in Figure 4; also included are the hardness profiles predicted by the heat treat simulations. Here one sees the most pronounced improvement in hardness at the surface and subsurface to a depth of about 0.02" (0.5mm).

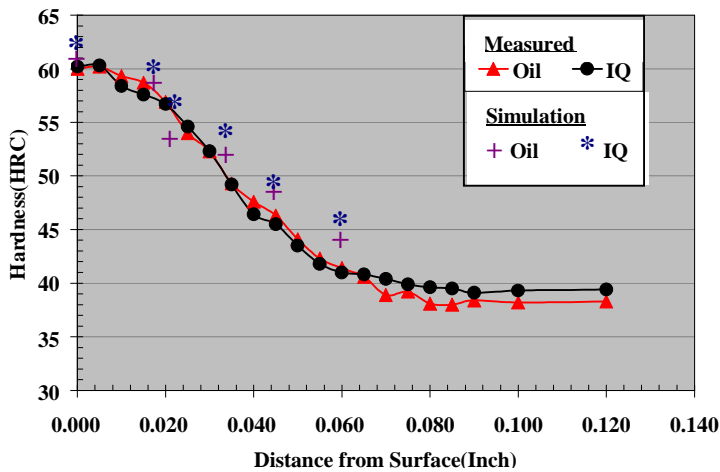

Figure 4. Comparison of Predicted and Measured Hardness at the Test Sample Root.

Both a conventional oil and an intensively quenched notched bar sample were sent to Lambda Research for surface and internal residual stress characterization. A combination X-ray diffraction / chemical etching technique was used to measure lattice strains and then calculate the longitudinal residual stress as a function of depth from the notch root. Measurements were taken at 0.2 mm (0.008") increments, to a depth of 1.2 mm (0.047"). The simulation and the measured test results display excellent agreement, as shown in the plot presented in Figure 5. The project methodology proved the value of process simulation as a predictive design tool.

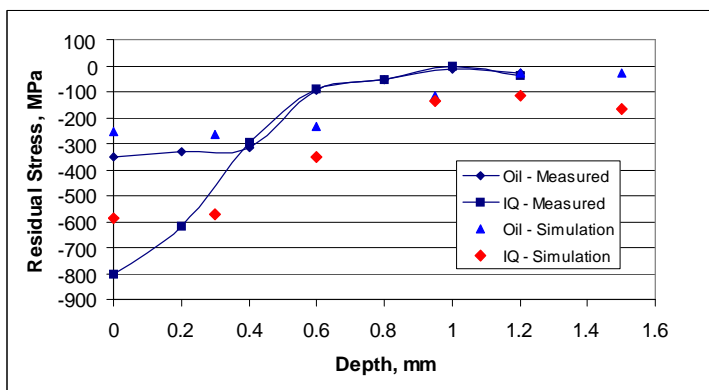

Figure 5. Predicted vs. Measured Residual Stress Profiles at the V-Notch as a Function of Depth.

To assess the bending fatigue resistance of the carburized and heat treated Pyrowear 53 notch bar samples, three-point bending fatigue tests were conducted using a servo-hydraulic testing machine at Case Western Reserve University. The machine was operated using load control, with the minimum to maximum load ratio being 0.1 so that the notch was under constant cyclic tension. This condition assured that no slippage or sample movement occurred during testing, at least up to the point of large ram displacement due to cracking. To stop the test quickly after crack development, strain gages were applied to the samples at the notch root.

Eighteen oil quenched and seventeen intensively quenched fatigue samples were tested in bending fatigue to compare the effect of the two heat treat processes on the resulting fatigue resistance. Figure 6 shows the fatigue test data for the two quenched conditions. A test was stopped after the number of cycles exceeded 10^6 and declared a runout. Rupture of the strain gage occurred when a crack began to extend, and the test machine would automatically stop and the sample was declared a failure. Failed samples were bent, not broken. While there is scatter evident in the data, Figure 6 shows that the resistance to bending fatigue is higher for the intensively quenched test bars than for the conventionally quenched oil test bars.

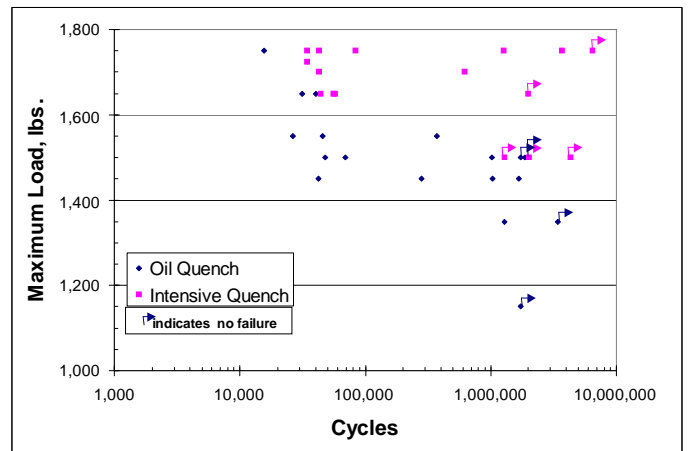

Figure 6. 3-Point Bending Fatigue Data for Carburized and Hardened Pyrowear 53 Notched Test Bars.

Statistical analysis of the data was performed to verify that the apparent improvement in bending fatigue resistance due to intensive quenching was real.[13] Following a relationship used to compare the bending fatigue strength of gear teeth, raw data were transformed to allow comparison of projected lives at a normalized load. In this case, the normalized load was selected as 1500 pounds, and a Weibull distribution was fit to the transformed data. A comparison of these data at both the 10% and 50% lives showed a statistical difference between the intensively and quenched and oil quenched test bars, see Table 3.[13] The analysis demonstrates the benefit of deeper residual compressive stress produced by intensive quenching on bending fatigue resistance. At the 50% life level, the ratio

of improvement was 4.2, with a 98% confidence level. However, at the lower 10% life level, the ratio dropped to 1.2, with just a 60% statistical confidence. The relatively low Weibull shape parameter for both quenched conditions is indicative of scatter in the test data. The difference in the significance of the life data comparison is also indicative of the test data scatter. One probable source of scatter was the surface finish of the notch and the fact that grinding was not performed after the milling operation to shape the notch.

Table 3. Statistical Analysis of Transformed Fatigue Data

	Intensive Quench Test Bar	Oil Quench Test Bar
Weibull Shape Parameter	0.458	0.665
10% Life (10^3 Cycles)	25	21
50% Life (10^6 Cycles)	1.5	0.36
Ratio of 10% Lives (IQ/OQ)	1.2	
Statistical Significance	<60%	
Ratio of 50% Lives (IQ/OQ)	4.2	
Statistical Significance	>98%	

Phase IA – Process Sensitivity and Refinement

Simulation in Process Sensitivity Assessment

The data scatter seen in the initial repeat notch bar testing necessitated additional investigation into IQ process variables and sensitivity. The DANTE predictive heat treatment software tool provided significant insight into the process sensitivity, particularly with respect to the effect of variation in water flow and application time.

The initial quench configuration used for the notch bar samples was a fixture system in which the water flow was directed parallel to the longitudinal direction of the sample, as shown schematically in Figure 7.

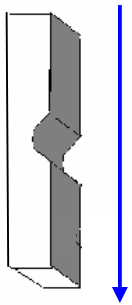

Figure 7. Phase I Quench Configuration.

Using the DANTE software, DCT executed a series of heat treatment simulations to characterize the sensitivity of resulting residual compressive stress in the sample with respect to water flow application and timing. It was found that full flow must be achieved within ≤ 1.0 seconds from initial quench application to develop the temperature gradient needed to achieve the deep compressive residual stresses. This information is crucial because it demonstrates

quantitative sensitivity data for quenching this type of root geometry. The shift in thermal gradient caused by the initial reduced flow, although seemingly insignificant, produced a distinct variation in the surface residual stress profile across the notch surface.

Simulations showed that the surface residual stress below the notch could vary from -600 MPa (87 ksi) at the outer edge to -45 MPa (6.52 ksi) at the center. This critical finding illustrates both the utility and importance of a simulation design tool in understanding and optimizing a manufacturing process such as heat treatment. With this information, modifications to the IQ valve system were made accordingly. Future plans also include computer control with data recording of operation and water application.

Coupling improved flow control with enhanced notch surface quality through grinding, the next variable examined was part orientation relative to the flow. Here again, process simulation with the DANTE design software demonstrated critical value. With the goal being optimal application of intensive quenching, three (3) new configurations were examined:

- A – Quench application directly onto the notch
- B – Quench flow parallel through notch
- C – Quench flow parallel through notch with stacked sample

Each configuration is illustrated schematically in Figure 8.

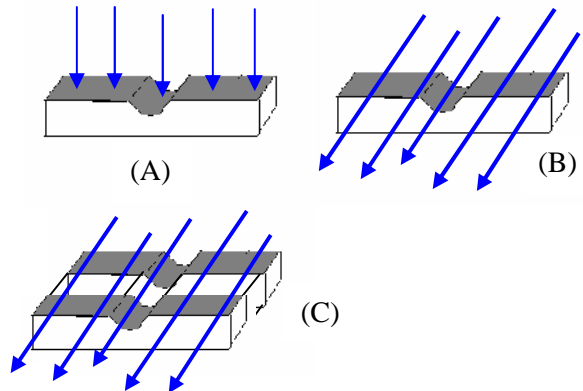

Figure 8. Sample Quench Configurations Examined in Phase IA.

DANTE simulations were conducted on each of these configurations to determine sensitivity of stress magnitude and distribution as a function of intensive quench flow orientation. As in the flow timing diagnostic work previously discussed, profiles of the resulting residual stresses across the surface notch were compared for each case. The plot in Figure 9 displays the results, while Figure 10 shows contour maps of the final residual stress through the notch cross section for each case. What appears immediately evident from the simulations is that, as seen with flow timing application, the orientation of the part relative to flow also has a significant effect on residual stress – specifically distribution.

Configuration A (normal flow) displayed the most consistent and uniform residual stress, with minimal variation in stress magnitude across the length of the notch. With flow parallel to the notch in processing a single sample (Configuration B), stress magnitude remains relatively uniform from the leading

edge through the center, but drops off rapidly at the trailing edge by nearly 50% (225 MPa vs. max. compression of ~450 MPa). The stacked configuration (C), with both outer edges essentially insulated, showed the worst performance with near 50% residual stress drop-off at both outer edges. Also, the stacked configuration displayed a wide region in the bar interior with tensile stress on the order of 330 MPa, extending through the bar thickness. The magnitude and spread of these tensile stresses are not as pronounced in configurations A and B. Thus from a residual stress standpoint, expectations were for configuration A to show superior bending fatigue performance as compared with the oil quenched samples (see oil stresses in Figure 5). Configuration B would be expected to show inferior or at best similar performance to the oil quench. Configuration C samples were not physically evaluated.

Physical Testing of Simulated Quench Configurations

In continuing the notch bar fatigue characterization, 84 additional notch bar samples were prepared using a carefully planned design-of-experiments approach to physically quantify the findings revealed in the DANTE simulations. Table 4 details this second notch bar testing plan.

Table 4. Test Matrix for Phase IA

Process Configuration	No. Samples
Oil Immersion Quench	20
IQ – Quench Normal to Notch Face (A)	20
IQ – Quench Parallel to Notch Face (B)	20

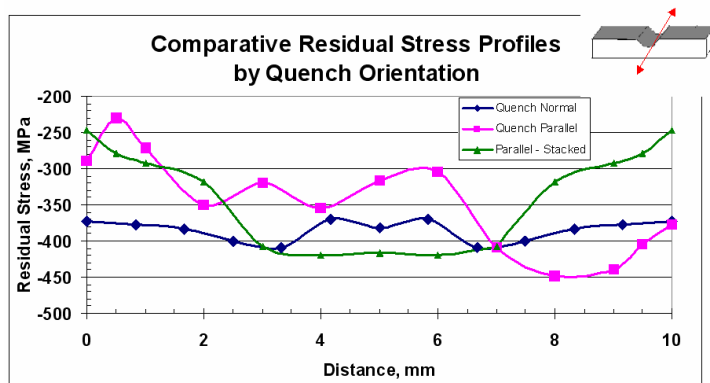

Figure 9. Comparison of Predicted Surface Residual Stress Across the Root of the Sample Notch.

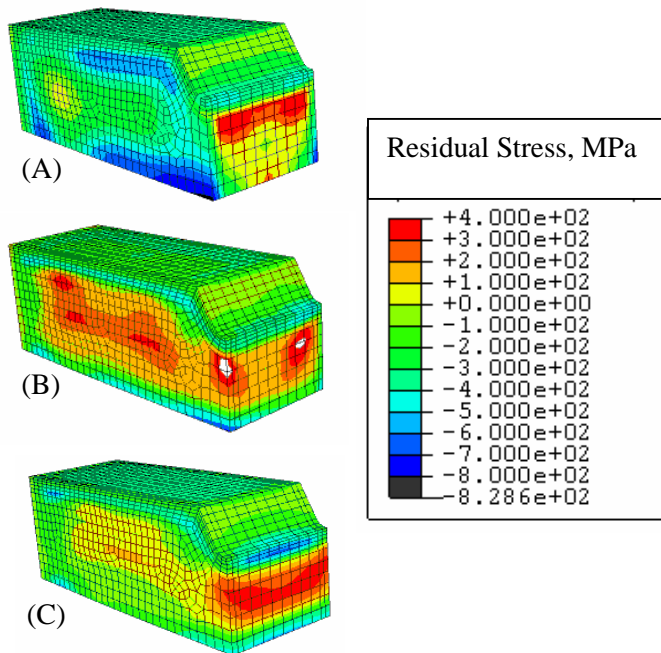

Figure 10. Predicted Cross Section Residual Stress Contours for 3 Quench Configurations.

To facilitate the normal and parallel directional flow, a new fixture was developed for the notch bars for use in the quench processing equipment. The fixture was a high temperature stainless steel cylinder, in which the notch bar was fitted diametrically. During austenitization, the entire fixture assembly (with sample) was heated. Transfer of the fixture into the quenching unit was rapid and highly consistent, with the entire assembly easily fitted into place within the IQ water flow tube.

Comparative x-ray and simulation residual stress calculations are presented in Figure 11.

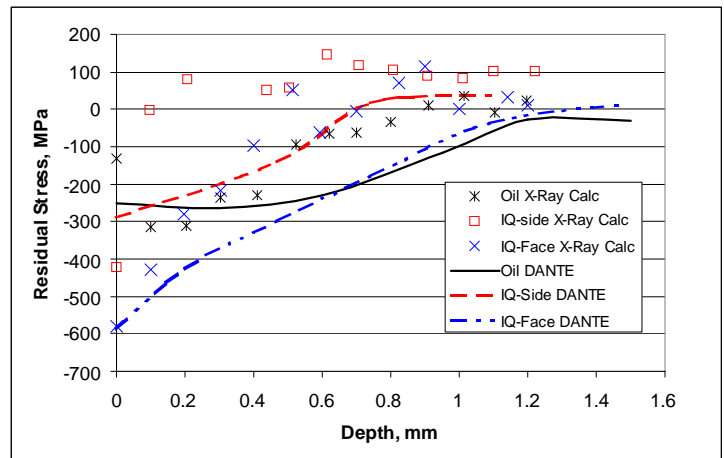

Figure 11. Comparative X-Ray and Simulation Predicted Residual Stress Profiles in Notch Bars.

As in the review of the surface stress simulation predictions, examination of the residual stress profiles would also indicate superior bending fatigue performance of the IQ-Face samples (config. A), over the oil quenched and parallel quenched specimens (config. B). Bending fatigue test data for this evaluation is shown in Figure 12. The new data showed a marked reduction in scatter, as both overall notch surface quality was improved and process stability was enhanced. Most importantly, the bending fatigue test data parallels exactly the expected performance as predicted in the

simulations. The IQ-faced quenched samples showed a clear maximum cyclic load limit of 1825 lbs., whereas the samples quenched in the standard oil quench practice showed a clear limit at 1650 lbs. Also consistent with the simulation stress predictions and x-ray calculations were the IQ-parallel quench samples, which performed slightly worse than the oil quenched material.

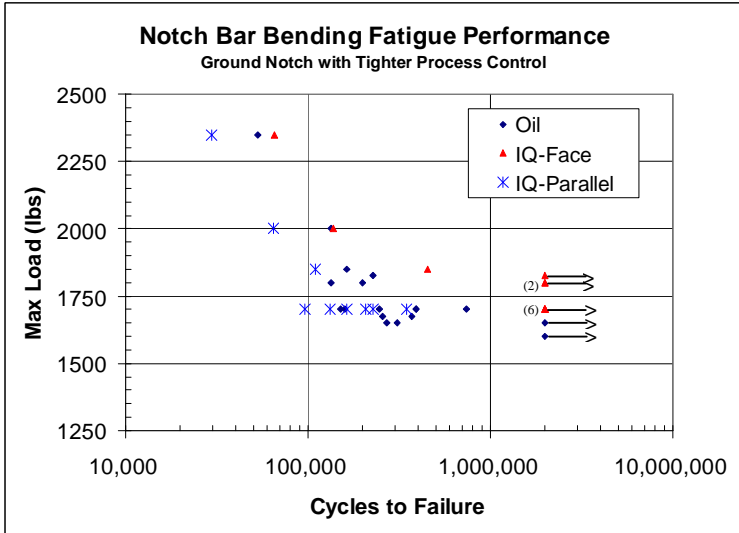

Figure 12. 3-Point Bending Fatigue Data for Phase IA Notch-Bar Evaluation.

Phase II – Implementation into Full Gear Component

With the strong feasibility demonstrated in Phase I and Phase IA for achieving the bending fatigue life increase goal, the next phase was initiated to extend the evaluation to full gear components. Through consultation with both the US Army AATD and military helicopter OEM’s, a simple spur gear design was selected as the Phase II test component. Configuration and summary gear specifications are shown in Figure 13.

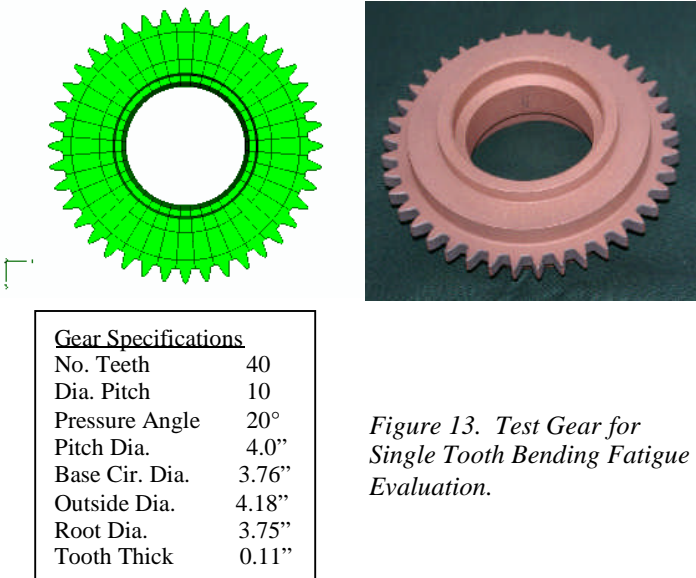

Figure 13. Test Gear for Single Tooth Bending Fatigue Evaluation.

Prior to quench hardening, the gears are vacuum carburized selectively on the teeth surfaces, with copper plating masking the balance of the gear as seen in the figure.

Process and Testing Plan

The effect of intensive quenching on the bending fatigue strength of the Pyrowear 53 gear will be evaluated by single tooth bend testing. The configuration of the test apparatus is shown schematically in Figure 14. In the test, a cyclic load is applied to two teeth via a movable upper anvil and a rigid lower anvil, with the gear remaining fixed by a shaft support.

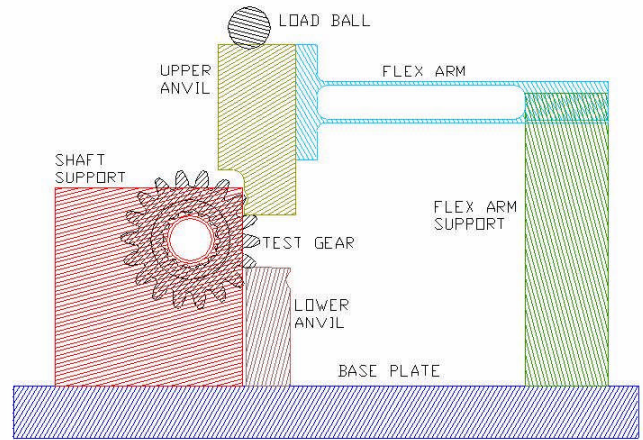

Figure 14. Schematic of Single Tooth Bending Fatigue Test Set-up.

For this tooth bending test, the evaluation plan shown in Table 5 was developed to quantitatively assess single tooth bending fatigue improvement.

Table 5. Test Plan for Tooth Bend Testing of Pyrowear 53 Spur Gear.

Process	No. Gears	Tests/Gear	Total
Standard Oil Quench	12	6	72
Intensive Quench	12	6	72

Heat Treating and Test Loading Simulation

As with the notch bar, an analytical approach was taken for the test gear heat treatment assessment with respect to both quench flow and fixturing design. A propriety fixture and channeled flow system was developed for intensive quench process, and a comparative heat treatment simulation study conducted to compare the predicted residual stress profiles between the intensive and oil quenched gears.

The resulting magnitude and distribution of predicted residual stresses for both quenching processes are shown in the contour plot illustrated in Figure 15. The figure illustrates the residual stress contours through the mid-plane cross section of the gear.

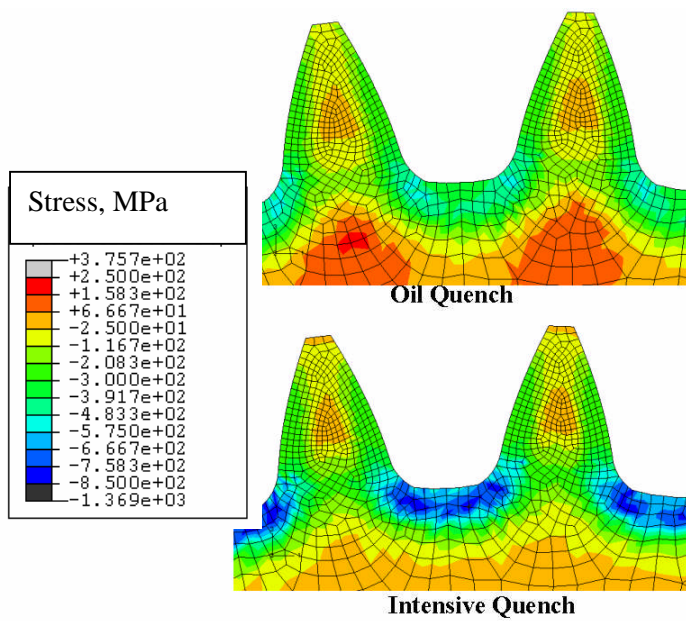

Figure 15. Residual Stress Profile Comparison after Heat Treat through Tooth/Root Cross Section,

While both quench methods are predicted to produce nearly identical stress in the tooth itself, both magnitude and distribution of the compressive stress in the root are markedly increased for the intensive quench process. The quantitative differences are clearly seen in direct comparison of stress profiles at three locations in the tooth/root cross section (Figure 16).

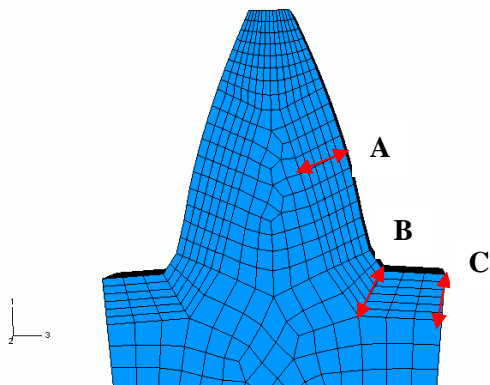

Figure 16. Reference Directions Points in Tooth/Root Cross Section .

Figures 17 – 19 compare the predicted residual stress profiles between the oil and intensive quenched simulations at the 3 locations shown in Figure 16. While the the tooth section (A) shows consistent residual compression between the two quenches (Figure 17), surface and subsurface compression at the tooth base (B) (Figure 18) and root center (C) (Figure 19) show significant increases in residual compression to a depth

of 1.5 mm (0.059”). For the tooth base the predicted increase is from 490 MPa (71 ksi) to 700 MPa (102 ksi), and for the center root from 320 MPa (46.4 ksi) to 620 MPa (89.9 ksi).

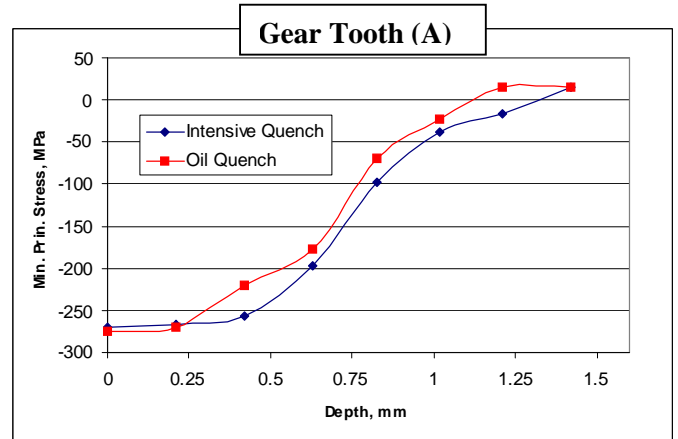

Figure 17. Residual Stress Profile Comparison at Position (A) in Test Gear.

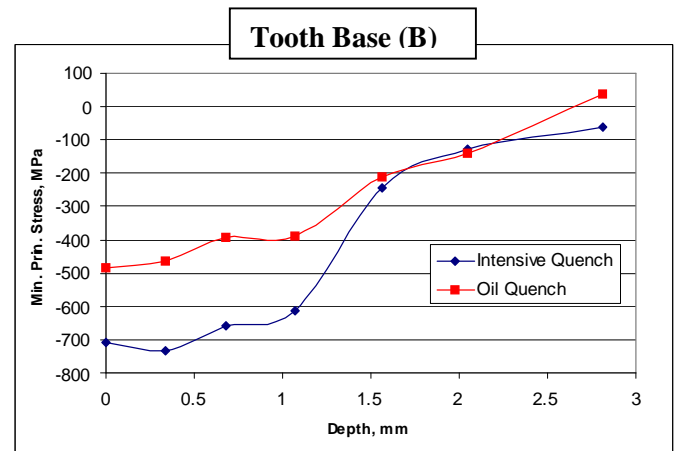

Figure 18. Residual Stress Profile Comparison at Position (B) in Test Gear.

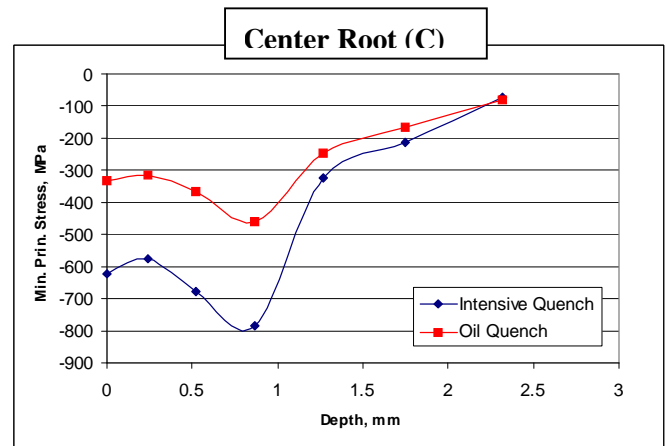

Figure 19. Residual Stress Profile Comparison at Position (C) in Test Gear.

Based on the modeling results, physical trials are currently underway involving x-ray analysis of the residual stresses at the locations investigated in the simulation.

The additional engineering utility of the DANTE heat treatment simulations is the ability to analyze composite stresses in the gear. Stresses generated in gear loading are of course affected by the residual stresses generated in the heat treatment. Quantitative assessment of the composite stress is not straightforward, and has typically been done under the assumption that the stress states are additive.

Simulation results illustrating this interaction for both the oil intensively quenched gears are shown in Figures 20 – 22. The nonlinear response of residual stress at the tooth base is clearly evident in the comparative stress plots presented in Figure 20. The graph compares the pre-loaded tooth base residual stress profile with that under a 900 lb. tooth load. The simulation provides important data concerning the non-linear response, as well as information concerning depth relationships. From a design standpoint, this type of analysis provides an important tool in engineering residual stresses to meet complex loading requirements.

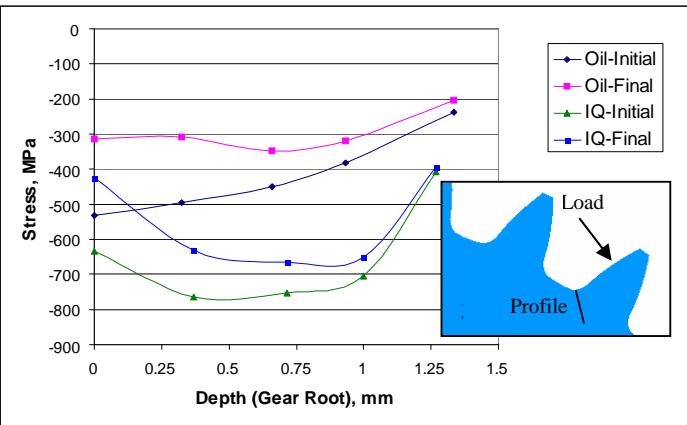

Figure 20. Comparison of Residual Stress Profiles at Tooth Base in Unloaded (Heat Treat Residual Stress Only) and Loaded (Composite Stress) Conditions.

Additional insight into behavior of the composite stresses can be gained through examination of cross-sectional contour maps such as shown in Figures 21 and 22. For example, in the oil quenched gear (Figure 21) one can see localized tensile regions below the tooth. This region increases in both volume and magnitude when the tooth is subjected to loading. In contrast, the intensively quench gear (Figure 22) shows a much smaller sub-tooth tensile region, which does not increase significantly during loading. Such characterization is valuable in understanding potential fracture path and failure mode. Therefore extending heat treatment simulation to include subsequent loading represents an important engineering design milestone.

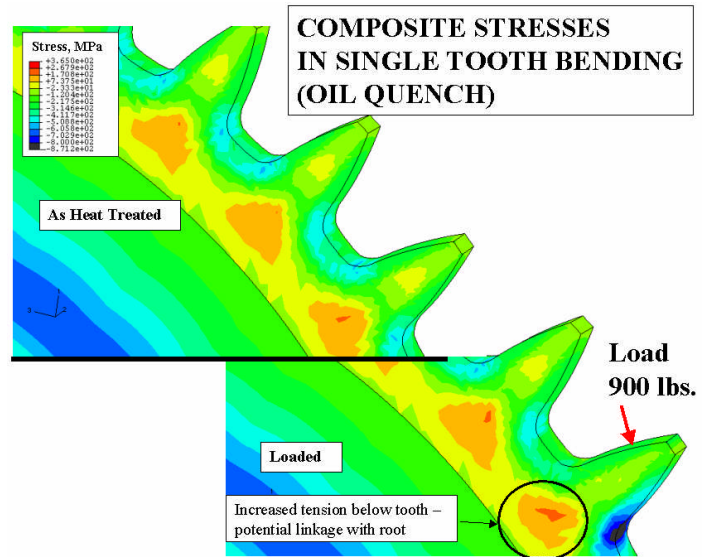

Figure 21. Cross Section Contour Map of Residual Stress in Oil Quenched Gear for Unloaded and Loaded Conditions.

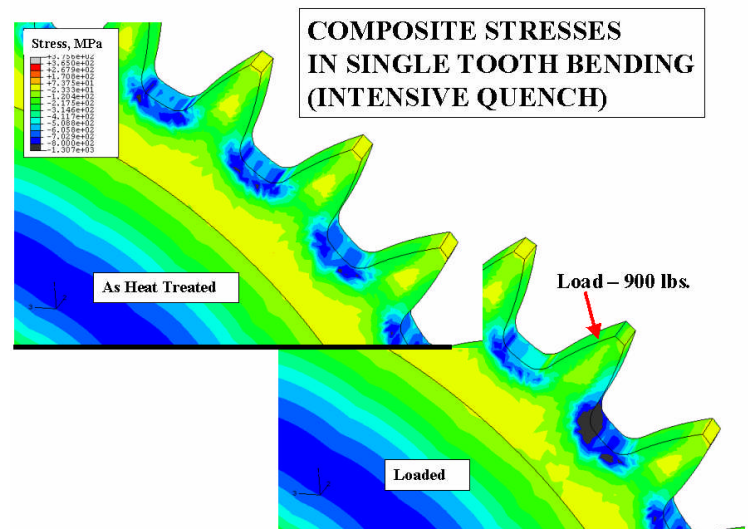

Figure 22. Cross Section Contour Map of Residual Stress in Intensive Quenched Gear for Unloaded and Loaded Conditions.

Conclusions

This study proved the feasibility of improving bending fatigue strength by altering the hardening process. The intensive quenching process produced a deeper compressive stress state after heat treatment than conventional oil quenching, and this resulted in improved bending fatigue strength. Furthermore, the goal of at least a 25% improvement was realized in these notched samples.

In addition to the fatigue test data, this study showed the benefit of using accurate numerical simulation. A finite element based software tool, DANTE, was used to simulate hardening processes for carburized samples to assess the sensitivity of residual stress state to quench conditions. Simulation was used to determine the quenching conditions required to achieve the goal of deeper residual compression and thus improved resistance to fatigue. An added benefit was shown to be the ability to carry the residual stress state from heat treatment forward to then simulate stresses during the fatigue test. This capability will prove beneficial for predicting part performance by combining process induced stresses with part service stresses.

Acknowledgements

The authors wish to acknowledge the support of B. Smith and the US Army AATD for their support of this work through the SBIR project #W911W6-05-C-0017. Appreciation is also expressed to B. Hansen of Sikorsky Aircraft Corp., S. Rao of the Gear Research Institute, and IQ Technologies in Akron, Ohio.

References

1. N. I. Kobasko and V. S. Morganyuk, "Numerical Study of Phase Changes, Current and Residual Stresses in Quenching Parts of Complex Configuration," *Proceedings of the 4th International Congress on Heat Treatment of Materials*, Berlin, Germany, 1 (1985), 465-486.
2. N. I. Kobasko, "Intensive Steel Quenching Methods. Theory and Technology of Quenching", Springer-Verlag, New York, N.Y., 1992, 367-389.
3. N. I. Kobasko, "Method of Overcoming Self-Deformation and Cracking During Quenching of Metal Parts," *Metallovedenie and Termicheskay Obrabotka Metallov* (in Russian), 4 (1975), 12-16.
4. M. Hernandez et al., "Residual Stress Measurements in Forced Convective Quenched Steel Bars by Means of Neutron Diffraction", *Proceedings of the 2nd International Conference on Quenching and the Control of Distortion*, ASM, (1996), 203-214.
5. M. A. Aronov, N. I. Kobasko, J. A. Powell, J. F. Wallace, and D. Schwam, "Practical Application of the Intensive Quenching Technology for Steel Parts," *Industrial Heating Magazine*, April 1999, 59-63.
6. A. M. Freborg, B. L. Ferguson, M. A. Aronov, N. I. Kobasko, and J. A. Powell, "Intensive Quenching Theory and Application for Imparting High Residual Surface Compressive Stresses in Pressure Vessel Components," *Journal of Pressure Vessel Technology*, 125 (2003), 188-194.
7. B. L. Ferguson, A. M. Freborg, and G. J. Petrus, "Comparison of Quenching Processes for Hardening a Coil Spring," *Advances in Surface Engineering, Metallurgy, Finishing and Wear*, SAE (01) 1373, (2002).
8. D. Bammann et. al., "A Material Model for Carburizing Steels undergoing Phase Transformations," *Proceedings of the 2nd International Congress on Quenching and Control of Distortion*, (Cleveland, OH: ASMI, 1996), 367-375.
9. B. L. Ferguson, A. M. Freborg, G. J. Petrus, and M. L. Callabresi, "Predicting the Heat Treat Response of a Carburized Helical Gear," *Gear Technology* (2002), 20-25.
10. B. L. Ferguson and A. M. Freborg, "A Design Tool for Tuning and Optimizing Carburizing and Heat Treat Processes," *Technical Paper 2002-01-1475*, SAE (2002).
11. B. L. Ferguson and A. M. Freborg, "Software to Predict Distortion of Heat Treated Components," *US Army SBIR - Phase II Final Report, USAAMCOM TR 02-D-46*, (2002).
12. Product Technical Data, Carpenter Technology Corporation, 2001.
13. T. Krantz, Army Research Laboratory, Private Communication, June 2004.