

10-PV Array Operation

Off-Grid Electrical Systems in Developing Countries
Chapter 7.6–7.15

1



Learning Outcomes

At the end of this lecture, you will be able to:

- ✓ understand how to mathematically model a PV module
- ✓ interpret a PV specification sheet (data sheet)
- ✓ model the effects of irradiance and temperature on PV module voltage, current, and maximum power
- ✓ compute the voltage, current, and maximum power from a PV array

2

PV Modules

- PV modules are made by connecting several PV cells
- Increasing number of series or parallel-connected cells affects the I-V curve of the module

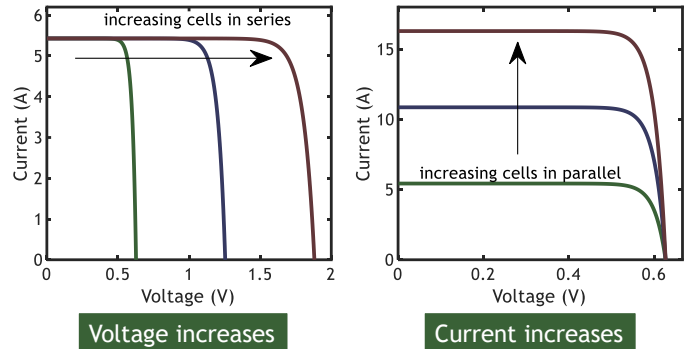

copyright 2019 www.drhenrylouie.com

3

3

PV Modules

- Most modules are made from connected PV cells in series
- Module voltage is simply the cell voltage multiplied by the number of series-connected cells:

$$V_{\text{module}} = N_{\text{ser}} \times V_{\text{cell}}$$

$$I_{\text{cell}} = I_G - I_0 \left(e^{V_{\text{cell}}/V_T} - 1 \right)$$

$$I_{\text{module}} = I_G - I_0 \left(e^{V_{\text{module}}/(V_T N_{\text{ser}})} - 1 \right)$$

V_{module} : PV module voltage (V)
 I_{module} : PV module current (A)
 N_{ser} : number of series-connected cells

copyright 2019 www.drhenrylouie.com

4

4

PV Modules

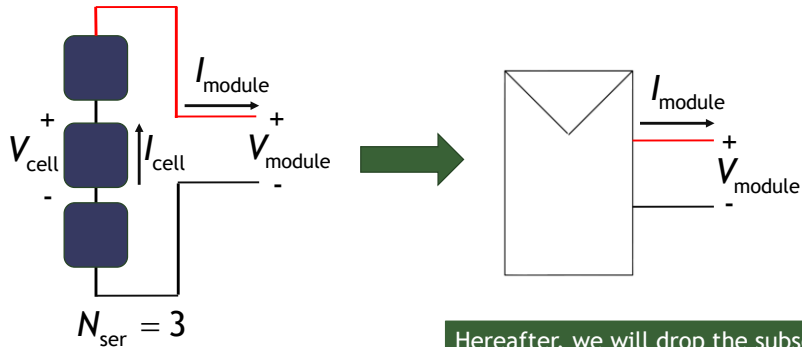

Hereafter, we will drop the subscript "module" since we are usually not interested in the characteristics of an individual cell

PV Spec Sheets

See handout (also on Canvas)

itek SE 72-Cell Module

Design & Engineering Data

GENERAL DATA	
Cell Type	<ul style="list-style-type: none"> 72 high-efficiency monocrystalline p-type cells 6 x 12 cell matrix
Solar Glass	<ul style="list-style-type: none"> Ultra-clear antireflective treatment Tempered, with low iron content Anti-glare pneumatic subsurface feature
Backsheet	<ul style="list-style-type: none"> Multi-layered Engineered adhesion for maximum weather protection
Frame	<ul style="list-style-type: none"> High-strength corrosion-resistant anodized aluminum Compatible with threaded racking, accommodating both top-down clamps and bottom-flange mounting
Cable	<ul style="list-style-type: none"> 99C 15AWG PV wire
Junction Box	<ul style="list-style-type: none"> 3 bypass diodes 1000 VDC MC4 connection Type 154
Grounding	<ul style="list-style-type: none"> Certified for Wiley Electronics WEE3™ grounding clips Right standard grounding locations per module for reduced ground wire length

QUALIFICATIONS	
Fire Rating	Type 1
PD Time	5001 hours
ATRA, IMA, and IMA Compliant	

ELECTRICAL DATA*					
	800 SE	805 SE	840 SE	845 SE	870 SE
Maximum Power - P_{max}(W)	350	355	360	365	370
Maximum Power Voltage - V_{mp}(V)	38.55	38.74	38.94	39.12	39.32
Maximum Power Current - I_{mp}(A)	9.08	9.16	9.25	9.33	9.41
Maximum Current - I_{sc}(A) (IS)	12	12	12	12	12
Maximum Voltage (P_{max} @ V_{oc}) - V_{oc}(V)	43.57	43.77	43.99	44.19	44.40
Open-Circuit Voltage - V_{oc}(V) (P_{max} @ V_{oc})	47.43	47.54	47.67	47.83	48.01
Short-Circuit Current - I_{sc}(A) (P_{max} @ V_{oc})	9.49	9.55	9.62	9.69	9.75
Module Efficiency	17.64%	17.79%	18.02%	18.20%	18.52%

MECHANICAL DATA	
Dimensions	1002mm x 1993mm x 40mm
Weight	49 lbs/22.3kg

MAXIMUM RATINGS	
Operational Temperature	-40...+90°C
Maximum System Voltage	1000 VDC
Maximum Design Load (UL 1708)	113 psf(5400pa)
Max Series Fuse Rating	15A
Max Reverse Current	15A

TEMPERATURE RATINGS	
Nominal Operating Cell Temperature (NOCT)	45.01°C
Temperature Coefficient of P_{max}	-0.21%/°C
Temperature Coefficient of V_{oc} @ I_{sc}	-0.29%/°C
Temperature Coefficient of V_{oc} (P_{max} @ V_{oc})	0.05%/°C
Temperature Coefficient of I_{sc}	+0.04%/°C
Temperature Coefficient of V_{oc}	-0.38%/°C

*Electrical characteristics may vary within 25% of the indicated values at Unstressed Test Conditions (STC): irradiance of 1,000 W/m², AM 1.5 spectrum, cell temperature at 25°C (77°F).
 Note: specifications subject to change without notice.

choose from Safety | Safety + Optimization | Safety + Optimization + Long Strings
 All of these options include Monitoring

14 Platform

- T84.L LONG STRING
- T84.O OPTIMIZATION
- T84.S SAFETY
- T84.M MONITORING
- T84.D DECIDE

Tigo

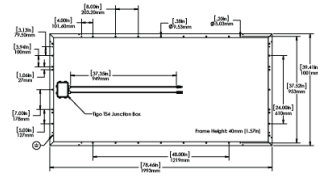

What PV Capacity (Power rating) Means

Itek SE 350 module has a maximum power rating of 350 W

- How should that be interpreted?
- Will it produce 350 W on a winter day in Seattle?
- Will it produce 350 W on a summer day in Las Vegas?
- Will it ever produce more than 350 W?
- Do the characteristics of the load or battery that it is connected to matter?

copyright 2019 www.drhenrylouie.com

7

7

Main Factors Affecting PV Power Production

Irradiance



Temperature



Load



Spectral distribution of irradiance
also affects production

copyright 2019 www.drhenrylouie.com

8

8

PV Module Spec Sheets

- Modules rated at Standard Test Conditions (STC)
 - Irradiance: 1000 W/m²
 - Cell temperature: 25°C
 - Spectral distribution: AM 1.5
- PV modules rarely operate under STC

itek SE 72-Cell Module

Design & Engineering Data

GENERAL DATA

Cell Type	• 72 high-efficiency monocrystalline p-type cells • 6 x 12 cell matrix
Joint Glass	• Ultra-clear anti-reflective treatment • Tempered, with low iron content • Anti-glare prismatic subsurface texture
Backsheet	• Multilayered • Engineered adhesion for maximum weather protection
Frame	• High-strength corrosion-resistant anodized aluminum • Compatible with standard racking, accommodating both top-down clamps and bottom-ledge mounting
Cable	• 100% 12 AWG PV wire
Junction Box	• 3 bypass diodes → 1000 VDC MC4 connection • Tigo TS4
Grounding	• Certified for Wiley Electronics WEEB™ grounding clips • Right standard grounding locations per module for reduced ground wire length

QUALIFICATIONS

IEC Rating	Type 1
IEC Test	5000 hours
IEC 61215 and IEC 61730	Compliant
ELECTRICAL DATA*	300 IE 305 IE 305 IE 305 IE 370 IE
Maximum Power - P_{max} (W)	350 355 360 365 370
Maximum Power Voltage - V_{mp} (V)	35.55 35.74 35.94 36.12 36.32
Maximum Power Current - I_{mp} (A)	9.08 9.16 9.23 9.33 9.41
Maximum Current - I_{sc} (A)	12 12 12 12 12
Maximum Voltage - V_{oc} (V)	43.57 43.77 43.99 44.19 44.40
Open Circuit Voltage - V_{oc} (V)	47.43 47.64 47.87 48.08 48.31
Short Circuit Current - I_{sc} (A)	9.49 9.55 9.62 9.69 9.76
Module Efficiency	17.54% 17.79% 18.02% 18.26% 18.55%

MECHANICAL DATA

Dimensions	1001mm x 1992mm x 40mm
Weight	49 lbs/22.2kg

MAXIMUM RATINGS

Operating Temperature	-40 ~ +90°C
Maximum System Voltage	1000 VDC
Maximum Design Load (UL 1708)	1.13 psf(154.0psf)
Max Series Fuse Rating	15A
Max Reverse Current	15A

TEMPERATURE RATINGS

Normal Operating Cell Temperature (NOCT)	45.0°C
Temperature Coefficient of P_{max}	-0.39%/°C
Temperature Coefficient of V_{oc} (EIAJEC)	-0.29%/°C
Temperature Coefficient of V_{oc} (IEC-1 only)	0.05%/°C
Temperature Coefficient of I_{sc}	+0.24%/°C
Temperature Coefficient of V_{mp}	-0.38%/°C

*Electrical characteristics may vary within 2% of the indicated values at Standard Test Conditions (STC): irradiance of 1,000W/m², AM 1.5 spectrum, cell temperature at 25°C.

Note: specifications subject to change without notice.



Choose from Safety | Safety + Optimization | Safety + Optimization + Long Strings
All of these options include Monitoring

S4 Platform

- T84.L LONG STRINGS
- T84.O OPTIMIZATION
- T84.S SAFETY
- T84.M MONITORING
- T84.D DIOXIDE

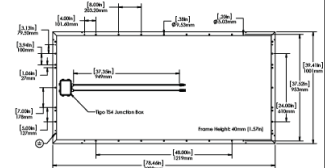

Headquarters: 3886 Hammer Drive, Bellingham, WA 98226
Sales Offices: WA: (360) 647-9221 | NH: (603) 318-6384 | CA: (560) 393-0178
info@itekenergy.com | www.itekenergy.com

V12.15.17

www.drhenrylouie.com

Standard Test Conditions

- We use subscript “STC” to denote a variable referenced to Standard Test Conditions
- Examples:
 - G_{STC} : irradiance at STC ($G_{STC} \triangleq 1000 \text{ W/m}^2$)
 - P_{STC}^* : maximum power output under STC
 - V_{STC}^* : voltage at the maximum power point under STC
 - $I_{SC,STC}$: short-circuit current under STC

Spec Sheet Interpretation

For the 350 SE module, determine:

P_{STC}^* _____

V_{STC}^* _____

$V_{OC,STC}$ _____

I_{STC}^* _____

$I_{SC,STC}$ _____

itek SE 72-Cell Module Design & Engineering Data

GENERAL DATA

Cell Type	• 72 high-efficiency monocrystalline p-type cells • 6 x 12-cell matrix
Joint Glass	• Ultra-clear anti-reflective treatment • Tempered, with low iron content • Anti-glare prismatic subsurface texture
Backsheet	• Multilayered • Engineered adhesion for maximum weather protection
Frame	• High-strength corrosion-resistant anodized aluminum • Compatible with standard racking, accommodating both top-down clamps and bottom-flange mounting
Cable	• 10C 12AWG PV wire
Junction Box	• 3 bypass diodes • 1000 VDC MC4 connection • Type T54
Grounding	• Certified for Wiley Electronics WEEB™ grounding clips • Eight standard grounding locations per module for reduced ground wire length

QUALIFICATIONS

PV Rating	Type 1
PD Free	500+ hours
IEEE 610, and IEC 61215	

ELECTRICAL DATA*

	350 SE	355 SE	360 SE	365 SE	370 SE
Maximum Power - P_{max}(W)	350	355	360	365	370
Maximum Power Voltage - V_{mp}(V)	38.55	38.74	38.94	39.12	39.32
Maximum Power Current - I_{mp}(A)	9.08	9.16	9.25	9.33	9.41
Maximum Current - I_{sc}(A)	12	12	12	12	12
Maximum Voltage (P_{max} at V_{oc}) - V_{oc}(V)	43.57	43.77	43.99	44.19	44.40
Open Circuit Voltage - V_{oc}(V) (P_{max} at I_{sc})	47.43	47.64	47.87	48.08	48.31
Short Circuit Current - I_{sc}(A) (P_{max} at V_{oc})	9.49	9.55	9.62	9.69	9.76
Module Efficiency	17.54%	17.79%	18.02%	18.26%	18.55%

MECHANICAL DATA	
Dimensions	1001mm x 1992mm x 40mm
Weight	49 lbs/22.2kg

MAXIMUM RATINGS	
Operating Temperature	-40...+90°C
Maximum System Voltage	1000 VDC
Maximum Design Load (UL 1709)	1.13 psf(1540psf)
Max Series Fuse Rating	15A
Max Reverse Current	15A

TEMPERATURE RATINGS	
Normal Operating Cell Temperature (NOCT)	45.0°C
Temperature Coefficient of P_{max}	-0.39%/°C
Temperature Coefficient of V_{oc} (P_{max} at V_{oc})	-0.29%/°C
Temperature Coefficient of V_{oc} (P_{max} at I_{sc})	0.05%/°C
Temperature Coefficient of I_{sc}	+0.24%/°C
Temperature Coefficient of V_{oc}	-0.38%/°C

*Electrical characteristics may vary within ±5% of the indicated values at Standard Test Conditions (STC): Irradiance of 1,000W/m², AM 1.5 spectrum, cell temperature at 25°C.

Note: specifications subject to change without notice.



Choose from Safety | Safety + Optimization | Safety + Optimization + Long Strings
All of these options include Monitoring

S4 Platform

- T54.L LONG STRINGS
- T54.O OPTIMIZATION
- T54.S SAFETY
- T54.M MONITORING
- T54.D DIVERS

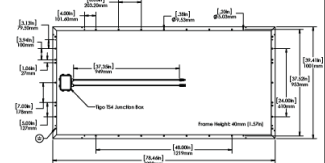

copyright 2019 www.drhenrylouie.com

Headquarters: 3886 Hammer Drive, Bellingham, WA 98226
Sales Offices: WA: (360) 647-9231 | NH: (603) 318-6384 | CA: (360) 393-0178
info@itekenergy.com | www.itekenergy.com

V12.15.17

Rated Power Interpretation

The 350 SE module will produce 350 W when the irradiance incident to it is 1000 W/m², the cell temperature is 25° C, the spectral distribution of the irradiance is AM 1.5, and it is connected to a load that maximizes the power production under these conditions

We will generally assume that that the load maximizes power production (i.e. the module operates at the MMP for a given set of conditions)

copyright 2019 www.drhenrylouie.com

Correcting for Irradiance

- Irradiance varies throughout the day
- Whenever the irradiance differs from G_{STC} (1000 W/m²), the maximum power output is affected
 - Maximum power is a function of irradiance $P^*(G)$
- Maximum power is approximately proportional to the irradiance
 - Doubling irradiance doubles maximum power

Correcting for Irradiance

Maximum power accounting for actual irradiance

$$P^*(G) = P_{STC}^* \times \frac{G}{G_{STC}}$$

Exercise

Estimate the power produced by the Itek SE 370 if the irradiance is 750 W/m^2

Exercise

Estimate the power produced by the Itek SE 370 if the irradiance is 750 W/m^2

$$P^*(G) = P_{\text{STC}}^* \times \frac{G}{G_{\text{STC}}}$$

$$P^*(G) = 370 \times \frac{750}{1000} = 277.5 \text{ W}$$

Correcting for Irradiance

The model assumes (approximates)

$$V^*(G) = V_{STC}^*$$

Voltage at MPP is not affected by irradiance

$$I^*(G) = I_{STC}^* \times \frac{G}{G_{STC}}$$

Current at MPP changes in proportion to irradiance

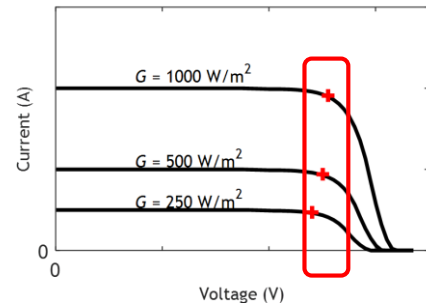

copyright 2019 www.drhenrylouie.com

17

17

Correcting for Temperature

- I-V characteristic of PV module is influenced by the temperature
- Increasing temperature:
 - Decreases voltage
 - Increases current
- Change in voltage dominates the change in current, so power (voltage x current) decreases

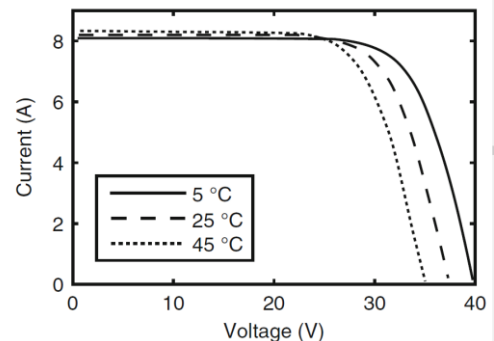

copyright 2019 www.drhenrylouie.com

18

18

How does temperature affect the design and operation of off-grid PV systems?

- Charge controllers have a maximum input voltage rating; cold temperatures can increase the PV module voltage, possibly exceeding (and damaging) the charge controller
- Overall energy reduction will be reduced (perhaps significantly) due to temperature-related losses

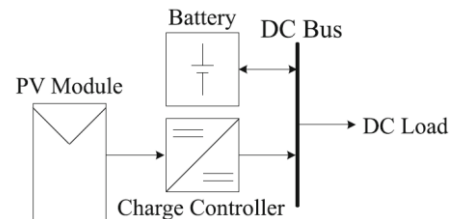

Correcting for Temperature

- Sensitivity of voltage, current, and power to temperature is empirically determined and reported by the manufacturer as “temperature coefficients”
- Coefficients are used to determine how open-circuit voltage, short-circuit current, and maximum change as the cell temperature deviates from 25° C
- Power can be reduced by 10 to 15% because cell temperature is often >20° C higher than that of STC

Temperature Coefficients

α_v : open-circuit voltage temperature coefficient (%/K or %/C)

α_i : short-circuit current temperature coefficient (%/K or %/C)

α_p : maximum power temperature coefficient (%/K or %/C)

Temperature coefficients are provided in module spec sheet

21

copyright 2019 www.drhenrylouie.com

21

Correcting for Temperature

$$I_{SC}(T_C) = I_{SC}(25^\circ \text{ C}) \left(1 + \frac{\alpha_i}{100} \times (T_C - 25) \right)$$

$$V_{OC}(T_C) = V_{OC}(25^\circ \text{ C}) \left(1 + \frac{\alpha_v}{100} \times (T_C - 25) \right)$$

$$P^*(T_C) = P^*(25^\circ \text{ C}) \left(1 + \frac{\alpha_p}{100} \times (T_C - 25) \right)$$

V_{oc} : open-circuit voltage at 25° C (V)
 I_{oc} : short-circuit current at 25° C (A)
 T_c : temperature of the PV cell, (C)

Note that if the cell temperature is 25° C, then no correction is applied. This makes sense since because 25° C corresponds to STC

22

copyright 2019 www.drhenrylouie.com

22

Example

The cell temperature of the Itek 370 SE module is 47° C. What is the short-circuit current at this temperature? Assume that other than temperature, the module is operating under STC.

Example

Referring to the spec sheet, we see that $\alpha_i = +0.04\%/C$ and $I_{SC,STC}$ is 9.76A.

$$I_{SC}(T_C) = I_{SC}(25^\circ C) \left(1 + \frac{\alpha_i}{100} \times (T_C - 25) \right)$$

$$I_{SC}(T_C) = 9.76 \left(1 + \frac{0.04}{100} \times (47 - 25) \right)$$

$$I_{SC}(T_C) = 9.769A$$

We shouldn't be concerned about the units being in Celsius, since the temperature is also expressed in these units (moreover, the difference in one degree Celsius is the same as the difference in one degree Kelvin)

How do we determine the temperature of the cell?

- Manufacturers report the cell temperature when the PV module is exposed to “Standard Operating Conditions” (SOC)
- The reported temperature is known as “Nominal Operating Cell Temperature” (NOCT)
 - typically between 45° C and 50° C
- When module is not exposed to SOC (often the case), then the cell temperature will likely not be NOCT and the cell temperature must be estimated

Standard Operating Conditions

Standard Operating Conditions

- Irradiance: 800 W/m² (0.8 G_{STC})
- Ambient temperature: 20°C
- Wind speed: 1 m/s
- Spectral distribution: AM 1.5
- Power output: 0 W (no load)
- see IEC 61215 for test procedure

Do not confuse SOC with STC!

Nominal Operating Cell Temperature

What happens when the module does not operate under SOC?
Approximate the cell temperature from:

$$T_c = T_a + (NOCT - 20) \frac{G}{800} \quad T_a: \text{ambient temperature (C)}$$

Other formulations exist for correcting for non-SOC wind speed, but it is not commonly employed

Example

What is the cell temperature of the Itek 370 SE when the irradiance is 400 W/m^2 , and the ambient temperature is 15° C ?
(Assume SOC otherwise)

Example

From the spec sheet the NOCT is 45.01° C

$$T_c = T_a + (NOCT - 20) \frac{G}{800}$$

This is a cold day (about 59° F)

$$T_c = 15 + (45.01 - 20) \frac{400}{800}$$

$$T_c = 27.5^\circ\text{C}$$

We see that the PV module is hotter than the ambient temperature

Exercise

What is the maximum power produced by the Itek SE 370 when the ambient temperature is 30° C and the irradiance on the module is 1000 W/m²?

Exercise

What is the maximum power produced by the Itek SE 370 when the ambient temperature is 30° C and the irradiance on the module is 1000 W/m²?

The temperature coefficient for power is -0.39%/°C

The NOCT is 45.01° C

The irradiance corresponds to G_{STC} , so use P_{STC}^* from the spec sheet (370 W)

Exercise

First compute cell temperature

$$T_c = T_a + (NOCT - 20) \frac{G}{800}$$

$$T_c = 30 + (45.01 - 20) \frac{1000}{800}$$

$$T_c = 61.27^\circ\text{C}$$

Now compute maximum power

$$P^*(T_c) = P^*(25^\circ\text{C}) \left(1 + \frac{\alpha_p}{100} \times (T_c - 25) \right)$$

$$P^*(30^\circ\text{C}) = 370 \left(1 + \frac{-0.39}{100} \times (T_c - 25) \right)$$

$$P^*(30^\circ\text{C}) = 317.7\text{ W}$$

Power has been reduced by 14% due to temperature

Correcting for Temperature & Irradiance

- Last example conveniently had an irradiance of 1000 W/m² (STC)
- What about when the cell temperature AND irradiance deviate from STC?
 - Mostly concerned about maximum power, not open-circuit voltage or short-circuit current

PV Power Production

- Several different methods possible
- Osterwald's method:

$$P = P_{\text{STC}}^* \times \frac{G}{1000} \times \left(1 + \frac{\alpha_p}{100} \times (T_c - 25) \right)$$

P: power produced by PV module (W)
*P*_{STC}^{*}: rated power under Standard Test Conditions (W)
G: irradiance (W/m²)
 α_p : power coefficient (% /K)
*T*_c: PV cell temperature (C)

Osterwald's Method

$$P = P_{\text{STC}}^* \times \frac{G}{1000} \times \left(1 + \frac{\alpha_p}{100} \times (T_c - 25) \right)$$

Corrects for irradiance

Corrects for temperature

Exercise

What is the maximum power produced by the Itek SE 370 when the ambient temperature is 30° C and the irradiance on the module is 900 W/m²?

Exercise

What is the maximum power produced by the Itek SE 370 when the ambient temperature is 30° C and the irradiance on the module is 900 W/m²?

The temperature coefficient is -0.39%/°C

The NOCT is 45.01° C

copyright 2019 www.drhenrylouie.com

37

37

Exercise

First compute cell temperature

$$T_c = T_a + (NOCT - 20) \frac{G}{800}$$

$$T_c = 30 + (45.01 - 20) \frac{900}{800}$$

$$T_c = 58.14^\circ\text{C}$$

Now compute maximum power

$$P = P_{STC}^* \times \frac{G}{1000} \times \left(1 + \frac{\alpha_p}{100} \times (T_c - 25) \right)$$

$$P = 370 \times \frac{900}{1000} \times \left(1 + \frac{-0.39}{100} \times (58.14 - 25) \right)$$

$$P = 289.96 \text{ W}$$

Compare this to the result of the previous exercise

copyright 2019 www.drhenrylouie.com

38

38

Short-Circuit Current

- We generally only correct the short-circuit current based on irradiance (not temperature) using:

$$I_{STC}(G) = I_{SC,STC} \times \frac{G}{G_{STC}}$$

- Important when determining fuse ratings and charge controller compatibility

Open-Circuit Voltage

- We generally only correct the open-circuit current based on temperature (not irradiance) using:

$$V_{OC}(T_c) = V_{OC}(25^\circ \text{C}) \left(1 + \frac{\alpha_v}{100} \times (T_c - 25) \right)$$

- Important when determining insulation ratings and charge controller compatibility

PV Arrays

- PV modules connected together are known as a *PV Array*
- Series-connected modules are known as “strings”
- Strings with the same number of series-connected modules can be connected in parallel
- Assume that all modules in the array are operating under the same conditions

copyright 2019 www.drhenrylouie.com

41

41

PV Arrays

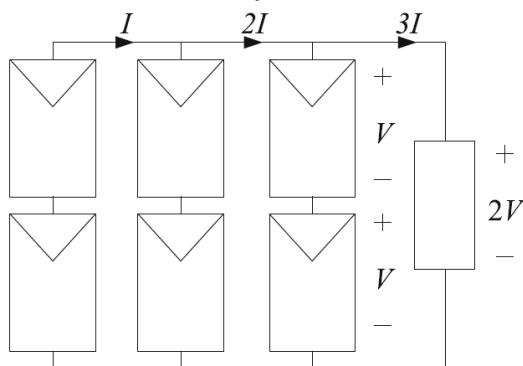

This array has three strings of two modules

$$V_{\text{array}} = N_{\text{ser,str}} \times V$$

$$I_{\text{array}} = N_{\text{par,str}} \times I$$

$N_{\text{ser,str}}$: number of modules connected in series per string
 $N_{\text{par,str}}$: number of strings connected in parallel

copyright 2019 www.drhenrylouie.com

42

42

PV Array Power

- Power produced by the array:

$$\begin{aligned} P_{\text{array}} &= V_{\text{array}} \times I_{\text{array}} = N_{\text{ser,str}} \times V \times N_{\text{par,str}} \times I \\ &= N_{\text{ser,str}} \times N_{\text{par,str}} \times P \\ &= \text{Number of modules} \times P \end{aligned}$$

- In other words, the power produced is independent of how the modules are connected (as long as each string has the same number of modules connected in series)

43

copyright 2019 www.drhenrylouie.com

43

Example

Compute the open-circuit voltage, short-circuit current and maximum power of this array assuming operation under STC (let the modules be Itek 370 SE)

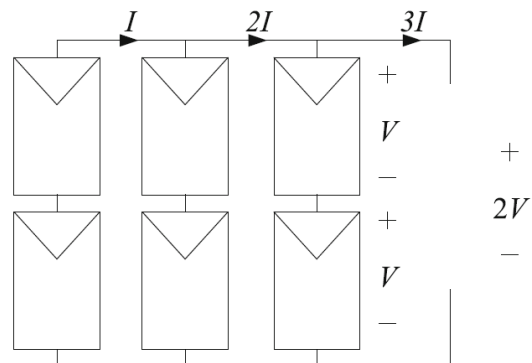

44

copyright 2019 www.drhenrylouie.com

44

Example

From the spec sheet:

$$I_{SC,STC} = 9.76 \text{ A}$$

$$V_{OC,STC} = 48.31 \text{ V}$$

$$P_{STC}^* = 370 \text{ W}$$

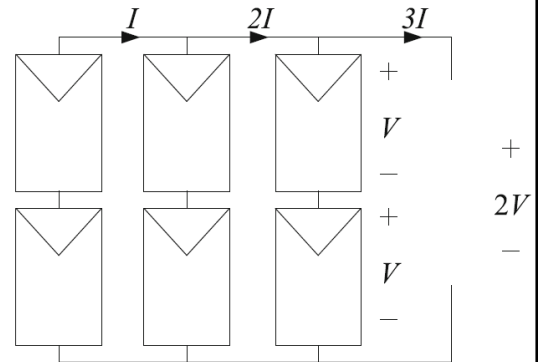

45

copyright 2019 www.drhenrylouie.com

45

Example

There are three strings in parallel, and two modules in each string so:

$$I_{array,SC,STC} = 3 \times 9.76 = 29.28 \text{ A}$$

$$V_{array,OC,STC} = 2 \times 48.31 = 96.62 \text{ V}$$

$$P_{array,STC}^* = (3 \times 2) 370 = 2220 \text{ W}$$

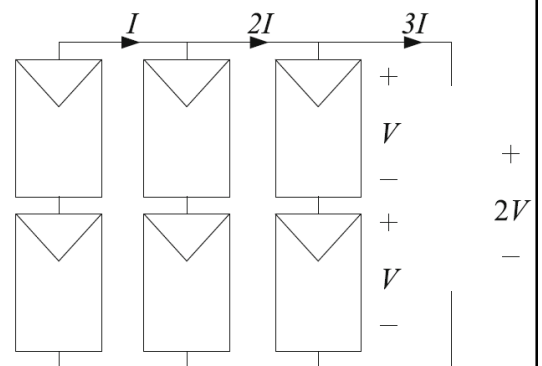

46

copyright 2019 www.drhenrylouie.com

46

Exercise

A design calls for three Itek 370 SE modules to be arranged in a single string and connected to a charge controller. The maximum voltage input rating of the charge controller is 150 VDC. Verify the charge controller can be used if the array operates under STC.

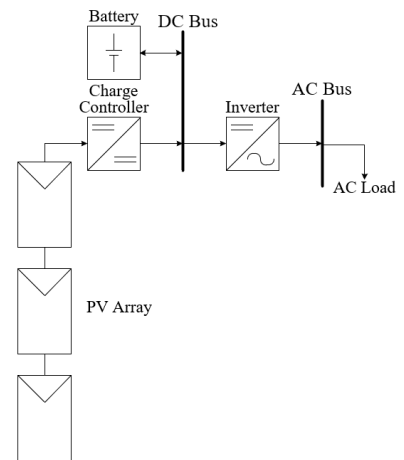

copyright 2019 www.drhenrylouie.com

47

47

Exercise

A design calls for three Itek 370 SE modules to be arranged in a single string and connected to a charge controller. The maximum voltage input rating of the charge controller is 150 VDC. Verify the charge controller can be used if the array operates under STC.

The PV modules are arranged in a string, so that:

$$V_{OC,array} = N_{ser,str} \times V_{OC,STC}$$

$$V_{OC,array} = 3 \times 48.31 \quad \text{(from the spec sheet)}$$

$$V_{OC,array} = 144.93 \text{ V}$$

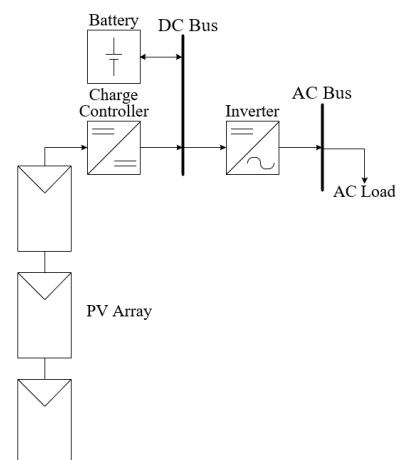

copyright 2019 www.drhenrylouie.com

48

48

Exercise

We know that STC operation almost never happens. The array open-circuit voltage was very close to the charge controller rating. We should check to see if the controller can be used if the temperature is low (why?). Assume the lowest cell temperature will be 5° C. Can the controller be used?



Exercise

We know that STC operation almost never happens. The array open-circuit voltage was very close to the charge controller rating. We should check to see if the controller can be used if the temperature is low (why?). Assume the lowest cell temperature will be 5° C. Can the controller be used?

$$V_{OC,array}(T_C) = 3 \times V_{OC}(25^\circ \text{C}) \left(1 + \frac{\alpha_v}{100} \times (T_C - 25) \right)$$

$$V_{OC,array}(5^\circ \text{C}) = 3 \times 48.31 \left(1 + \frac{-0.29}{100} \times (5 - 25) \right)$$

$$V_{OC,array}(5^\circ \text{C}) = 153.3 \text{ V}$$

This exceeds the charge controller rating.

Shading

- Complete or partial shading of PV module or array can severely reduce power production
- Avoid locations where shading occurs



copyright 2019 www.drhenrylouie.com

51

51

Shading

Read Chapter 7.12 of text for details, including how to mitigate the effects of shading by using diodes

“The current supplied by a PV module is limited to the current produced by its least productive cell.”---not exactly correct, but easy to remember

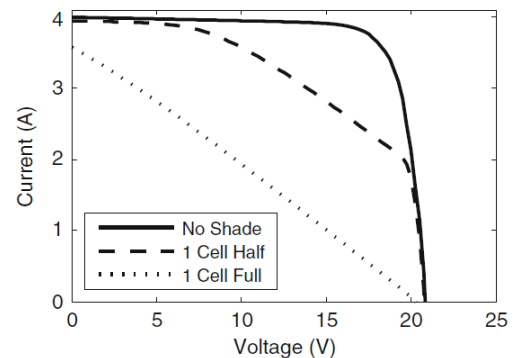

copyright 2019 www.drhenrylouie.com

52

52

Energy Production from PV Arrays

The energy produced by a PV array over the course of a day is found by integrating its power production

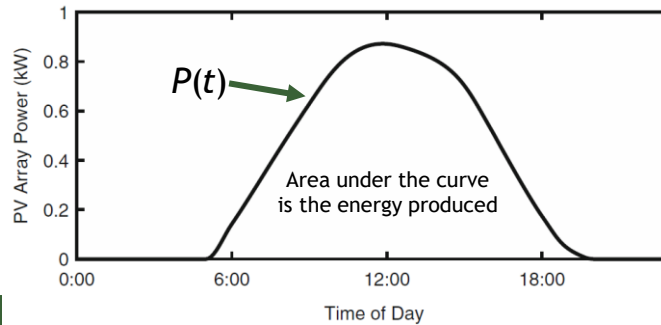

copyright 2019 www.drhenrylouie.com

53

53

Energy Production from PV Arrays

Integrate power between sunrise and sunset times (be careful of the units)

$$P(t) = P_{\text{STC}}^* \times \frac{G(t)}{1000} \times (1 + \alpha_p \times (T_c(t) - 25))$$

We expect both the irradiance and cell temperature to vary with time (t)

$$E = \int_{t_{\text{rise}}}^{t_{\text{set}}} P(t) dt$$

t_{set} : time the sun sets
 t_{rise} : time the sun rises

copyright 2019 www.drhenrylouie.com

54

54

Practical Considerations: Advantages



- No fuel costs
- Wide resource data availability
- Modularity
- Low maintenance (periodic washing of panels)
- No noise or air pollution
- Widely available, mature supply chains

copyright 2019 www.drhenrylouie.com

55

55

Practical Considerations: Disadvantages



- Variable and uncertain power production
- Requires charge controllers and batteries, and requires an inverter to serve AC load
- Higher capital costs than gen sets
- Relatively low power density so large amount of space needed
- Often requires custom racking to optimize incident irradiance



(courtesy GVE Projects)

copyright 2019 www.drhenrylouie.com

56

56

Contact Information

Henry Louie, PhD

Associate Professor

Fr. Wood Endowed Research Chair

Seattle University

 @henrylouie

hlouie@ieee.org

www.drhenrylouie.com

Office: +1-206-398-4619

