

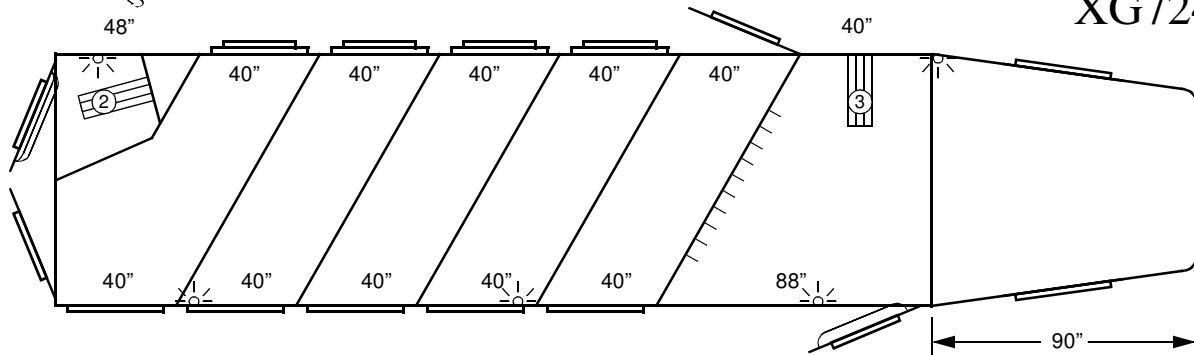

**PLATINUM
MANUFACTURING**

5 HORSE SLANT GOOSENECK PLATINUM SERIES 7' X 24' X 7' XG7245D



TOWING

2 5/16" ADJUSTABLE COUPLER (25,000# RATING)
SAFETY CHAINS WITH SAFETY HOOK LATCHES
7-WAY FLAT PRONG PLUG & CABLE
BREAK-AWAY KIT
DROP LEG JACK

STANDARD FEATURES

TAPERED NECK FROM 7' TO 5' WITH WINDOWS
PERMANENT SLANT BULKHEAD WALL
PERMANENT OFFSET REAR STORAGE WALL (REAR TACK)
DOUBLE REAR DOORS WITH WINDOWS AND BUTTERFLY LATCH
DRESSING ROOM DOOR AT DROP WITH WINDOW AND CAMPER LATCH WITH DEAD BOLT
WALK THRU DOOR AT FIRST STALL WITH WINDOW AND BUTTERFLY LATCH
DROP DOWN FEED DOORS WITH WINDOWS AT HEAD OF EACH STALL
ALL DOORS ARE INSULATED AND LINED ON INSIDE OF TRAILER
BUS WINDOWS AT HIP OF EACH STALL
SIDE WALLS IN HORSE COMPARTMENT ARE DOUBLE WALLED AND INSULATED
ALL WALLS IN HORSE COMPARTMENT ARE RUBBER LINED
DIVIDERS WITH STAINLESS STEEL SLAM LATCHES
FEED BAGS (ONE PER HORSE)
2-WAY ROOF VENTS (ONE PER HORSE)
INSIDE TIES (TWO PER HORSE)
OUTSIDE TIES (TWO PER HORSE)
SADDLE RACKS (ONE PER HORSE)
TACK ACCESSORIES: TEN BRIDLE HOOKS, TWO BRUSH TRAYS AND ONE BLANKET BAR
PADDING IN HORSE COMPT. ON BULKHEAD WALL, REAR TACK WALL AND EACH SIDE OF DIVIDERS
PADDED BUTT BAR AND PADDED BREAST BAR AT FIRST HORSE
CARPET ALL TACK ACCESSORIES (EXCLUDING BRIDLE HOOKS)
CARPET ON BED, DROP AND FLOOR OF DRESSING ROOM AREA
FLOOR MATS COVERING ENTIRE HORSE COMPARTMENT INCLUDING REAR TACK
FOLD-UP STEP CLEAT ON DROP
TAPER INNER WHEEL WELLS UP & TEAR DROP FENDERS
FULL WIDTH RUBBER DOCK BUMPER
FIVE INTERIOR L.E.D. LIGHTS
TWO PAIRS OF FULLY ENCLOSED L.E.D. TAIL LIGHTS
D.O.T. APPROVED L.E.D. RUNNING LIGHTS AND D.O.T. APPROVED REFLECTIVE TAPE

WHEELS & TIRES

FIVE 16 X 6 STEEL WHEELS
FIVE 235/85R16 10-PLY RADIAL TIRES
FOUR STAINLESS STEEL SIMULATORS
SPARE TIRE CARRIER

AXLES

102" WIDE RUBBER TORSION
7000# 8-BOLT ELECTRIC BRAKES

CUSTOM GRAPHICS PACKAGE

