



Progress Solar Hybrid™ Light Tower
Operator Manual

(SHYB 700 to 1400 Series)



Progress Solar Hybrid™ Light Tower **Operator Manual**

Table of Contents

<u>Operator’s Manual</u>	<u>Page #</u>
Table of contents	2
Introduction	3
Safety Alert Symbols	4
Safety Information.....	4-6
Serial & Model Number Locations.....	6
Specifications & Dimensions	7-8
Components	9-13
Inspection Checklist	14
Operating Instructions	15-22
Maintenance Program.....	23-24
Warranty	25
Manufacturer Certification Label Example	26

APPENDICES –

Appendix A – Troubleshooting Guide

Appendix B – Victron Battery Monitor Manual

Appendix C – TRISTAR MPPT Manual

Appendix D – Dynagen Manual

Generator Manual – Need specific manual for generator in unit. Pull make and model from generator you have and locate on manufacturer website.



Introduction

- Do not attempt to operate this unit without reading and understanding the Operator's Manual.
- It is imperative that any person using, operating or working on the mobile unit reads and studies the Operation Manual carefully. Information included in the manual instructs the user how to operate and maintain the unit safely.
- This Manual contains current specifications and is subject to change without notice.
- Read the manual thoroughly before using the unit. If you are unclear of any of the information, please contact the factory or your local dealer before continued use.
- Make this information available to all who may use or will be working around the Progress Solar (SHYB) or Progress Solar/Wind (SHYB(W)) Light Towers to ensure a safe working environment and a properly maintained system.
- **WARNING:** Although the unit once understood is very easy to use and maintain, improper use can cause permanent damage to the unit or harm to a person. For example, the batteries must have access to sunlight or other source to charge batteries during long duration storage or regular use. If the batteries are allowed to completely discharge and not immediately recharged, they will be permanently damaged and unable to function at their full potential. The batteries are the most expensive single component to replace and must all be replaced at the same time.

Note:

- This version of the manual is current as of date published. The manual may be updated as needed.
- To request a hard copy of this manual or a subcomponent manual, e-mail our Parts and Service email at parts@ProgressSolarSolutions.com with your VIN number and a detail request. System component operator instructions may be available if more information is required.

Progress Solar Light Tower Basic Set-Up and Tear-Down Video

YouTube Link: <https://www.youtube.com/@progresssolarsolutions>

Every SHYB/SHYBW unit includes a QR code sticker located inside or near the Control Box. If the operator has a Smart Phone with camera they can scan and view the same video while standing in front of the unit.



Safety Information

Alert symbols are located where danger is present, a warning is necessary or cautionary measures need to be taken. Be aware of these symbols and follow advised safety instructions to avoid harm to yourself, others or the unit. The following symbols identify the level of exposure to the operator of the unit.



DANGER: INDICATES HAZARD, UNSAFE ACTION OR PROCEDURE **WILL CAUSE** SERIOUS INJURY OR DEATH.

WARNING: INDICATES HAZARD, UNSAFE ACTION OR PROCEDURE **COULD POSSIBLY CAUSE** SERIOUS INJURY OR DEATH.

CAUTION: INDICATES HAZARD, UNSAFE ACTION OR PROCEDURE **COULD POSSIBLY RESULT** IN INJURY OR DAMAGES TO PROPERTY.

General Safety

WARNING:

- DO NOT OPERATE THE SHYB OR SHYB(W) MOBILE UNIT WITHOUT READING THE OPERATOR MANUAL AND SAFETY INSTRUCTIONS.
- DO NOT USE THE SHYB OR SHYB(W) DURING ELECTRICAL STORMS OR DURING LIGHTNING
- DO NOT USE THE SHYB OR SHYB(W) DURING EXTREMELY HIGH WINDS
- ALWAYS TURN OFF ALL ELECTRICAL BREAKERS PRIOR TO SERVICING OR MAINTENANCE OF ANY ELECTRICAL COMPONENTS

CAUTION:

- DO NOT OPERATE THIS UNIT WHILE UNDER THE INFLUENCE OF MEDICATION, FATIGUE, ILLNESS, ALCOHOL OR DRUGS.
- CHECK FOR LOOSE BOLTS, CONNECTIONS AND OTHER LOOSENED MATERIAL BEFORE TRANSPORTING OR USING THE UNIT.



- BEWARE OF TRAFFIC HAZARDS; STAND CLEAR OF TRAFFIC WHEN POSITIONING THE UNIT ROAD SIDE. SECURE ALL FASTENERS ON TRAILER BEFORE MOBILE UNIT IS IN TRANSIT. RETRACT MAST AND ALL OUTRIGGERS, STOW / LOCK IN CORRECT POSITION BEFORE TRANSIT.
- NEVER CLIMB ON TOP OF THE MAIN HOUSING UNIT.
- MAKE SURE UNIT IS LEVEL BEFORE ERECTING THE LIGHT TOWER. EXTEND ALL OUTRIGGERS BEFORE TOWER IS ERECTED AND KEEP OUTRIGGERS EXTENDED THE ENTIRE TIME THE TOWER IS ERECTED.
- NEVER ATTACH ANYTHING TO THE LIGHT TOWER MAST.
- KEEP AREA CLEAR WHILE RAISING OR LOWERING THE LIGHT TOWER.
- A SUPPLEMENTAL GROUNDING ROD, CAN BE USED WHERE POSSIBLE. THIS MAY REDUCE CHANCE OF PERSONAL INJURY DUE TO STRAY CURRENT. THIS SAFETY DEVICE CAN HELP PREVENT ELECTRIC SHOCK WHILE IN CONTACT WITH UNIT. USER IS RESPONSIBLE TO COMPLY WITH ALL NATIONAL, STATE AND LOCAL CODES FOR GROUNDING ROD USAGE.

Note:

- This unit should only be operated by qualified and trained personnel.
- Replace safety and instruction decals when they become difficult to read.
- Unauthorized modifications to the unit or removal of manufacturers labeling will void the warranty and may be unsafe and any accident resulting from unauthorized modifications will not be the responsibility of the manufacturer.
- Always store equipment properly when not in use.
- Fix damage to unit and replace any broken parts immediately.

Battery Safety



WARNING: BATTERIES CONTAIN EXPLOSIVE GASSES. SHIELD EYES. EXPLOSIVE GASSES CAN CAUSE BLINDNESS OR INJURY. SPARKS, FLAMES OR LIT CIGARETTES SHOULD BE KEPT AWAY FROM BATTERIES. SULFURIC ACID WITHIN THE BATTERY CAN CAUSE BLINDNESS. IF AN ACCIDENT OCCURS FLUSH EYES WITH WATER AND SEEK MEDICAL ASSISTANCE. DO NOT CHARGE BATTERIES WITHOUT PROPER INSTRUCTION. NOTE: THE ABOVE WARNING IS BASED PRIMARILY ON FLOODED BATTERIES, ALL PROGRESS SOLAR UNITS USE AGM SEALED BATTERIES BUT THE PRECUTIONS MAY STILL BE RELEVANT IF CASE IS PIERCED.

- DO NOT ATTEMPT TO CHARGE A FROZEN BATTERY. ALLOW BATTERY TO WARM TO 60°F (16°C) BEFORE CHARGING TO AVOID EXPLOSION AND SERIOUS INJURY TO BODY OR PROPERTY.
- WEAR SAFETY GLASSES WHEN WORKING WITH BATTERIES.
- ALLOW FOR VENTILATION. DO NOT BLOCK VENTS ON UNIT.



- MAKE SURE ALL CONNECTIONS ARE TIGHT. DO NOT OVER-TIGHTEN CONNECTION ON THE BATTERY TO DETER DAMAGE TO TERMINALS OR BATTERY CASE.
- DO NOT LEAVE THE BATTERY ON A SHORE CHARGER FOR MORE THAN 72 HOURS.
- BATTERIES SHOULD BE KEPT CLEAN AND FREE FROM ANY CORROSION. USE A CORROSION DETERRENT SPRAY ON THE BATTERY TERMINALS TO ENSURE LONGER LIFE.
- IT IS CRITICAL THAT THE MPPT CHARGE CONTROLLER BE USED TO HELP REGULATE THE BATTERY FROM OVER AND/OR UNDERCHARGING. IF NOT THIS WILL SIGNIFICANTLY REDUCE THE LIFE OF THE BATTERIES.

Controller Safety

CHARGE CONTROLLERS CAN NOT GET WET

- ALWAYS KEEP CONTROLLERS DRY AND COVERED FROM ELEMENTS. CLOSE DOORS WHEN NOT ACCESSING ANY INTERNAL COMPONENTS.

SOLAR PANEL OR BATTERY REMOVAL / INSTALLATION SEQUENCE

- SOLAR PANELS MUST BE DISCONNECTED FROM THE CONTROLLER FIRST, BEFORE ANY WORK CAN BE DONE ON THE CONTROLLER OR BATTERIES.

Serial Number & Model Number Locations

- Serial Number (VIN#) and Model numbers are attached on the lower portion of the front or back of the unit.



Standard Features & Specifications

Progress Solar™ & Solar/Wind™ Light Tower (Towable)

SHYB and SHYB(W) Series

SOLAR, WIND & AC POWER GENERATORS & STORAGE

- **Power Generation – Solar & Wind Power w/ Critical Elements to Maximize Power**
 - Two monocrystalline solar arrays housed on two solar wings. Each solar array is made up of one or multiple solar modules x 2 solar arrays
 - The 2 adjustable solar wings use actuators to raise, lower and stabilize the 2 solar wings mounted on each side of the unit at angles required to function on each side. When deployed, these angles allow operators to optimize solar wings to any geographic area latitude from either side of the unit; and for travel, position both solar wings out of harm's way.
 - 5 outriggers/jacks stabilize the unit during high wind.
 - Each solar wing housed on each side of unit facing out and hinged at the top. This minimizes any potential damage in the transit (travel position) while maximizing solar exposure (optimal latitude) in the deployed position from either side of the unit. The hinge height on the solar wings specifically prevents shade from any adjacent vehicles or equipment. If your unit has additional foldout hinges on the sides (SHYB 800, 1000, 1200, 2800) then you when stored you must unfold the wings to allow all panels to be exposed to sunlight to get effective charging. ***Positioning solar arrays at optimal latitude and eliminating shade over the unit are critical for performance and prevent permanent damage to batteries.***
 - The Optional Wind Turbine adds additional power up to 200W at speeds greater than 7mph. This helps power the unit 24hrs/day especially when sun is down and in inclement weather.
 - Hybrid Back-up power generator with use of auto start controller. Generator used only to recharge battery bank up past bulk stage, when batteries full below a set battery voltage. Diesel or Dual Fuel (Propane/Gasoline).
- **Power Storage & Backup AC Charger**
 - 24 Volt DC deep-cycle, battery bank comprised of AGM (sealed, no maintenance) batteries (most units); 800aH (>=780-830aH) (optional 1200aH) capacity of battery bank.
 - For Backup AC Charging Power – U.S. 110-120VAC/20amp (ex U.S. 220-240VAC/20amp), 50/60Hz dual AC rapid-charger capable of charging up to 40aH to 24VDC battery bank using generator or any other standard 20amp commercial electrical source. Lights can be operated while batteries are being charged
 - Battery State-Of-Charge Meter – Incremental display of battery charge
 - 50 ft, 20amp electrical cord to use with AC battery charger



Light Tower & Control Module

- Multi-stage light tower that can expand from ~8' to 23' (standard size).
- Wind turbine option must be housed on same mast assembly and extends ~2' above lights
- Photocell – Activates lights in darkness when turned on
- Automated Light Timer / Charge Control Module
 - Light Timer(s) to enable automated, timed interval (optional photo-sensor) or manual lighting start/stop times (independent from solar panels)
 - Maximum Power Point Tracking (MPPT) charge controller(s) to maximize solar power gained and to prevent over or under charging of batteries. Performance data from the charge controllers can be downloaded. Low Voltage disconnect is used to protect batteries.
 - Breakers to protect service personnel, solar wings, lights and electrical systems
 - Temperature controlled cooling fans provided

Note: LED pupil lumens (scotopic) appear brighter than (photopic) foot candle measurements indicated when compared directly to high intensity discharge lighting (like metal halide or high-pressure sodium).

Customized Trailer & Housing

- Durable, steel vented housing customized to store, protect and maximize functionality of power generation, power storage and light tower components
- Towing weight – ~2500 to 3900lbs depending on model
- 5 outriggers/jacks
- Jack on Tow Bar
- Towing specifications & requirements –tongue weight - est. 120-220 lbs.
- Pintle lunette ring coupler OR optional 2" ball coupler
- Forklift guides
- 4 "D" rings/unit used to secure unit during transportation
- Lockable battery and storage compartment within unit housing



Components

Solar Array



Solar Arrays consisting of Mono- Crystalline Solar Modules housed on two Solar Wings with Electric Actuators.

Tele-Struts



Tele-Struts - Used to stabilize solar wings during high winds, with use of Tele-tabs and pins. Included in units that have the high-wind package.



Power Storage Module

24VDC sealed, AGM (no maintenance), Deep-Cycle, Rechargeable Batteries
 Typically, ~800aH wired as a 24VDC system.

Other battery configurations are available.



Control Box



Front Control Box (Top Half)

Remote Meter(s) 'TriStar' for MPPT Charge Controllers to allow users to view charging performance in real time. Some models use a Victron Meter.

Light Control Switch - Three-way switch. Set to the left and it turns on the Timer/Manual light control. Set to the right and the Photocell is turned on (turns on when dark). Set switch to the center and it turns lights off.

Light Timer(s) to automatically or manually turn lights on/off

Light Hour Meters(s) to record actual hours of lighting

Wind Turbine Control Switch to turn wind power On, Neutral or Brake (Off) (if applicable)



Front Control Box (lower Half)

Breaker(s) to engage or disengage electrical circuits
(up is ON, down is OFF)

Battery State-Of-Charge Meter
to enable visual real time
visualization of available power
(not shown).

Solar Wings – Use rocker
switches to automatically raise
and lower solar wings using
actuators

USB Cables to enable download
of performance data from MPPT
Controllers to your laptop

Back side of control Box
(Within Battery Storage Area)
MPPT Charge Controller(s)
AC Charger ‘On Shore’ (Back-Up)

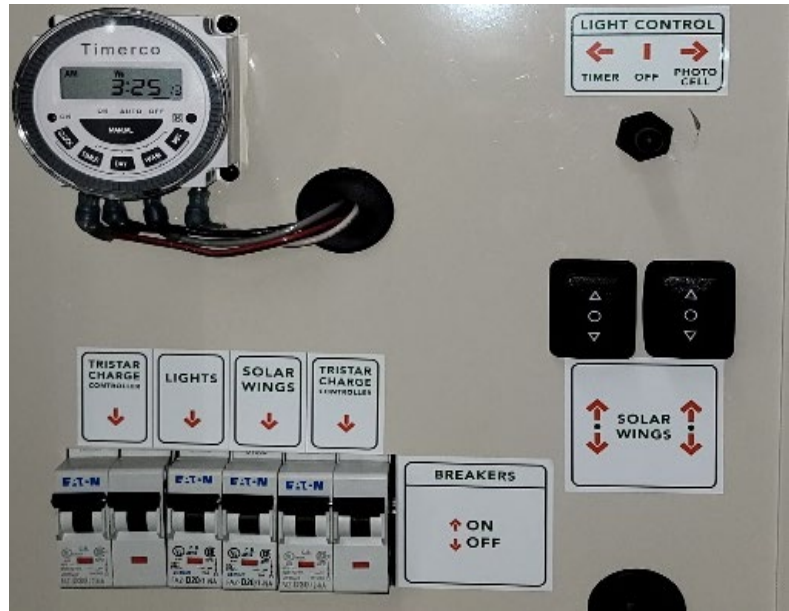

Auto Start Controller (DYNAGEN) for Backup Generator (Hybrid Models)



Dynagen - Used for Operation of the generator

Off - The engine cannot be started; “Not in auto start”

Auto - The engine waits to receive a start single “Waiting to start”

Run – Manual start

For more information refer to the Dynagen user’s manual



Trailer & Housing



Outriggers/Jack Stands - to level unit and support the raised light tower mast. Deploy outriggers/jacks for stability. Located at the front (optional), rear and tongue of the trailer to provide stability while light tower is deployed.

Tongue Jack Stand- Jack stand is used to level and support the tongue and enable attachment / detachment of the light tower to a vehicle for towing.

Lunette Ring or Ball Hitch - Coupler attaches trailer to vehicle. Make sure vehicle hitch and coupler are a match and trailer is securely attached to vehicle.

Safety Chain(s)- Safety chain attaches to vehicle towing the trailer.



Light / Brake Quick Connects- 7 pin or 4 pin Quick connects attach wiring of trailer lights and brakes to towing vehicle.



D-ring Tie-Down Points- Used to secure tower with straps / chains in order to apply equal force to both ends of the light towers if transported via a flat-bed truck or trailer while in tow. Locations vary by model.



Light Tower

LED Light Module / Tower / and Optional Wind Turbine

Solid-State LED Flood Lights – Each light can rotate 360 Degrees and tilt up or down

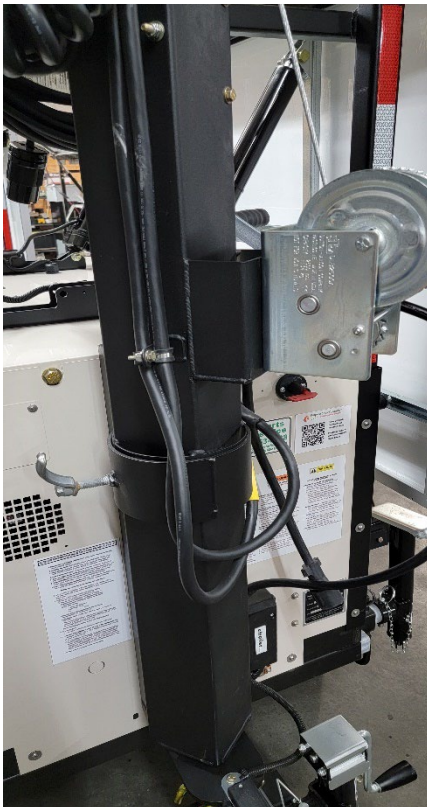
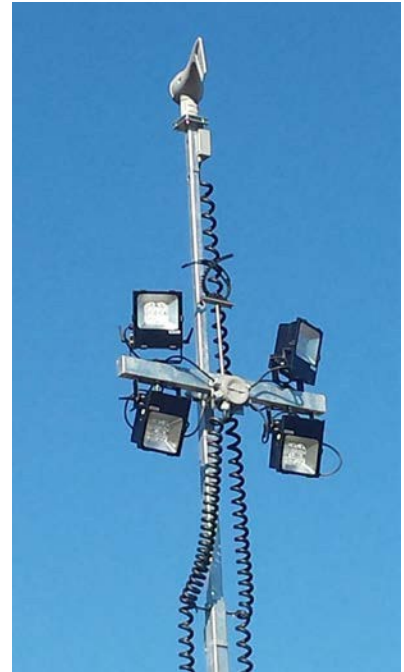

Tower:

Tower Extension Winch- This self-braking winch extends the mast to the desired height, up to ~23' for most models

Tower Rotation- Tower can rotate to approximately 180 degrees using tower pivot ring to provide optimum angle for your lights



Inspection Checklist

PREPARE FOR USE OF PROGRESS SOLAR™ or SOLAR/WIND™ LIGHT TOWER

Never put into use or deliver any unit that has been damaged or has missing decals. Replace any safety or instructional decals that are difficult to read. Inform the end user how to safely operate the unit as stated by the operator manual. Always include an operator manual with the sale or use of the any series light towers for safe operation.

Check List

- Inspect all areas of the unit to ensure that safety stickers and decals are present.
- Inspect the light tower and mast (winches, pulley and cable systems) for proper operation. Replace winch cables as needed if frayed, worn or damaged in any way to insure safe operation.
- Inspect the towing equipment for proper operation or damage.
- Inspect the outriggers and standing jacks for correct operation.
- Check light fixtures for damage and proper operation.
- Inspect wiring connections to insure proper connection.
- Inspect control buttons for correct operation.
- Check air pressure in tires and monitor their condition.
- Make sure the Operator Manual is with the equipment.
- Inspect and tighten any / all loose nuts or connectors
- Inspect trailer, wheels, and tires for damage.



Operating Instructions

Transport & Towing

- Close solar wings completely into down position tightly against the sides of the unit before transit. Secure all latches and connectors prior to transit.
- Lower light tower down to its lowest position. It is optional but encouraged to turn flood lights so they are pointing down and turn light bar to parallel with hitch direction to reduce drag during towing.
- Retract all jack stands and outriggers except the tongue jack and make sure they are properly stowed and outrigger pins locked for transit.
- Position vehicle ball under trailer connector. Crank down (counter-clockwise) tongue jack to lower trailer.
- Place coupler over ball (or lunette ring if applicable) and secure the unit to towing vehicle.
- Stow tongue jack to raised/locked position for transit. Lower jack by turning (counter clock-wise) the side mounted crank. Pull lock pin out and rotate jack to the horizontal position, parallel to trailer tongue and release lock pin. Make sure spring lock pin is completely inserted in correct hole.
- Attach safety chains and allow adequate slack (chains should not drag ground).
- Attach brake and light quick connects to towing vehicle.
- Check for loose debris hanging from the trailer.
- Check tire air pressure and tire condition. Tighten any lug nuts that may be loose.
- Make sure all lock pins (especially outriggers and jacks) are correctly inserted.
- Make sure license plate is attached and current (where required).



WARNING: MAKE SURE TRAILER HITCH AND BALL ARE CORRECT SIZES. SECURE THE TRAILER CORRECTLY TO TOWING VEHICLE.



WARNING: FOLLOW ALL LOCAL AND STATE SPEED LIMITS AND D.O.T LAWS WHEN TOWING A TRAILER. SLOW DOWN AND BE ESPECIALLY CAREFUL DURING WHEN MAKING SHARP OR SUDDEN TURNS

Before getting started inspect the entire unit for loose debris or damaged parts. Get acquainted with the safety and instructional decals located on the unit.



Setup

Light Tower Operation

1. Read Operator's Manual before starting.
2. Park the unit with the tow tongue facing east or west. This will allow the solar wings on either side to be raised to face the sun (solar south in Northern Hemisphere) and maximize solar gain as the sun rises in the east and sets in the west. It is not necessary to readjust during the course of the day. **NOTE: Smart phones typically have a compass function to assist you in orienting solar panels to the south.**
3. Disconnect the safety chains and lights from the towing vehicle.
4. Unhitch the portable solar light tower from the towing vehicle. Raise the tongue jack (clockwise) into position (perpendicular to ground). Take out the hitch pin and maneuver the tongue off of the towing vehicle.
5. Extend all outriggers and jack stands to level and stabilize the trailer and housing unit before raising the tower. Use all jack stands to level the entire trailer.



WARNING: A SUPPLEMENTAL GROUND ROD IS AN AVAILABLE DEVICE THAT CAN REDUCE THE LIKELIHOOD OF INJURY CAUSED BY A STRAY ELECTRICAL CURRENT OR LIGHTNING STRIKE. WE SUGGEST USING THIS PRECAUTIONARY DEVICE TO HELP PREVENT ELECTRIC SHOCK. IT IS THE RESPONSIBILITY OF THE USER TO COMPLY WITH NATIONAL, STATE AND LOCAL ELECTRICAL CODES THAT GOVERN THE GROUND ROD.



WARNING: OUTRIGGERS ARE TO STABILIZE THE UNIT AND NOT DESIGNED TO LIFT THE TIRES OFF OF THE GROUND. DO NOT ATTEMPT TO MOVE THE UNIT WHILE OUTRIGGERS AND JACKS ARE DEPLOYED. SERIOUS DAMAGE TO THE EQUIPMENT WILL OCCUR.

6. Adjust the solar wings to face solar south which optimizes solar absorption. The sun should hit the solar wings at a 90° angle ideally. Use the arrow keys located in the control box at the front of the unit to adjust the angle of each solar wing to area latitude or 35°-40° if unknown.



CAUTION: MOVING PARTS HAZARD: PROTECT HANDS AND LOOSE CLOTHING FROM SOLAR WINGS WHEN CLOSING AND OPENING.

7. While the tower is in the down position, adjust (tilt, rotate) the LED flood lights so they illuminate the desired area once the mast is raised.
8. Make sure the area around the unit is clear of any electrical lines or other interfering items before raising the mast.



! DANGER: ALWAYS MAKE SURE THE AREA ABOVE THE UNIT IS CLEAR OF TREE BRANCHES, BUILDING OVERHANGS, POWER LINES OR ANY OTHER OBSTRUCTIONS. CONTACT WITH SUCH OBSTRUCTIONS COULD RESULT IN PROPERTY DAMAGE, SERIOUS INJURY OR DEATH.

! WARNING: PRIOR TO RAISING THE LIGHT TOWER, MAKE SURE THE WIRING IS NOT TANGLED. INJURY AND PROPERTY DAMAGE COULD OCCUR.

9. Raise the tower by cranking the hand crank to desired height.
10. Rotate mast: loosen lock screw, turn the mast in desired direction.
11. Lower the tower by cranking the hand crank in the reverse direction. Rotating mast sideways can reduce drag on vehicle at high speeds.

! WARNING: UNDER NO CIRCUMSTANCES SHOULD THE UNIT BE MOVED WHEN THE TOWER IS IN THE VERTICAL POSITION.

Automated Light Timer Operation & Manual On/Off

The Light controls and light timer are located inside the control box. This component regulates light times and prevents over discharging of the batteries

The Progress Solar Light Tower provides a Light Timer to operate the lights and manage power consumption.



The Light Timers allow the user to set specific clock times for the lights to turn on/off automatically (unattended by operator). Multiple on/off times can be set per night and they can vary by day of the week if desired. Naturally any times can be used and can change as needed. This will automatically turn lights on when you need it but conserve energy by turning the lights off when they are not needed. This is helpful year round for user convenience, but this is also especially helpful during the winter months when the days are short (less solar energy is available) and the nights are the longest.

Examples:

- In a parking lot, you can set the Light Timers to turn on at 7pm and go off at 11pm and then turn back on at 5am and off again at 7am.
- For a job site, you can set the Light Timers to come on at 8pm and go off at 4am Mon through Friday if that is the work shift. Saturdays and Sundays can be set differently to remain off if there is no work activity.



- For entertainment or sporting events, you can set the Light Timers to turn on the lights from 6pm until 11pm or for whatever times fit your purpose.

If you want to start earlier than the automated timer setting, you can always manually turn the Lights on with the Timer by pushing the manual key until the red light comes on, and then push the key a second time to return it to automatic. The lights will turn on instantly and the lights will turn off at the designated off time automatically.

Setting the Clock and Programming the Timer

- 1) Set the Clock for the current Day of the week and Time.
Press and hold CLOCK and then press DAY key, HOUR key, MIN key respectively to adjust clock to the accurate day and time.
- 2) Program the Timer for desired On/Off - Days and Time settings
 - a) Press the TIMER key, LCD screen will show 1^{ON} --. -- --
 - b) Press the DAY key to select any combination of 15 Daily Programs based on your needs. Continue pressing DAY key to alternate among 15 combinations until you see the one of interest.

1) MO TU WE TH FR SA SU	9) MO TU WE TH FR
2) MO	10) SA SU
3) TU	11) MO TU WE TH FR SA
4) WE	12) MO TU WE
5) TH	13) TH FR SA
6) FR	14) MO WE FR
7) SA	15) TU TH SA
8) SU	

- c) Press HOUR and MIN respectively to set desired Hour and Minute setting for your 1st On time (1^{ON})
- d) After finished setting of 1^{ON} , Press TIMER key again, LCD screen will show 1^{OFF} --. -- --
- e) Press DAY key, repeat Programming procedure “2” to select Day-combination of interest. Note: The Day-combination in each ON/OFF program period must be consistent
- f) Press HOUR and MIN respectively to set desired Hour and Minute setting for your 1st OFF time (1^{OFF})



- g) When finished setting 1^{ON} and 1^{OFF}, if desired, you can Press TIMER again and repeat to set your 2nd set of ON/OFF times 2^{ON} then 2^{OFF}, etc. You can set up to eight (8) ON/OFF settings per night if desired.
 - h) When finished program setting (event) press CLOCK (finalizes program). Timer shall start to execute program(s).
- 3) To review programs
Press TIMER to alternate and display each setting on the LCD screen.
 - 4) To operate, Press MANUAL to select ON, AUTO or OFF setting mode. Note a will appear under ON, AUTO or OFF to designate current operating mode and will cycle if you press MANUAL.
 - a) The manual ON and OFF temporarily override the AUTO (automatic setting that you set in #2 above). It is recommended to set your TIMER, turn it to AUTO (automatic) and it will operate as requested. For days that you want to override the AUTO setting simply press MANUAL turning the light On (LED will also turn red) and then push MANUAL one additional time to AUTO again. The light will then turn on instantly as requested and will still turn Off at its established automatic Off time.
 - 5) To Reset, press X on controller to clear previous settings

Note: The Light Timer uses a Lithium CR2032 battery and is within a compartment on the back of the timer.

Battery State-of-Charge Meter Operation

The Battery State-of-Charge Meter(s) are standard with SHYB & SHYBW units. The meter is located inside the frontcontrol box. This component provides the SHYB/SHYBW operator an easy-to-understand visual display indicating the current battery state-of-charge at a glance.



The operator sees the current charge levels in increments to maximize battery life, it is best to limit your discharge rate to no lower than 30% of the capacity of the battery bank and to fully charge the batteries on a routine basis. This charge can be achieved by either or a combination of solar gain or with an on-board backup electric (AC) battery charger.



HYBRID BACKUP GENERATOR OPERATION (DYNAGEN)

1. The generator is operated by the DYNAGEN in the Control Box
2. Primary purpose of generator is to charge battery bank.
3. Generator may be run to provide AC power; however, is preferable to pull AC power from battery bank using the inverter/charger option instead of running generator for AC power.
4. All circuit breakers must be in ON position
5. Ensure Generator is turned to ON where applicable (consult Generator Manual – different brand generators have different configurations)
6. Ensure generator has fuel and proper maintenance and fluid levels prior to operation. Ensure fuel is not stale.
7. DYNAGEN has three Buttons ON / AUTO / OFF
 - a. OFF – Turns Generator off. Generator will not run
 - b. AUTO – This setting is where Generator should usually be set to. DYNAGEN is programmed to automatically sense low voltage in the battery bank and run for 4 hours on low voltage to charge up batteries.
 - c. ON – manual running of Generator. Do not use this functionality for more than 15 minutes when battery bank is fully charged and AC power is not being pulled from generator. This can cause damage to the unit.

Maximum Power Point Tracking (MPPT) Controller Operation

The MPPT Controllers are located inside the control box. The component is an advanced maximum power point tracking (MPPT) solar battery charger and load controller for stand-alone off-grid photovoltaic (PV) systems.

This controller features a smart tracking algorithm that maximizes the energy from the solar module(s) and also provides load control to prevent overcharging or over-discharging of the batteries. Each controller runs independently and each one is interconnected with a 24VDC bank of batteries, a group of 24VDC floodlights, and a user controllable timer for the lights. The only routine interaction a user needs to have is to observe performance characteristics and real time status. USB cables are available in the bottom of the front control box to enable the user to download historic performance data.

- The advantage of the MPPT technology is typically an overall increase “boost” in the solar charge current flowing out to the battery to help them recharge faster, when compared to other light/charge controllers.
- The battery status LEDs provide approximate battery state-of-charge indication and also indicates when a system or load fault condition exists.
- The light tower lights are controlled automatically through the automated Light Timer(s). See that section for operating instructions.



AC Battery Charger Operation (aka Shore Charger)

The cable is coiled on the skeleton of the frame with either a 15 or 20 amp three prong plug. The battery charger is located inside the main housing unit and allows the operator to provide a rapid charge to the unit's battery bank. This method is designed as a backup or secondary way of charging the batteries. The primary method to charge the batteries is through the solar arrays and with a wind turbine (if applicable). However, depending on your geographic location, and solar irradiation, there may be times of the year when having a backup is helpful.



This option is especially useful for those with heavy system utilization, especially during long winter nights (heavy use) and short winter days (low solar gain) or to obtain a rapid charge for a same day rental / use for a system that has been previously charged.

For SHYB/SHYBW systems the backup battery charger is standard, the systems are prewired and ready to use. Note: SHYB/SHYBW come equipped with AGM, no maintenance, sealed batteries. The charger will come configured correctly for the type of batteries installed.

To Operate:

For a standard unit:

The charger plug is hardwired to the unit. You will find the male plug end, (as seen in picture) wrapped around the cord wrap. Plug this into your local AC power source using a 20amp outlet. The Charger is pre-set to an input or either 120VAC (for U.S.) or 230VAC (ex U.S., 50/60 Hz, 20A. Call if you want to change it.

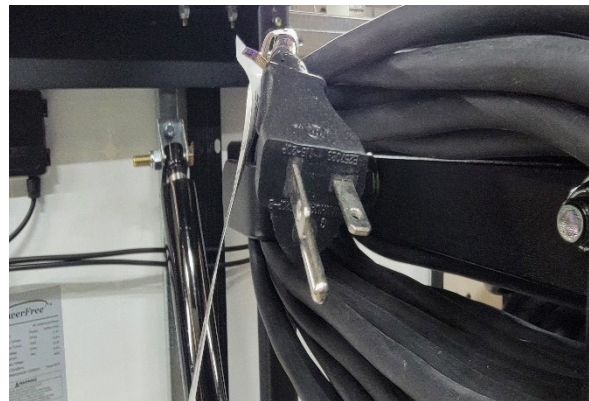

- 1) Turn the Charger power on. This should be the default setting, it is recommended to leave it in the on position. To check open door under solar wing; Charger is on back wall or mounted above batteries. Power switch is on right side of Charger unit.
- 2) The Charger will automatically start its 3 stage (bulk charging, absorption, and float), temperature compensated charging.
 - a. Bulk constant charge
 - b. Timed Absorption/Boost



c. Float/Maintenance or “Trickle” Charge

Optional Inverter/charger:

If equipped, there is a 30amp twist lock plug located on the Drivers side of the unit, near the front (see picture). Use the provided power cord that is wrapped around the cable wrap to connected the female end to the unit and the male end to shore power.

1. Make sure the inverter is on.
 - a. Open the control box door in the back of the unit.
 - b. Push and hold the power button on the inverter/charger controller come on
2. Once on the charger will start charging the battery bank.



Notes:

- Batteries must be recharged routinely either by solar and wind power or by the back-up electric AC battery charger.
- Batteries should not be charged with an AC battery charger when the batteries are frozen.
- Batteries are typically more efficient (charge faster) but provide less battery capacity during low temperatures.
- Batteries typically recharge more quickly when the depth of discharge is kept to a minimum (20-50%) instead of a deep discharge of 60-100%.



Maintenance Program

Your solar light tower should be maintained at all times understanding its current usage and location is very important. A unit in active use (kept outside where the panels are able to see receive regular solar charging) and units that are kept in a location where they cannot receive regular solar charging must be monitored with the batteries in mind.

ACTIVE USE SPECIFIC CHECKS (Solar panels able to see sun on a regular basis)

1. Control Box (Breakers & Controls)

- a. Frequency: Check once per week at a minimum.
- b. If equipped, ensure external Battery Disconnect is in the ON position.
- c. Ensure all breakers are ON so unit is able to charge when sun is available
- d. Check voltage level reported inside control panel. Ensure Voltage is between 24 and 30 Volts. If not, unit needs charging either by improved exposure to the sun during the day, or by using the Shore Power AC charger. Charge unit back to full to protect and maintain batteries.
 - i. For solar charging, position so both panels can face South without shade throughout the day. Refer to setup guide, setup video, and solar best practice sticker on inside of door for optimal panel angle for region and season.
- e. If Toggle Switch is not positioned in "Timer" mode as method of operation, ensure the Timer is set to OFF.
- f. Follow Routine Walk Around Visual Inspection and Maintenance (below)

LONG TERM STORAGE SPECIFIC CHECKS (No sunlight available to unit)

1. Control Box (Breakers & Controls)

- a. Frequency: Check once every 30 days at a minimum.
- b. If equipped, ensure external Battery Disconnect is in the OFF position
- c. Ensure all breakers are OFF so unit does not drain battery due to small component consumption and inability to re-charge from sun.
- d. Check voltage level reported in control panel (may require breakers and Battery Disconnect to temporarily to be turned ON). Ensure Voltage is between 24 and 30 Volts. If not, unit needs charging either by exposure to the sun or by using the Shore Power AC charger. Charge unit back to full to protect and maintain batteries.
- e. Follow Routine Walk Around Visual Inspection and Maintenance (below)

Walk Around Visual Inspection and Maintenance

1. Note damage of any sort and address / replace any damaged parts

- a. Trailer –
 - I. Mend brake light quick connect wiring if wires become stripped or exposed.
 - II. Replace brake lights when needed.
 - III. Keep tires at correct PSI. Replace worn tires.
 - IV. Rinse trailer periodically after traveling through salty conditions.
- b. Solar Wings
 - I. Keep solar modules o optimize solar absorption. Clean by wiping them with a dry cloth with glass cleaner or spraying down with hose or



pressure washer using water. Solar panels will still produce power when dusty and dirty but performance may be diminished significantly.

c. Housing Unit

- I. Clean with pressure washer gently or wipe down
- II. Use damp cloth when cleaning the inside of the unit. Be careful cleaning around batteries and controller components. Make sure to turn internal control box breakers off for any activities within the unit

d. Lights

- I. Inspect for any cracks, breaks or frayed wires
- II. The IP67 light fixtures allow cleaning with water
- III. Clear dirt from lights to optimize light output

e. Tower

- I. Clean with pressure washer
- II. Keep debris out of tower sections that can cause increased friction in sliding joints

f. Batteries

- I. AGM batteries are virtually maintenance free. Do not open caps on top of batteries.
- II. Batteries should not be charged with an AC battery charger when frozen.
- III. Keep batteries clean from corrosion. Remove corrosion by mixing baking soda and water to form a paste. Apply paste to needed area. When the solution stops reacting, the corrosion has been neutralized. Rinse the area thoroughly and clean work area to avoid any environmental issues.
- IV. Replace any defective or damaged batteries.
- V. Properly discard used batteries to permitted recycling/disposal center. It is illegal to improperly dispose of batteries in most states.
- VI. Check voltage in control panel as described above. Solar power, backup generator, or the AC battery charger (aka shore charger) can all be used to maintain charge in batteries. Long term voltage below 24 Volts will permanently damage, reduce performance, and shorten the life of the batteries.

g. Charge Controller and Control Box Wiring

- I. Located inside the control panel behind the controls. Access by opening the hinged face by loosening the screws on the right side of the control panel.
- II. Check for broken, loose, disconnected, or charred wire connections. Tighten all terminals (ensure to de-energize before touching by turning off breakers).
- III. Ensure airflow is not blocked around the controller. Remove any loose debris in the immediate area.
- IV. Keep controller out of a wet environment. Make sure there are no leaks in the control box that may affect the controller.
- V. Check the LED indicators on the controller for correct operation and current settings.

h. Hybrid Backup Generator

- I. Consult brand specific user manual for the generator that is included with unit for necessary maintenance (or find the proper manual online)
- II. Check that wiring connections are connected and wires are not loose or frayed



- III. Ensure exhaust is properly installed and venting out of the unit
- IV. Ensure adequate fuel is in tank and is not stale
- V. Ensure fluids are at proper levels and changed according to manual
- VI. Ensure any cooling fans in generator compartment operate within 30 seconds of unit startup



MANUFACTURER'S WARRANTY

Progress Solar Solutions™, LLC (PSS) warrants that all Progress Solar (SHYB) & Solar/Wind Light Towers (SHYBW) that are manufactured by PSS will be free from defects in material and workmanship for a period of **2 years** after date of delivery to first purchaser.

The warranty covers parts (tires excluded) where correct installation, setup, maintenance and operation have been applied. Normal wear and tear excluded. Operation must be kept within the limit of normal usage and any intentional or neglectful actions or inactions will void this warranty. The warranty specifically covers parts manufactured directly by PSS (no-labor). PSS warrants any replacement parts supplied to be free from defects in material and workmanship for a period of 90 days after documented purchase. Delivery will be considered, for this warranty, to take place five days after original purchase date if not stated otherwise in purchase agreement. This warranty covers the first purchaser. Any retail or wholesale entities will not be considered the first purchaser. The first purchaser is, for this warranty, to be the entity who puts the product into use. The warranty period will start when product is in use by the first purchaser.

Throughout the warranty period, any defective or malfunctioning parts will be replaced at the discretion of PSS. For any products that may need to be returned, transportation must be prepaid to PSS. PSS will not be liable for any losses incurred such as labor costs, loss of profit, down time, third party repairs or personal injury or travel. The sole duty of this manufacturer is to repair or replace defective equipment manufactured by PSS. The remedies here are exclusive to product service and replacement of damaged equipment due to manufacturing defects in workmanship. Any indirect damages are no obligation of PSS.

Remedies paid will not exceed the price of the product or parts under liability of warranty. PSS makes no warranty to cover parts, lights, batteries, tires or other components that have been altered, changed or improperly installed, operated or maintained. Any component repaired under the direct supervision of PSS or by PSS is covered under warranty. To keep products maintained correctly, read the Operator Manual for proper instruction. No person is authorized to make changes or exceptions to this warranty unless authorized in writing by the manufacturer. Buyer must send written notice of defect within **30 days** in order to make a warranty claim.

THIS WARRANTY IS IN LIEU OF AND EXCLUDES ALL OTHER WARRANTIES, EXPRESSED OR IMPLIED (INCLUDING ANY WARRANTY OF MERCHANTABILITY AND FITNESS OF ANY PRODUCT OR GOOD FOR A PARTICULAR PURPOSE) AND ANY EXCEPTIONS ARE STATED BY MANUFACTURER. PARTS, SUB-ASSEMBLIES OR ADDITIONAL COMPONENTS THAT ARE MANUFACTURED BY OTHER MANUFACTURERS ARE NOT COVERED UNDER THIS WARRANTY. SUCH WARRANTIES WILL ACCOMPANY OR COME WITH THE PRODUCT.

Progress Solar Solutions™, LLC 1108 N New Hope Rd, NC 27610 Toll Free: 888-298-6657 Phone: 919-363-3738 Fax: 919-924--0184 www.ProgressSolarSolutions.com



Manufacturer Certification Label Example

Manufactured By:	
Progress Solar Solutions LLC.	
1108 N New Hope RD, Raleigh,	
NC 27610	
Oct 2020	
GVWR	1034 KG (2280 LB)
GAWR	588 KG (3500 LB)
TIRES	ST205/75 D 14
RIMS	14X5.5 JJ
COLD WEATHER INFL	354 kPa (50 PSI)
THIS VEHICLE CONFORMS TO ALL APPLICABLE US FEDERAL MOTOR VEHICLE SAFETY STANDARDS IN EFFECT ON THE DATE OF MANUFACTURE SHOWN ABOVE.	
VIN: 1P9B71316AA661001	TYPE: TRAILER





TROUBLESHOOTING GUIDE SLT, SLTW, SHYB MODELS

Tip: New units (2023 and newer) that have Victron components may provide insight by using the Victron App that can connect to your mobile device by Bluetooth. The PIN is always six zeros (000000).

Lights

Q) All 4 of my lights are not working.

- **A) First check circuit breaker:**
 - Set in the ON position (which is UP). Breaker should be showing red which means the system is hot.
- **B) Check Toggle Switch position:**
 - Toggle switch needs to be in the correct position for which component you are trying to use either Timer or Photo cell. Refer to Label above the toggle switch for correct positioning.
- **C) Check the Battery Voltage of the unit:**
 - ***IF Below 23.5 Volts:***
 - Low Voltage Disconnect is set at 23.5 volts to protect the battery bank. Lights will not function below that level, but unit will stay on to allow it to charge.
 - If it is below 23.5 Volts unit needs to be charged. Leave unit in the sun with both sets of panels facing south and ensure the circuit breakers on. AC charging is also available and can be done in parallel with solar charging. If sun is plentiful solar charging is faster.
 - If State of Charge meter (Victron or Delta Fuel Guage) do not read voltage check with a multimeter if qualified person is available.
 - Place it on the main connection for the positive. This will be one of the parallel connections on the batteries and the other lead should be on the main negative parallel connection.
 - If the Battery voltage is close or at the LVD set point (23 - 24.5volts)
 - The Unit has a LVD which will disconnect the lights if the battery voltage goes below the set point.
 - Units LVD set at 23.5 volts:
 - Trick turn off breaker for the lights, this will reset LVD, this allows

you to see if the lights work, if not past the set point.

- Then this would be the reason why your unit's lights aren't working. You will need to charge the unit back up. Either using solar, a/c charger or generator, if possible or equipped with one.
 - You will need to get the resting voltage of the unit above 25.5 volts before the lights will be able to be turned back on.
- ***IF battery voltage is above the 23.5v follow the steps below:***
- **D) Check the connections:**
 - Check the J-Box which is located between the lights. Make sure all connections are free for corrosion and making a clean connection.
 - Check plugs on both ends of the stretching self-coiling cable that runs up and down the tower.
 - **E) Check if you have continuity:**
 - You will want to check the continuity going from the front box going to the lights to make sure you don't have a cut wire somewhere on the 12/4 coil cable.
 - To do this locate the color wires in the J-Box in between the lights. Using 1 lead place it on 1 colored wire and the other lead on the same-colored wire in the control box. You will need a co-worker to help with this and listen for the tone on your multimeter. If you don't hear the tone, then you have a cut wire. You will need to either replace the cable or fix it before the lights will work again.
 - If you have continuity in all the wires, then check continuity in the breakers.
 - To do this, Place one lead of the multimeter on the top side of the breaker and the other one on the bottom side. With the breaker on (up position) you should get a tone. If not then you may have a bad breaker.
 - If you still have continuity read below
 - **F) Check if the voltage is getting to your lights:**
 - If you checked the voltage on the batteries with you multimeter and say you have 26.5 volts DC, then you should be getting 25.5 volts DC to your lights. (1 volt drop because of wire travel) Check the connections inside the J-Box located between the lights for the voltage.

Q) Timer not working?

- **A) Refer to Timer guide with steps on how to setup the timer.**
 - If no lights on are on the timer at all?
 - Make sure the breaker is on (In the UP position)
 - Ensure lights work in Photocell or other manual mode

- Check the battery on the timer. This is located on the back side of the timer itself.
 - Take a picture before disconnecting the wires to the timer so they can be replaced the same way.
 - Remove the 4 screws holding the timer in place.
 - Remove the battery backing and Replace with a new battery and reinstall the timer.

Q) My Tristar controller is reading a fault. What does it mean?

- **A) Refer back to the TriStar owner's manual for fault code.**
 - Troubleshoot from there.
 - Remember if the Tristar is in an error mode it will not allow any solar input to charge the batteries.
 - Try resetting the Tristar.
 - Turn off the breaker, wait for a minute and turn the breaker back on.

Q) Can I charge my unit with a wall outlet or generator?

- **A) Yes, there is an on-board AC battery charger built into your unit.**
 - There is a receptacle located on the rear passenger side that you can plug a power supply to the battery charger.
 - Remember to use a **20amp** circuit if you're getting power from a wall receptacle. The battery charger uses 14 amp of AC current. If you're using a generator, use at least a 3KW (running watts) sized generator.

Q) How long does it take the AC battery charger to recharge my batteries?

- **A) That depends on the depth of discharge of the batterie, size of bank, and if sun is charging the unit in parallel.**
 - The batteries will normally recharge within 18 to 25 hrs. depending on the depth of discharge. (22vdc-24.5vdc). Much shorter if unit is in the sun and able to charge from solar in parallel. Ensure all circuit breakers are on.
 - If your batteries are lower, then the AC charger will take longer to charge the battery bank.
 - **NOTE:** Battery banks that are below **20vdc** may be damaged not come back at all. Therefore, it is very important to keep the solar wings up and breakers on for the solar charge controllers, even when not in use, to maintain the battery bank.

Q) What are some appropriate solar input voltages?

- A) **The solar input voltage will vary depending on what stage of charging your unit is in.**
 - You will see solar input voltages between 80 volts to 12 volts DC. If the unit is in the sunlight, otherwise you may see much lower voltages.
 - It's important to note that it's about the voltage of the solar panels but about the amperage going into your batteries.

Q) The solar panels don't seem to be charging according to the remote meter (if equipped), no wattage showing, is there something wrong?

- A) **No, the Tri-Star remote meter will only display what wattage the batteries are expecting.**
 - Exp: one side of the solar panel is showing 113 watts, the other side pointed in the same direction is only showing 30 watts.
 - This is because the voltage of the battery bank is almost topped off and is only allowing (x) number of solar panels to provide power to the battery bank.

Delta Volt Fuel Gauge

Q) My fuel gauge shows my battery capacity in the RED for several days in a row. Is my unit charging?

- A) **YES, once your fuel gauge enters the RED it will not move back up the LED line till your battery voltage reach's 26 volts.**
- If your unit is working 7 days a week and you're in the Fall Winter months, it's hard for the SLT units to recover enough solar input in one day to get the battery voltage above 26 volts. Read the user manual on the delta-volt for more information on LED color code.
 - The new delta-volt fuel gauges reset themselves every 7 mins to give the customer a better accurate reading of battery capacity.

Wind Turbine (SLTW Models)

Q) How do I know the wind turbine is producing power?

- A) **The wind turbine switch must be in the ON position.**
 - When charging the batteries, the AIR wind turbine **solid led light** will be continuously illuminated, on the bottom side of the tail fan.
- Start up speed is 7mph
- The wind turbine will start producing power at 12mph wind speed and above, up to 49mph.

Q) What does it mean when a green light is flashing once per second?

A: Regulation Mode:

If you see **flashing led light**, once per second, then your wind turbine is in regulation mode.

- This is when the battery voltage reaches it's set point and stops charging the batteries, and the blade rpm will lower dramatically (almost stopping). Meaning the battery bank is fully charged and wind power is not needed at this time.

Q) The led light at the bottom of the wind turbine is flashing 10 times per second, what does this mean?

A: Over Speed Protection:

If you see **Flashing led light**, 10 per second then the wind turbine is in over speed protection mode. The blades will near come to a stop for 30 seconds and then allows them to spin again. This cycle will repeat until the wind speed drops below 50mph and then the wind turbine will start rotating again normally, to produce power, if needed.

Q) What do I do if the turbine is wobbling or shaking more than expected?

- Inspect visually the turbine up close to see if there are any reasons it might be out of balance.
- Check the torque on the bolts per the Simple Checks below.
- Review the Technician Level checks below that involve disassembly of the turbine. Without blades you can manually spin the turbine with a drill to see if it still is out of balance. Replacing the blades could solve the problem if the unit wobbles with the blades on, but does not with the blades off.
- If the turbine continues to wobble or shake excessively or very hard to spin by hand, please Contact Progress Solar Solutions tech support. (919-632-4762)

Additional Simple Checks –

- 1. Ensure the switch in the control box is in the ON position for the Wind Turbine**
- 2. Ensure all the breakers in the Control Box are ON**
- 3. Check for Loose wires, plugs fully seated, visible damage to wires or wire jacketing causing a short or in any way disconnected. The cable runs down from the turbine housing down to a plug into the body. Inside the unit you may be able to visually inspect the wires from the plug to where they terminate.**
- 4. Check the torque on the bolts for the blades to the hub, the torque is 72 in-lb. If they are torqued down too hard, they will affect the performance.**
- 5. Check the torque on the hub to rotor nut, the torque value should be 40 lb.-ft.**

IF the simple checks don't correct the issue try these Technician Level Checks

(these steps should only be performed by a qualified person) -

Tools you will need: Ratchet with 5/16" socket, DC Multimeter with leads, a amp meter and a Drill.

- First open the control box door. Once open at the top right-hand side you will find 2 small 5/16" screws, unscrew them in order to access the breakers from the back side.
- Located the single pole 20-amp breaker. On the back side you will find that it has two red wires going to it, when the breaker is on the circuit will be energized.
- Using your multimeter set in DC voltage, place 1 lead on the top screw of the breaker and the over lead in the negative Wago (connector) feed throughs. See if there is voltage above 24Voltagess coming out, if there is your wind turbine is producing power and working correctly.

Q) What if there isn't any voltage after the first test?

- Take the turbine nose cone off and the blades and place aside.
- Use a 5/16" hex key in your drill. Place this in the hex bolt and use your drill to spin the shaft.
- Below 400 RPM's the rotor should spin freely and the LED light should remain off.
- Above 400 RPM's there should be resistance and LED light should turn on. If there is any bumping, wobbling, shaking or very hard to spin STOP! Please Contact Progress Solar Solutions tech support. (919-632-4762)

Gas/LPG Hybrid Generator (SHYB Models)

Q) Why don't I have any power to my generator?

- A) **Check to make sure the main Disconnect Switch located in the front of the unit is in the ON position.**
 - Check to make sure the light for the generator battery is **ON** and the led indicator is lite up.
 - Check and make sure the toggle switch for the generator itself it in the **RUN** position.
- Once you have checked the above steps locate the Dynagen controller in the control panel. It should be on and will say “NOT IN AUTO, WAITING TO START”

Q) How do I manually start the generator?

- A) **Make sure the generator has the proper fuel type you will be using i.e., LPG or Gasoline.**
- Make sure the Oil is full.
- Then on the Dynagen Auto start controller, push the auto button once then the run button, you will see a count down and then the generator will begin trying to start.

Q) If I manually start my generator, will it turn off with the auto start?

- A) **No, if you manually start the generator you need to manually turn off the generator.**

Q) How to I put the generator in auto start?

- A) **To do this all you need to do it make sure the Dynagen controller is on. (IF it isn't push, the off button and wait for it to load and turn on)**
- After it's on, Simply push the Auto button on the controller and it should now read across the screen “IN AUTO WAITING TO START”.
- Now it's in the auto mode.

Q) My generator is not cranking.

- A) **There could be several reasons why the generator did not crank.**
 - Check that the propane tanks are open and propane tanks have propane.
 - Check to make sure generator toggle switch is in the ON position.
 - Check the breaker on the generator is ON.
 - Check your oil level, generator has a low oil shut-off which will not allow generator to turn ON if oil level is low.

- If you have manually cranked generator and it's not cranking over
 - Check starting battery leads make sure these leads are across the main battery bank for only 12V. The Negative lead should be on the main negative i.e., parallel connection. The positive lead should be in the middle of the battery bank across 12V.
- Check with a multimeter to make sure the starter is getting 12-14 volts only.
- If while using the multimeter you see 15-19 volts or higher, remove the red lead and place it in the correct spot for 12-14 volts. The red lead should be in the middle of the battery bank.
- Try starting the generator without using the auto start controller.
 - To due this use, the toggle switch located on the generator itself and see if it starts.
 - If the generator doesn't start check regulator
 - Open the connection between the regulator and then generator. There should be a small 2-foot hose between the regulator and the generator, open the connection slightly and make sure you hear/smell propane.
- There should be a small cube relay and socket located on the generator, it will have a few green wires, white wires and black wires going to and from it. This relay controls the signal for the auto start controller. Make sure the cube relay is there and isn't blown.
 - If the relay is missing or blown replace and try starting the generator again.

Q) My Dynagen had an error code, "Failure to Start", or "Under Voltage" what may cause this?

- **A) Follow the same procedure listed above.**

Q) My Dynagen had an error code, "Failure to Start", or "Low Frequency" what may cause this?

- **A) Check to make sure you are getting the correct hertz out of the generator (60+ HZ)**
 - If you aren't getting 60+ HZ this is why the generator is shutting down.
 - Check for a plugged or dirty air filter.
 - Check for poor fuel or an almost empty propane tank
 - Reduce the load from the generator, to see if this helps.
 - If you are trying to charge the battery bank and the battery bank is below 20volts or less this will cause the generator to over work past it's limits.
 - Plug the AC (shore power) in and charge the battery bank up past 22Volts dc. This will allow the generator to work within its limits.



Q) I have the generator running but I had to move the choke lever to the left to get it running.

- **A) If you have to close the choke lever to get the generator running, you probably have a leak in the fuel supply.**
- Check all gas fittings and fuel line connections for a leak.

Q) How often do I need to change the oil?

- **A) Every 100 hrs. of use for most generators. Refer to generator manufacturer's manual for your specific generator.**

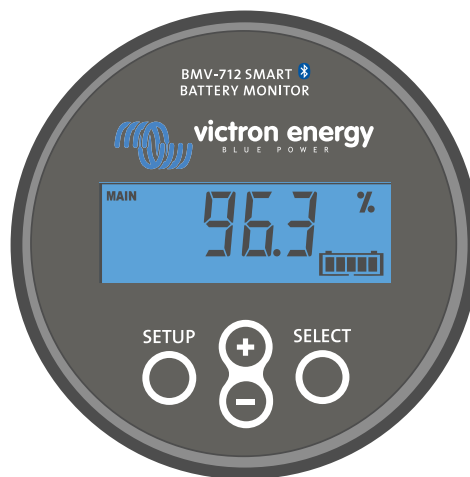

Manual - BMV-712 Smart

Battery monitor

Rev 10 - 12/2022

This manual is also available in [HTML5](#).

Table of Contents

1. Safety precautions	1
1.1. General safety precautions	1
1.2. Battery safety warnings	1
1.3. Transport and storage	1
2. Introduction	2
2.1. The battery monitor	2
2.2. Why should I monitor my battery?	2
2.3. Sizing	2
2.4. The VictronConnect app	2
2.5. Accessories	3
3. Installation	4
3.1. What's in the box?	4
3.2. Mounting the shunt	4
3.3. Mounting the head unit	5
3.4. Connections overview	7
3.5. Basic electrical connections	7
3.6. Auxiliary electrical connections	8
3.6.1. Auxiliary connection for monitoring the voltage of a second battery	8
3.6.2. Auxiliary connection midpoint battery bank monitoring	8
3.6.3. Auxiliary connection for temperature monitoring	9
3.7. Programmable relay	9
3.8. Use of alternative shunts	10
3.9. GX device connection	10
3.10. Wiring for use as DC meter	11
4. Configuration	12
4.1. Setup wizard	12
4.2. Automatic voltage detection	12
4.3. How to change settings	13
4.3.1. Settings via the head unit	13
4.3.2. The VictronConnect app	14
4.4. Update firmware	15
4.5. Make essential settings	15
4.5.1. Set the battery capacity value	15
4.5.2. Set charged voltage value	15
4.5.3. Set state of charge	16
4.5.4. Set the auxiliary input function	16
4.6. Make Lithium settings (if needed)	16
4.7. Configure for use as DC meter	17
5. Operation	18
5.1. How does the battery monitor work?	18
5.2. Readout overview	18
5.3. Using the head unit menus	19
5.4. Trends	19
5.5. History	20
5.5.1. Accessing historical data via the VictronConnect app	20
5.5.2. Accessing historical data via the head unit	21
5.5.3. History data	22
5.6. Alarms	22
5.7. Synchronising the battery monitor	23
5.7.1. Automatic synchronisation	23
5.7.2. Manual synchronisation	23
5.8. Operation as a DC meter	24
6. Interfacing	25
6.1. VictronConnect app via USB	25
6.2. Connecting to a GX device and the VRM portal	25
6.3. Connecting to VE.Smart networking	26
6.4. Custom integration	27

7. All features and settings	28
7.1. How to change settings	28
7.1.1. Accessing settings via the head unit	28
7.1.2. Accessing settings via the VictronConnect app	28
7.1.3. Saving, loading and sharing settings in VictronConnect	28
7.2. Battery settings	28
7.2.1. Battery capacity	28
7.2.2. Charged voltage	29
7.2.3. Discharge floor	29
7.2.4. Tail current	29
7.2.5. Charged detection time	29
7.2.6. Peukert exponent	29
7.2.7. Charge efficiency factor	30
7.2.8. Current threshold	30
7.2.9. Time-to-go averaging period	30
7.2.10. Battery starts synchronised	30
7.2.11. State of charge	31
7.2.12. Synchronise SoC to 100%	31
7.2.13. Zero current calibration	31
7.3. Relay settings	31
7.3.1. Relay mode	31
7.3.2. Invert relay	32
7.3.3. Relay state	32
7.3.4. Relay minimum closed time	32
7.3.5. Relay off delay	32
7.3.6. Low State of Charge (SoC) relay	32
7.3.7. Low voltage relay	33
7.3.8. High voltage relay	33
7.3.9. Low starter voltage relay	33
7.3.10. High starter voltage relay	33
7.3.11. Low temperature relay	34
7.3.12. Mid voltage relay	34
7.4. Alarm settings	34
7.4.1. Alarm buzzer	34
7.4.2. Low SoC alarm settings	34
7.4.3. Low voltage alarm	35
7.4.4. High voltage alarm	35
7.4.5. Low starter voltage alarm	35
7.4.6. High starter voltage alarm	36
7.4.7. High temperature alarm	36
7.4.8. Low temperature alarm	36
7.4.9. Midpoint deviation alarm	36
7.5. Display settings	36
7.5.1. Backlight intensity	36
7.5.2. Backlight always on	36
7.5.3. Scroll speed	37
7.5.4. Main voltage display	37
7.5.5. Current display	37
7.5.6. Power display	37
7.5.7. Consumed Ah display	37
7.5.8. State of charge display	37
7.5.9. Time-to-go display	37
7.5.10. Starter voltage display	38
7.5.11. Temperature display	38
7.5.12. Mid-voltage display	38
7.6. Miscellaneous settings	39
7.6.1. Software version	39
7.6.2. Restore defaults	39
7.6.3. Clear history	39
7.6.4. Lock setup	39
7.6.5. Shunt current	40
7.6.6. Shunt voltage	40
7.6.7. Temperature unit	40
7.6.8. Temperature coefficient	40
7.6.9. Aux input	40
7.6.10. Battery starts synchronised	40
7.6.11. Bluetooth mode	41
7.6.12. Monitor Mode	41
7.7. Additional settings	41
7.7.1. Reset history	41

7.7.2. Reset PIN code	41
7.7.3. Temperature unit setting	41
7.7.4. Serial number	42
7.7.5. Disabling and re-enabling Bluetooth	42
7.7.6. Changing PIN code	42
7.7.7. Custom name	42
7.7.8. Firmware	42
7.7.9. Reset to defaults	43
8. Battery capacity and Peukert exponent	44
9. Midpoint voltage monitoring	46
9.1. Battery bank and midpoint wiring diagrams	46
9.1.1. Connecting and monitoring midpoint in a 24V battery bank	46
9.1.2. Connecting and monitoring midpoint in a 48V battery bank	47
9.2. Midpoint deviation calculation	48
9.3. Setting the alarm level	48
9.4. Alarm delay	48
9.5. What to do in case of an alarm during charging	48
9.6. What to do in case of an alarm during discharging	49
9.7. The Battery Balancer	49
10. Troubleshooting	50
10.1. Functionality issues	50
10.1.1. Unit is dead	50
10.1.2. Auxiliary port not working	50
10.1.3. Unable to change VictronConnect settings	50
10.2. Connection issues	50
10.2.1. Cannot connect via Bluetooth	50
10.2.2. PIN code lost	51
10.3. Incorrect readings	51
10.3.1. Charge and discharge current are inverted	51
10.3.2. Incomplete current reading	51
10.3.3. There is a current reading while no current flows	51
10.3.4. Incorrect state of charge reading	52
10.3.5. State of charge is missing	52
10.3.6. State of charge does not reach 100%	52
10.3.7. State of charge always shows 100%	53
10.3.8. State of charge does not increase fast enough or too fast when charging	53
10.3.9. Incorrect battery voltage reading	53
10.3.10. Incorrect auxillary battery voltage reading	53
10.3.11. Synchronisation issues	53
11. Technical data	54
11.1. Technical data	54
12. Appendix	55
12.1. Dimensions BMV head unit	55
12.2. Dimensions shunt	56

1. Safety precautions

1.1. General safety precautions



Read this manual carefully. It contains important instructions that must be followed during installation, operation and maintenance.

Save these instructions for future reference on operation and maintenance.

1.2. Battery safety warnings



Working in the vicinity of a lead acid battery is dangerous. Batteries can generate explosive gases during operation. Never smoke or allow a spark or flame in the vicinity of a battery. Provide sufficient ventilation around the battery.

Wear eye and clothing protection. Avoid touching eyes while working near batteries. Wash your hands when done.

If battery acid contacts skin or clothing, wash them immediately with soap and water. If acid enters an eye, immediately flood the eye with running cold water for at least 15 minutes and get medical attention immediately.

Be careful when using metal tools in the vicinity of batteries. Dropping a metal tool onto a battery might cause a short circuit and possibly an explosion.

Remove personal metal items such as rings, bracelets, necklaces, and watches when working with a battery. A battery can produce a short circuit current high enough to melt objects such as rings, causing severe burns.

1.3. Transport and storage



Store this product in a dry environment.

Store this product in temperatures between -40°C and +60°C.

2. Introduction

2.1. The battery monitor

The BMV-712 Smart is a battery monitor. It measures battery voltage and current. Based on these measurements, it calculates the battery's state of charge and the time to go. It also keeps track of historical data, such as deepest discharge, average discharge and the number of charge and discharge cycles.

All monitored battery parameters can be read out, and settings can be changed via the display and the four buttons.

A connection with the [VictronConnect app](#) is possible via Bluetooth or USB. The VictronConnect app can be used to read out all monitored battery parameters or to change settings. To connect via USB, an optional [VE.Direct to USB interface](#) is needed.

If the battery monitor is connected to a GX device, such as the [Cerbo GX](#) or the [ColorControl GX](#), the battery can be monitored locally with the GX device or remotely via the [VRM portal](#).

The auxiliary input can be used to monitor the voltage of a second battery or the midpoint of a battery bank. The auxiliary input can also be used for battery temperature monitoring, together with the optional [Temperature sensor for BMV](#).

When connected to other Victron products via [VE.Smart networking](#), the battery monitor can provide real-time battery data such as battery temperature, voltage and current via Bluetooth for use by Victron solar chargers and select AC chargers.

2.2. Why should I monitor my battery?

Batteries are used in a wide variety of applications, mostly to store energy for later use. But how much energy is stored in the battery? No one can tell by just looking at it. The service life of batteries depends on many factors. Battery life may be shortened by under-charging, over-charging, excessively deep discharges, excessive charge or discharge currents, and by high ambient temperature. Monitoring the battery with a battery monitor will give important feedback to the user so that remedial measures can be taken when necessary. Doing this will extend battery life and the battery monitor will quickly pay for itself.

2.3. Sizing

The battery monitor is available in one size; it has a 500A shunt. However, it is possible to use the battery monitor with larger shunts all the way up to 9999A. Larger shunts are not included. For 1000A, 2000A or 6000A shunts see the [Shunt product page](#).

2.4. The VictronConnect app

The VictronConnect app can be used to monitor and configure the battery monitor. Note that configuring the battery monitor using the VictronConnect app is easier than configuring using the battery monitor head unit.

The VictronConnect app can connect to the battery monitor via:

- Bluetooth.
- USB, using the optional [VE.Direct to USB interface](#).
- Remotely via a GX device and the VRM portal.

The VictronConnect app is available for the following platforms:

- Android.
- Apple iOS (Note that USB is not supported, it is only possible to connect via Bluetooth).
- macOS.
- Windows (Note that Bluetooth is not supported, it is only possible to connect via USB).

The VictronConnect app can be downloaded from app stores or from the [VictronConnect product page](#) or scan the below QR code.

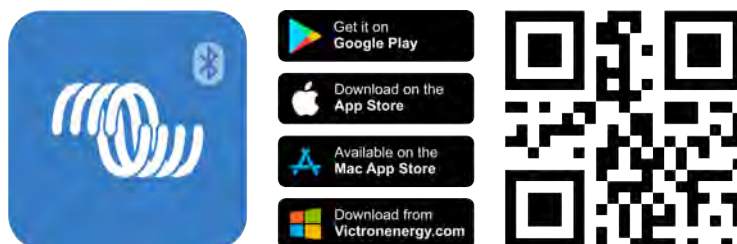





2.5. Accessories

These optional parts might be needed depending on your setup:

- [Temperature sensor for BMV](#) - to measure the battery temperature.
- GX Device, such as a [Cerbo GX](#) - for system and/or remote monitoring.
- [VE.Direct cable](#) - to connect the battery monitor to a GX device.
- [VE.Direct to USB interface](#) - to connect to the battery monitor via USB to a GX device or to the VictronConnect app.
- [Wall mount enclosure for BMV or MPPT Control](#) - use in case panel mounting of the battery monitor head unit is not possible.
- [Wall mount enclosure for BMV and Color Control GX](#) - use to wall mount the battery monitor head unit together with a Color Control GX in the same enclosure.
- [RJ12 UTP cable](#) - use in case the supplied 10m (32ft) RJ12 cable (the cable between the shunt and the head unit) is too long or too short. These cables are available in a variety of lengths of 30cm up to 30 meters (1ft up to 98ft).

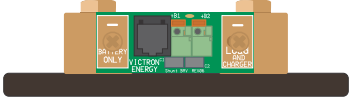
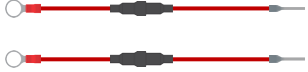
3. Installation

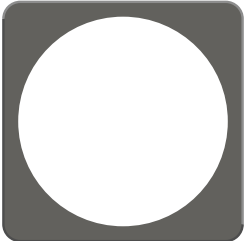
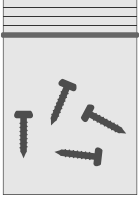
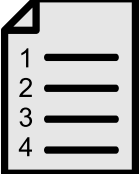
3.1. What's in the box?

<p>BMV-712 Smart head unit together with attachment sleeve.</p>	
<p>500A shunt.</p>	
<p>Two 1.5m (59") red cables with a 1A fuse.</p>	
<p>10m (33ft) RJ12 UTP cable.</p>	
<p>Square face plate together with an attachment flange.</p>	
<p>Bag with 4 small screws.</p>	
<p>Quick installation guide.</p>	
<p>Spare serial number sticker.</p>	

3.2. Mounting the shunt

The shunt has an IP21 rating; this means that the shunt is not waterproof and has to be mounted in a dry location.

The shunt has two 5.5 mm holes for mounting purposes; these are located in the base of the shunt. The holes can be used to screw or bolt the shunt onto a hard surface (note that these screws are not included).

For the exact location of the mounting holes see the [dimension drawing \[56\]](#) in the appendix of this manual.

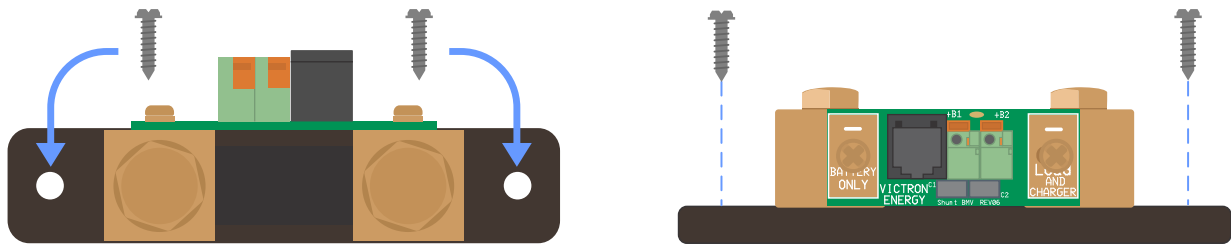

Top view shunt indicating mounting holes and side view shunt indicating the mounting method.

3.3. Mounting the head unit

The head unit can be mounted in a variety of ways:

- A. Panel mounting, the head unit is secured at the back of a panel.
- B. Panel mounting, the head unit is secured at the front of the panel.
- C. Wall mounting, using an optional wall mounting enclosure.

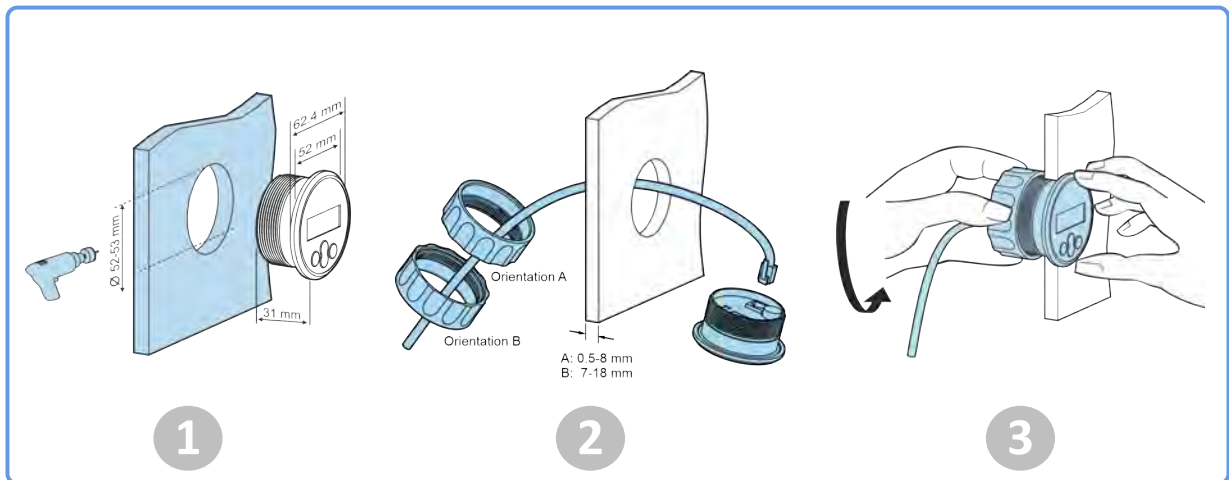

Mounting method A.

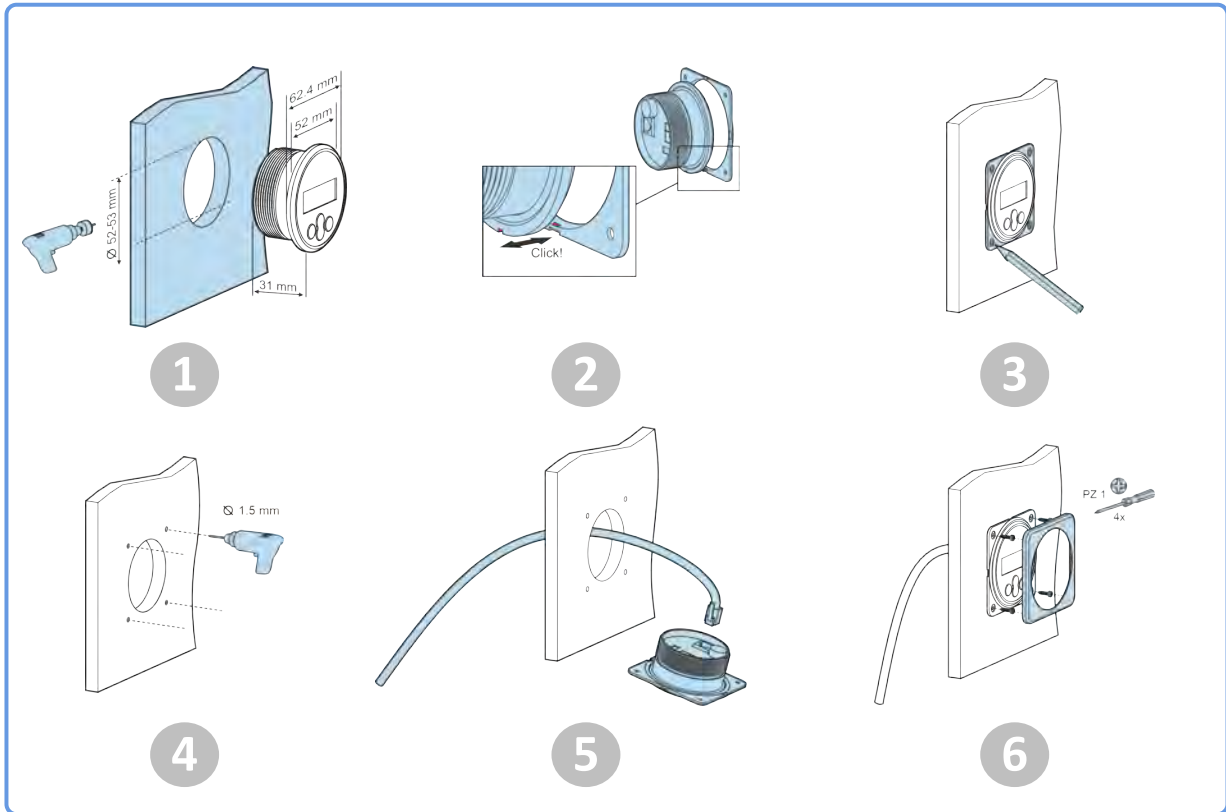

Mounting method B.



Mounting method C.

 For the full wall mounting instructions, see the wall mounting installation manuals on the [Wall mount enclosure for BMV or MPPT Control](#) or [Wall mount enclosure for BMV and Color Control GX](#) product pages.

3.4. Connections overview

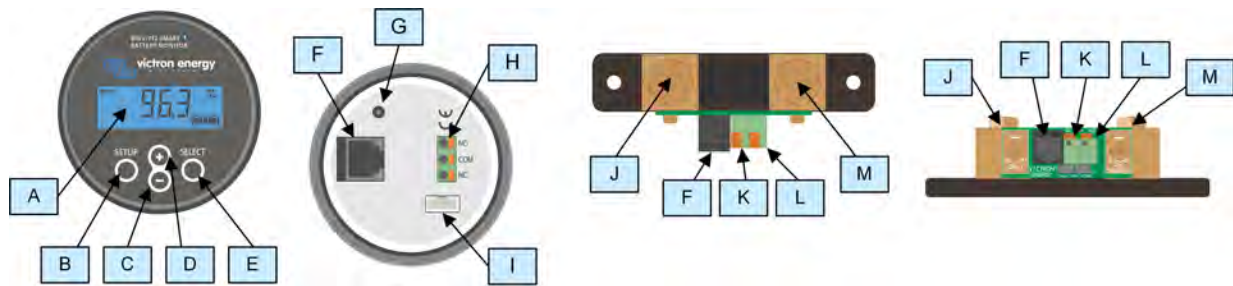

#	Name	Terminal type
A	Display	-
B	Setup button	-
C	Down button	-
D	Up button	-
E	Select button	-
F	RJ12 connector	RJ2 terminal
G	Buzzer	-
H	Programmable relay connector	Push connector
I	VE.Direct connector	VE.Direct terminal
J	Negative battery connection	M10 bolt
K	Positive battery connection	M10 ring terminal
L	Auxiliary connection	Push connector
M	Negative load connection	M10 bolt

3.5. Basic electrical connections

Connection procedure:

1. Connect the negative battery terminal to the M10 bolt on the "BATTERY ONLY" side of the shunt. Tighten the shunt bolt with a maximum torque of 21Nm.
Note that there should be no other connections on this side of the shunt or on the negative battery terminal. Any loads or chargers connected here will be excluded from the battery state of charge calculation.
2. Connect the negative of the electrical system to the M10 bolt on the "LOAD AND CHARGER" side of the shunt. Tighten the shunt bolt with a maximum torque of 21Nm. Make sure that the negative of all DC loads, inverters, battery chargers, solar chargers and other charge sources are connected "after" the shunt.
3. Connect the ferrule pin of the red cable with the fuse to the shunt by pushing the pin into to the "+B1" terminal.
4. Connect the M10 eye terminal of the red cable with the fuse to the positive terminal of the battery.
5. Connect the shunt to the head unit using the RJ12 cable. Plug one side of the RJ12 cable into the shunt RJ12 terminal and the other side of the cable into the RJ12 terminal on the rear of the head unit.

The battery monitor is now powered up. The display is active, and Bluetooth is active.

In order to be fully functional, the battery monitor needs to be configured; see the [Configuration \[12\]](#) chapter.

In case the battery monitor is going to be used to monitor a second battery, battery bank midpoint or battery temperature, see one of the next 3 paragraphs on how to do this and then go to the [Configuration \[12\]](#) chapter.

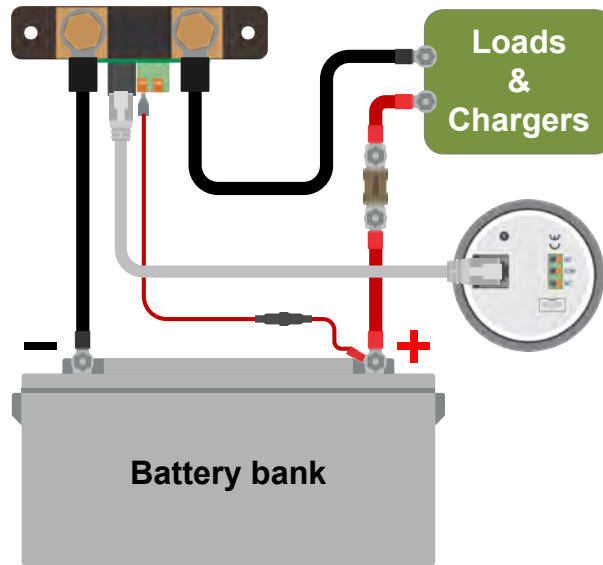

Basic battery monitor installation.

3.6. Auxiliary electrical connections

In addition to the comprehensive monitoring of the main battery bank, a second parameter can be monitored. This can be one of the following:

- The voltage of a second battery, like a starter battery.
- The midpoint deviation of the battery bank.
- Battery temperature.

This chapter describes how to wire the +B2 terminal for the three above options.

3.6.1. Auxiliary connection for monitoring the voltage of a second battery

For use to monitor the voltage of a second battery, such as a starter or auxiliary battery.

Connection procedure:

1. Verify that the negative pole of the second battery is connected to the LOAD AND CHARGER side of the shunt.
2. Connect the ferrule pin of the second red cable with fuse to the shunt by pushing the pin into to the +B2 terminal.
3. Connect the M10 lug of the second red cable with fuse to the positive terminal of the second battery.

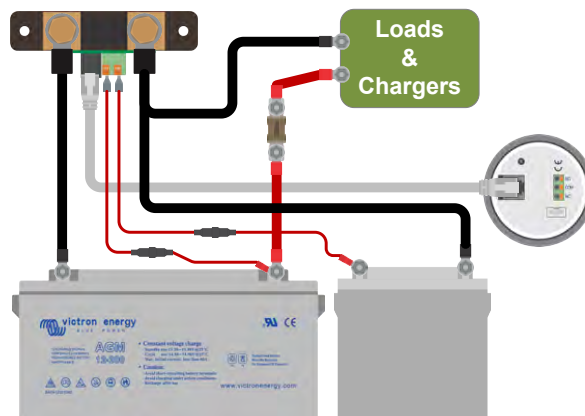

Battery monitor with auxiliary second battery monitoring.

3.6.2. Auxiliary connection midpoint battery bank monitoring

For use with a battery bank that consists of multiple batteries that are wired in series or series/parallel to create a 24V or 48V battery bank.

Connection procedure:

1. Connect the ferrule pin of the second red cable with fuse to the shunt by pushing the pin into to the +B2 terminal.
2. Connect the M10 lug of the second red cable with fuse to the positive terminal of the midpoint.

For more information on midpoint monitoring and for additional diagrams on midpoint battery bank wiring see the [Midpoint voltage monitoring \[46\]](#) chapter.

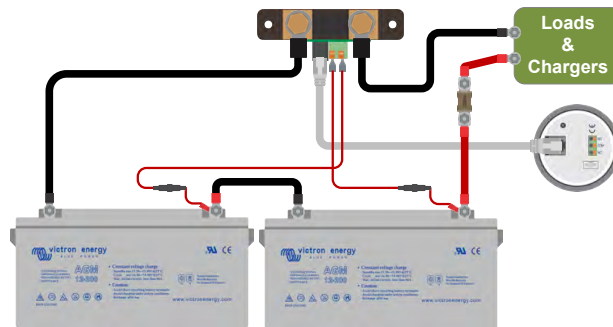

Battery monitor with auxiliary midpoint monitoring.

3.6.3. Auxiliary connection for temperature monitoring

For use to monitor the temperature of a battery via the (not included) [Temperature sensor for BMV-712 Smart and BMV-702](#) . This temperature sensor needs to be purchased separately. Be aware that this is a different temperature sensor than the temperature sensors that are included with Victron inverter/chargers and some battery chargers.



Temperature sensor for the battery monitor

Connection procedure:

- Connect the ferrule pin of the black temperature sensor wire by pushing the ferrule pin into the +B2 terminal.
- Connect the ferrule pin of the red wire cable by pushing the ferrule pin into to the +B1 terminal.
- Connect the M10 cable lug of the temperature sensor to the positive battery terminal.

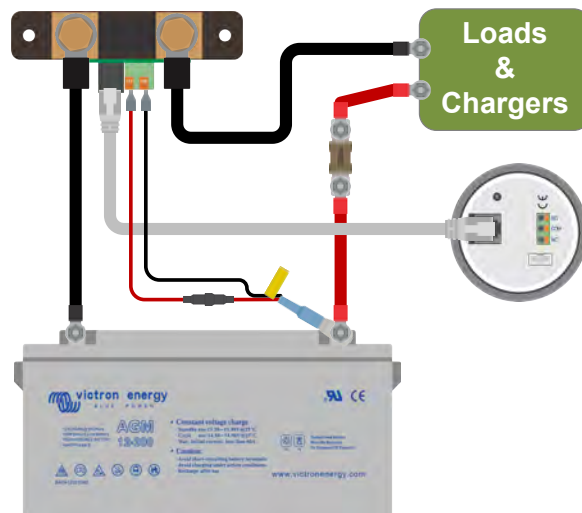

Battery monitor with auxiliary temperature sensing.

 Note that if the temperature sensor is used, the two red cables with fuse that came with the battery monitor are not needed. The temperature sensor will replace these cables.

3.7. Programmable relay

The battery monitor is equipped with a programmable relay. This relay can be used as an alarm relay, to start a generator or for other applications. For more information on the various relay modes and how to configure the relay, see chapter [Relay settings \[31\]](#).

A usage example of the relay is to start a generator when the battery state of charge has dropped too low, and then to stop the generator when the batteries have been recharged.

By default, the relay is set to energise when the battery state of charge falls below 50% and to de-energise when the battery state of charge has risen to 90%. However, the relay can be configured to also trigger on other conditions, like battery voltage.

The relay has 3 contacts: COM (common), NO (normally open), and NC (normally closed) and are located on the back of the head unit.

When the relay contact is open, the coil is de-energised; there is no contact between COM and NO. When the relay is energised, the relay closes, and contact between COM and NO is made. The relay function can be inverted: de-energised becomes energised and vice versa. See setting [Invert relay \[32\]](#).

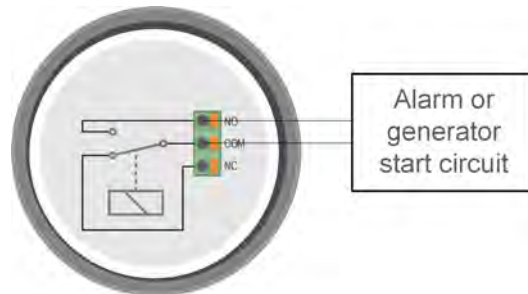

The internal wiring diagram of the battery monitor with the relay in a de-energised state connected to an external alarm or generator start circuit.

3.8. Use of alternative shunts

The battery monitor is supplied with a 500A, 50mV shunt. This shunt is suitable for most applications. However, a larger shunt will be required if system currents above 500A are expected.

The battery monitor can be configured to work with a wide range of different shunts. Shunts of up to 9999A and up to 75mV can be used. For a selection of larger shunts, i.e. 1000A, 2000A or 6000A, see our [shunt product page](#).

When using a shunt other than the one supplied with the battery monitor, please proceed as follows:

1. Unscrew the circuit board from the shunt.
2. Mount the circuit board on the new shunt, and ensure that there is good electrical contact between the circuit board and the shunt.
3. Connect the new shunt to the electrical system and battery monitor head unit as shown in chapter [Basic electrical connections \[7\]](#). Pay special attention to the orientation of the shunt circuit board in relation to the battery and load connections.
4. Follow the setup wizard; see the [Setup wizard \[12\]](#) chapter.
5. After completing the setup wizard, set the proper shunt current and shunt voltage according to the [Shunt current \[40\]](#) and the [Shunt voltage \[40\]](#) settings.
6. If the battery monitor reads a non-zero current, even when there is no load, and the battery is not being charged, calibrate the zero current reading using the [Zero current calibration \[31\]](#) setting.

3.9. GX device connection

If the system contains a GX device such as a [Cerbo GX](#), the battery monitor can be connected to the GX device using a [VE.Direct cable](#) or a [VE.Direct to USB interface](#).

Once connected, the GX device can be used to read out all monitored battery parameters. For more information see chapter [Connecting to a GX device and the VRM portal \[25\]](#).

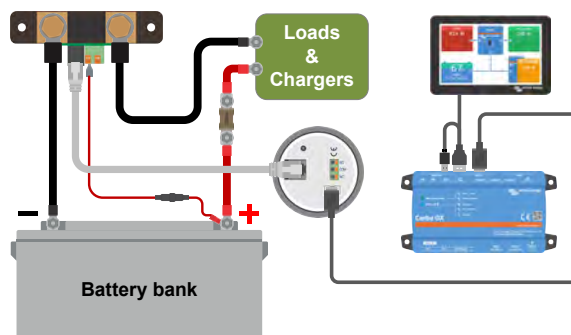

The battery monitor is connected to a *Cerbo GX* and a *GX Touch* screen.

3.10. Wiring for use as DC meter

When using the battery monitor as a DC meter, wire it to the device or circuit that needs to be monitored.

Note that the battery monitor also needs to be configured as a DC monitor using the VictronConnect app before it will operate as a DC meter. See the [Configure for use as DC meter \[17\]](#) chapter.

It is also possible to have a main battery monitor in the system together with a separate battery monitor that has been set up as a DC meter to monitor a specific device or circuit.

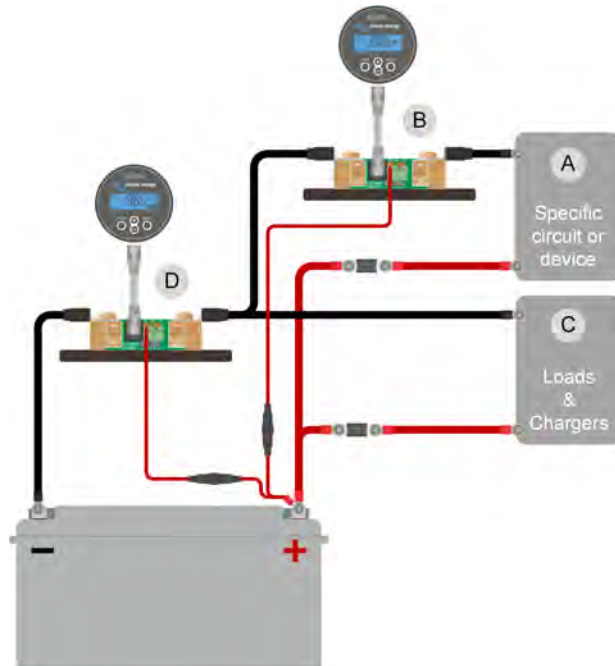

Wiring example of a system containing a main battery monitor, together with a battery monitor that has been set up as a DC meter and is monitoring a specific device or circuit. One battery monitor is used as a DC meter (B) and the other battery monitor is used as a battery monitor (D).

#	Description
A	Specific DC device or DC circuit
B	Battery monitor used as DC meter
C	The rest of the DC circuit
D	Battery monitor used as battery monitor

4. Configuration

Once the electrical connections have been made, and the battery monitor has been powered up, it needs to be configured to be suitable for the system it is used in.

This can be done with the buttons on the battery monitor head unit or even easier via the VictronConnect app.

This chapter describes how to configure the battery monitor by making the basic settings. See the [All features and settings \[28\]](#) chapter for all settings and features.

4.1. Setup wizard

The battery monitor will automatically start the setup wizard on the first power-up or after a factory reset. The setup wizard must be completed before any other settings are made.

Alternatively, use the VictronConnect app to configure the battery monitor. This will override the setup wizard.

1. The display shows the scrolling text "battery capacity": *BATTERY CAPACITY*.
2. Press any button to enter the setup wizard. The scrolling text will stop, and the factory default battery capacity value *200 Ah* (200 Ah) will be shown with the first digit blinking.
3. Use the + and – buttons to set the first digit of the battery capacity value. Preferably use the 20-hour (C20) battery capacity rating. For more information on battery capacity, see the [Battery capacity and Peukert exponent \[44\]](#) chapter.
4. Press SELECT to set the next digit in the same manner. Repeat this step until the required battery capacity is displayed.
5. Press SELECT to store the value. A short beep confirms this.
Should a correction need to be made, press SELECT again and repeat the previous steps.
6. Press SETUP, + or – to proceed to the auxiliary input setting.
7. The display will show the scrolling text *AUXILIARY INPUT* (auxiliary input).
8. Press SELECT to stop scrolling, and the LCD will show: *Start* (start).
9. Use the + or – buttons to select the required function of the auxiliary input: *Start* (start) for monitoring the starter battery voltage. *Mid* (mid) for monitoring the midpoint voltage of a battery bank. *Temp* (temp) for using the optional temperature sensor.
10. Press SELECT to store the value. A short beep confirms this.
Should a correction need to be made, press SELECT again and repeat the previous step.
11. Press the SETUP, + or – button to end the setup wizard and switch to the normal operating mode.

Immediately after the completion of the setup wizard, the battery monitor will automatically detect the nominal voltage of the battery system. For details and limitations of automatic voltage detection, see the next chapter [Automatic voltage detection \[12\]](#).

The battery monitor is now ready for use. It is now set up for an average system with GEL, AGM or flooded lead-acid batteries. Further battery monitor configurations are required if your system contains a battery with different chemistry, like lithium, or if other specific system settings are needed. See the [All features and settings \[28\]](#) chapter.



If the setup wizard is not showing, i.e. there is no scrolling text, it can be re-activated by performing a battery monitor reset. To do this: simultaneously press the SETUP and the SELECT button for 3 seconds. This resets the battery monitor to its factory settings.

Note that factory settings can only be restored if the [Lock setup \[39\]](#) setting has been set to OFF.

4.2. Automatic voltage detection

The battery monitor will automatically adjust itself to the nominal voltage of the battery bank. This happens immediately after the completion of the setup wizard. The below table shows how the nominal voltage is determined and to what nominal battery voltage the battery monitor is automatically set. See the [Set charged voltage value \[15\]](#) chapter for more information.

Measured voltage	Assumed nominal voltage
< 18V	12V
18 - 36V	24V

Measured voltage	Assumed nominal voltage
> 36V	48V

 Note that the battery monitor is unable to detect a 32V nominal battery voltage. If the battery monitor is used with a 32V battery bank, the charged voltage must be set manually using the [Charged voltage \[29\]](#) setting.

4.3. How to change settings

4.3.1. Settings via the head unit





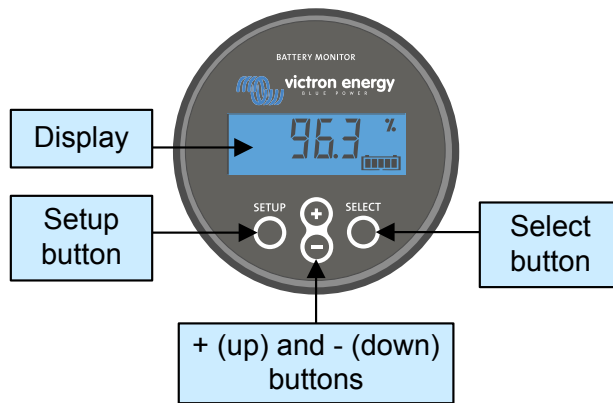

Use the display buttons to enter and navigate through the settings menu. Each setting has a number and a name. For example: "01 - Battery capacity". The full list of all battery settings and their corresponding number can be found in the [All features and settings \[28\]](#) chapter.

 It is also possible (and easier) to make the battery monitor settings via the VictronConnect app. See the [The VictronConnect app \[14\]](#) chapter on how to do this.



BMV head unit display and buttons.

To access the settings menu and change settings:

1	Start in the main menu.	
2	Press SETUP for two seconds to enter the settings menu.	
3	The first setting item 01-Battery capacity will be shown.	
4	Use the + and - buttons to go to the desired setting item.	
5	Press SELECT to access the setting item.	
6	Use SELECT and the + and - buttons to customize the setting.	

7	Press SETUP to return to the setting menu.	
8	Go to the next setting using the + or - buttons.	
9	After all settings have been made, press SETUP to return from the settings menu to normal mode.	

4.3.2. The VictronConnect app

The VictronConnect app can be used to change all settings and to update the firmware.

Ways to connect to the battery monitor:

- Locally via built-in Bluetooth.
- Locally via USB using the [VE.Direct to USB interface](#) connected to the VE.Direct port.
- Remotely via a GX device, using VictronConnect "Remote" feature. For more information, see the [VictronConnect-Remote](#) chapter in the VictronConnect app manual.

How to connect with the VictronConnect app to the battery monitor:

- Open the VictronConnect app.
- Ensure that the battery monitor is powered.
- Look for the battery monitor to appear in the device list in the "Local" or the "VRM" tab.
- Click on the battery monitor.
- In case of a connection via Bluetooth; enter the default PIN code: 000000. After entering the default PIN code, the VictronConnect app will ask you to change the PIN code. This is to prevent unauthorized connections in the future. It is recommended that you change the PIN code on the first installation. This can be done in the product info tab; see paragraph [Changing PIN code \[42\]](#).

To view and/or change battery monitor settings, navigate to the settings page by clicking on the cog icon  at the top right of the home screen.

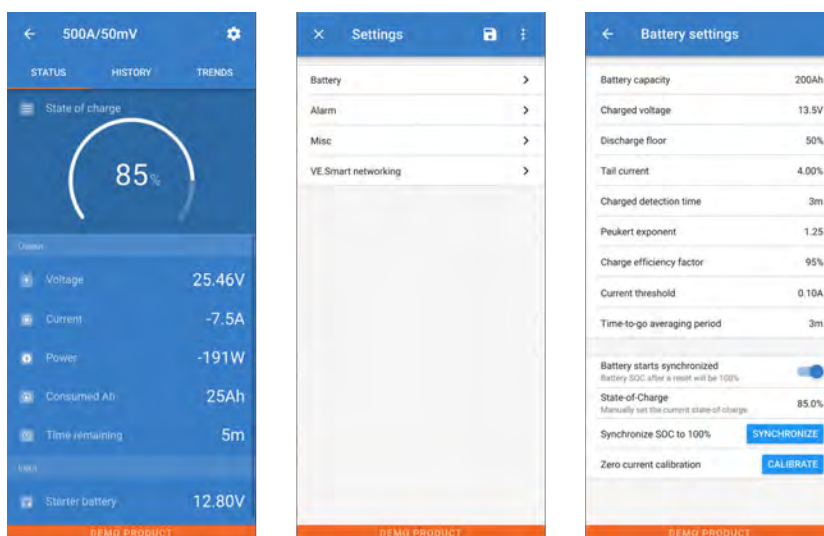

The battery monitor monitoring and setting screens in the VictronConnect app.



Note that this manual only covers the items that are specific to the battery monitor. For more general information about the VictronConnect app, like how to use it and where to download it, or how to connect, see the VictronConnect app [product page](#) and [manual](#).



4.4. Update firmware

On a new install, it is recommended to update the firmware of the battery monitor. If there is a newer firmware version available, the VictronConnect app will notify you of this as soon as a connection with the battery monitor is made.



Note that the firmware can only be updated via the VictronConnect app. The app needs to be up to date to be able to access the latest firmware.

To check if the firmware is up to date or to manually update firmware, connect to the battery monitor using the VictronConnect app and follow the below steps:

- Navigate to the product settings by clicking the "cog"  symbol in the top right-hand corner of the product status screen.
- Click on the "3 dots"  symbol in the top right-hand corner of the settings screen.
- Select "Product info" from the pop-up menu.
- The firmware version will be displayed. It is mentioned if this is the latest firmware version (or not). If a newer firmware version is available, an "UPDATE" button will be displayed.
- To update the firmware, press the "UPDATE" button.

4.5. Make essential settings

The default settings of the battery monitor are tailored for lead acid batteries, like AGM, GEL, OPzV or OPzS batteries.

Most settings can stay at their factory default. But there are a few settings that need to be changed. These are:

- Battery capacity.
- Charged voltage.
- The functionality of the auxiliary input (if used).
- State of charge or start synchronised.



If lithium batteries (or batteries with a different chemistry) are used, some additional settings will have to be changed.

First, make the essential settings as described in this paragraph and then refer to the next paragraph for the special lithium settings.



For more information about these and any of the other settings, see chapter [All features and settings \[28\]](#).

4.5.1. Set the battery capacity value

In the VictronConnect app, see: **Settings > Battery**.

Via the head unit, see: **Setup menu > Setting 01 - Battery capacity**.

The battery monitor is by default set to 200Ah. Change this value to match your battery capacity. For lead-acid batteries, we recommend entering the 20-hour (C20) rate.

4.5.2. Set charged voltage value

In the VictronConnect app, see: **Settings > Battery > Charged voltage**.

Via the head unit, see: **Setup menu > Setting 02 - Charged voltage**.

Although the battery monitor automatically detects the voltage, it is good practice to check if this setting is correctly set.

Nominal battery voltage	Recommended charged voltage setting
12V	13.2V
24V	26.4V
36V	39.6V
48V	52.8V

For more information, also see the [Charged voltage \[29\]](#) chapter.

4.5.3. Set state of charge

In the VictronConnect app, see: **Settings > Battery > Battery start synchronized**.

Via the head unit, see: **Setup menu > Setting 70 - Start synchronised**.

When set to ON, the battery monitor will consider itself synchronized when powered up, resulting in a state of charge of 100%. If set to OFF, the battery monitor will consider itself un-synchronized when powered up, resulting in a state of charge that is unknown until the first actual synchronization.

For VictronConnect only: The initial state of charge value can also be manually set, by default, this is 100%, and can be set to a different value if so desired. See: **Settings > Battery > State-of-charge**.

4.5.4. Set the auxiliary input function

In the VictronConnect app, see: **Settings > Misc > Aux input**.

Via the display, see: **Settings menu > Setting 69 - Aux input**.

This setting sets the function of the auxiliary input, being:

- **Starter battery** - Voltage monitoring of a second battery.
- **Midpoint** - Measuring the midpoint of a battery bank.
- **Temperature** - Measuring battery temperature via an optional temperature sensor.
- **None** - The auxiliary input is not used.

4.6. Make Lithium settings (if needed)

LiFePO4 (Lithium Iron Phosphate or LFP) is the most used Li-ion battery chemistry. The factory defaults are in general also applicable to LFP batteries with exception of these settings:

- Tail current.
- Peukert exponent.
- Charge efficiency.
- Discharge floor.

Tail current

In VictronConnect see: **Settings > Battery > Tail current**.

Via the head unit, see: **Setup menu > Setting 03 - Tail current**.

Some lithium battery chargers stop charging when the current drops below a set threshold. The tail current must be set higher in this case.

Peukert exponent

In VictronConnect see: **Settings > Battery > Peukert exponent**.

Via the head unit, see: **Setup menu > Setting 05 - Peukert exponent**.

When subjected to high discharge rates, lithium batteries perform much better than lead-acid batteries. Set the Peukert exponent at 1.05, unless the battery supplier advises otherwise.

Charge efficiency

In VictronConnect see: **Settings > Battery > Charge efficiency factor**.

Via the head unit, see: **Setup menu > Setting 06 - Charge efficiency factor**.

The charge efficiency of lithium batteries is much higher than that of lead-acid batteries. We recommend setting the charge efficiency at 99%.

Discharge floor

In VictronConnect see: **Setting > Battery > Discharge floor**

Via the head unit, see: **Setup menu > Setting 16 - SoC relay**.

This setting is used in "the time to go" calculation and is set at 50% by default for lead-acid batteries. However, lithium batteries usually can be discharged significantly deeper than 50%. The discharge floor can be set to a value between 10 and 20%, unless the battery supplier advises otherwise.

**Important warning**

Lithium batteries are expensive and can be irreparably damaged due to very deep discharge or overcharge. Damage due to deep discharge can occur if small loads slowly discharge the battery when the system is not in use. Some examples of these loads are alarm systems, standby currents of DC loads and back current drain of battery chargers or charge regulators.

A residual discharge current is especially dangerous if the system has been discharged all the way until a low cell voltage shutdown has occurred. At this moment the state of charge can be as low as 1%. The lithium battery will get damaged if any remaining current is drawn from the battery. This damage can be irreversible.

A residual current of 1mA for example can damage a 100Ah battery if the battery has been left in a discharged state for more than 40 days ($1\text{mA} \times 24\text{h} \times 40\text{ days} = 0.96\text{Ah}$).

The battery monitor draws $<12\text{mA}$ from the battery. The positive supply must therefore be interrupted if a system with Li-ion batteries is left unattended during a period long enough for the battery monitor power consumption to completely discharge the battery.

In case of any doubt about the possible residual current draw, isolate the battery by opening the battery switch, by pulling the battery fuse(s) or by disconnecting the battery positive when the system is not in use.

4.7. Configure for use as DC meter

In the VictronConnect battery monitor settings, go to the "Misc" settings and select "DC energy meter" from the Monitor mode drop-down menu. Once selected, you can choose what application the DC energy meter is used in.

Alternatively, navigate to setting 72 on the head unit.

For additional information also see the [Monitor Mode \[41\]](#) chapter.

5. Operation

5.1. How does the battery monitor work?

The main function of the battery monitor is to follow and indicate the state of charge of a battery, to be able to know how much charge the battery contains and to prevent an unexpected total discharge.

The battery monitor continuously measures the current flow in and out of the battery. Integration of this current over time, if it was a fixed current, boils down to multiplying current and time and gives the net amount of Ah added or removed.

For example, a discharge current of 10A for 2 hours will take $10 \times 2 = 20\text{Ah}$ from the battery.

To complicate matters, the effective capacity of a battery depends on the rate of discharge, the Peukert efficiency, and, to a lesser extent, the temperature. And to make things even more complicated: when charging a battery more energy (Ah) has to be 'pumped' into the battery than can be retrieved during the next discharge. In other words: the charge efficiency is less than 100%. The battery monitor takes all these factors into consideration when calculating the state of charge.

5.2. Readout overview

The head unit display or the VictronConnect app battery monitor status screen, displays an overview of the most important parameters. These are:

- State of charge
- Battery voltage
- Battery current
- Power
- Aux input reading (starter battery, midpoint or temperature)

State of charge

This is the actual state of charge of the battery in a percentage and is compensated for both the Peukert efficiency and charge efficiency. The state of charge is the best way to monitor the battery.

A fully charged battery will be indicated by a value of 100.0%. A fully discharged battery will be indicated by a value of 0.0%.

Please note that if the state of charge indicates three dashes: "---" this means that the battery monitor is in an unsynchronised state. This mainly occurs when the battery monitor has just been installed or after the battery monitor has been left unpowered and is powered up again. For more information, see the [Synchronising the battery monitor \[23\]](#) chapter.

Voltage

This is the terminal voltage of the battery.

Current

This is the actual current flowing in or out of the battery. A negative current indicates that current is taken from the battery. This is the current needed for DC loads. A positive current means that current is going into the battery. This is current coming from charge sources. Keep in mind that the battery monitor will always indicate the total battery current, being the current traveling into the battery minus the current traveling out of the battery.

Power

The power drawn from or received by the battery.

Consumed Ah

The battery monitor keeps track of the Amp-hours removed from the battery compensated for the efficiency.

Example: If a current of 12A is drawn from a fully charged battery for a period of 3 hours, the readout will show -36.0Ah ($-12 \times 3 = -36$).

Please note that if the "Consumed Ah" reading indicates three dashes: "---" this means that the battery monitor is in an unsynchronised state. This mainly occurs when the battery monitor has just been installed or after the battery monitor has been left unpowered and is powered up again. For more information, see the [Synchronising the battery monitor \[23\]](#) chapter.

Time remaining

The battery monitor estimates how long the battery can support the present load. This is the "time-to-go" readout and is the actual time left until the battery is discharged to the set "discharge floor". The discharge floor is by default set at 50%. For the discharge floor setting see the [Discharge floor \[29\]](#) chapter. If the load is fluctuating heavily, it is best not to rely on this reading too much,

as it is a momentary readout and should be used as a guideline only. We recommend the use of the state of charge readout for accurate battery monitoring.

If the “Time remaining” indicates three dashes: “---” this means that the battery monitor is in an unsynchronised state. This occurs when the battery monitor has just been installed or after it has been left unpowered and is powered up again. For more information, see the [Synchronising the battery monitor \[23\]](#) chapter.

Input

This is the state of the auxiliary input. Depending on how the battery monitor has been set up, you will see one of these options:

- **Starter battery voltage:** This shows the voltage of a second battery.
- **Battery temperature:** This shows the battery temperature of the main battery when the optional temperature sensor is used.
- **Midpoint voltage deviation:** This shows the deviation in a percentage of the main voltage of the battery bank top section compared to the voltage of the bottom section. For more information on this feature see the [Midpoint voltage monitoring \[46\]](#) chapter.

5.3. Using the head unit menus



Alternatively, use the VictronConnect app to access the battery monitor settings. See the chapter [The VictronConnect app \[14\]](#) on how to do this.

When the battery monitor is powered up for the first time or when the factory settings have been restored, the battery monitor will start the quick setup wizard; see chapter: [Setup wizard \[12\]](#). After that, the battery monitor will operate in normal mode, and the battery menu can be accessed as described in this chapter.

The battery monitor is controlled by the four buttons on the head unit. The function of the buttons depends on which mode the battery monitor is in. This is indicated in the below table.

If the backlight is off, press any button to restore the backlight.

Button	Function when in normal mode	Function when in setup mode
SETUP	Press and hold for two seconds to switch to setup mode. The display will scroll the number and description of the selected parameter.	Press SETUP any time to return to the scrolling text, and press again to return to normal mode. When pressing SETUP while a parameter is out of range, the display blinks five times, and the nearest valid value is displayed.
SELECT	Press to switch to the history menu. Press to stop scrolling and show the value. Press again to switch back to normal mode.	<ul style="list-style-type: none"> • Press to stop scrolling after entering the setup mode with the SETUP button. • After editing the last digit, press to end editing. The value is stored automatically. A short beep indicates confirmation. • If required, press again to restart editing.
SETUP and SELECT simultaneously	Press and hold both SETUP and SELECT buttons simultaneously for three seconds to restore factory settings (disabled when setting 64, lock setup, is on, see Lock setup [39]).	n/a
+	Move upwards.	<p>When not editing, press to move up to the previous parameter.</p> <p>When editing, this button will increment the value of the selected digit.</p>
-	<p>Move downwards.</p> <p>Press and hold for three seconds (until the confirmation beep) to start or stop automatic cycling through status items.</p>	<p>When not editing, press to move down to the next parameter.</p> <p>When editing, this button will decrement the value of the selected digit.</p>
+ and - simultaneously	Press and hold both buttons simultaneously for three seconds to manually synchronise the BMV.	n/a

5.4. Trends

The VictronConnect app provides battery monitor data logging. Providing that the firmware battery monitor is up to date, the battery monitor will store up to 45 days of past data and two of the following parameters can be viewed alongside:

- Voltage (V).
- Current (A).
- Power (W).
- Consumed Amp Hours (Ah).
- State of charge (%).
- Temperature (°C).



VictronConnect app battery monitor trends.

5.5. History

The battery monitor stores historic events. These can be used at a later date to evaluate usage patterns and battery health.

The history data is stored in a non-volatile memory and will not be lost when the power supply to the battery monitor has been interrupted or when the battery monitor has been reset to its defaults.

5.5.1. Accessing historical data via the VictronConnect app

The battery monitor's historical data can be accessed in the "History" tab in the VictronConnect app.



The VictronConnect app battery monitor history screen.

5.5.2. Accessing historical data via the head unit

To view the battery monitor history menu press SELECT when in normal mode:

- Press + or – to browse the various parameters.
- Press + or – to browse the various values.
- Press SELECT again to stop scrolling and show the value.
- Press SELECT again to leave the historical menu and to go back to the normal operation mode.

The below table gives an overview of the history parameters and how they are displayed in the menu. For the meaning of each parameter see the next chapter.

#	Display	Discription
A	A DEEPEST dI SCHAR-GE	Deepest discharge
B	b LAST dI SCHAR-GE	Last discharge
C	c AVE-RAGE dI SCHAR-GE	Average discharge
D	d CYCLES	Cycles
E	e dI SCHAR-GEs	Discharges
F	f CUMULATIVE Ah	Cumulative Ah
G	g LOWEST VOLTAGE	Lowest voltage
H	h HIGHEST VOLTAGE	Highest voltage
I	i DAYS SINCE LAST CHARGE	Days since last discharge
J	j SYNCHRONISATIONS	Synchronisations
L	l LOW VOLTAGE ALARMS	Low voltage alarms
M	m HIGH VOLTAGE ALARMS	High voltage alarms

#	Display	Description
P	P LOWEST AUX VOLTAGE	Lowest AUX voltage
Q	Q HIGHEST AUX VOLTAGE	Highest AUX voltage
R	R DISCHARGED ENERGY	Discharged energy
S	S CHARGED ENERGY	Charged energy

5.5.3. History data

Discharge information in Ah

- **Deepest discharge:** The battery monitor remembers the deepest discharge and each time the battery is discharged deeper the old value will be overwritten.
- **Last discharge:** The battery monitor keeps track of the discharge during the current cycle and displays the largest value recorded for Ah consumed since the last synchronisation.
- **Average discharge:** The cumulative Ah drawn divided by the total number of cycles.
- **Cumulative Ah drawn:** The cumulative number of Amp hours drawn from the battery over the lifetime of the battery monitor.

Energy in kWh

- **Discharged energy:** This is the total amount of energy drawn from the battery in kWh.
- **Charged energy:** The total amount of energy absorbed by the battery in kWh.

Charge

- **Total charge cycles:** The number of charge cycles over the lifetime of the battery monitor. A charge cycle is counted every time the state of charge drops below 65% and then rises above 90%.
- **Time since last full charge:** The number of days since the last full charge.
- **Synchronisations:** The number of automatic synchronisations. A synchronisation is counted every time the state of charge drops below 90% before a synchronisation occurs.
- **Number of full discharges:** The number of full discharges. A full discharge is counted when the state of charge reaches 0%.

Battery voltage

- **Min battery voltage:** The lowest battery voltage.
- **Max battery voltage:** The highest battery voltage.
- **Min starter voltage:** The lowest auxiliary battery voltage (if applicable).
- **Max starter voltage:** The highest auxiliary battery voltage (if applicable).

Voltage alarms

- **Low voltage alarms:** The number of low voltage alarms.
- **High voltage alarms:** The number of high voltage alarms.

5.6. Alarms

The battery monitor can raise an alarm in the following situations:

- Low battery state of charge (SOC).
- Low battery voltage.
- High battery voltage.
- Low and high starter battery voltage (if the AUX input has been set to "Starter battery").
- Midpoint voltage (if the AUX input has been set to "Midpoint").
- High and Low battery temperature (if the AUX input has been set to "Temperature").

The alarm will activate when the value reaches a set threshold and will deactivate when the value clears this threshold. The thresholds are configurable. For more information, see the [Alarm settings \[34\]](#) chapter.

The alarm will be displayed on the head unit, a buzzer will sound, the display backlight will flash, and the alarm icon will be visible on the display. An alarm is acknowledged when a button is pressed. However, the alarm icon is displayed as long as the alarm condition remains. The programmable relay can be triggered depending on the configuration of the alarm settings.

The alarm is also a software alarm.

When connecting with the VictronConnect app, while an alarm is active, the alarm will show in the app. Alternatively, when the battery monitor is connected to a GX device, the alarm will show on the GX device display or the VRM portal.

In the case of the VictronConnect app, an alarm is acknowledged when a button is pressed. And in the case of a GX device, an alarm is acknowledged when viewed in notifications. The alarm icon is displayed as long as the alarm condition remains.



Left: alarm displayed on the VictronConnect app. Right: alarm displayed on a GX device.

5.7. Synchronising the battery monitor

For a reliable readout, the state of charge, as displayed by the battery monitor, must self-synchronise regularly with the true state of charge of the battery. This is to prevent drift of the "State of charge" value over time. A synchronisation will reset the state of charge of the battery to 100%.

5.7.1. Automatic synchronisation

Synchronisation is an automatic process and will occur when the battery has been fully charged. The battery monitor will look at a few parameters to ascertain that the battery has been fully charged. It will consider the battery to be fully charged when the voltage has reached a certain value and the current has dropped below a certain value for a certain amount of time.

These parameters are called:

- Charged voltage - the float voltage of the battery charger.
- Tail current - a percentage of the battery capacity.
- Charged detection time - the time in minutes.

As soon as these 3 parameters have been met, the battery monitor will set the state of charge value to 100%, thus synchronising the state of charge.

Example:

In the case of a 12V battery, the battery monitor will reset the battery's state of charge to 100% when all these parameters have been met:

- The voltage exceeds 13.2V,
- the charge current is less than 4.0% of the total battery capacity (e.g. 8A for a 200Ah battery) and,
- 3 minutes have passed while both the voltage and current conditions are met.

If the battery monitor does not perform a regular synchronisation, the state of charge value will start to drift over time. This is due to the small inaccuracies of the battery monitor and because of the estimation of the [Peukert exponent \[44\]](#). Once a battery has been fully charged, and the charger has gone to the float stage, the battery is full and the battery monitor will automatically synchronise by setting the state of charge value to 100%.

5.7.2. Manual synchronisation

The battery monitor can be synchronised manually if required. This can be done by pressing the "Synchronise" button in the VictronConnect app. Navigate to "settings" and then to "battery settings".

Alternatively, the battery monitor can be synchronised when in normal operating mode by simultaneously pressing and holding the + and – buttons for 3 seconds.

A manual synchronisation can be needed in situations when the battery monitor does not synchronise automatically. This is for example needed during the first installation or after the voltage supply to the battery monitor has been interrupted.

A manual synchronisation can also be needed when the battery has not been fully charged, or if the battery monitor has not detected that the battery has been fully charged because the charged voltage, current or time has been set incorrectly. In this case, review the settings and make sure the battery regularly receives a full charge.

5.8. Operation as a DC meter

The battery monitor can be set up as a DC energy meter. It is used to measure DC production or consumption of a specific device in a system, like for example an alternator, wind turbine or hydro generator. Or similarly, the consumption of a specific circuit or load in a DC system.

When in DC monitor mode, the voltage, current and power is displayed.



VictronConnect app status screen of a battery monitor running in DC monitor mode.



Note that the wiring of a DC meter differs from battery monitor wiring, see the [Wiring for use as DC meter \[11\]](#) chapter on how to wire. When switching between modes, it is recommended to reset all historical data.

6. Interfacing

The battery monitor can be connected to other equipment, this chapter describes how this can be done.

6.1. VictronConnect app via USB

The VictronConnect app can not only connect via Bluetooth but it can also connect via USB. A USB connection is essential when connecting to the Windows version of the VictronConnect app and is optional when the MacOS or Android version is used. Please note that in case of connecting to an Android phone or tablet a “USB on the Go” cable might be needed.

To connect via USB, you will need a VE.Direct to USB interface. Use this interface to connect the computer to the battery monitor. for more information see the [VE.Direct to USB interface](#) product page.

For more information also see the [VictronConnect app manual](#).

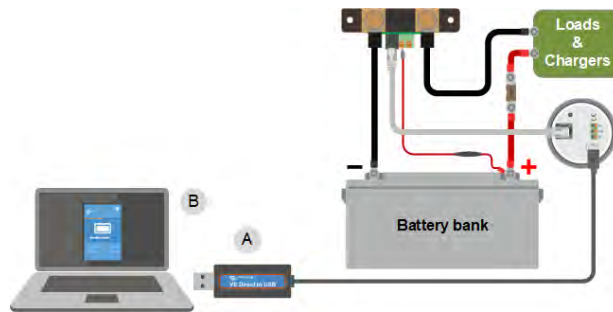

Example of a VE.Direct to USB interface connection between the battery monitor and a computer.

#	Description
A	VE.Direct to USB interface.
B	Computer or laptop.

6.2. Connecting to a GX device and the VRM portal

A GX device, such as the [Cerbo GX](#), is a Victron Energy device that provides control and monitoring for all Victron equipment that is connected to it. Control and monitoring of the GX device and it's connected equipment can be done locally or remotely via our free Victron Remote Monitoring portal, the [VRM portal](#).

The battery monitor can be connected to a GX device with a [VE.Direct cable](#). The VE.Direct cables are available in lengths ranging from 0.3 to 10 meters and are available with straight or right-angle connectors. Alternatively, the battery monitor can also connect to a GX device using a [VE.Direct to USB interface](#).

Once connected, the GX device can be used to read out all monitored battery parameters.

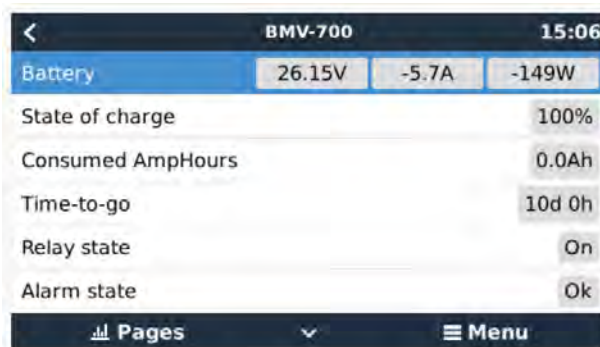

Battery monitor information displayed by a GX device.

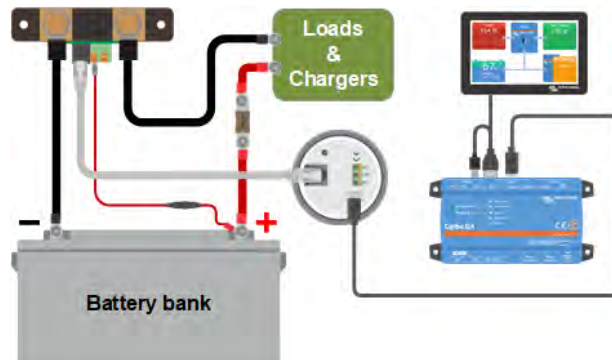

Example of a battery monitor connecting to a GX device.

6.3. Connecting to VE.Smart networking

VE.Smart networking is a wireless network that allows a number of Victron products to exchange information via Bluetooth. The battery monitor can share the following information with the network:

- Battery voltage.
- Battery current.
- Battery temperature. Note that an optional temperature sensor is needed see chapter [Auxiliary connection for temperature monitoring \[9\]](#) for more information.

A usage example is a system with VE.Smart networking that contains a battery monitor with a temperature sensor and a solar charger. The solar charger receives the battery voltage and temperature information from the battery monitor and uses this information to optimise its charge parameters. This will improve charging efficiency and will prolong battery life.

To make the battery monitor part of VE.Smart networking, you will have to either create a network or join an existing network. The setting can be found in the VictronConnect app. Navigate to the battery monitor page and then to: settings > smart networking. Please see the [VE.Smart networking manual](#) for more information.



Creating a VE.Smart network using the VictronConnect app.

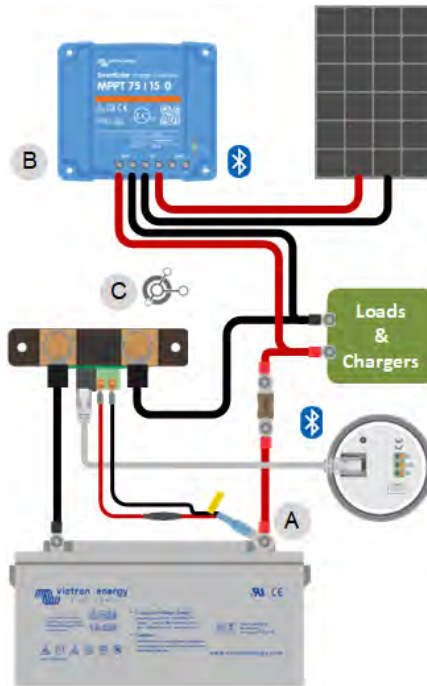

Example of a system containing a battery monitor with a temperature sensor and a solar charger, both using the VE.Smart networking.

6.4. Custom integration



Please note that this is an advanced feature and requires programming knowledge.

The VE.Direct communications port can be used to read data and change settings. The VE.Direct protocol is extremely simple to implement. Transmitting data to the battery monitor is not necessary for simple applications: the battery monitor automatically sends all readings every second.

All the details are explained in the [Data communication with Victron Energy products](#) document.

7. All features and settings

This chapter explains all battery monitor settings. In addition to this we also have a video available explaining these settings and how they interact with each other to achieve accurate battery monitoring for both lead acid and lithium batteries.

Link to the video:

https://www.youtube.com/embed/mEN15Z_S4kE

7.1. How to change settings

Settings can be changed by using the battery monitor's head unit or by using the VictronConnect app.



7.1.1. Accessing settings via the head unit

To access and change setting parameters use the buttons on the head unit in the following way:

- Press SETUP for two seconds to access these functions and use the + and – buttons to browse them.
- Press SELECT to access the desired parameter.
- Use SELECT and the + and – buttons to customize. A short beep confirms the setting.
- Press SETUP at any time to return to the scrolling text, and press again to return to normal mode.

7.1.2. Accessing settings via the VictronConnect app

To access and change setting parameters do the following:

- Click on the settings symbol  to go to the battery settings menu.
- To navigate from the general settings menu to the product settings menu, click on the menu symbol .

For information on how to connect with the VictronConnect app to the battery monitor, see the [The VictronConnect app \[14\]](#) chapter.

7.1.3. Saving, loading and sharing settings in VictronConnect

In the settings menu you can find the following 3 symbols:

 **Save settings to file** - This will save settings for reference or for later use.

 **Load settings from file** - This will load earlier saved settings.

 **Share settings file** – This allows you to share the settings file via email, message, airdrop and so on. The available sharing options depend on the platform used.

For more information on these features, see the [VictronConnect manual](#).

7.2. Battery settings

The battery settings can be used to fine-tune the battery monitor. Please be careful when you change these settings, as a change might affect the battery monitor's state of charge calculations.

7.2.1. Battery capacity

This parameter is used to tell the battery monitor how big the battery is. This setting should already have been done during the initial installation.

The setting is the battery capacity in Amp-hours (Ah).

For more information on the battery capacity and the related Peukert exponent see the [Battery capacity and Peukert exponent \[44\]](#) chapter.

Setting	Default	Range	Step size
Battery capacity (setting 01)	200Ah	1 - 9999Ah	1Ah

7.2.2. Charged voltage

The battery voltage must be above this voltage level to consider the battery as fully charged. As soon as the battery monitor detects that the voltage of the battery has reached this “charged voltage” parameter and the current has dropped below the “tail current [29]” parameter for a certain amount of time, the battery monitor will set the state of charge to 100%.

Setting	Default	Range	Step size
Charged voltage (setting 02)	13.2V (12V nominal)	0 - 70V	0.1V
	26.4V (24V nominal)		
	52.8V (48V nominal)		

The “charged voltage” parameter should be set to 0.2V or 0.3V below the float voltage of the charger.

The table below indicates the recommended settings for lead acid batteries.

Nominal battery voltage	Charged voltage setting
12V	13.2V
24V	26.4V
36V	39.6V
48V	52.8V

7.2.3. Discharge floor

The “Discharge floor” parameter is used in the “time remaining” calculation. The battery monitor calculates the time it takes until the set “discharge floor [29]” has been reached. It is also used to set the state of charge alarm defaults.

For lead-acid batteries set this to 50% and for lithium set it lower.

Note that this setting only appears when accessing the battery monitor via the VictronConnect app. In case the battery monitor is accessed via the head unit, see the [Low State of Charge \(SoC\) relay \[32\]](#) setting instead.

Setting	Default setting	Range	Step size
Discharge floor	50%	0 - 99%	1%

7.2.4. Tail current

The battery is considered as fully charged once the charge current has dropped to less than this “Tail current” parameter. The “Tail current” parameter is expressed as a percentage of the battery capacity.

Note that some battery chargers stop charging when the current drops below a set threshold. In these cases, the tail current must be set higher than this threshold.

As soon as the battery monitor detects that the voltage of the battery has reached the set “Charged voltage [29]” parameter and the current has dropped below this “Tail current” parameter for a certain amount of time, the battery monitor will set the state of charge to 100%.

Setting	Default	Range	Step size
Tail current (setting 03)	4.00%	0.50 - 10.00%	0.1%

7.2.5. Charged detection time

This is the time the “Charged voltage [29]” parameter and the “Tail current [29]” parameter must be met in order to consider the battery fully charged.

Setting	Default setting	Range	Step size
Charged detection time (setting 04)	3 minutes	0 - 100 minutes	1 minute

7.2.6. Peukert exponent

Set the Peukert exponent parameter according to the battery specification sheet. If the Peukert exponent is unknown, set it at 1.25 for lead-acid batteries and set it at 1.05 for lithium batteries. A value of 1.00 disables the Peukert compensation. The Peukert value for lead-acid batteries can be calculated. For more information on the Peukert calculation, the Peukert exponent and how this relates to the battery capacity, see the [Battery capacity and Peukert exponent \[44\]](#) chapter.

Setting	Default	Range	Step size
Peukert exponent (setting 05)	1.25	1.00 - 1.50	0.01

7.2.7. Charge efficiency factor

The “Charge Efficiency Factor” compensates for the capacity (Ah) losses during charging. A setting of 100% means that there are no losses.

A charge efficiency of 95% means that 10Ah must be transferred to the battery to get 9.5Ah actually stored in the battery. The charge efficiency of a battery depends on battery type, age and usage. The battery monitor takes this phenomenon into account with the charge efficiency factor.

The charge efficiency of a lead acid battery is almost 100% as long as no gas generation takes place. Gassing means that part of the charge current is not transformed into chemical energy, which is stored in the plates of the battery, but is used to decompose water into oxygen and hydrogen gas (highly explosive!). The energy stored in the plates can be retrieved during the next discharge, whereas the energy used to decompose water is lost. Gassing can easily be observed in flooded batteries. Please note that the ‘oxygen only’ end of the charge phase of sealed (VRLA) gel and AGM batteries also results in a reduced charge efficiency.

Setting	Default setting	Range	Step size
Charge efficiency factor (setting 06)	95%	50 - 100%	1%

7.2.8. Current threshold

When the current measured falls below the “Current threshold” parameter it will be considered zero. The “Current threshold” is used to cancel out very small currents that can negatively affect the long-term state of charge readout in noisy environments. For example, if the actual long-term current is 0.0A and, due to injected noise or small offsets, the battery monitor measures 0.05A the battery monitor might, in the long term, incorrectly indicate that the battery is empty or will need to be recharged. When the current threshold in this example is set to 0.1A, the battery monitor calculates with 0.0A so that errors are eliminated.

A value of 0.0A disables this function.

Setting	Default	Range	Step size
Current threshold (setting 07)	0.10A	0.00 - 2.00A	0.01A

7.2.9. Time-to-go averaging period

The time-to-go averaging period specifies the time window (in minutes) that the moving averaging filter works. A value of 0 (zero) disables the filter and gives an instantaneous (real-time) readout. However, the displayed “Time remaining” value may fluctuate heavily. Selecting the longest time, 12 minutes, will ensure that only long-term load fluctuations are included in the “Time remaining” calculations.

Setting	Default	Range	Step size
Time-to-go averaging period (setting 08)	3 minutes	0 - 12 minutes	1 minute

7.2.10. Battery starts synchronised

Note that if the battery monitor settings are accessed via the head unit, this setting will be part of the miscellaneous setting, and if accessed via VictronConnect it will be part of the battery settings.

The battery state of charge will become 100% after the battery monitor is powered up. When set to ON, the battery monitor will consider itself synchronised when powered up, resulting in a state of charge of 100%. If set to OFF, the battery monitor will consider it unsynchronised when powered up, resulting in a state of charge that is unknown until the first actual synchronisation.

Please be aware that situations can occur where special consideration is needed when setting this feature to ON. One of these situations occurs in systems where the battery is often disconnected from the battery monitor, for example on a boat. If you leave the boat and disconnect the DC system via the main DC breaker and at that moment the batteries were, for example, 75% charged. On return to the boat, the DC system is reconnected and the battery monitor will now indicate 100%. This will give a false impression that the batteries are full, while in reality they are partially discharged.

There are two ways of solving this, one is to not disconnect the battery monitor when the batteries are partially discharged or alternatively turn the “Battery starts synchronised” feature off. Now when the battery monitor is reconnected the state of charge will display “---” and will not show 100% until the batteries have been fully charged. Please note that leaving a lead acid battery in a partially discharged state for a length of time will cause battery damage.

Setting	Default	Modes
Start synchronized (setting 70)	ON	ON/OFF

7.2.11. State of charge

With this setting, you can manually set the state of charge value. This setting is only active after the battery monitor has, at least once, been synchronised. Either automatically or manually.

This setting is only available when accessing the battery monitor via the VictronConnect app.

Setting	Default	Range	Step size
State of charge	-- %	0.0 - 100%	0.1%

7.2.12. Synchronise SoC to 100%

Setting 10

This option can be used to manually synchronise the battery monitor.

When navigating to this setting on the head unit, press the SELECT button to synchronize the battery monitor to 100%.

In the VictronConnect app press the "Synchronise" button to synchronise the battery monitor to 100%.

See the [Manual synchronisation \[23\]](#) paragraph for more information on this setting.

7.2.13. Zero current calibration

Setting 09

This option can be used to calibrate the zero reading if the battery monitor reads a non-zero current even when there is no load and the battery is not being charged.

A zero current calibration is (almost) never needed. Only perform this procedure in case the battery monitor shows a current while you are absolutely sure that there is no actual current flowing. The only way to be sure is to physically disconnect all wires and cables connected to the LOAD AND CHARGER side of the shunt. Do this by unscrewing the shunt bolt and removing all cables and wires from that side of the shunt. The alternative, switching loads or chargers off, is NOT accurate enough as this does not eliminate small standby currents.

Ensure that there really is no current flowing into or out of the battery (disconnect the cable between the load and the shunt), then press SELECT in the head unit menu or press CALIBRATE in the VictronConnect app.

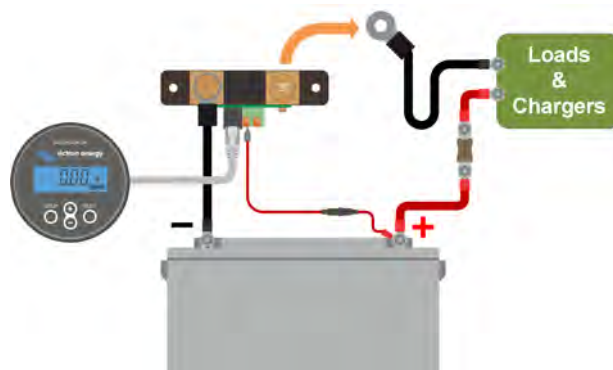

Performing a zero current calibration.

7.3. Relay settings

The battery monitor is equipped with a programmable relay. These settings are used to program the function of the relay.

The relay settings are disabled by default (except the State of Charge (SoC) relay setting). To enable, a relay setting do the following:

- In the VictronConnect app, enable the relay setting by sliding the slider button to the right.
- Via the head unit, enable the relay setting by changing the set and clear value to any value above zero.

7.3.1. Relay mode

This setting has the following relay modes, namely:

Setting	Default mode	Modes	Description
Relay mode (setting 11)	DFLT	DFLT Default mode.	The relay settings 16 up to 31 can be used to control the relay.
		CHRG Charger mode.	The relay will close when the state of charge falls below setting 16 (discharge floor) or when the battery voltage falls below setting 18 (low voltage relay). The relay will be open when the state of charge is higher than setting 17 (clear state of charge relay) and the battery voltage is higher than setting 19 (clear low voltage relay). An application example is to start and stop control of a generator, together with settings 14 and 15.
		REM Remote mode.	The relay can be controlled via the VE.Direct interface. Relay settings 12 and 14 up to 31 are ignored as the relay is under the full control of the device connected via the VE.Direct interface.

7.3.2. Invert relay

This function enables selection between a normally de-energised (contact open) or a normally energised (contact closed) relay.

When inverted, the open and closed conditions as described in all the relay settings are inverted (with the exception of the [Relay state \[32\]](#)).

Note that the "normally energised" setting will slightly increase the power consumption of the battery monitor.

Setting	Default mode	Modes	Range
Invert relay (setting 12)	OFF	OFF	Normally de-energised
		ON	Normally energised

7.3.3. Relay state

This is a read-only parameter and it displays whether the relay is open or closed (de-energised or energised).

Setting	Value	Description
Relay state (setting 13)	OPEN	The relay is open (de-energised)
	CLSD	The relay is closed (energised)

7.3.4. Relay minimum closed time

Sets the minimum time the "closed" condition will remain present after the relay has been energised.

Note that this changes to "open" and de-energised if the relay function has been inverted ([Invert relay \[32\]](#) setting).

An application example is to set a minimum generator run time when the relay is set to "charger" mode ([Relay mode \[31\]](#) setting).

Setting	Default	Range	Step size
Relay minimum closed time (setting 14)	0 minutes	0 - 8 hours	1 minute

7.3.5. Relay off delay

Sets the amount of time the "de-energise relay" condition must be present before the relay opens.

An application example is to keep a generator running for a while to charge the battery better when the relay is set to "charger" mode ([Relay mode \[31\]](#) setting).

Setting	Default	Range	Step size
Relay off delay (setting 15)	0 minutes	0 - 500 minutes	1 minute

7.3.6. Low State of Charge (SoC) relay

When the state of charge percentage has fallen below the "set relay" value, the relay will close.

When the state of charge percentage has risen above the "clear relay" value, the relay will open (after a delay, depending on the [Relay minimum closed time \[32\]](#) and/or the [Relay off delay \[32\]](#) settings).

The "clear relay" value needs to be greater than the "set relay" value.

Setting	Default	Range	Step size
Set relay value (setting 16)	50%	0 - 99%	1%
Clear relay value (setting 17)	90%	0 - 99%	1%



When the "set relay" and "clear relay" values are equal, the state of charge condition will be unable to drive the relay.



Note that this setting is also known as the discharge floor. The time-to-go reading displayed by the battery monitor relates to this setting. The time to go is the time left until this setting (the discharge floor) has been reached.

7.3.7. Low voltage relay

When the battery voltage falls below the "set relay" value for more than 10 seconds the relay will close.

When the battery voltage rises above the "clear relay" value, the relay will open (after a delay, depending on the [Relay minimum closed time \[32\]](#) and/or the [Relay off delay \[32\]](#) settings).

The "clear relay" value needs to be greater than the "set relay" value.

Setting	Default	Range	Step size
Set relay value (setting 18)	0V	0 - 95V	0.1V
Clear relay value (setting 19)	0V	0 - 95V	0.1V

7.3.8. High voltage relay

When the battery voltage rises above the "set relay" value for more than 10 seconds the relay will close.

When the battery voltage falls below the "clear relay" value, the relay will open (after a delay, depending on the [Relay minimum closed time \[32\]](#) and/or the [Relay off delay \[32\]](#) settings).

The "clear relay" value needs to be greater than the "set relay" value.

Setting	Default	Range	Step size
Set relay value (setting 20)	0V	0 - 95V	0.1V
Clear relay value (setting 21)	0V	0 - 95V	0.1V

7.3.9. Low starter voltage relay

This setting is available if the aux input has been set to "Starter battery", see the [Aux input \[40\]](#) setting.

When the auxiliary (e.g. starter battery) voltage falls below "set relay" value for more than 10 seconds, the relay will be closed.

When the auxiliary voltage rises above the "clear relay" value, the relay will open (after a delay, depending on the [Relay minimum closed time \[32\]](#) and/or the [Relay off delay \[32\]](#) settings).

The "clear relay" value needs to be greater than the "set relay" value.

Setting	Default	Range	Step size
Set relay value (setting 20)	0V	0 - 95V	0.1V
Clear relay value (setting 21)	0V	0 - 95V	0.1V

7.3.10. High starter voltage relay

This setting is available if the aux input has been set to "Starter battery", see the [Aux input \[40\]](#) setting.

When the auxiliary (e.g. starter battery) voltage rises above the "set relay" value for more than 10 seconds, the relay will be closed.

When the auxiliary voltage falls below the "clear relay" value, the relay will open (after a delay, depending on the [Relay minimum closed time \[32\]](#) and/or the [Relay off delay \[32\]](#) settings).

The "clear relay" value needs to be greater than the "set relay" value.

Setting	Default	Range	Step size
Set relay value (setting 24)	0V	0 - 95V	0.1V
Clear relay value (setting 25)	0V	0 - 95V	0.1V

7.3.11. Low temperature relay

This setting is available if the aux input has been set to "Temperature", see the [Aux input \[40\]](#) setting.

Use the [Temperature unit setting \[41\]](#) to choose between °C or °F temperature units.

When the battery temperature drops below the "set relay" value for more than 10 seconds the relay will close.

When the battery temperature rises above the "clear relay" value, the relay will open (after a delay, depending on the [Relay minimum closed time \[32\]](#) and/or the [Relay off delay \[32\]](#) settings).

Setting	Default	Range	Step size
Set relay value (setting 28)	0°C	-40 - +99°C	1°C
	0°F	-40 - +210°F	1°F
Clear relay value (setting 29)	0°C	-40 - +99°C	1°C
	0°F	-40 - +210°F	1°F

7.3.12. Mid voltage relay

This setting is available if the aux input has been set to "Mid point", see the [Aux input \[40\]](#) setting.

See the chapter [Midpoint voltage monitoring \[46\]](#) for more information about the midpoint voltage.

When the midpoint voltage deviation rises above the "set relay" value, the relay will close.

When the midpoint voltage deviation falls below the "clear relay" value, the relay will open (after a delay, depending on the [Relay minimum closed time \[32\]](#) and/or the [Relay off delay \[32\]](#) settings).

Setting	Default	Range	Step size
Set relay value (setting 30)	0%	0 - 99%	1%
Clear relay value (setting 31)	0%	0 - 99%	1%

7.4. Alarm settings

The BMV battery monitor is equipped with an alarm relay and a buzzer. Alarms are also visible on the VictronConnect app while connected to the battery monitor or are used to send an alarm signal to a GX device.

Alarms are disabled by default. To enable do the following:

- In the VictronConnect app, enable the alarm by sliding the slider button to the right.
- Via the head unit, enable the alarm by changing the "set" and "clear" value in the alarm settings to any value above zero.

7.4.1. Alarm buzzer

When enabled (set to ON), the buzzer will sound an alarm as soon as an alarm condition occurs. After a button is pressed, the buzzer will stop sounding.

When disabled (set to OFF) the buzzer will not sound an alarm.

Setting	Default	Modes
Alarm buzzer (setting 32)	ON	ON OFF

7.4.2. Low SoC alarm settings

When enabled, the alarm will activate when the state of charge (SoC) falls below the set value for more than 10 seconds. The alarm will deactivate when the state of charge rises above the clear value

Setting	Default	Range	Steps
Set alarm value (setting 33)	1%	0 - 100%	1%
Clear alarm value (setting 34)	1%	0 - 100%	1%

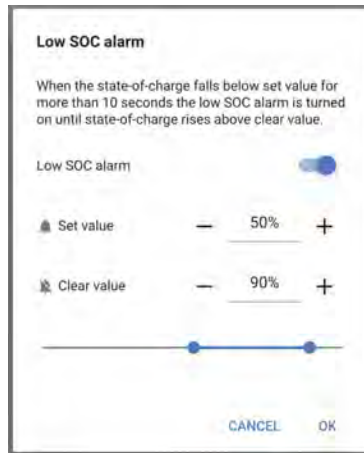

7.4.3. Low voltage alarm

When enabled, the alarm will activate when the battery voltage falls below the set value for more than 10 seconds. The alarm will deactivate when the battery voltage rises above the clear value.

Setting	Default	Range	Steps
Set alarm value (setting 35)	1.1V	0 - 95.0V	0.1V
Clear alarm value (setting 36)	1.0V	0 - 95.0V	0.1V

7.4.4. High voltage alarm

When enabled, the alarm will activate when the battery voltage rises above the set value for more than 10 seconds. The alarm will deactivate when the battery voltage drops below the clear value.

Setting	Default	Range	Steps
Set alarm value (setting 37)	1.1V	0 - 95.0V	0.1V
Clear alarm value (setting 38)	1.0V	0 - 95.0V	0.1V

7.4.5. Low starter voltage alarm

This setting is only available if the Aux input has been set to "Starter battery", see chapter [Aux input \[40\]](#).

When enabled, the alarm will activate when the starter battery voltage falls below the set value for more than 10 seconds. The alarm will deactivate when the starter battery voltage rises above the clear value.

Setting	Default	Range	Steps
Set alarm value (setting 39)	1.1V	0 - 95.0V	0.1V
Clear alarm value (setting 40)	1.0V	0 - 95.0V	0.1V

7.4.6. High starter voltage alarm

This setting is only available if the Aux input has been set to “Starter battery”, see chapter [Aux input \[40\]](#).

When enabled, the alarm will activate when the starter battery voltage rises above the set value for more than 10 seconds and the alarm will deactivate when the starter battery voltage drops below the clear value.

Setting	Default	Range	Steps
Set alarm value (setting 41)	1.1 V	0 - 95.0V	0.1V
Clear alarm value (setting 42)	1.0 V	0 - 95.0V	0.1V

7.4.7. High temperature alarm

This setting is only available if the Aux input has been set to “temperature”, see chapter [Aux input \[40\]](#).

When enabled, the alarm will activate when the battery temperature rises above the set value for more than 10 seconds. The alarm will deactivate when the battery temperature drops below the clear value.

Setting	Default	Range	Step size
Set relay value (setting 43)	0°C	-40 - +99°C	1°C
	0°F	-40 - +210°F	1°F
Clear relay value (setting 44)	0°C	-40 - +99°C	1°C
	0°F	-40 - +210°F	1°F

7.4.8. Low temperature alarm

This setting is only available if the Aux input has been set to “temperature”, see chapter [Aux input \[40\]](#).

When enabled, the alarm will activate when the battery temperature falls below the set value for more than 10 seconds. The alarm will deactivate when the battery temperature rises above the clear value.

Setting	Default	Range	Step size
Set relay value (setting 45)	0°C	-40 - +99°C	1°C
	0°F	-40 - +210°F	1°F
Clear relay value (setting 46)	0°C	-40 - +99°C	1°C
	0°F	-40 - +210°F	1°F

7.4.9. Midpoint deviation alarm

This setting is only available if the Aux input has been set to “Midpoint”; see chapter [Aux input \[40\]](#).

When enabled, the alarm will activate when the midpoint voltage deviation rises above the set value for more than 10 seconds. The alarm will deactivate when the midpoint voltage deviation drops below the clear value.

Setting	Default	Range	Steps
Set alarm value (setting 47)	2 %	0 - 99 %	1 %
Clear alarm value (setting 48)	1 %	0 - 99 %	1 %

7.5. Display settings

7.5.1. Backlight intensity

The intensity of the backlight This setting ranges from 0 (always off) to 9 (maximum intensity).

Setting	Default	Range	Step size
Backlight intensity (setting 49)	5	0 - 9	1

7.5.2. Backlight always on

When set the backlight will not automatically turn off after 60 seconds of inactivity.

Setting	Default	Modes
Backlight always on (setting 50)	OFF	ON OFF

7.5.3. Scroll speed

The scroll speed of the display. This setting ranges from 1 (very slow) to 5 (very fast).

Setting	Default	Range	Step size
Scroll speed (setting 51)	2	1 - 5	1

7.5.4. Main voltage display

Must be set to ON to display the voltage of the main battery in the monitoring menu.

Setting	Default	Modes
Main voltage display (setting 52)	ON	ON OFF

7.5.5. Current display

Must be set to ON to display the current in the monitoring menu.

Setting	Default	Modes
Current display (setting 53)	ON	ON OFF

7.5.6. Power display

Must be set to ON to display the power measurement in the monitoring menu.

Setting	Default	Modes
Power display (setting 54)	ON	ON OFF

7.5.7. Consumed Ah display

Must be set to ON to display the consumed Ah in the monitoring menu.

Setting	Default	Modes
Consumed Ah display (setting 55)	ON	ON OFF

7.5.8. State of charge display

Must be set to ON to display the battery state of charge in the monitoring menu.

Setting	Default	Range	Step size
State of charge display (setting 56)	5	1 - 5	1

7.5.9. Time-to-go display

Must be set to ON to display the state of charge in the monitoring menu.

Setting	Default	Modes
Time-to-go display (setting 57)	ON	ON OFF

7.5.10. Starter voltage display

Must be set to ON to display the auxiliary voltage in the monitoring menu.

Setting	Default	Modes
Starter voltage display (setting 58)	ON	ON OFF

7.5.11. Temperature display

Must be set to ON to display the battery temperature in the monitoring menu.

Setting	Default	Modes
Temperature display (setting 59)	ON	ON OFF

7.5.12. Mid-voltage display

Must be set to ON to display the midpoint deviation percentage in the monitoring menu.

Setting	Default	Modes
Mid-voltage display (setting 60)	ON	ON OFF

7.6. Miscellaneous settings

7.6.1. Software version

Setting 61

This is a read-only setting. It displays the firmware version of the battery monitor.

The software version as displayed on the head unit is the same as the firmware version as displayed in the VictronConnect app product settings. In addition to this, the VictronConnect app also allows updating of the firmware. For more information see the [Firmware \[42\]](#) setting.

Setting	Default	Mode
Software version (setting 61)	Displays the battery monitor firmware version.	Read-only

7.6.2. Restore defaults

Setting 62

This head unit setting resets all settings to factory default.

The defaults can also be restored via the VictronConnect app. For more information on how to do this see the [Reset to defaults \[43\]](#) chapter.

To restore defaults do the following:

- Navigate to setting 62: the text "restore defaults" is displayed
- Press SELECT on the head unit: the blinking text "reset" is displayed.
- Press SELECT again: a beep is heard, and all settings have gone back to factory default.
- Should the reset function have been entered accidentally and the text "reset" is blinking, press SETUP to leave and go back to the regular settings menu.

Note that restoring the defaults does not clear the history settings. To clear the history see the [Clear history \[39\]](#) setting.

When in normal operating mode, the factory settings can also be restored by pressing SETUP and SELECT simultaneously for 3 seconds on the head unit. Note that this is only possible if the [Lock setup \[39\]](#) setting is off.

7.6.3. Clear history

Setting 63

This setting resets all settings to factory default. To clear the history do the following:

- Navigate to setting 63: the text "clear history" is displayed
- Press SELECT on the head unit: the blinking text "clear" is displayed.
- Press SELECT again: a beep is heard and all settings have gone back to factory default.
- Should the reset function have been entered accidentally and the text "clear" is blinking, press SETUP to leave and go back to the regular settings menu.

The history can also be cleared via the VictronConnect app, for more information on how to do this see the [Reset history \[41\]](#) chapter.



Please be aware that history data is an important tool to keep track of battery performance and is also needed to diagnose possible battery problems. Do not clear the history unless the battery bank is replaced.

7.6.4. Lock setup

When on, all settings (except this one) are locked (read-only) and cannot be altered via the head unit. Note that they still can be altered via the VictronConnect app.

Setting	Default	Modes
Lock setup (setting 64)	OFF	ON/OFF

7.6.5. Shunt current

When a shunt other than the one supplied with the battery monitor is used, use this setting to set the rated current of the shunt.

Setting	Default	Range	Step size
Shunt current (setting 65)	500A	1 - 9999A	1A

7.6.6. Shunt voltage

When a shunt other than the one supplied with the battery monitor is used, use this setting to change the rated voltage of the shunt.

Setting	Default	Range	Step size
Shunt voltage (setting 66)	50mV	1 - 75mV	1mV

7.6.7. Temperature unit

This setting is available if the aux input has been set to "Temperature", see the [Aux input \[40\]](#) setting.

Use this setting to select the temperature unit the battery monitor head unit is using.

Note that this setting only affects the battery monitor head unit display and settings. To change the temperature unit in the VictronConnect app see [Temperature unit setting \[41\]](#).

Setting	Default	Modes
Temperature unit (setting 67)	CELC	CELC/FAHR

7.6.8. Temperature coefficient

This setting is available if the aux input has been set to "Temperature", see the [Aux input \[40\]](#) setting.

The available battery capacity decreases with temperature. The temperature coefficient (ΔT) is the percentage the battery capacity changes with temperature when temperature decreases to less than 20°C (above 20°C the influence of temperature on capacity is relatively low and is not taken into account). Typically, the reduction, compared to the capacity at 20°C, is 18% at 0°C and 40% at -20°C.

The unit of this value is "%cap/°C" or per cent capacity per degree Celsius.

The typical value (below 20°C) is 1%cap/°C for lead acid batteries, and 0.5%cap/°C for LFP batteries.

Setting	Default	Range	Step size
Temperature coefficient (setting 68)	0.0%cap/°C	0 - 2.0%cap/°C	0.1%cap/°C
	0.0%cap/°F	0 - 3.6%cap/°F	0.1%cap/°F

7.6.9. Aux input

This setting sets the function of the auxiliary input. Select between: None, Starter battery, Midpoint or Temperature.

Setting	Default	Modes	Description
Aux input (setting 69)	NONE	NONE	Disables the auxiliary input.
		START	Auxiliary voltage, e.g. a starter battery
		MID	Midpoint voltage
		TEMP	Battery temperature. Note that a special temperature sensor is needed. For more information see: Auxiliary connection for temperature monitoring [9]

7.6.10. Battery starts synchronised

Note that if the battery monitor settings are accessed via the head unit, this setting will be part of the miscellaneous setting, and if accessed via VictronConnect it will be part of the battery settings.

For full information about this setting see the [Battery starts synchronised \[30\]](#) chapter.

Setting	Default	Modes
Start synchronized (setting 70)	ON	ON/OFF

7.6.11. Bluetooth mode

Determines whether to enable Bluetooth. If turned OFF using the VictronConnect app, the Bluetooth functionality is not disabled until disconnected from the BMV.

Setting	Default	Modes
Bluetooth mode (setting 71)	ON	ON/OFF

7.6.12. Monitor Mode

Setting 72

If you wish to use the battery monitor to monitor individual DC circuits rather than as a whole-of-system battery monitor, you can change the "Monitor mode" setting in the "Misc" menu from "Battery Monitor" to "DC Energy Meter".

If "DC meter" is selected, you can select the following types:

Solar charger, Wind charger, Shaft generator, Alternator, Fuel cell, Water generator, DC-DC charger, AC charger, Generic source, Generic load, Electric drive, Fridge, Water pump, Bilge pump, DC system, Inverter, Water heater.

When connected to a GX device, the type, the current and the power is shown in the user interface, and this information is also available on the VRM Portal.

When the GX device is also configured as type "has DC System", the GX does more than just recording and visualisation:

1. The power shown in the DC system box is the sum of power reported by all battery monitors configured as such. Having multiple meters can be useful, for example, in a catamaran, so that the DC systems in the port hull and in the starboard hull are being measured.
2. The DC system current is being compensated for when setting DVCC charge current limits to inverter/chargers and solar chargers. For example, when a load of 50A is being measured, and CCL by the battery is 25A, the limit given to the inverter/charger or solar charger is 75A.

See the GX device documentation for more information about these advanced features, especially refer to the [Distributed voltage and current control](#) chapter.

7.7. Additional settings

These VictronConnect settings are not located in the VictronConnect settings menu but are located elsewhere in the VictronConnect app.

7.7.1. Reset history

This setting can be found at the bottom of the history tab.

This setting can also be made via the head unit. For more information see the [Clear history \[39\]](#) chapter.



Please be aware that history data is an important tool to keep track of battery performance and is also needed to diagnose possible battery problems. Do not clear the history unless the battery bank is replaced.

7.7.2. Reset PIN code

Note that the PIN code is only applicable when connecting to the battery monitor via Bluetooth.

This setting can be found in the settings of the VictronConnect app itself. Leave the battery monitor by clicking on the ← arrow. This will bring you back to the device list of the VictronConnect app. Now, click on the menu symbol next to the battery monitor listing.

A new window will open which allows you to reset the PIN code back to its default: 000000. To be able to reset the PIN code you will need to enter the battery monitor unique PUK code. The PUK code is printed on the product information sticker on the Battery monitor.

7.7.3. Temperature unit setting

This setting can be found in the settings of the VictronConnect app itself. Leave the battery monitor page by clicking on the ← arrow. This will bring you back to the device list of the VictronConnect app. Click on the menu  symbol and then click on the

settings  symbol. Here you can select the “Display temperature unit”. Selecting Celsius will display the temperature in °C and selecting Fahrenheit will display the temperature in °F.

7.7.4. Serial number

The serial number can be found in the battery monitor product info section of the VictronConnect app or on the product information sticker rear of the battery monitor head unit.

7.7.5. Disabling and re-enabling Bluetooth

Bluetooth is enabled by default in the battery monitor. If Bluetooth is not wanted it can be disabled. This is done by sliding the Bluetooth switch in the product settings.

A reason to disable Bluetooth could be for security reasons, or to eliminate unwanted transmission from the Battery monitor.

As soon as Bluetooth has been disabled the only way to communicate with the battery monitor is via its VE.Direct port.

This is done via the USB to VE.Direct interface or via a GX device connected to the battery monitor via a VE.Direct cable or the USB to VE.Direct interface. For more info see the [VictronConnect app via USB \[25\]](#) chapter.

Bluetooth can be re-enabled by connecting to the battery monitor with VictronConnect via the VE.Direct – USB interface. Once connected you can navigate to the product settings menu and re-enable Bluetooth.

For more information also see the [VictronConnect manual](#).



VictronConnect product info screen.

7.7.6. Changing PIN code

In the battery monitor Bluetooth interface product info the PIN code can be changed.

7.7.7. Custom name

In the battery monitor product information screen, you can change the name of the battery monitor. By default, it is called by its product name. But a more applicable name might be needed, especially if you are using multiple battery monitors in close proximity of each other it might become confusing with which battery monitor you are communicating. You can, for example, add identification numbers to their name, like: Battery Monitor A, Battery Monitor B and so on.

7.7.8. Firmware

Both the battery monitor and its Bluetooth interface run on firmware.

Occasionally a newer firmware version is available. New firmware is released to either add features or to fix a bug. The product overview in the VictronConnect app displays the battery monitor and the Bluetooth interface firmware version. It also indicates whether the firmware is the latest version, and there is a button you can press to update the firmware.

On the first installation, it is always recommended to update to the most recent firmware (if available). Whenever you connect to the battery monitor with an up-to-date version of the VictronConnect app, it will check the firmware, and if there is a newer version available, it will ask you to update the firmware. The VictronConnect app contains the actual firmware files, so an internet connection is not needed to update to the most recent firmware as long as you are using the most up-to-date version of the VictronConnect app.

A firmware update is not mandatory. If you choose not to update the firmware, you can only read out the battery monitor, but you cannot change settings. Settings can only be changed if the battery monitor runs on the most recent firmware.

For more information on firmware updates also see the VictronConnect app manual [Firmware update chapter](#).

This setting is also available via the head unit [Software version \[39\]](#) setting. But note that this is a read-only setting. The firmware cannot be updated via the head unit.

7.7.9. Reset to defaults

To set all settings back to default select “Reset to defaults”. Please note that this only resets all settings to their default values, the history is not reset.

This setting is also available via the head unit. For more information see the [Restore defaults \[39\]](#) chapter.

8. Battery capacity and Peukert exponent

Battery capacity is expressed in Amp hour (Ah) and indicates how much current a battery can supply over time. For example, if a 100Ah battery is being discharged with a constant current of 5A, the battery will be totally discharged in 20 hours.

The rate at which a battery is being discharged is expressed as the C rating. The C rating indicates how many hours a battery with a given capacity will last. 1C is the 1h rate and means that the discharge current will discharge the entire battery in 1 hour. For a battery with a capacity of 100Ah, this equates to a discharge current of 100A. A 5C rate for this battery would be 500A for 12 minutes (1/5 hours), and a C5 rate would be 20A for 5 hours.



There are two ways of expressing the C rating of a battery. Either with a number before the C or with a number after the C.

For example:

- 5C is the same as C0.2
- 1C is the same as C1
- 0.2C is the same as C5

The capacity of a battery depends on the rate of discharge. The faster the rate of discharge, the less capacity will be available. The relation between slow or fast discharge can be calculated by Peukert's law and is expressed by the Peukert exponent. Some battery chemistries suffer more from this phenomenon than others. Lead acid are more affected by this than lithium batteries are. The battery monitor takes this phenomenon into account with Peukert exponent.

Discharge rate example

A lead acid battery is rated at 100Ah at C20, this means that this battery can deliver a total current of 100A over 20 hours at a rate of 5A per hour. $C20 = 100Ah (5 \times 20 = 100)$.

When the same 100Ah battery is discharged completely in two hours, its capacity is greatly reduced. Because of the higher rate of discharge, it may only give $C2 = 56Ah$.

Peukert's formula

The value which can be adjusted in Peukert's formula is the exponent n: see the formula below.

In the battery monitor the Peukert exponent can be adjusted from 1.00 to 1.50. The higher the Peukert exponent the faster the effective capacity 'shrinks' with increasing discharge rate. An ideal (theoretical) battery has a Peukert exponent of 1.00 and has a fixed capacity regardless of the size of the discharge current. The default setting in the battery monitor for the Peukert exponent is 1.25. This is an acceptable average value for most lead acid batteries.

Peukert's equation is stated below:

$C_p = I^n \times t$ Where Peukert's exponent n is:

$$n = \frac{\log t_2 - \log t_1}{\log I_1 - \log I_2}$$

To calculate the Peukert exponent you will need two rated battery capacities. This is usually the 20h discharge rate and the 5h rate, but can also be the 10h and 5h, or the 20h and the 10h rate. Ideally use a low discharge rating together with a substantially higher rating. Battery capacity ratings can be found in the battery datasheet. If in doubt contact your battery supplier.

Calculation example using the 5h and the 20h rating

The C5 rating is 75Ah. The t1 rating is 5h and I1 is calculated:

$$I_1 = \frac{75Ah}{5h} = 15A$$

The C20 rating is 100Ah. The t2 rating is 20h and I2 is calculated:

$$I_2 = \frac{100Ah}{20h} = 5A$$

The Peukert exponent is:

$$n = \frac{\log 20 - \log 5}{\log 15 - \log 5} = 1.26$$

A Peukert calculator is available at <http://www.victronenergy.com/support-and-downloads/software#peukert-calculator>.

Please note that the Peukert exponent is no more than a rough approximation of reality. In case of very high currents, the battery will give even less capacity than predicted by a fixed exponent. We do not recommend changing the default value in the battery monitor, except in the case of lithium batteries.

9. Midpoint voltage monitoring

One bad cell or one bad battery can destroy a large, expensive battery bank.

A short circuit or high internal leakage current in one cell for example will result in undercharge of that cell and overcharge of the other cells. Similarly, one bad battery in a 24V or 48V bank of several series/parallel connected 12V batteries can destroy the whole bank.

Moreover, when new cells or batteries are connected in series, they should all have the same initial state of charge. Small differences will be ironed out during absorption or equalize charging, but large differences will result in damage during charging due to excessive gassing of the cells or batteries with the highest initial state of charge.

A timely alarm can be generated by monitoring the midpoint of the battery bank (i.e. by splitting the string voltage in half and comparing the two string voltage halves).

The midpoint deviation will be small when the battery bank is at rest, and will increase:

- At the end of the bulk phase during charging (the voltage of well charged cells will increase rapidly while lagging cells still need more charging).
- When discharging the battery bank until the voltage of the weakest cells starts to decrease rapidly.
- At high charge and discharge rates.

9.1. Battery bank and midpoint wiring diagrams

9.1.1. Connecting and monitoring midpoint in a 24V battery bank

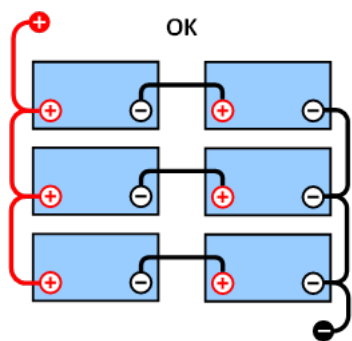

GOOD: The midpoints are not connected and without busbars or midpoint monitoring.

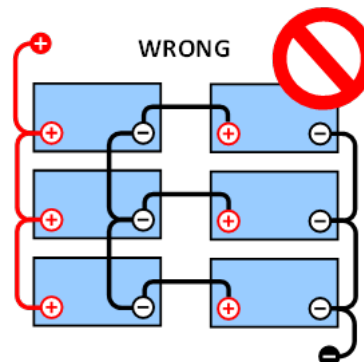

WRONG: The midpoints are connected and without busbars or midpoint monitoring.

Due to the voltage drop over the positive and the negative cables the midpoint voltage is not identical.

In an unmonitored battery bank, the midpoints should not be interconnected; since one bad battery bank can go unnoticed and could damage all other batteries.

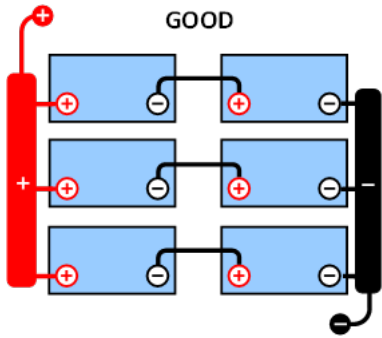

GOOD: The midpoints are not connected; busbars are used but without midpoint monitoring.

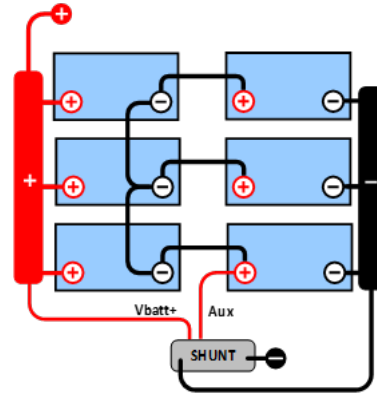

GOOD: The midpoints are connected, with busbars and midpoint monitoring.

Always use busbars when applying midpoint voltage monitoring. The cables to the busbars must all have the same length. The midpoints can only be connected if corrective action is taken in case of an alarm.

9.1.2. Connecting and monitoring midpoint in a 48V battery bank

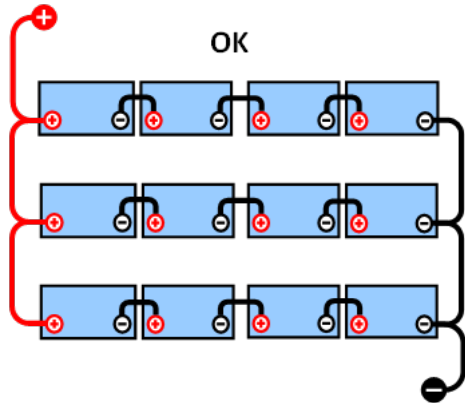

GOOD: The midpoints are not connected and without busbars or midpoint monitoring.

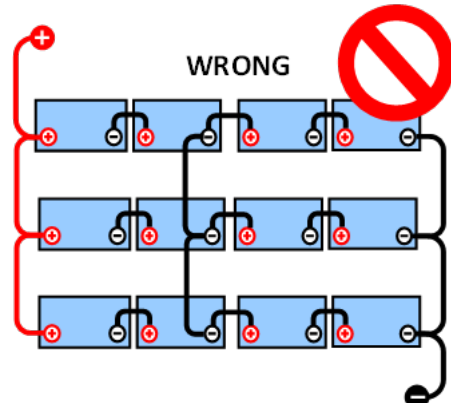

WRONG: The midpoints are connected and without busbars or midpoint monitoring.

Due to the voltage drop over the positive and the negative cables the midpoint voltage is not identical.

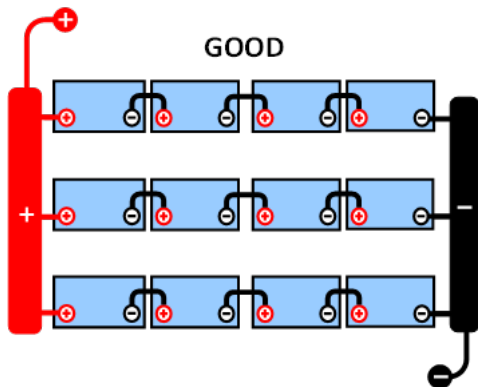

GOOD: The midpoints are not connected; busbars are used and without midpoint monitoring.

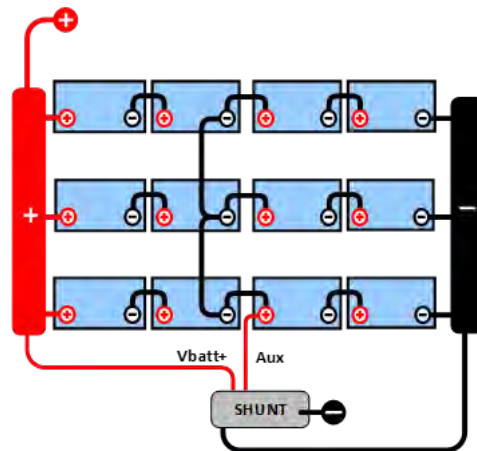

GOOD: The midpoints are connected, busbars are used and with midpoint monitoring.

In an unmonitored battery bank the midpoints should not be interconnected, one bad battery bank can go unnoticed and could damage all other batteries.

Always use busbars when applying midpoint voltage monitoring. The cables to the busbars must all have the same length.

Midpoints can only be connected if corrective action is taken in case of an alarm.

9.2. Midpoint deviation calculation

The battery monitor measures the midpoint and then calculates the deviation in a percentage from what the midpoint should be.

$$\text{Deviation} = \frac{100 \times (\text{top string voltage} - \text{bottom string voltage})}{\text{battery voltage}}$$

$$d = \frac{100 \times (V_t - V_b)}{V}$$

Where:

d is the deviation in %

V_t is the top string voltage

V_b is the bottom string voltage

V is the voltage of the battery ($V = V_t + V_b$)

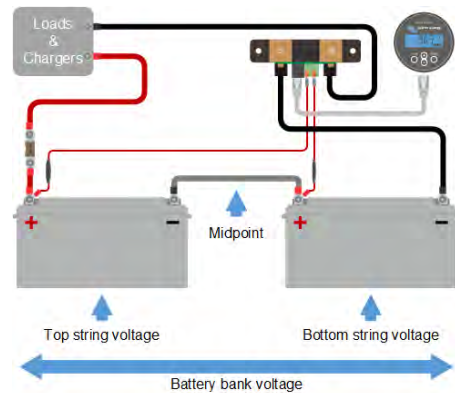

9.3. Setting the alarm level

In case of VRLA (gel or AGM) batteries, gassing due to overcharging will dry out the electrolyte, increasing internal resistance and ultimately resulting in irreversible damage. Flat plate VRLA batteries start to lose water when the charge voltage approaches 15V (12V battery). Including a safety margin, the midpoint deviation should therefore remain below 2% during charging. When, for example, charging a 24V battery bank at 28.8V absorption voltage, a midpoint deviation of 2% would result in:

$$V_t = \frac{V \times d}{100} + V_b = \frac{V \times d}{100} + V - V_t = V \times \frac{1 + \frac{d}{100}}{2}$$

$$V_t = V \times \frac{1 + \frac{d}{100}}{2} \quad \text{and} \quad V_b = V \times \frac{1 - \frac{d}{100}}{2}$$

$$V_t = 28.8 \times \frac{1 + \frac{2}{100}}{2} \approx 14.7 \quad \text{and} \quad V_b = 28.8 \times \frac{1 - \frac{2}{100}}{2} \approx 14.1$$

Obviously, a midpoint deviation of more than 2% will result in overcharging the top battery and undercharging the bottom battery. These are two good reasons to set the midpoint alarm level at not more than $d = 2\%$.

This same percentage can be applied to a 12V battery bank with a 6V midpoint.

In case of a 48V battery bank consisting of 12V series connected batteries, the % influence of one battery on the midpoint is reduced by half. The midpoint alarm level can therefore be set at a lower level.

9.4. Alarm delay

An alarm delay is in place to prevent the occurrence of alarms during short-term deviations that will not damage a battery. The alarm is triggered when the deviation exceeds the set alarm value for more than 5 minutes. If the deviation exceeds the set alarm value by a factor of two or more, the alarm will trigger after 10 seconds.

9.5. What to do in case of an alarm during charging

In case of a new battery bank the alarm is usually due to differences in the initial state of charge of the individual battery. If the deviation increases to more than 3% you should stop charging the battery bank and charge the individual batteries or cells separately. Another way is to substantially reduce the charge current to the battery bank, this will allow the batteries to equalize over time.

If the problem persists after several charge-discharge cycles do the following:

- In case of series/parallel connection disconnect the midpoint, parallel connection wiring and measure the individual midpoint voltages during absorption charging to isolate batteries or cells which need additional charging.
- Charge and then test all batteries or cells individually.

In case of an older battery bank which has performed well in the past the problem may be due to systematic undercharge. In this case more frequent charging or an equalization charge is needed. Please note that only flooded deep cycle flat plate or OPzS batteries can be equalized. Better and regular charging will solve the problem.

In case there are one or more faulty cells:

- In case of series/parallel connection disconnect the midpoint, parallel connection wiring and measure the individual midpoint voltages during absorption charging to isolate batteries or cells which need additional charging.
- Charge and then test all batteries or cells individually.

9.6. What to do in case of an alarm during discharging

The individual batteries or cells of a battery bank are not identical, and when fully discharging a battery bank, the voltage of some cells will start dropping earlier than others. The midpoint alarm will therefore nearly always trip at the end of a deep discharge.

If the midpoint alarm trips much earlier (and does not trip during charging), some batteries or cells may have lost capacity or may have developed a higher internal resistance than others. The battery bank may have reached the end of service life, or one or more cells or batteries have developed a fault:

- In case of series/parallel connection, disconnect the midpoint parallel connection wiring and measure the individual midpoint voltages during discharging to isolate faulty batteries or cells.
- Charge and then test all batteries or cells individually.

9.7. The Battery Balancer

A consideration can be made to add a [Battery Balancer](#) to the system. A Battery Balancer will equalize the state of charge of two series connected 12V batteries, or of several parallel strings of series connected batteries.

When the charge voltage of a 24V battery system increases to more than 27.3V, the Battery Balancer will turn on and compare the voltage over the two series connected batteries. The Battery Balancer will draw a current of up to 0.7A from the battery (or parallel connected batteries) with the highest voltage. The resulting charge current differential will ensure that all batteries will converge to the same state of charge. If needed, several balancers can be paralleled.

A 48V battery bank can be balanced with three Battery Balancers, one between each battery.

For more information see the Battery Balancer product page: <https://www.victronenergy.com/batteries/battery-balancer>.

10. Troubleshooting

10.1. Functionality issues

10.1.1. Unit is dead

On first connection the display of the head unit should be active.

If this is not the case check the fuse in the +B1 cable and also check the cable itself and its terminals.

In case the temperature sensor is used:

- The temperature sensor M8 cable lug must be connected to the positive pole of the battery bank (the red wire of the sensor doubles as the power supply wire).
- Check the fuse in the positive (red) cable.
- Make sure the correct temperature sensor is used. Note that the MultiPlus temperature sensor is not suitable.
- Make sure the temperature sensor has been connected the right way. The red cable should connect the +B1 terminal and the black wire to the +B2 terminal.

See the [Auxiliary connection for temperature monitoring \[9\]](#) chapter for connection instructions and a wiring diagram.

10.1.2. Auxiliary port not working

Check the fuse in the +B2 cable and also check the cable itself and its terminals.

In case a second battery (starter battery) is monitored:

Make sure the second battery negative is connected to the load side of the battery monitor shunt. See the chapter [Auxiliary connection for monitoring the voltage of a second battery \[8\]](#) for connection instructions and a wiring diagram.

In case the temperature sensor is used:

- The temperature sensor M8 cable lug must be connected to the positive pole of the battery bank (the red wire of the sensor doubles as the power supply wire).
- Check the fuse in the positive (red) cable.
- Make sure the correct temperature sensor is used. The MultiPlus temperature sensor does not work with the battery monitor.
- Make sure the temperature sensor has been connected the right way. The red cable should connect to the +B1 terminal and the black wire to the Aux+B2 terminal.

See the [Auxiliary connection for temperature monitoring \[9\]](#) chapter for connection instructions and a wiring diagram.

10.1.3. Unable to change VictronConnect settings

Settings can only be changed if the battery monitor is running on the most up to date firmware. Update to the latest firmware with the VictronConnect app.

10.2. Connection issues

10.2.1. Cannot connect via Bluetooth

It is highly unlikely that the Bluetooth interface is faulty. Some pointers to try before seeking support:

- Is the battery monitor powered up? The display on the head unit should be active. If not see the [Unit is dead \[50\]](#) chapter.
- Is another phone or tablet already connected to the battery monitor? Only one phone or tablet can be connected to the battery monitor at any given time. Make sure no other devices are connected and try again.
- Is the VictronConnect app up to date?
- Are you close enough to the battery monitor? In an open space, the maximum distance is about 20 meters.
- Are you using the Windows version of the VictronConnect app? This version is unable to connect via Bluetooth. Use Android, iOS or macOS instead (or use the USB - VE.Direct interface).

For connection issues, see the troubleshooting section of the VictronConnect manual: <https://www.victronenergy.com/live/victronconnect:start>.

10.2.2. PIN code lost

Note that the PIN code is only applicable when connecting to the battery monitor via Bluetooth.

If you have lost the PIN code you will need to reset the PIN code to its default PIN code, see the [Reset PIN code \[41\]](#) chapter.

More information and specific instructions can be found in the VictronConnect manual: <https://www.victronenergy.com/live/victronconnect:start>.

10.3. Incorrect readings

10.3.1. Charge and discharge current are inverted

The charge current should be shown as a positive value. For example: 1.45A.

The discharge current should be shown as a negative value. For example: -1.45A.

If the charge and discharge currents are reversed, the negative power cables on the battery monitor must be swapped.

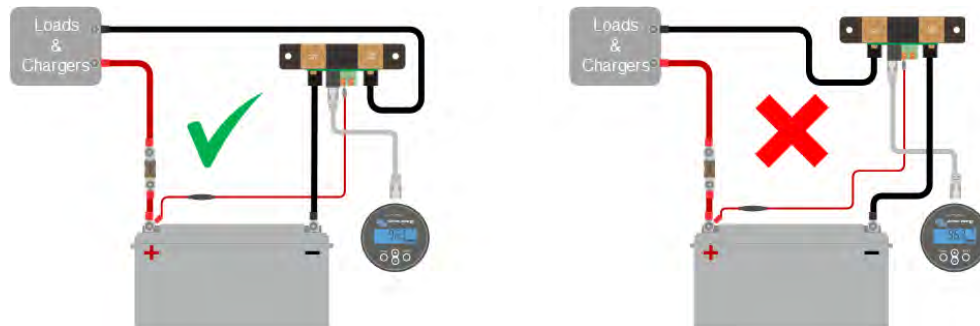

10.3.2. Incomplete current reading

The negatives of all the loads and the charge sources in the system must be connected to the system minus side of the shunt.

If the negative of a load or a charge source is connected directly to the negative battery terminal or the "battery minus" side on the shunt, their current will not flow through the battery monitor and will be excluded from the overall current reading and the state of charge reading.

The battery monitor will display a higher state of charge than the actual state of charge of the battery.

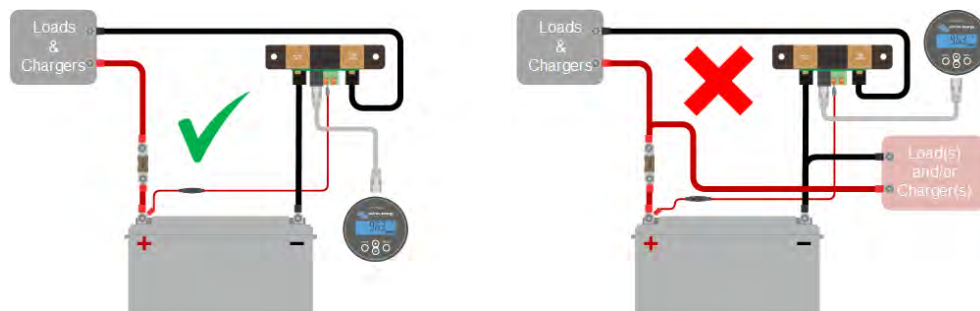

10.3.3. There is a current reading while no current flows

If there is a current reading while no current is flowing through the battery monitor, perform a [zero current calibration \[31\]](#) while all loads are turned off or set the [current threshold \[30\]](#).

10.3.4. Incorrect state of charge reading

An incorrect state of charge can be caused by a variety of reasons.

Incorrect battery settings

The following parameter(s) will have an effect on the state of charge calculations if they have been set up incorrectly:

- Battery capacity.
- Peukert exponent.
- Charge efficiency factor.

Incorrect state of charge due to a synchronisation issue:

The state of charge is a calculated value and will need to be reset (synchronised) every now and then.

The synchronisation process is automatic and is performed each time the battery is fully charged. The battery monitor determines that the battery is fully charged when all 3 "charged" conditions have been met. The "charged" conditions are:

- Charged voltage (Voltage).
- Tail current (% of battery capacity).
- Charge detection time (minutes).

A practical example of the conditions that need to be met before a synchronisation will take place:

- The battery voltage has to be above 13.8V.
- The charge current has to be less than $0.04 \times$ battery capacity (Ah). For a 200Ah battery, this is $0.04 \times 200 = 8A$.
- Both above conditions have to be stable for 3 minutes.

If the battery is not fully charged or if the automatic synchronisation does not happen, the state of charge value will start to drift and will eventually not represent the actual state of charge of the battery.

The following parameter(s) will have an effect on automatic synchronisation if they have been set incorrectly:

- Charged voltage.
- Tail current.
- Charged detection time.
- Not occasionally fully charging the battery.

For more information on these parameters see the chapter: "Battery settings".

Incorrect state of charge due to incorrect current reading:

The state of charge is calculated by looking at how much current flows in and out of the battery. If the current reading is incorrect, the state of charge will also be incorrect. See paragraph [Incomplete current reading \[51\]](#).

10.3.5. State of charge is missing

This means that the battery monitor is in an unsynchronised state. This can occur when the battery monitor has just been installed or after it has been unpowered for some time and is being powered up again.

To fix this, fully charge the battery. Once the battery is close to a full charge, the battery monitor should synchronise automatically. If that doesn't work, review the synchronisation settings.

If you know the battery is fully charged but don't want to wait until the battery synchronises, then perform a manual synchronisation, see paragraph [Synchronise SoC to 100% \[31\]](#).

10.3.6. State of charge does not reach 100%

The battery monitor will automatically synchronise and reset the state of charge to 100% as soon as the battery has been fully charged. In case the battery monitor does not reach a 100% state of charge, do the following:

- Fully charge the battery and check if the battery monitor correctly detects if the battery is fully charged.
- If the battery monitor does not detect that the battery has been fully charged you will need to check or adjust the charged voltage, tail current and/or charged time settings. For more information see [Automatic synchronisation \[23\]](#).

10.3.7. State of charge always shows 100%

One reason could be that the negative cables going in and out of the battery monitor have been wired the wrong way around, see [Charge and discharge current are inverted \[51\]](#).

10.3.8. State of charge does not increase fast enough or too fast when charging

This can happen when the battery monitor thinks the battery is bigger or smaller than in reality. Check if the [battery capacity \[15\]](#) has been set correctly.

10.3.9. Incorrect battery voltage reading

Check if there is an issue with the +B1 cable. Perhaps the fuse, the cable itself or one of the terminals is faulty or there is a loose connection.

Check for incorrect wiring: the +B1 cable has to be connected to the positive of the battery bank, not midway of the battery bank.

In case a temperature sensor is used, make sure the sensor is connected to the positive terminal of the battery bank, not in the middle of the battery bank.

10.3.10. Incorrect auxillary battery voltage reading

If the auxillary (starter) battery voltage is too low:

- Perhaps there is an issue with the +B2 cable, perhaps the fuse, the cable itself or one of the terminals is faulty, or there is a loose connection.

If the auxillary (starter) battery voltage reading is missing:

- Make sure that both batteries share a common negative and that the starter battery negative is connected to the load side of the battery monitor shunt. For instructions on how to correctly wire the starter battery, see [Aux connection for monitoring the voltage of a second battery \[8\]](#).

10.3.11. Synchronisation issues

If the battery monitor does not synchronise automatically, one possibility could be that the battery never reaches a fully charged state. Fully charge the battery and see if the state of charge eventually indicates 100%.

Another possibility is that the [charged voltage setting \[29\]](#) should be lowered and/or the [tail current setting \[29\]](#) should be increased.

It is also possible that the battery monitor synchronises too early. This can happen in solar systems or in systems that have fluctuating charge currents. If this is the case change the following settings:

- Increase the "[charged voltage \[29\]](#)" to slightly below the absorption charge voltage. For example: 14.2V in case of 14.4V absorption voltage (for a 12V battery).
- Increase the "[charged detection time \[29\]](#)" and/or decrease the "[tail current \[29\]](#)" to prevent an early reset due to passing clouds.

11. Technical data

11.1. Technical data

Battery monitor	BMV-712 Smart
Supply voltage range	6.5 - 70 Vdc
Current draw (backlight off)	< 1mA
Input voltage range, auxiliary battery	6.5 - 70Vdc
Battery capacity (Ah)	1 - 9999Ah
Operating temperature range	-40 +50°C (-40 - 120°F)
Measures voltage of second battery, temperature* or midpoint	Yes
Temperature measurement range*	-20 +50°C (-4 - 120°F)
VE.Direct communication port	Yes
Bistable relay	60V / 1A normally open (function can be inverted)
RESOLUTION & ACCURACY (with a 500A shunt)	
Current	± 0.01A
Voltage	± 0.01V
Amp hours	± 0.1Ah
State of charge (0 - 100%)	± 0.1%
Time-to-go	± 1 min
Temperature (0 - 50°C or 30 - 120°F) *	± 1°C/°F
Accuracy of current measurement	± 0.4%
Accuracy of voltage measurement	± 0.3%
INSTALLATION & DIMENSIONS	
Installation	Flush mount
Head unit front diameter	63mm (2.5 inch)
Head unit front bezel	69 x 69mm (2.7 x 2.7 inch)
Shunt connection bolts	M10 (0.3937 inch)
Head unit body diameter and depth	52mm (2.0 inch) and 31mm (1.2 inch)
Head unit protection category	IP55 (not intended for outdoor use)
STANDARDS	
Safety	EN 60335-1
Emission / Immunity	EN 55014-1 / EN 55014-2
Automotive	ECE R10-4 / EN 50498
ACCESSORIES	
Shunt (included)	500A / 50mV
Cables (included)	10 meter 6 core UTP with RJ12 connectors, 1 cable 2 cables with 1A slow blow fuse for the battery positive connection
Temperature sensor	Optional (ASS000100000)

* Only when the optional temperature sensor is connected, the [Temperature sensor for BMV-712 Smart and BMV-702](#). This temperature sensor is not included.

12. Appendix

12.1. Dimensions BMV head unit

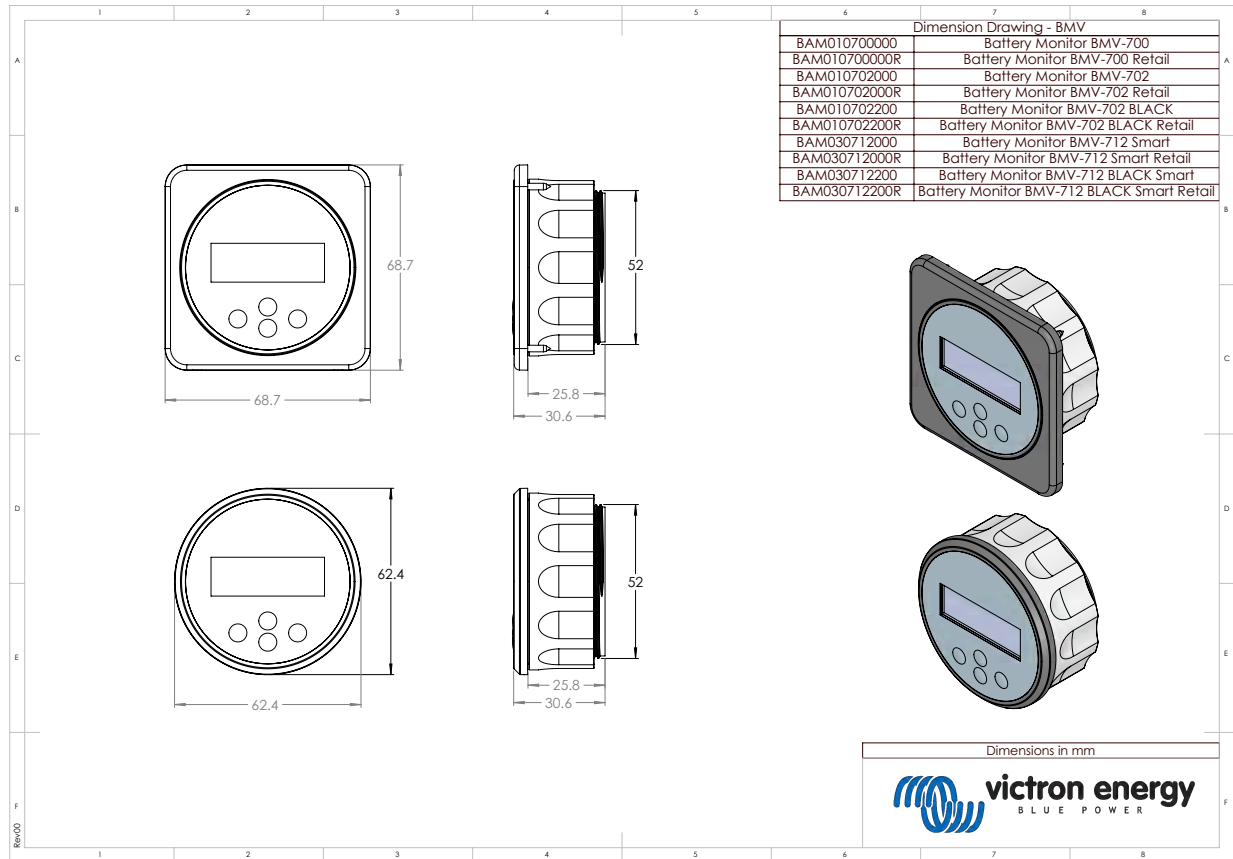

12.2. Dimensions shunt

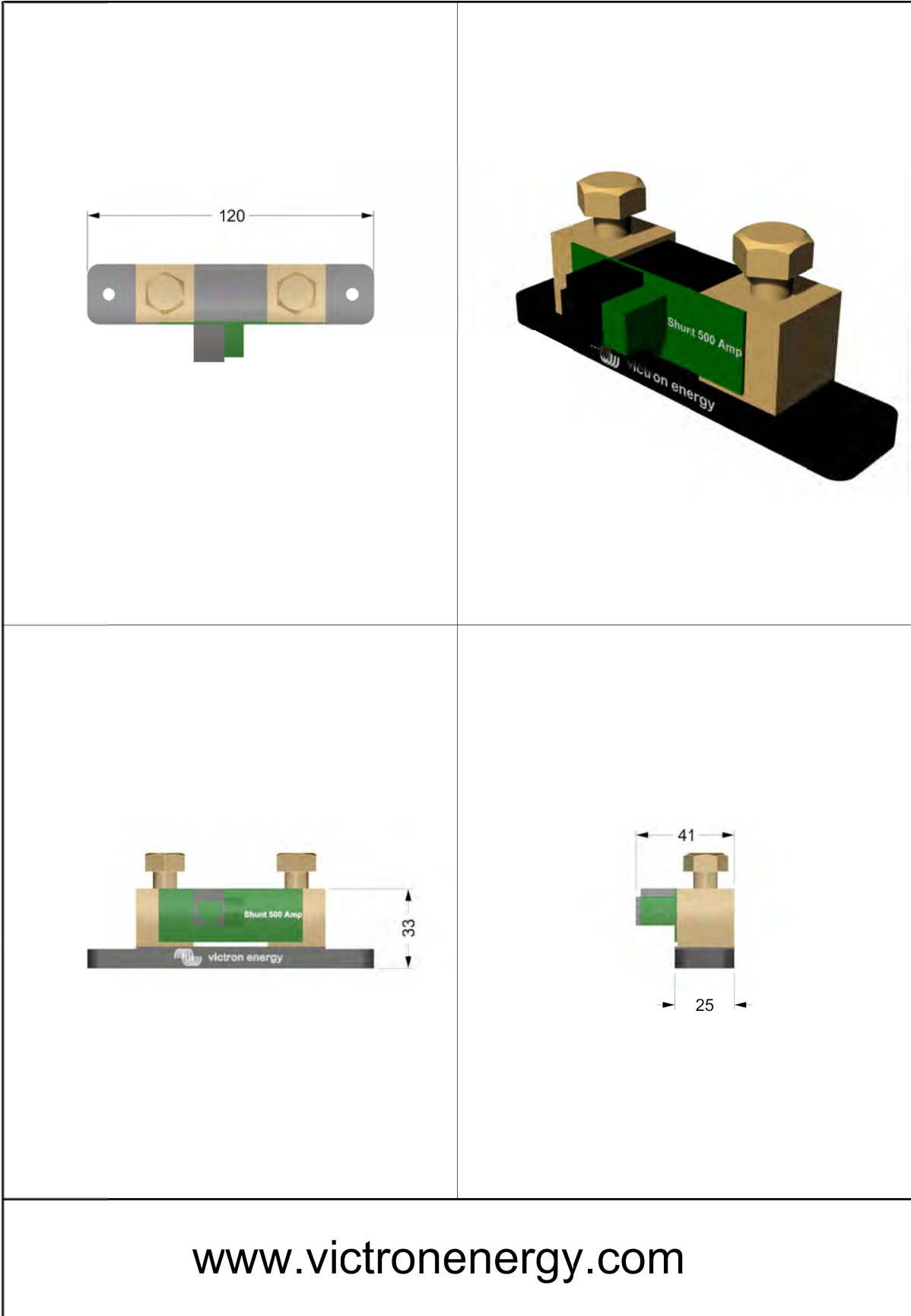

TRISTAR MPPT™

Solar Charging System Controller

Installation, Operation and Maintenance Manual



•••••

Solar Battery Charger

With

TrakStar™ Maximum Power Point Tracking Technology

•••••



www.morningstarcorp.com

MODELS

TS-MPPT-30
TS-MPPT-45
TS-MPPT-60
TS-MPPT-60M



Dimensions in Inches [Millimeters]

TABLE OF CONTENTS

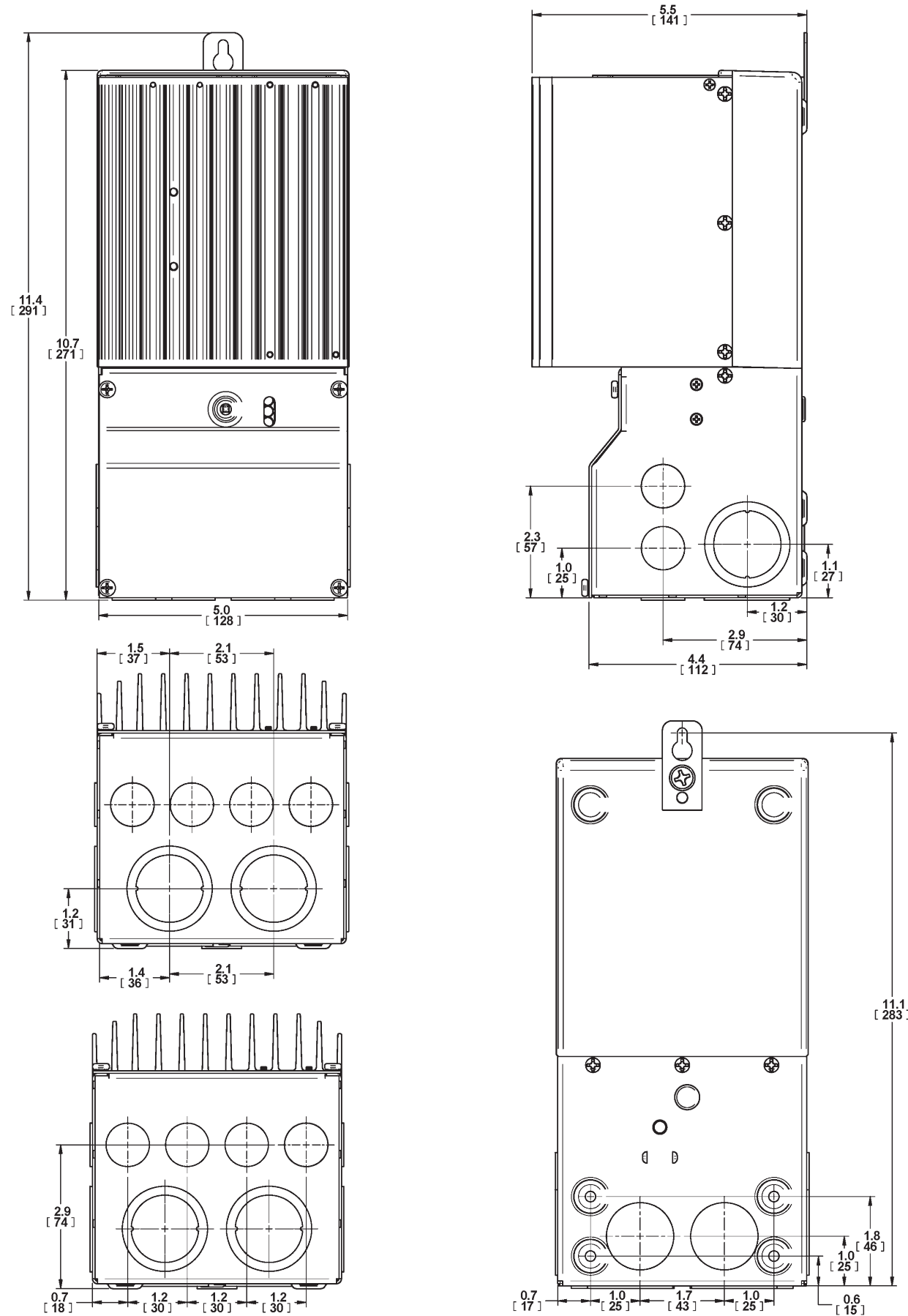

1.0 Important Safety Instructions	4
2.0 Getting Started	10
2.1 Overview	10
2.2 Versions and Ratings	10
2.3 Features	11
2.4 Regulatory Information	13
2.5 Optional Accessories	14
3.0 Installation	16
3.1 General Information	16
3.2 Controller Installation	18
4.0 Operation	34
4.1 TrakStar™ MPPT Technology	34
4.2 Battery Charging Information	36
4.3 Push-button	43
4.4 LED Indications	44
4.5 Protections, Faults & Alarms	45
4.6 Inspection and Maintenance	49
5.0 Networking and Communication	51
5.1 Introduction	51
5.2 Morningstar MeterBus™	52
5.3 Serial RS-232	53
5.4 EIA-485 (formerly RS-485)	55
5.5 Ethernet	56
6.0 Troubleshooting	61
7.0 Warranty and Claim Procedure	63
8.0 Specifications	65
Appendix A - Wire Sizing Information	70
Certifications	75

1.0 Important Safety Instructions

SAVE THESE INSTRUCTIONS.

This manual contains important safety, installation and operating instructions for the TriStar MPPT 150V solar controller. The following symbols are used throughout this manual to indicate potentially dangerous conditions or mark important safety instructions:



WARNING:

Indicates a potentially dangerous condition. Use extreme caution when performing this task.



CAUTION:

Indicates a critical procedure for safe and proper operation of the controller.



NOTE:

Indicates a procedure or function that is important for the safe and proper operation of the controller.



AVERTISSEMENT :

Indique une condition potentiellement dangereuse. Faites preuve d'une prudence extrême lors de la réalisation de cette tâche.



PRUDENCE :

Indique une procédure critique pour l'utilisation sûre et correcte du contrôleur.



REMARQUE :

Indique une procédure ou fonction importante pour l'utilisation sûre et correcte du contrôleur.

Safety Information

- Read all of the instructions and cautions in the manual before beginning installation.
- There are no user serviceable parts inside the TriStar MPPT 150V. Do not disassemble or attempt to repair the controller.



WARNING: RISK OF ELECTRICAL SHOCK.

NO POWER OR ACCESSORY TERMINALS ARE ELECTRICALLY ISOLATED FROM DC INPUT, AND MAY BE ENERGIZED WITH HAZARDOUS SOLAR VOLTAGE. UNDER CERTAIN FAULT CONDITIONS, BATTERY COULD BECOME OVER-CHARGED. TEST BETWEEN ALL TERMINALS AND GROUND BEFORE TOUCHING.

- External solar and battery disconnects are required.
- Disconnect all sources of power to the controller before installing or adjusting the TriStar MPPT 150V.
- There are no fuses or disconnects inside the TriStar MPPT 150V. Do not attempt to repair.

Informations de Sécurité

- Lisez toutes les instructions et les avertissements figurant dans le manuel avant de commencer l'installation.
- Le TriStar MPPT 150V ne contient aucune pièce réparable par l'utilisateur. Ne démontez pas ni ne tentez de réparer le contrôleur.



AVERTISSEMENT: RISQUE DE CHOC ÉLECTRIQUE.

NON ALIMENTATION OU AUX BORNES D'ACCESSOIRES SONT ISOLÉS ÉLECTRIQUEMENT DE L'ENTRÉE DE C.C ET DOIT ÊTRE ALIMENTÉS À UNE TENSION DANGEREUSE SOLAIRE. SOUS CERTAINES CONDITIONS DE DÉFAILLANCE, LA BATTERIE POURRAIT DEVENIR TROP CHARGÉE. TEST ENTRE TOUTES LES BORNES ET LA MASSE AVANT DE TOUCHER.

External solaire et la batterie se déconnecte sont nécessaires.

- Déconnectez toutes les sources d'alimentation du contrôleur avant d'installer ou de régler le TriStar MPPT 150V.
- Le TriStar MPPT ne contient aucun fusible ou interrupteur. Ne tentez pas de réparer.
- Installez des fusibles/coupe-circuits externes selon le besoin.

Installation Safety Precautions

Throughout this manual, NEC guidance has been provided in order to meet general safety requirements and inform of best installation practices. It is the installer's responsibility to ensure that installation complies with all national and local safety code requirements.



WARNING:

This unit is not provided with a GFDI device. This charge controller must be used with an external GFDI device as required by the Article 690 of the National Electrical Code for the installation location.

- Mount the TriStar MPPT 150V indoors. Prevent exposure to the elements and do not allow water to enter the controller.
- Install the TriStar MPPT 150V in a location that prevents casual contact. The TriStar MPPT 150V heatsink can become very hot during operation.
- Use insulated tools when working with batteries.
- Avoid wearing jewelry during installation.
- The battery bank must be comprised of batteries of same type, make, and age.
- Do not smoke near the battery bank.
- Power connections must remain tight to avoid excessive heating from a loose connection.
- Use properly sized conductors and circuit interrupters.
- The grounding terminal is located in the wiring compartment and is identified by the symbol below:

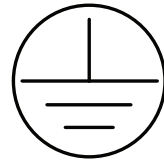

Ground Symbol

- This charge controller is to be connected to DC circuits only. These DC connections are identified by the symbol below:



Direct Current Symbol

The TriStar MPPT 150V controller must be installed by a qualified technician in accordance with the electrical regulations of the country where the product is installed. A means of disconnecting all power supply poles must be provided. These disconnects must be incorporated in the fixed wiring. A permanent, reliable earth ground must be established with connection to the wiring compartment ground terminal. The grounding conductor must be secured against any accidental detachment. The knock-outs in the wiring compartment must protect wires with conduit or rubber rings.

Précautions de Sécurité D'installation



AVERTISSEMENT: L'appareil n'est pas fourni avec un dispositif GFDI. Ce contrôleur de charge doit être utilisé avec un dispositif GFDI externe tel que requis par l'Article 690 du Code électrique national de l'emplacement de l'installation.

- Montez le TriStar MPPT 150V à l'intérieur. Empêchez l'exposition aux éléments et la pénétration d'eau dans le contrôleur.
- Installez le TriStar MPPT 150V dans un endroit qui empêche le contact occasionnel. Le dissipateur de chaleur peut devenir très chaud pendant le fonctionnement.
- Utilisez des outils isolés pour travailler avec les batteries.
- Évitez le port de bijoux pendant l'installation.
- Le groupe de batteries doit être constitué de batteries du même type, fabricant et âge.
- Ne fumez pas à proximité du groupe de batteries.
- Les connexions d'alimentation doivent rester serrées pour éviter une surchauffe excessive d'une connexion desserrée.
- Utilisez des conducteurs et des coupe-circuits de dimensions adaptées.
- La borne de mise à la terre se trouve dans le compartiment de câblage et est identifiée par le symbole ci-dessous estampillé dans le boîtier:

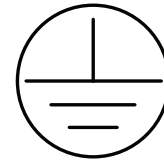

- Ce contrôleur de charge ne doit être connecté qu'à des circuits en courant continu. Ces connexions CC sont identifiées par le symbole ci-dessous:



Le contrôleur TriStar MPPT 150V doit être installé par un technicien qualifié conformément aux réglementations électriques du pays où est installé le produit.

Un moyen d'assurer la déconnexion de tous les pôles de l'alimentation doit être fourni. Cette déconnexion doit être incorporée dans le câblage fixe.

À l'aide de la borne de mise à la masse du TriStar MPPT 150V (dans le compartiment de câblage), un moyen permanent et fiable de mise à la terre doit être fourni. La fixation de la mise à la terre doit être fixée contre tout desserrage accidentel.

Les ouvertures d'entrée au compartiment de câblage du TriStar MPPT 150V doivent être protégées avec un conduit ou une bague.

Battery Safety



WARNING: A battery can present a risk of electrical shock or burn from large amounts of short-circuit current, fire, or explosion from vented gases. Observe proper precautions.



AVERTISSEMENT: Une batterie peut présenter un risque de choc électrique ou de brûlure de grandes quantités de court-circuit, d'incendie ou d'explosion de gaz ventilés. Observer les précautions appropriées.



WARNING: Risk of Explosion. Proper disposal of batteries is required. Do not dispose of batteries in fire. Refer to local regulations or codes for requirements.



AVERTISSEMENT: Risque d'Explosion. Au rebut des piles est nécessaire. Ne pas jeter les piles dans le feu. Se référer aux réglementations locales ou des codes pour les exigences.



CAUTION: When replacing batteries, proper specified number, sizes types and ratings based on application and system design



PRUDENCE: Lorsque le remplacement des piles, utilisez correctement nombre spécifié, tailles, types et les évaluations basées sur conception de système et d'application.



CAUTION: Do not open or mutilate batteries. Released electrolyte is harmful to skin, and may be toxic.



PRUDENCE: Ne pas ouvrir ou mutiler les piles. L'électrolyte est nocif pour la peau et peut être toxique.

- Servicing of batteries should be performed, or supervised, by personnel knowledgeable about batteries, and the proper safety precautions.
 - Be very careful when working with large lead-acid batteries. Wear eye protection and have fresh water available in case there is contact with the battery acid.
 - Remove watches, rings, jewelry and other metal objects before working with batteries.
 - Wear rubber gloves and boots
 - Use tools with insulated handles and avoid placing tools or metal objects on top of batteries.
 - Disconnect charging source prior to connecting or dis-connecting battery terminals.
 - Determine if battery is inadvertently grounded. If so, remove the source of contact with ground. Contact with any part of a grounded battery can result in electrical shock. The likelihood of such a shock can be reduced if battery grounds are removed during installation and maintenance (applicable to equipment and remote battery supplies not having a grounded supply circuit).
 - Carefully read the battery manufacturer's instructions before installing / connecting to, or removing batteries from, the TriStar MPPT.
 - Be very careful not to short circuit the cables connected to the battery.
 - Have someone nearby to assist in case of an accident.
 - Explosive battery gases can be present during charging. Be certain there is enough ventilation to release the gases.
 - Never smoke in the battery area.
 - If battery acid comes into contact with the skin, wash with soap and water. If the acid contacts the eye, flood with fresh water and get medical attention.
 - Be sure the battery electrolyte level is correct before starting charging. Do not attempt to charge a frozen battery.
 - Recycle the battery when it is replaced.
-
- Entretien des batteries devrait être effectué ou supervisé, par un personnel bien informé sur les piles et les précautions de sécurité appropriées.
 - Soyez très prudent quand vous travaillez avec des grandes batteries au plomb. Portez des lunettes de protection et ayez de l'eau fraîche à disposition en cas de contact avec l'électrolyte.
 - Enlevez les montres, bagues, bijoux et autres objets métalliques avant de travailler avec des piles.
 - Porter des bottes et des gants de caoutchouc
 - Utiliser des outils avec poignées isolantes et évitez de placer des outils ou des objets métalliques sur le dessus de batteries.
 - Débrancher la source de charge avant de brancher ou dis-reliant les bornes de la batterie.
 - Utilisez des outils isolés et évitez de placer des objets métalliques dans la zone de travail.
 - Déterminer si batterie repose par inadvertance. Dans l'affirmative, supprimer la source du contact avec le sol. Contact avec n'importe quelle partie d'une batterie mise à la terre peut entraîner un choc électrique.

- La probabilité d'un tel choc peut être réduite si des motifs de batterie sont supprimés pendant l'installation et maintentretien (applicable à l'équipement et les fournitures de pile de la télécommande n'ayant pas un circuit d'alimentation mise à la terre *).
- Lisez attentivement les instructions du fabricant de la batterie avant d'installer / connexion à ou retrait des batteries du TriStar MPPT.
- Veillez à ne pas court-circuiter les câbles connectés à la batterie.
- Ayez une personne à proximité qui puisse aider en cas d'accident.
- Des gaz explosifs de batterie peuvent être présents pendant la charge. Assurez-vous qu'une ventilation suffisante évacue les gaz.
- Ne fumez jamais dans la zone des batteries
- En cas de contact de l'électrolyte avec la peau, lavez avec du savon et de l'eau. En cas de contact de l'électrolyte avec les yeux, rincez abondamment avec de l'eau fraîche et consultez un médecin.
- Assurez-vous que le niveau d'électrolyte de la batterie est correct avant de commencer la charge. Ne tentez pas de charger une batterie gelée.
- Recyclez la batterie quand elle est remplacée.

About this Manual

This manual provides detailed installation and usage instructions for the TriStar MPPT 150V controller. Only qualified electricians and technicians who are familiar with solar system design and wiring practices should install the TriStar MPPT 150V. The usage information in this manual is intended for the system owner/operator.

2.0 Getting Started

2.1 Overview

Thank you for selecting the TriStar MPPT 150V solar charge controller with TrakStar™ MPPT Technology. The TriStar MPPT 150V (TS-MPPT) is an advanced maximum power point tracking solar battery charger. The controller features a smart tracking algorithm that finds and maintains operation at the solar array peak power point, maximizing energy harvest.

The TriStar MPPT 150V battery charging process has been optimized for long battery life and improved system performance. Self-diagnostics and electronic error protections prevent damage when installation mistakes or system faults occur. The controller also features eight (8) adjustable settings switches, several communication ports, and terminals for remote battery temperature and voltage measurement.

Please take the time to read this operator's manual and become familiar with the controller. This will help you make full use of the many advantages the TriStar MPPT 150V can provide for your PV system.

2.2 Versions and Ratings

There are four versions of TriStar MPPT 150V controller:

TriStar-MPPT-30

- maximum 30 amps continuous battery current
- 12, 24 and 48 Volt dc systems
- maximum 150 Volt dc solar input voltage
- RS-232 and MeterBus™ communication ports

TriStar-MPPT-45

- maximum 45 amps continuous battery current
- 12, 24 and 48 Volt dc systems
- maximum 150 Volt dc solar input voltage
- RS-232 and MeterBus™ communication ports

TriStar-MPPT-60

- maximum 60 amps continuous battery current
- 12, 24 and 48 Volt dc systems
- maximum 150 Volt dc solar input voltage
- RS-232, EIA-485, MeterBus™, and Ethernet communication ports

TriStar-MPPT-60M

- maximum 60 amps continuous battery current
- 12, 24 and 48 Volt dc systems
- maximum 150 Volt dc solar input voltage
- RS-232, EIA-485, MeterBus™, and Ethernet communication ports
- Includes on-board meter display

2.3 Features

The features of the TriStar MPPT 150V are shown in Figure 2-1 below. An explanation of each feature is provided.

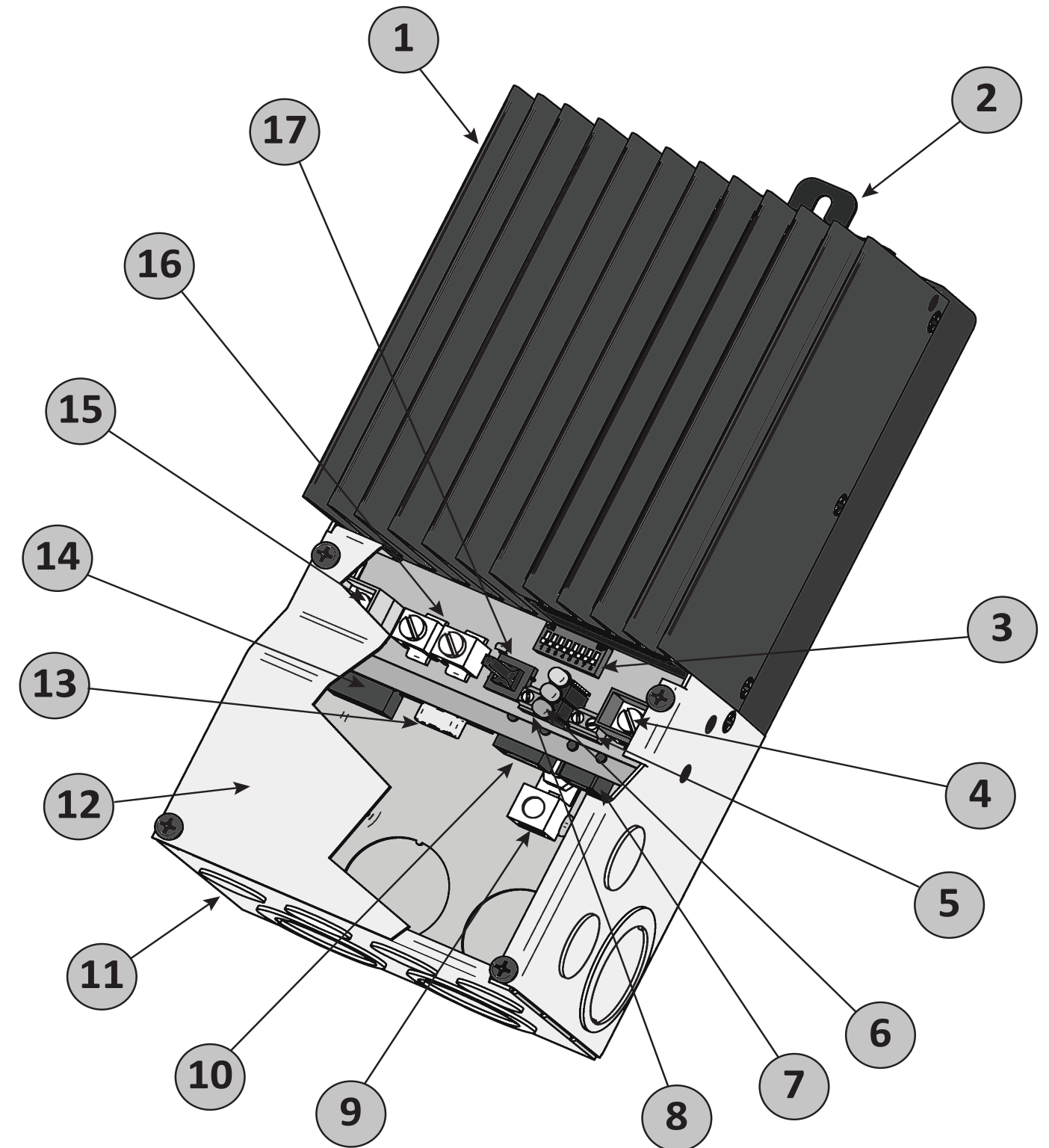

Figure 2-1. TriStar MPPT 150V features

1 - Heatsink

Aluminum heatsink to dissipate controller heat

2 - Mounting Hanger

Keyhole slot for mounting

3 - Settings Switches

Eight (8) settings switches to configure operation of the TriStar MPPT 150V

4 - Battery Positive Terminal (red)

Power connection for Battery (+)

5 - Remote Temperature Sensor Terminals

Connection point for a Morningstar RTS (optional) to remotely monitor battery temperature

6 - LED Indicators

Three *state of charge* (SOC) LED indicators show charging status and controller faults

7 - MeterBus™ Port

RJ-11 socket for Morningstar MeterBus™ network connections

8 - Battery Voltage Sense Terminals

Terminals for battery voltage input provide accurate battery voltage measurement

9 - Ground Terminal

A chassis ground terminal for system grounding

10 - Ethernet Port

RJ-45 socket for LAN/internet connections (TS-MPPT-60 model only)

11 - Wiring Box with Conduit Knockouts

Termination points for wiring conduit and wire glands

12 - Wiring Box Cover

Sheet metal wiring box cover protects power connections

13 - Serial RS-232 Port

9-pin serial connector (female)

14 - EIA-485 Port

Four (4) position screw terminal for EIA-485 bus connections (TS-MPPT-60 model only)

15 - Solar Positive Terminal (yellow)

Power connection for Solar (+)

16 - Common Negative Power Terminals

Two (2) negative terminals for negative system cable termination

17 - Push-button Switch

Manually reset from an error or fault, also used to start/stop a manual equalization.

2.4 Regulatory Information



NOTE:

This section contains important information for safety and regulatory requirements.

The TriStar MPPT 150V controller should be installed by a qualified technician according to the electrical rules of the country in which the product will be installed.

TriStar MPPT 150V controllers comply with the following EMC standards:

- Immunity: EN61000-6-2:1999
- Emissions: EN55022:1994 with A1 and A3 Class B1
- Safety: EN60335-1 and EN60335-2-29 (battery chargers)

A means shall be provided to ensure all pole disconnection from the power supply. This disconnection shall be incorporated in the fixed wiring.

Using the TriStar MPPT 150V grounding terminal (in the wiring compartment), a permanent and reliable means for grounding shall be provided. The clamping of the earthing shall be secured against accidental loosening.

The entry openings to the TriStar MPPT 150V wiring compartment shall be protected with conduit or with a bushing.

FCC requirements:

This device complies with Part 15 of the FCC rules. Operation is subject to the following two conditions: (1) This device may not cause harmful interference, and (2) this device must accept any interference received, including interference that may cause undesired operation.

Changes or modifications not expressly approved by Morningstar for compliance could void the user's authority to operate the equipment.

Note:

This equipment has been tested and found to comply with the limits for a Class B digital device, pursuant to Part 15 of the FCC rules. These limits are designed to provide reasonable protection against harmful interference in a residential installation. This equipment generates, uses, and can radiate radio frequency energy and, if not installed and used in accordance with the instruction manual, may cause harmful interference to radio communication. However, there is no guarantee that interference will not occur in a particular installation. If this equipment does cause harmful interference to radio or television reception, which can be determined by turning the equipment on and off, the user is encouraged to try to correct the interference by one or more of the following measures:

- Reorient or relocate the receiving antenna.
- Increase the separation between the equipment and receiver.
- Connect the equipment into an outlet on a circuit different from that to which the receiver is connected.
- Consult the dealer or an experienced radio/TV technician for help.

This Class B digital apparatus complies with Canadian ICES-003.

Cet appareil numérique de la classe B est conforme à la norme NMB-003 du Canada.

2.5 Optional Accessories

The following accessories are available for purchase separately from your authorized Morningstar dealer:

TriStar Digital Meter 2 / TriStar Remote Meter 2 (Models: TS-M-2 / TS-RM-2)

The TriStar Digital Meter mounts directly on the TS-MPPT controller, replacing the wiring box cover. The TriStar Remote Meter can be flush mounted in a wall or into a standard duplex (2-gang) electrical box. A 2 x 16 character display shows system operating information, error indications, and self-diagnostic information. Four (4) buttons make navigating the meter menus easy. For systems where multiple TS-MPPT controllers are networked together, one (1) meter can display full system information. The TriStar meters connect to the RJ-11 MeterBus™ port on the TriStar-MPPT.

Meter Hub (HUB-1)

A Morningstar MeterBus™ network with multiple controllers requires a Meter Hub for electrical isolation. The HUB-1 allows communication between MeterBus™ compatible Morningstar products, including the TriStar MPPT 150V controller. DIN rail compatible. See section 5.2 for more details.

Relay Driver (RD-1)

The Relay Driver™ accessory enables the TriStar MPPT 150V to control external devices. Four (4) relay control ports can be configured (in various combinations) to perform the following tasks:

- generator control (2-, 3-, and 4-wire configurations)
- dry contacts for alarms and other signals
- advanced load control
- vent fan control
- DIN rail compatible or surface mount

For more information on the Relay Driver, visit our website at www.morningstarcorp.com or inquire with your local Morningstar dealer.

EIA-485 / RS-232 Communications Adapter (RSC-1)

Connect one or more TriStar MPPT 150V controllers to a PC or to other serial devices using the RSC-1 EIA-485 adapter. The adapter converts an RS-232 serial interface to EIA-485 compliant signals. An LED shows network activity and errors. DIN rail compatible.

USB Communications Adapter (UMC-1)

A modular unit that uses a USB-B plug, usually from a USB A-B computer cable, and an RJ-11 plug to connect with a Morningstar controller's MeterBus port, for monitoring and programming using MSView PC software.

PC MeterBus Adapter™ (Model: MSC)

The MSC converts the MeterBus RJ-11 electrical interface to an isolated standard RS-232 interface which enables communication between the High-Power MPPT and a personal computer (PC). The MSC can be used for programming custom charging set-points, and for logging data in MSView. See Section 4.7 for more information on programming.

Ethernet Meterbus Converter (EMC-1)

This product is an Ethernet gateway that provides web monitoring, a Modbus TCP/IP server, and a local web page server. End users can collect information about their off-grid PV system remotely by bridging MODBUS TCP/IP requests to serve LiveView pages, or connect with MSView monitoring software. The EMC-1 supports all products that have a MeterBus port.

Remote Temperature Sensor (Model: RTS)

The RTS measures battery temperature for accurate temperature compensation and is recommended when the ambient battery temperature differs from the ambient controller temperature by more than 5° C. The standard cable length is 33 ft (10m).

 NOTE: The use of a Remote Temperature Sensor is strongly recommended. Controller location, air flow, and system power can drastically affect the local temperature sensor reading. An RTS will provide optimal charging performance.

Ground-fault Protection Device (GFPD-150V)

The GFPD-150V detects power source ground faults and interrupts current as required by the U.S. National Electrical Code.

3.0 Installation

3.1 General Information

The mounting location is important to the performance and operating life of the controller. The environment must be dry and protected from water ingress. If required, the controller may be installed in a ventilated enclosure with sufficient air flow. Never install the TriStar MPPT 150V in a sealed enclosure. The controller may be mounted in an enclosure with sealed batteries, but never with vented/flooded batteries. Battery fumes from vented batteries will corrode and destroy the TriStar MPPT 150V circuits.

Multiple TriStars can be installed in parallel on the same battery bank to achieve higher charging current. Additional parallel controllers can also be added in the future. Each TriStar MPPT 150V must have its own solar array.



WARNING: Installation must conform to all requirements of the latest US National Electrical Code and the Canadian Electrical Code.



AVERTISSEMENT: Installation doit être conforme à toutes les requirments US National Electrical Code et Code Canadien d'Electricité.



CAUTION: Equipment Damage or Risk of Explosion
Never install the TriStar MPPT 150V in an enclosure with vented/flooded batteries. Battery fumes are flammable and will corrode and destroy the TriStar MPPT 150V circuits.



CAUTION: Equipment Damage
When installing the TriStar MPPT 150V in an enclosure, ensure sufficient ventilation. Installation in a sealed enclosure will lead to over-heating and a decreased product lifetime.



PRUDENCE : Endommagement de l'équipement ou risque d'explosion

N'installez jamais le TriStar MPPT 150V dans une enceinte avec des batteries à évent/à électrolyte liquide. Les vapeurs des batteries sont inflammables et corroderont et détruiront les circuits du TriStar MPPT 150V.



PRUDENCE : Endommagement de l'équipement
Assurez une ventilation suffisante en cas d'installation du TriStar MPPT 150V dans une enceinte. L'installation dans une enceinte hermétique entraîne une surchauffe et une réduction de la durée de vie du produit.

The installation is straight-forward, but it is important each step is done correctly and safely. A mistake can lead to dangerous voltage and current levels. Be sure to carefully follow each instruction in this section. Read all instructions first before beginning installation.

The installation instructions are for installation of a negative grounded system. National Electrical Code (NEC) requirements are noted on occasion for convenience, however the installer should have a complete understanding of NEC and UL requirements for photovoltaic installations.

- Read through the entire installation section first before beginning installation.
- Be very careful when working with batteries. Wear eye protection. Have fresh water available to wash and clean any contact with battery acid.
- Use insulated tools and avoid placing metal objects near the batteries.
- Explosive battery gases may be present during charging. Be certain there is sufficient ventilation to release the gases.
- Do not install in locations where water can enter the controller.
- Loose power connections and/or corroded wires may result in resistive connections that melt wire insulation, burn surrounding materials, or even cause fire. Ensure tight connections and use cable clamps to secure cables and prevent them from swaying in mobile applications.
- Stranded wires to be connected to the terminals should be prepared first with e.g. clamped copper heads, tinned-wire ends, etc. to avoid the possibility of one conductor free out of the connection screw, and possible contact with the metal enclosure.
- Preset charging profiles are generally designed for lead acid batteries. Custom settings can be used for varied charging requirements (see sections 3.2 and 4.2 for details). Note that some battery types may not be compatible.
- The TriStar MPPT 150V battery connection may be wired to one battery, or a bank of batteries. The following instructions refer to a singular battery, but it is implied that the battery connection can be made to either one battery or a group of batteries in a battery bank.
- The TriStar MPPT 150V uses stainless steel fasteners, an anodized aluminum heat sink, and conformal coating to protect it from harsh conditions. However, for acceptable service life, extreme temperatures and marine environments should be avoided.
- The TriStar MPPT 150V prevents reverse current leakage at night, so a blocking diode is not required in the system.
- Solar and battery disconnects and overcurrent protection are required in the system. These protection devices are external to the TriStar MPPT 150V controller. See Section 3.2, Step 9 - Power Connections - for requirements.

Recommended Tools:

- Wire strippers
- Wire cutters
- #2 & #0 Phillips screwdriver
- slotted screwdrivers
- Pliers
- Drill
- 3/32" (2.5 mm) drill bit
- Level
- hack saw (cutting conduit)

3.2 Controller Installation

Step 1 - Remove the wiring box cover



CAUTION: Shock Hazard

Disconnect all power sources to the controller before removing the wiring box cover. Never remove the cover when voltage exists on any of the TriStar MPPT 150V power connections.

PRUDENCE : Risque de décharge électrique

Déconnectez toutes les sources d'alimentation du contrôleur avant d'enlever le couvercle du boîtier de câblage. Ne retirez jamais le couvercle en présence de tension sur une des connexions d'alimentation du TriStar MPPT.



Use a #2 Phillips screw driver to remove the four (4) screws that secure the wiring box cover as shown in figure 3-1 below.

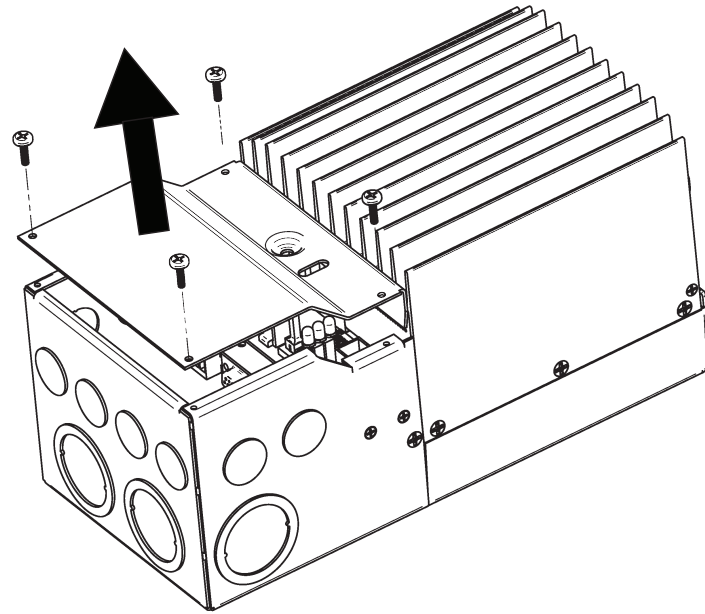

Figure 3-1. Remove the wiring box cover.

If a TriStar Digital Meter 2 display is installed, be sure to disconnect the RJ-11 cable.

Step 2 - Remove the Knock-Outs

Knockouts are provided for routing cables through conduit or wire glands. Table 3-1 below provides the knockout sizes and quantity on the TriStar MPPT 150V wiring box. Knockout locations and dimensions are on the inside front cover.

Quantity	Trade Size	Hole Dimension
8	1/2" or M20	7/8" (22.2 mm)
6	1"	1 - 23/64" (34.5 mm)
4	1 - 1/4"	1 - 23/32" (43.7 mm)

Table 3-1. Knockout sizes



CAUTION: Shock Hazard

Always use bushings, connectors, clamp connectors, or wire glands in the knockout openings to protect wiring from sharp edges.



PRUDENCE : Risque de décharge électrique

Utilisez toujours des bagues, des connecteurs, des raccordements à collets ou des fouloirs dans les ouvertures afin de protéger le câblage des bords coupants.



CAUTION: Shock Hazard

Never route network cables in the same conduit as the power conductors.



PRUDENCE : Risque de décharge électrique

N'acheminez jamais les câbles réseau dans le même conduit que les conducteurs d'alimentation.

Plan the routing of each conductor that will connect to the TriStar MPPT 150V before removing any knockouts. The 1/2" (M20) knockouts are ideal for routing network cables, which must be placed in separate conduit.

Step 3 - Mount to a Vertical Surface



CAUTION: Risk of Burns

Install the TriStar MPPT 150V in a location that prevents casual contact. The TriStar MPPT 150V heatsink can become very hot during operation.

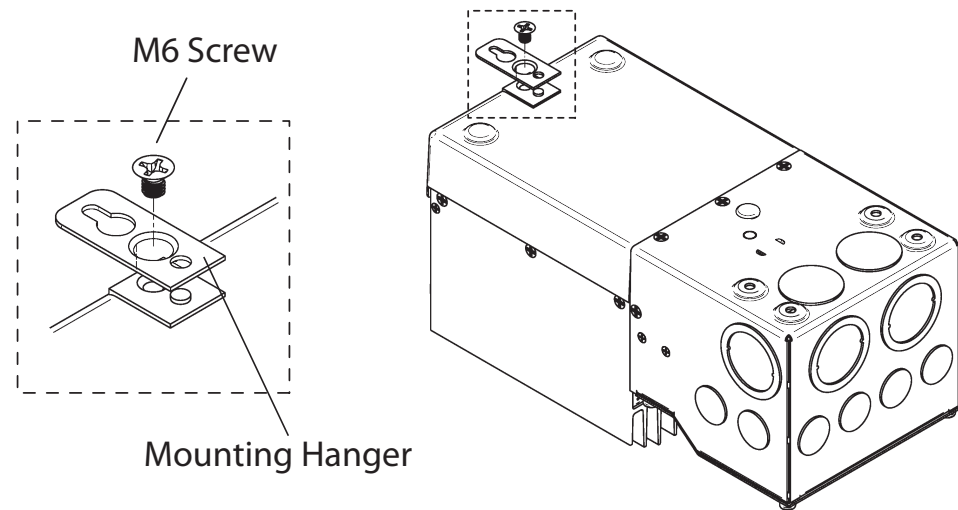

Figure 3-2. Attaching the mounting hanger

1. Attach the mounting hanger to the bottom of the TriStar MPPT 150V with the M6 screw provided as shown in figure 3-2.
2. Place the TriStar MPPT 150V on a vertical surface protected from direct sun, high temperatures, and water. The TriStar MPPT 150V requires at least 6" (150 mm) of clearance above and below and at least 1" (25 mm) on each side for proper air flow as shown in figure 3-3 below.

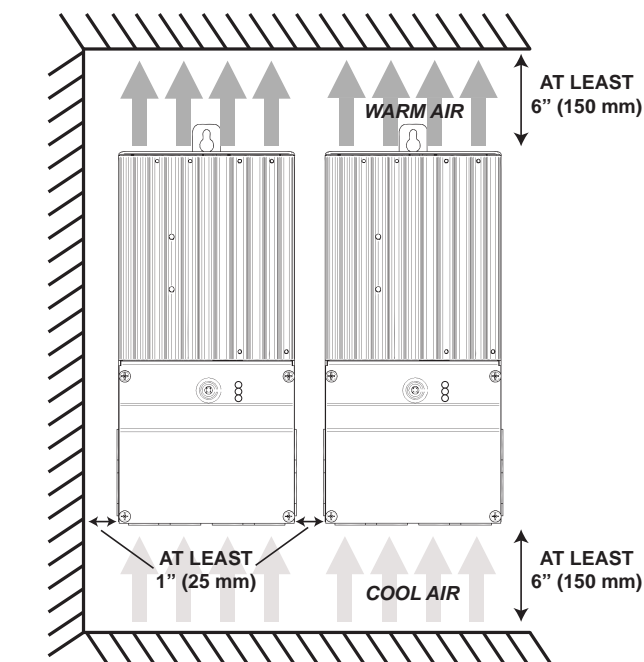

Figure 3-3. Required mounting clearance for air flow.

3. Place a mark on the mounting surface at the top of the keyhole.
4. Remove the controller and drill a 3/32" (2.5 mm) hole at the drill mark.
5. Insert a #10 screw (included) into the top pilot hole. Do not tighten the screw completely. Leave a 1/4" (6 mm) gap between the mounting surface and screw head.
6. Carefully align the keyhole on the TriStar MPPT 150V with the screw head. Slide the TriStar MPPT 150V down over the keyhole.
7. Check for vertical plumb with a level.
8. Mark two (2) mounting hole locations in the wiring box.
9. Remove the controller and drill 3/32" (2.5 mm) holes at the drill marks.
10. Carefully align the keyhole on the TriStar MPPT 150V with the screw head. Slide the TriStar MPPT 150V down over the keyhole.
11. The pre-drilled pilot holes should align with the mounting holes in the wiring box. Secure the controller with two (2) #10 mounting screws.
12. Tighten the keyhole screw.

Step 4 - Adjust Settings Switches

Switch 1: Reserved for Future Use

Settings switch 1 should remain in the "OFF" position.

Mode	Switch 1
Solar Charging	OFF
future use	ON

Switches 2 & 3: System Voltage

Four (4) system voltage configurations are available as shown in the table below:

System Voltage	Switch 2	Switch 3
Auto	OFF	OFF
12	OFF	ON
24	ON	OFF
48	ON	ON

The "auto" setting allows the TriStar MPPT 150V to detect the system voltage automatically on start up. The test is *only* performed at start up and the detected system voltage will never change during operation.

Generally, it is best to choose a specific system voltage. The auto detect feature should only be used in situations where the system voltage is unknown ahead of time or in systems where the system voltage may change periodically.

Switches 4, 5, & 6: Battery Charging Settings

It is important to select the battery type that matches the system battery to ensure proper charging and long battery life. Refer to the specifications provided by the battery manufacturer and choose a setting that best fits the recommended charging profile.

Settings Switches 4 - 5 - 6	Battery Type	Absorp. Stage (Volts)	Float Stage (Volts)	Equalize Stage (Volts)	Equalize Interval (Days)
off-off-off	1 - Gel	14.00	13.70		
off-off-on	2 - Sealed ¹	14.15	13.70	14.40	28
off-on-off	3 - Sealed ¹	14.30	13.70	14.60	28
off-on-on	4 - AGM/Flooded	14.40	13.70	15.10	28
on-off-off	5 - Flooded	14.60	13.50	15.30	28
on-off-on	6 - Flooded	14.70	13.50	15.40	28
on-on-off	7 - L-16	15.40	13.40	16.00	14
on-on-on	8 - Custom	Custom	Custom	Custom	Custom

¹ "Sealed" battery type includes gel and AGM batteries

All settings are for 12 Volt nominal systems. Multiply the charge voltage settings by 2 for 24 Volt systems or by 4 for 48 Volt systems. A description of each setting is provided below. See section 4.3 for full details on battery charging and a description of each of the settings in the battery charging table.

Battery Type - The most common battery type associated with the specified charging settings.

Absorption Stage - This stage limits input current so that the Absorption voltage is maintained. As the battery becomes more charged, the charging current continues to taper down until the battery is fully charged.

Float Stage - When the battery is fully charged, the charging voltage will be reduced to the Float voltage setting.

Equalize Stage - During an equalization cycle, the charging voltage will be held constant at the specified voltage setting.

Equalize Interval - The number of days between equalization charges when the controller is configured for automatic equalizations (settings switch 7).

Switch 7: Battery Equalization

Choose between manual and automatic battery equalization charging. In the manual equalization setting, an equalization will only occur when manually started with the push-button or when requested from the equalize menu on the TriStar meter. Automatic equalization will occur according to the battery program specified by settings switches 4, 5, & 6 in the previous step.

In both settings (auto and manual), the push-button can be used to start and stop battery equalization. If the selected battery charging setting does not have an equalization stage an equalization will never occur, even if requested manually.

Equalize	Switch 7
manual	OFF
automatic	ON

Switch 8: Ethernet Security

The Ethernet Security switch enables or disables configuration of the TriStar MPPT 150V settings through the Ethernet connection. When switch eight is set to *disabled*, write commands to the TriStar MPPT 150V custom memory are not allowed. This a safety feature to prevent unintended changes to custom settings, but it is not a replacement for proper network security.

Configuration via TCP/IP	Switch 8
disabled	OFF
enabled	ON



NOTE:

Adjustment of network settings and custom set-points is always enabled via the RS-232 and EIA-485 connections. The Ethernet Security switch only enables/disables remote configuration via TCP/IP.



CAUTION: Risk of Tampering

The Ethernet Security settings switch does not block write commands to devices bridged via EIA-485.



REMARQUE :

Le réglage des paramètres de réseau et des points de consignes personnalisés est toujours activé par les connexions RS-232 et EIA-485. Le contacteur de sécurité Ethernet n'active/désactive que la configuration à distance par TCP/IP.



PRUDENCE : Risque de tentative d'altération

Le contacteur des paramètres de sécurité Ethernet ne bloque pas les commandes d'écriture sur les dispositifs reliés par EIA-485.

Step 5 - Remote Temperature Sensor

The included Remote Temperature Sensor (RTS) is recommended for effective temperature compensated charging. Connect the RTS to the 2-position terminal located between the battery (+) terminal lug and the LED stack (see figure 2-1). The RTS is supplied with 33 ft (10 m) of 22 AWG (0.34 mm²) cable. There is no polarity, so either wire (+ or -) can be connected to either screw terminal. The RTS cable may be pulled through conduit along with the power wires. Tighten the connector screws to 5 in-lb (0.56 Nm) of torque. Separate installation instructions are provided inside the RTS bag.



WARNING: Risk of Fire.

If no Remote Temperature Sensor (RTS) is connected, use the TriStar MPPT 150V within 3m (10 ft) of the batteries.



AVERTISSEMENT: Risque d'incendie.

Si aucun capteur de température distant (RTS) est branché, utilisez le TriStar MPPT 150V au sein de 3 m (10 pi) de la batterie.



CAUTION:

The TriStar MPPT 150V will not temperature compensate charging parameters if the RTS is not used. Charging will be based on a temperature of 25°C. Use of an RTS is strongly recommended.



CAUTION: Equipment Damage

Never place the temperature sensor inside a battery cell. Both the RTS and the battery will be damaged.



NOTE:

The RTS cable may be shortened if the full length is not needed. Be sure to reinstall the ferrite choke on the end of the RTS if a length of cable is removed. This choke ensures compliance with electromagnetic emissions standards.



PRUDENCE:

Le TriStar MPPT 150V ne compensera pas la température des paramètres de charge si le RTS n'est pas utilisé. La charge sera basée sur une température de 25 ° C. L'utilisation du RTS est fortement recommandée.



PRUDENCE : Endommagement de l'équipement

Ne placez jamais la sonde de température dans un élément de batterie. Le RTS et la batterie seraient endommagés.



REMARQUE :

Le câble de RTS peut être raccourci si la totalité de la longueur n'est pas nécessaire. Assurez-vous de réinstaller la bobine en ferrite sur l'extrémité du RTS si une longueur de câble est enlevée. Cette bobine assure la conformité avec les normes d'émissions électromagnétiques.

Step 6 - Grounding and Ground Fault Interruption



WARNING:

This unit is not provided with a GFDI device. This charge controller must be used with an external GFDI device as required by the Article 690 of the National Electrical Code for the installation location.



NOTE:

Conductors identified by the colors green or green/yellow should only be used for earthing conductors.



AVERTISSEMENT :

L'appareil n'est pas fourni avec un dispositif GFDI. Ce contrôleur de charge doit être utilisé avec un dispositif GFDI externe tel que requis par l'Article 690 du Code électrique national de la région de l'installation.

Use a copper wire to connect the grounding terminal in the wiring box to earth ground. The grounding terminal is identified by the ground symbol shown below that is stamped into the wiring box just below the terminal:

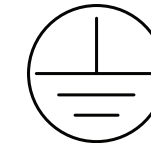

Figure 3-4. Ground Symbol

Do not connect the system negative conductor to this terminal. NEC requires the use of an external ground fault protection device (GFPD). The TriStar MPPT 150V does not have internal ground fault protection. The system electrical negative should be bonded through a GFPD to earth ground at one (and only one) location. The grounding point may be located in the solar circuit or the battery circuit.

Per NEC 690.45 (A) and NEC Table 250.122, minimum sizes for copper grounding wire are:

- TS-MPPT-30 10 AWG (5 mm²)
- TS-MPPT-45 10 AWG (5 mm²)
- TS-MPPT-60/M 8 AWG (8 mm²)

OR, of the same, or greater, cross-sectional area as the PV wires.



WARNING: Risk of Fire

DO NOT bond system electrical negative to earth ground at the controller. Per NEC requirements, system negative must be bonded to earth ground through a GFPD at only one point.



AVERTISSEMENT : Risque d'incendie

NE LIEZ PAS le côté négatif du système à la mise à la terre au niveau du contrôleur. Selon les exigences du CNE, le côté négatif du système doit être mis à la terre par un GFPD à un seul point.

Step 7 - Battery Voltage Sense

The voltage at the battery connection on the TriStar MPPT 150V may differ slightly from the voltage directly at the battery bank terminals due to connection and cable resistance. The *Battery Voltage Sense* connection enables the TriStar MPPT 150V to measure the battery terminal voltage precisely with small gauge wires that carry very little current, and thus have no voltage drop. Both battery voltage sense wires are connected to the TriStar at the 2-position terminal located between the push-button and the positive (+) terminal lug (see figure 2-1).

A battery voltage sense connection is not required to operate your TriStar MPPT 150V controller, but it is recommended for best performance. If a TriStar meter will be added to the controller, the battery voltage sense will ensure that the voltage and diagnostic displays are very accurate.

The voltage sense wires should be cut to length as required to connect the battery to the voltage sense terminal. The wire size can range from 16 to 24 AWG (1.0 to 0.25 mm²). A twisted pair cable is recommended but not required. Use UL rated 300 Volt conductors. The voltage sense wires may be pulled through conduit with the power conductors.

Fuse the positive (+) voltage sense wire as close to the battery as possible. Size the fuse based on wire ampacity - a 1A fuse can be used for #24 wire.

Tighten the connector screws to 5 in-lb (0.56 Nm) of torque.

The maximum length allowed for each battery voltage sense wire is 98 ft (30 m).

Be careful to connect the battery positive (+) terminal to the voltage sense positive (+) terminal. No damage will occur if the polarity is reversed, but the controller cannot read a reversed sense voltage. Connecting the voltage sense wires to the RTS terminal will cause an alarm.

If a TriStar meter is installed, check the "TriStar Settings" to confirm the Voltage Sense and the RTS (if installed) are both present and detected by the controller. MSView™ PC software can also be used to confirm the voltage sense is working correctly.

Step 8 - Network Connections

Network connections allow the TriStar MPPT 150V to communicate with other controller or computers. A network can be as simple as one controller and one PC, or as complex as dozens of controllers monitored via the internet. Review section 5.0 for more information about networking and the connection(s) required for your system.



WARNING: Shock Hazard

Never route network cables in the same conduit as the power conductors.



WARNING: Shock Hazard

Only use 300 Volt UL rated communication cable.



AVERTISSEMENT : Risque de décharge électrique

N'acheminez jamais les câbles réseau dans le même conduit que les conducteurs d'alimentation.



AVERTISSEMENT : Risque de décharge électrique

N'utilisez qu'un câble de communication 300 V homologué UL.

Connect the appropriate network cables to the TriStar MPPT 150V at this time. Access to the network ports is easier before the power cables are attached. The ports are located inside the conduit wiring box on the lower circuit board as shown in figure 3-5.

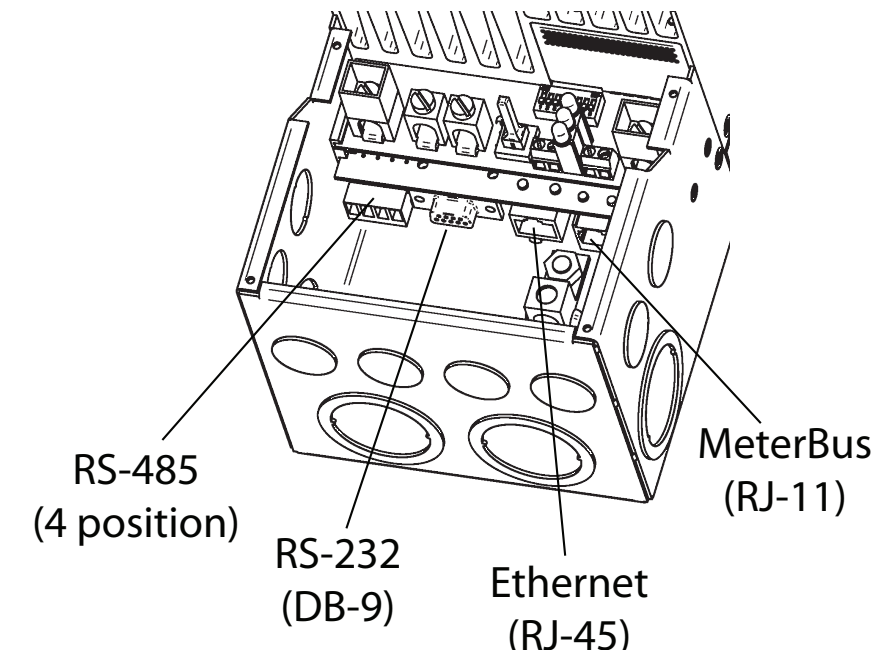

Figure 3-5. TriStar MPPT 150V network port locations

EIA-485 Connection

The four (4) position EIA-485 connector on the TriStar MPPT 150V must be removed to access the terminal screws. Remove the socket connector by firmly grasping the connector body and pulling away from the circuit board as shown in Figure 3-6.

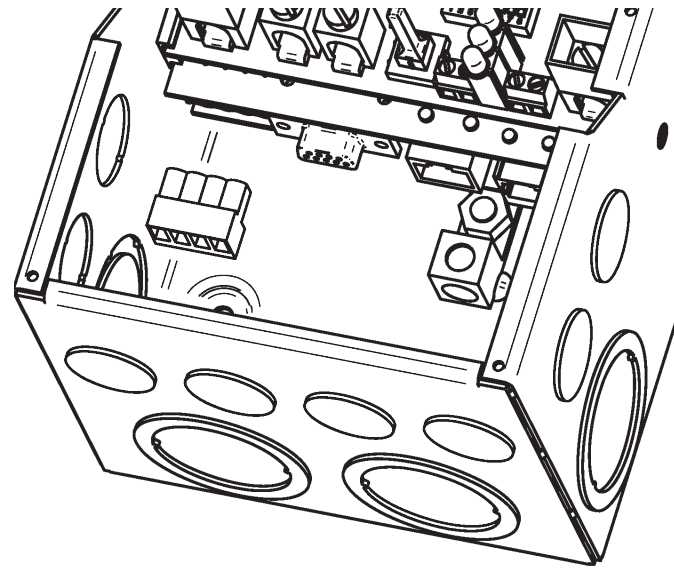

Figure 3-6. Removing the RS-485 socket connector

RS-232 Connection

The serial RS-232 port is a standard 9-pin (DB9) female connector. A low-profile serial connector is recommended to save room in the wiring box.



NOTE:

The RS-232 and EIA-485 ports share hardware. Both ports cannot be used simultaneously.



REMARQUE :

Les ports RS-232 et EIA-485 partagent le matériel. Ils ne peuvent pas être utilisés simultanément.

Ethernet Connection

The RJ-45 Ethernet jack features two (2) indicator LEDs for connection status and network traffic. Use CAT-5 or CAT-5e twisted pair cable and RJ-45 plugs. If possible, pull the network cable through conduit before crimping on the RJ-45 connectors. If using pre-assembled cables, take care not to damage the plugs when the cables are pulled through conduit.

MeterBus™ Connection

MeterBus™ networks use standard 4-wire or 6-wire RJ-11 telephone cables. If possible, pull the telephone cable through conduit before crimping on the RJ-11 connectors. If using pre-assembled cables, take care not to damage the plugs when the cables are pulled through conduit.

Y-cable Connections for EMC-1 Use

TS-MPPT-30 and TS-MPPT-45 units can be Ethernet connected using the EMC-1 accessory and an EMC-1 provided Y-cable. These models need to be connected to the EMC-1 with the Y-cable (DB-9 serial and RJ-11 plugs at the TS-MPPT) and an RJ-11 plug at the EMC-1.

Step 9 - Power Connections



CAUTION: Wiring Requirements

U.S. installed wiring must conform to all current U.S. NEC, ANSI/NFPA 70 requirements, and to any local regulations. Non-U.S. installations must meet all national and local requirements of the country of installation.



WARNING: Fire Hazard

If multiple units are used in parallel for more charging current, the battery conductor wiring must be sized for the total sum of all current ratings of the combined controllers.



CAUTION: Risk of Fire and Shock

Connect battery terminals prior to the connection of array terminals. The battery positive (+) terminal has a red cover, the solar positive (+) terminal has a yellow cover.



AVERTISSEMENT : Risque d'incendie

Si plusieurs unités sont utilisées en parallèle pour plus de courant de charge, le câblage du conducteur de la batterie doit être dimensionné pour la somme totale de tous les courants nominaux des contrôleurs combinés.



PRUDENCE : Exigences de câblage

Le câblage installé aux États-Unis doit être conforme à toutes les exigences actuelles du NEC américain, ANSI/NFPA 70 et à toute réglementation locale. Non américain les installations doivent répondre à toutes les exigences nationales et locales du pays d'installation.



PRUDENCE : Risque d'incendie et de décharge électrique

Branchez les bornes de la batterie avant la connexion des bornes de réseau. La borne positive (+) de la batterie a un capuchon rouge, la borne positive (+) solaire a un capuchon jaune.

WIRE SIZING

The four large power terminals are sized for 14 - 2 AWG (2.5 - 35 mm²) wire. The terminals are rated for copper and aluminum conductors. Use UL-listed Class B or Class C stranded wire rated for 300 Volt and 75C or higher. Copper is recommended due to the ease of use, good conductivity, strength and lower thermal expansion properties.

It is critical that the ampacity (or current carrying capacity) of conductors is sufficient to handle the maximum current of the power circuits. Good system design generally requires large conductor wires that limit voltage drop losses to 2% or less.

See the APPENDIX A - Wire Sizing - for copper wire sizing instructions including minimum wire sizing and voltage drop distance tables.

REQUIRED OVERCURRENT PROTECTION DEVICES (OCPD) AND DISCONNECT SWITCHES

WARNING: Risk of Fire

Solar and battery overcurrent protection (breakers or fuses) are required in the system. These protection devices are external to the TriStar MPPT controller, and must be sized as required by the NEC or local code requirements.

WARNING: Shock Hazard

The PV system requires a means of disconnecting the battery and PV array. Breaker switches or disconnect switches can serve as a disconnecting means and should be located at a readily accessible location. For best practices and safety guidance see NEC 690 "Part III - Disconnecting Means" for disconnect requirements for PV systems in addition to other code requirements.

WARNING: Shock Hazard

Fuses, single-pole circuit breakers, or single-pole disconnect switches must only be installed on ungrounded system conductors. The NEC allows and may require the use of double-pole breakers or double-pole disconnect switches which break both the grounded and ungrounded conductors of the PV array.

WARNING: Risk of Fire

Maximum battery short-circuit current rating must be less than the interrupt current rating of the battery over-current protection device.

BATTERY DISCONNECT AND OVER-CURRENT PROTECTION DEVICE SIZING

The U.S. NEC requires the installation of DC breakers or fused disconnect switches in all battery circuits in order to provide both a means of disconnection and overcurrent protection.

The battery breaker or fused disconnect switch(es) should be located near the battery or the battery busbar. Where the controller battery terminals are more than 1.5m (5 feet) from the battery, or where circuits from these terminals pass through a wall or partition, U.S. NEC requires that a means of disconnection be provided at the battery and solar controller with overcurrent protection at the DC (battery) power source.

The minimum battery disconnect switch current rating is the current rating of the controller being installed. To provide over-current protection when using a disconnect switch, a properly sized fuse or breaker must be installed in series.

Battery breakers or fuses must be sized with a minimum of 125% of the continuous output current rating of the solar controller. Recommended battery circuit fuse or breaker current ratings:

TS-MPPT-30: 40 Amps
TS-MPPT 45: 60 Amps
TS-MPPT-60/M: 75 or 80 Amps

PV INPUT DISCONNECT AND OVER-CURRENT PROTECTION DEVICE SIZING

WARNING: Shock and Fire Hazards

The solar array open-circuit voltage (Voc) at the worst-case (coldest) module temperature must not exceed the PV disconnect or overcurrent protection voltage ratings.

As defined in NEC Section 690.9, PV input disconnect switches must have a current rating greater than or equal to the maximum PV array current (PV array Isc multiplied 1.25). PV array Isc = number of strings multiplied by the module Isc (STC) rating. Note that individual PV string circuits do not require disconnects.

NEC Section 690.9 also provides requirements for overcurrent protection. The PV input breaker or fuse current rating should not be less than the next higher breaker rating above 125% of the maximum PV array current (156% of the PV array Isc). Maximum PV breaker or fuse ratings are:

TS-MPPT-30: 40 Amps
TS-MPPT 45: 60 Amps
TS-MPPT-60/M: 80 Amps

String over-current protection is also required for parallel strings and are typically included with the PV string combiner. There may be other code requirements specific to the installation of a particular PV array.

If 156% of PV array Isc is greater than the maximum PV input breaker or fuse current rating, the PV array breaker or fuse should be located at the output of the PV array combiner.

CONNECT THE POWER WIRES



WARNING: Shock Hazard

The solar PV array can produce open-circuit voltages in excess of 150 Vdc when in sunlight. Verify that the solar input breaker or disconnect has been opened (disconnected) before installing the system wires.



AVERTISSEMENT : Risque de décharge électrique

Le réseau PV solaire peut produire des tensions de circuit ouvert supérieures à 150 Vdc à la lumière du soleil. Vérifiez que le coupe-circuit ou l'interrupteur d'entrée solaire a été ouvert (déconnexion) avant d'installer les câbles du système.

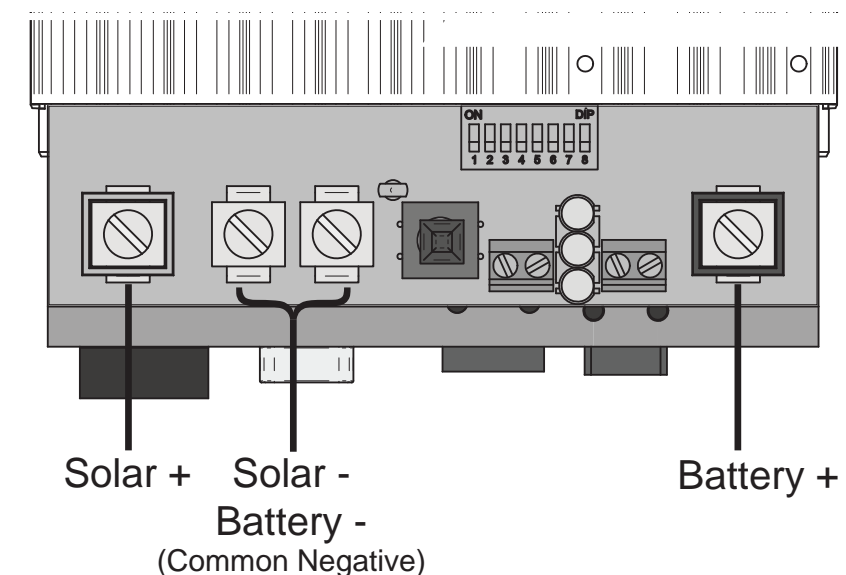

Figure 3-7. Power terminal locations

Connect the four (4) power conductors shown in Figure 3-7 above in the following steps:

1. Confirm that the system input and output disconnect switches are both turned off before connecting the power wires to the controller. There are no disconnect switches inside the TriStar MPPT 150V.
2. Provide for strain relief if the bottom knockouts are used and conduit is not used.
3. Pull the wires into the wiring box. The Remote Temperature Sensor and Battery Sense wires can be inside the conduit with the power conductors. It is easier to pull the RTS and Sense wires before the power cables.



WARNING: Risk of Damage

Be very certain that the battery connection is made with correct polarity. Turn on the battery breaker/disconnect and measure the voltage on the open battery wires **BEFORE** connecting to the TriStar MPPT 150V. Disconnect the battery breaker/disconnect before wiring to the controller.



AVERTISSEMENT : Risque d'endommagement

Assurez-vous que la connexion à la batterie est effectuée avec la polarité correcte. Activez le coupe-circuit/interrupteur de la batterie et mesure la tension sur les câbles ouverts **AVANT** la connexion au TriStar MPPT 150V. Déconnectez le coupe-circuit/interrupteur de la batterie avant le câblage sur le contrôleur.

4. Connect the Battery (+) wire to the Battery (+) terminal on the TriStar MPPT 150V. The Battery (+) terminal has a red cover.
5. Connect the Battery (-) wire to one of the Common Negative terminals on the TriStar MPPT 150V.



WARNING: Risk of Damage

Be very certain that the solar connection is made with correct polarity. Turn on the solar array breaker/disconnect and measure the voltage on the open wires **BEFORE** connecting to the TriStar MPPT 150V. Disconnect the solar breaker/disconnect before wiring to the controller.



AVERTISSEMENT : Risque d'endommagement

Assurez-vous que la connexion solaire est effectuée avec la polarité correcte. Activez le coupe-circuit/interrupteur de réseau solaire et mesure la tension sur les câbles ouverts **AVANT** la connexion au TriStar MPPT 150V. Déconnectez le coupe-circuit/interrupteur solaire avant le câblage sur le contrôleur.

6. Connect the TriStar MPPT 150V battery (+) wire (through a properly sized breaker) as close as possible to the system battery (+) post: then connect the battery (-) wire to the system battery (-) post (system battery not shown).
7. Connect the Solar (+) wire to the Solar + terminal on the TriStar MPPT 150V. The Solar (+) terminal has a yellow cover.
8. Connect the Solar (-) wire to one of the Common Negative terminals on the TriStar MPPT 150V.

Torque all four (4) power terminals to 50 in-lbs (5.65 Nm)

POWER-UP



WARNING: Risk of Damage

Connecting the solar array to the battery terminal will permanently damage the TriStar MPPT 150V.



WARNING: Risk of Damage

Connecting the solar array or battery connection with reverse polarity will permanently damage the TriStar MPPT 150V.



AVERTISSEMENT : Risque d'endommagement

La connexion du réseau solaire sur la borne de la batterie endommagera le TriStar MPPT 150V de façon permanente.



AVERTISSEMENT : Risque d'endommagement

La connexion du réseau solaire ou la connexion de la batterie avec une polarité inversée endommagera le TriStar MPPT 150V de façon permanente.

- Confirm that the Solar and Battery polarities are correct.
- Turn the battery disconnect switch on first. Observe that the LEDs indicate a successful start-up. (LEDs blink Green - Yellow - Red in one cycle)
- Note that a battery must be connected to the TriStar MPPT 150V to start and operate the controller. The controller will not operate only from solar input.
- Turn the solar disconnect on. If the solar array is in full sunlight, the TriStar MPPT 150V will begin charging. If an optional TriStar Meter is installed, charging current will be reported along with charging state.

TO POWER-DOWN



WARNING: Risk of Damage

ONLY disconnect the battery from the TriStar MPPT 150V **AFTER** the solar input has been disconnected. Damage to the controller may result if the battery is removed while the TriStar MPPT 150V is charging.



AVERTISSEMENT : Risque d'endommagement

Le TriStar MPPT 150V **SEULEMENT** déconnecter la batterie **APRÈS** l'entrée solaire a été déconnectée. Le contrôleur pourrait endommager si la batterie est retirée quand le TriStar MPPT 150V est en charge.

- Per warning above: To prevent damage, power-down must be done in the reverse order as power-up.

4.0 Operation

The TriStar MPPT 150V operation is fully automatic. After installation is completed, there are few operator tasks to perform. However, the operator should be familiar with the operation and care of the TriStar MPPT 150V as described in this section.

4.1 TrakStar™ MPPT Technology

The TriStar MPPT 150V utilizes Morningstar's TrakStar™ Maximum Power Point Tracking (MPPT) technology to extract maximum power from the solar array. The tracking algorithm is fully automatic and does not require user adjustment. TrakStar™ technology tracks the array *maximum power point* as it varies with weather conditions, ensuring that maximum power is harvested from the array throughout the course of the day.

Current Boost

Under most conditions, TrakStar™ MPPT technology will “boost” the solar charge current. For example, a system may have 36 Amps of solar current flowing into the TS-MPPT and 44 Amps of charge current flowing out to the battery. The TriStar MPPT 150V does not create current! Rest assured that the power into the TriStar MPPT 150V is the same as the power out of the TriStar MPPT 150V. Since power is the product of voltage and current (Volts x Amps), the following is true¹:

- (1) Power Into the TriStar MPPT 150V = Power Out of the TriStar MPPT 150V
- (2) Volts In x Amps In = Volts Out x Amps Out

¹ assuming 100% efficiency. Losses in wiring and conversion exist.

If the solar module's *maximum power voltage* (V_{mp}) is greater than the battery voltage, it follows that the battery current must be proportionally greater than the solar input current so that input and output power are balanced. The greater the difference between the V_{mp} and battery voltage, the greater the current boost. Current boost can be substantial in systems where the solar array is of a higher nominal voltage than the battery as described in the next section.

High Voltage Strings and Grid-Tie Modules

Another benefit of TrakStar™ MPPT technology is the ability to charge batteries with solar arrays of higher nominal voltages. For example, a 12 volt battery bank may be charged with a 12, 24, 36, or 48 volt nominal off-grid solar array. Grid-tie solar modules may also be used as long as the solar array *open circuit voltage* (V_{oc}) rating will not exceed the TriStar MPPT 150V 150 Volt maximum input voltage rating at worst-case (coldest) module temperature. The solar module documentation should provide V_{oc} vs. temperature data.

Higher solar input voltage results in lower solar input current for a given input power. High voltage solar input strings allow for smaller gauge solar wiring. This is especially helpful and economical for systems with long wiring runs between the controller and the solar array.

An Advantage Over Traditional Controllers

Traditional controllers connect the solar module directly to the battery when recharging. This requires that the solar module operate in a voltage range that is usually below the module's V_{mp} . In a 12 Volt system for example, the battery voltage may range from 10 - 15 Vdc, but the module's V_{mp} is typically around 16 or 17 Volts. Figure 4-1 shows typical current vs. voltage and power output curves for a nominal 12 Volt off-grid module.

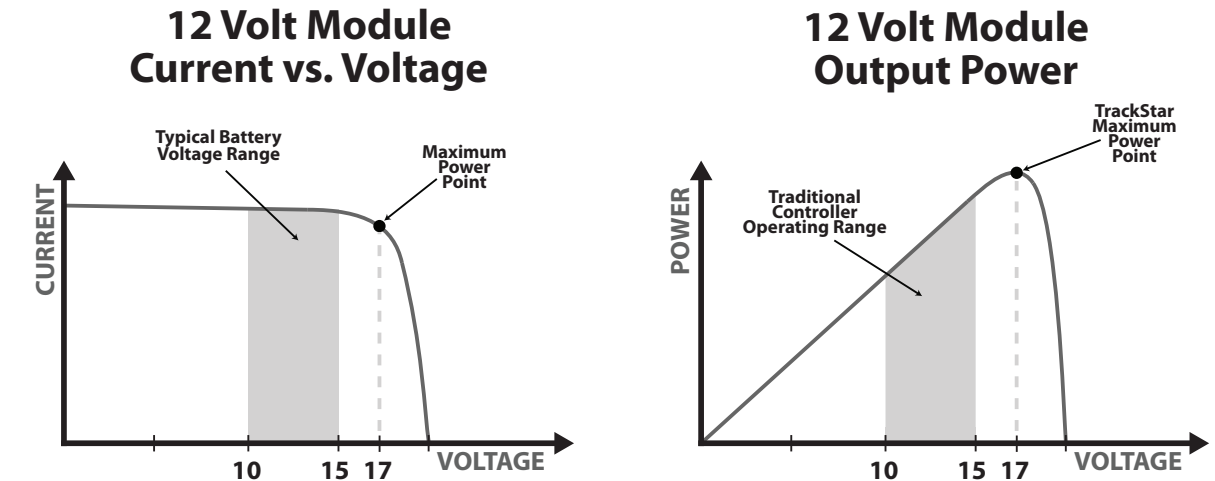

Figure 4-1. Nominal 12 Volt Solar Module I-V curve and output power graph.

The array V_{mp} is the voltage where the product of output current and voltage (Amps x Volts) is greatest, which falls on the “knee” of the solar module I-V curve as shown on the left in Figure 4-1.

Because traditional controllers do not always operate at the V_{mp} of the solar array, energy is wasted that could otherwise be used to charge the battery and power system loads. The greater the difference between battery voltage and the V_{mp} of the module, the more energy is wasted. TrakStar™ MPPT technology will always operate at the maximum power point resulting in less wasted energy compared to traditional controllers.

Conditions That Limit the Effectiveness of MPPT

The V_{mp} of a solar module decreases as the temperature of the module increases. In very hot weather, the V_{mp} may be close or even less than battery voltage. In this situation, there will be very little or no MPPT gain compared to traditional controllers. However, systems with modules of higher nominal voltage than the battery bank will always have an array V_{mp} greater than battery voltage. Additionally, the savings in wiring due to reduced solar current make MPPT worthwhile even in hot climates.

4.2 Battery Charging Information

4-Stage Charging

The TriStar MPPT 150V has a 4-stage battery charging algorithm for rapid, efficient, and safe battery charging. Figure 4-2 shows the sequence of the stages.

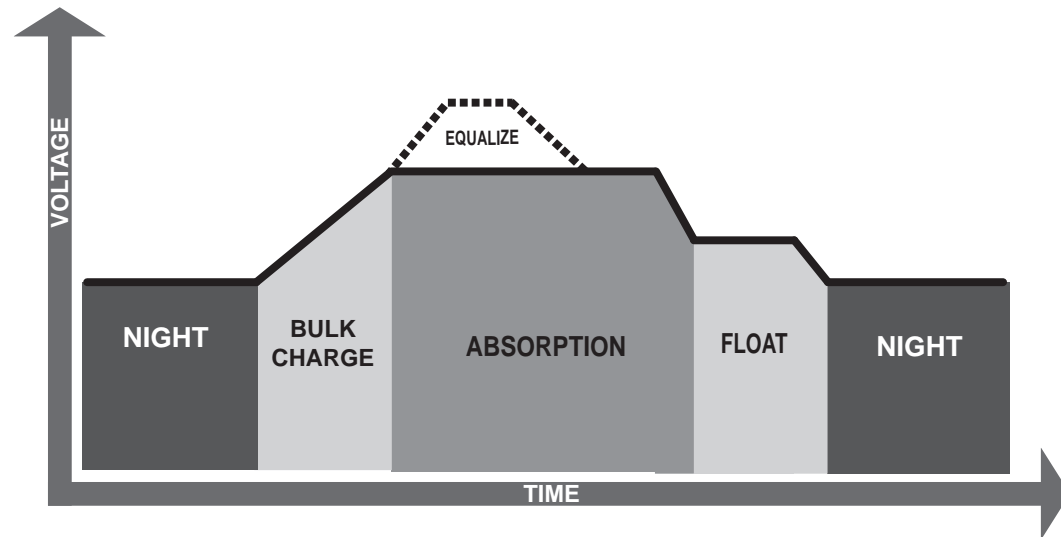

Figure 4-2. TriStar MPPT 150V Charging Algorithm

Bulk Charge Stage

In Bulk charging stage, the battery is not at 100% state of charge and battery voltage has not yet charged to the Absorption voltage set-point. The controller will deliver 100% of available solar power to recharge the battery.

Absorption Stage

When the battery has recharged to the Absorption voltage set-point, constant-voltage regulation is used to maintain battery voltage at the Absorption set-point. This prevents heating and excessive battery gassing. The battery is allowed to come to full state of charge at the Absorption voltage set-point. The green SOC LED will blink once per second during Absorption charging.

The battery must remain in the Absorption charging stage for a cumulative 150 - 180 minutes, depending on battery type, before transition to the Float stage will occur. However, Absorption time will be extended by 30 minutes if the battery discharges below 12.5 Volts (25 Volts @24 V, 50 Volts @48 V) the previous night.

The Absorption set-point is temperature compensated if the RTS is connected; otherwise, voltages set-points are based on the reference of 25°C.

Float Stage

After the battery is fully charged in the Absorption stage, the TriStar MPPT 150V reduces the battery voltage to the Float voltage set-point. When the battery is fully recharged, there can be no more chemical reactions and all the charging current is turned into heat and gassing. The float stage provides a very low rate of maintenance charging while reducing the heating and gassing of a fully charged battery. The purpose of float is to protect the battery from long-term overcharge. The green SOC LED will blink once every two (2) seconds during Float charging.

Once in Float stage, loads can continue to draw power from the battery. In the event that the system load(s) exceed the solar charge current, the controller will no longer be able to maintain the battery at the Float set-point. Should the battery voltage remain below the Float set-point for a cumulative 60 minute period, the controller will exit Float stage and return to Bulk charging.

The Float set-point is temperature compensated if the RTS is connected; otherwise, voltages set-points are based on the reference of 25°C.

Equalize Stage



WARNING: Risk of Explosion

Equalizing vented batteries produces explosive gases. The battery bank must be properly ventilated.



CAUTION: Equipment Damage

Equalization increases the battery voltage to levels that may damage sensitive DC loads. Verify all system loads are rated for the temperature compensated Equalize voltage before beginning an Equalization charge.



CAUTION: Equipment Damage

Excessive overcharging and gassing too vigorously can damage the battery plates and cause shedding of active material from the plates. An equalization that is too high or long can be damaging. Review the requirements for the particular battery being used in your system.



AVERTISSEMENT : Risque d'explosion

Les batteries à évent et compensation produisent des gaz explosifs. Le groupe de batteries doit être correctement ventilé.



PRUDENCE : Endommagement de l'équipement

La compensation augmente la tension des batteries à des niveaux pouvant endommager les charges sensibles en CC. Vérifiez que toutes les charges du système sont conçues pour la tension de compensation par température avant de commencer une charge de compensation.



PRUDENCE : Endommagement de l'équipement

Une surcharge excessive et un dégagement gazeux trop vigoureux peuvent endommager les plaques de batteries et provoquer l'élimination du matériau actif des plaques. Une compensation trop élevée ou trop longue peut provoquer des dégâts. Examinez les exigences pour la batterie particulière utilisée dans votre système.

Certain battery types benefit from a periodic boost charge to stir the electrolyte, level the cell voltages, and complete the chemical reactions. Equalize charging raises the battery voltage above the standard absorption voltage so that the electrolyte gases. The green SOC LED will blink rapidly two (2) times per second during equalization charging.

The duration of the equalize charge is determined by the selected battery type. See table 4-1 in this section for more details. The *Equalization Time* is defined as time spent at the equalize set-point. If there is insufficient charge current to reach the equalization voltage, the equalization will terminate after an additional 60 minutes to avoid over gassing or heating the battery. If the battery requires more time in equalization, an equalize can be requested using the TriStar Meter or push-button to continue for one or more additional equalization cycles.

The Equalize set-point is temperature compensated if the RTS is connected; otherwise, voltages set-points are based on the reference of 25°C.

When to Equalize

The ideal frequency of equalizations depends on the battery type (lead-calcium, lead-antimony, etc.), the depth of discharging, battery age, temperature, and other factors. One very broad guide is to equalize flooded batteries every 1 to 3 months or every 5 to 10 deep discharges. Some batteries, such as the L-16 group, will need more frequent equalizations.

The difference between the highest cell and lowest cell in a battery can also indicate the need for an equalization. Either the specific gravity or the cell voltage can be measured. The battery manufacturer can recommend the specific gravity or voltage values for your particular battery.

Why Equalize?

Routine equalization cycles are often vital to the performance and life of a battery - particularly in a solar system. During battery discharge, sulfuric acid is consumed and soft lead sulfate crystals form on the plates. If the battery remains in a partially discharged condition, the soft crystals will turn into hard crystals over time. This process, called “lead sulfation,” causes the crystals to become harder over time and more difficult to convert back to soft active materials.

Sulfation from chronic undercharging of the battery is the leading cause of battery failures in solar charging systems. In addition to reducing the battery capacity, sulfate build-up is the most common cause of buckling plates and cracked grids. Deep cycle batteries are particularly susceptible to lead sulfation.

Normal charging of the battery can convert the sulfate back to the soft active material if the battery is fully recharged. However, a solar charged battery is seldom completely recharged, so the soft lead sulfate crystals harden over a period of time. Only a long controlled overcharge, or equalization, at a higher voltage can reverse the hardening of sulfate crystals.

Preparation for Equalization

First, confirm that all of the system loads are rated for the equalization voltage. Consider that at 0°C (32°F) the equalization voltage will reach 16.75 Volts for 12 Volt L-16 batteries (67.0 Volts for 48 Volt systems) with a temperature sensor installed. Disconnect any loads at risk of damage due to the high input voltage.

If Hydrocaps are used, be sure to remove them before starting an equalization. Replace the Hydrocaps with standard battery cell caps. The Hydrocaps can get very hot during an equalization. Also, if Hydrocaps are used, the equalization should be set for manual only (DIP switch #7 is Off).

After the equalization is finished, add distilled water to each cell to replace gassing losses. Check that the battery plates are covered.

Equalize a Sealed Battery?

The *Battery Charging Settings* table (see table 4-1 in this section) shows two sealed battery settings with an Equalization cycles. These are minimal “boost” cycles to level individual cells. This is not an equalization, and will not vent gas from sealed batteries that require up to 14.4V charging (12V battery). Many VRLA batteries, including AGM and gel, have charging requirements up to 14.4V (12V battery). Depending on the battery manufacturer’s recommendation, the “boost” cycle for sealed cells can be disabled by setting the equalize setting switch to manual, if required.

Battery Charging Settings

Preset TriStar MPPT 150V battery charging options are shown in tables 4-1 and 4-2 below. All voltage settings listed are for nominal 12 Volt batteries. Multiply the voltage settings by two (2) for 24 Volt batteries or by four (4) for 48 Volt systems.



NOTE: *These settings are general guidelines for use at the operator’s discretion. The TriStar MPPT 150V can be set or programmed to charge to virtually any specific requirements, but only the battery manufacturer can recommend optimal settings for their products.*

Settings Switches 4 - 5 - 6	Battery Type	Absorp. Stage (Volts)	Float Stage (Volts)	Equalize Stage (Volts)	Absorp. Time (Minutes)	Equalize Time (Minutes)	Equalize Interval (Days)
off-off-off	1 - Gel	14.00	13.70		150		
off-off-on	2 - Sealed ¹	14.15	13.70	14.40	150	60	28
off-on-off	3 - Sealed ¹	14.30	13.70	14.60	150	60	28
off-on-on	4 - AGM/Flooded	14.40	13.70	15.10	180	120	28
on-off-off	5 - Flooded	14.60	13.50	15.30	180	120	28
on-off-on	6 - Flooded	14.70	13.50	15.40	180	180	28
on-on-off	7 - L-16	15.40	13.40	16.00	180	180	14
on-on-on	8 - Custom	Custom	Custom	Custom	Custom	Custom	Custom

¹ “Sealed” battery type includes gel and AGM batteries

Table 4-1. Battery charging settings for each selectable battery type

The TriStar MPPT 150V provides seven (7) standard battery charging settings that are selectable with the settings DIP switches (see Figure 4.1 above). These standard charging settings are suitable for lead-acid batteries ranging from sealed (gel, AGM, maintenance-free) to Flooded and L-16 cells. In addition, an 8th charging setting provides for custom set-points using MSView™ PC software.

Shared Settings	Value	Units
Absorption Extension Voltage	12.50	Volts
Absorption Extension Time	Absorption Time + 30	minutes
Float Exit Timeout	60	minutes
Float Cancel Voltage	12.30	Volts
Equalize Timeout	Equalize Time + 60	minutes
Temperature Compensation Coefficient ¹	- 5	millivolts / °C / cell

¹ 25°C reference

Table 4-2. Battery settings that are shared between all battery types

The shared settings in Table 4-2 above are common to all battery types. The following illustrations graphically explain the shared settings.

Absorption Extension

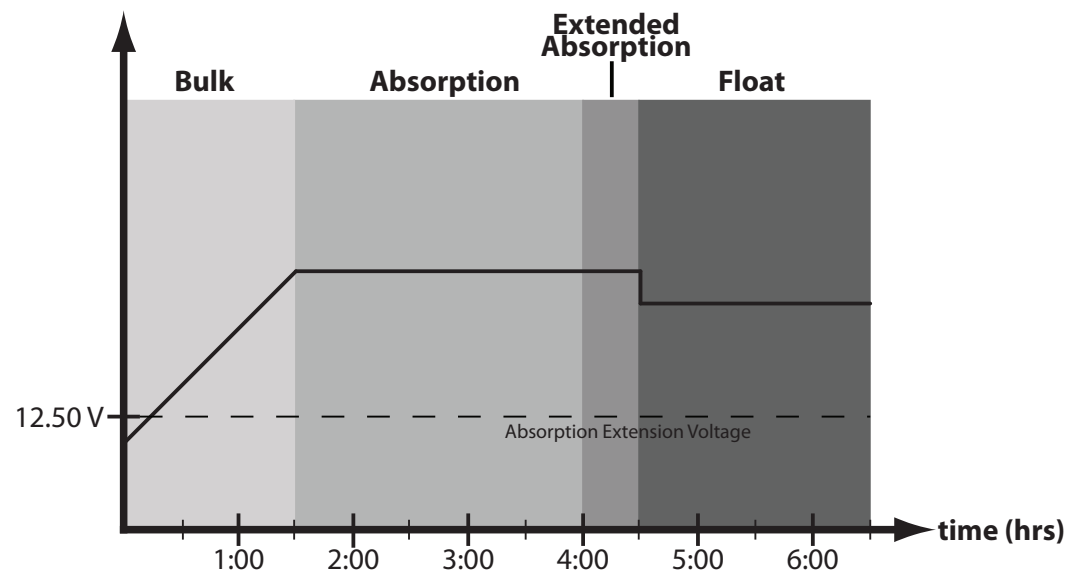

Figure 4-3. Absorption extension charging profile.

If battery voltage discharges below 12.50 Volts (25.00 Volts @ 24 V, 50 Volts @ 48 V) the previous night, Absorption charging will be extended on the next charge cycle as shown in figure 4-3 above. 30 minutes will be added to the normal Absorption duration.

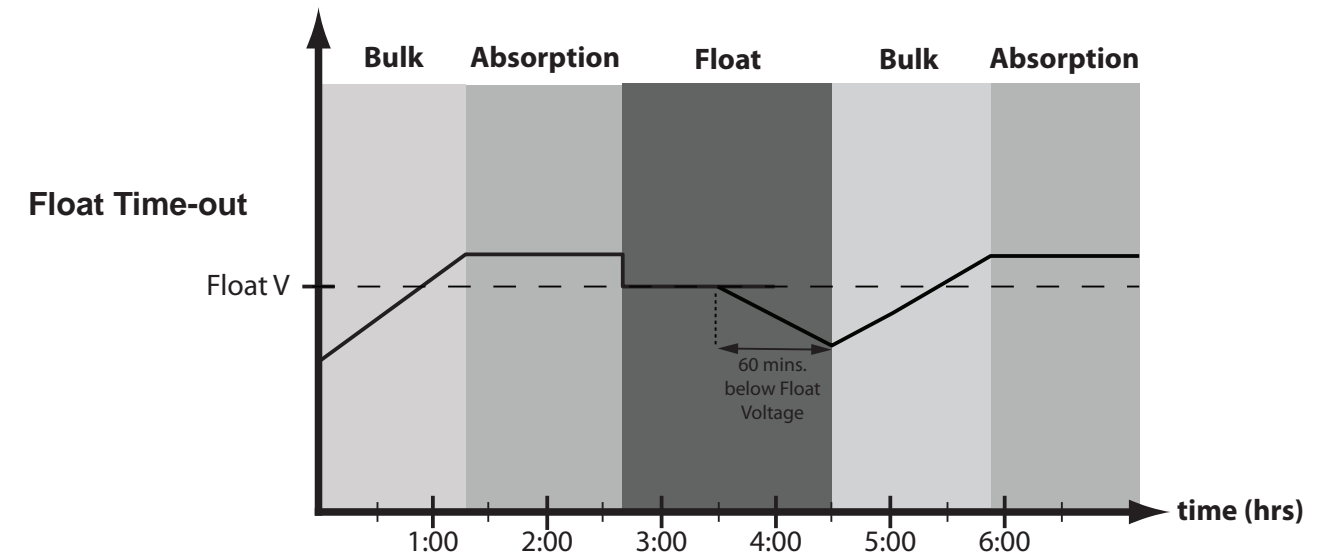

Figure 4-4. Float exit time-out charging profile

After entering Float stage, the controller will only exit Float if the battery voltage remains below Float voltage for 60 cumulative minutes. In figure 4-4, a system load turns on at 3:30 hrs when the controller is in Float stage, runs for one hour, and turns off at 4:30 hrs. The load current draw is larger than the charge current, causing battery voltage to drop below Float voltage for 60 minutes. After the load runs for 60 minutes, the time-out causes the controller to return to Bulk charging, and then Absorption stage once again. In this example, a load runs continuously for 60 minutes. However, because the Float exit timer is cumulative, multiple momentary load events that pull the battery voltage below Float voltage for a combined 60 minutes duration will also force an exit from Float stage.

Float Cancel Voltage

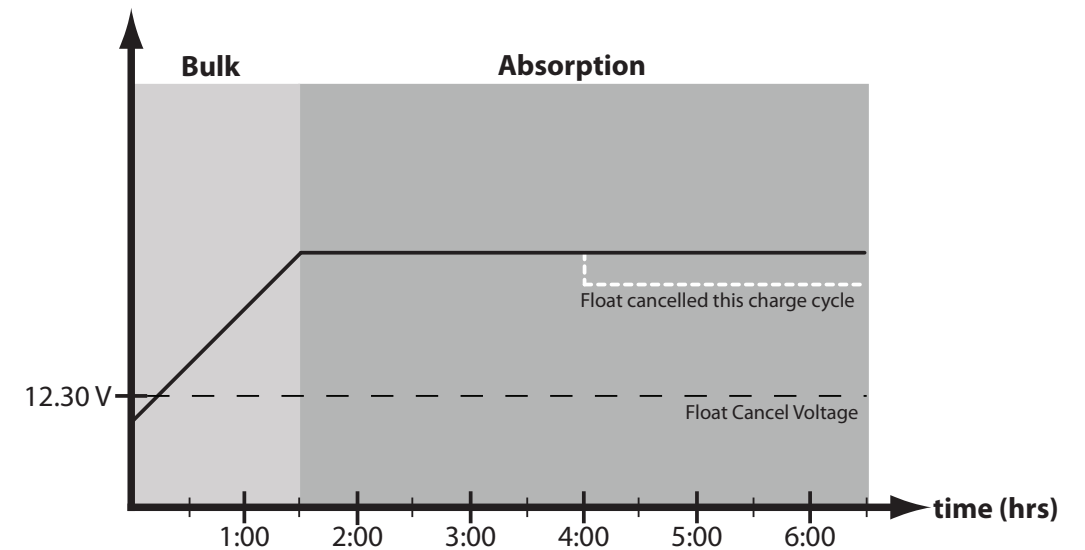

Figure 4-5. Float cancelled charging profile

If the battery bank discharges below 12.30 Volts (24.60 Volts @ 24 V, 49.20 Volts @ 48 V) the previous night, Float charging stage will be cancelled for the next charge cycle. Figure 4-5 above illustrates this concept. At 0:00 hrs (dawn), battery voltage is below the Float Cancel threshold voltage. The diagram shows where Float stage would have occurred if Float was not cancelled.

Equalize Time-out

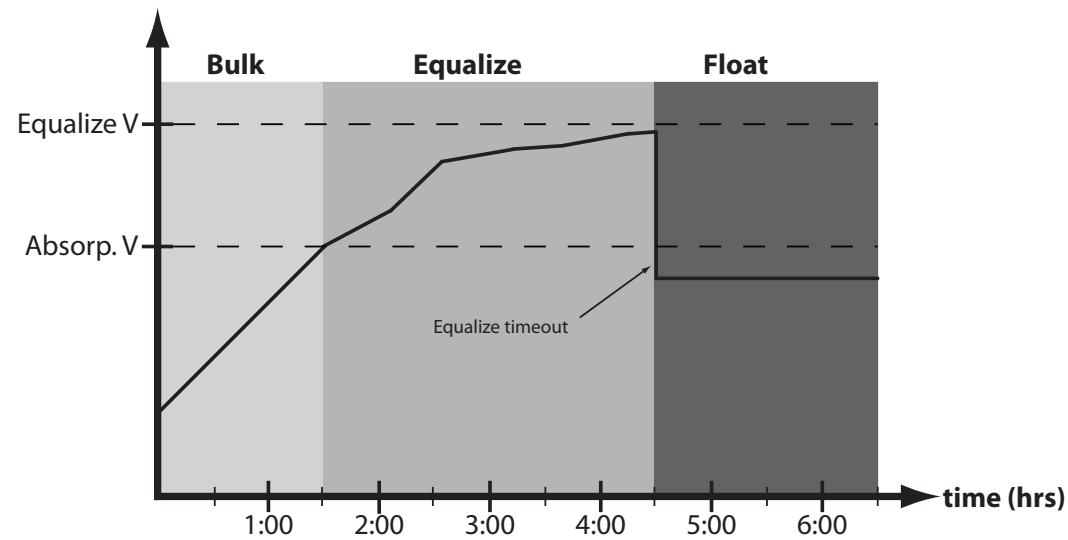

Figure 4-6. Equalize timeout charging profile

The charging profile in figure 4-6 shows an *Equalize Timeout* event. The timeout timer begins as soon as battery voltage exceeds the Absorption voltage setpoint. If there is insufficient charging current or system loads are too large, the battery voltage may not reach the Equalize setpoint. Equalize Timeout is a safety feature that prevents high battery voltage for extended periods of time which may damage the battery.

Temperature Compensation

All charging settings are based on 25°C (77°F). If the battery temperature varies by 5°C, the charging setting will change by 0.15 Volts for a 12 Volt battery. This is a substantial change in the charging of the battery, and the use of the Remote Temperature Sensor (RTS) is recommended to adjust charging to the actual battery temperature.

The need for temperature compensation depends on the temperature variations, battery type, how the system is used, and other factors. If the battery appears to be gassing too much or not charging enough, the RTS can be added at any time after the system has been installed. See Section 2.3 - Step 4 for installation instructions.

Battery Sense

Voltage drops are unavoidable in power cables that carry current, including the TriStar MPPT 150V battery cables. If Battery Sense wires are not used, the controller must use the voltage reading at the battery power terminals for regulation. Due to voltage drops in the battery cables, the battery power connection voltage will be higher than the actual battery bank voltage while charging the battery.

Two sense wires, sized from 1.0 to 0.25 mm² (16 to 24 AWG), can be used for battery voltage sense. Because these wires carry no current, the voltage at the TriStar will be identical to the battery voltage. A 2-position terminal is used for the battery sense connection. Generally accepted wiring practice is to limit voltage drops between the charger and the battery to 2%.

Even properly sized wiring with 2% drop can result in a 0.29 Volt drop for 14.4V charging (or 1.15 Volt for a 48 Volt nominal system). Voltage drops will cause some undercharging of the battery. The controller will begin Absorption or limit equalization at a lower battery voltage because the controller measures a higher voltage at the controller's terminals than is the actual battery voltage. For example, if the controller is programmed to start Absorption at 14.4V, when the controller "sees" 14.4V at its battery terminals, the true battery voltage would only be 14.1V if there is a 0.3V drop between the controller and battery.

Note that the battery sense wires will not power the controller, and the sense wires will not compensate for losses in the power wires between the controller and the battery. The battery sense wires are used to improve the accuracy of the battery charging.

See Section 3.2 - Step 7 for instructions on how to connect the battery sense wires.

4.3 Push-button

The following functions can be enabled with the push-button (located on the front cover):

PUSH

- Reset from an error or fault.
- Reset the battery service indication if this has been activated in custom settings. A new service period will be started, and the flashing LEDs will stop blinking. If the battery service is performed before the LEDs begin blinking, the push-button must be pushed at the time when the LEDs are blinking to reset the service interval and stop the blinking.

PUSH AND HOLD 5 SECONDS

- Request battery equalization manually. The TriStar MPPT 150V will begin equalization in either the manual or automatic equalization mode. Equalization will begin when there is sufficient solar power to charge the battery up to the equalization voltage. The LEDs will blink the sequence defined in table 4-3 below to confirm that an equalize has been requested. The equalization request will automatically stop per the battery type selected (see Section 4.4). Equalization will only occur if the selected battery type has an equalization stage.
- Stop an equalization that is in progress. This will be effective in either the manual or automatic mode. The equalization will be terminated. The LEDs will blink to confirm the equalize has been cancelled as shown in table 4-3 below.

Push-button Action	SOC LED Indication ¹
Manual Equalization Started	Green / Yellow / Red - Green / Yellow / Red - Green - Green
Stop Equalization	Green / Yellow / Red - Green / Yellow / Red - Red - Red

Table 4-3. Manual equalization LED indications

**NOTE:**

For multiple TriStar MPPT 150V controllers on a MeterBus™ network, initialize a battery equalization using the TriStar meter so that all controllers are synchronized.

**REMARQUE :**

Avec plusieurs contrôleurs TriStar MPPT 150V sur un réseau MeterBus™, initialisez une compensation de batteries à l'aide de l'outil de mesure TriStar afin de synchroniser tous les contrôleurs.

Note that if two or more TriStar MPPT 150V controllers are charging in parallel, each controller may attempt to equalize on a different day. Systems with multiple controllers should only equalize manually to ensure synchronization between controllers.

4.4 LED Indications

Valuable information can be provided by the three LEDs visible through the front cover. Although there are many different LED indications, they have similar patterns to make it easier to interpret each LED display. Consider as three groups of indications: General Transitions // Battery Status // Faults & Alarms.

LED Display Explanation

G = green LED is lit

Y - R = yellow LED is lit, then red LED is lit alone

G / Y = green and yellow are both lit at the same time

G / Y - R = green & yellow both lit, then red is lit alone

Sequencing LED patterns (faults) repeat until the fault is cleared

General Transitions

- | | |
|--|--|
| • Controller start-up | G - Y - R (one cycle) |
| • Equalize start request | G / Y / R - G / Y / R - G - G |
| • Equalize cancelled | G / Y / R - G / Y / R - R - R |
| • Battery service is required ¹ | all three LEDs blinking until service is reset |

¹ Battery service notification is only enabled in custom settings, or when any custom edit is programmed

Battery Status

- | | |
|---------------------------|---|
| • General state-of-charge | See battery SOC LED indications below |
| • Absorption state | G blinking (½ second on / ½ second off) |
| • Equalization state | G fast blink (2.5 times per second) |
| • Float state | G slow blink (1 second on / 1 second off) |

Faults & Alarms

- | | |
|-----------------------------------|--|
| • Over-temperature | Y - R sequencing |
| • High voltage disconnect | G - R sequencing |
| • DIP switch fault | R - Y - G sequencing |
| • Self-test faults | R - Y - G sequencing |
| • Remote Temperature Sensor (RTS) | G - R sequencing, with constant yellow |
| • Battery voltage sense | G - R sequencing, with constant yellow |
| • Battery over-current | R / Y - G sequencing |

Battery State-of-Charge LED Indications

- | | |
|-------|------------------------|
| G | 80% to 95% SOC |
| G / Y | 60% to 80% SOC |
| Y | 35% to 60% SOC |
| Y / R | 0% to 35% SOC |
| R | battery is discharging |

Refer to the Specifications (Section 8.0) for the State-of-Charge voltages.

Note that because these State-of-Charge LED displays are for all battery types and system designs, they are only approximate indications of the battery charge state.

Ethernet Jack Indications

In addition to the SOC LEDs, two (2) small LEDs can be found on the Ethernet RJ-45 jack inside the wiring box. These LEDs indicate the LAN/WAN network link and activity status as follows:

Condition	Green LED	Yellow LED
Network Connection OK	ON	OFF
Network Activity	ON	Blinking
Error	OFF	ON

4.5 Protections, Faults & Alarms

The TriStar MPPT 150V protections and automatic recovery are important features that ensure the safe operation of the system. Additionally, the TriStar MPPT 150V features real-time self diagnostics that report Fault and Alarm conditions as they occur.

Faults are events or conditions that require the TriStar MPPT 150V to cease operation. A Fault usually occurs when a limit such as voltage, current, or temperature has been surpassed. Fault conditions are indicated with unique LED sequences and are also displayed on the TriStar Meter.

Alarms are events or conditions that may require the TriStar MPPT 150V to modify operation. Alarms are commonly used to alert the user that the controller is nearing a specific voltage, current, or temperature limit. Alarm conditions are only displayed on the TriStar Meter.

Protections

Solar Overload

The TriStar MPPT 150V will limit battery current to the *Maximum Battery Current* rating. An over-sized solar array will not operate at peak power. The solar array should be less than the TriStar MPPT 150V *Nominal Maximum Input Power* rating for optimal performance. For more information see the Nominal Maximum Input Power asterisk on p. 63.

Solar Short Circuit

The TriStar MPPT 150V will disconnect the solar input if a short circuit is detected in the solar wiring. Charging automatically resumes when the short is cleared. No LED indication.

High Input Voltage Current Limit

The TriStar MPPT 150V will limit the solar input current as the solar array Voc approaches the maximum input voltage rating. The array Voc should never exceed the 150 volt maximum input voltage - see the array voltage de-rating graph in Appendix.

Very Low Battery Voltage

If battery discharges below ~7 Volts the controller will go into brownout and shut down. When the battery voltage rises above the 8 Volt minimum operating voltage, the controller will restart.

Faults

Remote Temperature Sensor Failure (G - R sequencing, with constant yellow)

If a fault in the RTS (such as a short circuit, open circuit, loose terminal) occurs after the RTS has been working, the LEDs will indicate a failure. However, if the controller is restarted with a failed RTS, the controller may not detect that the RTS is connected, and the LEDs will not indicate a problem. A TriStar meter or the PC software can be used to determine if an RTS is detected and working properly.

Battery Voltage Sense Failure (G - R sequencing, with constant yellow)

If a fault in the battery sense connection (such as a short circuit, open circuit or loose terminal) occurs after the battery sense has been working, the LEDs will indicate a failure. If the controller is restarted with the failure still present, the controller may not detect that the battery sense is connected and the LEDs will not indicate a fault. A TriStar meter or the PC software can be used to determine if the battery sense is working properly.

Battery Over-Current (R / Y - G)

While rare, if battery charging current exceeds approximately 130% of the controller's output current rating, this fault can occur. The fault is generally related to fast, large battery voltage transients (connecting a very heavy or capacitive load like an inverter) that are faster than the controller can regulate and it shuts off to protect the circuitry. The controller will automatically re-start in 10 seconds.

Settings (DIP) Switch Changed (R-Y-G sequencing)

If a settings switch is changed while there is power to the controller, the LEDs will begin sequencing and the solar input will disconnect. The controller must be re-started to clear the fault and begin operation with the new settings.

Battery High Voltage Disconnect (G-R sequencing)

This fault is set when battery voltage is above normal operating limits. The controller will disconnect the solar input and set a High Voltage Disconnect fault. This fault is commonly caused by other charging sources in the system charging the battery above the TriStar MPPT 150V regulation voltage. When the battery voltage returns to normal levels, the fault will automatically clear.

Custom Settings Edit (R -Y- G sequencing)

A value has been modified in custom settings memory. The controller will stop charging and indicate a fault condition. After all settings have been modified, the controller must be reset by removing and then restoring power to the controller. The new programmed settings will be used after the power reset.

Firmware Update Failure

The firmware update was not successfully programmed. The controller will not indicate the full power-up LED sequence of G - Y - R when power to the controller is reset. Instead, the controller will display green and then stop on yellow. The yellow LED will continue to be lit and the controller will not complete start up or begin charging. Retry the firmware update. The firmware must be successfully loaded before the controller will start up.

Alarms

High Temperature Current Limit

The TriStar MPPT 150V will limit the solar input current if the heatsink temperature exceeds safe limits. Solar charge current will be tapered back (to 0 amps if needed) to reduce the heatsink temperature. The TriStar MPPT 150V is designed to operate at full rated current at the maximum ambient temperature. This alarm indicates that there is insufficient airflow and that the heatsink temperature is approaching unsafe limits. If the controller frequently reports this alarm condition, corrective action must be taken to provide better air flow or to relocate the controller to a cooler spot.

High Input Voltage Current Limit

The TriStar MPPT 150V will limit the solar input current as the solar array Voc approaches the maximum input voltage rating. The array Voc should never exceed the 150 Volt maximum input voltage. See the array voltage derating graph in Section 8.0.

Current Limit

The array power exceeds the rating of the controller. This alarm indicates that the TriStar MPPT 150V

is limiting battery current to the maximum current rating.

RTS Open

The Remote Temperature Sensor is not connected to the controller. Use of the RTS is recommended for proper battery charging.

Heatsink Temperature Sensor Open / Shorted

The heatsink temperature sensor is damaged. Return the controller to an authorized Morningstar dealer for service.

Battery Sense Out of Range / Disconnected

A battery sense wire is disconnected. Inspect the battery sense connections. This alarm is set when the voltage at the battery sense voltage differs by more than 5 volts from the voltage at the battery terminals.

Uncalibrated

The controller was not factory calibrated. Return the controller to an authorized Morningstar dealer for service.

4.6 Inspection and Maintenance



WARNING: RISK OF ELECTRICAL SHOCK.

NO POWER OR ACCESSORY TERMINALS ARE ELECTRICALLY ISOLATED FROM DC INPUT, AND MAY BE ENERGIZED WITH HAZARDOUS SOLAR VOLTAGE. UNDER CERTAIN FAULT CONDITIONS, BATTERY COULD BECOME OVER-CHARGED. TEST BETWEEN ALL TERMINALS AND GROUND BEFORE TOUCHING.



AVERTISSEMENT: RISQUE DE CHOC ÉLECTRIQUE.

NON ALIMENTATION OU AUX BORNES D'ACCESSOIRES SONT ISOLÉS ÉLECTRIQUEMENT DE L'ENTRÉE DE C.C ET DOIT ÊTRE ALIMENTÉS À UNE TENSION DANGEREUSE SOLAIRE. SOUS CERTAINES CONDITIONS DE DÉFAILLANCE, LA BATTERIE POURRAIT DEVENIR TROP CHARGÉE. TEST ENTRE TOUTES LES BORNES ET LA MASSE AVANT DE TOUCHER.



WARNING: Shock Hazard

Disconnect all power sources to the controller before removing the wiring box cover. Never remove the cover when voltage exists on the TriStar MPPT 150V power connections.



AVERTISSEMENT : Risque de décharge électrique

Un moyen de déconnexion de tous les poteaux d'alimentation doit être fourni. Ceux-ci se déconnecte doit être intégrée dans le câblage fixe. Ouvrir que toutes les source d'énergie se déconnecte avant de retirer le couvercle de la contrôleur, ou accès au câblage.

Table 4-6 below lists the recommended maintenance schedule to keep your TriStar MPPT 150V performing optimally.

Schedule	Maintenance Items
2 weeks after installation	Re-tighten power terminal connections to specified torque values.
3 months after installation	Re-tighten power terminal connections to specified torque values.
Monthly or After Each Equalization	<p>Inspect the battery bank. Look for cracked or bulging cases, and corroded terminals.</p> <p>For wet cell (flooded type) batteries, make sure the water level is correct. Wet cell water levels should be checked monthly or according to the manufacturer's recommendations.</p>
Annually	<p>Clean the heatsink fins with a clean, dry rag.</p> <p>Inspect all wiring for damage or fraying.</p> <p>Inspect for nesting insects.</p> <p>Re-tighten all wiring terminal connections to specified torque values.</p> <p>Inspect the system earth grounding for all components. Verify all grounding conductors are appropriately secured to earth ground.</p>

Table 4-3. Maintenance Schedule

5.0 Networking and Communication

5.1 Introduction

The TriStar MPPT 150V provides several communication options. The TriStar MPPT 150V uses a proprietary protocol for the MeterBus™ network and the non-proprietary open standard MODBUS™ and MODBUS TCP/IP™ protocols for RS-232, EIA-485, and ethernet networks. Additionally, HTTP, SMTP, and SNMP are supported for web page, email, and network message support. Morningstar's MSView™ PC software provides system monitoring and logging capabilities via RS-232, EIA-485, and Ethernet. MSView™ PC software is available for free on our website at:

<http://www.morningstarcorp.com>

Further, hardware and third party software that supports the MODBUS™ protocol can also be used to communicate with a TriStar MPPT 150V.

Multiple communication ports can be used simultaneously. For example, a TriStar MPPT 150V may be connected to a MeterBus™ network for on-site system metering, connected to the internet for remote monitoring, and connected to an EIA-485 network to bridge data from other controllers in the system to an internet connection. Note that the RS-232 and EIA-485 connections share hardware and therefore cannot be used simultaneously.

Table 5-1 below provides a summary of morningstarcorp.com/supported features for each communication interface.

	MeterBus	RS-232	EIA-485	Ethernet
Display system/network data on a TriStar meter	•			
Connect a TSMPPT to a Relay Driver or other MS Accessory	•			
Connect multiple TSMPPT together in a network	•		•	•
View and log data with MSView™ PC Software		•	•	•
View logged data stored in the TriStar MPPT 150V internal memory	•	•	•	•
Update TriStar MPPT 150V firmware		•		
Program custom settings		•	•	•
View data in a web browser				•
Email notification				•
Text Message Alerts				•
SNMP Alerts				•

Table 5-1. Communication summary

5.2 Morningstar MeterBus™

Morningstar's proprietary MeterBus™ protocol allows communication between compatible Morningstar products. Use a MeterBus™ network to:

- display net system data for multiple TriStar / TriStar MPPT 150V systems**
- communicate with a TriStar Digital Meter 2 or TriStar Remote Meter 2
- communicate with a Relay Driver or other compatible Morningstar accessories (see section 2.5 for more details)

**A Morningstar MeterBus Hub (HUB-1) and either a TriStar Digital Meter 2 (TS-M-2) or TriStar Remote Meter 2 (TS-RM-2) are required, not included.

A MeterBus Hub (model: HUB-1) is required for MeterBus networks containing multiple TriStar MPPT 150V controllers. The ports on the hub are electrically isolated to prevent damage in the event of broken grounds or voltage differences between controllers. Figure 5-1 below shows an example MeterBus™ network with two (2) TriStar MPPT 150V controllers and a TriStar Remote Meter 2 (TS-RM2).

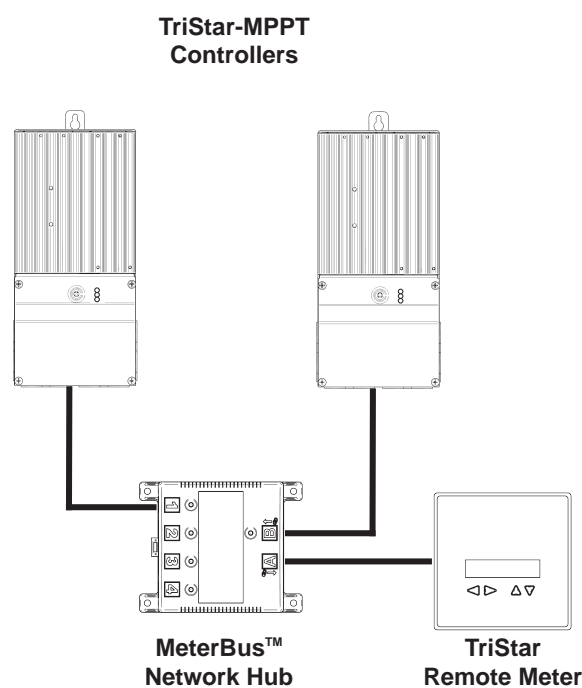

Figure 5-1. An example MeterBus network.

Up to five (5) controllers can be networked together with a single hub. Multiple hubs can be daisy-chained together to allow networks of up to 14 controllers and a meter.

Refer to the HUB-1 and TriStar Meter manuals for more information about Morningstar MeterBus™ networking.

5.3 Serial RS-232

The serial port connection on the TriStar MPPT 150V is a standard 9-pin isolated RS-232 port. See figure 3-5 for the port location. The TriStar MPPT 150V communicates through the serial port via the open standard MODBUS™ protocol.

Connect the TriStar MPPT 150V to the serial port on a PC to:

- program custom charge settings with MSView™ PC software
- view real-time data with MSView™ PC software
- log real-time data with MSView™ PC software
- configure ethernet settings
- update controller firmware with MSLoad™ firmware utility



NOTE:
The RS-232 and EIA-485 ports share hardware. Both ports cannot be used simultaneously.



NOTE:
If your PC does not have a serial port, a USB to Serial cable can be purchased at your local electronics retailer.

The serial connection is ideal for configuring custom settings or monitoring a single TriStar MPPT 150V controller. Figure 5-2 shows a serial connection between the controller and a PC with MSView™ PC software.

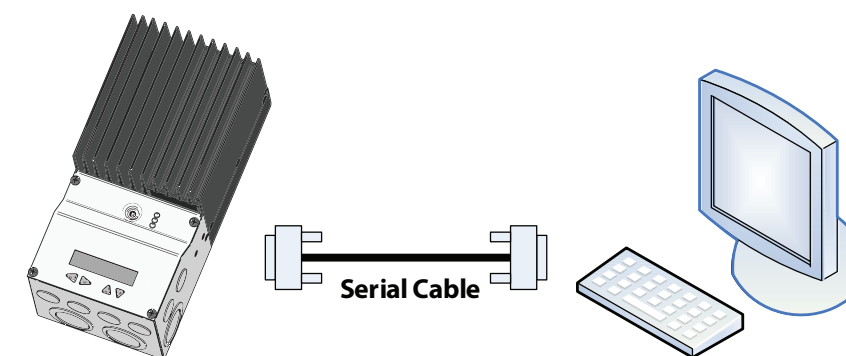

Figure 5-2. A serial connection between a PC and the TriStar MPPT 150V

Serial Port Settings

Adjust the serial port settings as follows:

- 9600 BAUD
- 8 data bits
- 1 or 2 stop bits
- no parity

The serial RS-232 connection provides a direct connection between a TriStar MPPT 150V and a PC (or other serial device). **Firmware updates can only be programmed through the RS-232 connection.** The serial connection is not typically used for multi-controller networking. However, networking is possible using a USB hub and USB-Serial cables. For more information, refer to the “Morningstar Communications Document” at:

www.morningstarcorp.com/support

5.4 EIA-485 (formerly RS-485)



NOTE:

The EIA-485 connection is only available on the TS-MPPT-60/M model.



NOTE:

The RS-232 and EIA-485 ports share hardware. Both ports cannot be used simultaneously.

EIA-485 is a networking standard for serial communication between multiple devices on a bus. The TriStar MPPT 150V communicates over an EIA-485 network via the open standard MODBUS™ protocol. Use EIA-485 networking to:

- connect multiple TriStar MPPT 150V controllers on a network to log and view real-time data using MSView™ PC software
- program each controller on the network with custom charge settings using MSView™ PC software
- connect the TriStar MPPT 150V to other Morningstar controllers with the RSC-1 Serial to EIA-485 Adapter (sold separately)
- bridge an Ethernet connection through a TriStar MPPT 150V to an EIA-485 network

The EIA-485 port has four (4) connections: Power, Data A, Data B, and Ground. Data A & B are differentially driven data lines that carry the network data. Power and Ground connections provide power to the network. The TriStar MPPT 150V does not supply power to the EIA-485 network, therefore an external power source is required. The source voltage must be between 8-16 Vdc. For 12 Volt systems, the network can be powered directly from the system battery. Use a DC-DC converter for 24, 36, and 48 Volt systems.



CAUTION: Equipment Damage

Tapping power off of individual batteries in a series string of batteries can cause a voltage imbalance. Damage to the batteries may result. Always use a DC-DC converter to power the EIA-485 network if the nominal system voltage is greater than 12 volts.



PRUDENCE : Endommagement de l'équipement

L'arrêt progressif de batteries individuelles dans une série de batteries peut provoquer un déséquilibre de tension. Les batteries peuvent être endommagées. Utilisez toujours un convertisseur CC-CC pour convertir l'alimentation au réseau EIA-485 si la tension nominale du système est supérieure à 12 V.

For more information on EIA-485 networking, refer to the “Morningstar Communications Document” on our website at:

morningstarcorp.com/support

5.5 Ethernet



NOTE:

Ethernet is only available on the TS-MPPT-60/M model.



CAUTION: Risk of Tampering

The TS-MPPT does not feature built-in network security. It is the responsibility of the user or network administrator to place the TS-MPPT behind a network firewall to prevent unauthorized access.



PRUDENCE : Risque de tentative d'altération

Le TS-MPPT ne comporte pas de sécurité réseau intégrée. Il incombe à l'utilisateur ou à l'administrateur du réseau de placer le TS-MPPT derrière un pare-feu réseau afin d'empêcher l'accès non autorisé.

The Ethernet port supports HTTP, MODBUS TCP/IP™, SMTP, and SNMP protocols to provide a fully web-enabled interface between the TriStar MPPT 150V and a LAN/WAN network or the internet. Some of the many features the Ethernet connection provides include:

- program custom settings with MSView™ PC software
- monitor the controller from a web browser
- modify controller settings from a web browser
- log and monitor the system with MSView™ PC software anywhere on the internet
- create custom web pages to show system data
- send an email or text message if a fault, alarm, or user-defined event occurs
- monitor and receive messages on an SNMP network

This section provides a summary of each of the features. For detailed information about Ethernet connectivity and networking, refer to the, “*Morningstar Communications Document*” at:

morningstarcorp.com/support

Network Information

Connect to the TriStar MPPT 150V via an Ethernet network (LAN/WAN) or connect the controller directly to a PC using an ethernet cross-over cable. Use CAT-5 or CAT-5e twisted pair Ethernet cables with RJ-45 connectors. A network diagram for both scenarios is shown in figure 5-3 below.

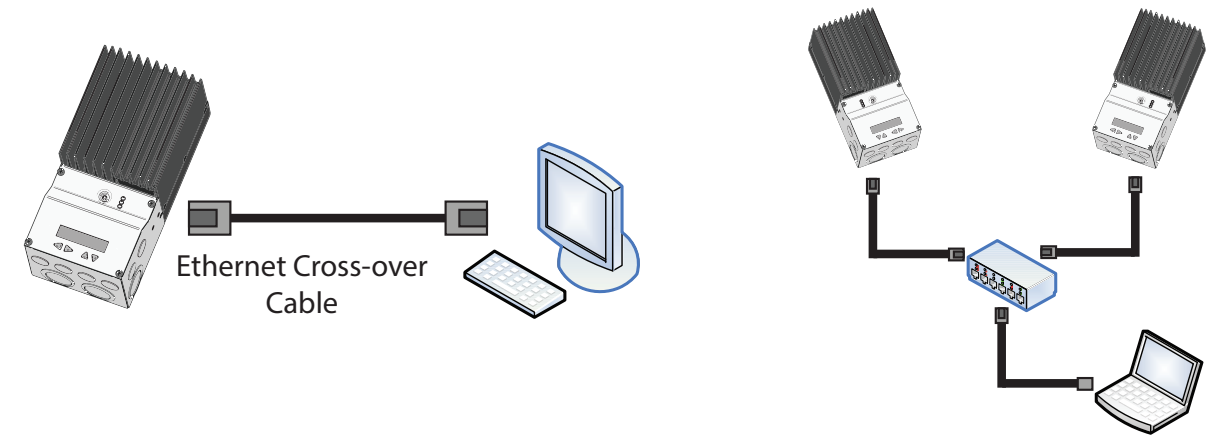

Figure 5-3. Ethernet network diagrams.

Factory Default Network Settings

DHCP	enabled
Live View Web Address	http://tsmppt + serial number **
IP	192.168.1.253 (if DHCP is not enabled)
Subnet Mask	255.255.255.0
Gateway	192.168.1.1
Primary DNS Server	169.254.1.1
MODBUS TCP/IP™ Port	502

** The Live View web address is unique to each controller. If the TriStar MPPT 150V serial number is 09501234, then the Live View address is: <http://tsmppt09501234>. The Live View address is printed on the serial label on the side of the unit for reference.

The controller's MAC Address is located on the serial label on the side of the controller. Two (2) LEDs on the Ethernet jack indicate link and activity status.

Condition	Green LED	Yellow LED
Network Connection OK	ON	OFF
Network Activity	ON	Blinking
Error	OFF	ON

Web Pages

Connect the TriStar MPPT 150V controller to the network using an Ethernet cable. Wait 5 to 10 minutes for the controller to connect to the network. Open a web browser on any PC on the network. Enter the Live View web address in the address bar of the web browser. The TriStar MPPT 150V main Live View webpage will load. Links are provided to real-time data, history, and network settings adjustment pages.

Pages served by the TriStar MPPT 150V are ideal for retrieving quick information about the charge controller and making adjustments to network settings. However, there is no ability to customize the layout or data displayed. Also, information from multiple controllers cannot be displayed on the same webpage.

Custom Settings

The *TriStar MPPT 150V Setup Wizard* in MSView™ provides an interface to adjust all operating parameters. Morningstar's MSView™ PC software can connect to any TriStar MPPT 150V on the Ethernet network or through a RS-232 serial connection. Refer to the help documentation included with MSView™ for more information.

E-mail & SMS Alerts (Text Messages)

The email and SMS alerts feature sends notification to an e-mail address or mobile phone if one of the following occurs:

- TriStar MPPT 150V self-diagnostics fault condition
- TriStar MPPT 150V self-diagnostics alarm condition
- User-defined event (e.g. battery voltage is less than 46 Volts)

Up to four e-mails, SMS alerts, or SNMP Traps (see section on next page) can be configured from the network settings web page in the MSView TriStar MPPT 150V Setup Wizard.

SMS alerts can be configured from MSView™. Proceed to enter the outgoing SMTP server address and username/password. NOTE: Most forms of webmail (Google, Yahoo, etc) are not supported as the outgoing SMTP server. This step will be the same as configuring an e-mail alert.

In the recipient's e-mail address field, you will need to enter the cell phone @ the cell phone carrier's SMS Gateway (i.e. 8885553333@vtext.com). Essentially you will be sending an e-mail to the recipient's cell phone provider. The provider will then translate the e-mail into SMS format and deliver it to the recipient's cell phone as a text message.

Contact the cell phone provider or perform an internet search (several web sites exist listing these SMS Gateways) to determine the proper gateway address.

View Logged Data

The TriStar MPPT 150V logs up to 200 days* of daily data. The controller always logs the standard values listed below. Using MSView, the controller can be configured to log additional optional values each day. The maximum number of days that can be stored decreases as the number of logged values increases.

Standard Values

- Minimum Battery Voltage
- Maximum Battery Voltage
- Daily Events (Equalize triggered, Entered Float, Alarm/Fault occurred, Controller Reset)
- Faults / Alarms - recorded only if a fault or alarm occurs that day

Optional Values

- Maximum Array Voltage
- Maximum Power Output
- Charge Amp-hours
- Charge Watt-hours
- Minimum/Maximum Battery Temperature
- Charge stage regulation timers for Absorption, Float, Equalize

* logging only standard values

SNMP Traps - ONLY WITH TS-MPPT-60, 60M, or using optional EMC-1 accessory



NOTE: The default IP port assignment for the SNMP Trap Receiver is 162

Asynchronous SNMP traps are configured, and behave, similarly to e-mail/SMS alerts. An SNMP trap receiver can be specified in MSView™. When a specified condition is met (alarm, fault, custom event), a trap is sent to the receiver, notifying it of the condition.

As with e-mail and SMS alerts, the Ethernet equipped controller may have traps triggered by conditions of other MODBUS™ enabled units on an EIA-485 network.

For telecom and industrial applications that **require** full SNMP monitoring of deployed systems, the TriStar MPPT 150V **WILL NOT** operate as an SNMP Agent supporting the commands below, **UNLESS**, a Morningstar **EMC-1 accessory is installed WITH the unit**. Complete SNMP (v2c) polling capabilities and implementation, available through the **required EMC-1 accessory**, are described in Section 8.5 of the Morningstar Communications Document (Product Connectivity Manual) and EMC-1 product manual located at:

morningstarcorp.com/support

NOTE: SNMP does not support the **SET** message, which allows a user to alter a setting on the device. This precaution helps to minimize the security and operational risks associated with the unverified user access. Morningstar's MSView PC software can be used to make changes to device settings, if desired.

GET

Method used by the SNMP manager to request information from a SNMP Agent on a specific OID.

GET NEXT

Method used by SNMP manager to work through an ordered list of OIDs according to the standard MIB hierarchy.

GET BULK

A sequence of GetNext requests, allowing a large segment of the MIB hierarchy to be queried by the SNMP manager from a managed device.

RESPONSE

Used by the SNMP Agent to deliver requested information. Also acts as an acknowledgment.

6.0 Troubleshooting



WARNING: RISK OF ELECTRICAL SHOCK.

NO POWER OR ACCESSORY TERMINALS ARE ELECTRICALLY ISOLATED FROM DC INPUT, AND MAY BE ENERGIZED WITH HAZARDOUS SOLAR VOLTAGE. UNDER CERTAIN FAULT CONDITIONS, BATTERY COULD BECOME OVER-CHARGED. TEST BETWEEN ALL TERMINALS AND GROUND BEFORE TOUCHING.



AVERTISSEMENT: RISQUE DE CHOC ÉLECTRIQUE.

NON ALIMENTATION OU AUX BORNES D'ACCESSOIRES SONT ISOLÉS ÉLECTRIQUEMENT DE L'ENTRÉE DE C.C ET DOIT ÊTRE ALIMENTÉS À UNE TENSION DANGEREUSE SOLAIRE. SOUS CERTAINES CONDITIONS DE DÉFAILLANCE, LA BATTERIE POURRAIT DEVENIR TROP CHARGÉE. TEST ENTRE TOUTES LES BORNES ET LA MASSE AVANT DE TOUCHER.



WARNING: Shock Hazard

A means of disconnecting all power supply poles must be provided. These disconnects must be incorporated in the fixed wiring. Open all power source disconnects before removing controller wiring cover, or accessing wiring.



AVERTISSEMENT: Risque de décharge électrique

Un moyen de déconnexion de tous les poteaux d'alimentation doit être fourni. Ceux-ci se déconnecte doit être intégrée dans le câblage fixe. Ouvrir que toutes les source d'énergie se déconnecte avant de retirer le couvercle de la contrôleur, ou accès au câblage.

Battery Charging and Performance Issues

Problem:

No LED indications, controller does not appear to be powered

Solution:

With a multi-meter, check the voltage at the battery terminals on the TriStar MPPT 150V. Battery voltage must be 8 Vdc or greater. If the voltage on the battery terminals of the controller is between 8 and 72 Vdc and no LEDs are lit, contact your authorized Morningstar dealer for service. If no voltage is measured, check wiring connections, fuses, and breakers.

Problem:

The TriStar MPPT 150V is not charging the battery.

Solution:

Check the three (3) battery SOC LEDs. If they are flashing a sequence, see *Section 4.4 Faults & Alarms* of this manual to determine the issue. If a TriStar Meter 2 is connected, the diagnostics menu will display reported faults and alarms.

If the LED indications are normal, check the fuses, breakers, and wiring connections in the solar array wiring. With a multi-meter, check the array voltage directly at the TriStar MPPT 150V solar input terminals. Input voltage must be greater than battery voltage before charging will begin.

Network and Communication Issues

Problem:

Cannot connect to the controller via RS-232

Solution:

Check the following:

- The RS-232 cable is straight-through, not a Null Modem (cross-over)
- If using a serial-USB adapter, verify that the adapter software is installed and a serial COM port has been mapped. Check the activity light on the USB adapter if it has one. If there is no activity, the wrong COM port has been chosen or there is a configuration issue with the adapter.
- The default MODBUS ID of the TriStar MPPT 150V is 1. Verify that the PC software is configured to communicate using the correct MODBUS ID.

Problem:

Cannot connect to the controller via EIA-485

Solution:

Check the following:

- The RS-232 port is not in use. The EIA-485 and RS-232 ports cannot be used simultaneously. Only one port can be used at a time.
- The RSC-1 adapter used to connect the PC to the EIA-485 network shows a green LED and pulses red when a connection is attempted. See the RSC-1 documentation for more information.
- Each controller or device on the EIA-485 network has been programmed with a unique MODBUS ID.
- A serial cross-over (Null Modem) cable is used for the connection between the PC and the Morningstar RSC-1 485 Adapter. A straight-through serial cable will not work.
- Power is supplied to the 4-wire bus on the Power/Ground lines. The bus requires voltage in the range: 8 - 16 Vdc.
- All bus connections are secure and each terminal is wired in parallel: line A to line A, line B to line B, etc.

Problem:

Cannot connect to the controller via Ethernet

Solution:

See the *Morningstar Communications Document* at:
morningstarcorp.com/support

7.0 Warranty and Claim Procedure

WARRANTY

LIMITED WARRANTY - Morningstar Solar Controllers and Inverters

All Morningstar *Professional Series™* products, except the SureSine™ inverter, are warranted to be free from defects in materials and workmanship for a period of FIVE (5) years from the date of shipment to the original end user. Warranty on replaced units, or field-replaced components, will be limited only to the duration of the original product coverage.

Morningstar *Essentials Series™*, and SureSine™ inverter, products are warranted to be free from defects in materials and workmanship for a period of TWO (2) years from the date of shipment to the original end user. Warranty on replaced units, or field-replaced components, will be limited only to the duration of the original product coverage.

Morningstar will, at its option, repair or replace any such defective units.

CLAIM PROCEDURE:

Before requesting warranty service, check the Operator's Manual to verify product failure. Return the defective product to your authorized Morningstar distributor with shipping charges prepaid. Provide proof of date and place of purchase.

An RMA number must be issued by Morningstar prior to return of any unit(s) under this warranty. RMA information must include product model, serial number, detailed failure description, panel type, array size-configuration, type of batteries and system load details. This information is critical to rapid disposition of your warranty claim.

Morningstar will pay the return shipping charges if the repairs are covered under the warranty.

WARRANTY EXCLUSIONS AND LIMITATIONS

This warranty does not apply under the following conditions:

- Damage by accident, negligence, abuse or improper use
- PV or load currents exceeding the ratings of the product
- Unauthorized product modification or attempted repair
- Damage occurring during shipment
- Damage results from acts of nature such as lightning and weather extremes

THE WARRANTY AND REMEDIES SET FORTH ABOVE ARE EXCLUSIVE AND IN LIEU OF ALL OTHERS, EXPRESS OR IMPLIED. MORNINGSTAR SPECIFICALLY DISCLAIMS ANY AND ALL IMPLIED WARRANTIES, INCLUDING, WITHOUT LIMITATION, WARRANTIES OF MERCHANTABILITY AND FITNESS FOR A PARTICULAR PURPOSE. No Morningstar distributor, agent or employee is authorized to make any modification or extension to this warranty.

MORNINGSTAR IS NOT RESPONSIBLE FOR INCIDENTAL OR CONSEQUENTIAL DAMAGES OF ANY KIND, INCLUDING BUT NOT LIMITED TO LOST PROFITS, DOWNTIME, GOODWILL OR DAMAGE TO EQUIPMENT OR PROPERTY.

WARRANTY CLAIM PROCEDURE

1. Before proceeding, please refer to product manual, including troubleshooting section.
2. Contacting your authorized Morningstar distributor or dealer from whom you purchased the unit is the first step in the warranty process. Local dealers can often address warranty issues quickly.
3. If supplier is unable to address the issue, please contact Morningstar by e-mail at support@morn-
ingstarcorp.com) with:
 - (A) purchase location -- business or company name
 - (B) full model and serial numbers (SN is 8-digits on unit bar label)
 - (C) failure behavior, including LED indications
 - (D) array configuration, panel Pmax, Voc, Vmp, Isc, and battery voltage; these specifications are needed to receive assistance.
 - (E) multi-meter available (for field troubleshooting)
4. After warranty replacement has been approved and new unit(s) received, please return failed unit(s) using pre-paid shipping label, and follow any product specific instructions if requested by Morningstar Warranty Dept.
5. If instructed by Morningstar, after warranty replacement shipment has been received, return of failed unit(s) is required before further warranty replacements can be considered for the original or future cases.

NOTE: Please do not return units without an RMA or case number. Doing so will increase the time required to resolve your claim.

8.0 Specifications

Electrical

	TS-MPPT-30	TS-MPPT-45	TS-MPPT-60/M
Nominal System Voltage		ALL: 12, 24 or 48 Volts dc	
Maximum Battery Current	30 Amps	45 Amps	60 Amps
Maximum Solar Input Voltage		ALL: 150 Volts dc	
Battery Operating Voltage Range		ALL: 8 - 72 Volts dc	
Nominal Maximum Input Power ¹			
12 Volt	400 Watts	600 Watts	800 Watts
24 Volt	800 Watts	1200 Watts	1600 Watts
48 Volt	1600 Watts	2400 Watts	3200 Watts
Voltage Accuracy		12 / 24 V: $\leq 0.1\% \pm 50$ mV 48 V: $\leq 0.1\% \pm 100$ mV	
Self consumption (tare loss)		ALL: 1.3 - 2.7 Watts	
Transient Surge Protection		ALL: 4500 Watts / port	

¹ These power levels refer to the maximum wattage each of the TS-MPPTs can process at a certain system voltage. Higher power arrays can be used without damaging a controller, but array cost-benefits will be reduced at power levels much beyond the nominal ratings.

Battery Charging

Charging algorithm	4 - stage
Charging stages	Bulk, Absorption, Float, Equalize
Temperature compensation coefficient	-5 mV / °C / cell (25 °C ref.)
Temperature compensation range	-30 °C to +80 °C
Temperature compensated set-points	Absorption, Float, Equalize, HVD
Charging Set-points:	

Settings Switches	Battery Type	Absorp. Stage	Float Stage	Equalize Stage	Absorp. Time	Equalize Time	Equalize Timeout	Equalize Interval
sw: 4-5-6		Volts	Volts	Volts	Minutes	Minutes	Minutes	Days
off-off-off	1 - Sealed ¹	14.00	13.70		150			
off-off-on	2 - Sealed ¹	14.15	13.70	14.40	150	60	120	28
off-on-off	3 - Sealed ¹	14.30	13.70	14.60	150	60	120	28
off-on-on	4 - AGM/Flooded	14.40	13.70	15.10	180	120	180	28
on-off-off	5 - Flooded	14.60	13.50	15.30	180	120	180	28
on-off-on	6 - Flooded	14.70	13.50	15.40	180	180	240	28
on-on-off	7 - L-16	15.40	13.40	16.00	180	180	240	14
on-on-on	8 - Custom	Custom	Custom	Custom	Custom	Custom	Custom	Custom

¹ "Sealed" battery type includes gel and AGM batteries.
See section 4.2 for more information



NOTE:

All charging voltage set-points listed are for 12 Volt systems.
Multiply 2X for 24 Volt systems, 4X for 48 Volt systems.

Battery Charging Status LEDs

LED Indication	Battery Charging Status
Green Flashing (fast) - 2.5 times per second	Equalize charging stage
Green Flashing - 1/2 sec on, 1/2 sec off	Absorption charging stage
Green Flashing (slow) - 1 sec on, 1 sec off	Float charging stage
Green	$13.3 \text{ Volts} \leq V_{\text{battery}}$
Green & Yellow	$13.0 \text{ Volts} \leq V_{\text{battery}} < 13.3 \text{ Volts}$
Yellow	$12.7 \text{ Volts} \leq V_{\text{battery}} < 13.0 \text{ Volts}$
Yellow & Red	$12.0 \text{ Volts} \leq V_{\text{battery}} < 12.7 \text{ Volts}$
Red	$V_{\text{battery}} < 12.0 \text{ Volts}$

Mechanical

Dimensions:

(H) 291 mm / 11.44"

(W) 130 mm / 5.12"

(D) 142 mm / 5.58"

Product Weight:

4.14 kg / 9 lbs 2 oz

Shipping Weight (2 pcs/carton)

11.6 kg / 25 lbs 9oz

Power terminals:

Minimum wire size:

2.5 mm² / 14 AWG

Maximum wire size:

35 mm² / 2 AWG

Recommended torque:

5.65 Nm / 50 in-lb

RTS / Sense terminals:

Minimum wire size

0.25 mm² / 24 AWG

Maximum wire size

1.0 mm² / 16 AWG

Recommended torque

0.40 Nm / 3.5 in-lb

Knockouts (trade sizes):

M20 & 1/2", 1", 1 - 1/4"

Mounting:

Vertical surface

Environmental

Operating Altitude

Below 2000 meters

Ambient Temperature Range

-40 °C to +45 °C

Storage Temperature

-55 °C to +85 °C

Humidity

100% N.C.

Enclosure

IP20

Type 1 (indoor & vented)

Protections

Solar high voltage disconnect

Solar high voltage reconnect

Battery high voltage disconnect

Battery high voltage reconnect

High temperature disconnect

High temperature reconnect

De-ratings

Battery Current vs. Array Voltage

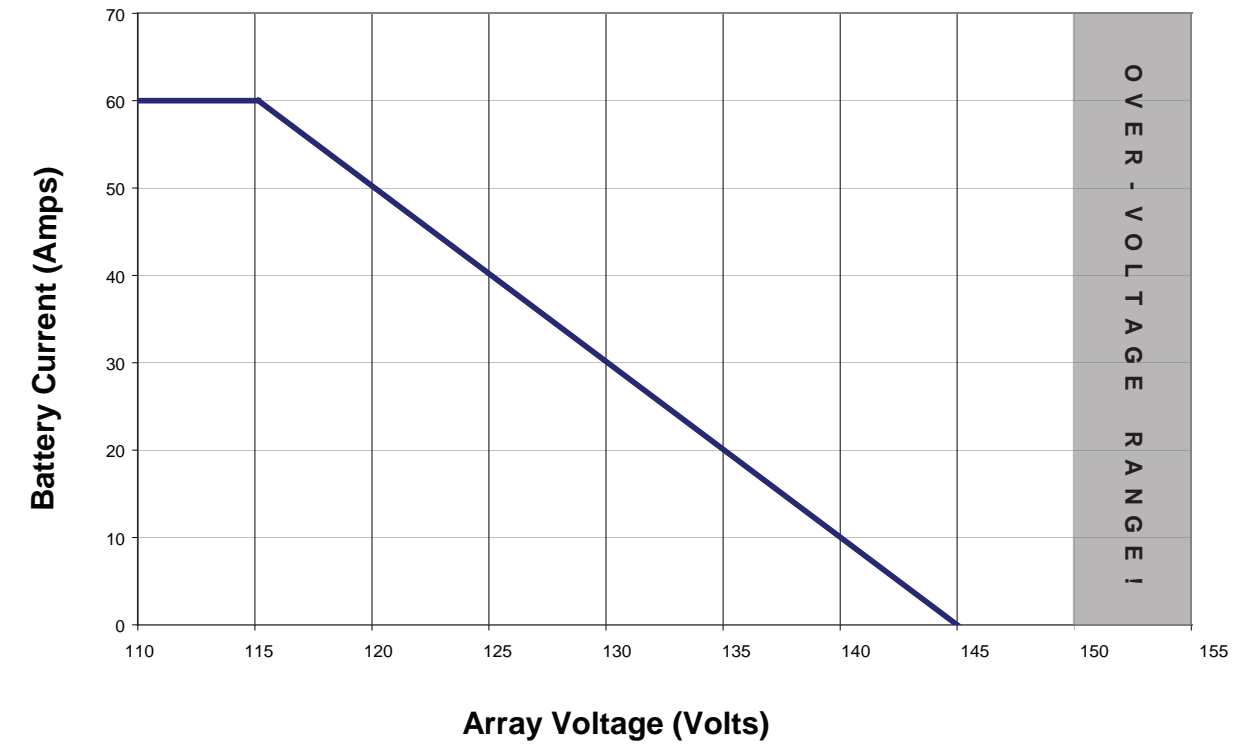

Battery Current vs. Heatsink Temperature

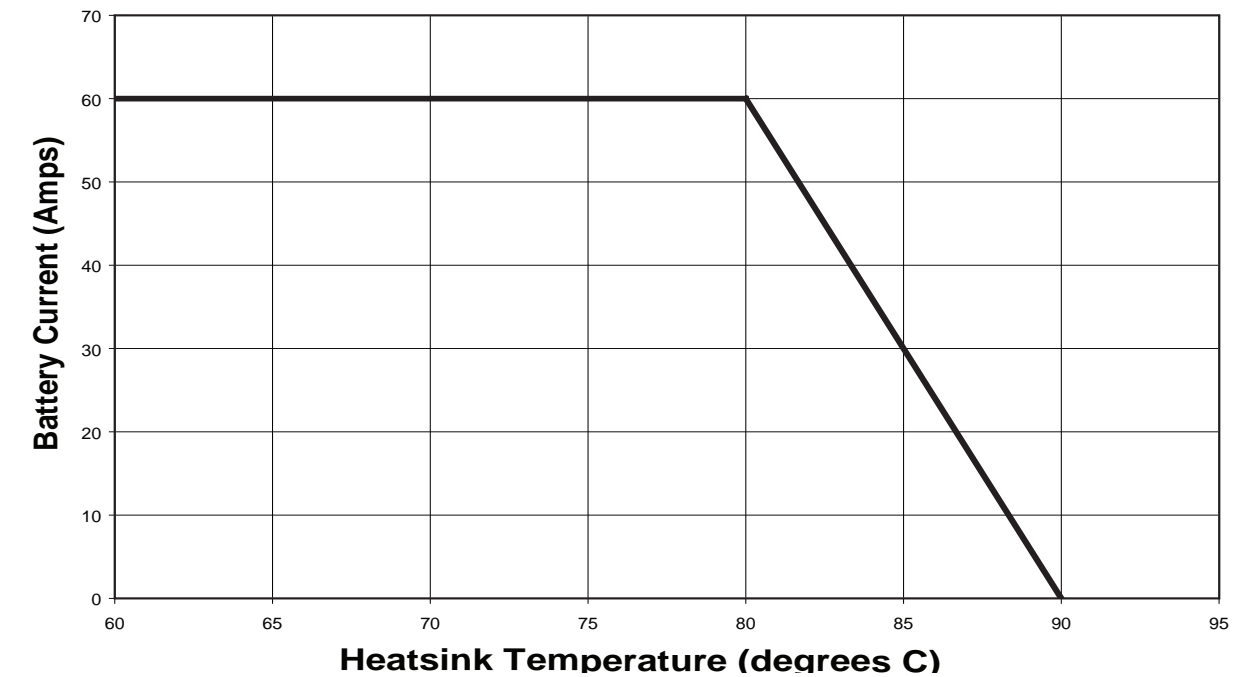

Efficiency

TriStar MPPT 12 Volt Efficiency

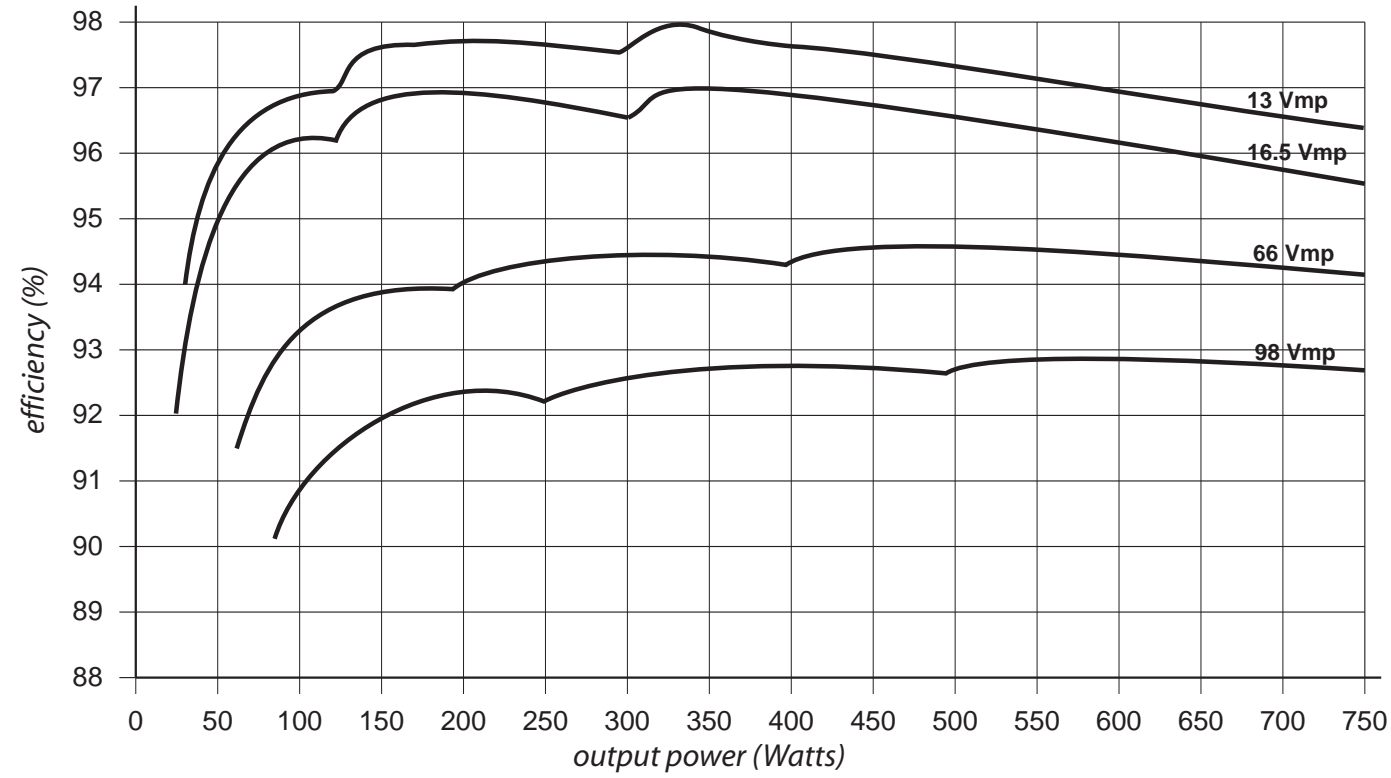

Battery @ 12.8 V, 25 C ambient, firmware ver. 08 or later

TriStar MPPT 24 Volt Efficiency

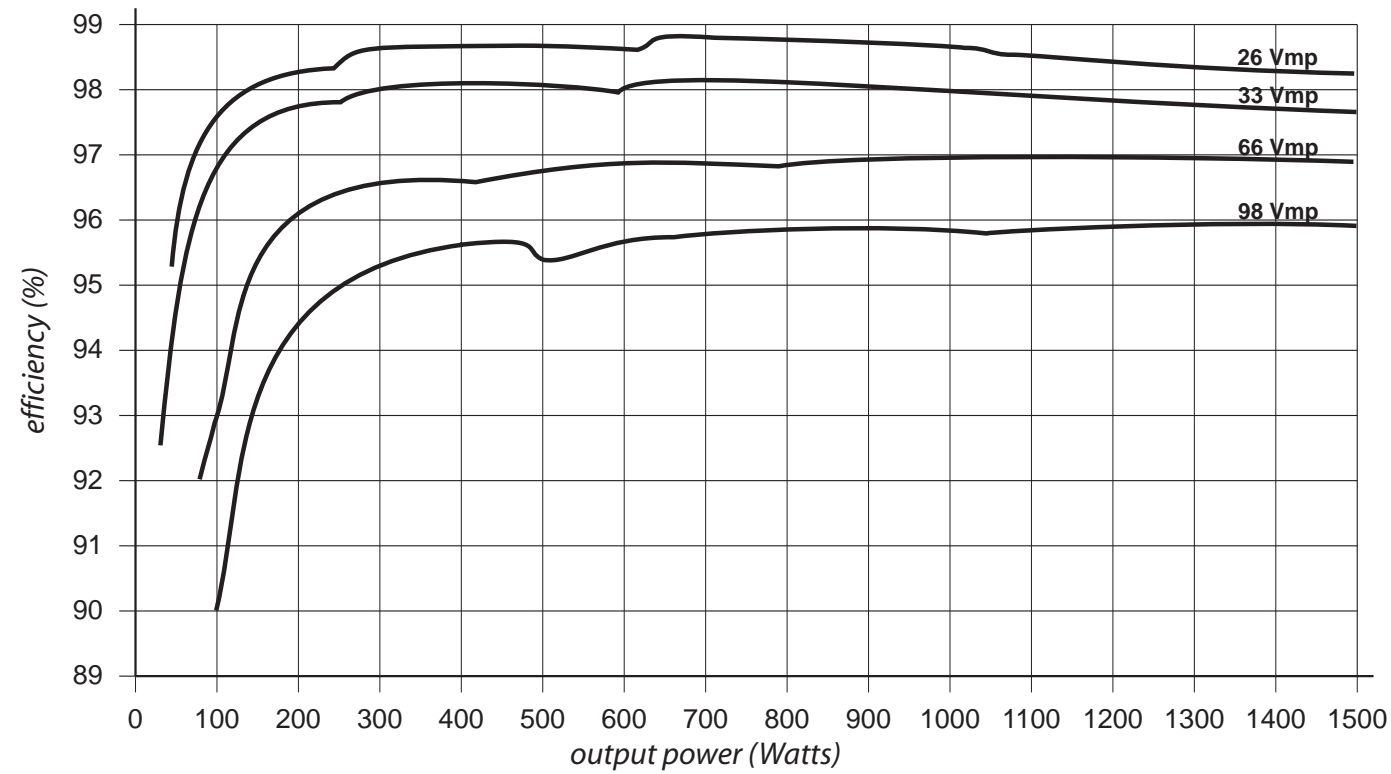

Battery @ 25.6 V, 25 C ambient, firmware ver. 08 or later

TriStar MPPT 48 Volt Efficiency

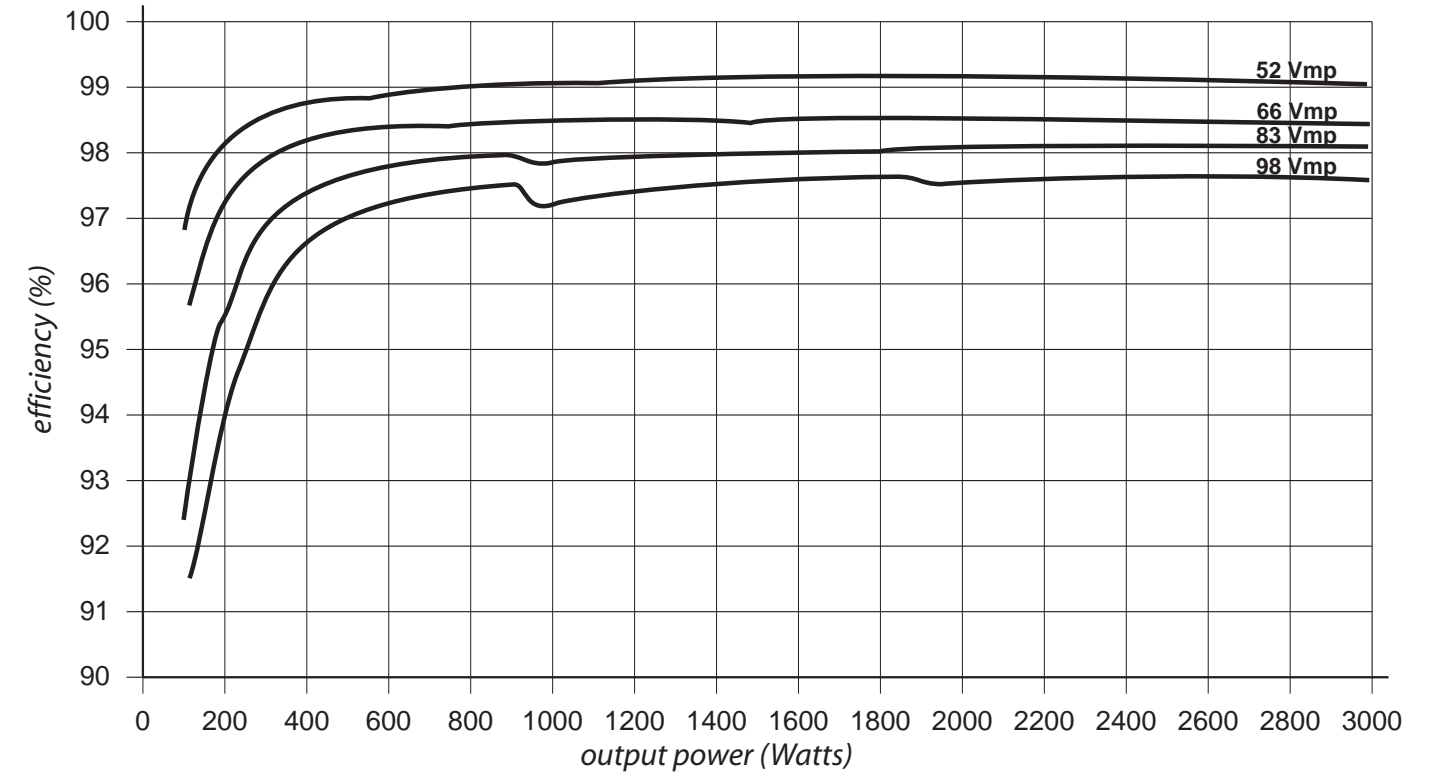

Battery @ 51.2 V, 25 C ambient, firmware ver. 08 or later

APPENDIX A - Wire Sizing

Minimum Wire Sizing

Wire sizing requirements are based on the ampacity (or current carrying capacity) of conductors. The NEC includes Ampacity Tables which are used to determine the ampacity for a given wire size as indicated in Section 310.15.

TriStar MPPT power terminals are rated for 75°C. When wires with a 90°C temperature rating are used with terminals that have a 75°C temperature rating, wire ampacity at 75°C must be used.

Wire ampacity requirements for the battery and PV array circuits are as follows:

Controller battery wire ampacity must be greater than or equal to 125% of maximum continuous current (battery current rating of the controller)

PV array wire ampacity must meet both of the following requirements:

Must be greater than or equal to 156% of PV Array I_{sc} without correction and adjustment factors
 Must be greater than or equal to 125% of PV Array I_{sc} with correction and adjustment factors

Correction and adjustment factors may also be required to account for the following:

- maximum ambient temperature
- temperatures at different parts of the circuit (rooftops or engine rooms for example)
- wire terminal temperature ratings
- multi conductor cables
- conduit fill and other factors

Minimum Battery Wire Sizes - 75°C or 90°C Rated Stranded Copper

MODEL	Wire Size in a raceway, cable, or earth ¹		Wire Size in free air ²		Metric Wire Size ³ (mm ²)
	@30°C	30°-45°C	@30°C	30°-45°C	
TS-MPPT-30	#8 AWG	#8 AWG	#10 AWG	#10 AWG	6 - 10
TS-MPPT-45	#6 AWG	#4 AWG > 40°C	#8 AWG	#8 AWG	10 - 18
TS-MPPT-60/M	#4 AWG	#3 AWG > 40°C	#6 AWG	#6 AWG	16 - 25

¹ Per NEC 2021 [see NEC Table 310.15(b)(16)], ampacity for not more than three current-carrying conductors in a raceway, cable, or earth (buried)

² Per NEC 2021 [see NEC Table 310.15(b)(17)], ampacity for conductors in free air

³ Estimated. See local code requirements for metric cable sizing

Table A-1. Minimum Battery Stranded Wire Sizes for 75°C or 90°C Rated Copper

Celsius to Fahrenheit Conversions

°Celsius	°Fahrenheit
30	86
35	95
40	104
45	113

Table A-2. Celsius to Fahrenheit Conversions

TriStar MPPT Voltage Drop Tables

Good system design generally requires large conductor wires that limit voltage drop losses to 2% or less. The tables below provide wire sizing for a maximum of 2% voltage drop. Longer distance wire runs may require significantly larger wire sizes to reduce the voltage drop to an acceptable level.

2% Voltage Drop Chart for 75°C or 90°C Stranded Copper Wire (Feet), 12 Volt System

Maximum 1-way Distance (feet), 12 Volt System - multiply values by (2) for 24 Volt and by (4) for 48V, System.

Wire Size (AWG)	60A	55A	50A	45A	40A	35A	30A	25A	20A	15A
4/0 ¹	39.2	42.8	47.0	52.3	58.8	67.2	78.4	94.1	117.6	156.8
3/0 ¹	31.1	33.9	37.3	41.5	46.7	53.3	62.2	74.7	93.3	124.5
2/0 ¹	24.6	26.9	29.6	32.9	37.0	42.3	49.3	59.2	73.9	98.6
1/0	19.5	21.3	23.4	26.0	29.3	33.5	39.1	46.9	58.6	78.1
#1	15.5	16.9	18.6	20.6	23.2	26.5	31.0	37.1	46.4	61.9
#2	12.3	13.4	14.7	16.4	18.4	21.1	24.6	29.5	36.9	49.1
#3	9.7	10.6	11.7	13.0	14.6	16.7	19.5	23.3	29.2	38.9
#4	7.7	8.4	9.3	10.3	11.6	13.3	15.5	18.6	23.2	31.0
#6	4.9	5.3	5.8	6.5	7.3	8.3	9.7	11.6	14.6	19.4
#8	3.1	3.3	3.7	4.1	4.6	5.3	6.1	7.4	9.2	12.3
#10					2.9	3.3	3.8	4.6	5.8	7.7
#12								2.9	3.6	4.8
#14									2.3	3.0

¹Wires sizes larger than #2 AWG (35 mm²) must be terminated at a splicer block located external to the TriStar MPPT. Use #2 AWG (35 mm²) or smaller wire to connect to the TriStar MPPT to a splicer block.

Table A-3. Maximum 1-way wire distance for 12 Volt systems, stranded copper, 2% voltage drop

2% Voltage Drop Chart for 75°C or 90°C Stranded Copper Wire (meters), 12 Volt System

Maximum 1-way Distance (meters), 12 Volt System - multiply values by (2) for 24 Volt and by (4) for 48V, System.

Wire Size (mm ²)	60A	55A	50A	45A	40A	35A	30A	25A	20A	15A
120 ¹	12.7	13.9	15.3	17.0	19.1	21.8	25.5	30.6	38.2	51.0
95 ¹	10.1	11.0	12.1	13.5	15.2	17.4	20.2	24.3	30.4	40.5
70 ¹	7.3	8.0	8.8	9.8	11.0	12.6	14.7	17.6	22.0	29.4
50	5.1	5.5	6.1	6.8	7.6	8.7	10.2	12.2	15.3	20.3
35	3.8	4.1	4.5	5.0	5.6	6.4	7.5	9.0	11.3	15.0
25	2.7	3.0	3.3	3.6	4.1	4.6	5.4	6.5	8.1	10.8
16	1.7	1.9	2.1	2.3	2.6	2.9	3.4	4.1	5.2	6.9
10			1.3	1.4	1.6	1.8	2.2	2.6	3.2	4.3
6							1.3	1.5	1.9	2.6
4								1.0	1.3	1.7
2.5									0.8	1.1

¹Wires sizes larger than 35 mm² must be terminated at a splicer block located external to the TriStar MPPT. Use 35 mm² or smaller wire to connect to the TriStar MPPT to a splicer block.

Table A-4. Maximum 1-way wire distance for 12 Volt systems, stranded copper, 2% voltage drop

Certifications



**THIS PAGE IS LEFT
BLANK INTENTIONALLY**



FOR CURRENT DETAILED CERTIFICATION LISTINGS, REFER TO:

<https://www.morningstarcorp.com/support/library>

Under, "Type", choose, "Declaration of Conformity (DOC)", to view a list of product DOCs.

TrisStar MPPT™, MeterBus™ are trademarks of Morningstar Corporation

MODBUS™ and MODBUS TCP/IP™ are trademarks of Modbus IDA.

© 2022 Morningstar Corporation. All rights reserved.



DYNAGENTM

TOUGH SeriesTM
TG350

User Manual



CONNECT. CONTROL. PROTECT.

Revision History

VERSION	DATE	NOTES
1.3	06/2014	Updated to include Rev 1.5 of the system wiring diagram. Changed AC Voltage sensing to 600 VAC; added note to say do not exceed 600 VAC. Changed V to VDC in several places.
2.0	12/2015	Updated to include Rev 3.0 of the typical wiring diagram. Updated DynaGen logo. Updated Specs.
3.0	10/2018	Updated with new drawing version R2.0. Updated switched outputs in Specs. Updated power in Specs. Changed cut-out drawing to one used in TE inserts (with cutouts for RP100).
7.0	09/2019	
A	09/2022	Document rebranded and contact information updated. Added French Translations for all DANGER/WARNING/CAUTION statements per UL Requirements.

Any information furnished by Cattron™ and its agents is believed to be accurate and reliable. All specifications are subject to change without notice. Responsibility for the use and application of Cattron products rests with the end user since Cattron and its agents cannot be aware of all potential uses. Cattron makes no warranties as to non-infringement nor as to the fitness, merchantability, or sustainability of any Cattron products for any specific or general uses. Cattron Holdings, Inc., or any of its affiliates or agents shall not be liable for incidental or consequential damages of any kind. All Cattron products are sold pursuant to the Terms and Conditions of Sale, a copy of which will be furnished upon request. When used as a tradename herein, Cattron means Cattron Holdings, Inc. or one or more subsidiaries of Cattron Holdings, Inc. Cattron™, corresponding logos, and other marks are trademarks or registered trademarks of Cattron Holdings, Inc. Other marks may be the property of third parties. Nothing herein provides a license under any Cattron or any third party intellectual property right.



Contents

1	Introduction	5
1.1	Specifications	6
2	Installation	9
2.1	General Wiring Notes	10
2.2	Terminal Descriptions	11
2.3	Wiring Harness.....	13
2.4	Typical Wiring Diagram	14
2.5	Typical Wiring Diagram with RelayPak	15
2.6	Wiring Considerations	16
2.6.1	Remote Start Contact (Start/Stop)	16
2.6.2	Emergency Stop Wiring	16
2.6.3	Universal Sensor	17
2.6.4	CANbus Wiring.....	18
2.6.5	RelayPak (Optional).....	19
3	Using the Controller.....	22
3.1	Modes, Starting and Stopping.....	23
3.1.1	Cranking Behavior	24
3.2	Using Cooldown Mode	24
3.3	Warnings	25
3.4	Failures	26
3.5	Events History	27
4	Settings.....	34
4.1	Operator Setup.....	34
4.2	Switched Inputs.....	35
4.2.1	Configurable Inputs	38
4.3	Switched Outputs	39
4.3.1	Group Outputs.....	43
4.3.2	Pull and Hold Coil.....	44
4.4	Sensors	44
4.4.1	Engine Temperature	45
4.4.2	Oil Pressure	47
4.4.3	Fuel Level.....	48



4.4.4	Engine Speed.....	49
4.4.5	Battery	54
4.4.6	Auxiliary Sensors	56
4.4.7	Custom Sender Tables	67
4.5	Timers	68
4.5.1	Engine Logic	68
4.5.2	Schedulers	75
4.5.3	Maintenance.....	77
4.6	AC Monitor	78
4.6.1	Generator Voltage.....	78
4.6.2	Generator Frequency.....	81
4.7	Communications	82
4.7.1	CANbus (J1939).....	82
4.8	Other Config.....	83
4.8.1	Password	83
4.8.2	Settings Name.....	84
4.8.3	Process Control.....	84
5	Troubleshooting.....	87
6	Technical Support.....	88



1 Introduction

The TOUGH Series controllers are designed to provide complete control, protection, AC metering, and engine instrumentation for both standard and electronic engines. The module is easily configured using either the front panel buttons or our RapidCore Configurator software. TOUGH Series controllers are ideally suited for severe duty applications where reliability is critical, such as mobile and stationary generators.



 Tier 4 Ready



Features and Functions:

- Five-Year Warranty
- SAE J1939 CANbus Protocol
- RPM via J1939, Magnetic Pickup or Generator
- Speed control offset for electronic engines
- AutoStart on low battery and other sensors
- Trim feature for AC monitoring and sensors
- Maintenance counter
- Exerciser Clock
- 150 Event Log
- Conformally coated for protection against moisture
- Gasket for water ingress protection resistance
- Free RapidCore Configurator Software
- Fast and rugged installation clips
- Passcode protected
- Automatic shutdowns and warnings
- Manual and Remote start
- Momentary Start/Stop inputs
- Pre-heat and many other configurable timers
- Accepts common senders (VDO, Datcon, S&W)
- Custom senders configurable with RapidCore Configurator Software



Displays:

- Engine Temperature
- Oil Pressure
- Fuel Level
- Engine Speed
- AC Metering
- Battery Voltage
- Real Time Clock
- Engine Hours
- Time to Maintenance
- J1939 DTCs + Custom Text
- Custom Senders
- Warnings and Failures

Feature	Included
J1939 CANbus	✓
Magnetic Pickup Input	✓
150 Event Log	✓
Clock / Exerciser	✓
Generator Metering	Single or 3-Phase
Configurable Switched Inputs (+Battery, Ground, Open)	5
Resistive Sensors (1 High Ohm, 2 Low Ohm)	3
Universal Sensor (Resistive, 0-5V, 4-20mA)	1
Configurable Switched Outputs	6

1.1 Specifications

The TOUGH Series controllers were rigorously tested to ensure durability, reliability and functionality. The following specifications are a brief summary of the standards to which the controller has been tested. For complete details on the testing performed, please contact Cattron at www.cattron.com.

Testing Specifications

Specification	Rating
Electrical Transients	SAE1113-11



Specification	Rating
Thermal Shock and Cycling	SAE1455
Vibration Profiles	SAE1455
Electric Static Discharge	SAE1113-13: +/-8 kV Direct Discharge +/-15 kV Air Gap Discharge
UL	 UL 6200 recognized component. Contact Cattron at www.cattron.com for UL conditions of acceptability.

Physical Specifications

Specification	Rating
Operating Temperature	-40 to +158 °F (-40 to +70 °C)
LCD Viewing Temperature	-4 to +158 °F (-20 to +70 °C) (Optional heater available, contact Cattron at www.cattron.com)
Weight	0.83 lb (0.38 kg)
Weight w/RelayPak	1.32 lb (0.60 kg)
Dimensions:	
- controller (no gasket)	4.17" x 6.50" x 1.38" (10.59 cm x 16.51 cm x 3.51 cm)
- controller with gasket	4.41" x 6.79" x 1.38" (11.20 cm x 17.25 cm x 3.51 cm)
- controller with gasket and RelayPak	4.41" x 6.79" x 3.33" (11.20 cm x 17.25 cm x 8.46 cm)

Electrical Specifications

Specification	Rating
Operating Voltage	5.5 ~ 36 VDC
Standby Current (Minimum)	Auto Mode: 60 mA @ 12 VDC, 38 mA @ 24 VDC (back lighting off) Off Mode: 80 mA @ 12 VDC, 45 mA @ 24 VDC (back lighting off) Actual consumption could be more depending on connected sensors and other I/O.
Switched Inputs	+Battery, Ground, Open, Closed
Switched Outputs	+Battery @ 1 A Max
Low Resistance Sensors	0 ~ 750 Ω
High Resistance Sensors	0 ~ 7,500 Ω
Universal Sensors	0 ~ 750 Ω, 0 ~ 7,500 Ω, 0 ~ 5 VDC, 4 ~ 20 mA
Magnetic Pickup	10 ~ 10,000 Hz at 1 ~ 50 VAC



Specification	Rating
AC Voltage (Line-To-Line)	UL Approved Range: 50 ~ 600 VAC True RMS, Accuracy: 2% Full Scale Non-UL Range: 50 ~ 670 VAC Do not connect more than 600 VAC to the controller for UL approved installations, or 700 VAC for locations where UL is not required.
Communications	SAE J1939 (Tier II, III, IV)
External Sensor Power	TG410 only: 5 VDC at a max load of 200 mA





2 Installation

Generator systems contain high voltage circuitry, and precautions should be taken to protect against electrical shock. Failing to power down and lock out equipment can cause damage, injury or death.

	WARNING
	WIRING OF THIS CONTROLLER SHOULD BE PERFORMED BY QUALIFIED ELECTRICIANS ONLY.

	AVERTISSEMENT
	LE CÂBLAGE DE CE CONTRÔLEUR NE DOIT ÊTRE EFFECTUÉ QUE PAR DES ÉLECTRICIENS QUALIFIÉS.

	CAUTION
	HIGH VOLTAGE MAY BE PRESENT AT THE CONTROLLER.

	ATTENTION
	UNE HAUTE TENSION PEUT ETRE PRESENTE AU NIVEAU DU CONTROLEUR.

The following general electrical safety precautions should be followed:

- Do a thorough inspection of the area before performing any maintenance
- Keep fluids away from electrical equipment
- Unplug connectors by pulling on the plug and not on the cord
- Use fuses where appropriate
- Ensure all equipment is properly grounded
- Provide support to wires to prevent stress on terminals

	CAUTION
	TO ENSURE PROPER AND SAFE OPERATION, CAUTION MUST BE TAKEN AT THE INSTALLATION SITE TO MAKE SURE IT IS FREE FROM EXCESSIVE MOISTURE, FLUCTUATING TEMPERATURE, DUST AND CORROSIVE MATERIALS.

	ATTENTION
	POUR GARANTIR UN FONCTIONNEMENT CORRECT ET SUR, IL FAUT PRENDRE DES PRECAUTIONS SUR LE SITE D'INSTALLATION POUR S'ASSURER QU'IL SOIT EXEMPT D'HUMIDITE EXCESSIVE, DE FLUCTUATIONS DE TEMPERATURE, DE POUSSIERE, ET DE MATERIAUX CORROSIFS.



Choose a mounting surface with the least amount of vibration and not more than 0.125" (3.175 mm) thick.

The following steps outline the mounting procedure:

1. Choose a suitable mounting location based on the criteria above.
2. Create a rectangular cut-out in the panel that is a minimum 3.9" (99 mm) high and 6.2" (158 mm) wide.
3. Place the controller into the panel cut-out so that the LCD screen and buttons are facing out.
4. Place the mounting clips into the designated slots on the top and bottom of the controller.
5. Tighten the screws on the clips until the controller is snug against the panel. Do not over-tighten. The bottom of the screws should angle very slightly away from the controller.
6. If applicable, snap the RelayPak (RP100) to the back of the controller. Place one side of the RP100's tabs into the slot on the back of the controller and, without pushing on the relays, snap the other tab into place.

The following figures show the TE Series cut-out dimensions and an image of the controller.

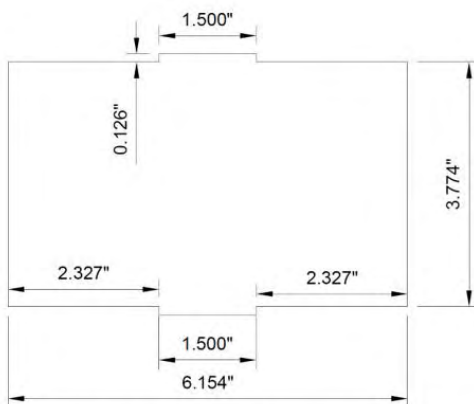

TE Series Cutout (Not To Scale)



2.1 General Wiring Notes

The following important wiring guidelines should be followed:

- Use a minimum of 18 AWG wire for all connections
- Battery Positive (+Battery) and Battery Negative connections on the controller should be run directly to the positive and negative terminals on the battery to prevent voltage drops from negatively impacting the controller
- Limit the wire length to 20 ft (6.1 m) to any I/O on the controller (e.g., Switched Input, Switched Outputs, AC Sensing and Analog Inputs)

The TOUGH Series contains a TVS to protect the I/O and internals from a transient on the main battery (the battery from which the controller is powered). If you have I/O connected to other batteries or power supplies, those I/O must contain their own voltage transient protection. Otherwise, the I/O and/or controller can be damaged if the transient exceeds the maximum rated voltage of the I/O. A device that provides this kind of protection is known as a TVS or a varistor.



- The switched outputs already contain a kickback diode. Do not connect relays with an internal kickback diode to a switched output as the output may be shorted. This includes relays in the RelayPak
- Fusing:
 - A fuse should be placed in line with the battery positive wire going to the controller power; a 10 A fuse is suggested
 - The AC Voltage A, B and C lines should be fused near the source of AC voltage with a 1 A fuse to protect personnel if any of these lines becomes disconnected or damaged
 - If using the RelayPak, the power going to the relay commons should be fused
- For noisy environments, some guidelines are as follows:
 - Replace speed sensing wires with twisted pair from the sensor to the controller
 - Consider using isolated sensors (i.e., two terminal) and use twisted pair wiring to connect from the engine to the controller

When possible, the following enclosure guidelines should be followed:

- It is recommended that vibration mounts be used
- For outdoor applications, it is recommended that a sealed enclosure be used

2.2 Terminal Descriptions

Main Connector (J4)

Terminal	Name	Description
J4-1	+Battery	Provides power to the controller from the battery
J4-2	+Battery	Provides power to the controller from the battery
J4-3	Ground	Provides ground return for the controller
J4-4	Ground	Provides ground return for the controller
J4-5	Switched Input A	Configurable to detect +Battery, Ground, or Open
J4-6	Switched Input B	Configurable to detect +Battery, Ground, or Open
J4-7	Switched Input C	Configurable to detect +Battery, Ground, or Open
J4-8	Switched Output A	Outputs +Battery voltage when active (Max Current: 1 A)
J4-9	Switched Output C	Outputs +Battery voltage when active (Max Current: 1 A)
J4-10	Switched Output B	Outputs +Battery voltage when active (Max Current: 1 A)
J4-11	Sensor Ground	Provides ground return for 2-wire (isolated) sensors
J4-12	Sensor Input A	High impedance sensor input (0-7,500 Ω)
J4-13	Sensor Input B	Low impedance sensor input (0-750 Ω)
J4-14	Sensor Input C	Low impedance sensor input (0-750 Ω)



Expansion Connector (J3)

Terminal	Name	Description
J3-1	Switched Input D	Configurable to detect +Battery, Ground, or Open
J3-2	Switched Input E	Configurable to detect +Battery, Ground, or Open
J3-3	Switched Output D	Outputs +Battery voltage when active (Max Current: 1 A)
J3-4	Switched Output E	Outputs +Battery voltage when active (Max Current: 1 A)
J3-5	Switched Output F	Outputs +Battery voltage when active (Max Current: 1 A)
J3-6	No Connection	No Connection
J3-7	Sensor Ground	Provides ground return for 2-wire sensors
J3-8	Sensor Input D	Universal sensor input (0-750 Ω, 0-7,500 Ω, 0-5 VDC, 4-20 mA). See the Universal Sensor section for more information.

Communications Connector (J6)

Terminal	Name	Description
J6-1	No Connection	No Connection
J6-2	No Connection	No Connection
J6-3	No Connection	No Connection
J6-4	CAN-H	Communications line for CANbus (J1939)
J6-5	CAN-L	
J6-6	CAN-Shield	Connect the shield of the twisted pair cable to this terminal.
J6-7	Speed Sensing A	Connect to a magnetic pickup, tachometer, or a flywheel alternator. Not polarity sensitive and not required if using AC voltage terminals for speed sensing.
J6-8	Speed Sensing B	Connect to a magnetic pickup, tachometer, or a flywheel alternator. Not polarity sensitive and not required if using AC voltage terminals for speed sensing.
J6-9	No Connection	No Connection
J6-10	No Connection	No Connection

Generator AC Voltage (J5)

Terminal	Name	Description
J5-1	Phase A	Connect to Phase A of the generator
J5-2	Phase B	Connect to Phase B of the generator
J5-3	Phase C	Connect to Phase C of the generator
J5-4	Neutral	Connect to neutral of the generator



2.3 Wiring Harness

DWG1478 - TG350 Mag Pickup and J1939 Harness

Terminal	Color	Wire Text	Description
J6-1			Not Populated
J6-2			Not Populated
J6-3			Not Populated
J6-4	White	CAN/HIGH	CAN/J1939 High
J6-5	White	CAN/LOW	CAN/J1939 Low
J6-6	White	CAN/GND	CAN/J1939 Shield
J6-7	Green	SPEED INPUT	Speed Input
J6-8	Green	SPEED REF	Speed Reference
J6-9			Not Populated
J6-10			Not Populated

DWG1522 - TG410 Mag Pickup and Comm. Harness

Terminal	Color	Wire Text	Description
J6-1	Blue	RS485 A	Modbus A (+)
J6-2	Blue	RS485 B	Modbus B (-)
J6-3			Not Populated
J6-4	Black	CAN HIGH	CAN/J1939 High
J6-5	Black	CAN LOW	CAN/J1939 Low
J6-6	Black	CAN GND	CAN/J1939 Shield
J6-7	Green	SPEED INPUT	Speed Input
J6-8	Green	SPEED REF	Speed Reference
J6-9			Not Populated
J6-10	Blue	RS485 GND	RS485 Common

DWG1475 - With RelayPak

Terminal	Color	Wire Text	Description
J4-1	Red	BATT POS	Battery Positive
J4-2			Not Populated
J4-3	Black	BATT NEG	Battery Negative
J4-4	Black	BATT NEG	RelayPak Coil -
J4-5	Tan	SW IN A	Switched Input A
J4-6	Tan	SW IN B	Switched Input B
J4-7	Tan	SW IN C	Switched Input C
J4-8	Purple	SW OUT A	RelayPak relay A
J4-9	Purple	SW OUT C	RelayPak relay C
J4-10	Purple	SW OUT B	RelayPak relay B
J4-11	Brown	SEN GND	Sensor Ground
J4-12	Brown	SEN IN A	Sensor Input A
J4-13	Brown	SEN IN B	Sensor Input B
J4-14	Brown	SEN IN C	Sensor Input C

DWG1476 - Without RelayPak

Terminal	Color	Wire Text	Description
J4-1	Red	BATT POS	Battery Positive
J4-2	Black	BATT NEG	Battery Negative
J4-3			Not Populated
J4-4			Not Populated
J4-5	Tan	SW IN A	Switched Input A
J4-6	Tan	SW IN B	Switched Input B
J4-7	Tan	SW IN C	Switched Input C
J4-8	Purple	SW OUT A	Switched Output A
J4-9	Purple	SW OUT C	Switched Output C
J4-10	Purple	SW OUT B	Switched Output B
J4-11	Brown	SEN GND	Sensor Ground
J4-12	Brown	SEN IN A	Sensor Input A
J4-13	Brown	SEN IN B	Sensor Input B
J4-14	Brown	SEN IN C	Sensor Input C

Mating Plugs

Terminal	Manufacturer	Housing P/N	Crimps P/N
J3	Molex	39-01-2080	39-00-0039
J4	Molex	39-01-2140	39-00-0039
J5/J7 - AC Voltage	Tyco	1-480702-0	38038-1
J5 - AC Current	Tyco	1-480702-0	380218-1
J6	Molex	39-01-2100	39-00-0039
RelayPak J1	Molex	39-01-2080	39-00-0039

Notes:
(1) Harnesses are 5 feet in length except for the three DWG1522 RS485 wires which are 6 inches in length.

DWG1477 - Advanced IO Harness

Terminal	Color	Wire Text	Description
J3-1	Tan	SW IN D	Switched Input D
J3-2	Tan	SW IN E	Switched Input E
J3-3	Purple	SW OUT D	Switched Output D
J3-4	Purple	SW OUT E	Switched Output E
J3-5	Purple	SW OUT F	Switched Output F
J3-6			Not Populated
J3-7	Brown	SEN GND	Sensor Ground
J3-8	Brown	SEN IN D	Sensor Input D

Terminal J3-3 is left unpopulated from the factory and can be populated using one of the two individual wires that came with the harness (a short one with two crimps on both sides and a long one with a crimp on one side and a pigtail on the other). If using relay D on the RelayPak insert one end of the short wire into J3-3 and the other end into RelayPak J1-1. If you are not using the relay pack insert the longer wire into J3-3.

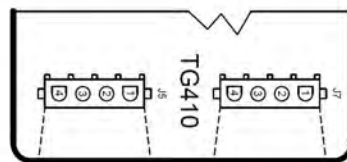

DWG1518 - AC Current Sensing Harness

Terminal	Color	Wire Text	Description
J5-1	Red	PHASE A	Gen. Current (A)
J5-2	Red	PHASE B	Gen. Current (B)
J5-3	Red	PHASE C	Gen. Current (C)
J5-4	Red	CT COMMON	CT Common

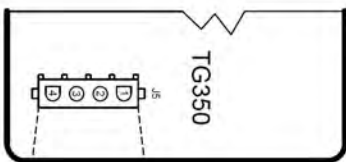

DWG1479 - AC Voltage Sensing Harness

Terminal	Color	Wire Text	Description
J5-1	Orange	PHASE A	Generator Voltage
J5-2	Orange	PHASE B	
J5-3	Orange	PHASE C	
J5-4	Orange	NEUTRAL	

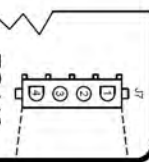

DWG1479 - AC Voltage Sensing Harness

Terminal	Color	Wire Text	Description
J7-1	Orange	PHASE A	Generator Voltage
J7-2	Orange	PHASE B	
J7-3	Orange	PHASE C	
J7-4	Orange	NEUTRAL	

Tough Series Harness Guide
DWG-1547R2.0



2.4 Typical Wiring Diagram

- Speed Sensing:**
- (1) Input is to be used for a magnetic pickup (MPU) sensor, alternator, or tach output.
 - (2) Not required if using AC. Voltage for speed sensing.
 - (3) The polarity of the inputs does not matter.
 - (4) Use twisted pair shielded cable. Leave one side of shield unterminated.
 - (5) If using a MPU:
 - (a) A shielded MPU is recommended.
 - (b) One side of the ring pickup also has to be connected to ground in addition to the controller.
- CAN (TG350TG410 and RS485 TG410):**
- (1) A 120 Ohm impedance twisted pair cable is required.
 - (2) Examples are Belden 9841 (single twisted pair) and Belden 7895A (two twisted pair).
 - (3) RS485 requires an extra wire or twisted pair in the cable for RS485 common.
 - (4) The controller is to be connected to the CAN bus through operations using the shielded cable within at least 6 inches of the terminal. Closer to 3 inches is better.
 - (5) Terminate the bus on each end with a 120Ohm resistor.
- AC Current (CT's):** If current readings are unstable try connecting the CT Common's to ground. Ensure the connecting wire is as short as possible.
- Sensors:** For hand/wire revisions below 2.0, if using non-isolated (one-wire) sensors connect sensor common to battery negative. Make connection at the same point the main ground connection is made.
- Switched Inputs:** For runs longer than 20 feet or in noisy environments place a relay in circuit close to controller to prevent false triggering due to noise. See the auto-start example in this drawing.
- Switched Outputs:** Relay drivers. When using to trigger logic a 2.2kOhm, 1W resistor is required to be installed from output to ground to ensure the output goes to 0 VDC in off state.

Main Connector	
J4-1	Battery
J4-2	Battery
J4-3	Ground
J4-4	Ground
J4-5	Switch Input A
J4-6	Switch Input B
J4-7	Switch Input C
J4-8	Switch Output A
J4-9	Switch Output C
J4-10	Switch Output B
J4-11	Sensor Ground
J4-12	Sensor Input A
J4-13	Sensor Input B
J4-14	Sensor Input C

Expansion Connector	
J3-1	Switch Input D
J3-2	Switch Input E
J3-3	Switch Output D
J3-4	Switch Output E
J3-5	Switch Output F
J3-6	Sensor Ground
J3-7	Sensor Input D
J3-8	Sensor Input D

Communication Connector	
J6-1	Reserved
J6-2	Reserved
J6-3	CAN High
J6-4	CAN Low
J6-5	CAN Ground
J6-6	CAN Ground
J6-7	Speed Input
J6-8	Speed Reference
J6-9	Reserved
J6-10	Reserved

Generator Connector (V)	
J5-1	Gen. Phase A
J5-2	Gen. Phase B
J5-3	Gen. Phase C
J5-4	Neutral

TG350 Example

DWG-1551-1R2.0

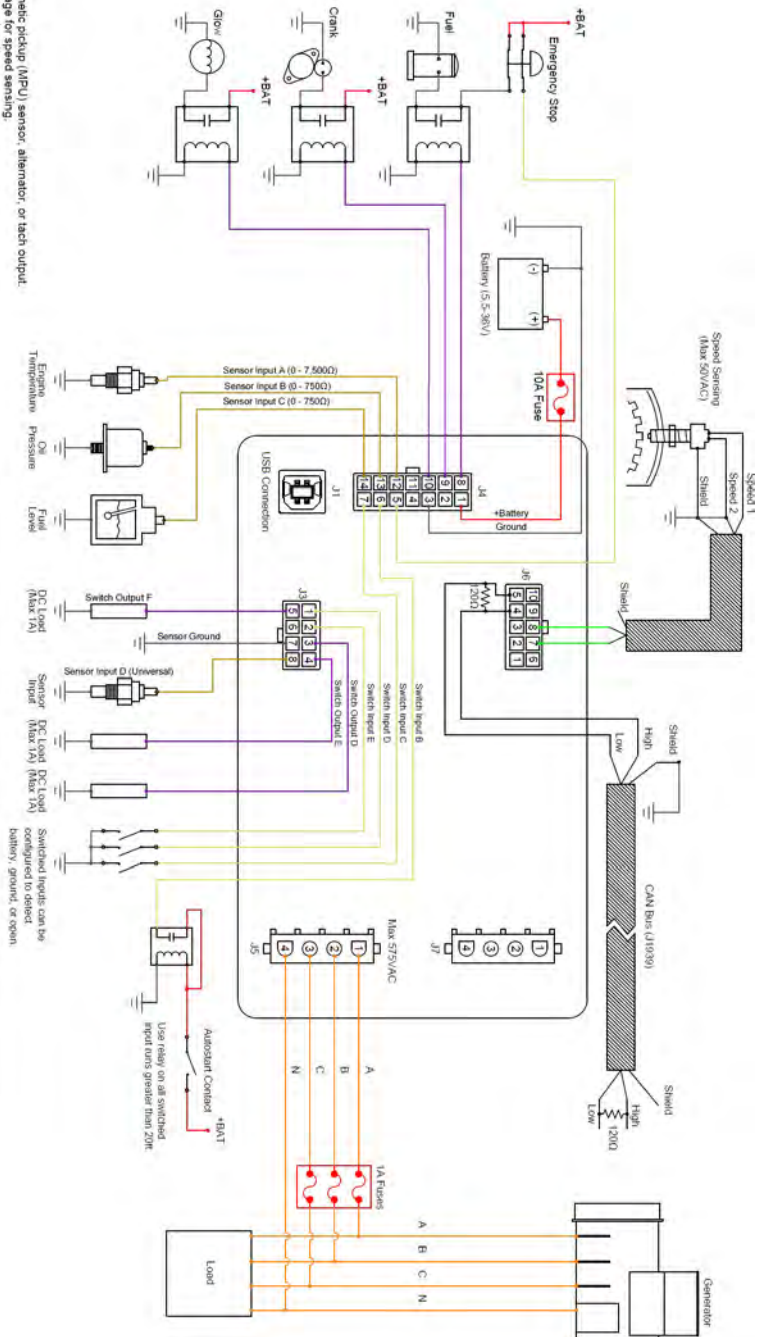

2.5 Typical Wiring Diagram with RelayPak

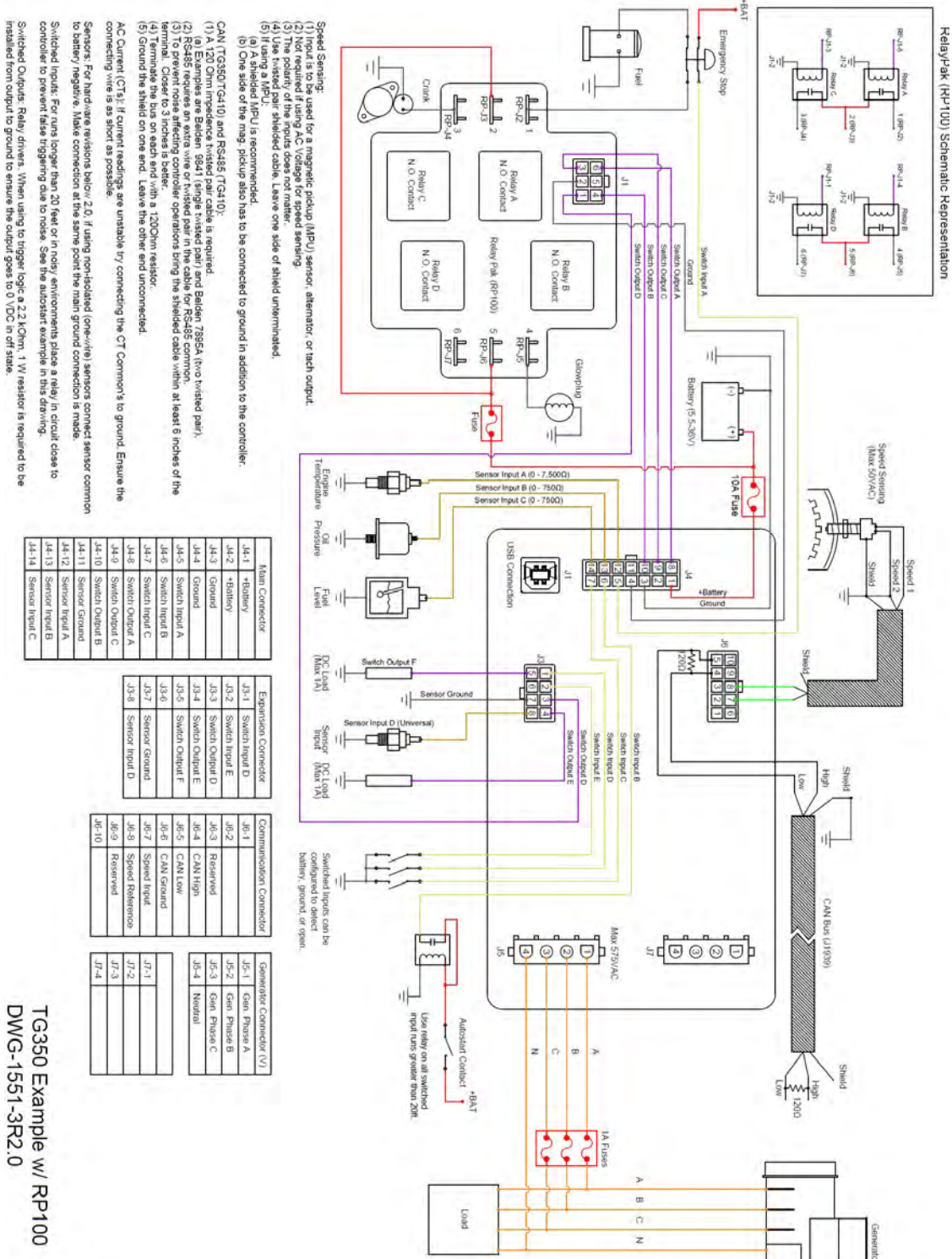

TG350 Example w/ RP100
DWG-1551-3R2.0



2.6 Wiring Considerations

The following sections are meant to describe certain wiring configurations and are for illustrative purposes only. Not all applications are the same. Please ensure that you modify these examples to fit your unique system requirements.

2.6.1 Remote Start Contact (Start/Stop)

As of firmware version 1.60, the Start/Stop is factory defaulted to switch input B (changeable) and the trigger is factory defaulted to Close +BAT. For older firmware versions, you must set Start/Stop to Switched Input B or as desired and set the trigger mode to Close +BAT. The trigger can be set to any of four options but Close +BAT gives the best immunity to noise.

For runs over 20 ft (6.1 m), especially in noisy environments, Cattron recommends connecting the Start/Stop to an external relay. The relay needs to be located as close to the controller as possible.

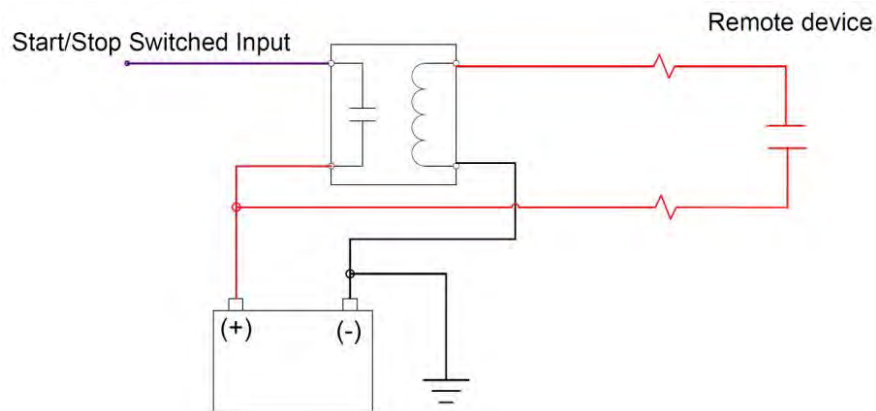

2.6.2 Emergency Stop Wiring

If Emergency Stop functionality is required, it must be an external mushroom-style switch wired in series with the fuel or ignition supply to ensure reliable and immediate shutdown upon activation.

The following figure shows is an example wiring diagram of a double pole, single throw switch being used to activate the e-stop input and cut power to the fuel solenoid. In this configuration, the e-stop is activated when there is an open circuit to the switched input, and it is inactive when the input detects battery positive voltage.

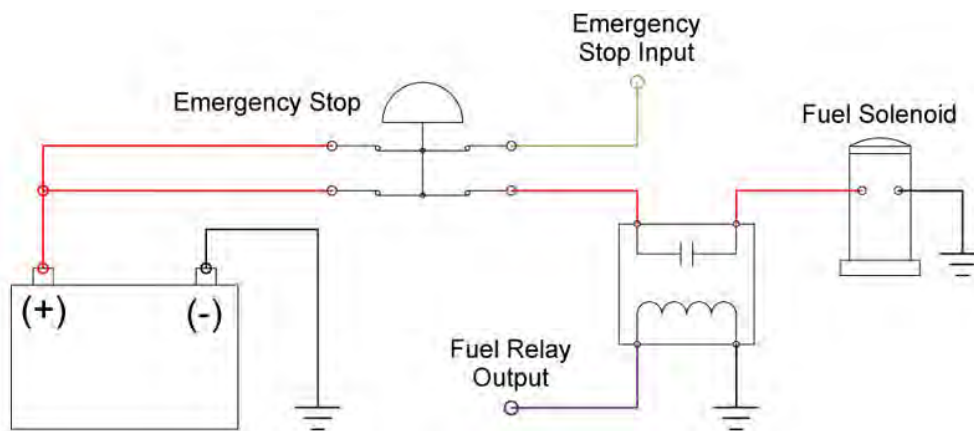

2.6.3 Universal Sensor

Universal Sensors have the ability to be configured to detect different sender types (0-750 Ω, 0-7,500 Ω, 0-5 VDC, 4-20 mA). The examples shown below are advanced applications of the universal sensor.

	<p>CAUTION</p> <p>CUSTOM SENDER TABLES ARE REQUIRED FOR THE UNIVERSAL SENSOR TO WORK WITH THESE EXAMPLES. SEE THE CUSTOM SENDER TABLES SECTION FOR MORE INFORMATION.</p>
---	---

	<p>ATTENTION</p> <p>LES TABLEAUX CUSTOM SENDER (EMETTEUR PERSONNALISE) SONT NECESSAIRES POUR QUE L'EMETTEUR UNIVERSEL FONCTIONNE AVEC CES EXEMPLES. VOIR LA SECTION CUSTOM SENDER TABLES (TABLEAUX DE CAPTEURS PERSONNALISES) POUR PLUS D'INFORMATIONS.</p>
---	--

Example #1: The following example shows the correct way to wire a 4-20 mA sensor. The 240 Ω resistor is required to transform the 4-20 mA current into the 0-5 V voltage range required by the controller.

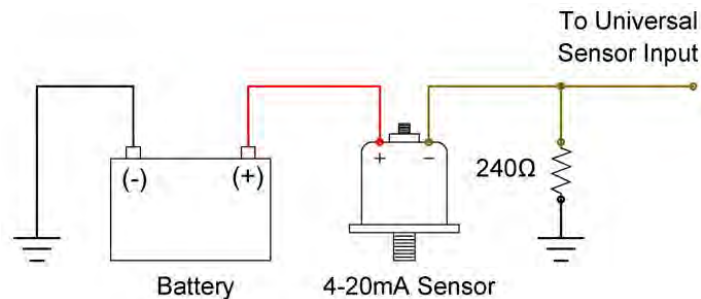

4-20 mA Wiring Example

Example #2: Sometimes it is required to measure voltages outside the 0-5 V range allowed by the controller. To do this you must use a voltage divider with appropriate scaling resistors. The equation to calculate the resistor values is as follows:

$$V_{OUT} = (R1 / (R1 + R2)) \times V_{IN}$$

Where: $V_{OUT} = 5 \text{ V}$

V_{IN} = Maximum Voltage to Read

$R1$ = Common Resistor Value > 10 kΩ

$R2$ = Calculated Resistor Value (select closest common resistor value)

The following diagram shows the typical wiring of a voltage divider. The resistors' values have been selected to allow the controller to read up to 36 V from an external battery bank.



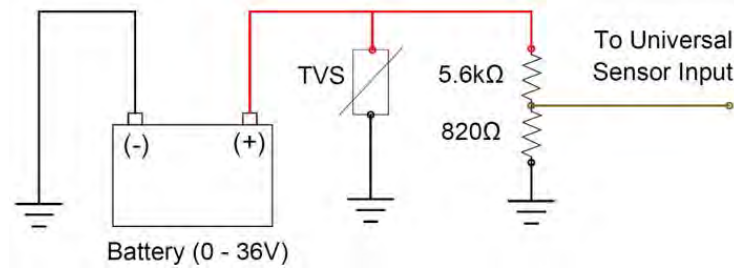

0-36 V Wiring Example

	CAUTION
A TVS (I.E., VARISTOR) IS REQUIRED IF THE BATTERY IS DIFFERENT THAN THE BATTERY FROM WHICH THE CONTROLLER IS POWERED. THE CONTROLLER'S TVS CANNOT PROTECT THE SENSOR INPUT FROM TRANSIENTS IN THIS CASE.	

	ATTENTION
UN TVS (VARISTANCE) EST NECESSAIRE SI LA BATTERIE EST DIFFERENTE DE CELLE QUI ALIMENTE LE CONTROLEUR. DANS CE CAS, LE TVS DU CONTROLEUR NE PEUT PAS PROTEGER L'ENTREE CAPTEUR CONTRE LES TRANSITOIRES.	

2.6.4 CANbus Wiring

The following table outlines some items that must be taken into consideration when connecting to a CANbus engine.

Consideration	Description
Bus Termination	Each end of the bus must be terminated from CAN H to CAN L with 120 Ω +/- 10 Ω resistors. The resistor must be able to handle at least 400 mW of power dissipation.
Cable Selection	A twisted pair 120 Ω impedance cable is required for communications. For better protection, a shielded twisted pair cable is recommended. Examples include the following: <ul style="list-style-type: none"> • Belden 9841 - Shielded cable with one twisted pair, 24 AWG • Belden 7895A - Shielded cable with two twisted pair, 20 AWG For short runs of 5 ft or less, regular 18 AWG wiring can often be run.
Shielding	If using a shielded cable, the shield must be connected to ground on one end of the bus only. This prevents loss of data from electromagnetic interference.
Termination at the Controller	The twisted pair cable must terminate no farther than six inches from the controller's CAN (J1939) connector. Three inches is ideal.



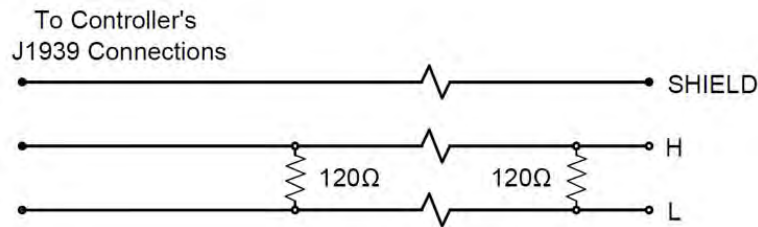

Communications Wiring

It is common practice to use the fuel output to trigger the ECM key input to enable the ECM before cranking. For some ECMs to function, they must be powered/enabled for a certain period before cranking to allow time for the ECM to boot up. There are two ways to provide this time:

- Set a preheat time or increase the preheat time to allow a longer time for the ECM to boot up before cranking; the fuel output turns on at the start of preheat
- Enable the Auto Power ECM setting in the Communications > CANbus (J1939) menu, which will cause the fuel output to turn on in Auto Mode and stay on

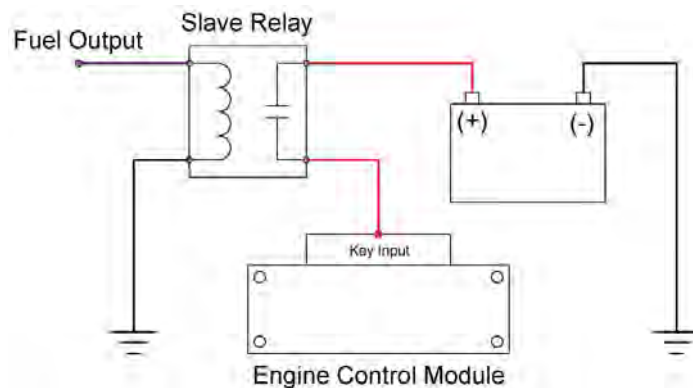

ECM Wiring

2.6.5 RelayPak (Optional)

Model Number: RP100

The RelayPak is used to provide up to four built-in slave relays in a compact and easy to wire package. This allows the low current outputs of the controller to switch on high current relays on the RelayPak.

Note: The RelayPak can be used to sense DC voltages up to 39 VDC using one of the Auxiliary Sensor Inputs on the controller. The VM in RP100-VM refers to this voltage sensing capability. Refer to drawing DWG1552 at www.cattron.com. If this capability is used, the fourth relay, Relay D, cannot be used.



Electrical Specifications

Specification	Rating
Operating Voltage	12 V / 24 V
Output Pilot Duty Rating	5.83 A Per Relay @ 12 V
Output Resistive Rating	10 A Continuous Per Relay @ 12 V 40 A Momentary Per Relay @ 12 V
Relay Style	Automotive Cube
Standards	 UL 6200 recognized component. Contact Cattron at www.cattron.com for UL conditions of acceptability.



WARNING
YOU MUST USE RELAYS IN THE RELAYPAK THAT ARE SUITABLE FOR THE SYSTEM VOLTAGE; FOR EXAMPLE, 12 V RELAYS IN A 12 V SYSTEM AND 24 V RELAYS IN A 24 V SYSTEM.



AVERTISSEMENT
VOUS DEVEZ UTILISER DES RELAIS ADAPTES A LA TENSION DU SYSTEME DANS LE RELAYPAK. PAR EXEMPLE, DES RELAIS 12 V POUR UN SYSTEME 12 V, ET DES RELAIS 24 V POUR UN SYSTEME 24 V.

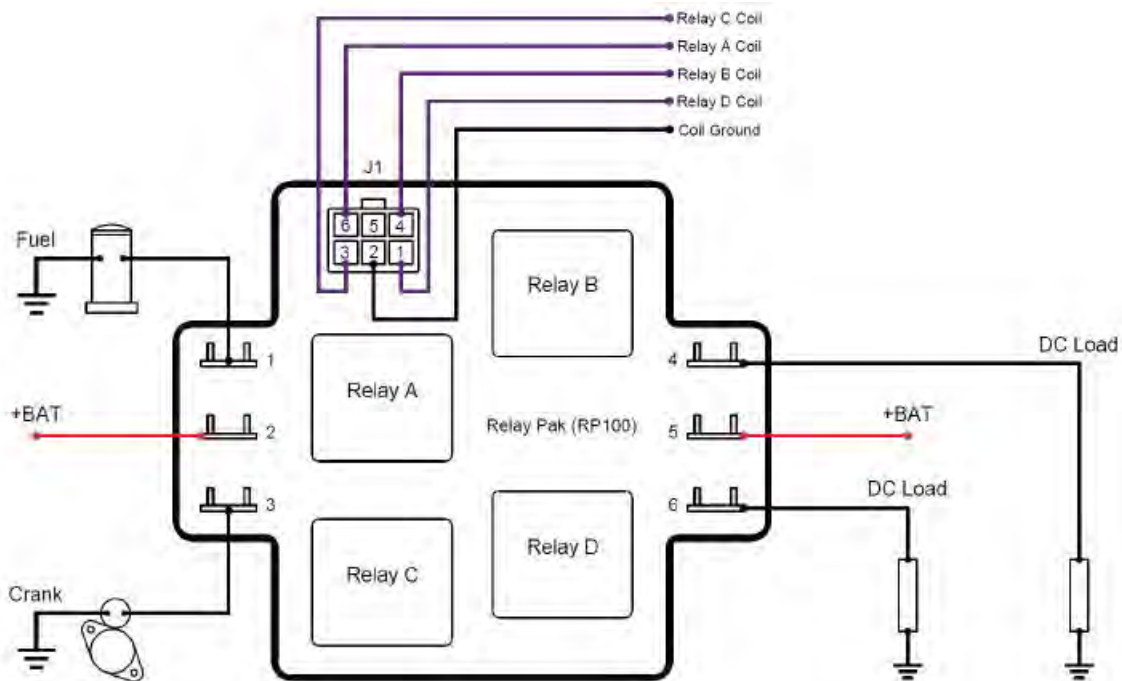

Schematic Representation

Relay Pak Connector	
J1-1	Relay D Coil
J1-2	Coil Ground
J1-3	Relay C Coil
J1-4	Relay B Coil
J1-5	
J1-6	Relay A Coil
1	Relay A Contact
2	A and C Common
3	Relay C Contact
4	Relay B Contact
5	B and D Common
6	Relay D Contact

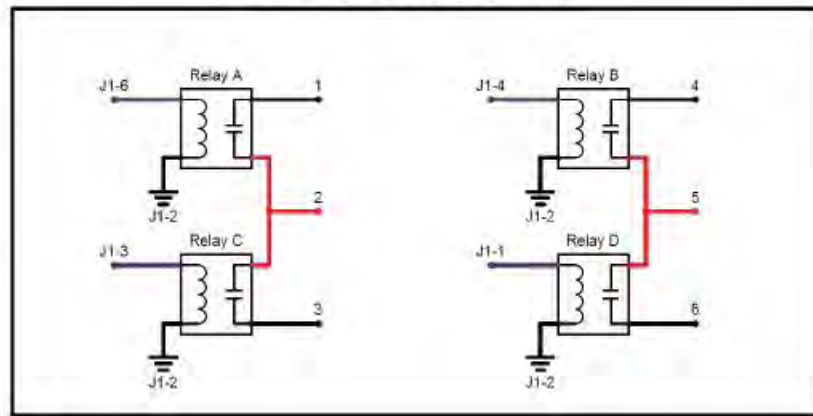

3 Using the Controller

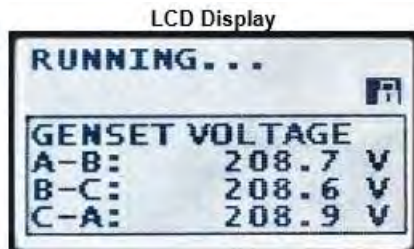

The LCD display is the primary source of information from the controller. It allows you to view/change settings and monitor the status of sensors and other engine peripherals.







Using the Menu System

Task	Description
Entering Menu	When in the Off Mode, press the Enter button to bring up the menu.
Navigating Menu	Once in the menu, use the up and down arrows to navigate. Pressing Enter will move you into that menu.
Change a Setting	Scroll to the desired value and press Enter to select. A check mark should appear beside that item. Press Enter again to save the setting and return to the previous screen.
Scroll Parameters	When in Auto or Running Mode, pressing the up and down arrows will scroll through the parameter pages.
Lock Screen	When in Auto or Running Mode, the screen can be locked to a certain parameter page by pressing Enter and unlocked by pressing Enter again.
Events History	Once in the menu, select Events History to view the most recent controller event. Use the up and down arrows to navigate to other events. The controller can store up to 150 events. If more than 150 events occur, the oldest event is deleted to make room for the next event.

Front Panel Items

Item	Name	Description
	OFF Button	Used for turning off the engine or exiting out of Auto Mode. This is not intended to function as an Emergency Stop as there are conditions in which it will not shut down the engine. See the OFF Button Function section for more information.
	AUTO Button	Used for placing the controller into Auto Mode. Once in Auto Mode, the controller waits for a start command to be received.
	RUN Button	Used to start the engine manually. The OFF button must be used to shut down the engine if it has been started using the front panel.



Item	Name	Description
	Up Button	Used for moving around in the menu, changing a setting's value, or changing the currently displayed parameter page.
	Enter Button	Used for entering the menu system, accepting settings, or locking the LCD screen when viewing parameters.
	Down Button	Used for moving around in the menu, changing a setting's value, or changing the currently displayed parameter page.
	Generator/Engine LED	Green = Engine running with no issues Amber = Engine running with warnings Red = Engine shut down on failure

3.1 Modes, Starting and Stopping

The following table describes the operating modes of the controller.

Mode/State	Description
Off	When in the Off Mode, the engine cannot be remotely started.
Auto	When in the Auto Mode, the engine waits to receive a start command.
Running	When engine is Running, the controller monitors engine parameters and waits to receive a stop command.
Failure	When a Failure occurs, the controller shuts down the engine and displays the reason for failure. The unit must be reset using the front panel OFF button, with the exception of Modbus.
Menu	When in the Menu Mode, settings can be changed, and the Events History may be viewed.

The following table describes the different methods for starting a controller. Unless you are using the Manual Run method to start the controller, the controller must be in Auto Mode.

Starting Methods

Methods	Description
Manual Run	Pressing the RUN button will start the engine. You must press the OFF button to shut down the engine.
Start / Stop Switched Input	When this input is active, the engine will start. When the input becomes inactive, the engine will shut down.
Momentary Switched Inputs	Switched inputs Momentary Start and Momentary Stop can be used for starting and stopping of the engine. Unlike other inputs, they only have to be activated for a short period of time.
Battery Recharge	When the battery voltage drops below a certain level, the engine will start and run for a predetermined amount of time.



Methods	Description
Exerciser	When the scheduled exerciser interval occurs, the engine will start and run for a predetermined amount of time.
Week Scheduler	When a scheduled event occurs, the engine will start and run for the programmed amount of time.
Auxiliary Sensors	When a properly configured Auxiliary sensor falls below / rises above a certain point, the engine will start as determined by the Auxiliary Sensors > Mode Select settings.
J1939 Start	Start/stop command sent over the J1939 CANbus; for example, from the TR100 or a remote telemetry device. The controller will display either “J1939 Run” or “J1939 Remote” as the reason for starting.
ECM Power On	<p>This is not a starting mode like the others. In Auto Mode, if the AUTO button is held for 3 seconds, the fuel output is turned on for 1 hour. “ECM Power On” will be displayed on the screen.</p> <p>Pressing and holding the AUTO button again within the hour will refresh for another hour. This feature can be used to turn on or activate equipment powered by the fuel output. Often this is used by a tech to power the ECM on an electronic engine so that a diagnostic tool can obtain information from the ECM.</p>

	WARNING
	SEE THE USING COOLDOWN SECTION FOR MORE INFORMATION ON HOW IT AFFECTS STARTING AND STOPPING.

	AVERTISSEMENT
	VOIR LA SECTION USING COOLDOWN (UTILISATION DU MODE REFROIDISSEMENT) POUR PLUS D'INFORMATIONS SUR LA FAÇON DONT CELA PEUT AFFECTER LE DÉMARRAGE ET L'ARRÊT.

3.1.1 Cranking Behavior

Crank disconnect is only monitored at the beginning of cranking. If the engine is already running, the starter motor (output set to Crank) may turn on briefly.

If the controller is programmed to use CAN J1939 or a magnetic pickup (sensor or alternator output), the controller will also monitor the AC Voltage Phase A line for frequency as a backup or secondary means of crank disconnect. This occurs even if AC Voltage sensing is disabled in the settings.

The oil pressure is not used as a means of crank disconnect.

3.2 Using Cooldown Mode

When the controller is configured to have a cooldown period (see the [Engine Logic](#) section) for the engine, there is some special functionality that must be considered.



The cooldown period is special in that during this time, it will accept a Start command. This means if the engine is cooling down and a start command is received, the controller will be placed back into a Running Mode and will not shut down.

The following is an example of how the cooldown functionality works; this process is also shown in the following figure.

1. Remote Start contacts close.
2. Engine starts and is in Running Mode.
3. Remote Start contacts open.
4. Engine starts cooldown period.
5. User presses RUN button on the front panel.
6. Engine moves back into Running Mode and does not shut down.
7. Engine can now only be shut down by using the OFF button or Emergency Stop input.

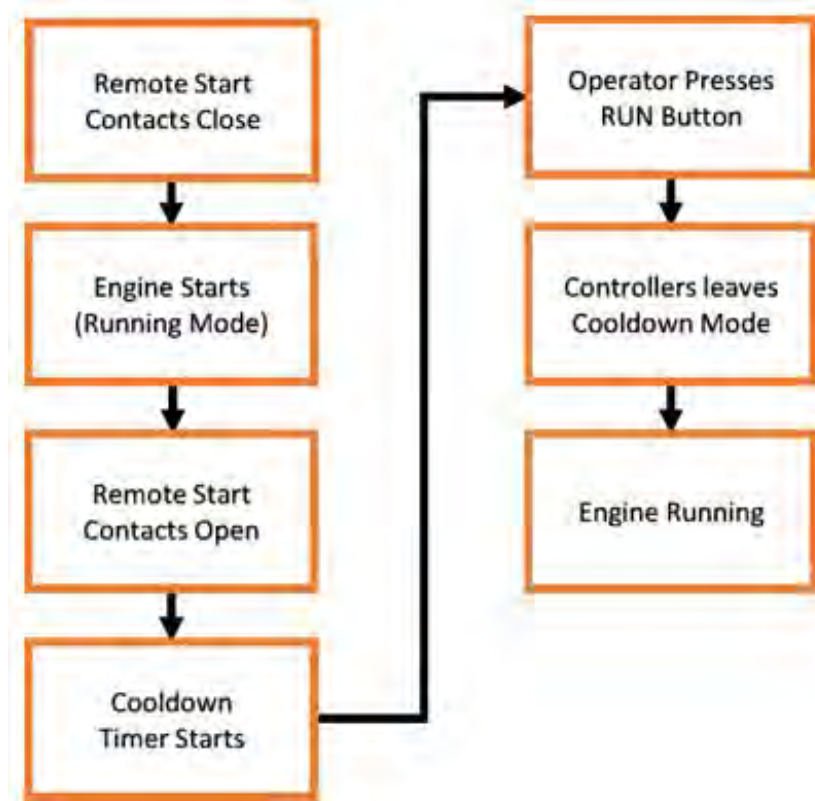

3.3 Warnings

Warnings are conditions that alert the user to possible issues. These get enabled/disabled when you enable/disable various settings in the controller.

Notable warnings are given in the following table.



Warning Name	Enabled Condition(s)	Description
High Fuel Level	High Fuel Level not disabled (in Sensors > Fuel Level menu).	High Fuel Level warning. This is often used to indicate an over fueling condition where fuel could be overflowing from the fuel tank.
Low Engine Temp	Low Engine Temp not disabled (in Sensors > Engine Temp. menu).	Low Engine Temperature warning. This is often used to indicate a malfunction of the engine block heater in stationary generator applications.
Low Oil Pressure	Switched input set to "Oil Pres. Warn" function. See the Switched Inputs section. Triggered if switched input is active during the Run Mode.	Low oil pressure warning.

3.4 Failures

Failures are conditions that cause the controller to shut down to prevent damage to the engine or generator. These get enabled/disabled when you enable/disable various settings in the controller.

Notable failures are given in the following table.

Failure Name	Enabled Condition(s)	Description
ECM Communication Failure	Enabled if loss of ECM communication is enabled. See CANbus (J1939) section. J1939 feature.	If the controller has not received messages from the ECM for 6 seconds.
Exception*	Always enabled.	Occurs when there is an issue from which the controller cannot recover. For example, EMI can cause the microcontroller to enter a bad state, or a software bug could cause the code to hang while triggering the watchdog. In these cases, the controller will reset and enter the failure state. *The name is configurable so it may not match what is shown here.
Failure To Stop	Disabled when ETS On Duration (Energize to Stop) is set to 0 seconds; otherwise, it is enabled. If used, ETS On Duration should be set to at least 2 to 3 seconds; otherwise, this failure may occur on a normal shutdown.	After ETS countdown is finished, if the speed was greater than 50 RPM (600 RPM for TG350/TG410 firmware 1.88 and above) for the previous 2 seconds, then the controller triggers this failure.
Load Imbalance	See Load Imbalance. AC Current feature.	Generator load imbalance. Excessive AC current on one or more of the three phases.



Failure Name	Enabled Condition(s)	Description
Low Air Pressure	Switched input set to “Air Pres. Fail” function. See the Switched Inputs section. Triggered if switched input is active during starting.	Application specific.
Low Coolant Lvl	Switched input set to “Cool. Lvl Fail” function. See the Switched Inputs section. Triggered if switched input is active.	Low Coolant Level.
Low Hydraulic	Switched input set to “Hyd Pres. Fail” function. See the Switched Inputs section. Triggered if switched input is active during starting.	Refers to Low Hydraulic pressure usually. Application specific.
FILL DEF NOW	For electronics engines with a SCR (Selective Catalytic Reaction) emissions aftertreatment only. See J1939 section and J1939 Reference Manual.	The SCR tank needs to be refilled (aka urea tank). Engine may not start if this is not performed or may remain in "limp-home" mode. DEF stands for diesel exhaust fluid.

If Battle Mode (see Battle Mode in the [Switched Inputs](#) section) is active (‘Battle Running’ is displayed on the screen), the controller will not shut down on a failure and no failure information will be displayed on the screen. If Battle Mode is switched off, the controller will shut down on any failure that occurred when Battle Mode was active.

3.5 Events History

The following table lists all events, warnings, and failures than can appear in the controller’s events history. The events history is accessed in the menu under “Events History.”

Event Name	Event Type	Description
Power On	Event	The controller has powered on.
Auto Enabled	Event	The controller has entered Auto Mode. The controller is waiting for a manual or automatic start condition such as a remote start / stop command.
Off Enabled	Event	The controller has entered Off Mode (Not in Auto is displayed on screen). Automatic starting is disabled.
Manual Start	Event	A user has pressed the RUN button on the controller.
Start Cooldown	Event	The controller has entered cooldown. Cooldown has to be enabled under Timers > Engine Logic.
Remote Start	Event	A switched input remote start has been triggered. The controller will start.



Event Name	Event Type	Description
Remote Stop	Event	A switched input remote stop has been triggered. The controller will stop.
Emergency Stop	Event	The switched input Emergency Stop has been triggered. The controller has performed an emergency shutdown, skipping cooldown.
Start Charging	Event	The controller has auto started because of a low starter battery condition. The low battery restart has to be enabled under Sensors > Battery.
Stop Charging	Event	The controller has run for the programmed amount of time to recharge the starter battery and is shutting down.
Service Required	Event	The controller requires maintenance. This has to be enabled under Timers > Maintenance. Also, after maintenance is performed, the tech has to reset the maintenance counter by going to Timers > Maintenance > Reset Counter and selecting "Yes."
Reset Defaults	Event	The controller has loaded default settings. This could have been because the user initiated a factory reset from the RapidCore software or because the controller memory has become corrupt. The controller will need to be programmed with the proper settings if applicable.
Service Complete	Event	The tech has performed service on the engine/generator and has reset the maintenance counter as mentioned in "Service Required" above.
Exerciser Bypass	Event	The exerciser, if enabled under Timers > Exerciser, has been skipped. This could happen if the controller was otherwise running or powered off when an exerciser was scheduled to be performed.
Start Exercise	Event	The controller has auto started to perform an exercise.
Stop Exercise	Event	The controller has run for the programmed exercise and is now shutting down.
Log Cleared	Event	The controller Events History has been cleared either from user action (via the RapidCore software) or because the controller memory was corrupt.
Modbus Start	Event	The controller has auto started from a start command sent to its RS485 Modbus port.
Modbus Stop	Event	The controller has auto stopped from a stop command sent to its RS485 Modbus port.
Genset Disable	Event	Applies to the Kubota electronic engine. Level 3 shutdown has occurred.
Engine Started	Event	The engine has successfully started and entered the Run Mode.
J1939 Remote	Event	The controller has auto started due to a command sent over its CAN J1939 port.



Event Name	Event Type	Description
Idle Speed	Event	The controller has entered Idle Mode either from the idle switched input, the warmup or cooldown idle feature under Engine Logic, or for some other reason. Under speed, under frequency, and under voltage warnings and failures are disabled.
Rated Speed	Event	The controller has exited Idle Mode and has gone back into normal running.
Sensor 1 Run	Event	The controller has auto started due to an Auxiliary Sensor 1 “start on low” or “start on high” request.
Sensor 2 Run	Event	The controller has auto started due to an Auxiliary Sensor 2 “start on low” or “start on high” request.
Sensor 1 Stop	Event	The controller has shut down due to an Auxiliary Sensor 1 “start on low” or “start on high” stop request.
Sensor 2 Stop	Event	The controller has shut down due to an Auxiliary Sensor 2 “start on low” or “start on high” stop request.
Switch Start	Event	A controller start was triggered by the momentary start switched input.
Switch Stop	Event	A controller stop was triggered by the momentary stop switched input.
Regen Inhibited	Event	Electronic engines with a Diesel Particulate Filter (DPF) only. The user requested that the automatic regeneration of the DPF be disabled.
Force Regen	Event	Electronic engines with a Diesel Particulate Filter (DPF) only. The user requested a manual regeneration of the DPF.
Auto Regen	Event	Electronic engines with a Diesel Particulate Filter (DPF) only. The engine ECM has performed an automatic regeneration of the DPF.
Sensor 3 Run	Event	The controller has auto started due to an Auxiliary Sensor 3 “start on low” or “start on high” request.
Sensor 4 Run	Event	The controller has auto started due to an Auxiliary Sensor 4 “start on low” or “start on high” request.
Sensor 3 Stop	Event	The controller has shut down due to an Auxiliary Sensor 3 “start on low” or “start on high” stop request.
Sensor 4 Stop	Event	The controller has shut down due to an Auxiliary Sensor 4 “start on low” or “start on high” stop request.
Long Time Start	Event	A user has started the controller using the RUN button and the long time run feature is enabled under Timers > Long Time Run. The controller will run for the duration specified under “Long Time Run” and then automatically shut down.
Scheduler Start	Event	The controller has auto started due to a daily schedule set up in Timers > Week Scheduler.
Start Cancelled	Event	A daily scheduler was cancelled either because the controller was not in Auto Mode, or a start request was ignored. A start request being ignored is an internal error and should not occur.



Event Name	Event Type	Description
J1939 Start	Event	Controller started from J1939 using the second J1939 start/stop method. Refer to the J1939 Reference Manual for more information. This is often used by telemetry devices to start/stop the controller.
Crank Failed	Warning	The controller has turned its crank output but has failed to detect that the engine is running. After crank rest (if programmed under Timers > Engine Logic) it will try again.
Low Batt InCrank	Warning	During cranking the battery was lower than normal. The level is set under Sensors > Battery.
Charger Fault	Warning	Indicates a battery charger issue. The controller has a battery charger fault switched input. This is used to indicate to the controller that the charger has a fault.
High Fuel Level	Warning	The fuel level has risen above the high fuel level warning threshold set under Sensors > Fuel Level. Potential over fueling issue.
Under Voltage	Warning	The generator AC voltage has fallen below the under voltage warning setpoint set under AC Monitor > Genset Voltage. Possible issue with the voltage regulator or speed governor on the engine.
Under Speed	Warning	The generator speed has fallen below the under speed warning setpoint set under Sensors > Engine Speed.
Over Speed	Warning	The generator speed has risen above the over speed warning setpoint set under Sensors > Engine Speed.
High Engine Temp	Warning	The engine temperature has risen above the high engine temperature warning under Sensors > Engine Temp.
Low Oil Pressure	Warning	The oil pressure has fallen below the low oil pressure warning setpoint under Sensor > Oil Pressure.
Low Fuel Level	Warning	The fuel level has fallen below the low fuel level warning setpoint under Sensors > Fuel Level.
False Restart	Warning	After going into the Run Mode, the controller has determined that the engine has not started after all and will attempt to do another crank attempt. The fault restart feature under Engine Logic > Timers has to be enabled.
Breaker Tripped	Warning	The “Breaker Trip” switched output has been activated. This output is used to control the generator breaker.
Over Current	Warning	The generator AC current has risen above the over current warning setpoint under AC Monitor > O.C. Protection > Basic Alarm.
Fuel In Basin	Warning	The “fuel in basin” switched input has been triggered. This indicates there has been a leak in the fuel tank.
Low Battery	Warning	The main starter battery (the battery from which the controller is powered) voltage has fallen below the low battery warning setpoint under Sensors > Battery.



Event Name	Event Type	Description
High Battery	Warning	The main starter battery (the battery from which the controller is powered) voltage has risen above the high battery warning setpoint under Sensors > Battery.
Low Engine Temp	Warning	The engine temperature has fallen below the low engine temperature warning setpoint set under Sensors > Engine Temp. > Setpoints.
Battle Running	Warning	The “Battle Mode” switched input has been triggered. The controller will not shut down on any failures. All failures will be ignored.
Under Frequency	Warning	The generator AC frequency has fallen below the under frequency warning setpoint set under AC Monitor > Genset Freq. > Setpoints.
Over Frequency	Warning	The generator AC frequency has risen above the over frequency warning setpoint set under AC Monitor > Genset Freq. > Setpoints.
Load Imbalance	Warning	The generator load is imbalanced between the A, B, and C phases. This has to be enabled under AC Monitor > O.C. Protection > Imbalance Mode.
Over Voltage	Warning	The generator AC voltage has risen above the over voltage warning setpoint set under AC Monitor > Genset Voltage. Possible issue with the voltage regulator or speed governor on the engine.
High Fuel Temp	Warning	Doosan G2 electronic engine high fuel temperature warning. This warning comes from the engine ECM over CAN J1939.
Hi Exhaust Temp	Warning	Doosan G2 electronic engine high turbine exhaust temperature. This warning comes from the engine ECM over CAN J1939.
Failed To Stop	Failure	The controller shut down the engine -- by turning off the Fuel output and (if enabled) by turning on the Energize-To-Stop output -- but the engine speed did not go to zero after the energize to stop time (under Timers > Engine Logic).
Breaker Failed	Failure	The “Breaker Trip” switched output failed to turn off the breaker. This is triggered if the AC Current is still above 10% of the rated current setpoint. The “breaker trip” failure has to be enabled under AC Monitor > O.C. Protection > Brk Trip Fail.
Load Imbalance	Failure	The generator load is imbalanced between the A, B, and C phases. This has to be enabled under AC Monitor > O.C. Protection > Imbalance Mode with the mode set to “Shutdown Trip.”
Over Current	Failure	The generator AC current has risen above the over current failure setpoint set under AC Monitor > O.C. Protection > Basic Alarm.
ECM Shutdown	Failure	Electronic engines only. CAN J1939 DM1 stop lamp is active; the ECM has shut down the engine.
High Engine Temp	Failure	Engine temperature has risen above the high engine temperature failure setpoint set under Sensors > Engine Temp.
Low Oil Pressure	Failure	Engine oil pressure has fallen below the low oil pressure failure setpoint set under Sensors > Oil Pressure.



Event Name	Event Type	Description
Under Speed	Failure	Engine speed has fallen below the under speed failure setpoint set under Sensors > Engine Speed.
Over Speed	Failure	Engine speed has risen above the over speed failure setpoint set under Sensors > Engine Speed.
Low Fuel Level	Failure	The fuel level has fallen below the low fuel level failure setpoint under Sensors > Fuel Level.
Low Battery	Failure	The main starter battery (the battery from which the controller is powered) voltage has fallen below the low battery failure setpoint set under Sensors > Battery.
Low Coolant Lvl	Failure	The “Low Coolant Level” switched input is active indicating low coolant level failure.
Over Crank	Failure	The controller exhausted the crank attempts (specified in Timers > Engine Logic > Crank Attempts) and could not start the engine.
Over Voltage	Failure	The generator AC voltage has risen above the over voltage failure setpoint set under AC Monitor > Genset Voltage > Setpoints.
Under Voltage	Failure	The generator AC voltage has fallen below the under voltage failure setpoint set under AC Monitor > Genset Voltage > Setpoints.
Regen Needed	Failure	For electronic engines with a diesel particulate filter (DPF) only. The user must perform a regeneration before running the engine further. Continuing to ignore this message could result in the DPF being damaged and requiring replacement.
Low Air Pressure	Failure	The “Air Press. Fail” switched input is active. Indicates a low air pressure failure condition.
Low Hydraulic	Failure	The “Hyd Pres. Fail” switched input is active. Indicates a low hydraulic pressure failure condition.
High Battery	Failure	The main starter battery (the battery from which the controller is powered) voltage has risen above the high battery failure setpoint set under Sensors > Battery.
Loss Of ECM Comm	Failure	For electronic engines only. The “Loss of ECM” under J1939 must be enabled. The controller has not detected engine speed, oil pressure, or engine temperature on its CAN J1939 port.
Under Frequency	Failure	The generator AC frequency has fallen below the under frequency failure setpoint set under AC Monitor > Genset Freq. > Setpoints.
Over Frequency	Failure	The generator AC frequency has risen above the over frequency failure setpoint set under AC Monitor > Genset Freq. > Setpoints.
DPF SRVC REQ'D!	Failure	For electronic engines with a diesel particulate filter (DPF) only. Service the DPF ASAP. Damage to the DPF is possible if the engine is run.



Event Name	Event Type	Description
SERVICE DPF!!!	Failure	For electronic engines with a diesel particulate filter (DPF) only. Service the DFP ASAP. Damage to the DPF is likely if the engine is run.
Calibration Fail	Failure	Doosan G2 electronic engine only. Contact Doosan for more information.
High Fuel Temp	Failure	Doosan G2 electronic engine high fuel temperature failure. This failure comes from the engine ECM over CAN J1939.
Hi Exhaust Temp	Failure	Doosan G2 electronic engine high turbine exhaust temperature failure. This failure comes from the engine ECM over CAN J1939.
FILL DEF NOW	Failure	For electronics engines with a SCR (Selective Catalytic Reaction) device only. The SCR needs to be refilled. Engine may not start if this is not performed, or it may remain in "limp-home" mode. DEF stands for diesel exhaust fluid.
Engine Stall	Failure	The controller is in the Run Mode and the engine speed has fallen below the crank disconnect speed. The engine stall must be enabled under Timers > Engine Logic.



4 Settings

The following section relates to settings that can be changed to alter the way the controller performs its functions. Read and review these sections carefully to ensure your settings are set correctly for your engine.

4.1 Operator Setup

The following settings are used to change the way the user interacts with the controller. They are not password protected and can be changed by anyone from the front panel.

Name	Range	Default Setting	Description
Lamp Test	-----	-----	Performs a lamp test on the LEDs when selected.
Display > LCD Reverse	-----	-----	Reverses the white and black pixels when selected.
Display > LCD Contrast	5 ~ 95%	50%	Changes the contrast of the LCD.
Display > Page Scroll	1 ~ 10 s	5 s	Amount of time between each auto scroll of the parameter pages.
Display > Message Pop-Up	1 ~ 10 s	2 s	Amount of time each message is displayed on the screen before displaying next message in the buffer.
Display > DPF/DEF Display Time	0 ~ 10 s	2 s	See DPF/DEF aftertreatment in the J1939 Reference Manual for more information.
Display > LCD Backlight Timeout	10 ~ 600 s	600 s	Amount of time the LCD Backlight stays on after button activity stops.
Date / Time > Date Change	1 ~ 31 days 1 ~ 12 months 2000 ~ 2099 yr	-----	Sets the date.
Date / Time > Time Change	0 ~ 23 hr 0 ~ 59 min 0 ~ 59 s	-----	Sets the time.
Date / Time > Daylight Saving	Enable Disable	Enable	Turns Daylight Saving Time on or off. This applies to North America only. Disable for other locations.
Units > Temperature Unit	Fahrenheit or Celsius	Fahrenheit	Selects the temperature display format.
Units > Pressure Unit	PSI or kPa	PSI	Selects the oil pressure display format.



Name	Range	Default Setting	Description
Run from OFF > RUN from OFF	Enable Disable	Enable	When enabled, allows a user to start the engine using the RUN button while in the Off Mode. When disabled, the controller must be placed in Auto Mode before the RUN button can start the engine.

4.2 Switched Inputs

The controller has five switched inputs which cause the controller to perform a function when activated. The following are the default settings.

Default Settings

Switched Input	Default Value
Switched Input A	Emergency Stop
Switched Input B	Start / Stop
Switched Input C	Disable
Switched Input D	Disable
Switched Input E	Disable



Switched I/O > Switched IN X:

Name	Range	Description
Function	[Menu] See below.	The function that the switched input performs when active.
Active Mode	[Menu] See below.	Determines the operating conditions under which the switched input can be active. Multiple selections are allowed.
Trigger	[Menu] See below.	The state of the input determining if it is active or inactive.

Switched I/O > Switched IN X > Function:

Name	Active Mode	Description
Disabled	N/A	Input is disabled and has no function.
Start / Stop	Auto, Running	Starts the engine when active, stops the engine when deactivated. It is recommended that the Trigger mode be set to Close +BAT for better noise tolerance. If Trigger mode is set to "Open" or "Close +BAT/GND", the start/stop input will act like a momentary input. A pulse of 2 to 4 seconds will start controller. Another pulse of 2 to 4 seconds is required to stop the controller. If the input is just turned off, the controller will continue to run.



Name	Active Mode	Description
Emergency Stop	Global	<p>When active, shuts down the engine, displays Emergency Stop, and prevents leaving the Off Mode.</p> <div style="border: 1px solid black; padding: 5px;">  <p>CAUTION</p> <p>THIS SHOULD ONLY BE USED FOR THE EMERGENCY STOP INDICATION ON THE CONTROLLER. THE INSTALLER MUST PROVIDE AN INDEPENDENT MEANS TO SHUT DOWN THE ENGINE FROM THE EMERGENCY STOP BUTTON SUCH AS CUTTING OFF FUEL. SEE THE TYPICAL WIRING DIAGRAMS FOR AN EXAMPLE ON HOW TO WIRE THE EMERGENCY STOP.</p> </div> <div style="border: 1px solid black; padding: 5px;">  <p>ATTENTION</p> <p>CELA NE DOIT ETRE UTILISE QUE POUR L'INDICATION D'ARRET D'URGENCE SUR LE CONTROLEUR. L'INSTALLATEUR DOIT PREVOIR UN MOYEN INDEPENDANT D'ARRETER LE MOTEUR A PARTIR DU BOUTON D'ARRET D'URGENCE, PAR EXEMPLE EN COUPANT LE CARBURANT. VOIR LES SCHEMAS DE CABLAGE TYPES, POUR UN EXEMPLE DE CABLAGE DE L'ARRET D'URGENCE.</p> </div>
Idle Mode	Running	See the Idle section under Engine Logic for more information.
Voltage Select 1	Auto	Used for changing the system AC voltage configuration. See AC Voltage Select for more information.
Voltage Select 2	Auto	
Charger Fault (Battery Charger Fault)	Global	Controller displays “Charger Fault” warning when active.
Mom. Start (Momentary Start)	Auto	<p>Starts or stops the engine when momentarily active for at least 2 seconds. These inputs allow the user to wire separate inputs for start and stop or to use a push button instead of a toggle switch.</p> <p>Momentary stop will only stop the controller when the reason for start was “momentary start.” It will not stop if the front panel RUN button was used to start the engine.</p>
Mom. Stop (Momentary Stop)	Running	
Configurable Warning 1	Configurable	<p>Controller displays a warning or failure with configurable text when active. In the case of the configurable failures, a shutdown is also performed.</p> <p>The RapidCore Configurator Software must be used to change the text.</p>
Configurable Warning 2	Configurable	
Configurable Failure 1	Configurable	



Name	Active Mode	Description
Configurable Failure 2	Configurable	The settings under Timers > Trigger Delays > Config Inputs and Timers > Trigger Delays > Config Fail 3 can be set to control the amount of time the input has to be active in order to trigger.
Configurable Failure 3	Configurable	
Air Press. Fail (Air Pressure Failure)	Cranking	Controller displays 'Low Air Pressure' and shuts down engine when active.
Hyd Pres. Fail (Low Hydraulic Pressure Failure)	Cranking	Controller displays 'Hydraulic Pressure Failure' and shuts down engine when active.
Oil Pres Warn (Low Oil Pressure Warning)	Running	Controller displays 'Oil Pressure Warning' when active.
Cool. Lvl Fail (Low Coolant Level Failure)	Global	Controller displays 'Low Coolant Lvl' and shuts down engine when active.
High Fuel Warning	Global	Controller displays 'High Fuel Level' warning when active.
Lamp Test	Global	Controller performs lamp test when active. If the controller is in the Failure Mode, the LED will remain red. The only indication that the lamp test is active is the LED indicator will alternate between the green and red colors. The LED goes back to its original state when the switched input is no longer active.
Fuel In Basin	Global	Controller displays 'Fuel In Basin' warning when active.
Battle Mode	After Cranking	Controller ignores all warnings and failures when active. Displays 'Battle Running' when active. If a failure occurs during Battle Mode, it is 'latched' and the engine will shut down on failure when the controller leaves Battle Mode.
Start Inhibit	Global	Controller ignores all start commands, and the engine cannot start when active. Once Start Inhibit becomes inactive, starting is enabled again. If the engine is running, activating this input will shut down the engine and place the controller in Auto Mode.
RPM Switch (Primary RPM / 60 Hz - Secondary RPM / 50 Hz Select)	Auto	Used for changing between Primary and Secondary RPM for an engine or 50 Hz / 60 Hz for a generator. See RPM / Frequency Select for more information.
ECM Preheat (ECM Preheat Signal)	Cranking (during the Preheat countdown only)	Controls preheating using a switched input. See Switched Input in the Preheat Mode section.



Name	Active Mode	Description
Remote Reset	Global	Allows the controller to be reset from a Failure Mode. <ul style="list-style-type: none"> • Momentary action for 3-5 seconds in Failure Mode will place the controller in Off Mode • Momentary action for 3-5 seconds in Off Mode will place the controller in Auto Mode • Momentary action for 3-5 seconds in Run Mode will place the controller in Auto Mode. Cool-down is skipped.

	CAUTION
	MORE THAN ONE ACTIVE MODE CAN BE SELECTED.

	ATTENTION
	IL EST POSSIBLE DE SELECTIONNER PLUS D'UN ACTIVE MODE (MODE ACTIF).

The active mode is only configurable if the Function menu is set to one of the configurable switched input functions. It is fixed for all other functions.

Switched I/O > Switched IN X > Trigger:

Name	Description
Close +BAT	Input is active when +Battery is present at the terminal.
Close GND	Input is active when Ground is present at the terminal.
Close +BAT/GND	Input is active when either +Battery or Ground is present at the terminal.
Open	Input is active when neither +Battery nor Ground is present at the terminal.

	CAUTION
	WHEN RUNNING WIRES OVER LONG DISTANCES (OVER 20 FT / 6.1 M), IT IS RECOMMENDED THAT THE +BATTERY BE USED AS THE TRIGGER METHOD.

	ATTENTION
	LORSQUE VOUS FAITES PASSER DES FILS SUR DE LONGUES DISTANCES (AU DELA DE 6 M), IL EST RECOMMANDE D'UTILISER +BATTERIE COMME METHODE DE DECLENCHEMENT.

4.2.1 Configurable Inputs

These inputs are used to create custom warnings and failures. Using the RapidCore Configurator Software, you can change the text displayed when the warning or failure occurs. If you select one of these inputs without changing the text, it will default to 'Config Warn X' and 'Config Fail X'.



There are also timers associated with the configurable inputs which can be found in the menu under Timers > Trigger Delays > Config Inputs and Config Fail 3. These timers change the amount of time the input has to be active before the controller registers the warning or failure.

	CAUTION
	IF THE SWITCHED INPUT BECOMES INACTIVE BEFORE THE TRIGGER DELAY TIME EXPIRES, THE WARNING OR FAILURE WILL NOT OCCUR.

	ATTENTION
	SI L'ENTREE COMMUTEE DEVIENT INACTIVE AVANT L'EXPIRATION DU DELAI DE DECLENCHEMENT, L'AVERTISSEMENT OU LA PANNE NE SE PRODUIRA PAS.

Example: The user wants a pump to turn on 30 seconds after a high water level switch is tripped and remain on until the level switch turns off.

The level switch is connected to Switched Input C and closes to ground when the water level is too high. The words 'Water Pumping' are also required to be displayed on the controller's LCD screen. The pump is connected to a slave relay which is controlled by Switched Output D on the controller.

Relevant Settings

Setting	Value
Switched Input C > Function	Configurable Warning 1
Switched Input C > Active Mode	Global
Switched Input C > Trigger	Close GND
Configurable Warning 1 Custom Text	Water Pumping
Switched Output D > Warnings	Configurable Warning 1

4.3 Switched Outputs

The controller has switched outputs that are turned on under certain conditions to perform a function. The outputs turn on to +Battery voltage to drive the load when active. The following items are the available functions for switched outputs.

	WARNING
	SWITCHED OUTPUTS HAVE A FLOATING VOLTAGE OF APPROXIMATELY 8 V WHEN OFF. IF USING THE OUTPUTS FOR DIGITAL LOGIC, IT WILL BE NECESSARY TO PUT A PULL-DOWN RESISTOR (2.2 KΩ, 1 WATT) FROM THE OUTPUT TO GROUND TO ENSURE A LOW LOGIC LEVEL WHEN OUTPUT IS OFF.



	AVERTISSEMENT
	<p>LES SORTIES COMMUTEES PRESENTENT UNE TENSION FLOTTANTE D'ENVIRON 8 V LORSQU'ELLES SONT OFF (INACTIVES). SI VOUS SOUHAITEZ UTILISER LES SORTIES COMME SIGNAUX LOGIQUES NUMERIQUES, IL FAUT INSTALLER UNE RESISTANCE PULL-DOWN (2,2 KΩ, 1 W) ENTRE LA SORTIE CONCERNEE ET LA MASSE, POUR ASSURER UN NIVEAU LOGIQUE BAS QUAND LA SORTIE EST OFF.</p>

Default Settings

Switched Output	Default Setting
Switched Output A	Fuel Output
Switched Output B	Disable
Switched Output C	Crank Output
Switched Output D	Disable
Switched Output E	Disable
Switched Output F	Disable

Event Functions

Name	Active Mode	Description
Fuel	Cranking, Running	Active during cranking and running to supply fuel to engine.
Crank	Cranking	Active during cranking to start the engine.
Pull Coil	Cranking	See Pull and Hold Coil section for more information.
LCD Backlight	Global	Active when LCD Backlight is active.
Voltage Regulator	Running	Active when engine is starting/running and is not in Idle Mode.
ETS (Energize to Stop)	ETS Timer	Active during Energize to Stop timer. See 71 under Timers > Engine Logic for more details.
Off Mode (Not In Auto)	Off	Active when the controller is in the Off Mode.
Idle Mode	Idle Mode	Active when the controller is in Idle Mode. For example, when the idle switched input is active or during warmup and cooldown if warmup idle and cooldown idle settings under Timers > Engine Logic are enabled.
Battle Mode	Battle Mode	Active when Battle Mode switched input is active.
System OK (System Ready)	Auto, Run	Active when the controller is in the Auto and Run Modes and no warnings or failures are present.
Delay to Start	Delay to Start Timer	Active when the Delay to Start timer is active.



Name	Active Mode	Description
Glowplug	Preheat, Midheat, Postheat	Active during the Preheat, Midheat and Postheat timers.
Warmup	Warmup Timer	Active in Run Mode after Warmup Timer has expired. Is not active in the cooling down state or other states. Typically used to apply load to the engine only after it has warmed up and to remove the load on cooldown.
Cooldown	Cooldown Timer	Active when Cooldown Timer is active.
Engine Running	Running	Active after crank success.
Exercising	Exercise Timer	Active during the engine exercising cycle.
Batt. Recharge (Battery Recharge)	Battery Recharge Timer	Active during the battery recharge cycle.
Maintenance (Maintenance Required)	Global	Active when Maintenance timer has expired. If the timer has expired when the controller is in the Run Mode, the output does not turn on until the controller enters the Off or Auto Mode. See the Maintenance section.
LowBat InCrank (Low Battery During Cranking)	Cranking	Active when Low Battery During Cranking warning is displayed.
Aux Sensor 1	Auxiliary Settings Dependent	Active dependent upon settings in the Auxiliary Sensors section.
Aux Sensor 2		
Aux Sensor 3		
Aux Sensor 4		
Force Regen	User Controlled	When user triggers a Force Regeneration, output is active for 20 seconds then switches off.
Regen Inhibit	User Controlled	When user triggers a Regeneration Inhibit, output is active for 20 seconds then switches off.
Common Failure	Any Failure	Active when any failure occurs.
RPM Increment	Running	Output is used to trigger inputs on an ECM to control speed. See Front Panel Speed Control section for more information.
RPM Decrement	Running	Output is used to trigger inputs on an ECM to control speed. See Front Panel Speed Control section for more information.
DEF Fluid Pump	Running	Active when DEF Fluid Level falls below the DEF Low Level and stays active until the level rises above the DEF High Level. See CANbus (J1939) section for more information.



Name	Active Mode	Description
Genset Disable	Global	Disables the generator during a stationary Regen on Kubota engines (see Aftertreatment in the J1939 Reference Manual) or also during an engine idle condition from the idle switched input. Automatic idle is ignored. If the generator voltage is not below the under voltage setpoint in 10 seconds, the controller will shut down the engine on “Generator Disable Failure.”
Dummy Load	Running	Output is controlled by the dummy load feature.
Breaker Trip	Running	Output is controlled by the Over Current Failure, IDMT and Load Imbalance features. The Breaker Trip only reacts to over current faults; it does not activate for other failures.
Auto Idle	Warm-up, Cooldown	Active at the start of delay to start until the end of warm-up if warmup idle is enabled. Also active during cooldown if cooldown idle is enabled. See Warm-up Idle and Cooldown Idle in Engine Logic . This output does not react to the Idle switched input.
RPM Output	Running	Refer to the RPM Output feature under Sensors > Engine Speed for more information.
Amb Temp Out	Running	Used by the J1939 Ambient Air Temperature Control feature. Refer to the J1939 Reference Manual for more details.

Warning Functions

Functions			
Low Engine Temperature	High Engine Temperature	Low Oil Pressure	Under Speed
Over Speed	Low Fuel Level	High Fuel Level	Low Battery Voltage
High Battery Voltage	Under Frequency	Over Frequency	AC Under Voltage
AC Over Voltage	Over Current	Fuel In Basin	Battery Charger Fault
Configurable Warning 1	Configurable Warning 2	Auxiliary Sensor 1	Auxiliary Sensor 2
Auxiliary Sensor 3	Auxiliary Sensor 4		
Name	Active Mode	Description	
DTC Received (DTC/MIL)	Running	Active when controller receives a DM1 from the ECM.	

Failure Functions

Functions			
Overcrank	Engine Failed to Stop	DM1 Stop Lamp	High Engine Temperature



Functions			
Low Oil Pressure	Low Fuel Level	Under Speed	Over Speed
Low Battery Voltage	High Battery Voltage	Low Coolant Level	Low Air Pressure
Low Hydraulic Pressure	Under Frequency	Over Frequency	AC Under Voltage
AC Over Voltage	Over Current (TG410 only)	ECM Communication Failure	Configurable Failure 1
Configurable Failure 2	Configurable Failure 3	Auxiliary Sensor 1	Auxiliary Sensor 2
Auxiliary Sensor 3	Auxiliary Sensor 4		
Name	Active Mode	Description	
Exception Fault*	All	When the controller encounters an unhandled exception or lockup (watchdog triggered), it will reset and enter the Failure Mode as an exception fault. *The name of this fault is configurable from the Configurator Software.	

4.3.1 Group Outputs

Group functions have been designed to allow multiple output functions to be bundled together and assigned to a single switched output pin. The definition of a group output follows.

When any of the functions in a group is active (OR logic), the assigned switched output will be active.

Group Functions

Name	Active Mode	Description
Group #1	Group Dependent	Must be set from RapidCore Configurator software.
Group #2	Group Dependent	Must be set from RapidCore Configurator software.
Group #3	Group Dependent	Must be set from RapidCore Configurator software.
Group #4	Group Dependent	Must be set from RapidCore Configurator software.

Example: Low AC Frequency, High AC Frequency are bundled in 'Group #1' and assigned to Switched Output D. This output is connected to an external indicator lamp labeled 'AC Frequency Warnings', allowing one output to indicate there is a warning with the AC frequency. The following table shows the output state based on the Warnings status.

Low AC Frequency Warning	High AC Frequency Warning	Switched Output State
Inactive	Inactive	OFF
Inactive	Active	ON
Active	Inactive	ON
Active	Active	ON



4.3.2 Pull and Hold Coil

On some engine systems the fuel pump has two coils. This is because the initial power-on of the fuel solenoid requires substantial current (Pull Coil), but only needs a small amount of current to hold it in place (Hold Coil).

1. Hold Coil (Fuel) is energized.
2. Pull Coil is energized for the first 1.6 to 1.8 seconds of preheat. If preheat is disabled, the pull coil is energized at the beginning of cranking; the crank output turned off for that time period.
3. This is repeated for each crank attempt.

Configuring a switched output to Pull Coil automatically configures the engine logic necessary for a Pull Coil system.

Note: The pull coil feature does not operate when the fuel output is activated by the Auto Power ECM feature or when requesting stored DTCs (DM2 codes). See the [CANbus \(J1939\)](#) section for more information on these features.

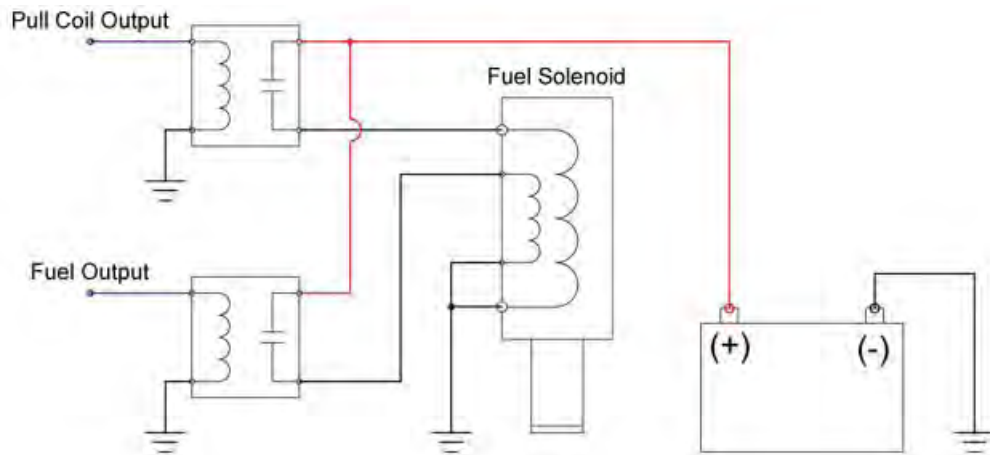

Pull Coil Wiring Example

4.4 Sensors

The controller has four sensor inputs which can be connected to a variety of different sensors/switches depending on the input. See the [Terminal Descriptions](#) section for more information regarding the sensor types supported.

To configure the behavior of these sensor inputs, the user assigns the sensor input to one of the following seven sensor functions:

- Engine Temperature
- Oil Pressure
- Fuel Level
- Auxiliary Sensor 1



- Auxiliary Sensor 2
- Auxiliary Sensor 3
- Auxiliary Sensor 4

Note that there are more sensor functions than sensor inputs as the Auxiliary Sensors can be assigned the same sensor input as the other sensor functions.

- The Engine Temperature, Oil Pressure, and Fuel Level functions are mostly fixed in functionality but the [Auxiliary Sensors](#) can be configured to perform specific shutdowns or special functions (for example, starting engine on low temperature)
- The Engine Temperature, Oil Pressure, and Fuel Level functions can be set to work with a switch or a sender/sensor, but the Auxiliary sensors can only work with a sender

Note: The engine speed and battery level are built in and do not need to be assigned to a pin.

4.4.1 Engine Temperature

Use the following settings' configurations to allow the controller to read and interpret data from the engine temperature sensor or switch.

(Sensors > Engine Temp. menu)

Name	Range	Default Settings	Description
Signal Source	Port A Port B Port C Port D J1939 Bus*	Port A	The sensor input pin where the engine temperature switch or sender is attached. *Engine temperature is obtained from the engine controller (ECM) using the CANbus communication port and J1939 protocol.



Name	Range	Default Settings	Description
Sensor Type	DAT DAH* VDO 250F* (custom sender)** Close = Warning+ Open = Warning+ Close = Failure+ Open = Failure+	DAT DAH	<p>Select the sender that is connected to the Signal Source above. If using a switch, select the action that should occur when the switch is active.</p> <p>*These are preprogrammed into the controller and cannot be changed.</p> <ul style="list-style-type: none"> - DAT DAH supports all Datcon type DAH (high range) temperature sensors such as 02022-00 - VDO 250F supports the VDO 323-420 or equivalent temperature sensor <p>DAT DAH and VDO 250F can only be used if the Signal Source is set to Port A or D. To use on other ports, store as a custom sender table using the RapidCore Configurator software.</p> <p>**A custom table can be created using the RapidCore Configurator Software. The text (custom sender) will be replaced with the custom text you choose when creating the sender.</p> <p>+The switch must close to ground.</p>
Trim Offset	-50.0 ~ 50.0 °F (-27.8 ~ 27.8 °C)	0.0 °F	Calibrate a sensor by using the offset to correct errors. Only applies if Sensor Type has been set to a sender.
Setpoints > Bypass Time	0 ~ 90 s	30 s	Amount of time to bypass warnings and failures after engine has started.
Setpoints > Low Warn (Low Warning)	Disabled 32 ~ 200 °F (0 ~ 93.3 °C)	Disabled	Reading at which a “Low Engine Temp” warning occurs. Displays ‘Low Engine Temp’ on the screen. Only applies if Sensor Type has been set to a sender. Monitored globally including Off and Auto Mode.
Setpoints > High Warn (High Warning)	Disabled 50 ~ 300°F (10 ~ 148.9 °C)	200 °F	Reading at which a “High Engine Temp” warning occurs. Only applies if Sensor Type has been set to a sender. Only monitored in the Run Mode.
Setpoints > High Fail (High Failure)	Disabled 50 ~ 300°F (10 ~ 148.9 °C)	220 °F	Reading at which a “High Engine Temp” failure occurs. Only applies if Sensor Type has been set to a sender. Only monitored in the Run Mode.

Note: All temperature settings are entered in terms of Fahrenheit.



4.4.2 Oil Pressure

Use the following settings' configurations to allow the controller to read and interpret data from the oil pressure sensor or switch.

Name	Range	Default Settings	Description
Signal Source	Port A Port B Port C Port D J1939 Bus*	Port B	The sensor input pin where the oil pressure switch or sender is attached. *Oil pressure is obtained from the engine controller (ECM) using the CANbus communication port and J1939 protocol.
Sensor Type	DAT 100P/R240* VDO 150P/R180* (custom sender)** Close = Warning ⁺ Open = Warning ⁺ Close = Failure ⁺ Open = Failure ⁺	DAT 100P/R240 (Stewart 279B-F)	Select the sender that is connected to the Signal Source above. If using a switch, select the action that should occur when the switch is active. *These are preprogrammed into the controller and cannot be changed. - DAT 100P/R240 supports the Stewart - Warner 279B-F and Datcon 2505-00 sender tables - VDO 150P/R180 supports the VDO 360-004 oil pressure sender DAT 100P/R240 and VDO 150P/R180 cannot be used on port A. To use on port A, store as a custom sender table using the RapidCore Configurator software. **A custom table created using the RapidCore Configurator Software. The text (custom sender) will be replaced with the custom text you choose when creating the sender. ⁺ The switch must close to ground.
Trim Offset	-50.0 ~ 50.0 PSI (-344.7 ~ 344.7 kPa)	0 PSI	Calibrate a sensor by using the offset to correct errors. Only applies if Sensor Type has been set to a sender.
Setpoints > Bypass Time	0 ~ 90 s	30 s	Amount of time to bypass warnings and failures after engine has started.
Setpoints > Low Warning	Disabled 0.1 ~ 99.0 PSI (0.7 ~ 682.6 kPa)	20.0 PSI	Reading at which a "Low Oil Pressure" warning occurs. Only applies if Sensor Type has been set to a sender.
Setpoints > Low Failure	Disabled 0.1 ~ 99.0 PSI (0.7 ~ 682.6 kPa)	15.0 PSI	Reading at which a "Low Oil Pressure" failure occurs. Only applies if Sensor Type has been set to a sender.

Note: All pressure settings are entered in terms of PSI.



4.4.3 Fuel Level

Use the following settings' configurations to allow the controller to read and interpret data from the fuel level sensor.

Name	Range	Default Settings	Description
Signal Source	Disable Port A Port B Port C Port D	Disable	The sensor input pin where the fuel level switch or sender is attached
Sensor Type	DAT R/33-240* VDO R/0-180* (custom sender)** Close = Warning+ Open = Warning+ Close = Failure+ Open = Failure+	Close = Failure	<p>Select the sender that is connected to the Signal Source above. If using a switch, select the action that should occur when the switch is active.</p> <p>*These are preprogrammed into the controller and cannot be changed.</p> <ul style="list-style-type: none"> - DAT R/33-240 supports a Datcon fuel level sensor of the range 33 Ω to 180 Ω - VDO R/0-180 supports a VDO fuel level sensor of the range 0 Ω to 180 Ω <p>DAT R/33-240 and VDO R/0-180 cannot be used on port A. To use on port A, store as a custom sender table using the RapidCore Configurator software.</p> <p>**A custom table created using the RapidCore Configurator Software. The text (custom sender) will be replaced with the custom text you choose when creating the sender.</p> <p>+The switch must close to ground</p>
Trim Offset	-50.0 ~ 50.0%	0.0%	Calibrate a sensor by using the offset to correct errors. Only applies if Sensor Type has been set to a sender.
Setpoints > Bypass Time	0 ~ 90 s	30 s	Amount of time to bypass warnings and failures after engine has started.
Setpoints > Low Warning	Disabled 1 ~ 90%	25%	Reading at which a "Low Fuel Level" warning occurs. Only applies if Sensor Type has been set to a sender. Only monitored in the Run Mode.



Name	Range	Default Settings	Description
Setpoints > Low Failure	Disabled 1 ~ 90%	5%	Reading at which a “Low Fuel Level” failure occurs. Only applies if Sensor Type has been set to a sender. Only monitored in the Run Mode.
Setpoints > High Warning	Disabled 1 ~ 125%	Disabled	Reading at which a “High Fuel Level” warning occurs. Displays ‘High Fuel Level’ on the screen. Only applies if Sensor Type has been set to a sender. Monitored globally including Off and Auto Mode.

4.4.4 Engine Speed

Use the following settings’ configurations to allow the controller to read and interpret speed sensing data.

Name	Range	Default Settings	Description
Signal Source	J1939 Bus Mag Pickup Genset Voltage	Genset Voltage	The source for the engine speed signal. J1939 -- Engine speed is obtained over the engine CAN communication bus. Genset Voltage -- The AC Voltage connector phase A is used for engine speed. Mag Pickup -- A magnetic pickup, alternator output, or the distributor signal can be used to sense speed. Must use J6 pins 7 and 8. If using a distributor, a filter is often required. Contact Cattron at www.cattron.com for more information on using a distributor signal.
Speed Settings > Rated RPM	500 ~ 4000 RPM in 1 RPM increments	1800 RPM	Speed at which the engine runs under normal operating conditions. Warning and failure setpoints are calculated from this setting.
Speed Settings > Idle RPM	300 ~ 2000 RPM in 1 RPM increments	900 RPM	Speed at which the engine runs when it is idling.



Name	Range	Default Settings	Description
Speed Settings > Tooth Count	1 ~ 600	110	(only applies when Signal Source is set to Mag Pickup) Number of teeth on the flywheel. If the number of teeth is unknown, the following formula can be used. A multimeter must be used to measure the AC frequency (Frequency-In-Hz below) from the magnetic pickup. The speed (Speed-In-RPM below) must be known. $\text{Tooth-Count} = (\text{Frequency-In-Hz} * 60) / \text{Speed-In-RPM}$
Setpoints > Low Warn (Under Speed Warning)	20 ~ 99%	90%	Reading at which a warning occurs.
Setpoints > Low Fail (Under Speed Failure)	20 ~ 99%	85%	Reading at which a failure occurs.
Setpoints > High Warn (Over Speed Warning)	101 ~ 150%	110%	Reading at which a warning occurs.
Setpoints > High Fail (Over Speed Failure)	101 ~ 150%	115%	A over speed failure is triggered if the speed is above this threshold for 4 seconds.
RPM Control > Min Speed	500 ~ 4000 RPM in 1 RPM increments	600 RPM	Front Panel Speed Control Settings. See the Front Panel Speed Control section for more information on these settings.
RPM Control > Max Speed	500 ~ 4000 RPM in 1 RPM increments	2000 RPM	
RPM Control > Speed Bias	0 to 600 RPM in 1 RPM increments	30 RPM	
RPM Control > TSC1 RPM/s	Disabled 10 to 300 RPM in 10 RPM increments	200 RPM	
RPM Display	Blank AC Hertz Aux Sensor 1 Aux Sensor 2	AC Hertz	



Name	Range	Default Settings	Description
RPM Switch > Secondary (Secondary RPM / 50 Hz)	500 ~ 4000 RPM in 1 RPM increments	1500 RPM	The Rated RPM when the Secondary RPM / 50 Hz is selected. See RPM / Frequency Select section for more information.
RPM Switch > Primary (Primary RPM / 60 Hz)	500 ~ 4000 RPM in 1 RPM increments	1800 RPM	The Rated RPM when the Primary RPM / 60 Hz is selected. See RPM / Frequency Select section for more information.
RPM Output	See the RPM Output section for more information.		

Note: When using J1939 or Genset Voltage as a signal source, connections to the speed sensing terminals are not required.

IMPORTANT: When using Genset Voltage as a signal source, the voltage source must be connected to terminal A (J7-1). AC frequency is sensed on terminal A only.

	CAUTION
	<p>SPEED IS MONITORED AT THE START OF CRANKING. IF THERE IS SPEED DETECTED ABOVE THE CRANK DISCONNECT SETTING, THEN CRANKING AND IDLE ARE SKIPPED. THE SPEED IS NOT MONITORED DURING DELAY TO START OR PREHEAT AS THIS PROVIDES SOME DEGREE OF PROTECTION AGAINST SPURIOUS SIGNALS DUE TO NOISE. THE FUEL INPUT IS TURNED ON AT THE START OF PREHEAT AND OFTEN POWERS EXTERNAL EQUIPMENT THAT CAN CAUSE NOISE.</p>

	ATTENTION
	<p>LA VITESSE DE ROTATION EST CONTROLEE AVANT D'ENGAGER LE DEMARREUR. SI LA VITESSE DETECTEE EST SUPERIEURE A LA VITESSE DE DESENGAGEMENT DU DEMARREUR, LE DEMARRAGE ET LE RALENTI SONT IGNORES. LA VITESSE N'EST PAS CONTROLEE PENDANT LE DELAI DE DEMARRAGE OU DE PRECHAUFFAGE, AFIN D'ASSURER UNE CERTAINE PROTECTION CONTRE LES SIGNAUX PARASITES DUS AU BRUIT. L'ARRIVEE DE CARBURANT EST ACTIVEE AU DEBUT DU PRECHAUFFAGE, ET ALIMENTE SOUVENT CERTAINS EQUIPEMENTS EXTERNES QUI PEUVENT GENERER DU BRUIT. H (MAINTAIN FONT AND COLOR)</p>

4.4.4.1 *Front Panel Speed Control*

The operator is able to adjust the speed of the engine by using the controller's front panel. This section describes the two methods available for implementing speed control, the settings and the parameters to be used, and the necessary instructions allowing the operator to control the speed.



Speed Control Methods

Setting	Description
Front Panel Speed Control using J1939 TSC1	The controller can instruct the ECM of an electronic engine to adjust its speed by broadcasting the TSC1 command. Refer to the J1939 Reference Manual for more information.
Front Panel Speed Control using Switched Outputs	The controller can instruct the ECM of an electronic engine to adjust its speed by using switched outputs on the controller set to RPM Increment and RPM Decrement to interface with digital inputs on the ECM. When the speed is changed, the corresponding switched output will be on for 1 second each time increment or decrement is pressed. See the rest of this section for more information.
Aux 4 Speed Control	The Auxiliary Sensor 4 is used to determine the setpoint speed. The speed is adjusted with the TSC1 J1939 command. Refer to the J1939 Reference Manual for more information.

	WARNING
	SWITCHED OUTPUTS HAVE A FLOATING VOLTAGE OF APPROXIMATELY 8 V WHEN OFF. IF USING THE OUTPUTS FOR DIGITAL LOGIC, IT WILL BE NECESSARY TO PUT A PULL-DOWN RESISTOR (2.2 KΩ, 1 WATT) FROM THE OUTPUT TO GROUND TO ENSURE A LOW LOGIC LEVEL WHEN OUTPUT IS OFF.

	AVERTISSEMENT
	LES SORTIES COMMUTEES PRESENTENT UNE TENSION FLOTTANTE D'ENVIRON 8 V LORSQU'ELLES SONT OFF (INACTIVES). SI VOUS SOUHAITEZ UTILISER LES SORTIES COMME SIGNAUX LOGIQUES NUMERIQUES, IL FAUT INSTALLER UNE RESISTANCE PULL-DOWN (2,2 KΩ, 1 W) ENTRE LA SORTIE CONCERNEE ET LA MASSE, POUR ASSURER UN NIVEAU LOGIQUE BAS QUAND LA SORTIE EST OFF.

Front Panel Speed Control Using the Switched Outputs

Settings

Name	Parent Menu	Range	Default	Description
Speed Control Enable	RapidCore only. Engine Speed menu.	Enable Disable	Disable	(Programmable from RapidCore Configurator Software only) Enables or disables front panel speed control.
RPM Display	Sensors > Engine Speed	Blank AC Hertz Aux Sensor 1 Aux Sensor 2	AC Hertz	Parameter to display when adjusting speed from front panel. This is used to provide operator feedback in the case that the engine RPM affects another parameter such as AC Frequency or an Auxiliary Sensor (example: flow rate of pump).



Name	Parent Menu	Range	Default	Description
Limit Method	RapidCore only. Engine Speed menu.	Speed Bias Min RPM / Max RPM	Speed Bias	(Programmable from RapidCore Configurator Software only) The method in which the minimum and maximum speeds the operator is allowed to adjust is determined.
Speed Bias	Sensors > Engine Speed > RPM Control	0 ~ 600 RPM in 1 RPM increments	30 RPM	The minimum or maximum RPM that the engine speed can be adjusted around the Rated RPM. Example: Rated RPM is 1800 and Speed Bias is 150. The minimum RPM will be 1650 and maximum RPM will be 1950. Only valid when the correct Limit Method is chosen.
Min Speed		500 ~ 4000 RPM in 1 RPM increments	600 RPM	The minimum RPM that can be set using speed control. Only valid when the correct Limit Method is chosen.
Max Speed		500 ~ 4000 RPM in 1 RPM increments	2000 RPM	The maximum RPM that can be set using speed control. Only valid when the correct Limit Method is chosen.
TSC1 RPM/s	Sensors > Engine Speed > RPM Control	Disable 10 ~ 300 RPM/s in 10 RPM/s increments	200 RPM/s	Ignore this setting. Refer to the J1939 Reference Manual for information on this setting.

Speed Control Instructions

When the controller is running and there are other functions occurring, the controller will scroll through its display parameters as usual. When the speed control page is displayed, it will show the Engine Speed as well as the following instructions: Hold AUTO + Up/Down to Adjust RPM.

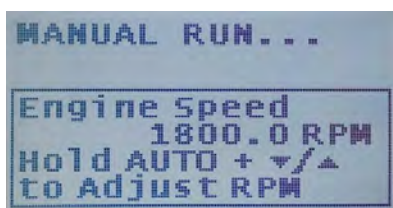

Speed Control Parameter Page

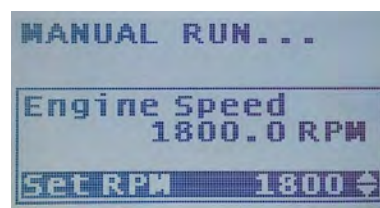

Speed Control Adjust Page

Pressing and holding the AUTO button will display the screen to the right. If a 'Display Adjust Parameter' is set, it will also be displayed underneath the Engine Speed. While still holding the AUTO key, press the up or down arrows to adjust the RPM. The Engine Speed display should update as the engine physically changes its speed to accommodate the speed request.



	<p>CAUTION</p> <p>WHEN USING SWITCHED OUTPUTS FOR SPEED CONTROL, THE SET RPM WILL DISPLAY '---' INSTEAD OF THE SET SPEED.</p>
---	--

	<p>ATTENTION</p> <p>SI VOUS UTILISEZ DES SORTIES COMMUTEES POUR LA COMMANDE DE VITESSE, SET RPM (REGIME MOTEUR DE CONSIGNE EN TOURS/MINUTE) AFFICHERA « --- » AU LIEU DU REGIME DE CONSIGNE.</p>
---	---

4.4.4.2 RPM Output

This feature can be used to turn an output on and off when the speed of the engine/generator rises or falls below a given speed.

To use this feature, a [Switched Output](#) has to be set to “RPM Output”.

(Sensors > Engine Speed)

Name	Range	Default	Description
RPM Output	Sub menu	----	----
RPM Output > Debounce	0.2 ~ 10 s in 0.2 s increments	2 s	Sets the time to wait before turning on or off the switched output.
RPM Output > Trigger	Disable Under Over	Disable	Sets when to turn on the switched output relative to the Switched RPM setting.
RPM Output > Switch RPM	500 to 3000 RPM in 1 RPM increments	1800 RPM	Sets the RPM to trigger on. Trigger is based on this setting.

4.4.5 Battery

Use the following settings' configurations to allow the controller to read and interpret the battery voltage level.

Name	Range	Default	Description
Battery Recharge	Enable Disable	Disable	Enables or disables the ability to have the engine start on low battery voltage in order to charge it.
Recharge Setup > Level	6.0 - 30.0 V	10.4 V	Voltage level at which the controller starts the engine to recharge the battery.
Recharge Setup > Pre-Alarm	1 ~ 30 min	5 min	Amount of time to display a warning before starting the engine.
Recharge Setup > Duration	10 ~ 900 min	90 min	Amount of time to run the engine.



Name	Range	Default	Description
Setpoints > Low Warning	Disabled 6.0 ~ 24.0 V	11.3 V	Reading at which a warning occurs.
Setpoints > Low Failure	Disabled 6.0 ~ 24.0 V	Disabled	Reading at which a failure occurs.
Setpoints > High Warning	Disabled 12.0 ~ 32.0 V	Disabled	Reading at which a warning occurs.
Setpoints > High Failure	Disabled 12.0 ~ 32.0 V	Disabled	Reading at which a failure occurs.
LowBat InCrank	6.0 ~ 24.0 V	8.0 V	Screen displays a 'Low Voltage During Cranking' warning if voltage dips below this level during cranking.

	CAUTION
	WHEN THE ENGINE IS RUNNING, THE BATTERY VOLTAGE WILL EQUAL THE ALTERNATOR CHARGING VOLTAGE. THE ACTUAL OPEN-CIRCUIT BATTERY VOLTAGE MAY BE LOWER THAN DISPLAYED.

	ATTENTION
	QUAND LE MOTEUR TOURNE, LA TENSION DE BATTERIE EST EGALE A LA TENSION DE CHARGE DE L'ALTERNATEUR. LA TENSION REELLE DE LA BATTERIE EN CIRCUIT OUVERT PEUT ETRE INFERIEURE A CELLE AFFICHEE.



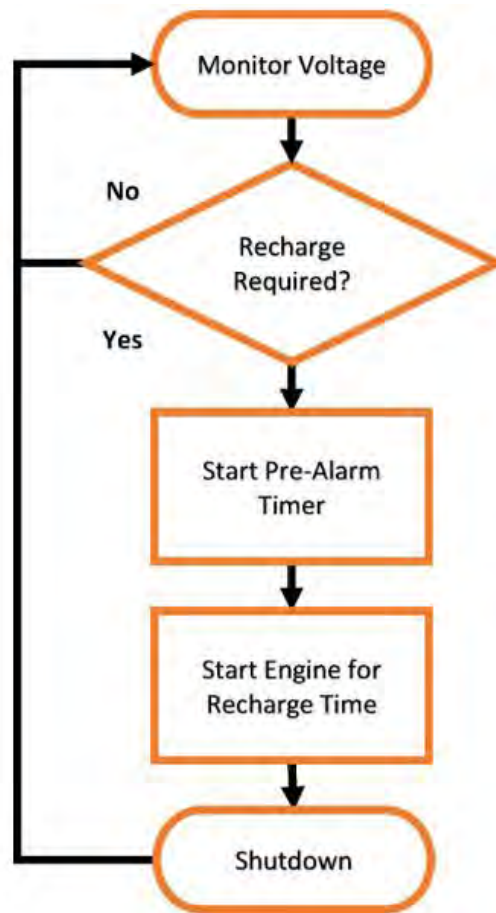

Battery Recharge Sequence

4.4.6 Auxiliary Sensors

The Auxiliary sensors are used for supporting custom sensors and triggering actions based on the sensor values. There are four auxiliary sensors.

Note: There is a fifth sensor – the Transducer Sensor (Auxiliary Sensor 5 in RapidCore) – that is similar to the Auxiliary Sensors. It is set in the Application Menu > Transducer Menu (or Sensors > Auxiliary Sensor 5 in RapidCore). The following menus are for the Auxiliary Sensors.

	<p>CAUTION</p> <p>YOU MUST USE THE RAPIDCORE CONFIGURATOR SOFTWARE TO PROGRAM A CUSTOM SENDER TABLE TO THE CONTROLLER FOR THE AUXILIARY SENSOR(S) THAT WILL BE USED. OTHERWISE "UNDEFINED SENSOR" WILL APPEAR MENU IN THE FRONT PANEL MENU SYSTEM. ONCE A SENDER TABLE IS PROGRAMMED TO THE CONTROLLER ALL THE OTHER SETTINGS CAN BE ADJUSTED FROM THE FRONT PANEL OF THE CONTROLLER.</p>
---	--



	ATTENTION
	<p>VOUS DEVEZ UTILISER LE LOGICIEL RAPIDCORE CONFIGURATOR POUR PROGRAMMER UN TABLEAU D'EMISSION PERSONNALISE SUR LE CONTROLEUR, POUR LE OU LES CAPTEURS AUXILIAIRES QUI SERONT UTILISES. SINON, LE MESSAGE « UNDEFINED SENSOR » (CAPTEUR NON-DEFINI) S'AFFICHERA DANS LE MENU DU PANNEAU DE COMMANDE. UNE FOIS QU'UN TABLEAU D'EMISSION EST PROGRAMME DANS LE CONTROLEUR, TOUS LES AUTRES PARAMETRES PEUVENT ETRE REGLES A PARTIR DU PANNEAU DE COMMANDE DU CONTROLEUR.</p>

(Sensors > Aux Sensor 1/2/3/4 menus)

Name	Range	Default	Description
Signal Source	Disable Port A Port B Port C Port D	Disable	The source from which to get the signal for the Aux Sensor. Any port can be used, even if it is used by another sensor or Aux Sensor. If the port is in use by other sensor, this is known as <i>overloading</i> the port.
Custom Sender (Configurator Software only)	-----	Undefined	The sender resistance / value curve must be programmed from the RapidCore Configurator Software even if the port is being overloaded. This tells the controller how to interpret the signal from the port. No front panel configuration is allowed until the sender curve is programmed to the controller.
Display	Enable Disable	-----	Determines if the sensor's value is displayed on the screen when the engine is running.



Name	Range	Default	Description
Active Mode	Disable Global Off Mode (Not in Auto) Auto Mode Running Cranking After Cranking Cooldown	----	<p>Determines under which operating conditions the Auxiliary Sensor is monitored. Multiple selections are allowed. Does not apply to “Start on Low” or “Start on High”; for those selections, the active mode is always Auto.</p> <p>Refer to the examples in the following pages for information on specific mode functions.</p> <ul style="list-style-type: none"> - Disable - Input cannot be triggered - Global - Input can be triggered at any time - Off Mode - Input can be triggered while in the Off Mode - Auto Mode - Input can be triggered while in the Auto Mode - Running - Input can be triggered after a start command is received until shutdown (cooldown not included) - Cranking - Input can be triggered during cranking - After Cranking - Input can be triggered after engine has started until shutdown - Cooldown - Input can be triggered while cooldown timer is active
Func. Select	Fault Monitor Output on Low Output on High Start on Low Start on High	----	<p>Determines how the controller responds to the readings of the Auxiliary Sensor.</p> <p>“x on Low” will turn on the output or start the controller if the sensor input falls below the Start Level.</p> <p>“x on High” will turn on the output or start the controller if the sensor input rises above the Start Level.</p>
Trim Offset	-50.0 ~ 50.0 units The units depend on the unit type of the programmed sender table -- °F, PSI, %, V, A	----	Calibrate a sensor by using the offset to correct errors.
Mode Settings > Bypass Time	0 ~ 90 s in 1 s increments	----	The amount of time to ignore the sensor input after the desired active mode is first entered. Once triggered, the bypass time does not apply again until the device resets (for example, transitioning from Run to the Off or Auto state) or on power-up.



Name	Range	Default	Description
Mode Settings > Run Time	Disable 1 ~ 6000 min* in 1 min increments	----	<p>(Only applies if Func. Select is not set to Fault Monitor) The amount of time to turn on the auxiliary switched output or run the controller before turning off the output or shutting down the controller.</p> <p>If the Run Time is disabled, then the start/output is held until the Stop Level is reached (if enabled) or until the controller is reset or powered down or, in the case of Start on Low / Start on High, until the user presses the OFF button.</p> <p>Note that the run time is not exact. Up to 10 seconds may be added to the beginning of the run time counter and up to 4 seconds to the end. The run time begins when a start request is received so crank time, preheat time, etc., are included in the Run Time.</p>
Mode Settings > Start Level	Disable Temperature: 32 ~ 999 °F in 1 °F increments Pressure: 1 ~ 6000 PSI in 1 PSI increments Level:	----	<p>(Only applies if Func. Select is not set to Fault Monitor) The level at which the auxiliary switched output turns on or the engine starts.</p> <p>If this is set to Disable, the Auxiliary Sensor action defined in Func. Select is disabled. The Auxiliary Sensor becomes display only (unless Func. Select is set to Fault Monitor).</p>
Mode Settings > Stop Level	1 ~ 99% in 1% increments Voltage: 0.1 ~ 99.9 V in 0.1 V increments Current: 1 ~ 999 A in 1 A increments		<p>(Only applies if Func. Select is not set to Fault Monitor) The level at which the auxiliary switched input turns off or the engine is stopped.</p> <p>If Stop Level is disabled, the start/output condition is maintained until the Run Time expires (if enabled) or until the controller is reset or powered down or, in the case of a start, until the user presses the OFF button.</p>
Setpoints > Low Warning			(Only applies if Func. Select is set to Fault Monitor) Reading at which a warning occurs.
Setpoints > Low Failure			(Only applies if Func. Select is set to Fault Monitor) Reading at which a failure occurs.
Setpoints > High Warning			(Only applies if Func. Select is set to Fault Monitor.) Reading at which a warning occurs.
Setpoints > High Failure			(Only applies if Func. Select is set to Fault Monitor.) Reading at which a failure occurs.
Timers > Trigger Delays Aux Sensors menu:			
Aux 1	1 to 3600 s in 1 s increments	5 s	<u>Func. Select is set to fault monitor:</u> Sets the amount of time to ignore the input for warning and
Aux 2			



Name	Range	Default	Description
Aux 3			failure detection purposes. No warnings or failures will be generated during this time.
Aux 4			"Func. Select" set to other than fault monitor: Sets the amount of time to delay a start or stop event. If set to larger than 4 s the stop delay portion is limited to 4 s. If the trigger for the start or stop event becomes unavailable during this time the time will be reset and the controller will wait for the next start/stop trigger. <u>Limitations:</u> For TG350/TG410 firmware versions below 1.88.01, the maximum range is 45 s.

* 1 ~ 600 min for firmware versions below 1.78.

If using *Output on Low* or *Output on High*, one of the switched outputs events must be set to one of the following, corresponding to the Auxiliary Sensor being configured per the following table.

(Switched I/O > Switched Out A/B/C/D/E/F > Events menus)

Name	Description
Aux Sensor 1	Used by the Auxiliary Sensor 1 <i>Output on Low</i> or <i>Output on High</i> feature.
Aux Sensor 2	Used by the Auxiliary Sensor 2 <i>Output on Low</i> or <i>Output on High</i> feature.
Aux Sensor 3	Used by the Auxiliary Sensor 3 <i>Output on Low</i> or <i>Output on High</i> feature.
Aux Sensor 4	Used by the Auxiliary Sensor 4 <i>Output on Low</i> or <i>Output on High</i> feature.

The display resolution of the auxiliary sensors that are displayed on the screen are different than the resolution used for the purpose of the comparisons that determine if the start level, stop level, low warning, etc., are in effect. The resolutions are given in the following table.

Sensor Unit Type	Comparison Resolution
Temperature	1 °F
Pressure	1 PSI
Level	1%
Voltage	0.1 V
Current	1 A

Example: If the Auxiliary Sensor 1 (Aux 1) is using a temperature sender curve, set to *Output on Low*, and the Start Level is set to 130 °F, then the Output will not turn on until the temperature drops to 129 °F since the resolution for comparisons is 1 °F.

The following tables gives all the possible actions that the auxiliary sensors can perform.



	Behavior	Func. Select	Start Level	Run Time	Stop Level
A - Indefinitely	Start controller when the sensor drops below a certain value. Run indefinitely. ¹	Start on Low	Set to value that the sensor needs to drop below to start.	Disable	Disable
	Turn on an output when the sensor drops below a certain value. Keep the output on indefinitely. ²	Output on Low	Set to value that the sensor needs to drop below to turn on the output.	Disable	Disable
	Start controller when the sensor rises above a certain value. Run indefinitely. ¹	Start on High	Set to value that the sensor needs to rise above to start.	Disable	Disable
	Turn on an output when the sensor rises above a certain value. Keep the output on indefinitely. ²	Output on High	Set to value that the sensor needs to rise above to turn on the output.	Disable	Disable
B - Fixed Duration	Start controller when the sensor drops below a certain value. Run for a fixed period of time and then stop controller.	Start on Low	Set to value that the sensor needs to drop below to start.	Set to the desired run duration.	Disable
	Turn on an output when the sensor drops below a certain value. Run for a fixed period of time and then turn off the output.	Output on Low	Set to value that the sensor needs to drop below to turn on the output.	Set to the desired duration to keep the output on.	Disable
	Start controller when the sensor rises above a certain value. Run for a fixed period of time and then stop controller.	Start on High	Set to value that the sensor needs to rise above to start.	Set to the desired run duration.	Disable
	Turn on an output when the sensor rises above a certain value. Run for a fixed period of time and then turn off the output.	Output on High	Set to value that the sensor needs to rise above to turn on the output.	Set to the desired duration to keep the output on.	Disable
C - Start Level / Stop Level	Start controller when the sensor drops below a certain value. Stop controller when the sensor rises above a certain value.	Start on Low	Set to value that the sensor needs to drop below to start.	Disable	Set to the value the sensor needs to rise above to stop the controller.



	Behavior	Func. Select	Start Level	Run Time	Stop Level
	Turn on an output when the sensor drops below a certain value. Turn off output when the sensor rises above a certain value.	Output on Low	Set to value that the sensor needs to drop below to turn on the output.	Disable	Set to the value the sensor needs to rise above to turn off the output.
	Start controller when the sensor rises above a certain value. Stop controller when the sensor drops below a certain value.	Start on High	Set to value that the sensor needs to rise above to start.	Disable	Set to the value the sensor needs to drop below to stop the controller.
	Turn on an output when the sensor rises above a certain value. Turn off output when the sensor drops below a certain value.	Output on High	Set to value that the sensor needs to rise above to turn on the output.	Disable	Set to the value the sensor needs to drop below to turn off the output.
D - Start Level / Stop Level with Timeout	Start controller when the sensor drops below a certain value. Stop controller when the sensor rises above a certain value. Stop the controller after a fixed time if the stop level is not reached.	Start on Low	Set to value that the sensor needs to drop below to start.	Set to the desired maximum run duration (i.e., this is the timeout).	Set to the value the sensor needs to rise above to stop the controller.
	Turn on an output when the sensor drops below a certain value. Turn off output when the sensor rises above a certain value. Turn off the output after a fixed time if the stop level is not reached.	Output on Low	Set to value that the sensor needs to drop below to turn on the output.	Set to the desired maximum duration to keep the output on (i.e., this is the timeout).	Set to the value the sensor needs to rise above to turn off the output.
	Start controller when the sensor rises above a certain value. Stop controller when the sensor drops below a certain value. Stop the controller after a fixed time if the stop level is not reached.	Start on High	Set to value that the sensor needs to rise above to start.	Set to the desired maximum run duration (i.e., this is the timeout).	Set to the value the sensor needs to drop below to stop the controller.



	Behavior	Func. Select	Start Level	Run Time	Stop Level
	Turn on an output when the sensor rises above a certain value. Turn off output when the sensor drops below a certain value. Turn off the output after a fixed time if the stop level is not reached.	Output on High	Set to value that the sensor needs to rise above to turn on the output.	Set to the desired maximum duration to keep the output on (i.e., this is the timeout).	Set to the value the sensor needs to drop below to turn off the output.
E - Warnings / Failures	Trigger warnings and/or failures on the sensor.	Fault Monitor	N/A	N/A	N/A
F - Display only	Do not perform any actions based on the sensor value. Just display the value to the user.	Fault Monitor (Disable all warnings and failures)	N/A	N/A	N/A

¹ The user must manually stop the controller by pressing the OFF button.

² The controller must be either

- Powered down, or
- A reset initiated by
 - Going from the Run Mode to the Auto or Off Mode, or
 - Changing a setting in the menu and exiting the menu system

4.4.6.1 *Fault Monitor Example*

In this example, a sensor is monitoring the temperature of an engine block. If the temperature rises above 275 °F, a warning message is displayed. If the temperature rises above 350 °F, the engine shuts down and a failure message is displayed.

Relevant Settings

Setting	Value
Signal Source	Same as Engine Temperature
Display	Disable (if enabled, controller will display Engine Temperature twice)
Sensor Type	Same as Engine Temperature
Sensor Table Name	Engine Temp.
Active Range	Running
Mode Select	Fault Monitor
Setpoints > Low Warning	Disabled



Setting	Value
Setpoints > Low Failure	Disabled
Setpoints > High Warning	275 °F
Setpoints > High Failure	350 °F

The following chart shows the connection between engine temperature and time. At approximately 13 minutes run time, the temperature rises above the 275 °F warning threshold, activating the warning display. The engine will continue to run because it has not reached the 350 °F failure threshold. At 20 minutes run time, the temperature falls below the warning threshold, and the warning disappears.

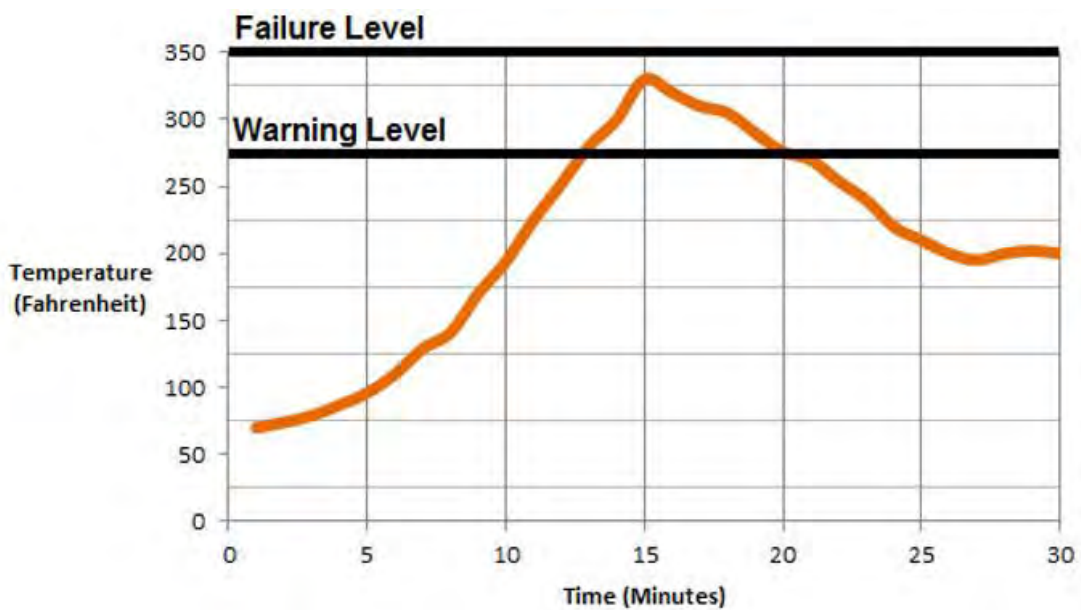

4.4.6.2 Start on Low Example

In this example, a sensor is monitoring the voltage of an external battery bank. If the voltage falls below 10.5 V, the engine will start and run for 40 minutes to charge the battery.

Relevant Settings

Setting	Value
Signal Source	Sensor Port X
Display	Enable
Sensor Type	Custom
Sensor Table Name	Battery Bank
Active Range	N/A (these ranges are fixed for Start on Low / High)



Setting	Value
Mode Select	Start on Low
Mode Settings > Active Time	40 min
Mode Settings > Start Level	10.5 V
Mode Settings > Stop Level ¹	Disabled

¹Stop Level needs to be disabled when the engine is running because the battery voltage will equal the alternator charging voltage. Disabling this will force the engine to run for the entire duration of the active time.

The following chart shows the connection between a battery bank and time. At approximately 80 minutes time, the voltage falls below the 10.5 V start threshold, causing the engine to start. The engine runs for the 40 minutes of active time, regardless of the voltage reading, and then shuts down.

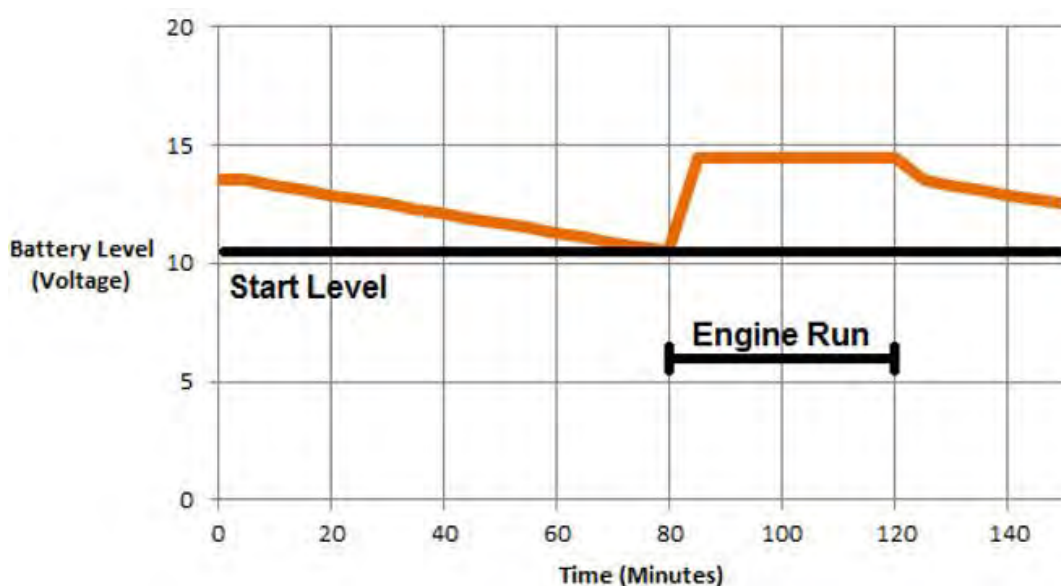

4.4.6.3 Output on High Example

In this example, a sensor is monitoring the temperature of an engine. If the temperature rises above 325 °F, a fan will turn on to cool the engine. Once the temperature drops to below 200 °F, the fan will turn off.

Relevant Settings (Auxiliary Sensor)

Setting	Value
Signal Source	Same as Engine Temperature
Display	Disable (if enabled, controller will display Engine Temperature twice)
Sensor Type	Same as Engine Temperature
Sender Table Name	Engine Temp.
Active Range	Global



Setting	Value
Mode Select	Output on High
Mode Settings > Active Time ¹	Disabled
Mode Settings > Start Level	325 °F
Mode Settings > Stop Level	200 °F

¹Active time is disabled because the fan needs to stay on indefinitely or until 200 °F is reached.

Relevant Settings (Switched Outputs)

Setting	Value
Switched Output X	Auxiliary Sensor X (choose based on which Auxiliary Sensor is being used)

The following chart shows the connection between engine temperature and time. At approximately 10 minutes run time, the temperature rises above the 325 °F start threshold and the fan turns on. The fan continues to run as the temperature declines. When the temperature falls below the 200 °F stop threshold, the fan turns off.

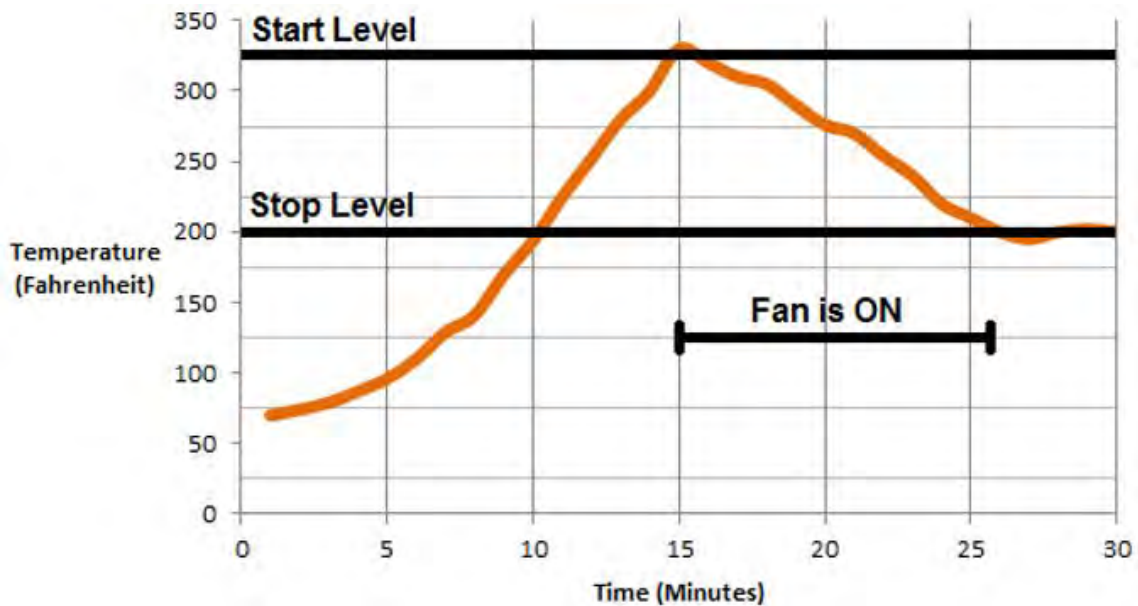

4.4.7 Custom Sender Tables

Custom Sender Tables are created using the RapidCore Configurator Software when using a sensor that is not supported by Cattron. The Configurator Software has the ability to create these custom tables, allowing the controller to properly read the sensor data.

	CAUTION
	CUSTOM SENDER TABLES CAN ONLY BE CREATED WHEN USING THE CONFIGURATOR SOFTWARE.

	ATTENTION
	LES TABLEAUX D'EMISSION PERSONNALISES NE PEUVENT ETRE CREES QU'AVEC LE LOGICIEL CONFIGURATOR.

Parameter	Description
Name	The label that will be displayed in the controller (Engine Temp, Oil Pressure, etc.).
Input Type	Choose resistance, voltage or current based on the sensor type. Use the Terminal Descriptions section to determine if your sensor is compatible with a sensor port.
Unit Type	Choose temperature, pressure, voltage, current or percentage based on the sensor. This defines what unit of measurement will be displayed on the front panel (°F, PSI, V, A, %).

The following example outlines the steps for creating a custom sender table:

1. Navigate to the sensor input that will be using your custom sender table.
2. Select a Name, Input Type and Unit Type for the controller (definitions in the table above).
3. Click the check box next to 'Build Table' (Step 1 in the following image).
4. From the 'Sender' drop-down menu, select 'Custom' (Step 2 in the following image).
5. Click the 'Edit' button next to the drop-down menu (Step 3 in the following image).
6. Enter the sensor values. Once entered, click Apply, then OK.



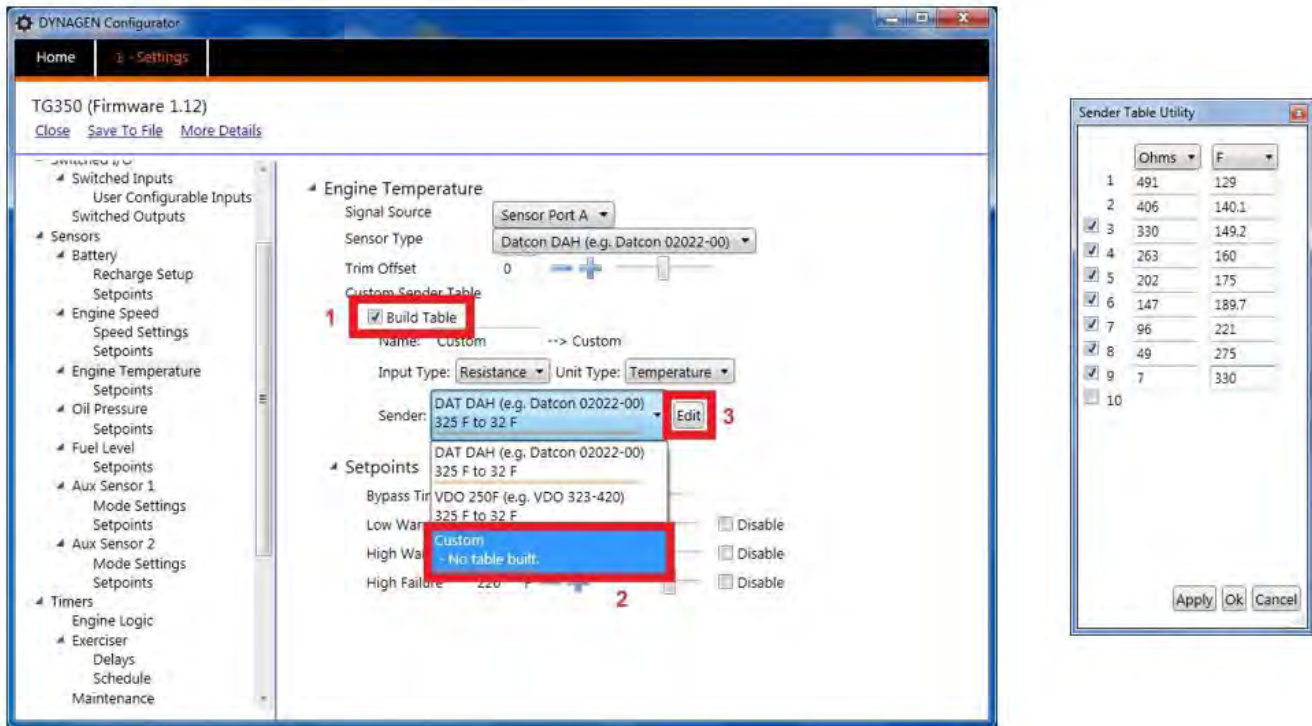

4.5 Timers

The controller has an internal clock which is used not only to keep time, but also to ensure that programmed events happen at the correct times. The following sections are used to configure settings associated with timing functions.

	CAUTION
	THE CONTROLLER HAS AN ON-BOARD BACKUP BATTERY TO KEEP TIME EVEN WHEN THE MAIN POWER IS NOT SUPPLIED TO THE UNIT. THIS BATTERY HAS AN UNPOWERED (NO MAIN POWER) LIFETIME OF APPROXIMATELY FIVE YEARS.

	ATTENTION
	LE CONTROLEUR DISPOSE D'UNE BATTERIE DE SECOURS INTEGREE, QUI PERMET DE CONSERVER L'HEURE MEME QUAND L'UNITE N'EST PAS CONNEXE A L'ALIMENTATION PRINCIPALE. CETTE BATTERIE A UNE DUREE DE VIE D'ENVIRON CINQ ANS SANS ALIMENTATION (EN L'ABSNECE D'ALIMENTATION PRINCIPALE).

4.5.1 Engine Logic

The following settings determine how the controller starts and stops the engine. It gives the user the functionality to add delays and timers to the sequences. Most of the settings have a switched output associated with them that must be set in the settings for [Switched Outputs](#).



	CAUTION
	SETTING A TIMER'S VALUE TO 0 SECONDS WILL DISABLE THE TIMER. FOR EXAMPLE, IF DELAY TO START IS SET TO 0 S, THE CONTROLLER WILL NOT PERFORM A DELAY TO START WHEN STARTING THE ENGINE.

	ATTENTION
	REGLER LA MINUTERIE SUR 0 SECONDE A POUR EFFET DE LA DESACTIVER. PAR EXEMPLE, SI DELAY TO START (RETARD AU DEMARRAGE) EST REGLE SUR 0 S, LE CONTROLEUR N'APPLIQUERA PAS DE RETARD AU DEMARRAGE LORS DU DEMARRAGE DU MOTEUR.

Timers > Engine Logic:

Name	Range	Default	Description
Delay to Start	0 ~ 90 s	0 s	Amount of time to delay the starting of the engine after receiving a command to start.
DTS Manual Run (Delay to Start on Manual Run)	Disable Delay or Enable Delay	Enable Delay	Determines if the Delay to Start timer is used when the front panel RUN button is used to start the engine.
Preheat Mode	Preheat Timer Switched Input J1939	Preheat Timer	Determines the method used to control enabling the Glowplug output. See the Preheat Mode section for more information.
Preheat Time	0 ~ 1200 s 0 ~ 90 s in firmware versions below 1.33	0 s	Amount of time the <u>Glowplug output</u> is active before cranking the engine. Used on diesel engines to warm the engine before cranking.
Crank Time	3 ~ 30 s	10 s	Amount of time the <u>Crank output</u> is active before going to crank rest. This timer immediately expires upon successful cranking.
Midheat Time	0 ~ 90 s	0 s	Keeps <u>Glowplug output</u> turned on while cranking but not during crank rest. Output will turn off upon crank failure, crank success or midheat time expiration.
Crank Rest Time	1 ~ 90 s	15 s	Amount of time to delay between each attempt to start the engine.
Crank Attempts	1 ~ 20	3	Number of attempts to start the engine before going to an overcrank failure.
Fuel In Rest (Fuel Crank Rest)	Fuel ON or Fuel OFF	Fuel ON	Determines if the fuel output stays on during the crank rest time.



Name	Range	Default	Description
RPM Disconnect	100 ~ 2000 RPM	650 RPM	Speed at which controller determines the engine has started successfully and turns off the <u>Crank output</u> .
Postheat Time	0 ~ 90 s	0 s	Amount of time the <u>Glowplug output</u> remains on after crank success and the engine is running.
False Restart (Restart on False Start)	Enable false start (engine stall) detection. Refer to the False Restart section.		
False Check (False Restart Detect Time)			
Engine Stall	Enable Disable	Disable	If enabled, after the false restart delay and if the engine speed goes below the crank disconnect setting, (1) disables oil pressure shutdown, and (2), after two seconds the controller will shut down on an "engine stall" failure. This prevents an erroneous low oil pressure, under speed, or under frequency failure. Available in firmware version 1.87 and above.
Warmup Time	0 ~ 600 s in 5 s increments	0 s	After successful cranking, engine delays this amount of time before turning on the <u>Warmup output</u> . This allows the engine to warm up before applying any load to it. The output will turn off when the controller enters the Cooldown Delay.
OFF Button Function	Cooldown Shutdown Force Cooldown	Shutdown	The function the OFF button on the front panel performs while engine is running. See the OFF Button Function section for more information.
Cooldown Time	0 ~ 6000 s in 5 s increments	0 s	Amount of time to cool down the engine after a stop command has been received. During this time the <u>Warmup output</u> turns off and the <u>Cooldown output</u> turns on. If another start command is received during cool down, the controller will return to Running Mode.



Name	Range	Default	Description
ETS On Duration (Energize to Stop)	0 ~ 30 s	0 s	Amount of time the <u>Energize to Stop (ETS) output</u> is on after the engine has shut down. Time must be greater than 0 s for the Energize to Stop function to work. As of TG350/TG410 version 1.88, the OFF button is disabled during ETS to prevent possible issues with the engine failing to shut down. If controller still detects speed (RPM) above 600 RPM in the last two seconds, it goes to a ' Failed to Stop ' failure.
Warm-up Idle	Idle options. See the Idle section for more information.		
Idle Settings			
Cooldown Idle			
Auto Idle Link			

4.5.1.1 Preheat Mode

The controller has the ability to control the length of the preheat time through three different methods. The following table describes each method.

Preheat Mode Settings (under Timers > Engine Logic menu)

Mode	Description
Preheat Timer	This mode uses the Preheat Time setting in the Engine Logic menu.
Switched Input	This mode uses a switched input set to 'ECM Preheat' to determine when to exit preheat. The preheat time (in Engine Logic) must be set to a minimum of 5 seconds for this input to work. If the switched input is or becomes active when the preheat timer is counting down, the controller displays 'ECM Preheating' on the screen after the preheat counter has finished its countdown. Cranking begins when the 'ECM Preheat' switched input is no longer active.
J1939	This mode uses commands sent from the ECM over J1939 to decide when to exit preheat.

	CAUTION
	DURING PREHEAT, THE GLOWPLUG SWITCHED OUTPUT IS ON (IT NEEDS TO BE SET TO A SWITCHED OUTPUT – SEE SWITCHED OUTPUTS).

	ATTENTION
	PENDANT LE PRECHAUFFAGE, LA SORTIE COMMUTEE GLOWPLUG (VOYANT DE PRECHAUFFAGE) EST ACTIVEE (ELLE DOIT ETRE PARAMETREE EN SORTIE COMMUTEE - VOIR SWITCHED OUTPUTS (SORTIES COMMUTEES)).



4.5.1.2 False Restart

The false restart feature is used to monitor and recover from unsuccessful crank attempts where the speed did go above the crank disconnect and the controller is in the Run Mode. For example, the engine might have stalled shortly after cranking.

False Restart Settings (under Timers > Engine Logic)

Name	Range	Default	Description
False Restart (Restart on False Start)	Enable Disable	Disable	Determines if the controller will monitor for false starts and attempt a restart. Controller will only attempt restarting the engine as many times as determined by Crank Attempts.
False Check (False Restart Detect Time)	5 ~ 30 s in 1 s intervals	8 s	Amount of time after successful cranking to monitor for a false restart. A false restart is defined as the speed dropping below 250 RPM for 2 seconds. If this time expires and the engines stalls out, the controller will not attempt a restart. This time starts from crank success.

Tip: It takes up to 2 seconds for the false restart to be triggered. In addition, it takes time for the engine speed to drop below 250 RPM. These should be measured and added to the desired False Check setting.

For example, when the speed is disconnected, it takes approximately 2.5 s for the speed sensing to record 0 RPM when the speed sensing is set to a magnetic input at a speed of 3200 Hz/1800 RPM. This totals 4.5 s when you include the 2 s for the false restart delay. So, if the desired monitoring period is 10 s, the False Check setting should be set to 15 s.

4.5.1.3 OFF Button Function

The OFF button on the front panel of the controller can be configured to function in three different ways while the engine is running. The following table describes each of these functions.

Function	Description
Cooldown	This function causes the controller to go into cooldown. Pressing the OFF button again will cause the engine to shut down.
Shutdown	This function bypasses cooldown and causes the engine to shut down.
Force Cooldown	This function causes the controller to activate the cooldown process. Pressing the OFF button will have no effect as the controller is forcing the engine to perform a full cool down.

	WARNING
	IF THE CONTROLLER RECEIVES A COMMAND TO START FROM THE REMOTE START OR FRONT PANEL RUN BUTTON WHILE IN COOLDOWN, IT WILL LEAVE THE COOLDOWN MODE AND GO BACK TO RUNNING MODE.



	AVERTISSEMENT
	<p>SI LE CONTROLEUR REÇOIT UNE COMMANDE DE DEMARRAGE A PARTIR DE LA COMMANDE DE DEMARRAGE A DISTANCE, OU DU BOUTON RUN (MARCHE) DU PANNEAU DE COMMANDE ALORS QU'IL EST EN MODE COOLDOWN (REFROIDISSEMENT), IL QUITTERA LE MODE COOLDOWN (REFROIDISSEMENT) ET REVIENDRA AU MODE RUNNING (MARCHE).</p>

4.5.1.4 Idle

The controller ignores under speed, voltage and frequency warnings and failures when active. If using J1939, the controller will broadcast TSC1 as the Idle Speed parameter found in the [Engine Speed](#) section.

This section explains the general Idle functionality. There are three ways to use Idle, as follows:

- [Warmup Idle](#) – Automatically enter the Idle Mode during warmup for a period of time before going to rated speed; see [Warmup Idle](#)
- [Cooldown Idle](#) – Idle automatically during cool down; see below
- [Idle Switched Input](#) – Idle whenever this switched input is active; see the Idle Mode function under [Switched Inputs](#)

Name	Parent Menu	Range	Default	Description
Warmup Idle	Timers > Engine Logic	Disable Warm-up Timer Oil Temp. Engine Temp.	Refer to the Warmup Idle section.	
Idle Settings	Timers > Engine Logic	[Menu]		
Cooldown Idle	Timers > Engine Logic	Disable Enable	Disable	Idle during cooldown.
Auto Idle Link	Timers > Engine Logic	Disable Breaker Trip	Disable	If set to breaker trip, the breaker trip will be activated whenever the controller is in the Idle Mode. The breaker trip will be turned off when Idle Mode is exited if it was not in the latched state. If the user de-latches the breaker trip output while Auto Idle is active, the breaker trip will turn off for 1 second and then turn back on.

Idle Switched Output

A switched output can be set to Idle to turn on whenever Idle Mode is entered. This is useful for electronic governors that have an idle input to tell the governor to run the engine at idle speed. Note that the switched outputs are meant to drive relays, so a relay must be installed to do the logic for the governor.



4.5.1.4.1 Warmup Idle

This section explains the Warmup Idle functionality.

The Warmup Idle is used to run the engine at a reduced speed at engine start.

Name	Parent Menu	Range	Default	Description
Warmup Idle	Timers > Engine Logic	Disable Warm-up Timer Oil Temp. Engine Temp.	Disable	If enabled, the engine is placed in Idle Mode during the warm-up period. <u>Warm-up Timer</u> – The engine idles during the duration of the warm-up timer countdown. <u>Oil Temp.</u> – The oil temperature over J1939 is used to determine the extent of the Warm-up / Idle period. <u>Engine Temp.</u> – Same as Oil Temp. but the engine temperature is used. The engine temperature can come locally or from J1939. The oil temp and engine temp selections use the Debounce, Low Point, and High Point settings below.
Debounce	Timers > Engine Logic > Idle Settings	1 to 10 s, in 1 s increments	10 s	(Warmup Idle) If the temperature remains between the “Low Point” and “High Point” settings for this time, exit the warm-up / idle.
Low Point	Timers > Engine Logic > Idle Settings	1 to 180 °F, in 1 °F increments	32 °F	(Warmup Idle) Continue to idle when the temperature is below this setting. Ignore the Debounce.
High Point	Timers > Engine Logic > Idle Settings	1 to 180 °F, in 1 °F increments	50 °F	(Warmup Idle) Always exit idle when the temperature is above this setting.

4.5.1.4.2 Idle Inhibit

Use this feature to prevent start up when the Idle Mode switch is active.

Settings (Other Config > Idle Inhibit, in the Configurator Software; these are under the switched inputs when the idle input is enabled)

Name	Parent Menu	Range	Default	Description
Remote Start (Start / Stop Switched Input Inhibit)	Other Config > Idle Inhibit	No Inhibit Inhibit	No Inhibit	Prevent the remote start switch input from starting the engine when the idle switch is active.
Aux Start (Aux 1, 2, 3, 4 Sensor AutoStart Inhibit)	Other Config > Idle Inhibit	No Inhibit Inhibit	No Inhibit	Prevent Auxiliary 1, 2, 3, and 4 sensors AutoStart feature from starting the engine when the idle switch is active.



If the engine is in the Idle Mode because of the [Warmup Idle](#) feature, the remote start (start/stop) and auxiliary sensors AutoStart can still start the engine.

This prevents starting when the Idle switch is active in the Auto Mode. This will also shut down the engine if the idle switched input is activated when the controller is in the delay to start, preheat, cranking, and crank reset states. The main purpose is to prevent a remote start if the idle switch was accidentally left on.

4.5.2 Schedulers

4.5.2.1 Exerciser

The Exerciser function is used to start and run the engine periodically. The following settings configure the Exerciser function.

Exerciser Settings (in the Timers menu)

Name	Range	Default	Description
Enable	Enable Disable	Disable	Enables the exerciser feature.
Delays > Pre-Alarm	1 ~ 20 min	5 min	Amount of time to display a warning before starting the engine.
Delays > Run Time	10 ~ 1500 min	30 min	Amount of time to run the engine.
Schedule > Start Date	1 ~ 31	8	The day of the month for the first exerciser run. This setting is only used to set the first exerciser run. All subsequent exerciser runs use the Repeat Days setting to determine when they should run. If the date and time selected has already gone by for the current month, then the exerciser will be started on the given date in the next month. Also, if the date has not yet occurred, but the current month does not have that date (for example, it is February 21 and a date of 31 has been selected), then the exerciser will run in the next month to have that date (March 31).
Schedule > Start Hour	0 ~ 23	12	The time of day for the exerciser run. If the "Pre-Alarm" setting above is non-zero, then this setting indicates when the pre-alarm warning countdown will begin. The controller will start after the pre-alarm countdown is finished.
Schedule > Repeat Days	1 ~ 28 days	14	Number of days between each exerciser cycle. This setting is applied to all subsequent exerciser starts after the first start.



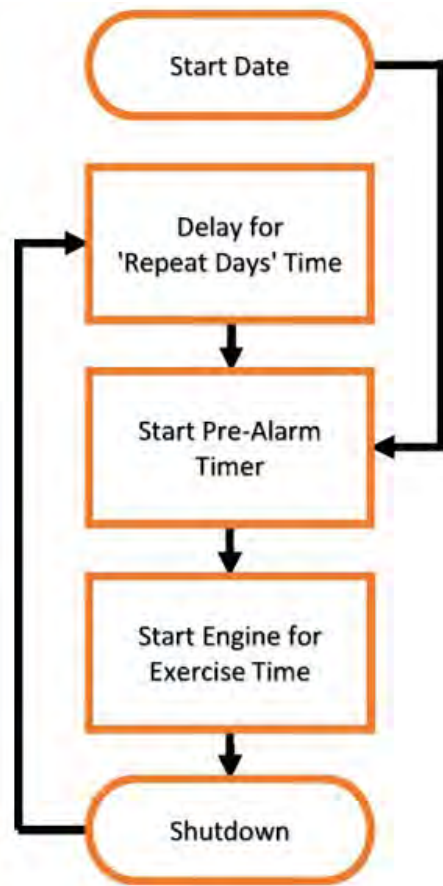

Exerciser Sequence

If the controller is in the Off Mode, if the emergency stop is activated, or if the start inhibit is active, then the exerciser will not run. The event “Bypass Exerciser” will be logged in the Events History and the exerciser will run again at the next scheduled time as determined by the “Repeat Days” setting.

4.5.2.2 Week Scheduler

The weekly scheduler allows up to 16 unique weekly exercise times to be created. By default, all schedulers are disabled.

Timers > Week Scheduler

Name	Range	Description
Weekday	Sunday ~ Saturday	The day of the week on which the exercise will take place.
Start time	24-hour clock in 1 min increments	The time at which the exercise should start on the given day. At the selected time, a one-minute pre-alarm is displayed on the LCD screen. The controller starts after this one-minute period.
Run time	10 ~ 1440 min in 1 min increments	The duration of the exercise run period. Up to one day.



When entering the Week Scheduler menu, there will be 16 sub menu items, each corresponding to one of the 16 weekly exercise times. If disabled, the entry will have dashed lines, as shown here: “-----”. If enabled, the day of week, start time, and duration will be displayed for the menu. Pressing Enter will enter the sub menu for that exerciser time.

It is recommended that the RapidCore Configurator Software be used to enter the times as this provides a much more convenient interface, especially if daily exercise times are wanted.

4.5.2.3 Long Time Run

The Long Time Run counter can be used to shut down the controller after a very long period of time. This is useful for remote primary power applications where the user wants to divide run time between two generators. When the countdown expires, the controller will shut down. Long Time Run is only active if the generator was started manually (i.e., by pressing the front RUN button).

Timers > Long Time Run

Name	Range	Default	Description
Start Trigger	Disable Manual Start	Disable	Set to “Manual Start” to enable the Long Time Run feature.
Run Duration	1 ~ 5000 hr in 1 hr increments	1 hr	The amount of time to run before shutting down.

4.5.3 Maintenance

The controller has the ability to count down the time between scheduled maintenance events. Once maintenance is required, the controller will alert the operator via the LCD screen and a switched output (if enabled) wired to a lamp / horn / buzzer. The following settings are used to configure the maintenance timer.

Timers > Maintenance

Name	Range	Default	Description
Reset Counter	Yes or No	----	Once the maintenance count interval expires, use this to reset the time and turn off the switched output (if enabled). Select Yes to reset the counter and exit the menu. Select No to exit the menu without resetting the counter.
Enable Counter	Enable Disable	Disable	Enables or disables the maintenance function.
Count Interval	10 ~ 9990 hr in 5 hr increments	1000 hr	Determines the number of hours between required maintenance. A switched output can be configured to turn on once the count interval expires.

To determine the amount of time until the next scheduled maintenance, follow these menu steps:

Main Menu > Device Info. > Maintenance



The maintenance counter is disabled if “---” is displayed. A negative number indicates the amount of time since the maintenance timer expired.

Note: The maintenance timer displays “Service Required” when this time expires. This message is only displayed the next time the controller enters the Run Mode. If the timer expires when the controller is in the Run Mode, the message is not displayed.

4.6 AC Monitor

The controller has the ability to monitor AC voltage from a generator. The following sections are used to configure settings associated with AC monitoring.

4.6.1 Generator Voltage

The following settings are used to configure the controller’s response to voltage measurements.

AC Monitor > Genset Voltage menu

Name	Range	Default	Description
Voltage Source	Disable 2-Wire Single 3-Wire Single 3-Wire 3-Phase 4-Wire 3-Phase 4-Wire Delta Auto Selection	3-Wire Single	The wiring configuration of the generator. Disable will disable AC voltage and AC frequency sensing and display. <u>2-Wire Single:</u> One 120 VAC L-N. Use phase A. <u>3-Wire Single:</u> 120/240 VAC systems. Use phases A and B. <u>3-Wire 3-Phase:</u> Three phase delta without a ground. <u>4-Wire 3-Phase:</u> Three phase Wye system. Center taped ground. <u>4-Wire Delta:</u> Delta with a ground. The high leg is phase B. For example, if A-N and C-N read 120 VAC, then B-N will read 208 VAC. <u>Auto Selection:</u> Selecting Auto Selection will use the Voltage Select switched inputs to determine the wiring configuration. This setting also enables the AC Frequency monitoring and display.
Scaling Factor	0.500 ~ 2.500 in 0.001 increments	1.000	The gain to apply to the AC voltage that is read at the controller. See below for more information.
Nominal Volts	50 ~ 800 VAC* in 1 VAC increments	240 VAC	Generator line-to-line voltage output when operating under normal running conditions.
Auto Nominal > 1Ph 3-Wire (1-Phase 3-Wire)	50 ~ 800 VAC* in 1 VAC increments	240 VAC	Nominal Volts when using the Voltage Select inputs.



Name	Range	Default	Description
Auto Nominal > 3-Phase (1)	50 ~ 800 VAC* in 1 VAC increments	208 VAC	
Auto Nominal > 3-Phase (2)	50 ~ 800 VAC* in 1 VAC increments	480 VAC	
Auto Nominal > 3-Phase (3)	50 ~ 800 VAC* in 1 VAC increments	600 VAC	
Auto Scaling > 1Ph 3-Wire (1-Phase 3-Wire)	0.500 ~ 2.500 in 0.001 increments	1.000	Scaling Factor when using the Voltage Select inputs.
Auto Scaling > 3-Phase (1)	0.500 ~ 2.500 in 0.001 increments	1.000	
Auto Scaling > 3-Phase (2)	0.500 ~ 2.500 in 0.001 increments	1.000	
Auto Scaling > 3-Phase (3)	0.500 ~ 2.500 in 0.001 increments	1.000	
Auto Single	A-C Phase A-B Phase	A-B Phase	For 1-Phase 3-Wire when using the Voltage Select inputs. This determines the phases from which the single-phase voltage is read.
Setpoints > Low Warn	50 ~ 99% in 1% increments	90%	Reading at which a warning occurs.
Setpoints > Low Fail	50 ~ 99% in 1% increments	85%	Reading at which a failure occurs.
Setpoints > High Warn	101 ~ 150% in 1% increments	110%	Reading at which a warning occurs.
Setpoints > High Fail	101 ~ 150% in 1% increments	115%	Reading at which a failure occurs.

	CAUTION
	* 800 VAC APPLIES TO SOFTWARE LOGIC ONLY. DO NOT EXCEED 600 VAC ON THE AC VOLTAGE TERMINALS INCLUDING DURING OVER VOLTAGE WARNING AND FAILURE CONDITIONS.

	ATTENTION
	* 800 VCA NE S'APPLIQUE QU'A LA LOGIQUE LOGICIELLE. NE DEPASSEZ PAS 600 VCA SUR LES BORNES DE TENSION CA, Y COMPRIS EN SITUATION D'AVERTISSEMENT DE SURTENSION OU DE DEFAILLANCE.



Application Note: Scaling Factor

The scaling factor setting can be used to calibrate the AC voltage if there are discrepancies between the reading and the actual value. It can also be used if transformers are used to step up / down the voltage. The scaling factor applies to all phases in a system.

Example: The voltage source is a 3-Wire 3-Phase system with a nominal voltage of 208 VAC. The controller is reading 206.3 VAC, but a calibrated multimeter gives 208.3 VAC. Use the formula below to determine the scaling factor.

$$\text{Scaling Factor} = \text{Multimeter Reading} / \text{Controller Reading}$$

$$\text{Therefore, Scaling Factor} = 208.3 \text{ VAC} / 206.3 \text{ VAC}$$

$$\text{Scaling Factor} = 1.010$$

4.6.1.1 AC Voltage Select

The controller has the ability to automatically change its AC sensing (voltage and current) and display configuration through the use of switched inputs. When using voltage select, the controller will continue to monitor the inputs for 10 seconds after crank success. Once that time expires, the controller will then display the selected voltage configuration.

The following must be set:

1. Two switched inputs (Switched I/O > Switched IN X > Function) must be set to the *Volt Select 1* and *Volt Select 2* switch input functions
2. AC Monitor > Genset Voltage > Voltage Source must be set to *Auto Selection*. Rapid Configurator Software note: this option will not appear unless Step 1 is performed

The following table shows the relationship between the switched inputs' status and the voltage configuration.

Volt Select 1 Input	Volt Select 2 Input	Voltage Configuration
Inactive	Inactive	3-Wire Single Phase
Active	Inactive	3-Phase (1)
Inactive	Active	3-Phase (2)
Active	Active	3-Phase (3)

	CAUTION
	BOTH <i>VOLT SELECT 1</i> AND <i>VOLT SELECT 2</i> MUST BE ASSIGNED TO SWITCHED INPUTS. OTHERWISE, THE VOLTAGE SENSING WILL BE DISABLED.

	ATTENTION
	<i>VOLT SELECT 1</i> (SELECTION TENSION 1) ET <i>VOLT SELECT 2</i> (SELECTION TENSION 2) DOIVENT TOUS DEUX ETRE AFFECTES A DES ENTREES COMMUTEES. SINON, LA DÉTECTION DE TENSION SERA DÉACTIVÉE.

The following settings must be set. All except “Auto Single” are menus that contain four settings corresponding to the Volt Select 1 / Volt Select 2 inputs above.



Name	Volt Select 2 Input
Genset Voltage > Auto Nominal	These settings correspond to the “Nominal Volts” setting under the AC Monitor > Genset Voltage menu.
Genset Voltage > Auto Scaling	These settings correspond to the “Scaling Factor” setting under the AC Monitor > Genset Voltage menu.
Genset Voltage > Auto Single	Only applies when voltage source is set to 1-Phase 3-Wire. This determines the phases from which the single phase voltage is read: A-C or A-B.
Genset Current > Auto Rated	These settings correspond to the “Rated Amps” setting under the AC Monitor > Genset Current menu.
Genset Current > Auto Scaling	These settings correspond to the “Scaling Factor” setting under the AC Monitor > Genset Current menu.

4.6.2 Generator Frequency

Generator AC frequency display on the controller is enabled when the [Voltage Source](#) is not set to Disable.

The following settings are used to configure the controller’s responses to frequency measurements.

Frequency Settings (in AC Monitor > Genset Freq)

Name	Range	Default	Description
Freq. Source	50 Hz System (50 Hz) 60 Hz System (60 Hz) Auto Selection	60 Hz System	This is the wiring configuration of the generator. Selecting Auto Selection will use the RPM / Frequency Select input to determine which frequency is used. This setting is used by the following setpoints. It does not affect the display of AC Frequency.
Setpoints > Low Warn (Under-Frequency Warning)	Disable 20 ~ 99% in 1% increments	90%	Reading at which a warning occurs.
Setpoints > Low Fail (Under-Frequency Failure)	Disable 20 ~ 99% in 1% increments	85%	Reading at which a failure occurs.
Setpoints > High Warn (Over-Frequency Warning)	Disable 101 ~ 150% in 1% increments	110%	Reading at which a warning occurs.
Setpoints > High Fail (Over-Frequency Failure)	Disable 101 ~ 150% in 1% increments	115%	Reading at which a failure occurs.

4.6.2.1 RPM / Frequency Select

The controller has the ability to change between Primary RPM / 60 Hz and Secondary RPM / 50 Hz through the use of a switched input.





The following settings must be set in order for this feature to function.

- Switched I/O > Switched In A/B/C/D/E > Function > RPM Switch (Primary RPM / 60 Hz - Secondary RPM / 50 Hz Select). The switched input is only monitored before a start signal has been received. Once a start signal has been received, changing the status of the switched input will have no effect
- AC Monitor > Genset Freq. > Freq. Source > Auto Selection
- Sensors > Engine Speed > RPM Switch > Primary (Primary RPM / 60 Hz)
- Sensors > Engine Speed > RPM Switch > Secondary (Secondary RPM / 50 Hz)

The following table shows the relationship between the switched input status and the RPM / Frequency.

Switched Input	Speed / Frequency
Inactive	Primary RPM / 60 Hz
Active	Secondary RPM / 50 Hz

	CAUTION
	IF ENABLED, THE J1939 TSC1 PGN WILL BE BROADCASTED ACCORDING TO THE SELECTED SPEED. OTHERWISE, ONLY THE WARNING AND FAILURE SETPOINTS ARE AFFECTED BY THIS FUNCTION.

	ATTENTION
	S'IL EST ACTIVE, LE PGN J1939 TSC1 SERA DIFFUSE SELON LA VITESSE SELECTIONNEE. DANS LE CAS CONTRAIRE, SEULS LES POINTS DE CONSIGNE D'AVERTISSEMENT ET DE DEFAILLANCE SONT AFFECTES PAR CETTE FONCTION.

4.7 Communications

The controller has the ability to communicate with other systems over communication buses. The following sections relate to settings associated with communications.

4.7.1 CANbus (J1939)

This page gives a very short overview of J1939 support (electronic engines). For detailed information about J1939 and all related settings, please refer to the J1939 Reference Manual, which can be found at www.cattron.com.

Name	Range	Default	Description
ECM Model	Generic J1939 John Deere JDEC Volvo EMS This is not a complete list; see the J1939 Reference Manual for the full list.	Generic J1939	Choose one of the compatible ECM modules from the list.



Name	Range	Default	Description
ECM Communication Failure	Enable Disable	Disable	If no CAN messages are received for more than 6 seconds, the controller shuts down the engine.
DTC Display	Disable Global Enable Running Enable	Disable	Enables or disables active fault messages (DM1) monitoring.
Active DTC Log	Enable Disable	Disable	Enables or disables the storing of active faults (DM1).
Read Stored DTC	Enable Disable	Disable	Enables or disables the ability to request stored fault codes from the ECM (DM2).
Auto Power ECM	Enable Disable	Disable	When enabled, the fuel relay is enabled in Auto Mode so that the ECM is already booted up and initialized before the user decides to start the engine.
ECM Power Delay	5 ~ 30 s in 1 s increments	10 s	Used in conjunction with Auto Power ECM. When the engine shuts down, the controller waits for the time specified by the ECM Power Delay before turning on the fuel relay. This prevents unwanted start-ups due to the engine not being completely shut down.
Cummins PGNs	Disable Sending Enable	Sending Enable	Enables or disables the broadcasting of PGNs required by some Cummins engines.
SPN Conversion	Version 1 Version 2 Version 3	Version 3	Select the SPN conversion method.
EMS2B Frequency Select	Primary Secondary	Primary	For Volvo EMS2B Engine Control Modules only.
EMS2B Accelerator Pedal	40.0 ~ 60.0% in 0.1% increments	50.0 %	For Volvo EMS2B Engine Control Modules only.

4.8 Other Config

This section contains miscellaneous settings.

4.8.1 Password

A password is required to change certain settings. The Password menu is used to change this password and to control if and when the user is prompted for a password.



Other Config > Passcode

Name	Range	Default	Description
Bypass	Disable or Enable	Disable	If enabled, a password is not required to change settings.
Timeout	0 ~ 120 min in 1 min increments	10 min	How long after the password is entered before the user is required to enter it again. The timeout is implemented as a simple countdown timer. The following apply: <ul style="list-style-type: none"> • If the bypass time is changed, this new bypass time will not be loaded until the countdown timer has expired and the user enters the password. • The countdown timer is stored in non-volatile memory and is “paused” when the controller is powered off. The counter will resume when the controller is powered on again. • Any button press in the menu will reset the timer.
Passcode	0000 ~ 9999	0000	The four numeric digits that make up the password.

4.8.2 Settings Name

If you are storing settings from the RapidCore Configurator Software, a custom name can be entered to allow users to determine the settings that are stored in the controller. This custom name, called “Configuration Name” (ID in the controller), is found under Options in the settings tab of the Configurator Software. There is no controller menu to set this ID. It can be up to 12 characters long.

The Configuration Name can be viewed in the Device Info > About TG410/TG350 menu. It is labeled ID.

4.8.3 Process Control

The Process Control feature has two different control methods: Main-In and Main-Out. The Main-In maintains a reservoir/pressure level by controlling the flow of fluid/gas into the reservoir/tank. The Main-Out maintains a reservoir/pressure level by controlling the flow of fluid/gas from the reservoir/tank. It does this by regulating the speed of the engine over the J1939 CANbus.

The process control feature takes over on an engine start once the engine has ramped up to the goal speed (after going through the idle and intermediate ramping).

The controller reads the sensor value from selected Auxiliary Sensor input (1, 2, 3 or 4) or Transducer Input (Aux 5), compares the input value with the set-point, and then, based on an algorithm, increments or decrements the speed (RPM) by a certain amount (controlled by the Gain and Delay settings) to maintain the desired set-point outside of the deadband area. Control pauses inside the deadband area. If the sensor input goes beyond a minimum or maximum value, the algorithm will pause, and the RPM will be maintained at a minimum or maximum value.

The algorithm is a fuzzy logic type control with a deadband and a minimum / maximum saturation. The user sets the aggressiveness of the control with the *Gain* setting and the response time of the control with the *Delay* setting.



Front Panel: Other Config > Process Control menu, or

RapidCore: Pumping Applications > Closed Loop Control

Name	Range	Default	Description
Closed Loop > System (Control Type)	Disabled Main-In (Maintain In) Main-Out (Maintain Out)	Disabled	Main-In controls the level when pumping fluid into a reservoir. Main-Out controls the level while pumping fluid out of the reservoir.
Closed Loop > Sensor In (Sensor Input)	AUX-1 AUX-2 AUX-3 AUX-4 AUX-5	Aux-5	The Auxiliary Sensor Input function that is providing feedback on the reservoir level. Aux-5 refers to the Transducer under the Application menu.
Closed Loop > Delay	1 ~ 30 s in 0.1 s increments	8.0 s	The sampling time of the control algorithm. This value must be tuned for each installation.
Closed Loop > Gain	1 ~ 30 in 0.1 increments	19.0	The amount to increment or decrement the RPM when the sensed value is outside of the deadband. This number does not represent an actual RPM. A larger gain will generate a larger RPM change than a smaller gain for the same size error. This value must be tuned for each installation.
Setpoints > Main-In (Maintain In Setpoint)	1 ~ 900 in 0.1 increments	300.0	The level set-point to attempt to maintain. Only applies if the Control Type is set to Maintain-In. This value takes on the units of the Aux sensor set in the Closed Loop > Sensor In menu.
Setpoints > Main-Out (Maintain Out Setpoint)	1 ~ 900 in 0.1 increments	500.0	The level set-point to attempt to maintain. Only applies if the Control Type is set to Maintain-Out. This value takes on the units of the Aux sensor set in the Closed Loop > Sensor In menu.
Setpoints > Deadband+ (High Deadband)	1 ~ 30 in 0.1 increments	3.0	The high limit of the deadband.
Setpoints > Deadband- (Low Deadband)	1 ~ 30 in 0.1 increments	3.0	The low limit of the deadband.
Thresholds > High Edge (High Limit)	1 ~ 900 in 0.1 increments	700.0	The high saturation. The maximum level at which the RPM control is fixed. This value takes on the units of the Aux sensor set in the Closed Loop > Sensor In menu.



Name	Range	Default	Description
Thresholds > Low Edge (Low Limit)	1 ~ 900 in 0.1 increments	100.0	The low saturation. The minimum level at which the RPM control is fixed. This value takes on the units of the Aux sensor set in the Closed Loop > Sensor In menu.
Thresholds > Max RPM (Max Limit RPM)	500 ~ 4000 RPM in 1 RPM increments	3200 RPM	The fixed RPM that should be used when the level rises above the High Edge.
Thresholds > Min RPM (Low Limit RPM)	500 ~ 4000 RPM in 1 RPM increments	1000 RPM	The fixed RPM that should be used when the level falls below the Low Edge.



5 Troubleshooting

If you are having issues with your controller, please refer to the following table for a solution before contacting Cattron at www.cattron.com.

Issue	Solution
Engine starts but the crank output does not turn off	<p>The controller is not receiving a speed signal.</p> <ul style="list-style-type: none"> • Verify the Sensors > Engine Speed > Signal Source setting is set correctly. • Verify the Timers > Engine Logic > RPM Disconnect setting is set correctly. • Ensure the correct wiring to the controller. For magnetic pickup, Speed Sensing A and B terminals are used. For generator voltage, the AC voltage connections are used.
Sensor always displays its lowest or highest value	<p>The sensor could either be open (not connected) or shorted to ground. Verify your connections and ensure the correct sender table is loaded.</p>
Sensor value acts erratically, bounces, or climbs on engine start-up	<p>This could be caused by one of the following:</p> <ul style="list-style-type: none"> • Bad ground between sensor and controller. Check that there is a good ground between the negative post on the battery and the battery negative terminal (J4-3) on the controller. Also check that the connection from the negative post on the battery to the sensor body is good; if not, then add a grounding wire close to the sensor. • The ground strap is not sufficient AWG. Ensure the ground and power wiring can carry the large amperage for the starter motor and other equipment. • If you are using a magnetic pickup sensor for speed sensing, it might be generating noise. Use a shielded twisted pair cable from the magnetic sensor to the controller. Refer to the typical wiring diagram for how to do this. • Try twisted pair cable running both ground and the signal; ground it near the sensor body. Try an isolated sensor (sensor having both a ground post and a signal post).
Controller displays “Failure To Stop” on a shutdown.	<p>Either set Energize to Stop under Timers to 0 seconds or increase its duration. At the end of the Energize to Stop time, the controller will detect if the engine speed is zero. If it is not, it goes into a “Failure To Stop” failure.</p>



6 Technical Support

For remote and communication control systems support, parts and repair, or technical support, visit us online at:
www.cattron.com/contact.



Due to continuous product improvement, the information provided in this document is subject to change without notice.

Cattron Wireless Automation and Control Solutions Support

For remote and communication control systems support, parts and repair, or technical support, visit us online at:
www.cattron.com/contact

Cattron North America Inc., 655 N River Rd NW, Suite A, Warren, OH 44483