



SILICONE NEON STRIP

PRODUCT SPECIFICATION





- It is made of Dow Chemical SILASTIC™ ET-7021 silicone rubber, which provides high transparency and high strength.
- Environmental protection grade silicone material, integrated extrusion molding process.
- Unique optical light distribution structure design, uniform lighting surface and no shadow.
- IP67 protection level, salt solution resistance, acids & alkalis and UV resistance.
- Excellent toughness, simple and stylish appearance, delicate and unique.
- 3 years warranty, working life \geq 30000 hours.

Dimension structure

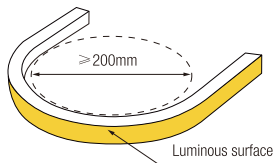
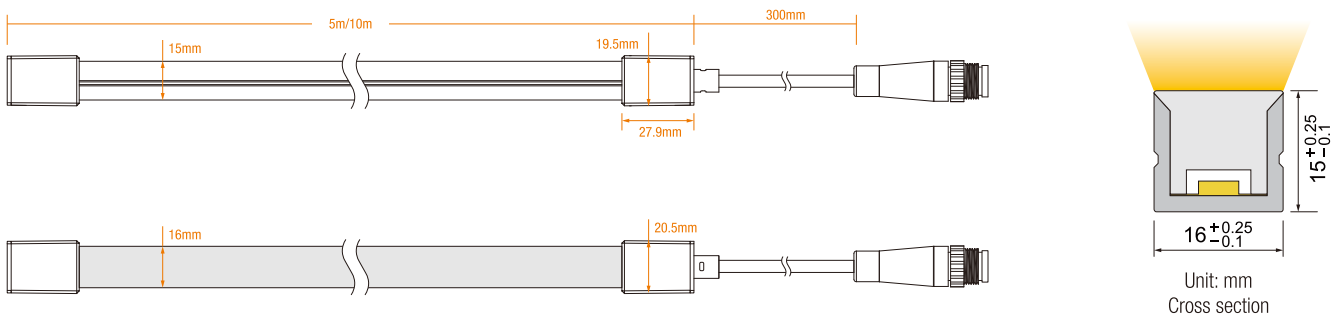

Min Bending diameter

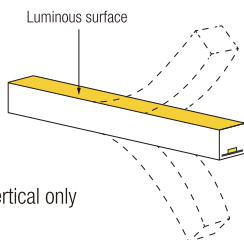

Bend vertical only

Electrical Parameter

Voltage	LED PIN Temperature	Storage Temperature	Ambient Temperature	CRI
DC24V	Max. 65 C	-25 C ~ 60 C	Min. -25°C Max(Table below)	\geq 90

Specification

Power	Efficacy@4000K	Max Ambient Temperature
5 w/m	58.8 lm/w	55°C
10 w/m	57.3lm/w	45°C
15 w/m	53.8 lm/w	35°C

Due to the tolerance of the production and electrical components, output value and electrical power can vary up to 10%

Length Standard

Length Range (M)	Final Length			Tolerance
	Integral end cap	Solder free end cap	Silicone end cap	
0M<Neon Strip(L) \leq 5M	L+6	L+16	L+8	\pm 7
5M<Neon Strip(L) \leq 10M	L+6	L+16	L+8	\pm 10
10M<Neon Strip(L) \leq 15M	L+6	L+16	L+8	\pm 13
15M<Neon Strip(L) \leq 20M	L+6	L+16	L+8	\pm 16
20M<Neon Strip(L) \leq 25M	L+6	L+16	L+8	\pm 19
25M<Neon Strip(L) \leq 30M	L+6	L+16	L+8	\pm 22



- The maximum series length refers to the maximum single end power supply length of the constant current strip under the condition of standard 30cm wire .
- For the load capacity of the solder free end cap, please refer to <The Maximum Load Capacity of Power Cables>
- The given color temperature is the temperature of finished product.
- The given data are typical values due to the tolerances of the production process and the electrical components, values for light output and electrical power can vary up to 10%.
- All products can be dimmed; the dimmer' s voltage should conform to the rated voltage of the led light. The output frequency of the dimmer of the constant-current led light should be less than 2K Hz, and the output PWM can control the led light.

Single color (Lm/m)

CCT(K)	CRI	Voltage	Power(W)	Lumen (LM/M)	Efficiency (LM/W)	Unit Length (mm)	Max. Run Length (M)	CC/CV
2100K±100	≥90	DC24V	10	460	46	50	17(CC)	CC/CV
2400K±100	≥90	DC24V	10	470	47	50	17(CC)	CC/CV
2700K±100	≥90	DC24V	10	550	55	50	17(CC)	CC/CV
3000K±100	≥90	DC24V	10	540	54	50	17(CC)	CC/CV
3500K ⁺²⁰⁰ ₋₁₀₀	≥90	DC24V	10	585	58.5	50	17(CC)	CC/CV
4000K ⁺³⁰⁰ ₋₂₀₀	≥90	DC24V	10	575	57.5	50	17(CC)	CC/CV
5000K ⁺³⁰⁰ ₋₂₀₀	≥90	DC24V	10	570	57	50	17(CC)	CC/CV
6000K ⁺⁴⁰⁰ ₋₁₀₀	≥90	DC24V	10	575	57.5	50	17(CC)	CC/CV
Red	--	DC24V	10	240	24	50	18(CC)	CC/CV
Green	--	DC24V	10	550	55	50	17(CC)	CC/CV
Blue	--	DC24V	10	110	11	50	17(CC)	CC/CV
Yellow	--	DC24V	10	240	24	50	18(CC)	CC/CV
Pink	--	DC24V	10	225	22.5	50	17(CC)	CC/CV

Note: -The running length is base on Constant Current 24Vdc LED Strip.

-When use the solder free end cap or waterproof connector,the max run length of 10W/M is respectively 10M.

CCT Tunable (Lm/m)

CCT(K)	CRI	Voltage	Power(W)	Lumen (LM/M)	Efficiency (LM/W)	Unit Length (mm)	Max. Run Length (M)	CC/CV
WW	≥90	DC24V	5	275	55	50	5	CV
W	≥90	DC24V	5	295	59	50	5	CV
W+WW	≥90	DC24V	10	570	57	50	5	CV

RGB (Lm/m)

CCT(K)	CRI	Voltage	Power(W)	Lumen (LM/M)	Efficiency (LM/W)	Unit Length (mm)	Max. Run Length (M)	CC/CV
R	--	DC24V	3.3	56.1	17	62.5	5	CV
G	--	DC24V	3.3	181.5	55	62.5	5	CV
B	--	DC24V	3.3	34.65	10.5	62.5	5	CV
RGB	--	DC24V	10	270	27	62.5	5	CV



Horizontal Bending

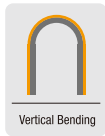

Vertical Bending



Only One Bin



Resistant Saltwater



UV Protection



Resistant to solvents

RGBW (LM/M)

CCT(K)	CRI	Voltage	Power(W)	Lumen (LM/M)	Efficiency (LM/W)	Unit Length (mm)	Max. Run Length (M)	CC/CV
R	--	DC24V	2.5	32.5	13	62.5	5	CV
G	--	DC24V	2.5	135	54	62.5	5	CV
B	--	DC24V	2.5	31.25	12.5	62.5	5	CV
W(2200-2600K)	≥80	DC24V	2.5	70	28	62.5	5	CV
RGBW	--	DC24V	10	340	34	62.5	5	CV

CCT(K)	CRI	Voltage	Power(W)	Lumen (LM/M)	Efficiency (LM/W)	Unit Length (mm)	Max. Run Length (M)	CC/CV
R	--	DC24V	2.5	32.5	13	62.5	5	CV
G	--	DC24V	2.5	135	54	62.5	5	CV
B	--	DC24V	2.5	31.25	12.5	62.5	5	CV
W(2400-3000K)	≥80	DC24V	2.5	158.75	63.5	62.5	5	CV
RGBW	--	DC24V	10	360	36	62.5	5	CV

CCT(K)	CRI	Voltage	Power(W)	Lumen (LM/M)	Efficiency (LM/W)	Unit Length (mm)	Max. Run Length (M)	CC/CV
R	--	DC24V	2.5	32.5	13	62.5	5	CV
G	--	DC24V	2.5	135	54	62.5	5	CV
B	--	DC24V	2.5	31.25	12.5	62.5	5	CV
W(3400-4000K)	≥80	DC24V	2.5	168.75	67.5	62.5	5	CV
RGBW	--	DC24V	10	370	37	62.5	5	CV

CCT(K)	CRI	Voltage	Power(W)	Lumen (LM/M)	Efficiency (LM/W)	Unit Length (mm)	Max. Run Length (M)	CC/CV
R	--	DC24V	2.5	32.5	13	62.5	5	CV
G	--	DC24V	2.5	135	54	62.5	5	CV
B	--	DC24V	2.5	31.25	12.5	62.5	5	CV
W(5000-5600K)	≥80	DC24V	2.5	140	56	62.5	5	CV
RGBW	--	DC24V	10	330	33	62.5	5	CV

- The maximum series length refers to the maximum single end power supply length of the constant current strip under the condition of standard 30cm wire .
- For the load capacity of the solder free end cap, please refer to <The Maximum Load Capacity of Power Cables>
- The given color temperature is the temperature of finished product.
- The given data are typical values due to the tolerances of the production process and the electrical components, values for light output and electrical power can vary up to 10%.
- All products can be dimmed; the dimmer' s voltage should conform to the rated voltage of the led light. The output frequency of the dimmer of the constant-current led light should be less than 2K Hz, and the output PWM can control the led light.

Various End Caps

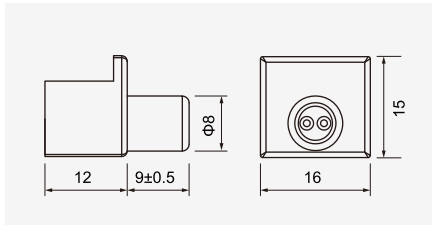

Integral end cap

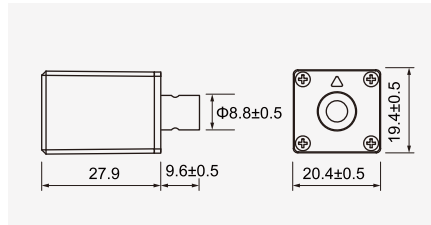

Solder free end cap

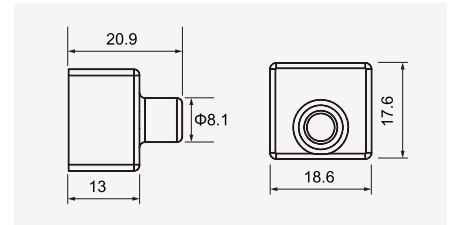

Silicone end cap

Cable Entry

Front Cable Entry:
The cable could be hidden in all directions by the flexible design.

Integral end cap

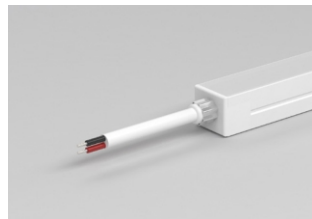

Combined end cap

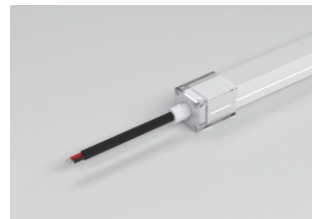

Silicone end cap

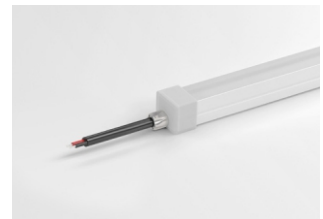

Side Cable Entry:
The cable could be perfectly hidden to achieve seamless light connection.

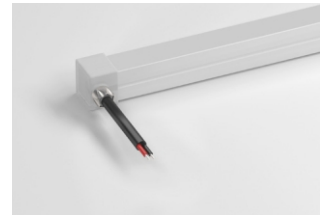

Bottom Cable Entry:
The cable could be perfectly hidden to achieve seamless light connection.



Integral closed end cap

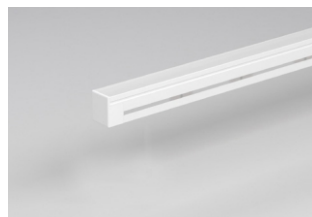







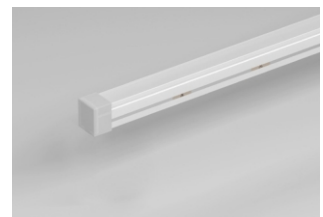

















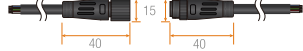







Solder free closed end cap



Silicone closed end cap



Cable

Cable Type	Schematic Diagram	Specification	Core	Electrical Properties
PVC Cable		OD: 5.0mm / Inner core: 20AWG		Red V+, Black V-
		OD: 5.0mm / Inner core: 20AWG		Brown V+, White W, Yellow WW
		OD: 5.5mm / Inner core: 20AWG		Black V+, Blue B, Green G, Red R
		OD: 5.5mm / Inner core: 22AWG		Black V+, White W, Blue B, Green G, Red R
Waterproof Connector with PVC Cable		OD: 5.0mm / Inner core: 20AWG M12Male / Female connecto		Red V+, Black V-
		OD: 5.0mm / Inner core: 20AWG M12Male / Female connecto		Brown V+, White W, Yellow WW
		OD: 5.5mm / Inner core: 20AWG M12Male / Female connecto		Black V+, Blue B, Green G, Red R
		OD: 5.5mm / Inner core: 22AWG M12Male / Female connecto		Black V+, White W, Blue B, Green G, Red R
Silicone Cable		OD: 5.0mm / Inner core: 20AWG		Red V+, Black V-
		OD: 5.0mm / Inner core: 20AWG		Brown V+, White W, Yellow WW
		OD: 6.0mm / Inner core: 20AWG		Black V+, Blue B, Green G, Red R
		OD: 6.0mm / Inner core: 20AWG		Black V+, White W, Blue B, Green G, Red R
Waterproof Connector with Silicone Cable		OD: 5.0mm / Inner core: 20AWG M12Male / Female connecto		Red V+, Black V-
		OD: 5.0mm / Inner core: 20AWG M12Male / Female connecto		Brown V+, White W, Yellow WW
		OD: 6.0mm / Inner core: 20AWG M12Male / Female connecto		Black V+, Blue B, Green G, Red R
		OD: 6.0mm / Inner core: 20AWG M12Male / Female connecto		Black V+, White W, Blue B, Green G, Red R

Cable's Maximum load capacity

a. Assembled end cap with single-ended power supply, its maximum load power is as follows:

Color	Maximum load current (A)	DC24V Maximum load Power (W)	DC12V Maximum load Power (W)
Single color	4.2	100	50
CCT Tunable	3.5	84	42
RGB	3	72	36
RGBW	3	72	36
Magic	3	72	36

b. When one end of the single color led neon goes out, the power exceeds the wattage listed in the table, it is recommended to use integrated or silicone end cap;

Cutting Mark



Remark:
The bottom of the led strip has transparent window,
the black marker is the cutting position



Use professional scissors to cut vertically
at the cutting mark

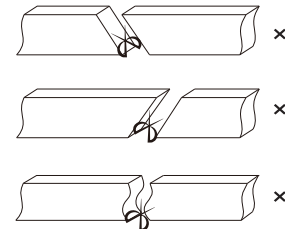

Please don't be feel free to cut and cut into an
oblique angle or cambered section.

Mounting Way

Mounting Clips

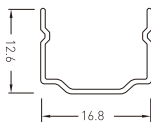
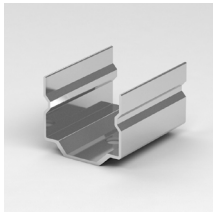

Dimension:
20x12.6x16.8mm
Accessories:
Screw M3x15mm

Aluminium Mounting clips

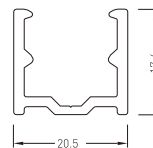
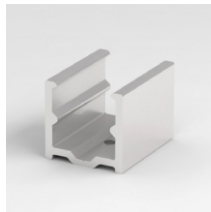

Dimension:
20x20.5x17.6mm
Accessories:
Screw M3x15mm

Aluminium Profile

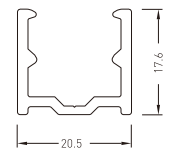
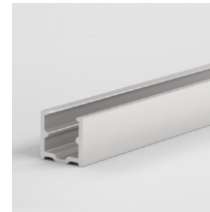

Dimension:
1000(±5)x20.5x17.6mm
Accessories:
Screw M3x15mm

Curved aluminum profile

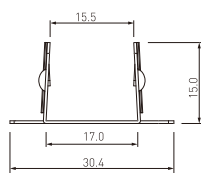

Dimension: 51.4x30.4x15mm
Accessories:
Screw M3x15mm

Suspension Installation



•Use with the profile

Single Color Connection Diagram

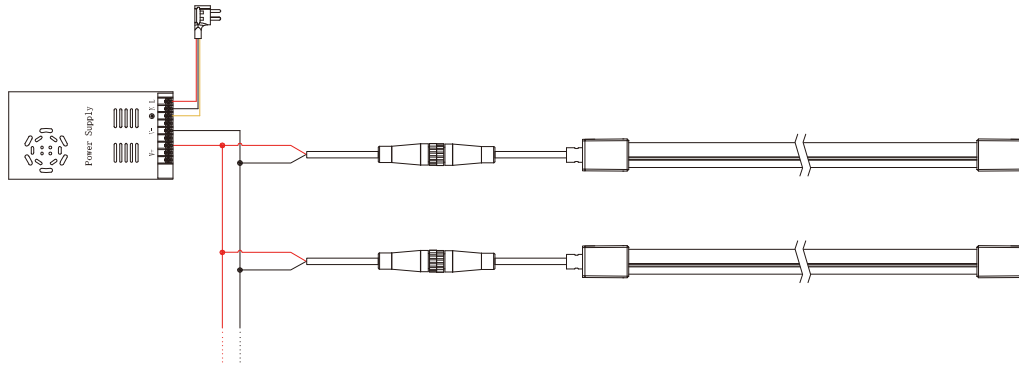

Tunable white Connection Diagram

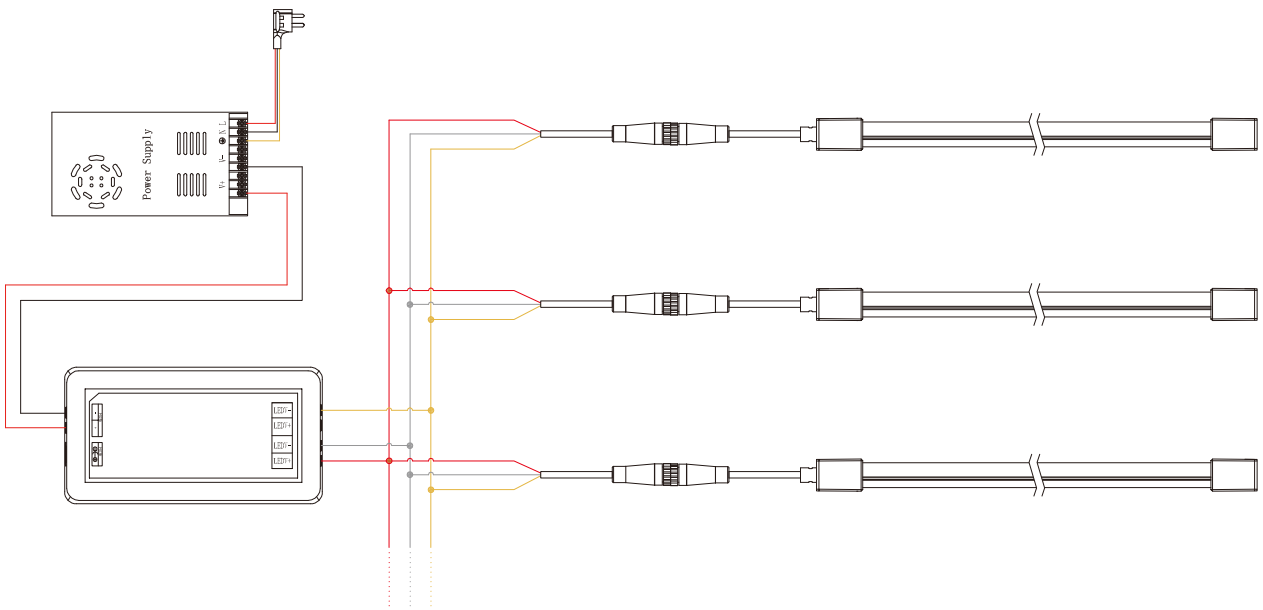

RGB Connection Diagram

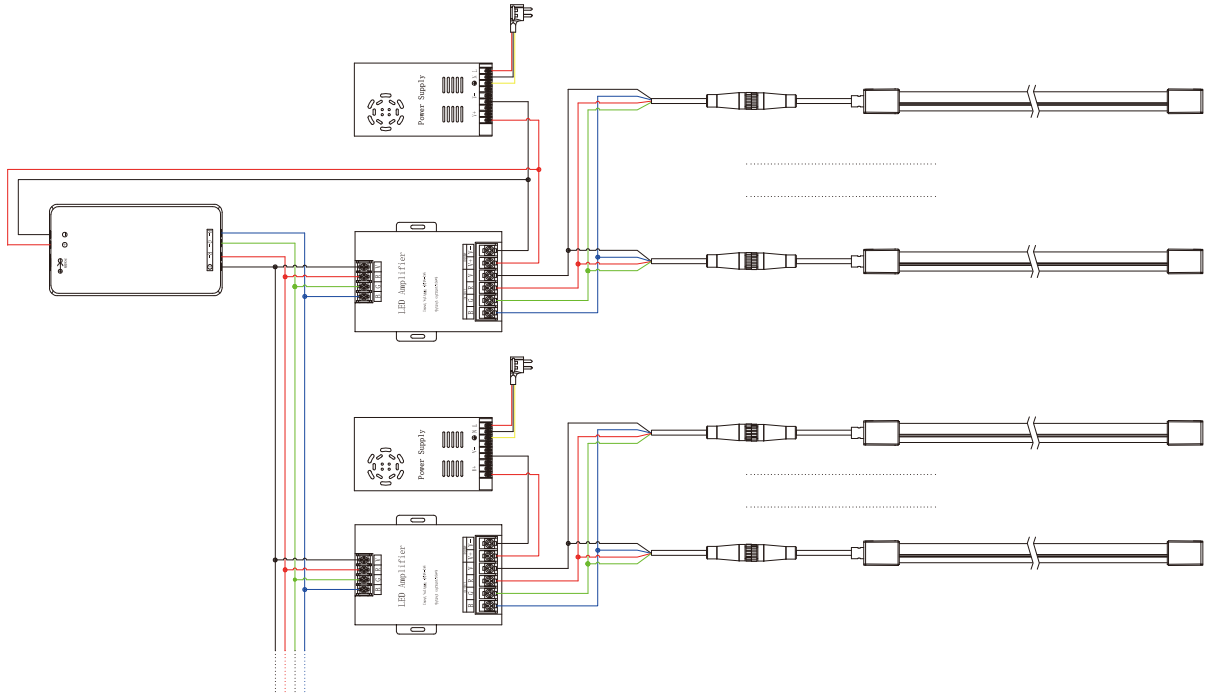

RGBW Connection Diagram

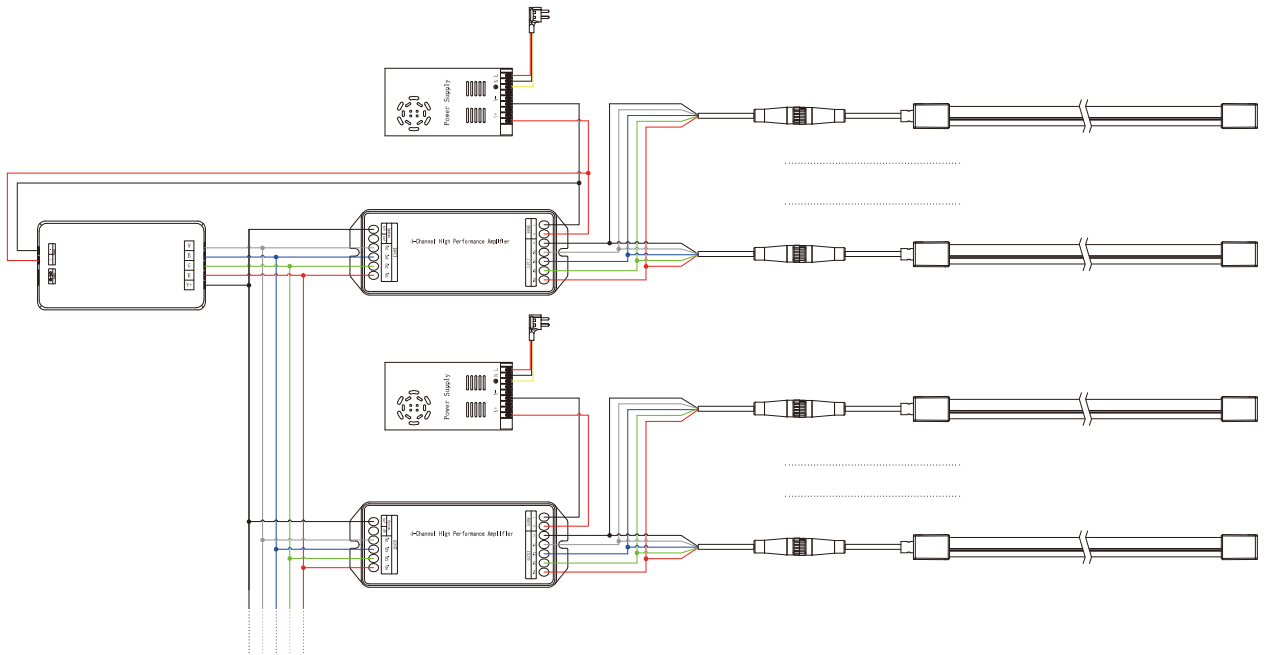

Installation Precautions

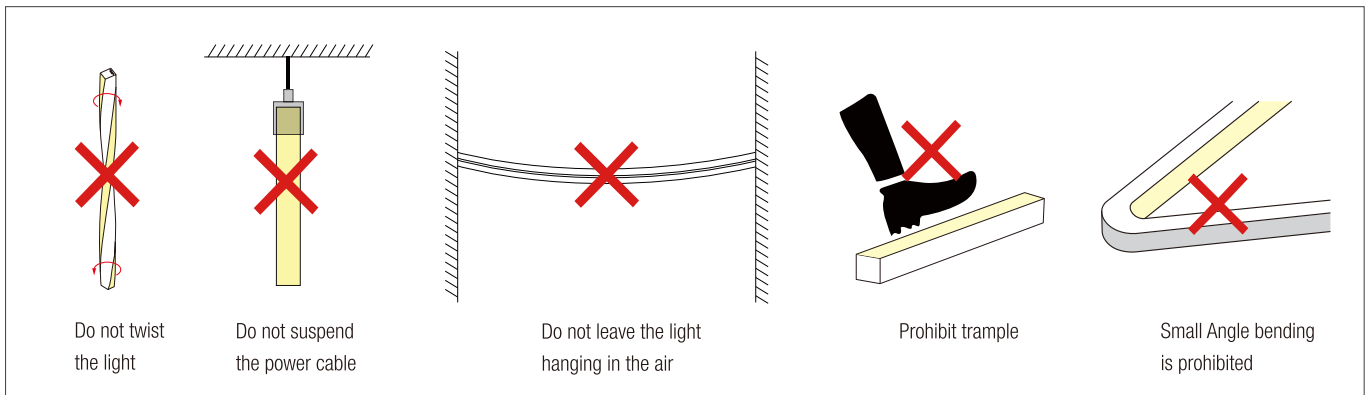
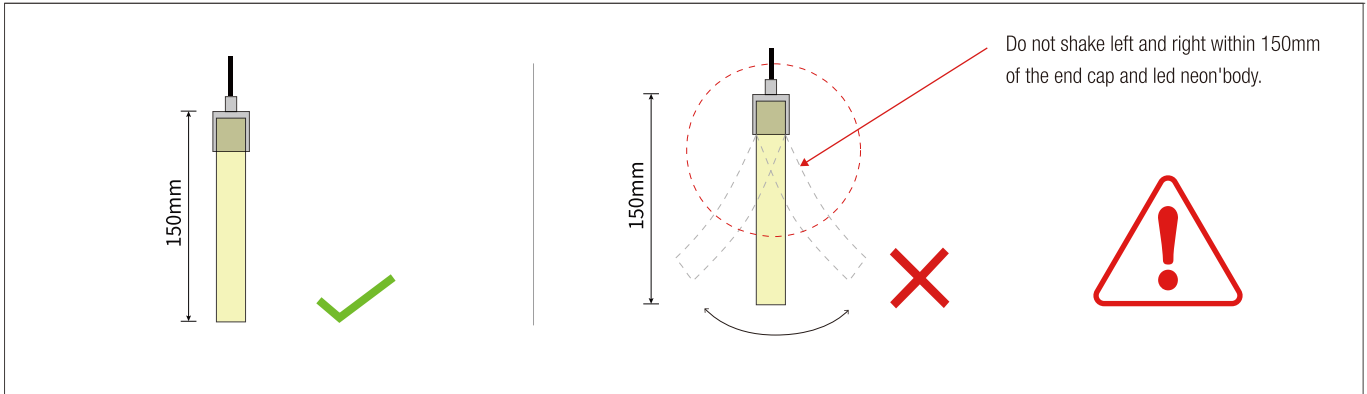

Put it in the profile

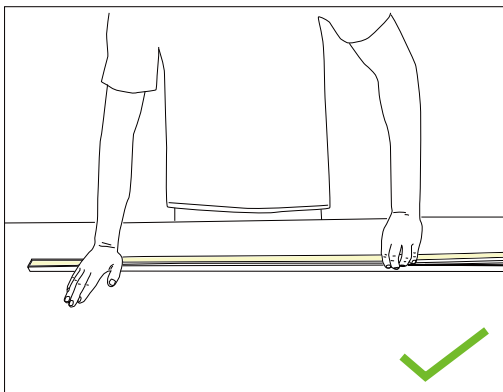

- Please press the led strip with your palm to slowly insert the led strip into the groove, and gently straighten the led strip above the groove with your right hand.
- Try to keep the led strip in a flat state during the installation process.

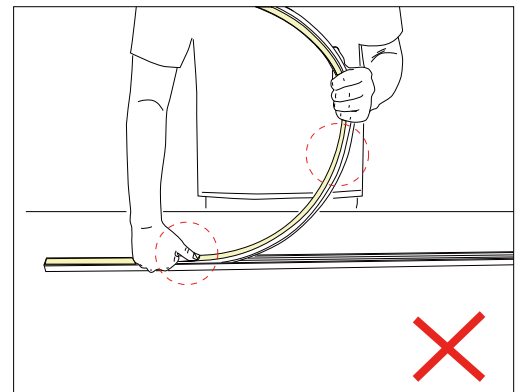

- Do not press the led strip with a single finger, it is easy to damage the internal parts of the led strip.
- The bent arc of the led strip should not be too large during installation.

Installation Precautions -- Side Mounted (If the length of the light is more than 2 meters, two persons must work together to install it.)

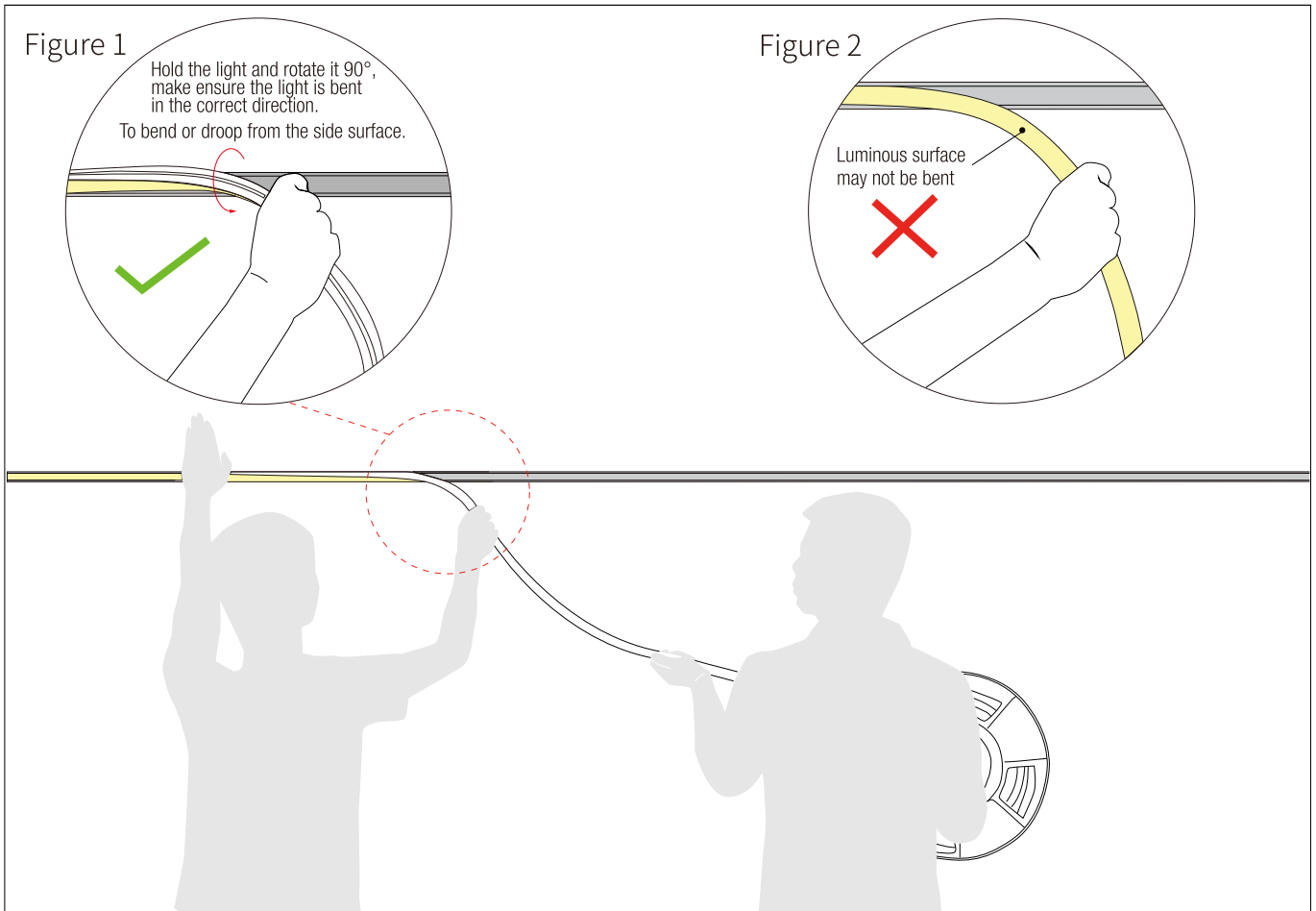

1.Installer:

- Press the light with the palm of the left hand to slowly load it into the slot. Straighten the light with right hand, hold it and rotate it 90° to droop it in the direction of your hand. See Figure 1.
- Luminous surface may not be bent. See Figure 2.

2.Assistant:

- Cooperate with the installer to lift the reel of the light, and then slowly deliver the light to installer. Do not pull or twist the light during the installation.

Installation Precautions -- Side Mounted (If the length of the light is more than 5 meters, two persons must work together to install it.)

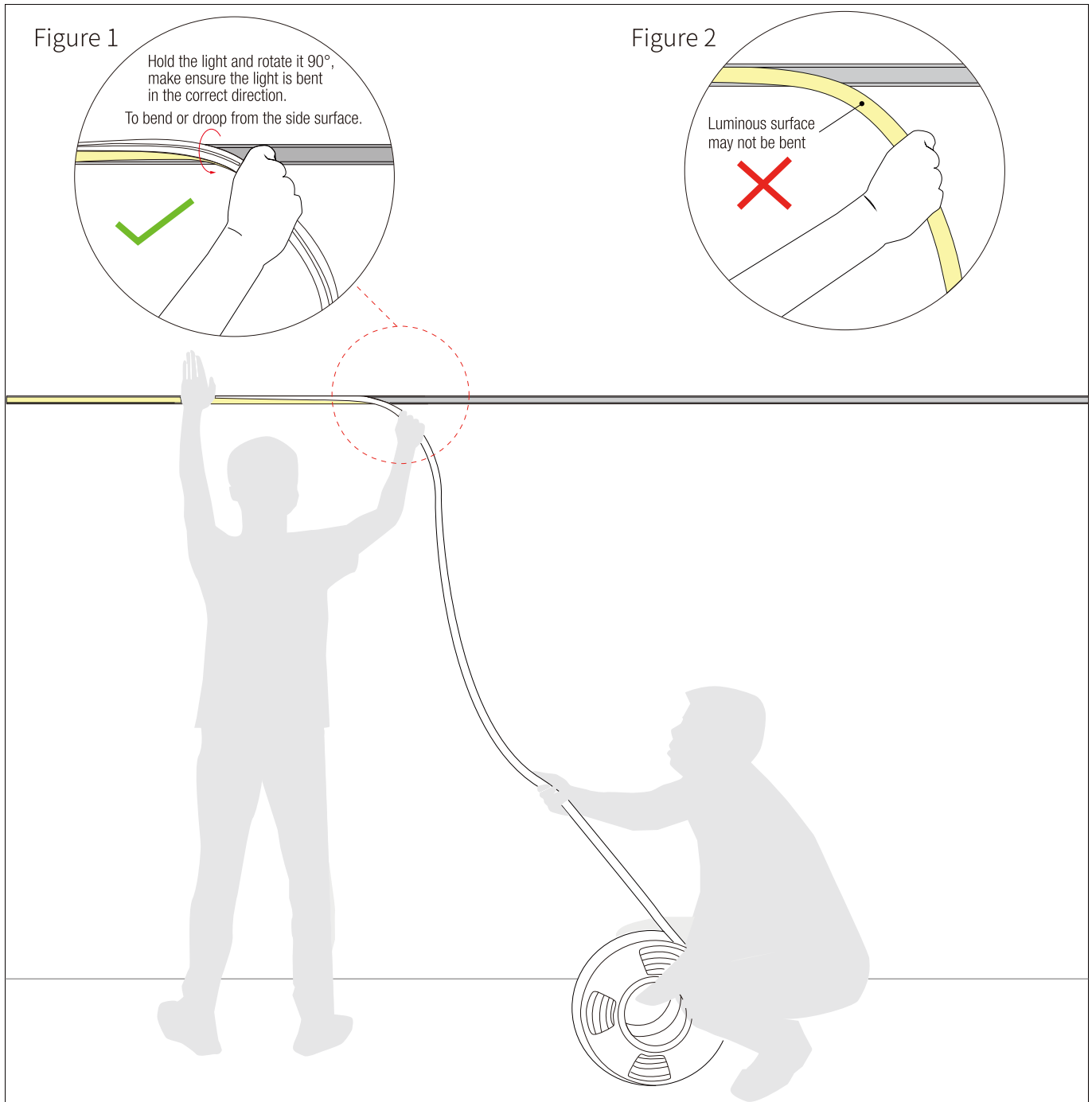

1.Installer:

-Press the light with the palm of the left hand to slowly load it into the slot. Straighten the light with right hand, hold it and rotate it 90° to droop it in the direction of your hand. See Figure 1.

-Luminous surface may not be bent. See Figure 2.

2.Assistant:

-Cooperate with the installer to slowly deliver the light to installer. Do not pull or twist the light during the installation.

Installation Precautions -- Top Mounted (If the length of the light is more than 2 meters, two persons must work together to install it.)

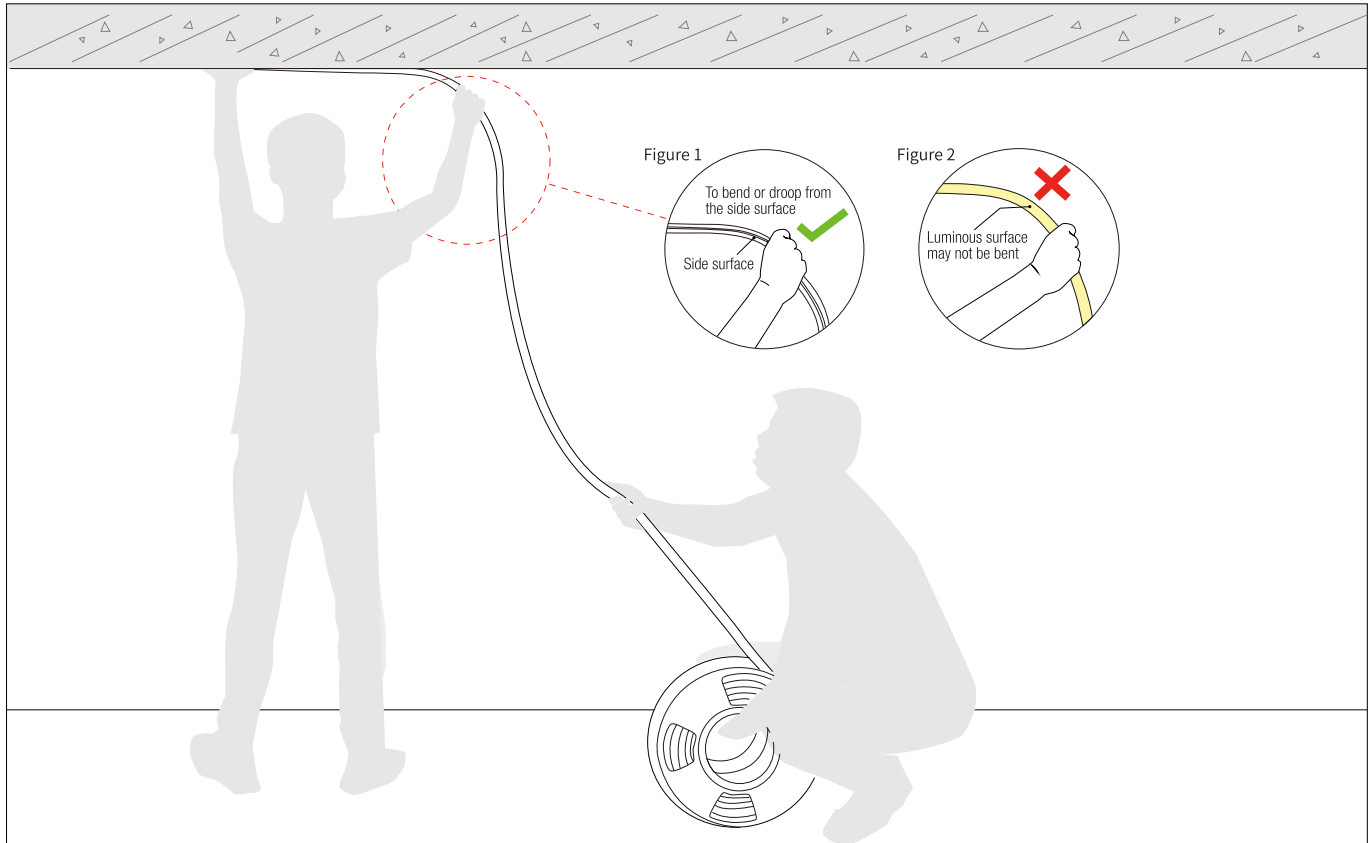

1.Installer:

- Press the light with the palm of the left hand to slowly load it into the slot. Straighten the light with your right hand so that it droop naturally. See Figure 1.
- Luminous surface may not be bent. See Figure 2.

2.Assistant:

- Cooperate with the installer to slowly deliver the light to installer. Do not pull or twist the light during the installation.

Notes

The selection of the cable specification at the output end of the power supply, it depends on the total current of the load and the length of the cable. It is recommended to select according to the following table:

Current of the light	Specifications of the cable								
	L=1M	L=2M	L=4M	L=6M	L=8M	L=10M	L=12M	L=14M	L=16M
1A	AWG26	AWG23	AWG21	AWG18	AWG18	AWG17	AWG16	AWG15	AWG15
2A	AWG23	AWG21	AWG18	AWG16	AWG15	AWG14	AWG13	AWG12	AWG12
3A	AWG22	AWG18	AWG16	AWG14	AWG13	AWG12	AWG11	AWG11	AWG10
4A	AWG21	AWG18	AWG15	AWG13	AWG12	AWG11	AWG10	AWG9	AWG9
5A	AWG20	AWG17	AWG14	AWG12	AWG11	AWG10	AWG9	AWG9	AWG8
6A	AWG18	AWG16	AWG13	AWG11	AWG10	AWG9	AWG8	AWG8	AWG7
7A	AWG18	AWG15	AWG12	AWG11	AWG9	AWG8	AWG8	AWG7	AWG6
8A	AWG17	AWG15	AWG12	AWG10	AWG9	AWG8	AWG7	AWG7	AWG6
9A	AWG17	AWG14	AWG11	AWG10	AWG8	AWG7	AWG7	AWG6	AWG5
10A	AWG16	AWG14	AWG11	AWG9	AWG8	AWG7	AWG6	AWG6	AWG5

- ※ The unused light should be sealed with the packaging bag to avoid prolonged exposure.
- ※ Please use DC24V isolated constant voltage power supply with ripple voltage less than 5%. Using other types of power supply may damage the light or cause other safety risks.
- ※ In practical application, 20% allowance should be reserved for power supply to ensure the stability of power supply.
- ※ It is recommended that professionals connect the power supply. Do not connect the power supply with live power to avoid electric shock.
- ※ Please confirm whether the voltage of the power supply is consistent with the voltage of the light; Pay attention to the positive and negative poles of the power cord, do not connect wrong, so as not to cause product damage;
- ※ When multiple power supplies are used, ensure that the positive poles of the power supply are not connected in parallel. Otherwise, the power supply system may be unstable or damaged after long-term operation.
- ※ If the actual application length exceeds the specified length, it will lead to overload, heating and uneven brightness of the light.
- ※ During installation, please do not scratch, twist, or bend the light irregularly. Otherwise, the light may be damaged beyond repair.
- ※ To ensure the life and reliability of the light, please do not over bend the light, which will damage the product itself.
- ※ To protect your eyes, please avoid staring at the glowing surface of the light for a long time.
- ※ Non-professionals are forbidden to install, disassemble and maintain the product.
- ※ Do not use any acid or alkaline adhesive to fix the light (including but not limited to glass glue, etc.)
- ※ IP67 products are not suitable for long-term immersion in water; IP68 products are only customized by the factory. After cutting and processing by users themselves, there is a risk that IP68 protection level cannot be reached
- ※ Because of the difference in structure, even if the same color temperature value, different sizes of light will look slightly different colors. Please confirm it before use.

Tests showed that methanol and benzenes will have yellowing effects on silicone.

In the newly decorated interior environment, epoxy floor paint, wall paint, wallpaper adhesive, various decoration materials or new furniture, they are likely to release of methanol and benzenes.

It is recommended to remove methanol and benzenes first, or ventilate for a period of time in the newly decorated interior environment before install the silicone neon light, to avoid affecting the silicone body.



Consilio Lighting

+44 (0)1926 312 712