

# Install XL

Software Version 2.12

---

**Audience:** This guide is for the electrician installing the Vorne XL Productivity Appliance™.

**Purpose:** Instructions for hanging XL on a machine, connecting XL to the network, and obtaining signals from the manufacturing process.

# Table of Contents

Important User Information.....	3
Contact Information.....	4
Corporate Office.....	4
What You Will Need to Install XL.....	5
Provided by Vorne.....	5
Provided by Customer.....	5
Identify Signal Requirements.....	6
Connect XL to Your Process.....	7
Step 1 – Prepare for Installation.....	7
Step 2 – Hang Mount the Device.....	7
Step 3 – Remove Access Plate.....	8
Step 4 – Take Note of Connector Locations.....	8
Step 5 – Connect Signal Inputs.....	9
Step 6 – Connect Barcode Scanner.....	10
Step 7 – Connect Ethernet Port.....	10
Step 8 – Reinstall Access Plate.....	10
Step 9 – European Union: Install Clamp-On Ferrite Core.....	11
Step 10 – Apply Power.....	11
Step 11 – Test Barcode Scanner.....	11
Appendix A – Relay Output.....	12
Relay Output Operation.....	12
Relay Output Wiring.....	12
Appendix B – DIP Switch Settings.....	13
Appendix C – Specifications.....	14
Operating Conditions.....	14
Inputs and Outputs.....	14
Communication Ports.....	14
Model-Specific Specifications.....	14
EU Declaration of Conformity.....	15

# Important User Information

XL products are not designed or intended for control applications, and MUST NOT be used for control applications under any circumstances. There are fundamental differences in the design methodology of a control product such as a Programmable Logic Controller (PLC) and a non-control product such as an XL device. Outputs (e.g., relays) are provided for annunciation only, and MUST NOT be used for control purposes.

This product is designed and intended for use solely in indoor industrial applications, and MUST be installed by a qualified electrician.

This product is designed and intended for use solely in a secure, private network environment.

It is the responsibility of all persons applying this product to a given installation and/or application to carefully review the installation and/or application to evaluate and ensure the suitability of this product for the intended application.

This documentation, including any examples, diagrams, and drawings, is intended to provide information for illustrative purposes only. Because of the differences and varying requirements of different installations and applications, Vorne Industries, Inc. cannot assume responsibility or liability for actual use, including use based on any examples, diagrams, and drawings.

In no event will Vorne Industries, Inc. be responsible or liable for indirect or consequential damages resulting from the use or application of this product. Please carefully review the Vorne Product Warranty Statement at [www.vorne.com/warranty.htm](http://www.vorne.com/warranty.htm) and the Vorne Sales Terms and Conditions at [www.vorne.com/terms.htm](http://www.vorne.com/terms.htm). Vorne Industries, Inc. makes no warranties express or implied except as expressly stipulated in our Product Warranty Statement.

While the information in this document has been carefully reviewed for accuracy, Vorne Industries, Inc. assumes no liability for any errors or omissions in the information.

Vorne Industries, Inc. reserves the right to make changes without further notice to any products described in this documentation.

**Important Legal Notice:** US Patent US9100248, US9633135, US9864961, EP Patents EP2145452, EP2381649, Canadian Patents CA2686313, CA2786004, Mexican Patent MX354053. Additional patents pending. Copyright © 2005 – 2020 Vorne Industries, Inc. Vorne, XL and other Vorne Industries, Inc. trademarks described herein are the exclusive property of Vorne Industries, Inc. All other trademarks are the property of their respective owners. This product and its associated software and documentation (collectively “the Product”) contains Vorne Industries, Inc. proprietary material, and is further protected by statute and applicable international treaties. The Product may not be reverse engineered or used in any manner for competitive purposes without the prior express written consent of Vorne Industries, Inc. Any rights not expressly granted herein are reserved.



**SHOCK HAZARD:** This product has more than one source of power. Relay outputs may be at mains potential from a secondary power source. Always disconnect power from all power sources before installing or servicing the XL device, and before opening the user access plate. Do not reapply power until the access plate has been reinstalled and securely closed. Failure to follow these precautions could result in personal injury or death due to electric shock.



**ATTENTION:** This product must be operated at or below Pollution Degree 2 (an environment where only non-conductive pollution occurs except for occasional and temporary conductivity caused by condensation) and Over Voltage Category II (circuits directly connected to local-level distribution).

# Contact Information

## Corporate Office

**Address:** Vorne Industries, Inc.  
1445 Industrial Drive  
Itasca, IL 60143-1849, USA

**Phone:** +1.630.875.3600

**Fax:** +1.630.875.3609

**Website:** [www.vorne.com](http://www.vorne.com)

## Sales and Support (USA and Canada)

We are available Monday through Friday from 8:00 AM to 6:00 PM CST (UTC-6:00).

**Toll-Free Phone:** +1.877.767.5326

**Sales Email:** [sales@vorne.com](mailto:sales@vorne.com)

**Support Email:** [support@vorne.com](mailto:support@vorne.com)

## Sales and Support (European Union)

Within the European Union, Vorne products are distributed by the following companies:

Company Name	Office Location
<b>Action Coaching International</b>	Koningin Astridlaan 74, 2820 Bonheiden, Belgium
<b>LineView Solutions</b>	Innovation Campus, 33 Greenhill, Blackwell, Bromsgrove, B60 1BL United Kingdom
<b>TQMSOft</b>	ul. Bociana 22a, 31-231 Kraków, NIP 676-11-58-054, Poland

## Sales and Support (International)

Vorne has an extensive network of international partners. More information can be found at:  
<https://www.vorne.com/about-us/xl-partners.htm>.

# What You Will Need to Install XL

## Provided by Vorne

### XL Productivity Appliance™

Item	Description
<b>XL Productivity Appliance™</b>	Your XL device, which includes an integrated scoreboard, digital I/O, production monitor, data warehouse, web server, and browser-based reporting platform.
<b>XL Power Cord</b>	Detachable power cord with IEC female connector.
<b>Ferrite Cable Clamp</b>	Cylindrical ferrite clamp. (Included only for products sold within the European Union)
<b>XL Documentation</b>	Includes: <ul style="list-style-type: none"><li>▪ <b>Meet XL</b> (for the person responsible for driving improvement with XL)</li><li>▪ <b>Configure XL</b> (for the person responsible for driving improvement with XL)</li><li>▪ <b>Install XL</b> (for the electrician installing XL)</li></ul>

### XL Barcode Kit (Optional)

Item	Description
<b>XL Barcode Kit</b>	Optional (but highly recommended). Includes 2D barcode scanner, XL interface cable, and AC adapter.  The operator uses a barcode scanner in most applications to scan down reasons and start new part runs. The barcode scanner can also be used to scan the start of changeovers and/or log rejects (counts and reasons).

## Provided by Customer

Item	Description
<b>Signal Inputs</b>	Most discrete manufacturing processes provide XL with a pulsing 5-24V DC digital In Count signal input. The In Count is used by XL to calculate counts and to track cycles.  Optionally a second Out Count signal input can be provided to track OEE Quality. This signal can be generated by either one or more Reject Count sensors, a Good Counts sensor, or the barcode scanner.  If the process does not have the capability to provide a pulsing count signal, XL can receive a run/down signal. Refer to the <b>Deploy XL: Manual Run Detection</b> document for more information.
<b>Network Drop</b>	Network connection for CAT5 or better Ethernet cable.
<b>Ethernet Cable</b>	CAT5 or better Ethernet cable. Straight-through or crossover.
<b>Mounting Hardware</b>	Refer to <b>Step 2 – Hang Mount the Device</b> in the <b>Connect XL to Your Process</b> chapter for chain specifications.

# Identify Signal Requirements

## Install XL on a Single-Step Process

If XL is being installed on a single-step manufacturing process:

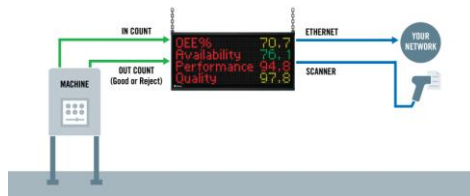

- **In Count (Required):** Counts pieces entering the process and detects Down Time. This signal should be configured as the Cycle Input to measure cycles and detect slow cycles and small stops.
- **Out Count (Optional):** Counts pieces exiting the process. Can be either Good Count or Reject Count (but not both). As an alternative, instead of using a signal input, the operator can use the barcode scanner to provide Reject Counts (with reasons).

## Install XL on a Multiple-Step Process

If you are monitoring a manufacturing process with multiple steps, you should measure losses at the constraint. XL can receive a dedicated cycle signal input sourced from the constraint. If XL is being installed on a multiple-step manufacturing process:



- **In Count (Required):** Counts pieces entering the process.
- **Cycle Input (Optional):** You can provide a signal as the Cycle input to measure cycles, and down time at the constraint, if the constraint is not the source of the In Count.
- **Out Count (Optional):** Counts pieces exiting the process. Can be either Good Count or Reject Count (but not both). As an alternative, instead of using a sensor, the operator can use the barcode scanner to provide Reject Counts (with reasons).

## Signal Variations

In addition to the two scenarios above, there are a few common signal variations:

- **No Counts:** If the process has no counts, XL can track Run and Down time using an on/off signal. For more information about this operation refer to the **Deploy XL: Manual Run Detection** guide.
- **No Out Count:** Technically, the Out Count is optional. However, an Out Count is required to calculate quality metrics (including OEE Quality).
- **Multiple Out Counts:** The Out Count (Good Count or Reject Count) can be taken from multiple points of the manufacturing process.
- **End of Line Count:** A standalone counter typically used to count packaged product at the end of the manufacturing process.

# Connect XL to Your Process

XL is designed to easily integrate with your existing process using sensors (e.g., photoelectric or proximity), relays, encoders, or PLC outputs. It **must** be installed by a qualified electrician.

## Step 1 – Prepare for Installation

There are four important pieces of information to obtain before starting the installation:

1. Determine where the signal inputs will be coming from (described in the previous chapter).
2. Determine where the ethernet drop will be located (used to access the XL web page interface).
3. Determine where the barcode scanner will be located (used by operators to enter down reasons). Place the barcode scanner near where the operator restarts the process after a stop.
4. Determine where the XL Productivity Appliance™ will be located (determine the optimum location for viewing across the manufacturing process).

## Step 2 – Hang Mount the Device

The XL device is designed to be hang mounted (i.e., suspended from a pair of chains).

- Chain must have a working load limit of not less than 400 pounds (182 kilograms).
- Chain material must be appropriate for the environment; for example, type 304L stainless steel for severe environments.
- Chain must be attached to each of the two end plates of the XL device through the provided mounting holes, each measuring a nominal 0.5" (12.7 mm) in diameter.

Attachment to the support structure and attachment to the XL device must use attaching devices (e.g., shackles) with the same working load limit and material considerations as described above.

Attachment points to the support structure should be at the same spacing as the width of the XL device (i.e., the same spacing as between the XL device end plates).



**WARNING:** Make sure that the supporting chain and attaching devices meet the above specifications. Failure to follow this warning could result in damage to property, personal injury, or death.

## Step 3 – Remove Access Plate



**SHOCK HAZARD:** This product has more than one source of power. Relay outputs may be at mains potential from a secondary power source. Always disconnect power from all power sources before installing or servicing the XL device, and before opening the user access plate. Do not reapply power until the access plate has been reinstalled and securely closed. Failure to follow these precautions could result in personal injury or death due to electric shock.



**CAUTION:** Keep mains-connected wiring (including relay output wiring) separate from signal and I/O wiring. Use the left knockout(s) for mains-connected wiring (including relay output wiring) and the right knockout for signal and I/O wiring.



**CAUTION:** Take care to pass all wiring through the back panel knockouts using cable glands that meet local electrical code. Make sure that any unused knockouts are plugged using hardware that meets local electrical code.

1. Verify that all sources of power have been completely disconnected from the XL device.
2. Remove and save the screws holding the access plate (eight to ten screws depending on model).
3. Gently pull the access plate away from the XL device. The access plate will remain connected to the XL device via its grounding strap.

## Step 4 – Take Note of Connector Locations

For the installation, you will need to connect:

- **RS-232** (for the barcode scanner)
- **High Speed Inputs** (to provide XL with signal inputs)
- **10/100 Ethernet** (to access XL over the network)

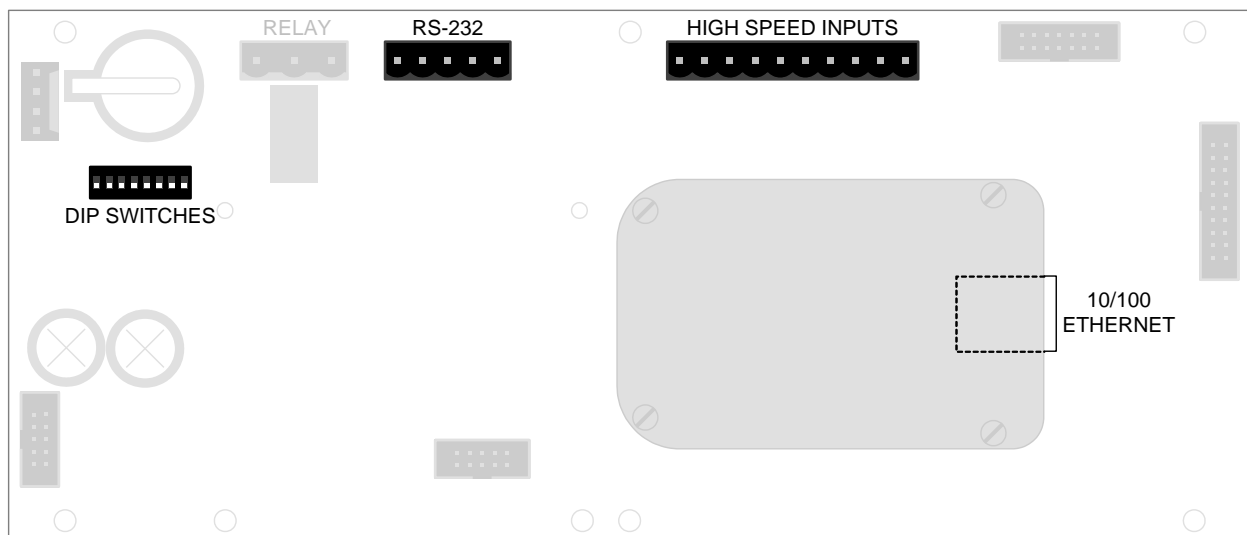



# Step 5 – Connect Signal Inputs

## Overview

XL uses either digital sinking inputs, or 5 to 24 VDC digital sourcing inputs (if providing multiple signal inputs, they must all be either sinking or sourcing).

Most XL users provide these signals from existing photoelectric sensors, proximity switches, relays, PLC (Programmable Logic Controller) outputs, or other devices that are physically appropriate for their manufacturing environment. The maximum signal frequency is 4,000 Hz.

Refer to **Appendix C** for digital input specifications.

## Connections

Wire your signal inputs to the 10-pin terminal block marked "HIGH SPEED INPUTS". This terminal block can be unplugged from the logic board to make wiring easier. Refer to the previous chapter for guidance on which dedicated digital inputs to connect:

- In Count (required; can also function as the Cycle Input)
- Out Count (optional; required for quality metrics if not manually scanning reject reasons)
- Cycle Input (optional; for multiple-step manufacturing processes)
- End of Line Count (optional; to count finished goods at the end of the process)

## Wiring Diagram for Sensors with Sinking (NPN) Outputs

Sensors are connected to power from the XL device. In Count and Reject Count are shown (additional sensors may be connected in the same way).

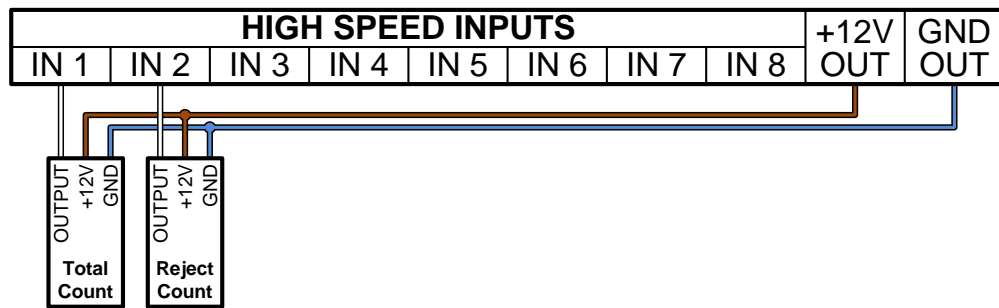

## Wiring Diagram for Sensors with Sourcing (PNP) Outputs

Sensors are connected to power from the XL device. In Count and Reject Count are shown (additional sensors may be connected in the same way).

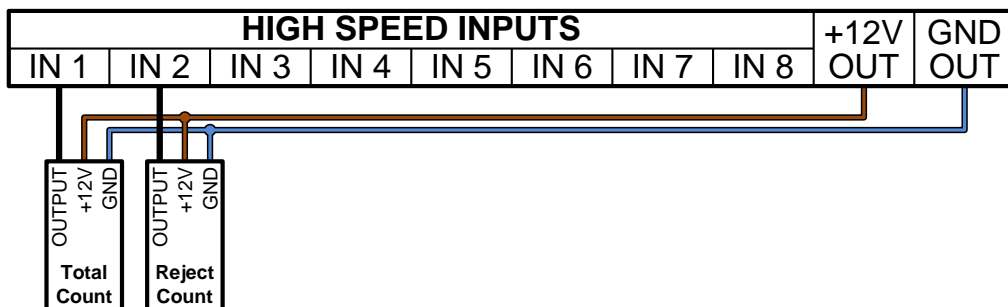

## Wiring Diagram for PLC Outputs

A shared DC ground is established between the PLC and the XL device. In Count and Reject Count are shown (additional PLC outputs may be connected in the same way).

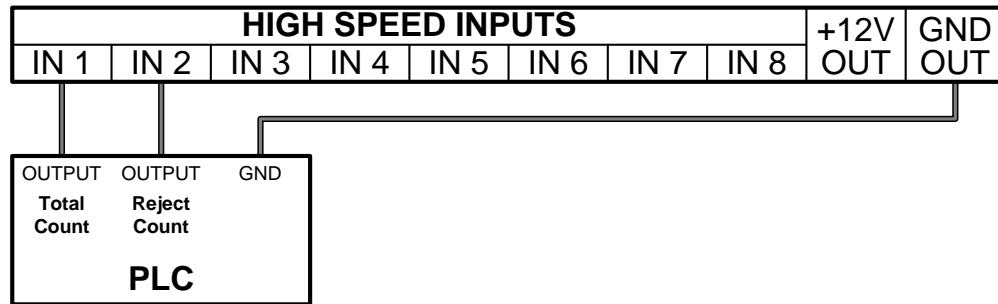

## Step 6 – Connect Barcode Scanner

XL is designed to interface to barcode scanners with an RS-232 output. The following instructions are based on XL Barcode Kits from Vorne.

1. Wire the XL barcode interface cable to the 5-pin terminal block marked "RS-232". This terminal block can be unplugged to make wiring easier:
  - Red wire to pin 1 (RxD1 ~ XL Receive Data).
  - Green wire to pin 2 (TxD1 ~ XL Transmit Data).
  - Black wire to pin 3 (GND ~ XL Ground).
2. Plug the male 9-pin D-sub connector at the end of the XL interface cable into the female 9-pin D-sub connector of the barcode scanner.
3. Plug the barrel connector of the AC adapter into its mating DC power receptacle in the barcode scanner:
  - Wired Scanners (the DC power receptacle is located on the back of the D-sub connector).
  - Wireless Scanners (the DC power receptacle is located on the base unit).
4. Plug the AC adapter into an AC power outlet.

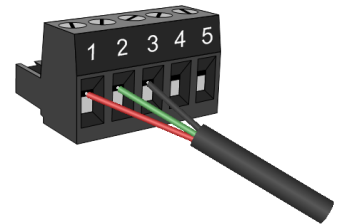

## Step 7 – Connect Ethernet Port

The XL device includes a 10/100 Ethernet port, which is used to connect XL to your local network. This port supports Auto-MDIX (automatic crossover) so either a straight-through or crossover cable can be used.

1. Gently plug one end of the Ethernet cable into the RJ45 jack on the XL logic board, latch side up (away from the board).
2. Plug the other end of the Ethernet cable into your local network drop.

## Step 8 – Reinstall Access Plate

Fasten the access plate to the back panel using the screws that were removed in **Step 3 – Remove Access Plate**.

## Step 9 – European Union: Install Clamp-On Ferrite Core



**ATTENTION:** A ferrite core must be installed on cables connected to Ethernet Cable to meet EU EMI suppression requirements.

A clamp-on ferrite core is provided with XL systems sold within the European Union. The Ethernet cable should be wrapped twice around the ferrite core.

1. Open the clamp-on ferrite core.
2. Position the ferrite core outside the XL system, as close as possible to where the signal wires exit the back panel.
3. Wrap the Ethernet cable twice through the ferrite core.
4. Close the ferrite core around the Ethernet cable.

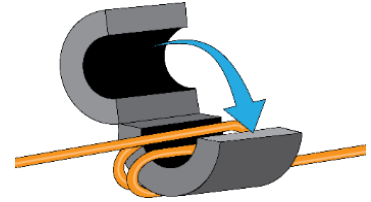

## Step 10 – Apply Power



**SHOCK HAZARD:** This product must be grounded. Never defeat the ground conductor or operate the product in the absence of a suitably installed ground conductor.



**ATTENTION:** This product is suitable for connection to a TN-S power distribution system (AC Hot and AC Neutral lines with a separate protective grounding conductor).



**ATTENTION:** Refer to **Appendix C – Specifications** for power requirements.

1. Apply mains power to the XL device.
2. Verify that the XL scoreboard lights up and starts showing information. The format of the information will depend on the XL model.

## Step 11 – Test Barcode Scanner

Scan this barcode to test the barcode scanner and its connection to XL. The XL display (XL810 shown) will show a message for five seconds indicating that the barcode connection test has passed.



# Appendix A – Relay Output



**WARNING:** XL products are not designed or intended for control applications, and **MUST NOT** be used for control applications under any circumstances. Outputs (e.g., relays) are provided for annunciation only, and **MUST NOT** be used for control purposes.



**CAUTION:** Keep mains-connected wiring (including relay output wiring) separate from signal and I/O wiring. Use the left knockout for mains-connected wiring (including relay output wiring) and the right knockout for signal and I/O wiring.



**CAUTION:** Carefully route relay output wiring to keep it away from electronic components inside the enclosure.

## Relay Output Operation

XL devices have one relay output on the main logic board. The relay output is intended to alert operators to down time, and to prompt them to scan a reason for a down event.

The relay behavior can be configured in the **Settings / Connections / Relay Output** page in the XL Web Page Interface. The relay can be configured as follows:

- When down time is detected, turn the relay on immediately. Turn off when a reason is scanned.
- When down time is detected, turn the relay on only after the process is running. Turn off when a reason is scanned, or a new down event is started.

## Relay Output Wiring

The relay output must only be used with a **resistive load**.

The current per relay contact must not exceed 1 Amp, and the voltage per relay contact must not exceed 30 VDC or 250 VAC.

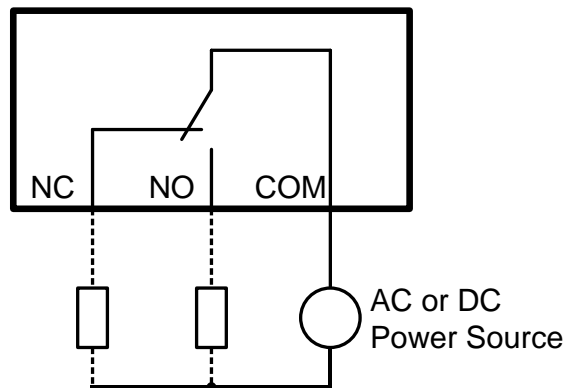

# Appendix B – DIP Switch Settings

All DIP Switches should be **OFF** for regular operation. Changes to DIP switch settings are recognized **only** at XL power-up. Carefully review the information in the table below before making any changes to DIP switch settings.



**SHOCK HAZARD:** This product has more than one source of power. Relay outputs may be at mains potential from a secondary power source. Always disconnect power from all power sources before installing or servicing the XL device, and before opening the user access plate. Do not reapply power until the access plate has been reinstalled and securely closed. Failure to follow these precautions could result in personal injury or death due to electric shock.

Switch	Function	Description
1	<b>Password Recovery</b>	Enables password recovery. OFF – Default                      ON – Password Recovery
2	<b>None</b>	Reserved
3	<b>None</b>	Reserved
4	<b>None</b>	Reserved
5	<b>None</b>	Reserved
6	<b>None</b>	Reserved
7	<b>None</b>	Reserved
8	<b>Lamp Test</b>	Turns on all LEDs on the scoreboard for visual verification. OFF – Default                      ON – Lamp Test

# Appendix C – Specifications

## Operating Conditions

Item	Specification
<b>Power</b>	100 to 240 VAC, 50 to 60 Hz (power and current requirements for each model are shown in <b>Model-Specific Specifications</b> below).
<b>Ambient Temperature</b>	32°F to 122°F (0°C to 50°C)
<b>Relative Humidity</b>	5% to 95% Non-Condensing

## Inputs and Outputs

Digital Inputs are configured through the XL web page interface by navigating to **Settings** > **Connections** > **Digital Inputs**. Refer to the **Configure XL** guide for step-by-step instructions.

Item	Specification
<b>High Speed Inputs</b>	(8) Digital Inputs, 5 to 24 VDC, port is configurable as Sink or Source via browser Low Speed (50 Hz max) or High Speed (4,000 Hz max) configurable via browser
<b>Relay Output</b>	(1) SPDT Relay, 30 VDC or 250 VAC at 1A (max), Resistive load only
<b>+12 VDC Power Out</b>	Supplies 100 ma (max) for sensors

## Communication Ports

Communication ports are configured through the XL web page interface by navigating to **Settings** > **Connections** > **Ethernet**.

Item	Specification
<b>Ethernet</b>	IEEE 802.3, 10/100 Mbps, Auto-MDIX, RJ-45
<b>Serial Ports</b>	(2) RS-232, 300 to 115.2k baud, Full-Duplex

## Model-Specific Specifications

All models include tricolor scoreboards (green, red, amber). The specified power represents maximum power (all LEDs on).

Model	Display Configuration	Dimensions – W x H x D	Weight	Power
<b>XL810-1</b>	Alphanumeric, 80-Column	26.2 x 13.7 x 3.5 in (67 x 35 x 9 cm)	19 lb (8.6 kg)	80 W
<b>XL810-2</b>	Alphanumeric, 160-Column	50.2 x 13.7 x 3.5 in (128 x 35 x 9 cm)	33 lb (15.0 kg)	160 W
<b>XL610</b>	Digital, 3-Line x 6-Digit 2.3 in (5.8 cm)	31.0 x 15.9 x 3.5 in (79 x 40 x 9 cm)	23 lb (10.4 kg)	50 W
<b>XL410</b>	Digital, 1-Line x 6-Digit 4.0 in (10.1 cm)	23.4 x 8.4 x 3.5 in (59 x 21 x 9 cm)	9 lb (4.1 kg)	30 W



# EU Declaration of Conformity

Name and Address of the manufacturer:

**Vorne Industries**  
**1445 Industrial Drive**  
**Itasca, Illinois**  
**USA 60143**

**Tel:** +1.630.875.3600  
**Email:** [support@vorne.com](mailto:support@vorne.com)

This declaration of conformity is issued under the sole responsibility of Vorne Industries, Inc.

## OBJECT OF THE DECLARATION

▪ Type of Object:	Production Monitoring System
▪ Regulatory Model:	XL810 Productivity Appliance
▪ Regulatory Type:	XL810-1
▪ Trade/Manufacturer Name:	Vorne Industries, Inc.

The object of the declaration described above is in conformity with the following directives:

- **DIRECTIVE 2014/30/EU** OF THE EUROPEAN PARLIAMENT AND OF THE COUNCIL of 26 February 2014 on the harmonization of the laws of the Member States relating to electromagnetic compatibility.
- **DIRECTIVE 2014/35/EU** OF THE EUROPEAN PARLIAMENT AND OF THE COUNCIL of 26 February 2014 on the harmonization of the laws of the Member States relating to the making available on the market of electrical equipment designed for use within certain voltage limits.
- **DIRECTIVE 2011/65/EU** OF THE EUROPEAN PARLIAMENT AND OF THE COUNCIL of 8 June 2011 on the restriction of the use of certain hazardous substances in the electrical and electronic equipment.

The object of the declaration described above has been assessed and found in compliance with the following harmonized standards, regulations, and technical references:

<b>SAFETY</b>	EN 60950-1:2006 + A11:2009 + A1:2010 + A12:2011 + A2:2013
<b>EMC</b>	EN 55011:2016/A1:2017 EN 55024:2010, A1:2015 EN 55032:2015 EN 61000-6-2:2005 EN 61000-6-4:2007, A1:2011 EN 61326-1:2013 EN 61000-3-2:2014 EN 61000-3-3:2013
<b>RoHS</b>	EN 50581:2012

**Itasca, Illinois, USA**

Place of Issue

**April 04, 2018**

Date of Issue

*Norman Vorne*

Signed for and on behalf of Vorne Industries, Inc.

**Norman Vorne**

Full Printed Name

**Vice-President**

Position/Title

**Vorne Industries**  
1445 Industrial Drive  
Itasca, IL 60143-1849  
USA