



Test Report issued under the responsibility of:



TEST REPORT IEC 62109-1 Safety of Power Converter for use in Photovoltaic Power Systems Part 1: General requirements	
Report Number :	230201452SHA-001
Date of issue :	2023-03-01
Total number of pages	89 Pages
Name of Testing Laboratory preparing the Report	Intertek Testing Services Shanghai Building No.86, 1198 Qinzhou Road (North), Shanghai 200233, China
Applicant's name	Afore New Energy Technology (Shanghai) Co., Ltd.
Address :	Build No.7, 333 Wanfang Road, Minhang District, Shanghai. China. 201112
Test specification:	
Standard	IEC/EN 62109-1:2010 (First Edition)
Test procedure	CE-LVD
Non-standard test method	N/A
Test Report Form No.	IEC62109_1B
Test Report Form(s) Originator	VDE Testing and Certification Institute
Master TRF	Dated 2016-04
Copyright © 2016 IEC System of Conformity Assessment Schemes for Electrotechnical Equipment and Components (IECEE System). All rights reserved. This publication may be reproduced in whole or in part for non-commercial purposes as long as the IECEE is acknowledged as copyright owner and source of the material. IECEE takes no responsibility for and will not assume liability for damages resulting from the reader's interpretation of the reproduced material due to its placement and context.	

Test item description	Hybrid inverter
Trade Mark	Afore
Manufacturer	Afore New Energy Technology (Shanghai) Co., Ltd. Build No.7, 333 Wanfang Road, Minhang District, Shanghai. China. 201112
Model/Type reference	AF*-TH (*=3K, 4K, 5K, 6K, 8K, 10K, 12K, 15K, 17K, 20K, 25K,30K) AF*-THP(*=3K, 4K, 5K, 6K, 8K, 10K, 12K)
Ratings	See below Specifications table

Specifications table				
Model	AF3K-TH	AF4K-TH	AF5K-TH	AF6K-TH
PV input				
P pv Max(kW)	5	6	7.5	9
Vmax PV (Vdc) (absolute Max.)	1000	1000	1000	1000
Isc PV (absolute Max.) (A)	30*2	30*2	30*2	30*2
Number MPP trackers	2	2	2	2
Number input strings	1/1	1/1	1/1	1/1
Max. PV input current (A)	20*2	20*2	20*2	20*2
MPPT voltage range (Vdc)	150-850	150-850	150-850	150-850
Vdc range @ full power (Vdc)	200-850	200-850	200-850	250-850
Battery (charge/discharge)				
Battery type	Li-ion/Lead-acid			
Battery Normal Voltage (Range) (Vdc)	150-800(Field adapt battery voltage range)			
Max charge/discharge Current(A)	30	30	30	30
Max charge/discharge Power(kW)	3	4	5	6
AC Grid (input and output)				
Normal AC Voltage (VAC)	3P+N+PE/3P+PE 230/400			
Frequency (Hz)	50			
Normal AC Current (A)	4.4	5.8	7.3	8.7
Max. cont. input/output current (A)	8 / 5.3	10.5 / 7	13 / 8.5	16 / 10.5
Rated Power (kW)	3	4	5	6
Rated Apparent Power (kVA)	3	4	5	6
Max. cont. input/output Power (kW)	4.5 / 3.3	6 / 4.4	7.5 / 5.5	9 / 6.6
Max. cont. Apparent input/output Power (KVA)	4.5 / 3.3	6 / 4.4	7.5 / 5.5	9 / 6.6
Power factor(adjustable)	1.0(-0.8~ +0.8)			
AC Load output (stand alone)				
Normal Voltage (VAC)	3P+N+PE/3P+PE 230/400			
Frequency (Hz)	50			
Nominal Current (A)	4.4	5.8	7.3	8.7
Max. cont. current (A)	5.3	7	8.5	10.5
Max. cont. Power (kW)	3	4	5	6
Rated Apparent Power (kVA)	3	4	5	6
Max. cont. Apparent Power (kVA)	3	4	5	6
Power factor	1.0			
Others				
Ingress protection (IP)	IP65			
Protective class	Class I			
Temperature (°C)	-25°C to +60°C (Derating 45°C)			
Inverter Isolation	Non-isolated (PV-AC-BAT)			
Overvoltage category	OVC III (AC Main), OVC II (PV)			
Firmware Version	V1.01			
Software Version	V01			

Specifications table				
Model	AF8K-TH	AF10K-TH	AF12K-TH	AF15K-TH
PV input				
P _{pv} Max(kW)	12	15	18	22.5
V _{max} PV (Vdc) (absolute Max.)	1000	1000	1000	1000
I _{sc} PV (absolute Max.) (A)	30*2	30*2	30*2	30+48
Number MPP trackers	2	2	2	2
Number input strings	1/1	1/1	1/1	1/2
Max. PV input current (A)	20*2	20*2	20*2	20+32
MPPT voltage range (Vdc)	150-850	150-850	150-850	150-850
V _{dc} range @ full power (Vdc)	300-850	500-850	500-850	500-850
Battery (charge/discharge)				
Battery type	Li-ion/Lead-acid			
Battery Normal Voltage (Range) (Vdc)	150-800(Field adapt battery voltage range)			
Max charge/discharge Current(A)	30	30	30	50
Max charge/discharge Power(kW)	8	10	12	15
AC Grid (input and output)				
Normal AC Voltage (VAC)	3P+N+PE/3P+PE 230/400			
Frequency (Hz)	50			
Normal AC Current (A)	11.6	14.5	17.4	21.8
Max. cont. input/output current (A)	20 / 13.5	26 / 17	32 / 21.5	40.5 / 27
Rated Power (kW)	8	10	12	15
Rated Apparent Power (kVA)	8	10	12	15
Max. cont. input/output Power (kW)	12 / 8.8	15 / 11	18 / 13.2	22.5 / 16.5
Max. cont. Apparent input/output Power (kVA)	12 / 8.8	15 / 11	18 / 13.2	22.5 / 16.5
Power factor(adjustable)	1.0(-0.8~ +0.8)			
AC Load output (stand alone)				
Normal Voltage (VAC)	3P+N+PE/3P+PE 230/400			
Frequency (Hz)	50			
Nominal Current (A)	11.6	14.5	17.4	21.8
Max. cont. current (A)	13.5	17	21.5	27
Max. cont. Power (kW)	8	10	12	15
Rated Apparent Power (kVA)	8	10	12	15
Max. cont. Apparent Power (kVA)	8	10	12	15
Power factor	1.0			
Others				
Ingress protection (IP)	IP65			
Protective class	Class I			
Temperature (°C)	-25°C to +60°C (Derating 45°C)			
Inverter Isolation	Non-isolated (PV-AC-BAT)			
Overvoltage category	OVC III (AC Main), OVC II (PV)			
Firmware Version	V1.01			
Software Version	V01			

Specifications table				
Model	AF3K-THP	AF4K-THP	AF5K-THP	AF6K-THP
PV input				
P _{pv} Max(kW)	5	6	7.5	9
V _{max} PV (Vdc) (absolute Max.)	1000	1000	1000	1000
I _{sc} PV (absolute Max.) (A)	30*2	30*2	30*2	30*2
Number MPP trackers	2	2	2	2
Number input strings	1/1	1/1	1/1	1/1
Max. PV input current (A)	20*2	20*2	20*2	20*2
MPPT voltage range (Vdc)	150-850	150-850	150-850	150-850
V _{dc} range @ full power (Vdc)	200-850	200-850	200-850	250-850
Battery (charge/discharge)				
Battery type	Li-ion/Lead-acid			
Battery Normal Voltage (Range) (Vdc)	80-600(Field adapt battery voltage range)			
Max charge/discharge Current(A)	50	50	50	50
Max charge/discharge Power(kW)	3	4	5	6
AC Grid (input and output)				
Normal AC Voltage (VAC)	3P+N+PE/3P+PE 230/400			
Frequency (Hz)	50			
Normal AC Current (A)	4.4	5.8	7.3	8.7
Max. cont. input/output current (A)	8 / 5.3	10.5 / 7	13 / 8.5	16 / 10.5
Rated Power (kW)	3	4	5	6
Rated Apparent Power (kVA)	3	4	5	6
Max. cont. input/output Power (kW)	4.5 / 3.3	6 / 4.4	7.5 / 5.5	9 / 6.6
Max. cont. Apparent input/output Power (KVA)	4.5 / 3.3	6 / 4.4	7.5 / 5.5	9 / 6.6
Power factor(adjustable)	1.0(-0.8~ +0.8)			
AC Load output (stand alone)				
Normal Voltage (VAC)	3P+N+PE/3P+PE 230/400			
Frequency (Hz)	50			
Nominal Current (A)	4.4	5.8	7.3	8.7
Max. cont. current (A)	5.3	7	8.5	10.5
Max. cont. Power (kW)	3	4	5	6
Rated Apparent Power (kVA)	3	4	5	6
Max. cont. Apparent Power (kVA)	3	4	5	6
Power factor	1.0			
Others				
Ingress protection (IP)	IP65			
Protective class	Class I			
Temperature (°C)	-25°C to +60°C (Derating 45°C)			
Inverter Isolation	Non-isolated (PV-AC-BAT)			
Overtoltage category	OVC III (AC Main), OVC II (PV)			
Firmware Version	V1.01			
Software Version	V01			

Specifications table			
Model	AF8K-THP	AF10K-THP	AF12K-THP
PV input			
P pv Max(kW)	12	15	18
Vmax PV (Vdc) (absolute Max.)	1000	1000	1000
Isc PV (absolute Max.) (A)	30*2	30*2	30*2
Number MPP trackers	2	2	2
Number input strings	1/1	1/1	1/1
Max. PV input current (A)	20*2	20*2	20*2
MPPT voltage range (Vdc)	150-850	150-850	150-850
Vdc range @ full power (Vdc)	300-850	500-850	500-850
Battery (charge/discharge)			
Battery type	Li-ion/Lead-acid		
Battery Normal Voltage (Range) (Vdc)	80-600(Field adapt battery voltage range)	120-650(Field adapt battery voltage range)	
Max charge/discharge Current(A)	50	50	50
Max charge/discharge Power(kW)	8	10	12
AC Grid (input and output)			
Normal AC Voltage (VAC)	3P+N+PE/3P+PE 230/400		
Frequency (Hz)	50		
Normal AC Current (A)	11.6	14.5	17.4
Max. cont. input/output current (A)	20 / 13.5	26 / 17	32 / 21.5
Rated Power (kW)	8	10	12
Rated Apparent Power (kVA)	8	10	12
Max. cont. input/output Power (kW)	12 / 8.8	15 / 11	18 / 13.2
Max. cont. Apparent input/output Power (kVA)	12 / 8.8	15 / 11	18 / 13.2
Power factor(adjustable)	1.0(-0.8~ +0.8)		
AC Load output (stand alone)			
Normal Voltage (VAC)	3P+N+PE/3P+PE 230/400		
Frequency (Hz)	50		
Nominal Current (A)	11.6	14.5	17.4
Max. cont. current (A)	13.5	17	21.5
Max. cont. Power (kW)	8	10	12
Rated Apparent Power (kVA)	8	10	12
Max. cont. Apparent Power (kVA)	8	10	12
Power factor	1.0		
Others			
Ingress protection (IP)	IP65		
Protective class	Class I		
Temperature (°C)	-25°C to +60°C (Derating 45°C)		
Inverter Isolation	Non-isolated (PV-AC-BAT)		
Overvoltage category	OVC III (AC Main), OVC II (PV)		
Firmware Version	V1.01		
Software Version	V01		

Specifications table				
Model	AF17K-TH	AF20K-TH	AF25K-TH	AF30K-TH
PV input				
P _{pv} Max(kW)	25.5	30	37.5	45
V _{max} PV (Vdc) (absolute Max.)	1000	1000	1000	1000
I _{sc} PV (absolute Max.) (A)	48*2	48*2	60*2	60*2
Number MPP trackers	2	2	2	2
Number input strings	2/2	2/2	2/2	2/2
Max. PV input current (A)	32*2	32*2	40*2	40*2
MPPT voltage range (Vdc)	150-850	150-850	150-850	150-850
V _{dc} range @ full power (Vdc)	500-850	500-850	500-850	500-850
Battery (charge/discharge)				
Battery type	Li-ion/Lead-acid			
Battery Normal Voltage (Range) (Vdc)	150-800(Field adapt battery voltage range)			
Max charge/discharge Current(A)	50	50	60	60
Max charge/discharge Power(kW)	17	20	25	30
AC Grid (input and output)				
Normal AC Voltage (VAC)	3P+N+PE/3P+PE 230/400			
Frequency (Hz)	50			
Normal AC Current (A)	24.7	29	36.3	43.5
Max. cont. input/output current (A)	45 / 30	48 / 32	60 / 40	72 / 48
Rated Power (kW)	17	20	25	30
Rated Apparent Power (kVA)	17	20	25	30
Max. cont. input/output Power (kW)	25.5 / 18.7	30 / 22	37.5 / 27.5	45 / 33
Max. cont. Apparent input/output Power (kVA)	25.5 / 18.7	30 / 22	37.5 / 27.5	45 / 33
Power factor(adjustable)	1.0(-0.8~ +0.8)			
AC Load output (stand alone)				
Normal Voltage (VAC)	3P+N+PE/3P+PE 230/400			
Frequency (Hz)	50			
Nominal Current(A)	24.7	29	36.3	43.5
Max. cont. current (A)	30	32	40	48
Max. cont. Power (kW)	17	20	25	30
Rated Apparent Power (kVA)	17	20	25	30
Max. cont. Apparent Power (kVA)	17	20	25	30
Power factor	1.0			
Others				
Ingress protection (IP)	IP65			
Protective class	Class I			
Temperature (°C)	-25°C to +60°C (Derating 45°C)			
Inverter Isolation	Non-isolated (PV-AC-BAT)			
Overvoltage category	OVC III (AC Main), OVC II (PV)			
Firmware	V1.01			
	V01			

Responsible Testing Laboratory (as applicable), testing procedure and testing location(s):		
<input checked="" type="checkbox"/> Testing Laboratory:	Intertek Testing Services Shanghai.	
Testing location/ address	Building No.86, 1198 Qinzhou Road (North), Shanghai 200233, China	
<input checked="" type="checkbox"/> Associated Testing Laboratory:		
Testing location/ address		
Tested by (name, function, signature) ...	Issac Chen	<i>Issac Chen</i>
Approved by (name, function, signature)	Sleif Sui	<i>Sleif Sui</i>
<hr/>		
<input type="checkbox"/> Testing procedure: CTF Stage 1:		
Testing location/ address		
Tested by (name, function, signature) ...		
Approved by (name, function, signature)		
<hr/>		
<input type="checkbox"/> Testing procedure: CTF Stage 2:		
Testing location/ address		
Tested by (name + signature).....		
Witnessed by (name, function, signature)		
Approved by (name, function, signature)		
<hr/>		
<input type="checkbox"/> Testing procedure: CTF Stage 3:		
<input type="checkbox"/> Testing procedure: CTF Stage 4:		
Testing location/ address		
Tested by (name, function, signature) ...		
Witnessed by (name, function, signature)		
Approved by (name, function, signature)		
Supervised by (name, function, signature)		

<p>List of Attachments (including a total number of pages in each attachment):</p> <p>Appendix 1: Photos of product-- total 16 pages (page 71-86) Appendix2-IEC 60529-- total 3 pages (page 87-89)</p>	
<p>Summary of testing: All tests were carried out according to IEC 62109-1:2010.</p>	
<p>Tests performed (name of test and test clause):</p> <ul style="list-style-type: none"> <input checked="" type="checkbox"/> 4.3 Thermal Test <input checked="" type="checkbox"/> 4.4 Testing in single fault condition <input checked="" type="checkbox"/> 4.6 Backfeed voltage protection test <input checked="" type="checkbox"/> 4.7 Electrical ratings tests <input checked="" type="checkbox"/> 5 Marking test <input checked="" type="checkbox"/> 6.3 IP test according IEC60529 <input checked="" type="checkbox"/> 7.3.6.3.3 Rating of protective bonding <input checked="" type="checkbox"/> 7.3.7 Insulation including clearance and creepage distances <input checked="" type="checkbox"/> 7.5.1 Impulse voltage test (type test) <input checked="" type="checkbox"/> 7.5.2 Voltage test (dielectric strength test) <input checked="" type="checkbox"/> 7.5.4 Touch current measurement <input type="checkbox"/> 8.3 Stability <input type="checkbox"/> 8.4 Provisions for lifting and carrying <input checked="" type="checkbox"/> 8.5 Wall mounting <input type="checkbox"/> 13.3.2.5 Cord anchorages and strain relief <input checked="" type="checkbox"/> 13.6.2.1 Stress relief test <input checked="" type="checkbox"/> 13.7 Mechanical resistance to deflection, impact, or drop 	<p>Testing location: Building No.86, 1198 Qinzhou Road (North), Shanghai 200233, China</p>
<p>Summary of compliance with National Differences (List of countries addressed): N/A</p> <p><input checked="" type="checkbox"/> The product fulfils the requirements of IEC/EN 62109-1:2010 (First Edition)</p>	

Copy of marking plate:

The artwork below may be only a draft. The use of certification marks on a product must be authorized by the respective NCBs that own these marks.

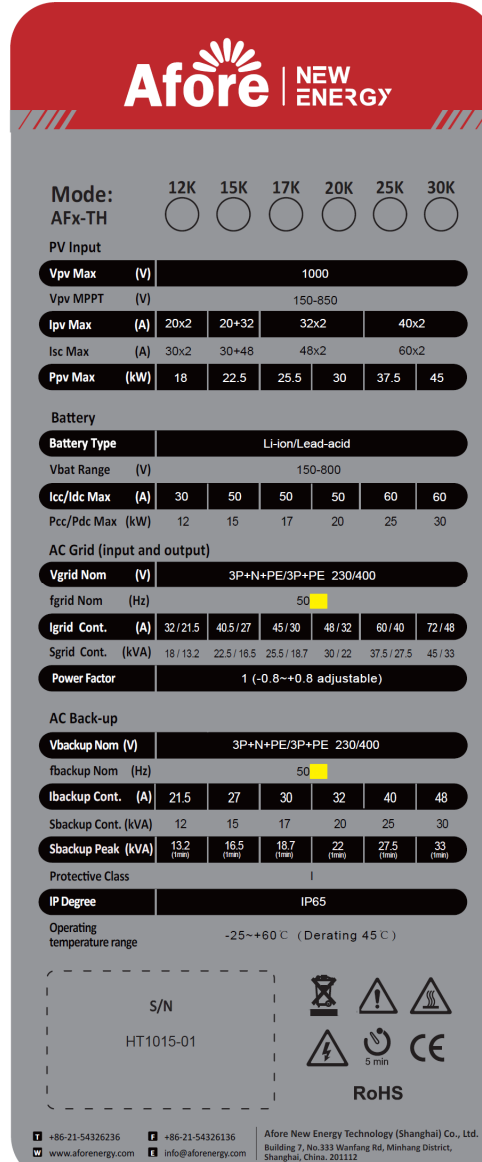

Series No.

T1230H0012305018

Remark:

1. The other model labels are same with above except model number and technical data.
2. Printed symbols shall be at least 2.75 mm high. Printed text characters shall be at least 1.5 mm high, whether upper case or lower case, and shall contrast in colour with the background.
3. The tenth to thirteenth of the serial number (2305): 23=year 05=week.
4. The information covered by **aaa** on marking plate was irrelevant to this report

Warning marking

WARNING

 **Hot surfaces**
To reduce the risk of burns. Do not touch.

 **Risk of electric shock**
Both AC and DC voltage sources are terminated inside this equipment. Each circuit must be individually disconnected before servicing and when the photovoltaic array is exposed to light, it supplies a DC voltage to this equipment.

 **Risk of electric shock from energy stored in capacitor.** Do not remove cover until 5 minutes after disconnecting all sources of supply.

 **Risk of electric shock, do not remove cover.** No user serviceable parts inside. Refer servicing to qualified service personnel.

 **Check user manual before service**
Refer to the operation instruction.

 **NO warranty for disassembled inverter**
Warranty doesn't provide for the inverter disassembled by non-authorized staff.

 WARNING:	POWER FED FROM MORE THAN ONE SOURCE
---	--

For continued protection against risk of fire, replace only with same type and ratings of fuse.

Test item particulars	
Equipment mobility	<input type="checkbox"/> movable <input type="checkbox"/> hand-held <input type="checkbox"/> stationary <input checked="" type="checkbox"/> fixed <input type="checkbox"/> transportable <input type="checkbox"/> for building-in
Connection to the mains	<input type="checkbox"/> pluggable equipment <input type="checkbox"/> direct plug-in <input checked="" type="checkbox"/> permanent connection <input type="checkbox"/> for building-in
Environmental category	<input checked="" type="checkbox"/> outdoor <input type="checkbox"/> indoor unconditional <input type="checkbox"/> indoor conditional
Over voltage category Mains	<input type="checkbox"/> OVC I <input type="checkbox"/> OVC II <input checked="" type="checkbox"/> OVC III <input type="checkbox"/> OVC IV
Over voltage category PV	<input type="checkbox"/> OVC I <input checked="" type="checkbox"/> OVC II <input type="checkbox"/> OVC III <input type="checkbox"/> OVC IV
Mains supply tolerance (%)	90 / +110 %
Tested for power systems	TN
IT testing, phase-phase voltage (V)	- - -
Class of equipment	<input checked="" type="checkbox"/> Class I <input type="checkbox"/> Class II <input type="checkbox"/> Class III <input type="checkbox"/> Not classified
Mass of equipment (kg)	Max.36 KG
Pollution degree	PD3 (PD2 internal)
IP protection class	IP65
..... :	
Possible test case verdicts:	
- test case does not apply to the test object	N/A
- test object does meet the requirement	P (Pass)
- test object does not meet the requirement	F (Fail)
Testing	
Date of receipt of test item	2023-02-20
Date (s) of performance of tests	2023-02-20 to 2023-03-01

General remarks:	
<p>The report only consider 230V 50Hz.</p> <p>Low voltage electrical installations shall comply with national and local regulation.</p> <p>"(See Enclosure #)" refers to additional information appended to the report.</p> <p>"(See appended table)" refers to a table appended to the report.</p> <p>Throughout this report a <input type="checkbox"/> comma / <input checked="" type="checkbox"/> point is used as the decimal separator.</p> <p>Standard IEC 62109-2:2011 is to be used in conjunction with IEC 62109-1:2010.</p> <p>The test results presented in this report relate only to the item tested. The results indicate that the specimen complies with standard" IEC 62109-1:2010 and IEC 62109-2:2011".</p> <p>Determination of the test conclusion is based on IEC Guide 115 in consideration of measurement uncertainty.</p> <p>This report is for the exclusive use of Intertek's Client and is provided pursuant to the agreement between Intertek and its Client. Intertek's responsibility and liability are limited to the terms and conditions of the agreement. Intertek assumes no liability to any party, other than to the Client in accordance with the agreement, for any loss, expense or damage occasioned by the use of this report. Only the Client is authorized to permit copying or distribution of this report and then only in its entirety. Any use of the Intertek name or one of its marks for the sale or advertisement of the tested material, product or service must first be approved in writing by Intertek. The observations and test results in this report are relevant only to the sample tested. This report by itself does not imply that the material, product, or service is or has ever been under an Intertek certification program.</p>	
Manufacturer's Declaration per sub-clause 4.2.5 of IEC 02:	
<p>The application for obtaining a CB Test Certificate includes more than one factory location and a declaration from the Manufacturer stating that the sample(s) submitted for evaluation is (are) representative of the products from each factory has been provided..... :</p>	<p><input type="checkbox"/> Yes</p> <p><input checked="" type="checkbox"/> Not applicable</p>
When differences exist; they shall be identified in the General product information section.	
<p>Name and address of factory (ies) : Afore New Energy Technology (Shanghai) Co., Ltd. Build No.7, 333 Wanfang Road, Minhang District, Shanghai. China. 201112</p>	

General product information:

The testing item is a Hybrid inverter for indoor or outdoor installation.
 The Inverter is three-phase type and non-isolated between PV, BATT and AC output.
 The internal control is redundantly built. It contains a main DSP and a slave DSP
 PE terminal on external and internal enclosure.
 The off grid port is grounding when the unit workings at stand alone mode by relay. The final used earth system shall comply the local code requirement.
 The inverter has adjustable power factor function. But the function is not available for this test report.
 And The testing performed on typical model: Max power model.

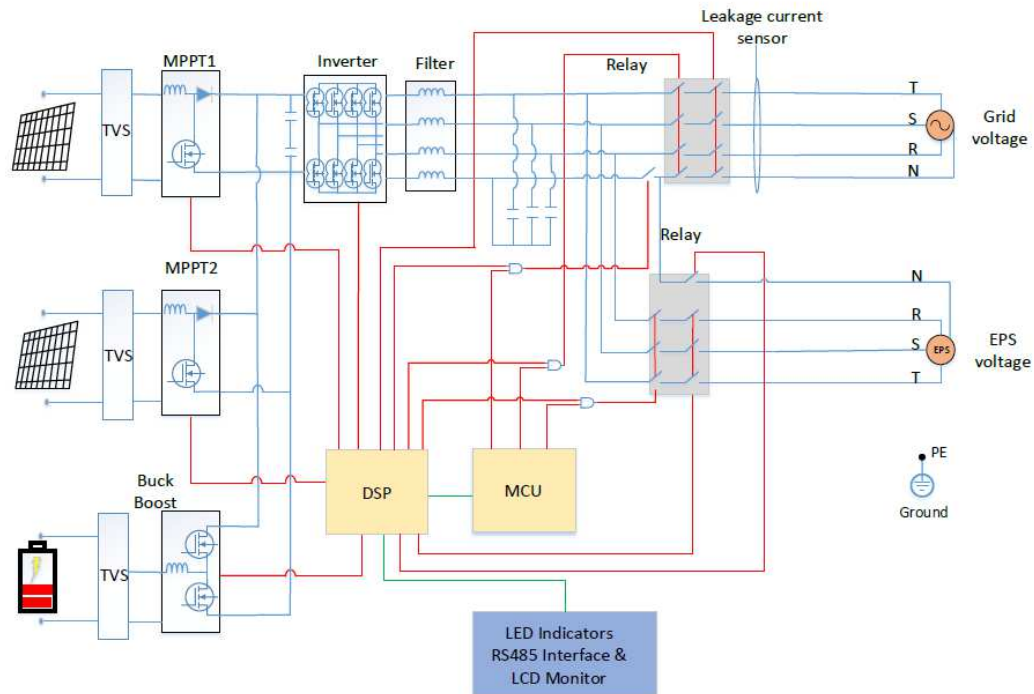

Model difference:

All models have same circuit, PWB layout and software, and differences between models are output rating, PV input string number and fan number.

Model AF3K-TH, AF4K-TH, AF5K-TH, AF6K-TH, AF8K-TH, AF10K-TH, AF12K-TH, AF3K-THP, AF4K-THP, AF5K-THP, AF6K-THP, AF8K-THP, AF10K-THP, AF12K-THP have 2 MPPT trackers with 2 input strings.

Model AF15K-TH has 2MPPT trackers with 3 input strings, and model AF17K-TH, AF20K-TH, AF25K-TH, AF30K-TH have 2MPPT trackers with 4 input strings.

Model AF3K-TH, AF4K-TH, AF5K-TH, AF6K-TH, AF8K-TH, AF3K-THP, AF4K-THP, AF5K-THP, AF6K-THP, AF8K-THP have no external fan, and model AF10K-TH, AF12K-TH, AF10K-THP, AF12K-THP, AF15K-TH, AF17K-TH, AF20K-TH, AF25K-TH, AF30K-TH have 2 external fans and 1 internal fan.

The BAT port current of Model AF3K-TH, AF4K-TH, AF5K-TH, AF6K-TH, AF8K-TH, AF10K-TH, AF12K-TH is 30A, and the BAT port current of model AF3K-THP, AF4K-THP, AF5K-THP, AF6K-THP, AF8K-THP, AF10K-THP, AF12K-THP is 50A.

IEC 62109-1			
Clause	Requirement + Test	Result - Remark	Verdict

4	GENERAL TESTING REQUIREMENTS		P
4.1	General		P
4.2	General conditions for testing		P
4.2.1	Sequence of tests		P
4.2.2	Reference test conditions		P
4.2.2.1	Environmental conditions		P
4.2.2.2	State of equipment		P
4.2.2.3	Position of equipment		P
4.2.2.4	Accessories		P
4.2.2.5	Covers and removable parts		P
4.2.2.6	Mains supply a) Voltage: b) Frequency: c) Polarity: d) Earthing: e) Over-current Protection:	3 ϕ /N/PE, 230Vac; 50Hz; Earthed Have over-voltage Protection	P
4.2.2.7	Supply ports other than the mains	PV input	P
4.2.2.7.1	Photovoltaic supply sources a) Open circuit voltage: b) Short-circuit current:		P
4.2.2.7.2	Battery inputs		P
4.2.2.8	Conditions of loading for output ports		P
4.2.2.9	Earthing terminals	Protective conductor terminal was connected to earth. No functional earth terminal.	P
4.2.2.10	Controls		P
4.2.2.11	Available short circuit current		P
4.3	Thermal testing	see appended table 4.3	P
4.3.1	General		P
4.3.2	Maximum temperatures		P
4.3.2.1	General		P
4.3.2.2	Touch temperatures		P
4.3.2.3	Temperature limits for mounting surfaces	see appended table 4.3	P
4.4	Testing in single fault condition	see appended table 4.4	P

IEC 62109-1			
Clause	Requirement + Test	Result - Remark	Verdict
4.4.1	General		P
4.4.2	Test conditions and duration for testing under fault conditions		P
4.4.2.1	General		P
4.4.2.2	Duration of tests		P
4.4.3	Pass/fail criteria for testing under fault conditions		P
4.4.3.1	Protection against shock hazard		P
4.4.3.2	Protection against the spread of fire		P
4.4.3.3	Protection against other hazards		P
4.4.3.4	Protection against parts expulsion hazards		P
4.4.4	Single fault conditions to be applied		P
4.4.4.1	Component fault tests		P
4.4.4.2	Equipment or parts for short-term or intermittent operation		P
4.4.4.3	Motors	Fans	P
4.4.4.4	Transformer short circuit tests		P
4.4.4.5	Output short circuit		P
4.4.4.6	Backfeed current test for equipment with more than one source of supply		P
4.4.4.7	Output overload		P
4.4.4.8	Cooling system failure		P
4.4.4.9	Heating devices	No heating devices used	N/A
4.4.4.10	Safety interlock systems	No safety interlock	N/A
4.4.4.11	Reverse d.c. connections		P
4.4.4.12	Voltage selector mismatch	No voltage selector	N/A
4.4.4.13	Mis-wiring with incorrect phase sequence or polarity		P
4.4.4.14	Printed wiring board short-circuit test		N/A
4.5	Humidity preconditioning		P
4.5.1	General		P
4.5.2	Conditions	93% RH, 40 °C, 48 h	P
4.6	Backfeed voltage protection		P
4.6.1	Backfeed tests under normal conditions		P
4.6.2	Backfeed tests under single-fault conditions		P
4.6.3	Compliance with backfeed tests		P

IEC 62109-1			
Clause	Requirement + Test	Result - Remark	Verdict
4.7	Electrical ratings tests	see appended table 4.7	P
4.7.1	Input ratings		P
4.7.1.1	Measurement requirements for DC input ports		P
4.7.2	Output ratings		P
5	MARKING AND DOCUMENTATION		P
5.1	Marking		P
5.1.1	General	Label is attached	P
	Equipment shall bear markings as specified in 5.1 and 5.2		P
	Graphic symbols may be used and shall be in accordance with Annex C or IEC 60417 as applicable.		P
	Graphic symbols shall be explained in the documentation provided with the PCE.		P
5.1.2	Durability of markings		P
	Markings required by this clause to be located on the PCE shall remain clear and legible under conditions of NORMAL USE and resist the effects of cleaning agents specified by the manufacturer		P
5.1.3	Identification		P
	The equipment shall, as a minimum, be permanently marked with:		P
	a) the name or trade mark of the manufacturer or supplier	see marking plate	P
	b) model number, name or other means to identify the equipment	see marking plate	P
	c) a serial number, code or other marking allowing identification of manufacturing location and the manufacturing batch or date within a three month time period.	see marking plate	P
5.1.4	Equipment ratings		P
	Unless otherwise specified in another part of IEC 62109, the following ratings, as applicable shall be marked on the equipment:		P
	– input voltage, type of voltage (a.c. or d.c.), frequency, and max. continuous current for each input	see marking plate	P
	– output voltage, type of voltage (a.c. or d.c.), frequency, max. continuous current, and for a.c. outputs, either the power or power factor for each output	see marking plate	P

IEC 62109-1			
Clause	Requirement + Test	Result - Remark	Verdict
	– the ingress protection (IP) rating as in 6.3 below	see marking plate (IP65)	P
5.1.5	Fuse identification		P
	Marking shall be located adjacent to each fuse or fuseholder, or on the fuseholder, or in another location provided that it is obvious to which fuse the marking applies, giving the fuse current rating and where fuses of different voltage rating value could be fitted, the fuse voltage rating.	750Vdc,100A	P
	Where fuses with special fusing characteristics such as time delay or breaking capacity are necessary, the type shall also be indicated	Interrupting 50kA	P
	For fuses not located in operator access areas and for soldered-in fuses located in operator access areas, it is permitted to provide an unambiguous cross-reference (for example, F1, F2, etc.) to the servicing instructions which shall contain the relevant information.		P
5.1.6	Terminals, Connections, and Controls		P
	If necessary for safety, an indication shall be given of the purpose of Terminals, connectors, controls, and indicators, and their various positions, including any connections for coolant fluids such as water and drainage. The symbols in Annex C may be used, and where there is insufficient space, symbol 9 of Annex C may be used.	Ground terminals are marked with relevant explanation. PV port with PV special connector AC port with special connector or terminals	P
	Push-buttons and actuators of emergency stop devices, and indicator lamps used only to indicate a warning of danger or the need for urgent action shall be coloured red.	No such components	N/A
	A multiple-voltage unit shall be marked to indicate the particular voltage for which it is set when shipped from the factory. The marking is allowed to be in the form of a paper tag or any other non-permanent material.	The PCE is not intended to connect to multiple-voltage and there is no voltage setting device	N/A
	A unit with d.c. terminals shall be plainly marked indicating the polarity of the connections, with:	PV port with PV special connector and with + -	P
	– the sign “+” for positive and “-” for negative; or		P
	– a pictorial representation illustrating the proper polarity where the correct polarity can be unambiguously determined from the representation		N/A
5.1.6.1	Protective Conductor Terminals		P
	The means of connection for the protective earthing conductor shall be marked with:		P
	– symbol 7 of Annex C; or		P
	– the letters “PE “; or		N/A

IEC 62109-1			
Clause	Requirement + Test	Result - Remark	Verdict
	– the colour coding green-yellow.		P
5.1.7	Switches and circuit-breakers		N/A
	The on and off-positions of switches and circuits breakers shall be clearly marked. If a push-button switch is used as the power switch, symbols 10 and 16 of Annex C may be used to indicate the on-position, or symbols 11 and 17 to indicate the off-position, with the pair of symbols (10 and 16, or 11 and 17) close together.		N/A
5.1.8	Class II Equipment	Class I	N/A
	Equipment using Class II protective means throughout shall be marked with symbol 12 of Annex C. Equipment which is only partially protected by DOUBLE INSULATION or REINFORCED INSULATION shall not bear symbol 12 of Table Annex C.		N/A
	Where such equipment has provision for the connection of an earthing conductor for functional reasons (see 7.3.6.4) it shall be marked with symbol 6 of Annex C		N/A
5.1.9	Terminal boxes for External Connections		P
	Where required by note 1 of Table 2 as a result of high temperatures of terminals or parts in the wiring compartment, there shall be a marking, visible beside the terminal before connection, of either:		N/A
	a) the minimum temperature Rating and size of the cable to be connected to the TERMINALS; or		N/A
	b) a marking to warn the installer to consult the installation instruction. Symbol 9 of Table D-1 is an acceptable marking		P
5.2	Warning markings		P
5.2.1	Visibility and legibility requirements for warning markings	Warning marking marked on enclosure.	P
	Warning markings shall be legible, and shall have minimum dimensions as follows:		P
	– Printed symbols shall be at least 2,75 mm high		P
	– Printed text characters shall be at least 1.5 mm high and shall contrast in colour with the background		P
	– Symbols or text that are moulded, stamped or engraved in a material shall have a character height of at least 2,0 mm, and if not contrasting in colour from the background, shall have a depth or raised height of at least 0,5 mm.		P

IEC 62109-1			
Clause	Requirement + Test	Result - Remark	Verdict
	If it is necessary to refer to the instruction manual to preserve the protection afforded by the equipment, the equipment shall be marked with symbol 9 of Annex C		P
	Symbol 9 of Annex C is not required to be used adjacent to symbols that are explained in the manual		P
5.2.2	Content for warning markings		P
5.2.2.1	Ungrounded heat sinks and similar parts	No ungrounded heat sink	N/A
	An ungrounded heat sink or other part that may be mistaken for a grounded part and involves a risk of electric shock in accordance with 7.3 shall be marked with symbol 13 of Annex C, or equivalent. The marking may be on or adjacent to the heat sink and shall be clearly visible when the PCE is disassembled to the extent that a risk of contact with the heat sink exists.		N/A
5.2.2.2	Hot Surfaces		P
	A part of the PCE that exceeds the temperature limits specified in 4.3.2 shall be marked with symbol 14 of Annex C or equivalent.		P
5.2.2.3	Coolant	No coolant used	N/A
	A unit containing coolant that exceeds 70 °C shall be legibly marked externally where readily visible after installation with symbol 15 of Annex C. The documentation shall provide a warning regarding the risk of burns from hot coolant, and either:		N/A
	a) statement that coolant system servicing is to be done only by SERVICE PERSONNEL, or		N/A
	b) instructions for safe venting, draining, or otherwise working on the cooling system, if these operations can be performed without OPERATOR access to HAZARDS internal to the equipment		N/A
5.2.2.4	Stored energy		P
	Where required by 7.3.9.2 or 7.4.2 the PCE shall be marked with Symbol 21 of Annex C and the time to discharge capacitors to safe voltage and energy levels shall accompany the symbol.		P
5.2.2.5	Motor guarding		P
	Where required by 8.2 a marking shall be provided where it is visible to service personnel before removal of a guard, warning of the hazard and giving instructions for safe servicing (for example disconnection of the source before removing the guard).		N/A
5.2.3	Sonic hazard markings and instructions		N/A
	If required by 10.2.1 a PCE shall:		N/A

IEC 62109-1			
Clause	Requirement + Test	Result - Remark	Verdict
	a) be marked to warn the operator of the sonic pressure hazard; or		N/A
	b) be provided with installation instructions that specify how the installer can ensure that the sound pressure level from equipment at its point of use after installation, will not reach a value, which could cause a hazard. These instructions shall include the measured sound pressure level, and shall identify readily available and practicable protective materials or measures which may be used.		N/A
5.2.4	Equipment with multiple sources of supply		P
	A PCE with connections for multiple energy sources shall be marked with symbol 13 of Annex C and the manual shall contain the information required in 5.3.4.	PV array, AC MAINS	P
	The symbol shall be located on the outside of the unit or shall be prominently visible behind any cover giving access to hazardous parts.		P
5.2.5	Excessive touch current		N/A
	Where required by 7.3.6.3.7 the PCE shall be marked with symbol 15 of Annex C. See also 5.3.2 for information to be provided in the installation manual.		N/A
5.3	Documentation		P
5.3.1	General		P
	The documentation provided with the PCE shall provide the information needed for the safe operation, installation, and (where applicable) maintenance of the equipment. The documentation shall include the items required in 5.3.2 through 5.3.4, and the following:		P
	a) explanations of equipment makings, including symbols used		P
	b) location and function of terminals and controls		P
	c) all ratings or specifications that are necessary to safely install and operate the PCE, including the following environmental ratings along with an explanation of their meaning and any resulting installation requirements:		P
	– ENVIRONMENTAL CATEGORY as per 6.1	For outdoor use	P
	– WET LOCATIONS classification for the intended external environment as per 6.1	Wet Locations	P
	– POLLUTION DEGREE classification for the intended external environment as per 6.2	PD3(external), PD2(internal)	P
	– INGRESS PROTECTION rating as per 6.3	IP65	P

IEC 62109-1			
Clause	Requirement + Test	Result - Remark	Verdict
	– Ambient temperature and relative humidity ratings	-25°C to 60°C 0-100 % condensing	P
	– MAXIMUM altitude rating		P
	– OVERVOLTAGE CATEGORY assigned to each input and output port as per 7.3.7.1.2, accompanied by guidance regarding how to ensure that the installation complies with the required overvoltage categories;	PV: II Mains: III	P
	d) a warning that when the photovoltaic array is exposed to light, it supplies a d.c. voltage to the PCE		P
5.3.1.1	Language	English	P
	Instructions related to safety shall be in a language that is acceptable in the country where the equipment is to be installed.		P
5.3.1.2	Format		P
	In general, the documentation must be provided in printed form and is to be delivered with the equipment.	Printed form provided	P
	For equipment which requires the use of a computer for both installation and operation, documentation may be provided in electronic format without accompanying printed format.		N/A
5.3.2	Information related to installation		P
	The documentation shall include installation and where applicable, specific commissioning instructions and, if necessary for safety, warnings against hazards which could arise during installation or commissioning of the equipment. The information provided shall include:	As specified in user manual, refer to information related to installation	P
	a) assembly, location, and mounting requirements:		P
	b) ratings and means of connection to each source of supply and any requirements related to wiring and external controls, colour coding of leads, disconnection means, or overcurrent protection needed, including instructions that the installation position shall not prevent access to the disconnection means;		P
	c) ratings and means of connection of any outputs from the PCE, and any requirements related to wiring and external controls, colour coding of leads, or overcurrent protection needed;		P
	d) explanation of the pin-out of connectors for external connections, unless the connector is used for a standard purpose (e.g. RS 232)		P
	e) ventilation requirements;		P

IEC 62109-1			
Clause	Requirement + Test	Result - Remark	Verdict
	f) requirements for special services, for example cooling liquid;		N/A
	g) instructions and information relating to sound pressure level if required by 10.2.1;		N/A
	h) where required by 14.8.1.3, instructions for the adequate ventilation of the room or location in which PCE containing vented or valve-regulated batteries is located, to prevent the accumulation of hazardous gases;	No such battery	N/A
	i) tightening torque to be applied to wiring terminals;		N/A
	j) values of backfeed short-circuit currents available from the PCE on input and output conductors under fault conditions, if those currents exceed the max. rated current of the circuit, as per 4.4.4.6;		N/A
	k) for each input to the PCE, the max value of short-circuit current available from the source, for which the PCE is designed; and		P
	l) compatibility with RCD and RCM;	Should be comply with local national code	N/A
	m) instructions for protective earthing, including the information required by 7.3.6.3.7 if a second protective earthing conductor is to be installed:		P
	n) where required by 7.3.8, the installation instructions shall include the following or equivalent wording:		N/A
	“This product can cause a d.c. current in the external protective earthing conductor. Where a residual current-operated protective (RCD) or monitoring (RCM) device is used for protection in a case of direct or indirect contact, only an RCD or RCM of Type B is allowed on the supply side of this product.”	Should be comply with local national code	N/A
	o) for PCE intended to charge batteries, the battery nominal voltage rating, size, and type		N/A
	p) PV array configuration information, such as ratings, whether the array is to be grounded or floating, any external protection devices needed, etc.		N/A
5.3.3	Information related to operation	As specified in user manual, refer to information related to operation	P
	Instructions for use shall include any operating instructions necessary to ensure safe operation, including the following, as applicable:		P
	– Instructions for adjustment of controls including the effects of adjustment;		P

IEC 62109-1			
Clause	Requirement + Test	Result - Remark	Verdict
	– Instructions for interconnection to accessories and other equipment, including indication of suitable accessories, detachable parts and any special materials;		P
	– Warnings regarding the risk of burns from surfaces permitted to exceed the temperature limits of 4.3.2 and required operator actions to reduce the risk; and		P
	– Instructions, that if the equipment is used in a manner not specified by the manufacturer, the protection provided by the equipment may be impaired.		P
5.3.4	Information related to maintenance		P
	Maintenance instructions shall include the following:	Maintenance made only by authorized service personal	P
	– Intervals and instructions for any preventive maintenance that is required to maintain safety (for example air filter replacement or periodic re-tightening of terminals);		P
	– Instructions for accessing operator access areas, if any are present, including a warning not to enter other areas of the equipment;		P
	– Part numbers and instructions for obtaining any required operator replaceable parts;		P
	– Instructions for safe cleaning (if recommended)		P
	– Where there is more than one source of supply energizing the PCE, information shall be provided in the manual to indicate which disconnect device or devices are required to be operated in order to completely isolate the equipment.		P
5.3.4.1	Battery maintenance	No battery	N/A
	Where required by 14.8.5, the documentation shall include the applicable items from the following list of instructions regarding maintenance of batteries:		N/A
	– Servicing of batteries should be performed or supervised by personnel knowledgeable about batteries and the required precautions		N/A
	– When replacing batteries, replace with the same type and number of batteries or battery packs		N/A
	– General instructions regarding removal and installation of batteries		N/A
	– CAUTION: Do not dispose of batteries in a fire. The batteries may explode.		N/A

IEC 62109-1			
Clause	Requirement + Test	Result - Remark	Verdict
	– CAUTION: Do not open or damage batteries. Released electrolyte is harmful to the skin and eyes. It may be toxic.		N/A
	– CAUTION: A battery can present a risk of electrical shock and high short-circuit current. The following precautions should be observed when working on batteries:		N/A
	a) Remove watches, rings, or other metal objects.		N/A
	b) Use tools with insulated handles.		N/A
	c) Wear rubber gloves and boots.		N/A
	d) Do not lay tools or metal parts on top of batteries		N/A
	e) Disconnect charging source prior to connecting or disconnecting battery terminals		N/A
	f) Determine if battery is inadvertently grounded. If inadvertently grounded, remove source from ground. Contact with any part of a grounded battery can result in electrical shock. The likelihood of such shock can be reduced if such grounds are removed during installation and maintenance (applicable to equipment and remote battery supplies not having a grounded supply circuit).		N/A
6	ENVIRONMENTAL REQUIREMENTS AND CONDITIONS		P
	The manufacturer shall rate the PCE for the following environmental conditions:		P
	– ENVIRONMENTAL CATEGORY, as in 6.1 below	Outdoor	P
	– Suitability for WET LOCATIONS or not	Yes	P
	– POLLUTION DEGREE rating in 6.2 below	PD3	P
	– INGRESS PROTECTION (IP) rating, as in 6.3 below	IP65	P
	– Ultraviolet (UV) exposure rating, as in 6.4 below	Metal enclosure	P
	– Ambient temperature and relative humidity ratings, as in 6.5 below	-25°C~+60°C, 0-100%, condensing	P
6.1	Environmental categories and minimum environmental conditions		P
6.1.1	Outdoor		P
6.1.2	Indoor, unconditioned		N/A
6.1.3	Indoor, conditioned		N/A
6.2	Pollution degree	PD3	P
6.3	Ingress Protection	IP65	P
6.4	UV exposure	For LCD panel	P

IEC 62109-1			
Clause	Requirement + Test	Result - Remark	Verdict
6.5	Temperature and humidity	-25°C~+60°C, 0-100%, condensing	P
7	PROTECTION AGAINST ELECTRIC SHOCK AND ENERGY HAZARDS		P
7.1	General		P
7.2	Fault conditions		P
7.3	Protection against electric shock		P
7.3.1	General	Earthed metal enclosure protects against direct contact	P
7.3.2	Decisive voltage classification		P
7.3.2.1	Use of decisive voltage class (DVC)		P
7.3.2.2	Limits of DVC (according table 6)	DVC-C output circuit,	P
7.3.2.3	Short-terms limits of accessible voltages under fault conditions	No accessible voltage exceeds DVC A during fault condition.	P
7.3.2.4	Requirements for protection (according table 7)		P
7.3.2.5	Connection to PELV and SELV circuits		P
7.3.2.6	Working voltage and DVC		P
7.3.2.6.1	General		P
7.3.2.6.2	AC working voltage (see Figure 2)		P
7.3.2.6.3	DC working voltage (see Figure 3)		P
7.3.2.6.4	Pulsating working voltage (see Figure 4)		P
7.3.3	Protective separation		P
	Protective separation shall be achieved by:		P
	<ul style="list-style-type: none"> ▪ double or reinforced insulation, or 	Reinforced insulation between DC input & AC output to communication circuit	P
	<ul style="list-style-type: none"> ▪ protective screening, i.e. by a conductive screen connected to earth by protective bonding in the PCE, or connected to the protective earth conductor itself, whereby the screen is separated from live parts by at least basic insulation, or 	Live part to enclosure	P
	<ul style="list-style-type: none"> ▪ protective impedance comprising limitation of current per 7.3.5.3 and of discharged energy per 7.3.5.4, or 		N/A
	<ul style="list-style-type: none"> ▪ limitation of voltage according to 7.3.5.4. 		N/A

IEC 62109-1			
Clause	Requirement + Test	Result - Remark	Verdict
	The protective separation shall be fully and effectively maintained under all conditions of intended use of the PCE		P
7.3.4	Protection against direct contact	Well earthed metal enclosure used.	P
7.3.4.1	General		P
	Protection against direct contact is employed to prevent persons from touching live parts that do not meet the requirements of 7.3.5 and shall be provided by one or more of the measures given in 7.3.4.2 (enclosures and barriers) and 7.3.4.3 (insulation).	Enclosure provided	P
	Open type sub-assemblies and devices do not require protective measures against direct contact but the instruction provided with the equipment must indicate that such measures must be provided in the end equipment or in the installation.	No such components	N/A
	Product intended for installation in CLOSED ELECTRICAL OPERATING AREAS, (see 3.9) need not have protective measures against direct contact, except as required by 7.3.4.2.4.		N/A
7.3.4.2	Protection by means of enclosures and barriers		P
	The following requirements apply where protection against contact with live parts is provided by enclosures or barriers, not by insulation in accordance with 7.3.4.3.	IP 65 enclosure provided to prevent access to inside live parts	P
7.3.4.2.1	General		P
	Parts of enclosures and barriers that provide protection in accordance with these requirements shall not be removable without the use of a tool (see 7.3.4.2.3).		P
	Polymeric materials used to meet these requirements shall also meet the requirements of 13.6		N/A
7.3.4.2.2	Access probe criteria		P
	Protection is considered to be achieved when the separation between the test probes and live parts, when tested as described below, is as follows:	IP 65 enclosure	P
	a) decisive voltage classification A, (DVC A) - the probe may touch the live parts		P
	b) decisive voltage classification B, (DVC B) - the probe must not touch bare live parts		P
	c) decisive voltage classification C, (DVC C) – the probe must have adequate clearance to live parts, based on the clearance for Basic insulation using the recurring peak working voltage involved,		P
7.3.4.2.3	Access probe tests		P

IEC 62109-1			
Clause	Requirement + Test	Result - Remark	Verdict
	Compliance with 7.3.4.2.1 is checked by all of the following:		P
	a) Inspection; and		P
	b) Tests with the test finger (Figure D.1) and test pin (Figure D.2) of Annex E, the results of which shall comply with the requirements of 7.3.4.2.1 a), b), and c) as applicable. Probe tests are performed on openings in the enclosures after removal of parts that can be detached or opened by an operator without the use of a tool, including fuseholders, and with operator access doors and covers open. It is permitted to leave lamps in place for this test. Connectors that can be separated by an operator without use of a tool, shall also be tested during and after disconnection. Any movable parts are to be put in the most unfavourable position.		P
	The test finger and the test pin are applied as above, without appreciable force, in every possible position, except that floor-standing equipment having a mass exceeding 40 kg is not tilted.		P
	Equipment intended for building-in or rack mounting, or for incorporation in larger equipment, is tested with access to the equipment limited according to the method of mounting detailed in the installation instructions.		N/A
	c) Openings preventing the entry of the jointed test finger (Figure E-1 of 0E) during test b) above, are further tested by means of straight unjointed test finger (Figure E-3 of 0E), applied with a force of 30 N. If the unjointed finger enters, the test with the jointed finger is repeated except that the finger is applied using any necessary force up to 30 N.	Without openings	N/A
	d) In addition to a) – c) above, top surfaces of enclosure shall be tested with the IP3X probe of IEC 60529. The test probe shall not penetrate the top surface of the enclosure when probed from the vertical direction $\pm 5^\circ$ only.		P
7.3.4.2.4	Service access areas	Not energized at service	N/A
7.3.4.3	Protection by means of insulation of live parts		P
	Where the requirements of 7.3.4.2 are not met, live parts shall be provided with insulation if:	See 7.3.7 Table: Clearance and creepage distance	P
	– their working voltage is greater than the maximum limit of decisive voltage class A, or		P

IEC 62109-1			
Clause	Requirement + Test	Result - Remark	Verdict
	– for a DVC A or B circuit, protective separation from adjacent circuit of DVC C is not provided (see note 2 under Table 7)		P
7.3.5	Protection in case of direct contact		P
7.3.5.1	General		P
	Protection in case of direct contact is required to ensure that contact with live parts does not produce a shock hazard.		P
	The protection against direct contact according to 7.3.4 is not required if the circuit contacted is separated from other circuits according to 7.3.2.3, and:		P
	– is of decisive voltage class A and complies with 7.3.5.2, or		P
	– is provided with protective impedance according to 7.3.5.3, or		N/A
	– is limited in voltage according to 7.3.5.4		N/A
	In addition to the measures as given in 7.3.5.2 to 7.3.5.4, it shall be ensured that in the event of error or polarity reversal of connectors no voltages that exceed DVC A can be connected into a circuit with protective separation. This applies for example to plug-in-sub-assemblies or other plug-in devices which can be plugged-in without the use of a tool (key) or which are accessible without the use of a tool.		N/A
	Conformity is checked by visual inspection and trial insertion.		N/A
7.3.5.2	Protection using decisive voltage class A	Communication interface circuit	P
7.3.5.3	Protection by means of protective impedance		N/A
	Circuits and conductive parts do not require protection against direct contact if any connection to circuits of DVC-B or DVC-C is through protective impedance, and the accessible circuit or part is otherwise provided with protective separation from circuits of DVC-B or DVC-C according 7.3.3.		N/A
7.3.5.3.1	Limitation of current through protective impedance		N/A
	The current available through protective impedance to earth and between simultaneously accessible parts, measured at the accessible live parts, shall not exceed a value of 3,5 mA a.c. or 10 mA d.c. under normal and single-fault conditions.		N/A
7.3.5.3.2	Limitation of discharging energy through protective impedance		N/A

IEC 62109-1			
Clause	Requirement + Test	Result - Remark	Verdict
	The discharging energy available between simultaneously accessible parts protected by protective impedance shall not exceed the charging voltage and capacitance limits given in Table 9, which applies to both wet and dry locations, under normal and single fault conditions. Refer to figure 8.		N/A
7.3.5.4	Protection by means of limited voltages		N/A
	That portion of a circuit that has its voltage reduced to DVC-A by a voltage divider that complies with the following requirements, and that is otherwise provided with protective separation from circuits of DVC-B or DVC-C according to 7.3.3, does not require protection against direct contact.		N/A
	The voltage divider shall be designed so that under normal and single fault conditions, including faults in the voltage division circuit, the voltage across the output of the voltage divider does not exceed the limit for DVC-A.		N/A
	This type of protection shall not be used in case of protective class II or unearthed circuits, because it relies on protective earth being connected.		N/A
7.3.6	Protection against indirect contact		P
7.3.6.1	General		P
	Protection against indirect contact is required to prevent shock- hazardous current being accessible from conductive parts during an insulation failure. This protection shall comply with the requirements for protective class I (basic insulation plus protective earthing), class II (double or reinforced insulation) or class III (limitation of voltages)	Class I (basic insulation plus protective earthing) Class II part (Communication circuit of SELV): reinforced insulation	P
	That part of a PCE meets the requirements of 7.3.6.2 and 7.3.6.3 is defined as protective class I	The earthed metal enclosure meets this requirement	P
	That part of a PCE meets the requirements of 7.3.6.4 is defined as protective class II.		P
	That part of PCE which meets the requirements of decisive voltage class A and in which no hazardous voltages are derived, is defined as protective class III. No shock hazard is present in such circuits.		P
	Where protection against indirect contact is dependent on means provided during installation, the installation instructions shall provide details of the required means and shall indicate the associated hazards.		N/A
7.3.6.2	Insulation between live parts and accessible conductive parts		P

IEC 62109-1			
Clause	Requirement + Test	Result - Remark	Verdict
	Accessible conductive parts of equipment shall be separated from live parts by insulation meeting the requirements of Table 7 or by clearances as specified in 7.3.7.4 and creepages as specified in 7.3.7.5		P
7.3.6.3	Protective class I – Protective bonding and earthing		P
7.3.6.3.1	General		P
	Equipment of protective class I shall be provided with protective earthing, and with protective bonding to ensure electrical contact between accessible conductive parts and the means of connection for the external protective earthing conductor, except bonding is not required for:	PE arrangement: external protective earthing is provided through approved AC installation connector, and an external second protective earthing conductor is bonded to metal case	P
	a) accessible conductive parts that are protected by one of the measures in 7.3.5.2 to 7.3.5.4, or		P
	b) accessible conductive parts are separated from live parts of DVC-B or -C using double or reinforced insulation.		P
7.3.6.3.2	Requirements for protective bonding		P
	Electrical contact with the means of connection of the external protective earthing conductor shall be achieved by one or more of the following means:		P
	a) through direct metallic contact;		P
	b) through other conductive parts which are not removed when the PCE or sub-units are used as intended;		N/A
	c) through a dedicated protective bonding conductor;		P
	d) through other metallic components of the PCE		N/A
	Where direct metallic contact is used and one or both of the parts involved is painted or coated, the paint or coating shall be removed in the area of contact, or reliably penetrated, to ensure metal to metal contact.	No coating	P
	For moving or removable parts, hinges or sliding contacts designed and maintained to have a low resistance are examples of acceptable means if they comply with the requirements of 7.3.6.3.3.	No such part	N/A
	Metal ducts of flexible or rigid construction and metallic sheaths shall not be used as protective bonding conductors, unless the device or material has been investigated as suitable for protective bonding purposes.		N/A
7.3.6.3.3	Rating of protective bonding		P

IEC 62109-1			
Clause	Requirement + Test	Result - Remark	Verdict
	Protective bonding shall withstand the highest thermal and dynamic stresses that can occur to the PCE item(s) concerned when they are subjected to a fault connecting live parts to accessible conductive parts. The protective bonding shall remain effective for as long as a fault to the accessible conductive parts persists or until an upstream protective device removes power from the part.		P
	Protective bonding shall meet following requirements:		P
	a) For PCE with an overcurrent protective device rating of 16 A or less, the impedance of the protective bonding means shall not exceed 0.1 Ω during or at the end of the test below.		N/A
	b) For PCE with an overcurrent protective device rating of more than 16 A, the voltage drop in the protective bonding test shall not exceed 2.5 V during or at the end of the test below.	Max.0.33V	P
	As alternative to a) and b) the protective bonding may be designed according to the requirements for the external protective earthing conductor in 7.3.6.3.5, in which case no testing is required.	Protective bonding wire size is same as output cable	P
	The impedance of protective bonding means shall be checked by passing a test current through the bond for a period of time as specified below. The test current is based on the rating of the overcurrent protection for the equipment or part of the equipment under consideration, as follows:		P
	a) For pluggable equipment type A, the overcurrent protective device is that provided external to the equipment (for example, in the building wiring, in the mains plug or in an equipment rack);		N/A
	b) For pluggable equipment type B and fixed equipment, the maximum rating of the overcurrent protective device specified in the equipment installation instructions to be provided external to the equipment;		P
	c) For a circuit or part of the equipment for which an overcurrent protective device is provided as part of the equipment, the rating of the provided overcurrent device.		N/A

IEC 62109-1			
Clause	Requirement + Test	Result - Remark	Verdict
	Voltages are measured from the protective earthing terminal to all parts whose protective bonding means are being considered. The impedance of the protective earthing conductor is not included in the measurement. However, if the protective earthing conductor is supplied with the equipment, it is permitted to include the conductor in the test circuit but the measurement of the voltage drop is made only from the main protective earthing terminal to the accessible part required to be earthed.		P
	On equipment where the protective earth connection to a subassembly or to a separate unit is part of a cable that also supplies power to that subassembly or unit, the resistance of the protective bonding conductor in that cable is not included in the protective bond impedance measurements for the subassembly or separate unit, as shown in Figure 11. However, this option is only permitted if the cable is protected by a suitably rated protective device that takes into account the size of the conductor. Otherwise the impedance of the protective bonding conductor between the separate units is to be included, by measuring to the protective earthing terminal where the power source enters the first unit in the system, as shown in Figure 12.		P
7.3.6.3.3.1	Test current, duration, and acceptance criteria		P
	The test current, duration of the test and acceptance criteria are as follows:	see appended table 7.3.6.3.3	P
	a) For PCE with an overcurrent protective device rating of 16 A or less, the test current is 200% of the overcurrent protective device rating, but not less than 32 A, applied for 120s. The impedance of the protective bonding means during and at the end of the test shall not exceed 0,1 Ω .		P
	b) For PCE with an overcurrent protective device rating of more than 16 A, the test current is 200% of the overcurrent protective device rating and the duration of the test is as shown in Table 10 below. The voltage drop in the protective bonding means, during and at the end of the test, shall not exceed 2,5 V.		P
	c) During and after the test, there shall be no melting, loosening, or other damage that would impair the effectiveness of the protective bonding means.		P
	The test current is derived from an a.c or d.c supply source, the output of which is not earthed.		P

IEC 62109-1			
Clause	Requirement + Test	Result - Remark	Verdict
	As an alternative to Table 10, where the time-current characteristic of the overcurrent protective device that limits the fault current in the protective bonding means is known because the device is either provided in the equipment or fully specified in the installation instructions, the test duration may be based on that specific device's time-current characteristic. The tests are conducted for a duration corresponding to the 200% current value on the time-current characteristic.		N/A
7.3.6.3.4	Protective bonding impedance (routine test)		N/A
	If the continuity of the protective bonding is achieved at any point by a single means only (for example a single conductor or single fastener), or if the PCE is assembled at the installation location, then the impedance of the protective bonding shall also be tested as a routine test. The test shall be as in 7.3.6.3.3, except for the following:		N/A
	<ul style="list-style-type: none"> ▪ the test current may be reduced to any convenient value greater than 10 A sufficient to allow measurement or calculation of the impedance of the protective bonding means: 		N/A
	<ul style="list-style-type: none"> ▪ the test duration may be reduced to no less than 2 s 		N/A
	For equipment subject to the type test in 7.3.6.3.3.1a), the impedance during the routine test shall not exceed 0,1Ω.		N/A
	For equipment subject to the type test in 7.3.6.3.3.1b) the impedance during the routine test shall not exceed 2,5 V divided by the test current required by 7.3.6.3.3.1b).		N/A
7.3.6.3.5	External protective earthing conductor		P
	A protective earthing conductor shall be connected at all times when power is supplied to PCE of protective class I. Unless local wiring regulations state otherwise, the protective earthing conductor cross-sectional area shall be determined from Table 11 or by calculation according to IEC 60364-5-54.		P
	If the external protective earthing conductor is routed through a plug and socket or similar means of disconnection, it shall not be possible to disconnect it unless power is simultaneously removed from the part to be protected.		P
	The cross-sectional area of every external protective earthing conductor which does not form part of the supply cable or cable enclosure shall, in any case, be not less than:	Connector on enclosure	P
	<ul style="list-style-type: none"> ▪ 2,5 mm² if mechanical protection is provided; 		P

IEC 62109-1			
Clause	Requirement + Test	Result - Remark	Verdict
	<ul style="list-style-type: none"> ▪ 4 mm² if mechanical protection is not provided. 		N/A
	For cord-connected equipment, provisions shall be made so that the external protective earthing conductor in the cord shall, in the case of failure of the strain-relief mechanism, be the last conductor to be interrupted.		N/A
7.3.6.3.6	Means of connection for the external protective earthing conductor		P
7.3.6.3.6.1	General		P
	<p>The means of connection for the external protective earthing conductor shall be located near the terminals for the respective live conductors. The means of connections shall be corrosion-resistant and shall be suitable for the connection of cables according to 7.3.6.3.5.</p> <p>The means of connection for the protective earthing conductor shall not be used as a part of the mechanical assembly of the equipment or for other connections.</p> <p>A separate means of connection shall be provided for each external protective earthing conductor.</p> <p>Connection and bonding points shall be so designed that their current-carrying capacity is not impaired by mechanical, chemical, or electrochemical influences. Where enclosures and/or conductors of aluminium or aluminium alloys are used, particular attention should be given to the problems of electrolytic corrosion.</p>		P
	The means of connection for the protective earthing conductor shall be permanently marked with:		P
	<ul style="list-style-type: none"> • symbol 7 of Annex C; or 	Near terminal	P
	<ul style="list-style-type: none"> • the colour coding green-yellow 		P
	Marking shall not be done on easily changeable parts such as screws.		P
7.3.6.3.7	Touch current in case of failure of the protective earthing conductor	A second protective earthing conductor used on enclosure	P
	The requirements of this sub-clause shall be satisfied to maintain safety in case of damage to or disconnection of the protective earthing conductor.		N/A
	For pluggable equipment type A, the touch current measured in accordance with 7.5.4 shall not exceed 3,5 mA a.c. or mA d.c.		N/A
	For all other PCE, one or more of the following measures shall be applied, unless the touch current measured in accordance with 7.5.4 using the test network of IEC 60990 test figure 4 shall not exceed 3,5 mA a.c. or 10 mA d.c.		N/A

IEC 62109-1			
Clause	Requirement + Test	Result - Remark	Verdict
	a) Permanently connected wiring, and:		P
	<ul style="list-style-type: none"> a cross-section of the protective earthing conductor of at least 10 mm² Cu or 16 mm² Al; or 		N/A
	<ul style="list-style-type: none"> automatic disconnection of the supply in case of discontinuity of the protective earthing conductor; or 		N/A
	<ul style="list-style-type: none"> provision of an additional terminal for a second protective earthing conductor of the same cross-sectional area as the original protective earthing conductor and installation instruction requiring a second protective earthing conductor to be installed or 	First PE at AC connector and Secondary at external enclosure	P
	b) Connection with an industrial connector according to IEC 60309 and a minimum protective earthing conductor cross-section of 2,5 mm ² as part of a multi-conductor power cable. Adequate strain relief shall be provided.		N/A
	In addition, the caution symbol 15 of Annex C shall be fixed to the product and the installation manual shall provide details of the protective earthing measures required in the installation as required in 5.3.2.		N/A
	When it is intended and allowed to connect two or more PCEs in parallel using one common PE conductor, the above touch current requirements apply to the maximum number of the PCEs to be connected in parallel, unless one of the measures in a)		N/A
	or b) above is used. The maximum number of parallel PCEs is used in the testing and has to be stated in the installation manual.		N/A
7.3.6.4	Protective Class II – Double or Reinforced Insulation	class II part (Communication circuit of SELV): reinforced insulation	P
	Equipment or parts of equipment designed for protective class II shall have insulation between live parts and accessible surfaces in accordance with 7.3.4.3. The following requirements also apply:		P

IEC 62109-1			
Clause	Requirement + Test	Result - Remark	Verdict
	<ul style="list-style-type: none"> equipment designed to protective class II shall not have means of connection for the external protective earthing conductor. However this does not apply if the external protective earthing conductor is passed through the equipment to equipment series-connected beyond it. In the latter event, the external protective earthing conductor and its means for connection shall be insulated with basic insulation from the accessible surface of the equipment and from circuits that employ protective separation, extra-low voltage, protective impedance and limited discharging energy, according to 7.3.5. This basic insulation shall correspond to the rated voltage of the series-connected equipment; 		P
	<ul style="list-style-type: none"> metal-encased equipment of protective class II may have provision on its enclosure for the connection of an equipotential bonding conductor; 		N/A
	<ul style="list-style-type: none"> equipment of protective class II may have provision for the connection of an earthing conductor for functional reasons or for damping of overvoltages; it shall, however, be insulated as though it is a live part; 		N/A
	<ul style="list-style-type: none"> equipment employing protective class II shall be marked according to 5.1.8. 		N/A
7.3.7	Insulation Including Clearance and Creepage Distance	See 7.3.7 Table: Clearance and creepage distance	P
7.3.7.1	General		P
	This subclause gives minimum requirements for insulation, based on the principles of IEC 60664.		P
	Manufacturing tolerances shall be taken into account during measurement of creepage, clearance, and insulation distance in the PCE.		P
	Insulation shall be selected after consideration of the following influences:		P
	<ul style="list-style-type: none"> pollution degree 	PD3 for outside of enclosure PD2 for internal	P
	<ul style="list-style-type: none"> overvoltage category 	OVC II for PV input circuit, OCV III for mains circuit	P
	<ul style="list-style-type: none"> supply earthing system 		P
	<ul style="list-style-type: none"> insulation voltage 		P
	<ul style="list-style-type: none"> location of insulation 		P
	<ul style="list-style-type: none"> type of insulation 		P

IEC 62109-1			
Clause	Requirement + Test	Result - Remark	Verdict
	Compliance of insulation, creepage distances, and clearance distances, shall be verified by measurement or visual inspection, and the tests of 7.5.		P
7.3.7.1.3	Supply earthing systems	TN system with neutral earthed, except corner earthed system	P
	Three basic types of earthing system are described in IEC 60364-1. They are:		P
	<ul style="list-style-type: none"> TN system: has one point directly earthed, the accessible conductive parts of the installation being connected to that point by protective conductors. Three types of TN systems, TN-C, TN-S and TN-C-S, are defined according to the arrangement of the neutral and protective conductor. 		P
	<ul style="list-style-type: none"> TT system: has one point directly earthed, the accessible conductive parts of the installation being connected to earth electrodes electrically independent of the earth electrodes of the power system; 		N/A
	<ul style="list-style-type: none"> IT system: has all live parts isolated from earth or one point connected to earth through an impedance, the accessible conductive parts of the installation being earthed independently or collectively to the earthing system. 		N/A
7.3.7.1.4	Insulation voltages		P
	Table 12 makes use of the circuit system voltage and overvoltage category to define the impulse withstands voltage and the temporary overvoltage.		P
7.3.7.2	Insulation between a circuit and its surroundings		P
7.3.7.2.1	General		P
7.3.7.2.2	Circuits connected directly to the mains	AC Output circuit connected to mains	P
7.3.7.2.3	Circuits other than mains circuits	PV input	P
7.3.7.2.4	Insulation between circuits		P
7.3.7.3	Functional insulating		P
7.3.7.4	Clearance distances	See appended table 7.3.7	P
7.3.7.4.1	Determination		P
7.3.7.4.2	Electric field homogeneity		N/A
7.3.7.4.3	Clearance to conductive enclosures		P
7.3.7.5	Creepage distances	See appended table 7.3.7	P
7.3.7.5.1	General		P

IEC 62109-1			
Clause	Requirement + Test	Result - Remark	Verdict
7.3.7.5.2	Voltage		P
7.3.7.5.3	Materials		P
7.3.7.6	Coating		N/A
7.3.7.7	PWB spacings for functional insulating		P
7.3.7.8	Solid insulating	See appended table 7.3.7	P
7.3.7.8.1	General		P
7.3.7.8.2	Requirements for electrical withstand capability of solid insulation		P
7.3.7.8.2.1	Basic, supplemental, reinforced, and double insulation		P
7.3.7.8.2.2	Functional insulation		P
7.3.7.8.3	Thin sheet or tape material		P
7.3.7.8.3.1	General		P
7.3.7.8.3.2	Material thickness not less than 0,2 mm		P
7.3.7.8.3.3	Material thickness less than 0,2 mm		P
7.3.7.8.3.4	Compliance		P
7.3.7.8.4	Printed wiring boards	UL 94, V-0	P
7.3.7.8.4.1	General		P
7.3.7.8.4.2	Use of coating materials	No coating material	N/A
7.3.7.8.5	Wound components		N/A
7.3.7.8.6	Potting materials		N/A
7.3.7.9	Insulation requirements above 30 kHz		N/A
7.3.8	Residual Current-operated protective (RCD) or monitoring (RCM) device compatibility	Should be comply with local national code	N/A
	RCD and RCM are used to provide protection against insulation faults in some domestic and industrial installations, additional to that provided by the installed equipment.		N/A
7.3.9	Capacitor discharge		P
7.3.9.1	Operator access area		P
	Equipment shall be so designed that there is no risk of electric shock in operator access areas from charge stored on capacitors after disconnection of the PCE.	Approved installation coupler use. Accessible communication interface is DVC A (< 30VDC)	P
7.3.9.2	Service access areas		P

IEC 62109-1			
Clause	Requirement + Test	Result - Remark	Verdict
	Capacitors located behind panels that are removable for servicing, installation, or disconnection shall present no risk of electric shock or energy hazard from charge stored on capacitors after disconnection of the PCE.	Warning symbol 21 of Annex C is marked on PCE.	P
7.4	Protection against energy hazards		P
7.4.1	Determination of hazardous energy level		P
	A hazardous energy level is considered to exist if		P
	a) The voltage is 2 V or more, and power available after 60 s exceeds 240 VA.	Access to internal power circuit, tool required.	P
	b) The stored energy in a capacitor is at a voltage. U of 2 V or more, and the stored energy. E, calculated from the following equation, exceeds 20J: $E = 0,5 CU^2$		P
7.4.2	Operator Access Areas		P
	Equipment shall be so designed that there is no risk of energy hazard in operator access areas from accessible circuits.	No energy exists in operator access areas	P
7.4.3	Services Access Areas		P
7.5	Electrical tests related to shock hazard	(see appended table 7.5)	P
7.5.1	Impulse voltage test (type test)		P
7.5.2	Voltage test (dielectric strength test)		P
7.5.2.1	Purpose of test		P
7.5.2.2	Value and type of test voltage		P
7.5.2.3	Humidity pre-conditioning	RH 93%, 40°C, 48 hours	P
7.5.2.4	Performing the voltage test	Output circuit to input circuit and enclosure	P
7.5.2.5	Duration of the a.c. or d.c. voltage test	60s	P
7.5.2.6	Verification of the a.c. or d.c. voltage test		P
7.5.3	Partial discharge test	See appended table 7.5	N/A
7.5.4	Touch current measurement (type test)	See appended table 7.5.4	N/A
	The touch current shall be measured if required by 7.3.6.3.7 and shall not be greater than 3.5 mA a.c. or 10 mA d.c. or special measures of protection as given in 7.3.6.3.7 are required.	See 7.3.6.3.7	N/A
	For type tests on PCE for which wet locations requirements apply according to 6.1, the humidity pre-conditioning of 4.5 shall be performed immediately prior to the touch current test.		N/A

IEC 62109-1			
Clause	Requirement + Test	Result - Remark	Verdict
7.5.5	Equipment with multiple sources of supply	Hazards do not present under normal or single fault conditions	P
8	PROTECTION AGAINST MECHANICAL HAZARDS		P
8.1	General		P
	Operation shall not lead to a mechanical HAZARD in NORMAL CONDITION or SINGLE FAULT CONDITION. Edges, projections, corners, openings, guards, handles and the like, that are accessible to the operator shall be smooth and rounded so as not to cause injury during normal use of the equipment.		P
	Conformity is checked as specified in 8.2 to 8.6.		P
8.2	Moving parts		P
	Moving parts shall not be able to crush, cut or pierce parts of the body of an OPERATOR likely to contact them, nor severely pinch the OPERATOR's skin. Hazardous moving parts of equipment, that is moving parts which have the potential to cause injury, shall be so arranged, enclosed or guarded as to provide adequate protection against the risk of personal injury.		P
8.2.1	Protection of service persons		N/A
	Protection shall be provided such that unintentional contact with hazardous moving parts is unlikely during servicing operations. If a guard over a hazardous moving part may need to be removed for servicing, the marking of symbol 15 of Table D-1 shall be applied on or near the guard.		N/A
8.3	Stability		N/A
	Equipment and assemblies of equipment not secured to the building structure before operation shall be physically stable in NORMAL USE.	Wall mounting	N/A
8.4	Provisions for lifting and carrying	Maximum 36 kg	N/A
	If carrying handles or grips are fitted to, or supplied with, the equipment, they shall be capable of withstanding a force of four times the weight of the equipment.	No such parts	N/A
	Equipment or parts having a mass of 18 kg or more shall be provided with a means for lifting and carrying or directions shall be given in the manufacturer's documentation.		P
8.5	Wall mounting		P
	Mounting brackets on equipment intended to be mounted on a wall or ceiling shall withstand a force of four times the weight of the equipment.		P

IEC 62109-1			
Clause	Requirement + Test	Result - Remark	Verdict
8.6	Expelled parts		N/A
	Equipment shall contain or limit the energy of parts that could cause a HAZARD if expelled in the event of a fault.		N/A
9	PROTECTION AGAINST FIRE HAZARDS		P
9.1	Resistance to fire		P
	This subclause specifies requirements intended to reduce the risk of ignition and the spread of flame, both within the equipment and to the outside, by the appropriate use of materials and components and by suitable construction.	Components are witnessed at normal condition and abnormal tests are verified	P
9.1.1	Reducing the risk of ignition and spread of flame		P
	For equipment or a portion of equipment, there are two alternative methods of providing protection against ignition and spread of flame that could affect materials, wiring, wound components and electronic components such as integrated circuits, transistors, thyristors, diodes, resistors and capacitors.	Method 1	P
9.1.2	Conditions for a fire enclosure		P
	A FIRE ENCLOSURE is required for equipment or parts of equipment for which Method 2 is not fully applied and complied with.		P
9.1.2.1	Parts requiring a fire enclosure		P
	Except where Method 2 is used, or as permitted in 9.1.2.2, the following are considered to have a risk of ignition and, therefore, require a FIRE ENCLOSURE:		P
	– components in PRIMARY CIRCUITS		P
	– components in SECONDARY CIRCUITS supplied by power sources which exceed the limits for a LIMITED POWER SOURCE as specified in 9.2;		N/A
	– components in SECONDARY CIRCUITS supplied by a LIMITED POWER SOURCE as specified in 9.2, but not mounted on a material of FLAMMABILITY CLASS V-1;		N/A
	– components within a power supply unit or assembly having a limited power output complying with the criteria for a LIMITED POWER SOURCE as specified in 9.2, including overcurrent protective devices, limiting impedances, regulating networks and wiring, up to the point where the LIMITED POWER SOURCE output criteria are met;		N/A

IEC 62109-1			
Clause	Requirement + Test	Result - Remark	Verdict
	– components having unenclosed arcing parts, such as open switch and relay contacts and commutators, in a circuit at HAZARDOUS VOLTAGE or at a HAZARDOUS ENERGY LEVEL; and		N/A
	– insulated wiring, except as permitted in 9.1.2.2.		N/A
9.1.2.2	Parts not requiring a fire enclosure	Fire enclosure used	N/A
9.1.3	Materials requirements for protection against fire hazard		P
9.1.3.1	General		P
	ENCLOSURES, components and other parts shall be so constructed, or shall make use of such materials, that the propagation of fire is limited.	Metal enclosure	P
9.1.3.2	Materials for fire enclosures	Metal enclosure	P
	If an enclosure material is not classified as specified below, a test may be performed on the final enclosure or part of the enclosure, in which case the material shall additionally be subjected to periodic SAMPLE testing.		N/A
9.1.3.3	Materials for components and other parts outside fire enclosures		P
	Except as otherwise noted below, materials for components and other parts (including MECHANICAL ENCLOSURES, ELECTRICAL ENCLOSURES and DECORATIVE PARTS); located outside FIRE ENCLOSURES, shall be of FLAMMABILITY CLASS HB.		P
9.1.3.4	Materials for components and other parts inside fire enclosures	All internal components are rated V-2 or better or mounded on PCB rated V-0.	P
9.1.3.5	Materials for air filter assemblies	No such part	N/A
9.1.4	Openings in fire enclosures	Without openings	N/A
9.1.4.1	General		N/A
	For equipment that is intended to be used or installed in more than one orientation as specified in the product documentation, the following requirements apply in each orientation.		N/A
	These requirements are in addition to those in the following sections:		N/A
	– 7.3.4, Protection against direct contact;		N/A
	– 7.4, Protection against energy hazards;		N/A
	– 13.5, Openings in enclosures		N/A
9.1.4.2	Side openings treated as bottom openings		N/A
9.1.4.3	Openings in the bottom of a fire enclosure		N/A

IEC 62109-1			
Clause	Requirement + Test	Result - Remark	Verdict
	The bottom of a FIRE ENCLOSURE or individual barriers, shall provide protection against emission of flaming or molten material under all internal parts, including partially enclosed components or assemblies, for which Method 2 of 9.1.1 has not been fully applied and complied with.		N/A
9.1.4.4	Equipment for use in a CLOSED ELECTRICAL OPERATING AREA		N/A
	The requirements of 9.1.4.3 do not apply to FIXED EQUIPMENT intended only for use in a CLOSED ELECTRICAL OPERATING AREA and to be mounted on a concrete floor or other non-combustible surface. Such equipment shall be marked as follows:		N/A
	WARNING: FIRE HAZARD SUITABLE FOR MOUNTING ON CONCRETE OR OTHER NON-COMBUSTIBLE SURFACE ONLY		N/A
9.1.4.5	Doors or covers in fire enclosures		N/A
9.1.4.6	Additional requirements for openings in transportable equipment		N/A
9.2	LIMITED POWER SOURCES		N/A
9.2.1	General		N/A
9.2.2	Limited power source tests	See appended table 9.2	N/A
9.3	Short-circuit and overcurrent protection		P
9.3.1	General		P
	The PCE shall not present a hazard, under short-circuit or overcurrent conditions at any port, including phase-to-phase, phase-to-earth and phase-to-neutral, and adequate information shall be provided to allow proper selection of external wiring and external protective devices.		P
9.3.2	Protection against short-circuits and overcurrent shall be provided for all input circuits, and for output circuits that do not comply with the requirements for limited power sources in 9.2, except for circuits in which no overcurrent hazard is presented by short-circuits and overloads.		P

IEC 62109-1			
Clause	Requirement + Test	Result - Remark	Verdict
9.3.3	Protective devices provided or specified shall have adequate breaking capacity to interrupt the maximum short circuit current specified for the port to which they are connected. If protection that is provided integral to the PCE for an input port is not rated for the short-circuit current of the circuit in which it is used, the installation instructions shall specify that an upstream protective device, rated for the prospective short-circuit current of that port, shall be used to provide backup protection.		P
10	PROTECTION AGAINST SONIC PRESSURE HAZARDS		N/A
10.1	General		N/A
	The equipment shall provide protection against the effect of sonic pressure. Conformity tests are carried out if the equipment is likely to cause such HAZARDS.	No sonic pressure hazards	N/A
10.2	Sonic pressure and Sound level		N/A
10.2.1	Hazardous Noise Levels		N/A
11	PROTECTION AGAINST LIQUID HAZARDS		N/A
11.1	Liquid Containment, Pressure and Leakage	No liquid containment system	N/A
	The liquid containment system components shall be compatible with the liquid to be used.		N/A
	There shall be no leakage of liquid onto live parts as a result of:		N/A
	a) Normal operation, including condensation;		N/A
	b) Servicing of the equipment; or		N/A
	c) Inadvertent loosening or detachment of hoses or other cooling system parts over time.		N/A
11.2	Fluid pressure and leakage		N/A
11.2.1	Maximum pressure		N/A
11.2.2	Leakage from parts		N/A
11.2.3	Overpressure safety device		N/A
11.3	Oil and grease		N/A
12	CHEMICAL HAZARDS		N/A
12.1	General		N/A
13	PHYSICAL REQUIREMENTS		P
13.1	Handles and manual controls		P

IEC 62109-1			
Clause	Requirement + Test	Result - Remark	Verdict
	Handles, knobs, grips, levers and the like shall be reliably fixed so that they will not work loose in normal use, if this might result in a hazard. Sealing compounds and the like, other than self-hardening resins, shall not be used to prevent loosening. If handles, knobs and the like are used to indicate the position of switches or similar components, it shall not be possible to fix them in a wrong position if this might result in hazard.		N/A
13.1.1	Adjustable controls	Without adjustable controls	N/A
13.2	Securing of parts	All screws locked with starwasher	P
13.3	Provisions for external connections		P
13.3.1	General	Certified PV connectors are used. Installation manuals provide information for the disconnection means.	P
13.3.2	Connection to an a.c. Mains supply	Approved AC connectors and terminals	P
13.3.2.1	General		P
	For safe and reliable connection to a MAINS supply, equipment shall be provided with one of the following:		P
	– terminals or leads or a non-detachable power supply cord for permanent connection to the supply; or	Approved AC connectors and terminals	P
	– a non-detachable power supply cord for connection to the supply by means of a plug		N/A
	– an appliance inlet for connection of a detachable power supply cord; or		N/A
	– a mains plug that is part of direct plug-in equipment as in 13.3.8		N/A
13.3.2.2	Permanently connected equipment		P
13.3.2.3	Appliance inlets		N/A
13.3.2.4	Power supply cord		N/A
13.3.2.5	Cord anchorages and strain relief		N/A
	For equipment with a non-detachable power supply cord, a cord anchorage shall be supplied such that:		N/A
	– the connecting points of the cord conductors are relieved from strain; and		N/A
	– the outer covering of the cord is protected from abrasion.		N/A
13.3.2.6	Protection against mechanical damage		P

IEC 62109-1			
Clause	Requirement + Test	Result - Remark	Verdict
13.3.3	Wiring terminals for connection of external conductors	Approved AC connectors and terminals	N/A
13.3.3.1	Wiring terminals		N/A
13.3.3.2	Screw terminals		N/A
13.3.3.3	Wiring terminal sizes		N/A
13.3.3.4	Wiring terminal design		N/A
13.3.3.5	Grouping of wiring terminals		N/A
13.3.3.6	Stranded wire		N/A
13.3.4	Supply wiring space		N/A
13.3.5	Wire bending space for wires 10 mm ² and greater		N/A
13.3.6	Disconnection from supply sources	Disconnect the unit from the MAINS and PV supply by the external customer installed disconnecting devices.	P
13.3.7	Connectors, plugs and sockets	Approved PV connectors AND AC connectors or terminals used	P
13.3.8	Direct plug-in equipment		N/A
13.4	Internal wiring and connections		P
13.4.1	General		P
13.4.2	Routing	Internal wire is routed to avoid sharp edge and overheat	P
13.4.3	Colour coding	Conductor having green-and-yellow insulation is used only for protective bonding connection	P
13.4.4	Splices and connections		P
13.4.5	Interconnections between parts of the PCE		P
13.5	Openings in enclosures		N/A
13.5.1	Top and side openings	Without openings	N/A
	Openings in the top and sides of ENCLOSURES shall be so located or constructed that it is unlikely that objects will enter the openings and create hazards by contacting bare conductive parts.		N/A
13.6	Polymeric Materials		P
13.6.1	General	Approved PV and AC connectors	P
13.6.1.1	Thermal index or capability		P

IEC 62109-1			
Clause	Requirement + Test	Result - Remark	Verdict
13.6.2	Polymers serving as enclosures or barriers preventing access to hazards		P
13.6.2.1	Stress relief test		P
13.6.3	Polymers serving as solid insulation	Approved PV connectors AND AC connectors used	P
13.6.3.1	Resistance to arcing		P
13.6.4	UV resistance		P
	Polymeric parts of an OUTDOOR ENCLOSURE required for compliance with this standard shall be sufficiently resistance to degradation by ultra-violet (UV) radiation		P
13.7	Mechanical resistance to deflection, impact, or drop		P
13.7.1	General		P
13.7.2	250-N deflection test for metal enclosures		P
13.7.3	7-J impact test for polymeric enclosures	For LCD panel	P
13.7.4	Drop test		N/A
13.8	Thickness requirements for metal enclosures		P
13.8.1	General	Conformity is checked by the test as specified in clause 13.7	P
13.8.2	Cast metal		N/A
13.8.3	Sheet metal		N/A
14	COMPONENTS		P
14.1	General	See appended table 14	P
	Where safety is involved, components shall be used in accordance with their specified RATINGS unless a specific exception is made. They shall conform to one of the following:		P
	a) applicable safety requirements of a relevant IEC standard. Conformity with other requirements of the component standard is not required. If necessary for the application, components shall be subjected to the test of this standard, except that it is not necessary to carry out identical or equivalent tests already performed to check conformity with the component standard;		P
	b) the requirements of this standard and, where necessary for the application, any additional applicable safety requirements of the relevant IEC component standard;		P

IEC 62109-1			
Clause	Requirement + Test	Result - Remark	Verdict
	c) if there is no relevant IEC standard, the requirements of this standard;		P
	d) applicable safety requirements of a non-IEC standard which are at least as high as those of the applicable IEC standard, provided that the component has been approved to the non-IEC standard by a recognized testing authority.		P
	Components such as optocouplers, capacitors, transformers, and relays connected across basic, supplemental, reinforced, or double insulation shall comply with the requirements applicable for the grade of insulation being bridged, and if not previously certified to the applicable component safety standard shall be subjected to the voltage test of 7.5.2 as routine test.		P
14.2	Motor Over temperature Protection		P
	Motors which, when stopped or prevented from starting (see 4.4.4.3), would present an electric shock HAZARD, a temperature HAZARD, or a fire HAZARD, shall be protected by an over temperature or thermal protection device meeting the requirements of 14.3.		N/A
14.3	Over temperature protection devices		N/A
14.4	Fuse holders		N/A
14.5	MAINS voltage selecting devices		N/A
14.6	Printed circuit boards		P
	Printed circuit boards shall be made of material with a flammability classification of V-1 of IEC 60707 or better.	PCB material approved by UL with UL94 V-0 rating	P
	This requirement does not apply to thin-film flexible printed circuit boards that contain only circuits powered from limited power sources meeting the requirements of 9.2.		N/A
	Conformity of the flammability RATING is checked by inspection of data on the materials. Alternatively, conformity is checked by performing the V-1 tests specified in IEC 60707 on three samples of the relevant parts.		N/A
14.7	Circuits or components used as transient overvoltage limiting devices		N/A
	If control of transient overvoltage is employed in the equipment, any overvoltage limiting component or circuit shall be tested with the applicable impulse withstand voltage of Table 7-10 using the test method from 7.5.1 except 10 positive and 10 negative impulses are to be applied and may be spaced up to 1 min apart.		N/A
14.8	Batteries		N/A

IEC 62109-1			
Clause	Requirement + Test	Result - Remark	Verdict
	Equipment containing batteries shall be designed to reduce the risk of fire, explosion and chemical leaks under normal conditions and after a single fault in the equipment including a fault in circuitry within the equipment battery pack.		N/A
14.8.1	Battery Enclosure Ventilation		N/A
14.8.1.1	Ventilation requirements		N/A
14.8.1.2	Ventilation testing		N/A
14.8.1.3	Ventilation instructions		N/A
14.8.2	Battery Mounting		N/A
	Compliance is verified by the application of the force to the battery's mounting surface. The test force is to be increased gradually so as to reach the required value in 5 to 10 s, and is to be maintained at that value for 1 min. A non-metallic rack or tray shall be tested at the highest normal condition operating temperature.		N/A
14.8.3	Electrolyte spillage		N/A
	Battery trays and cabinets shall have an electrolyte-resistant coating.		N/A
	The ENCLOSURE or compartment housing a VENTED BATTERY shall be constructed so that spillage or leakage of the electrolyte from one battery will be contained within the ENCLOSURE and be prevented from:		N/A
	a) reaching the PCE outer surfaces that can be contacted by the USER		N/A
	b) contaminating adjacent electrical components or materials; and		N/A
	c) bridging required electrical distances		N/A
14.8.4	Battery Connections		N/A
	Reverse battery connection of the terminals shall be prevented if reverse connection could result in a hazard within the meaning of this Standard		N/A
14.8.5	Battery maintenance instructions		N/A
	The information and instructions listed in 5.3.4.1 shall be included in the operator manual for equipment in which battery maintenance is performed by the operator, or in the service manual if battery maintenance is to be performed by service personnel only.		N/A
14.8.6	Battery accessibility and maintainability		N/A

IEC 62109-1			
Clause	Requirement + Test	Result - Remark	Verdict
	Battery terminals and connectors shall be accessible for maintenance with the correct TOOLS. Batteries with liquid electrolyte, requiring maintained shall be so located that the battery cell caps are accessible for electrolyte tests and readjusting of electrolyte levels.		N/A
15	Software and firmware performing safety functions	All software or firmware limits or controls were disabled during single-fault test, annex B, B.1.1 A) was considered	P

4.3 Thermal test condition

No.	PV input	Battery port	Grid AC input and output port	Off Grid AC output	
1.	230V, 9kW	200V, 6kW	207V, 3kW	0	
2.	230V, 9kW	200V, 6kW	253V, 3kW	0	
3.	230V, 9kW	150V, 2.4kW	207V, 6.6kW	0	
4.	230V, 9kW	150V, 2.4kW	253V, 6.6kW	0	
5.	850V, 9kW	200V, 6kW	207V, 3kW	0	
6.	850V, 9kW	200V, 6kW	253V, 3kW	0	
7.	850V, 9kW	150V, 2.4kW	207V, 6.6kW	0	
8.	850V, 9kW	150V, 2.4kW	253V, 6.6kW	0	
9.	No connector	200V, 6kW	207V, 9kW	207V, 3kW	
10.	No connector	200V, 6kW	253V, 9kW	253V, 3kW	
11.	No connector	200V, 6kW	No connect	207V, 6kW	
12.	No connector	200V, 6kW	No connect	253V, 6kW	
Remark: AMAP*= As much as possible					

4.3	TABLE: Thermal test, thermocouple measurements						P
Model	AF6K-TH		Ambient temperature (°C)			45°C	
Output power	Rating <input checked="" type="checkbox"/> Derating <input type="checkbox"/>						
Thermocouple locations	test condition						T-limit (°C)
	1	3	5	7	9	11	
T-Ambient	46	45	44	45	45	44	reference
Accessible enclosure	52	51	49	50	51	50	100
Mounting Surface	46	46	45	46	45	45	85
Operation panel	50	50	49	49	50	49	85
Support point (Heatsink)	52	52	50	51	50	49	85
PV connector	61	60	49	49	48	48	85
BAT connector	55	52	52	50	53	53	85
AC connector	48	48	47	47	47	46	105
AC load output connector	48	47	46	46	46	47	105
PV wire	80	79	59	58	58	57	105
BAT wire	70	62	64	57	65	66	105
AC wire	59	59	55	57	58	57	105
PV Switch	67	65	56	55	56	56	85
DC Varistor (RV1)	70	67	59	58	60	59	85
DC X capacitor (C203)	76	74	60	59	60	59	110
DC Y capacitor (C189)	67	66	59	58	60	59	110
DC-EMI choke (L1)	83	82	61	60	60	59	110
Relay for ISO detection (K1)	71	70	63	62	64	63	85
DC Film capacitor (C206)	81	79	63	61	62	61	105

4.3	TABLE: Thermal test, thermocouple measurements						P	
Model	AF6K-TH		Ambient temperature (°C)			45°C		
Boost Inductor	98	91	69	65	68	66	130	
Buck boost inductor	89	79	73	65	73	72	130	
Boost MOS or IGBT (Q20)	91	88	70	69	66	65	175	
BUCK IGBT (Q39)	88	78	79	71	79	69	175	
DC Electrolytic capacitor (C2)	77	73	67	65	68	68	105	
IGBT (Q9)	73	76	66	70	75	70	175	
IGBT (Q12)	76	77	67	69	73	69	175	
AC Main inductor	83	88	81	86	90	88	130	
AC current sensor (CT3)	69	70	64	66	69	67	85	
AC Film capacitor (C22)	64	63	59	61	63	62	110	
Relay of AC grid (K4)	72	73	67	69	72	48	85	
Relay of EPS (K12)	51	49	48	47	49	71	85	
AC EMI choke (L2)	69	70	64	67	69	68	85	
AC X capacitor (C230)	61	61	57	58	60	59	110	
AC Y capacitor (C25)	61	61	57	58	60	59	110	
AC Varistor (RV3)	60	60	57	57	59	58	85	
SPS Transformer (T1)	84	86	82	82	82	81	105	
SPS Transistor (Q64)	113	114	110	109	111	110	150	
COM-Optocoupler (G3)	66	64	60	59	62	61	105	
CPU (U26)	75	72	69	68	71	70	85	
CPU3 (U7)	67	67	63	64	66	65	85	

4.3	TABLE: Thermal test, thermocouple measurements						P	
Model	AF6K-TH		Ambient temperature (°C)			45°C		
Output power	Rating <input checked="" type="checkbox"/> Derating <input type="checkbox"/>							
Thermocouple locations	test condition						T-limit (°C)	
	2	4	6	8	10	12		
T-Ambient	45	45	46	46	45	45	reference	
Accessible enclosure	52	51	51	50	50	51	100	
Mounting Surface	46	46	46	46	45	46	85	
Operation panel	50	50	49	49	49	50	85	
Support point (Heatsink)	52	52	51	50	50	50	85	
PV connector	61	60	52	50	48	49	85	
BAT connector	55	52	54	50	53	54	85	
AC connector	48	48	48	47	47	47	105	
AC load output connector	47	47	47	47	46	48	105	
PV wire	81	80	63	60	58	59	105	
BAT wire	70	62	66	58	65	67	105	
AC wire	59	59	56	56	58	58	105	
PV Switch	67	65	59	56	56	57	85	
DC Varistor (RV1)	70	68	62	59	60	60	85	
DC X capacitor (C203)	77	75	63	60	59	60	110	
DC Y capacitor (C189)	68	66	61	59	60	60	110	
DC-EMI choke (L1)	85	83	66	62	60	61	110	
Relay for ISO detection (K1)	73	71	65	63	65	65	85	
DC Film capacitor (C206)	83	81	67	63	62	62	105	
Boost Inductor	102	95	76	67	68	68	130	
Buck boost inductor	93	82	78	67	74	74	130	
Boost MOS or IGBT (Q20)	94	91	72	69	65	66	175	

4.3	TABLE: Thermal test, thermocouple measurements						P	
Model	AF6K-TH		Ambient temperature (°C)			45°C		
BUCK IGBT (Q39)	92	80	83	71	81	70	175	
DC Electrolytic capacitor (C2)	78	75	67	64	69	68	105	
IGBT (Q9)	74	76	68	69	73	71	175	
IGBT (Q12)	77	78	69	69	72	70	175	
AC Main inductor	87	89	84	86	90	89	130	
AC current sensor (CT3)	70	70	66	66	68	68	85	
AC Film capacitor (C22)	65	64	59	59	63	62	110	
Relay of AC grid (K4)	72	73	67	69	71	49	85	
Relay of EPS (K12)	51	49	48	47	49	70	85	
AC EMI choke (L2)	69	69	64	65	68	67	85	
AC X capacitor (C230)	61	61	58	57	59	59	110	
AC Y capacitor (C25)	62	61	58	58	59	59	110	
AC Varistor (RV3)	61	60	58	57	59	59	85	
SPS Transformer (T1)	85	87	84	81	83	83	105	
SPS Transistor (Q64)	119	119	117	115	116	117	150	
COM-Optocoupler (G3)	66	64	62	59	62	62	105	
CPU (U26)	76	73	70	68	71	71	85	
CPU3 (U7)	68	67	64	64	66	65	85	

4.3	TABLE: Thermal test, thermocouple measurements						P
Model	AF6K-TH		Ambient temperature (°C)			60°C	
Output power	Rating <input type="checkbox"/> Derating <input checked="" type="checkbox"/>						
Thermocouple locations	test condition						T-limit (°C)
	1	3	5	7	9	11	
T-Ambient	62	61	62	61	60	61	reference
Accessible enclosure	65	64	64	65	64	65	100
Mounting Surface	61	61	61	61	61	62	85
Operation panel	64	63	63	64	63	64	85
Support point (Heatsink)	66	65	66	66	64	66	85
PV connector	64	63	63	63	63	63	85
BAT connector	65	64	65	65	65	66	85
AC connector	62	62	62	62	62	62	105
AC load output connector	63	62	63	62	61	62	105
PV wire	73	73	70	70	69	70	105
BAT wire	70	69	70	70	71	74	105
AC wire	68	68	68	68	69	70	105
PV Switch	70	70	69	69	68	69	85
DC Varistor (RV1)	73	73	71	71	71	72	85
DC X capacitor (C203)	74	73	71	71	70	72	110
DC Y capacitor (C189)	75	75	72	72	71	72	110
DC-EMI choke (L1)	75	74	70	70	71	72	110
Relay for ISO detection (K1)	76	76	75	75	75	76	85
DC Film capacitor (C206)	76	76	73	73	72	73	105
Boost Inductor	90	90	76	75	76	78	130
Buck boost inductor	84	85	78	78	80	83	130
Boost MOS or IGBT (Q20)	90	89	75	75	75	76	175
BUCK IGBT (Q39)	84	83	82	83	83	79	175
DC Electrolytic capacitor (C2)	77	78	77	76	76	77	105
IGBT (Q9)	78	78	78	79	80	81	175
IGBT (Q12)	80	80	79	79	79	80	175
AC Main inductor	93	94	99	99	95	96	130
AC current sensor (CT3)	77	77	78	78	78	79	85
AC Film capacitor (C22)	70	72	72	71	72	71	110
Relay of AC grid (K4)	79	80	80	80	80	64	85
Relay of EPS (K12)	64	64	64	64	64	80	85
AC EMI choke (L2)	75	76	77	77	77	77	85
AC X capacitor (C230)	70	71	71	71	71	71	110
AC Y capacitor (C25)	71	71	71	71	71	72	110
AC Varistor (RV3)	70	71	71	71	70	71	85
SPS Transformer (T1)	89	89	88	88	93	94	105
SPS Transistor (Q64)	122	122	124	124	120	122	150
COM-Optocoupler (G3)	73	72	73	72	72	73	105
CPU (U26)	80	80	80	80	81	82	85
CPU3 (U7)	76	77	77	77	77	77	85

4.3	TABLE: Thermal test, thermocouple measurements						P
Model	AF6K-TH		Ambient temperature (°C)			60°C	
Output power	Rating <input type="checkbox"/> Derating <input checked="" type="checkbox"/>						
Thermocouple locations	test condition						T-limit (°C)
	2	4	6	8	10	12	
T-Ambient	61	62	61	61	60	61	reference
Accessible enclosure	65	65	64	64	65	64	100
Mounting Surface	61	61	61	61	61	61	85
Operation panel	64	64	63	63	63	61	85
Support point (Heatsink)	66	67	66	65	65	66	85
PV connector	63	64	63	63	63	63	85
BAT connector	64	65	64	64	65	64	85
AC connector	62	62	62	62	62	62	105
AC load output connector	62	63	62	62	61	61	105
PV wire	72	73	70	70	69	70	105
BAT wire	69	70	69	69	71	69	105
AC wire	68	68	67	68	69	67	105
PV Switch	70	70	69	69	68	69	85
DC Varistor (RV1)	73	73	71	71	71	71	85
DC X capacitor (C203)	73	74	71	71	71	71	110
DC Y capacitor (C189)	75	76	73	73	71	72	110
DC-EMI choke (L1)	74	72	70	70	71	71	110
Relay for ISO detection (K1)	77	77	75	75	75	75	85
DC Film capacitor (C206)	76	76	73	73	72	72	105
Boost Inductor	91	92	77	77	76	75	130
Buck boost inductor	85	87	79	79	80	78	130
Boost MOS or IGBT (Q20)	89	89	77	85	75	76	175
BUCK IGBT (Q39)	85	83	83	86	85	77	175
DC Electrolytic capacitor (C2)	79	79	77	78	77	76	105
IGBT (Q9)	78	78	78	78	80	77	175
IGBT (Q12)	80	80	79	79	79	78	175
AC Main inductor	98	99	97	98	99	98	130
AC current sensor (CT3)	78	78	77	77	78	77	85
AC Film capacitor (C22)	72	72	71	71	72	71	110
Relay of AC grid (K4)	79	80	79	79	80	63	85
Relay of EPS (K12)	64	64	64	64	64	79	85
AC EMI choke (L2)	76	77	76	76	77	76	85
AC X capacitor (C230)	71	72	70	71	71	71	110
AC Y capacitor (C25)	71	71	70	71	71	70	110
AC Varistor (RV3)	71	71	70	71	71	70	85
SPS Transformer (T1)	90	90	89	89	93	88	105
SPS Transistor (Q64)	129	129	128	128	127	121	150
COM-Optocoupler (G3)	73	73	72	73	73	72	105
CPU (U26)	80	81	80	80	81	80	85
CPU3 (U7)	77	77	76	76	77	77	85

4.4.4 TABLE: Single fault tolerance						Pass
No .	Fault	Component No.	Fault point	Duration	Result	
1.	ISO Relay	K1	Short circuit before start up inverter	3min	Unit can't operating, error message: Iso Fault. no danger ,no hazard ,no fire	
2.	Monitoring Relay - L	K4	Pin3 to Pin4 short circuit before start up inverter	3min	Unit can't operating, error message: GridRelay Fault. no danger ,no hazard ,no fire	
3.	Monitoring Relay - L	K4	Pin3 to Pin4 open circuit before start up inverter	3min	Unit can't operating, error message: GridRelay Fault. no danger ,no hazard ,no fire	
4.	Monitoring Relay - N	K5	Pin3 to Pin4 short circuit before start up inverter	3min	Unit can't operating, error message: GridRelay Fault. no danger ,no hazard ,no fire	
5.	Monitoring Relay - N	K5	Pin3 to Pin4 open circuit before start up inverter	3min	Unit can't operating, error message: GridRelay Fault. no danger ,no hazard ,no fire	
6.	AC voltage measure1	D21	Pin2-Pin3 Short circuit	3min	Unit shut down, Error message: GridOverVolt Fault. no danger ,no hazard ,no fire	
7.	AC voltage measure1	D21	Pin1-Pin3 Short circuit	3min	Unit shut down, Error message: GridOverVolt Fault. no danger ,no hazard ,no fire	
8.	AC current measure1	D24	Pin1-Pin3 Short circuit	3min	Unit can't operating, error message: RInvCurAdChaFault. No damage ,no hazard ,no fire.	
9.	AC current measure1	D24	Pin2-Pin3 Short circuit	3min	Unit can't operating, error message: RInvCurAdChaFault. No damage ,no hazard ,no fire.	
10.	AC current measure2	D12	Pin1-Pin3 Short circuit	3min	Unit can't operating, error message: SInvCurAdChaFault. No damage ,no hazard ,no fire.	
11.	AC current measure2	D12	Pin2-Pin3 Short circuit	3min	Unit can't operating, error message: SInvCurAdChaFault. No damage ,no hazard ,no fire.	
12.	AC frequency measure	R300	Pin1-Pin2 Short circuit	3min	Unit shut down, error message: GridOverFreq Fault. No damage ,no hazard ,no fire	
13.	V-bus measure	R498	Pin2-Pin3 Short circuit	3min	Unit can't operating, Error message: BusAllVoltHwOveFault. No damage, no hazard, no fire.	
14.	DC current measure1	R468	Pin1-Pin2 Short circuit	3min	Unit shut down,error message: Pv1HwOverCurrFault. no danger ,no hazard ,no fire	
15.	DC current measure2	R469	Pin1-Pin2 Short circuit	3min	Unit shut down,error message: Pv2HwOverCurrFault. no danger ,no hazard ,no fire	
16.	DC current measure3	R432	Pin1-Pin2 Short circuit	3min	Unit shut down,error message: Pv3HwOverCurrFault. no danger ,no hazard ,no fire	
17.	T measure	R161	Pin1-Pin2 Short circuit	3min	Unit can't operating, Error message: TemperatureAdChanFault. No damage, no hazard, no fire.	

4.4.4 TABLE: Single fault tolerance						Pass
No	Fault	Component No.	Fault point	Duration	Result	
18.	power tube Boost	Q21	Pin2-Pin3 Short circuit before start up	3min	Unit can not start up, No damage, no hazard, no fire.	
19.	Diode	D55	Short circuit	3min	Unit normal operation, No danger ,no hazard ,no fire	
20.	power tube IGBT	Q1	Pin2-Pin3 Short circuit before start up	3min	Unit can't operating, error message: InvOpenTestErr. No danger ,no hazard ,no fire	
21.	power tube IGBT	Q5	Pin2-Pin3 Short circuit before start up	3min	Unit shut down, error message: InvOpenTestErr. No damage ,no hazard ,no fire	
22.	GFCI check	--	Short circuit	3min	Unit shut down, error message: LeakCurrFault. No damage ,no hazard ,no fire	
23.	Bus cap	C246	Pin1-Pin2 Short circuit before start up	3min	Unit can not start up, No damage, no hazard, no fire.	
4.4.4.4 Transformer short circuit tests						
24.	Transformer short circuit tests	T1	Pin22-Pin24 Short circuit	10min	Unit can not start up, No damage, no hazard, no fire.	
25.	Transformer short circuit tests	T1	Pin32-Pin36 Short circuit	10min	Unit can not start up, No damage, no hazard, no fire.	
26.	power tube MOS-SPS	Q64	G-D Short circuit	10min	SPS no output, no danger ,no hazard ,no fire	
27.	power tube MOS-SPS	Q64	D-S Short circuit	10min	SPS no output, no danger ,no hazard ,no fire	
4.4.4.5 Output short circuit						
28.	Output L to N	--	short circuit	3min	Unit shut down ,error message: GridUnderVoltFault. No damage ,no hazard ,no fire	
29.	Output L to PE	--	short circuit	3min	Unit shut down ,error message: GridLossFault. No damage ,no hazard ,no fire	
4.4.4.6 Backfeed current test for equipment with more than one source of supply						
30.	DC	--	--	10min	Vac=0, V _{BAT} =0	
31.	AC	--	--	10min	V _{dc} =0, V _{BAT} =0	
32.	BAT	--	--	10min	V _{dc} =0, Vac=0	
4.4.4.7 Output overload						
33.	Overload	--	Output overload (110%)	30 min	Unit normal operation, No damage ,no hazard ,no fire	
4.4.4.8 cooling system failure test						
34.	Cooling system failure – Blanketing test	--	Put the unit to box	2Hour	1 hour power run at 50%	
4.4.4.11 Reverse d.c. connections						
35.	PV+ to PV-	--	Reverse polarity	3min	Unit can not start up, no danger ,no hazard ,no fire	

4.4.4 TABLE: Single fault tolerance						Pass
No.	Fault	Component No.	Fault point	Duration	Result	
4.4.4.13 Mis-wiring with incorrect phase sequence or polarity						
36.	Output L - N	--	Reverse polarity before start up	3min	Unit normal operation. No damage, no hazard, no fire.	
<p>Remarks:</p> <p>Abbreviations APS:auxiliary power supply, EM: error message , EUT: equipment under test, SC short circuit, OP: open circuit, O/L: Overloaded EUT shut down: EUT not connect to Grid ,cease to export power to Grid, the relay is opened. EUT standby: EUT connect to Grid ,cease to export power to Grid, the relay is closed.</p> <p>During the test: Fire can not propagates beyond the EUT; Equipment shall not emitt molten metal; Enclosures shall not deform to cause non-compliance with the standard. Dielectric test is made on RI and BI between Pri. circuit and protective earthing terminal after the test. No Backfeed voltage on the test</p>						

4.7 Electrical ratings tests														
		PV input			Battery port			AC Grid port				AC load		
Condition	Rated	U (V)	I (A)	P (W)	U (V)	I (A)	P (W)	U (V)	I (A)	P (W)	S(VA)	U (V)	I (A)	P (W)
PV I Max.	40	152	39.8	6049.6	200	29.2	5848	0	0	0	0	0	0	0
Battery Discharge I Max.	60	0	0	0	199	60	11940	228.1	16.78	11482.5	11490	0	0	0
Battery Charging I Max.	60	618	20.1	12421.8	200.2	59.8	11972	0.0	0	0	0	0	0	0
AC Grid I Max.	48	620	51.6	31990	0	0	0	206.8	47.99	31020	31054.5	0	0	0
AC Grid P Max.	33000	620	55.4	34348	0	0	0	233.0	45.70	32961	32998	0	0	0
AC Load I Max.	48	0	0	0	0	0	0	207.1	47.99	29807	29816	207.1	47.98	29808.3
AC Load P Max.	33000	0	0	0	0	0	0	230	43.49	30010	30013	230	43.48	30000

7.3.6.3.3	TABLE: protective equipotential bonding;				P
	Measured between:	Test current (A)	Voltage drop (V)	Resistance (mΩ)	result
	AC earthing terminal to enclosure	96A	Max.0.33V	--	Pass
supplementary information					

7.3.6.3.7	TABLE: touch current measurement			N/A
	Measured between:	Measured (mA)	Limit (mA)	Comments/conditions
	Between earthing terminal of inverter and external protective earthing conductor	-	3.5mA a.c	
supplementary information: provision of an additional terminal for a second protective earthing conductor of the same cross-sectional area as the original protective earthing conductor and installation instructions requiring a second protective earthing conductor to be installed.				

7.3.7		TABLE: clearance and creepage distance measurements					P
Model	AF30K-TH						
clearance cl and creepage distance dcr at / of:	Up (V)	U r.m.s. (V)	required cl (mm)	cl (mm)	required dcr (mm)	dcr (mm)	
Mains AC circuits to accessible metal enclosure (BI)	1000V	230Vac 1000VDC	3.6	4.0	10.0	12.0	
PV and battery circuit to accessible metal enclosure(BI)	1000V	230Vac 1000VDC	3.6	4.0	10.0	12.0	
PV and battery circuit to Mains AC circuits (BI) on PCB	1000V	230Vac 1000VDC	3.6	6.6	5.0	6.6	
Mains AC circuits to Grounding conductor (BI) on PCB	1000V	230Vac 1000VDC	3.6	6.6	5.0	6.6	
PV and battery circuit to Grounding conductor (BI) on PCB	1000V	230Vac 1000VDC	3.6	6.6	5.0	6.6	
Mains AC circuits to SELV circuit (RI) on PCB	1000V	230Vac 1000VDC	6.1	7.8	10.0	10.6	
Mains AC circuits to SELV circuit (RI) on PCB(PD1)	1000V	230Vac 1000VDC	6.1	7.8	6.4	7.8	
PV and battery circuit to SELV circuit (RI) on PCB	1000V	230Vac 1000VDC	6.1	7.8	10.0	10.6	
PV and battery circuit to SELV circuit (RI) on PCB(PD1)	1000V	230Vac 1000VDC	6.1	7.8	6.4	7.8	
Remark: overvoltage: AC main: OVCIII, PV: OVCII							

7.5 TABLE: electric strength measurements, impulse voltage test and partial discharge test				P
test voltage applied between:	Viso voltage (V)	impulse withstand voltage (V)	partial discharge extinction voltage (V)	result
Mains AC circuits to accessible metal enclosure(BI)	1500V AC	4000V	-	Pass
PV circuits and Battery circuit to accessible metal enclosure(BI)	1500V AC	4000V	-	Pass
Mains AC circuits to SELV circuit (RI)	3000V AC	6000V	-	Pass
PV circuits and Battery circuit to SELV circuit (RI)	3000V AC	6000V	-	Pass
Remark: OVC II for PV input circuit, OCV III for mains circuit				

7.5.4 TABLE: Touch current measurement			N/A
Leakage current between	I (mA)	Max. allowed I (mA)	
Metal enclosure → ground	0.14	3.5 mA a.c.	
Communication port → ground	0.17	3.5 mA a.c.	

9.2	TABLE: Limited power sources					N/A
Circuit output tested:						
Note: Measured Uoc (V) with all load circuits disconnected:						
Components	Sample No.	Uoc (V)	I _{sc} (A)		VA	
			Meas.	Limit	Meas.	Limit
supplementary information:						
Sc=Short circuit, Oc=Open circuit						

14	TABLE: list of critical components				P
object/part No.	manufacturer/ trademark	type/model	technical data	standard	mark(s) of conformity 1)
Cover of enclosure	GUANGZHOU WEIZHENG SHEET METAL FABRICATION CO.,LTD	HT1002-03	558x426x22 mm, AL5052, 2mm Min,thickness	IEC/EN 62109-1:2010	Tested with appliance
Enclosure	GUANGZHOU WEIZHENG SHEET METAL FABRICATION CO.,LTD	HT1027-01	558x426x249.8 mm, AL5052, 2mm Min,thickness	IEC/EN 62109-1:2010	Tested with appliance
Heatsink	Aerospace Huashengyuan Electrical (SuZhou) Co., Ltd.	HT1023-02	360*320*85 mm, AL6063-T5, 1mm Min,thickness	IEC/EN 62109-1:2010	Tested with appliance
Cover for LED	Covestro Deutschland AG [PC Resins]	Makrolon:280 5+ (z)(f1)	PC, 160*75mm, display size 66*16mm, UL94V-2, UV resistance f1,-40~115°C UL E41613	IEC/EN 62109-1:2010	Tested with appliance
Adhesive-type label	3M	4646	Al surface Outdoor use, -35~110°C, UL 969. E17478	IEC/EN 62109-1:2010	Tested with appliance
Heat shrink tube	Changyuan Electronics Group Co., Ltd	CB-600	600V, 105°C, VW-1. E180908	IEC/EN 62109-1:2010	Tested with appliance
Gasket sealing	RAMPF Polymer Solution GmbH & Co KG	RAKU@PUR 32-3250-8	-40°C ~100°C MH30032	IEC/EN 62109-1:2010	Tested with appliance
Muti - functional Vents	Shangda Energy Technology Co., Ltd.	SD-POM123B-B10	IP67, UV resistance.	IEC/EN 62109-1:2010	Tested with appliance
(Alternative)	Shanghai PuWei	PPCM121510 7EW	IP65, UV resistance	IEC/EN 62109-1:2010	Tested with appliance
Waterproof seals	Ningbo Yusheng Electric Co., Ltd	M20*1.5	IP68, -40~105°C.	IEC/EN 62109-1:2010	Tested with appliance
Waterproof seals material	DOMO ENGINEERING PLASTICS EUROPE SPA	6G30 V0EF(d)(f2)	Outdoor use, PA6, UL 94, V-0. E170540	IEC/EN 62109-1:2010	Tested with appliance
Com connector	SuZhou LuYi Electronic Technology Co., Ltd.	HJA042101	10A/250V, IP68, -40°C~85°C	EN61984:2009	TUV No. B107880 0001Rev.00
Material for com connector	E I DUPONT DE NEMOURS & CO INC	FR50	V-0, UV resistance, f1 E41938	IEC/EN 62109-1:2010	Tested with appliance
DC Switch	Yueqing Jinzhao Electric Appliance Co., LTD	EDS6HM/40/4 R	4P, 1200V, 30A, -40~+85°C, IP66	EN60947-3:2009+A1+A2	TUV R50499439
PV connector	Dongguan Vaconn Electronic Technology co., Ltd.	VP-D4B-PHSM4, VP-D4B-PHSF4	1100V/30A, IP68, -40~85°C	IEC 62852:2014 EN 62852:2015	TUV R50396796

14	TABLE: list of critical components					P
object/part No.	manufacturer/ trademark	type/model	technical data	standard	mark(s) of conformity 1)	
BAT connector	Jiangsu HanDa power technology Co., Ltd.	HDC-65i3m2 / HDC-65i3f1	3P, 1000Vdc/Vac, 65A, RSV 8000V, V-0, IP68, -40~+85°C	EN 61984:2009	TUV R 50500824	
(Alternative)	SuZhou LuYi Electronic Technology Co., Ltd.	G-Z2MS03-N08	3P, 1000Vdc/Vac, 80A, RSV 8000V, V-0, IP67, -40~+135°C	EN 61984:2009	TUV No.B10788 00003Rev. 02	
AC connector	Jiangsu Handa power technology Co., Ltd.	HDC-65i5m2 / HDC-65i5f1	5P, 1000Vdc/Vac, 65A, RSV 8000V, V-0, IP68, -40~+85°C	EN 61984:2009	TUV R 50500824	
(Alternative)	SuZhou LuYi Electronic Technology Co., Ltd.	G-Y2HT05	5P, 1000Vdc/Vac, 76A, RSV 6000V, V-0, IP68, -40~+80°C	EN 60998-1:2004 EN 60998-2-1:2004 62444:20EN 13	TUV No.B10788 00005Rev. 00	
Material for enclosure of AC output	SABIC JAPAN L L C	357(f1)(w)(IC)	outdoor use, V-0, f1 E207780	IEC/EN 62109-1:2010	Tested with appliance	
Gasket enclosure of AC output	WUJIANG FLYUP	3FH60B09	NBR+F13, NEMA 4X, 6, -40~75°C. UL MH60110	IEC/EN 62109-1:2010	Tested with appliance	
Gland or outlet bushing for AC output	JiaXing ShengYang Electric Co., Ltd	JAR-K-M40	M40*1.5, PA66, -40-100°C E506986	IEC/EN 62109-1:2010	Tested with appliance	
Grounding terminal	Suzhou Haiyou Wei Precision Hardware Co., Ltd	M4*10 Three combination screws	M4*10, SUS304	IEC/EN 62109-1:2010	Tested with appliance	
External fan	MINEBEAMITSUMI INC	08025DE12N CUD	12V, 5250RPM, -20~70°C, IP68. E89936	IEC/EN 62109-1:2010	Tested with appliance	
External fan connector	Shanghai Fuerkang Precision Electronic Technology Co., LTD	JST 04R-JWPF-VSLE-S/JST 04T-JWPF-VSLE-S	10A max, 105°C	IEC/EN 62109-1:2010	Tested with appliance	
External fan wire	SHANGHAI JINGFENG WIRE & CABLE CO LTD	2547	500V, 80°C, 22AWG. E320487	IEC/EN 62109-1:2010	Tested with appliance	
Gland or outlet bushing for external fan wire	JiaXing ShengYang Electric Co., Ltd	JAR-K-M20	M20*1.5, PA66, -40-100°C. E506986	IEC/EN 62109-1:2010	Tested with appliance	
Internal fan	Shengjiu Group	SA120625BL CNR017	12V, 5000RPM, -10~70°C, IP20. E471112	IEC/EN 62109-1:2010	Tested with appliance	

14	TABLE: list of critical components					P
object/part No.	manufacturer/ trademark	type/model	technical data	standard	mark(s) of conformity1)	
DC cable	3Q CABLE	10269	1250Vdc, 105°C, 10AWG, UL E341104	IEC/EN 62109-1:2010	Tested with appliance	
DC cable	3Q CABLE	10269	1250Vdc, 105°C, 12AWG, UL E341104	IEC/EN 62109-1:2010	Tested with appliance	
DC fuse	Xi'an Sinofuse Electric Co Ltd	RS308-HB-4G100A	750Vdc, 100A. Interrupting 50kA. -40~85°C	EN 60269-1:2007+A1+A2 EN 60269-4:2009+A1+A2	TUV R 50566387	
BAT cable	3Q CABLE	10269	1250Vdc, 105°C, 8AWG, UL E341104	IEC/EN 62109-1:2010	Tested with appliance	
AC cable	3Q CABLE	10269	1250Vac, 105°C, 8AWG, UL E341104	IEC/EN 62109-1:2010	Tested with appliance	
PCB	Kunshan dayang printed circuit board Co.,ltd	DY-M	V-0, UL E360224	IEC/EN 62109-1:2010	Tested with appliance	
Communication Optocoupler (G3, G5)	Toshiba Electronic Devices & Storage Corporation	TLP2261	Viso 5000V, -40~125°C. CI 8.0mm, Cr 8.0mm	IEC60747-5-5:2007 EN 60747-5-5:2011+A1:2015	VDE 40040216	
(Alternative)	AVAGO TECHNOLOGIES PTE LTD	ACPL-064L-500E	Viso 3750V, -40~105°C. CI 8.0mm, Cr 8.0mm UL E55361	IEC/EN 62109-1:2010	Tested with appliance	
Transformer	Shanghai damask satin electric technology Co., Ltd.	ER3534-1.5mH	Class B, 130 °C	IEC/EN 62109-1:2010	Tested with appliance	
Bobbin	CHANGCHUN PLASTICS CO., LTD.	T375HF	PMC,150 °C, V-0 E59481	IEC/EN 62109-1:2010	Tested with appliance	
Magnet Wire	DONGGUAN YIDA INDUSTRIAL CO., LTD	2UEW-F	Polyester, 155°C E344055	IEC/EN 62109-1:2010	Tested with appliance	
Core of SPS transformer	HAINING WANDA JIAYUAN ELECTRONICS CO., LTD	ER3643 WD4	WD4	IEC/EN 62109-1:2010	Tested with appliance	
Power inductor	SHANGHAI JINGWAY ELECTRONICS CO., LTD	PD100222007 A0	0.497mH (AC)	IEC/EN 62109-1:2010	Tested with appliance	
Insulation sheet for inductor	CHANGSHU LIANGYI TAPE INDUSTRY CO., LTD	LY-20X	180°C E246820	IEC/EN 62109-1:2010	Tested with appliance	
Magnet Wire	DONGGUAN YIDA INDUSTRIAL CO., LTD	QZY-2/180	Polyester-imide, 180°C E344055	IEC/EN 62109-1:2010	Tested with appliance	

14	TABLE: list of critical components				P
object/part No.	manufacturer/ trademark	type/model	technical data	standard	mark(s) of conformity 1)
MOV (RV1, RV2, RV3, RV18, RV19, RV20)	THINKING	TVT20122KA KGB510	490Vac, 750Vdc, 1200V _{1mA} , -40~+105°C	IEC 61051-1:2007 IEC 61051-2:1991	TUV J50179389
MOV (RV10, RV12, RV13, RV16)	THINKING	TVT20821	510Vac, 670Vdc, 820V _{1mA} , -40~+85°C UL E14979	IEC/EN 62109-1:2010	Tested with appliance
(Alternative)	Brightking	MOV-25D821K	510Vac, 670Vdc, 820V _{1mA} , -40~+85°C	IEC61051-2:1991	VDE 40027827
(Alternative)	Brightking	821KN20	510Vac, 670Vdc, 820V _{1mA} , -40~+85°C	IEC61051-2:1991	VDE 40027827
(Alternative)	Brightking	681KN14	420Vac, 560Vdc, 680V _{1mA} , -40~+85°C	IEC61051-2:1991	VDE 40027827
X capacitor (C203, C205)	Jiangsu Jiarong Electronics Co., Ltd.	DPB-205K3LB27L5 AR31	2.0uf, 1100VDC, -40~105°C	IEC/EN 62109-1:2010	Tested with appliance
X capacitor (C104, C230, C231)	Xiamen Faratronic Co., Ltd.	HMKP3A1W2 2KOR20D	2.2uf, 310Vac, -40~+110°C	IEC/EN 62109-1:2010	Tested with appliance
Y capacitor (C189, C194, C209)	Xiamen Faratronic Co., Ltd.	C43Q1472M4 0C000	Y2, 300 Vac, 4.7nF, -40~+110°C	EN 60384-14:2013	ENEC14, SEMKO SE/0366-2D
Y Capacitor (C24, C25, C26, C27)	Xiamen Faratronic Co., Ltd.	C43Q1103M4 0C000	Y2, 300 Vac, 10nF, -40~+110°C	EN 60384-14:2013	ENEC14, SEMKO SE/0366-2D
DC bus capacitor (C1-C6)	CAPXON ELECTRONIC (SHEN ZHEN) CO., LTD	UL271M550P 500AP4	270uF, 550V, -40~105°C	IEC/EN 62109-1:2010	Tested with appliance
DC Choke (L1)	Endela Electronics (Shenzhen) Co., Ltd.	L-35-0226	0.5mH min, 130°C.	IEC/EN 62109-1:2010	Tested with appliance
(Alternative)	Guangzhou EMC Tech Co., Ltd.	EMC-L0022-01	0.5mH min, 130°C.	IEC/EN 62109-1:2010	Tested with appliance
BAT Choke (L9)	Endela Electronics (Shenzhen) Co., Ltd.	L-35-0243	0.8mH min, 130°C.	IEC/EN 62109-1:2010	Tested with appliance
AC Choke (L7)	Endela Electronics (Shenzhen) Co., Ltd.	LC-35-0303	23uH, 130°C.	IEC/EN 62109-1:2010	Tested with appliance
AC Choke (L2)	Endela Electronics (Shenzhen) Co., Ltd.	L-35-0226	0.5mH min, 130°C.	IEC/EN 62109-1:2010	Tested with appliance
(Alternative)	Guangzhou EMC Tech Co., Ltd.	EMC-L0022-01	0.5mH min, 130°C.	IEC/EN 62109-1:2010	Tested with appliance

14	TABLE: list of critical components					P
object/part No.	manufacturer/ trademark	type/model	technical data	standard	mark(s) of conformity 1)	
Current sensor for DC part (CT4, CT5)	NINGBO CRRC TIMES TRANSDUCER TECHNOLOGY CO LTD	NACA.50T-P6/VN	Ipn: 50A, -40°C~105°C. E317702	IEC/EN 62109-1:2010	Tested with appliance	
Current sensor for BAT part (CT5)	Ningbo Sinomags Technology Co., LTD	STK-80PL	Ipn: 80A, -40°C~105°C.	IEC/EN 61010-2-030:2021 EN62477-1:2012+A11 +A1+A12	TUV R50428205	
Current sensor for AC part (CT1, CT2, CT3, CT4)	Ningbo Sinomags Technology Co., LTD	STK-80PL	Ipn: 80A, -40°C~105°C.	IEC/EN 61010-2-030:2021 EN62477-1:2012+A11 +A1+A12	TUV R50428205	
(Alternative)	NINGBO CRRC TIMES TRANSDUCER TECHNOLOGY CO LTD	NACA.80T-P6/VN	Ipn: 80A, -40°C~105°C	IEC/EN 62109-1:2010	Tested with appliance	
(Alternative)	STM(HAIYAN) MEASUREMENT & CONTROL TECHNOLOGY CO., LTD	SO7T80C2.5 V1H	Ipn: 80A, -40°C~105°C.	IEC/EN 62109-1:2010	Tested with appliance	
Relay (ALFG1)	XIAMEN HONGFA ELECTROACOUSTIC CO., LTD	HF140FF/012 -2HSWTF	12Vdc, 10A, 250Vac Viso 5000V, -40~85 °C Contact gap: 2.0 mm	IEC/EN 61810-1:2004	TUV R 50149131	
Relay (K1)	Hongfa	HFD3/5	5VDC 2 A, 10W, Viso 3000V, -40°C~85°C.	IEC/EN 61810-1:2015	VDE 40018867	
Relay for BAT (K8)	Churod Electronics Co., Ltd.	CHAR-112A90C	90A, 1000Vac, -40°C~85°C, Viso 1000V, Contact gap: 4 mm	IEC/EN 61810-1:2015+A1	TUV R 50499133	
Relay (K1, K2, K3, K4, K5, K6, K7, K10, K11, K12, K13, K14 K18, K19, K20, K21)	Hongfa	HF161F-40W/12-HTF(967)(A38)	50A, 277Vac, -40°C~85°C, Viso 2500V, Contact gap: 1.8 mm	IEC/EN 61810-1:2015+A1	TUV R 50475730	
(Alternative)	Churod Electronics Co., Ltd.	CHFV-V-112H1A2F(50 A)	50A, 277Vac, -40°C~85°C, Viso 6000V, Contact gap: 1.8 mm	IEC/EN 61810-1:2015+A1	TUV R 50220099	
DSP (U26)	TI	TMS320F28374SPTP	-40°C~105°C HLQFP-176	IEC/EN 62109-1:2010	Tested with appliance	
(Alternative)	TI	TMS320F28377SPTP	-40°C~105°C HLQFP-176	IEC/EN 62109-1:2010	Tested with appliance	
Communication CPU (U17)	ST	STM32F407ZET6	-40°C~105°C LQFP-144	IEC/EN 62109-1:2010	Tested with appliance	

14	TABLE: list of critical components				P
object/part No.	manufacturer/ trademark	type/model	technical data	standard	mark(s) of conformity1)
(Alternative)	GigaDevice Semiconductor Inc.	GD32F407ZE T6	-40°C~85°C LQFP-144	IEC/EN 62109-1:2010	Tested with appliance
IGBT (Q2, Q3, Q6, Q7, Q10, Q11, Q14, Q15)	INFINEON	IKW100N60T	100A/600V	IEC/EN 62109-1:2010	Tested with appliance
IGBT (Q1, Q4, Q5, Q8, Q9, Q12, Q13, Q16)	NCE POWER	NCE100TD12 0VTP	100A/1200V	IEC/EN 62109-1:2010	Tested with appliance
Zero-sequence Current sensor	Jingpeng	JP-H-12172 JP2605	50mm, 200°C	IEC/EN 62109-1:2010	Tested with appliance
Insulation sheet for IGBT	SHENZHEN CITY JIA RIFENG TAI ELECTRONIC TECHNOLOGY CO., LTD	JRF-TC025	1600°C, 35*22*1mm (Thermal ceramic)	IEC/EN 62109-1:2010	Tested with appliance

Appendix1 Photos:

Overview-AF30K-TH



Overview-AF30K-TH

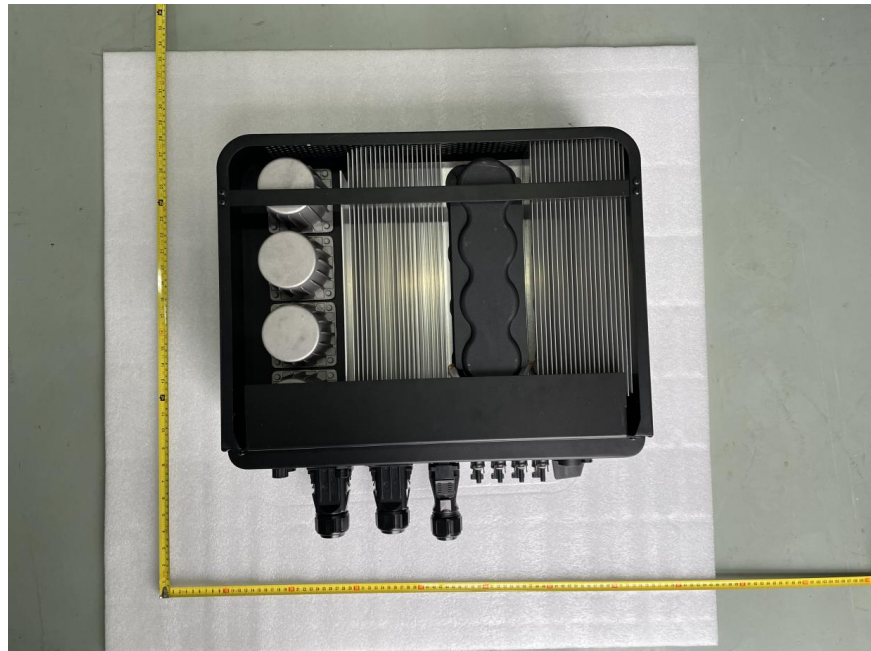

Appendix1 Photos:

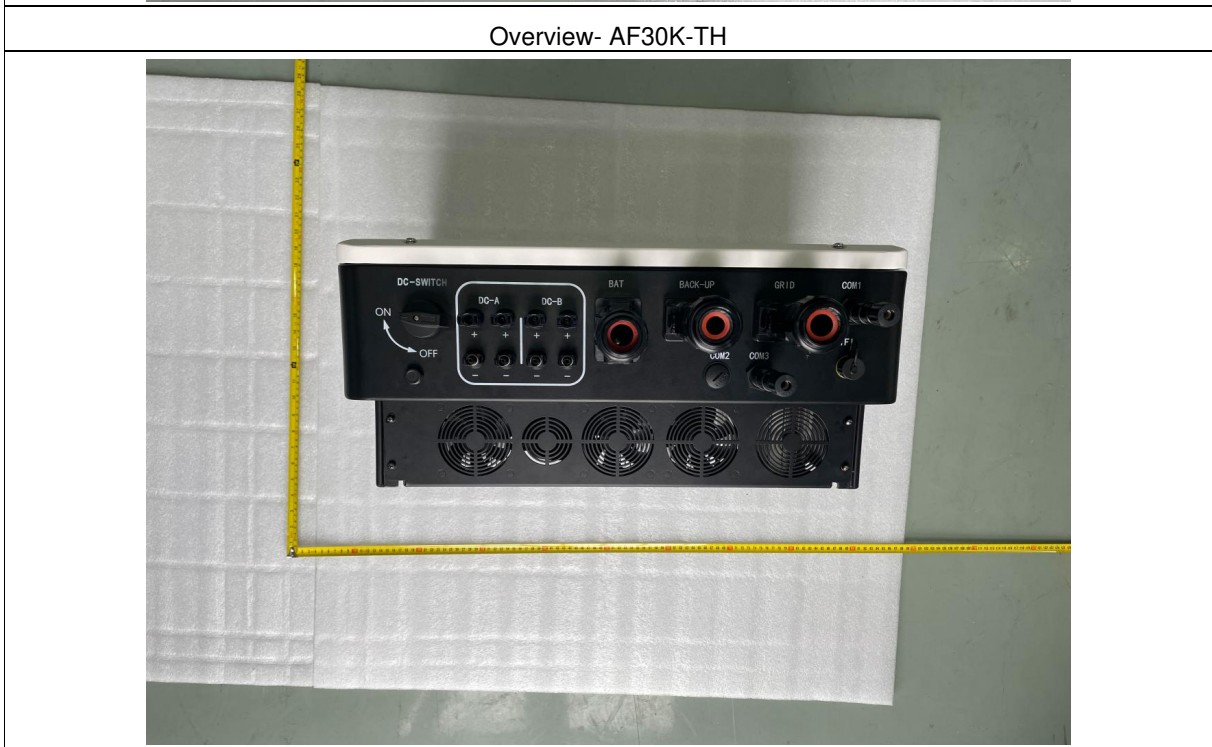

Appendix1 Photos:

Overview- AF30K-TH

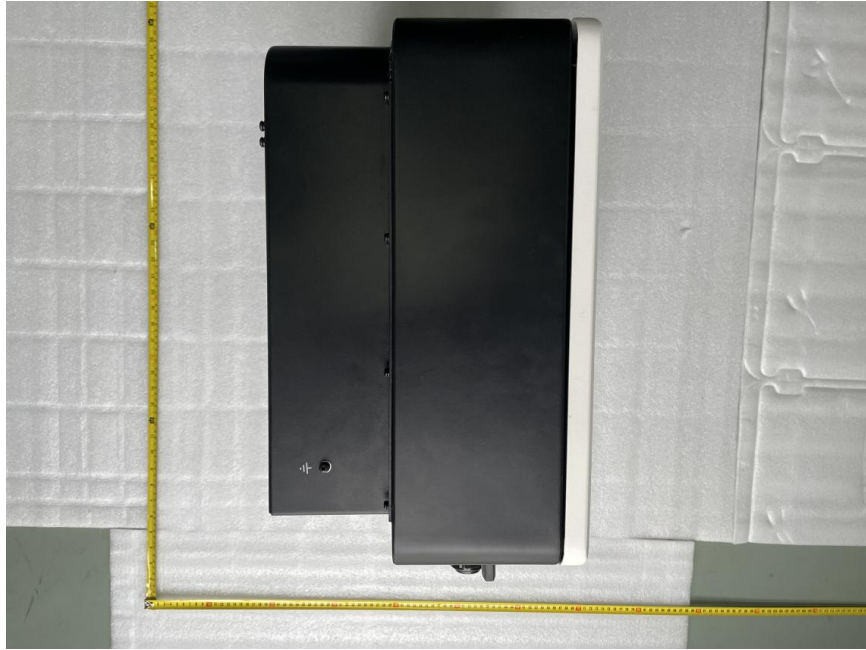

Overview- AF30K-TH

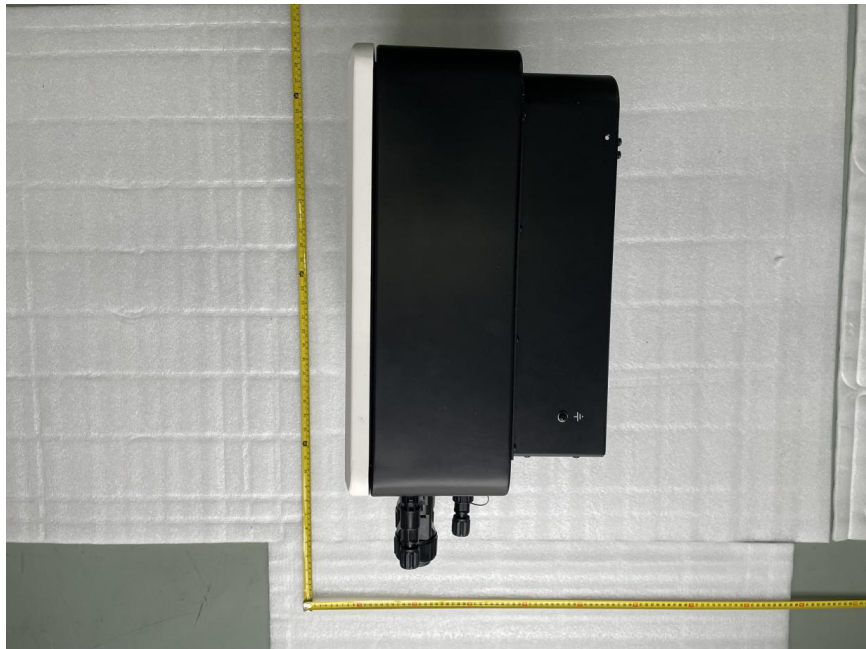

Appendix1 Photos:

Internal view- AF30K-TH

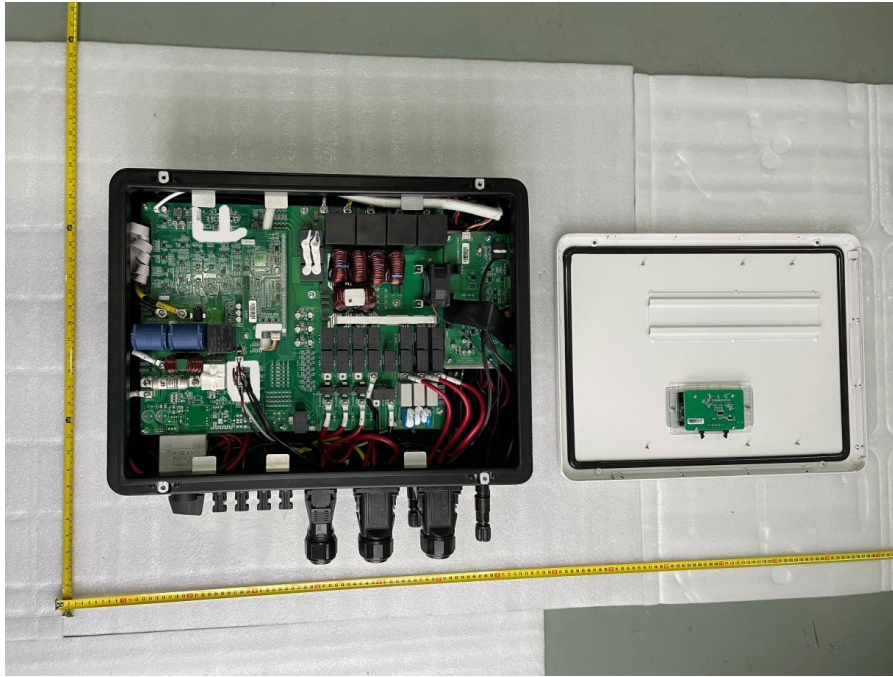

Internal view-

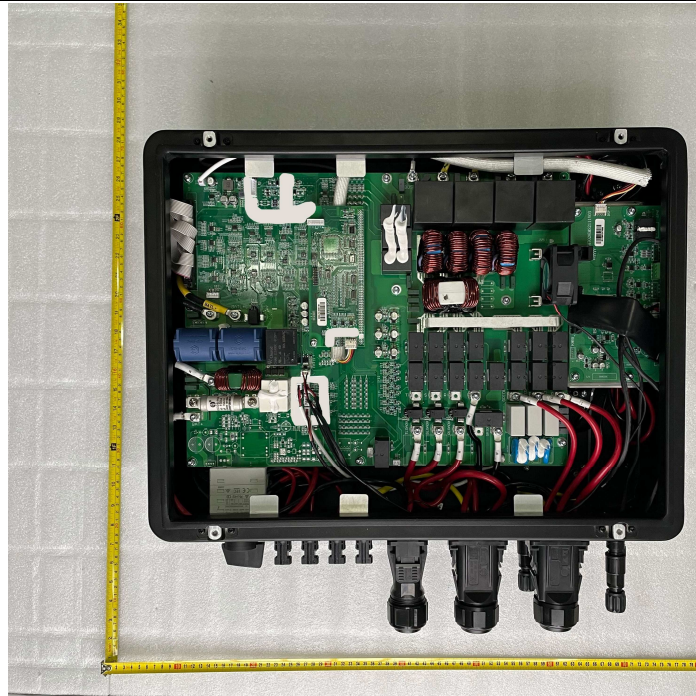

Appendix1 Photos:

Internal view-

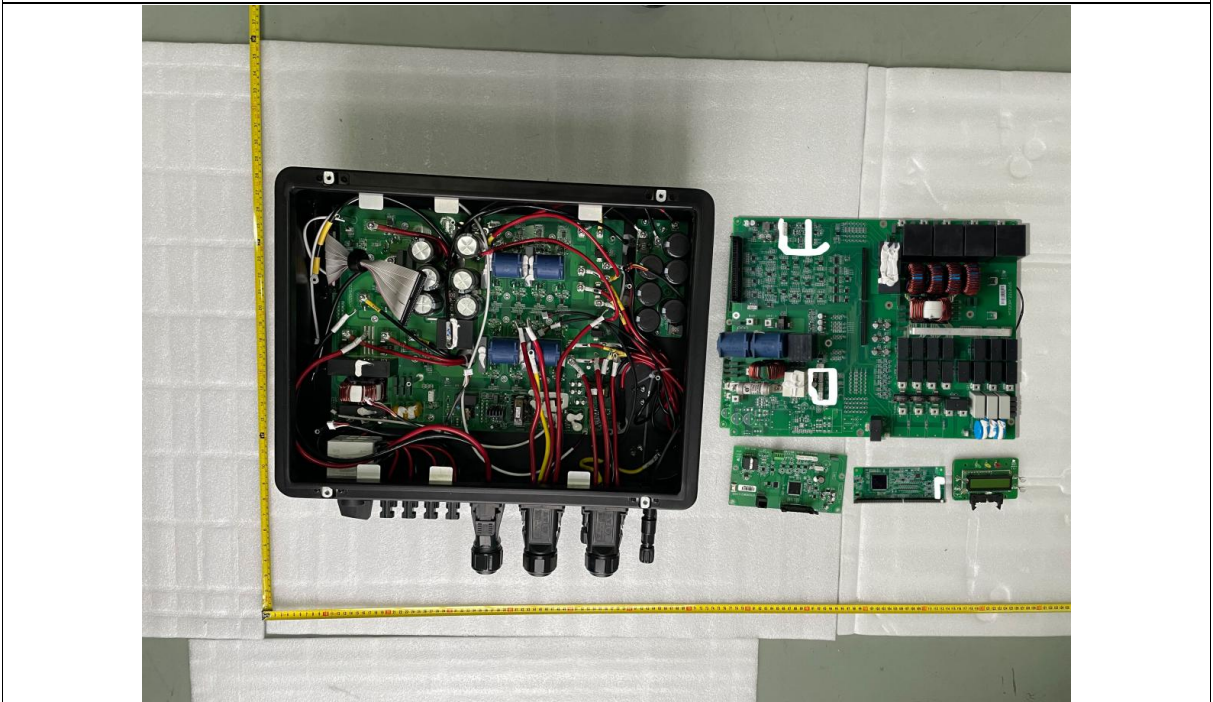

Internal view-

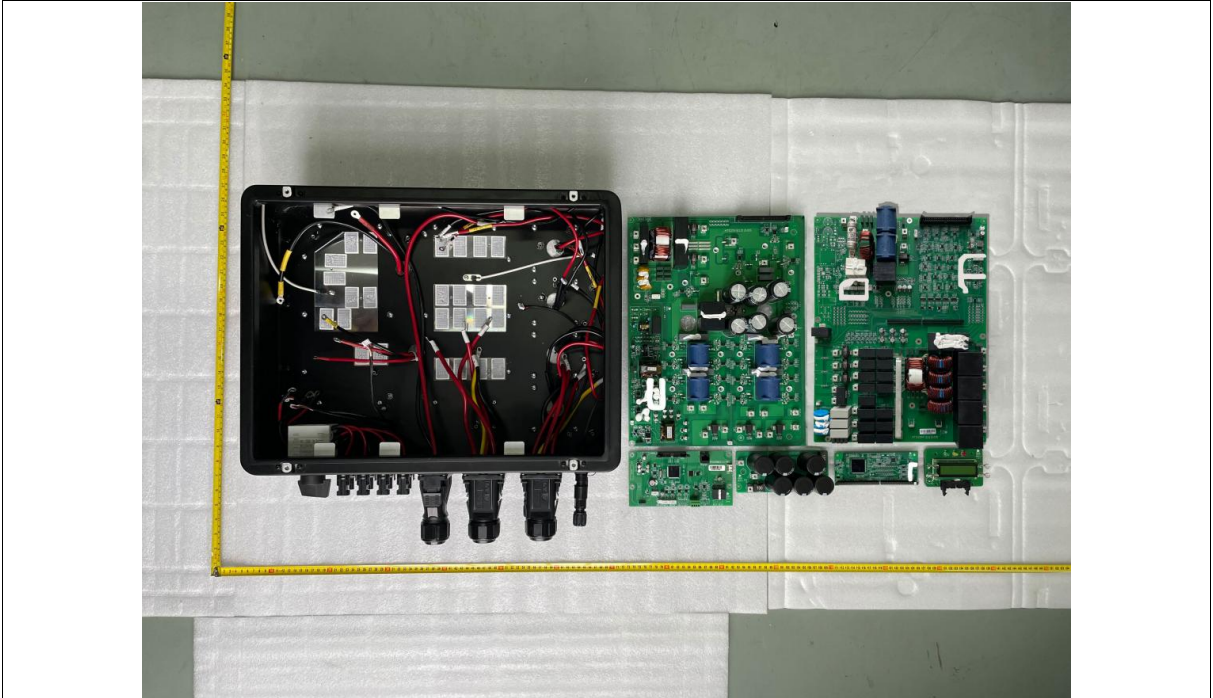

Appendix1 Photos:

Internal view-

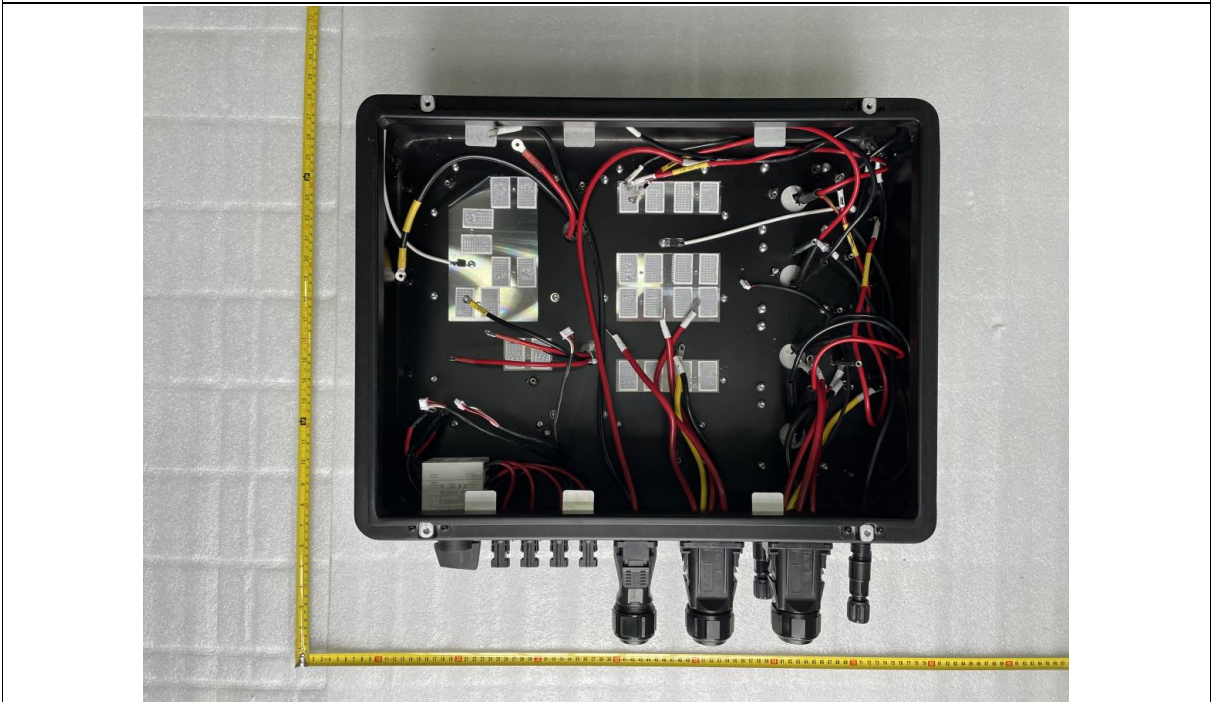

Internal view-

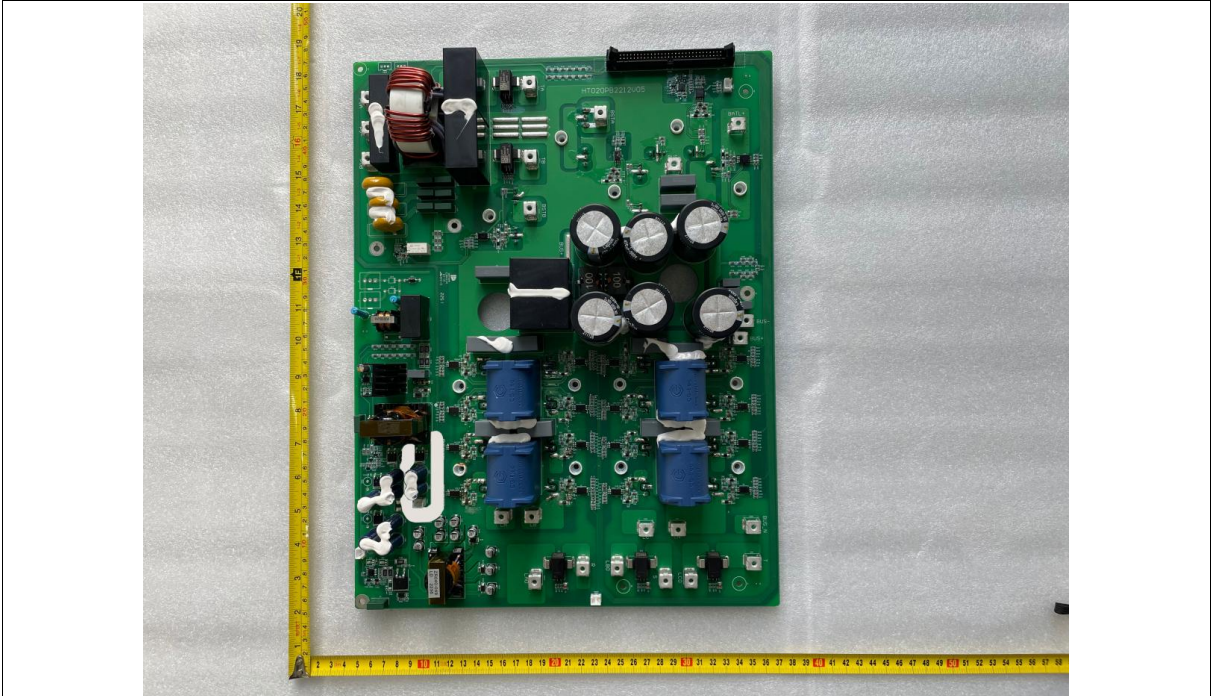

Appendix1 Photos:

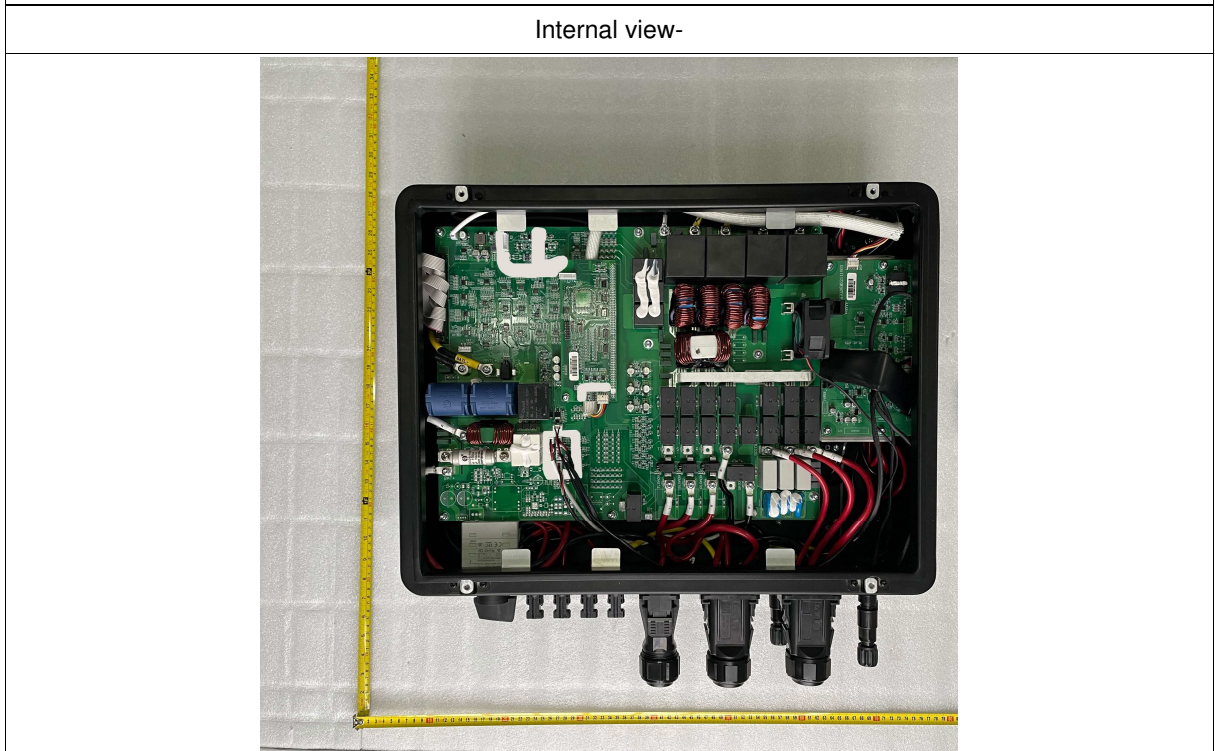
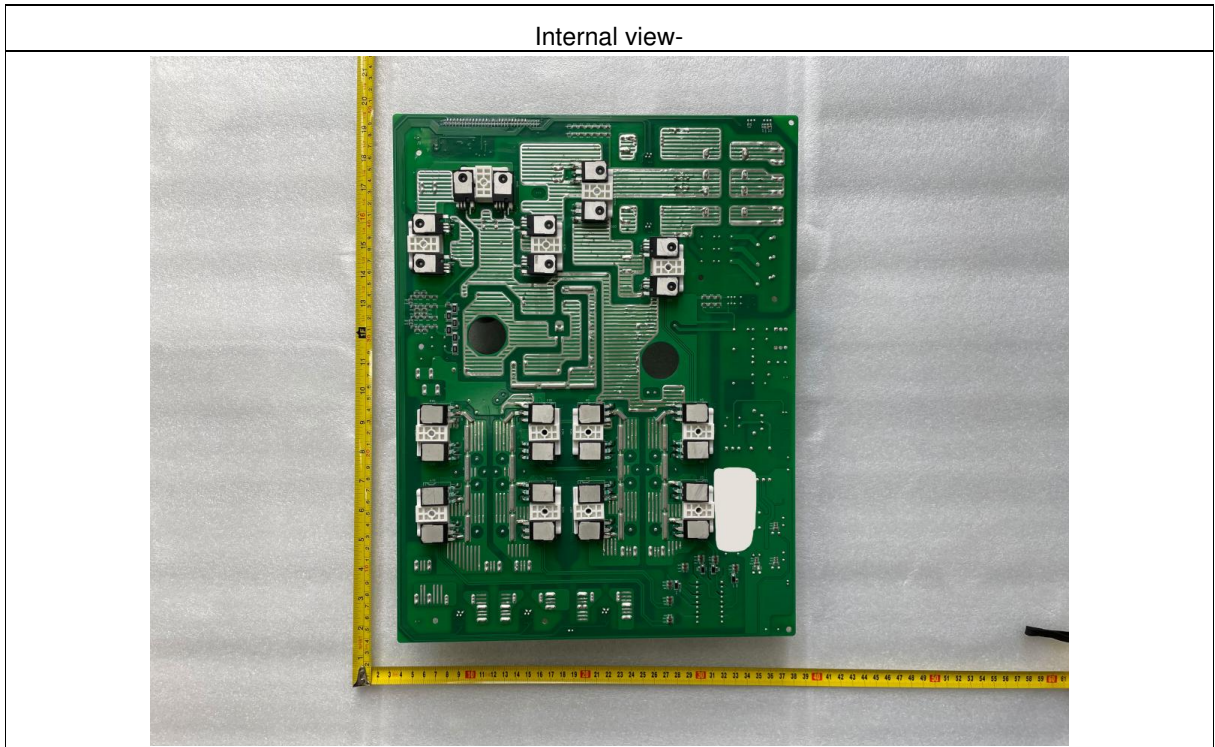

Appendix1 Photos:

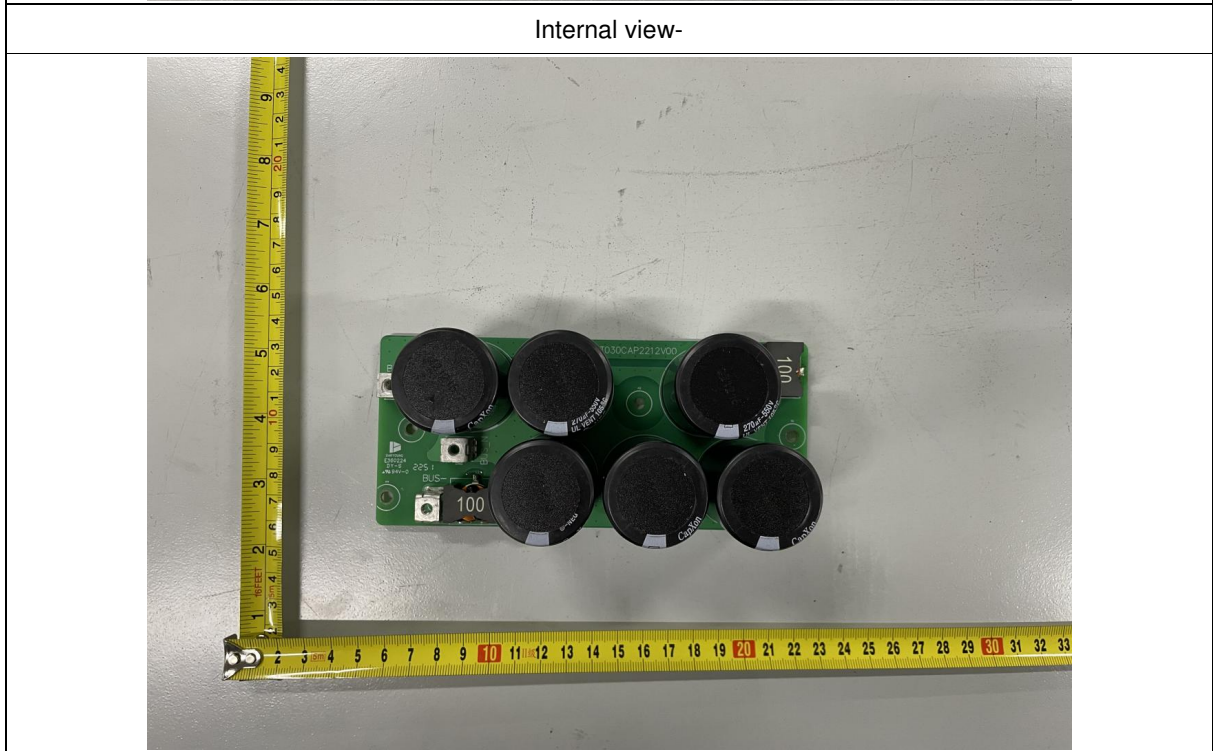
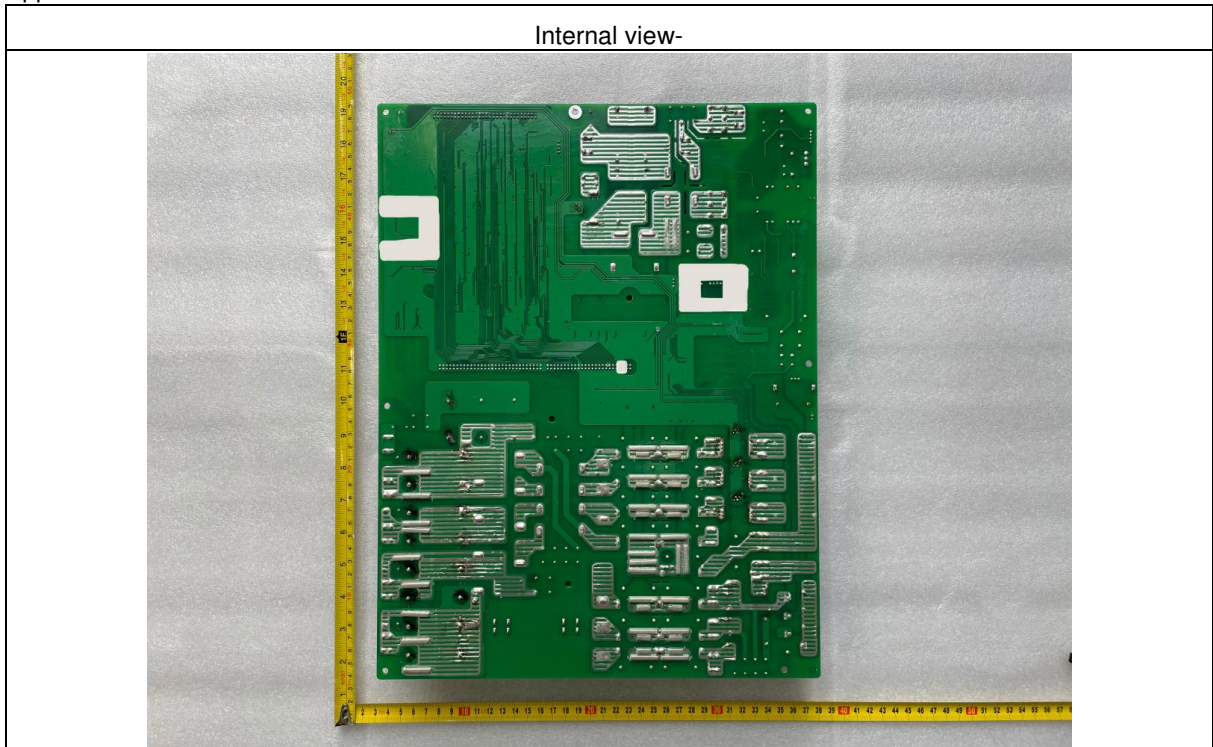

Appendix1 Photos:

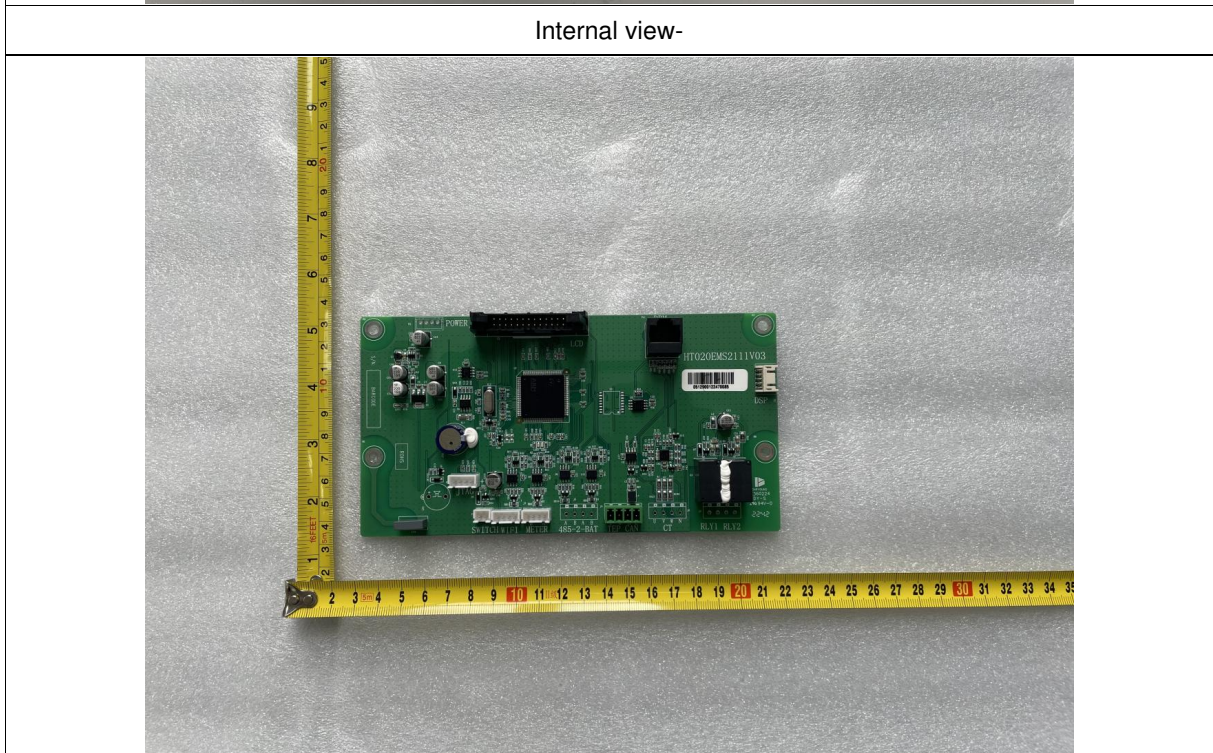
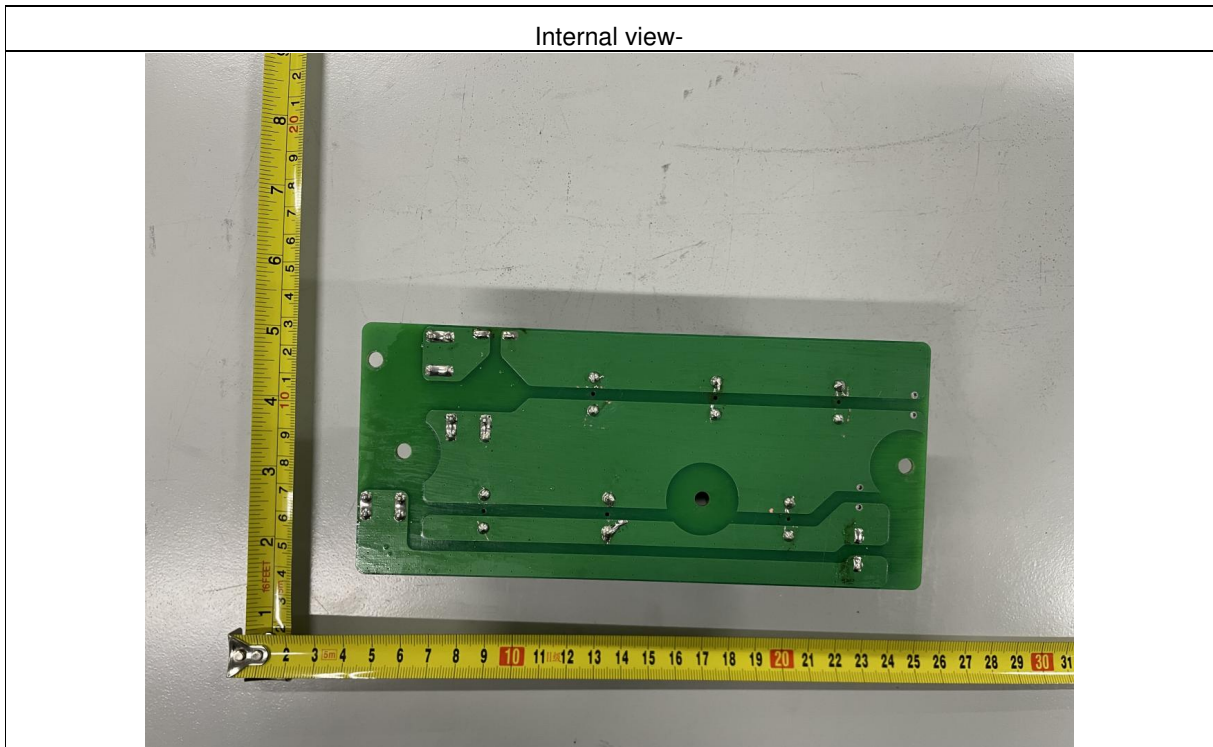

Appendix1 Photos:

Internal view-

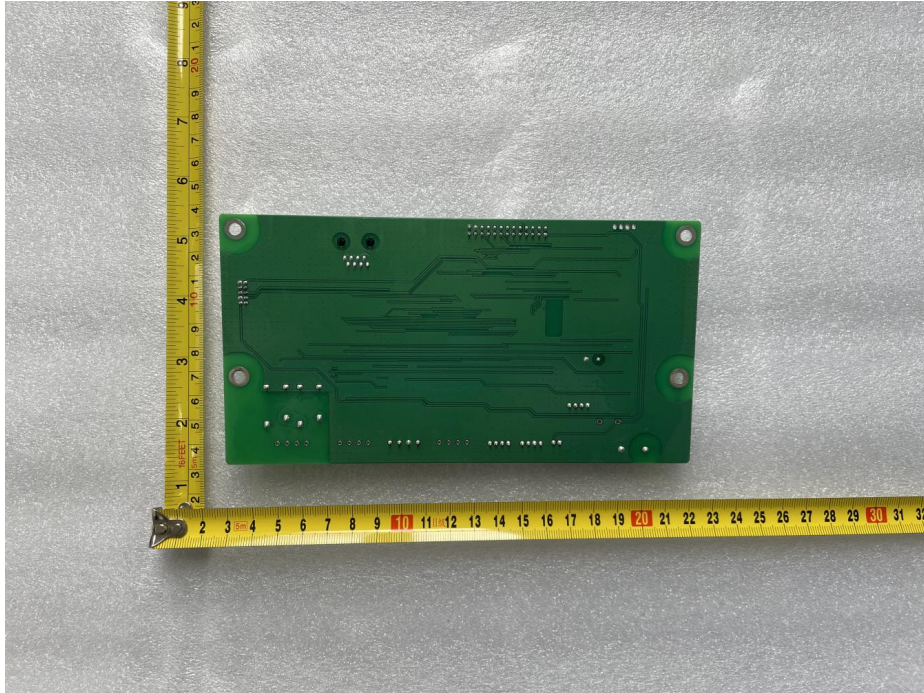

Internal view-

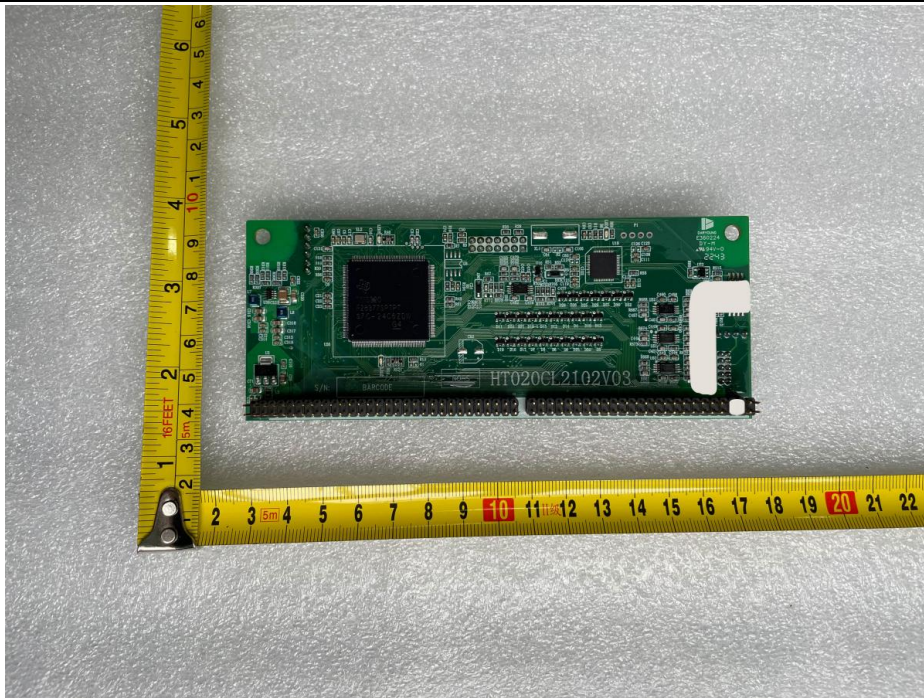

Appendix1 Photos:

Internal view-

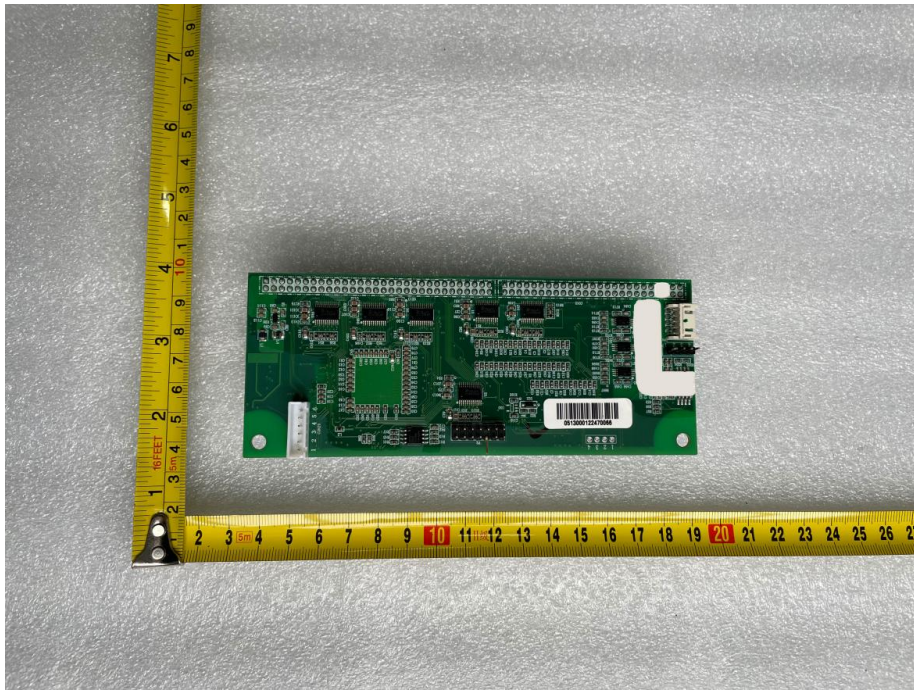

Internal view-

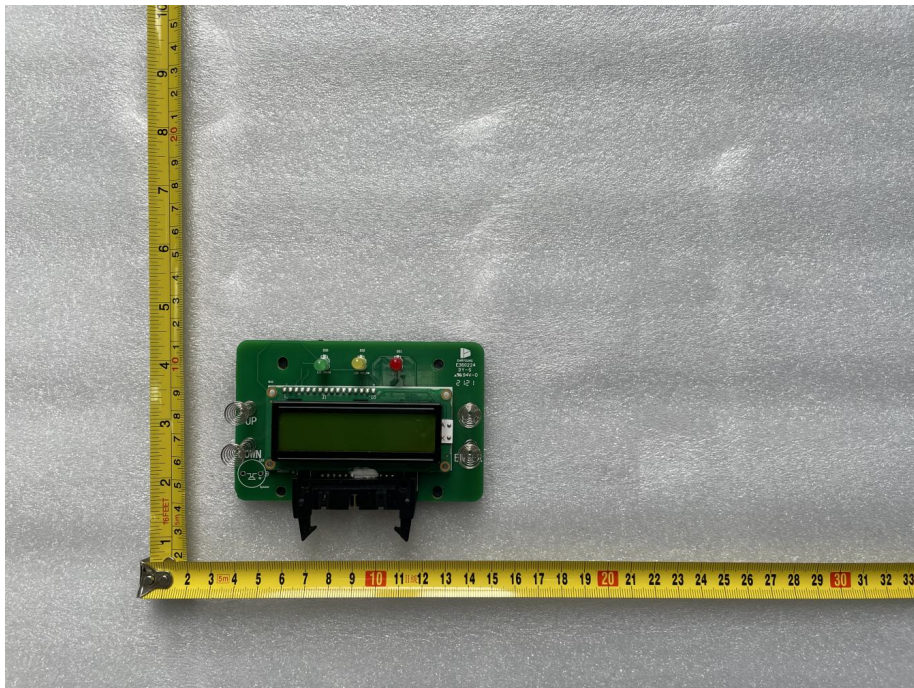

Appendix1 Photos:

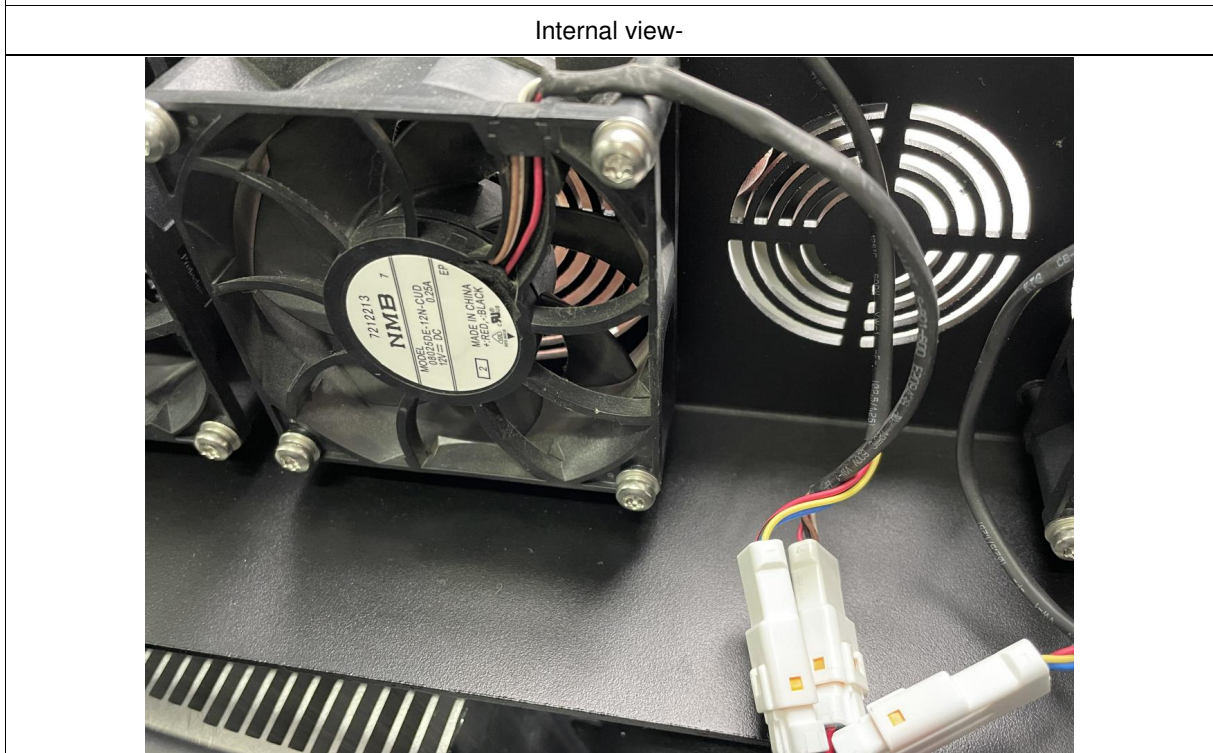
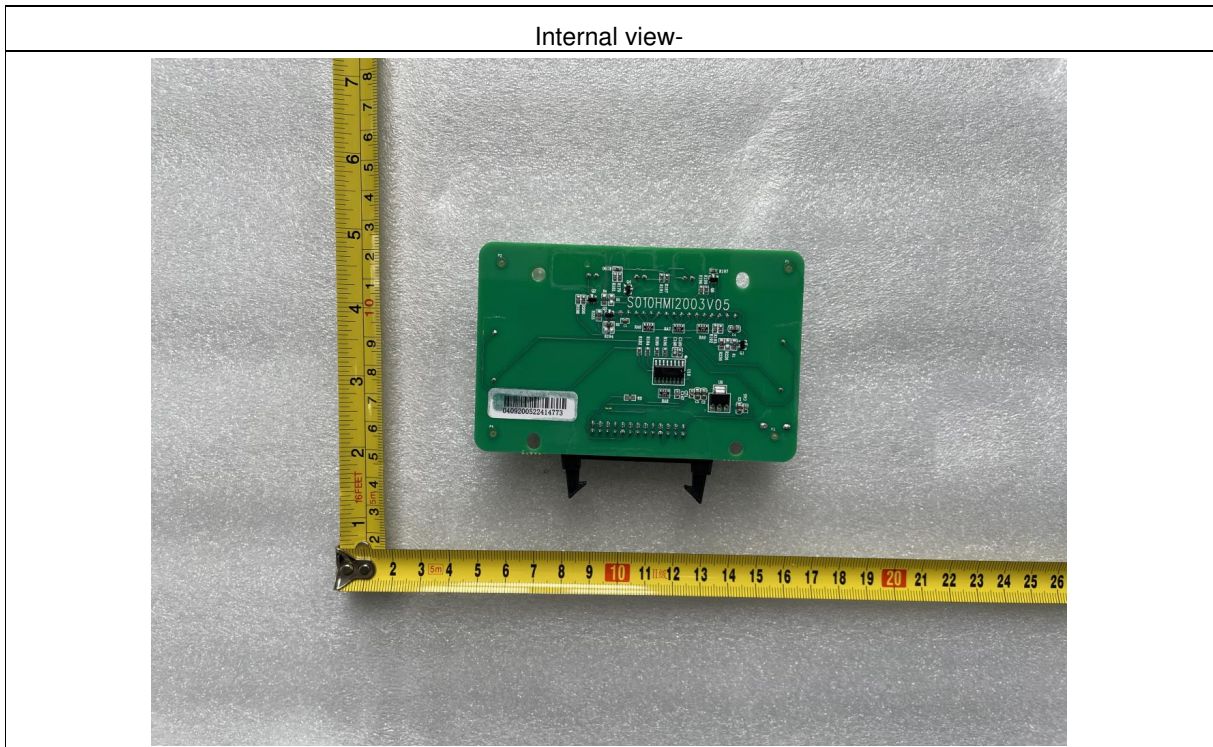

Appendix1 Photos:

Internal view-



Internal view-



Appendix1 Photos:

Internal view-

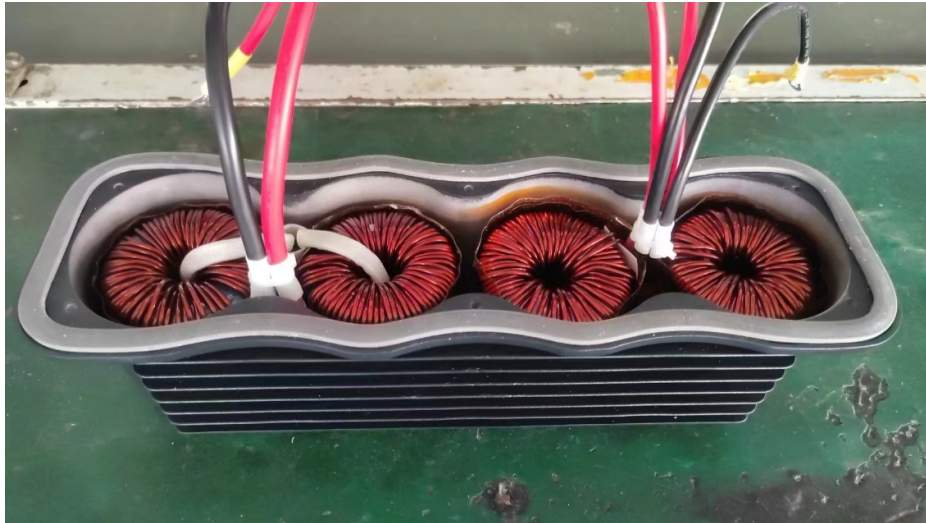

Internal view-

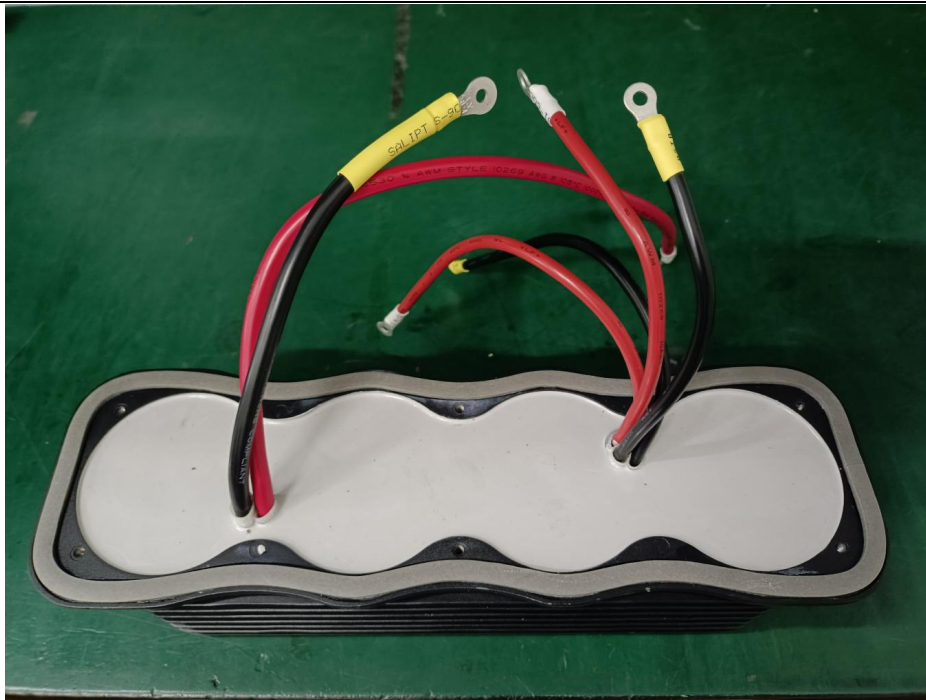

Appendix1 Photos:

Transformer-

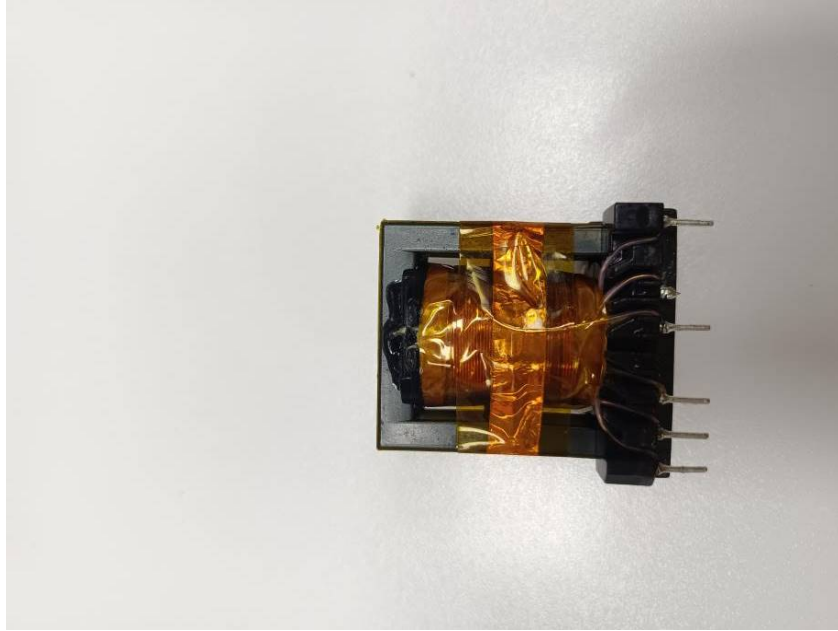

Transformer-

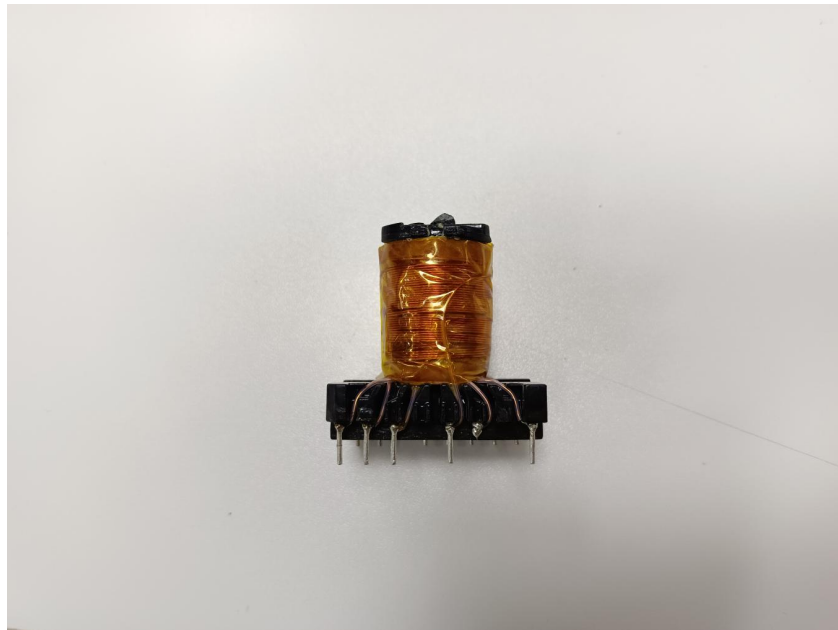

Appendix1 Photos:

Transformer-

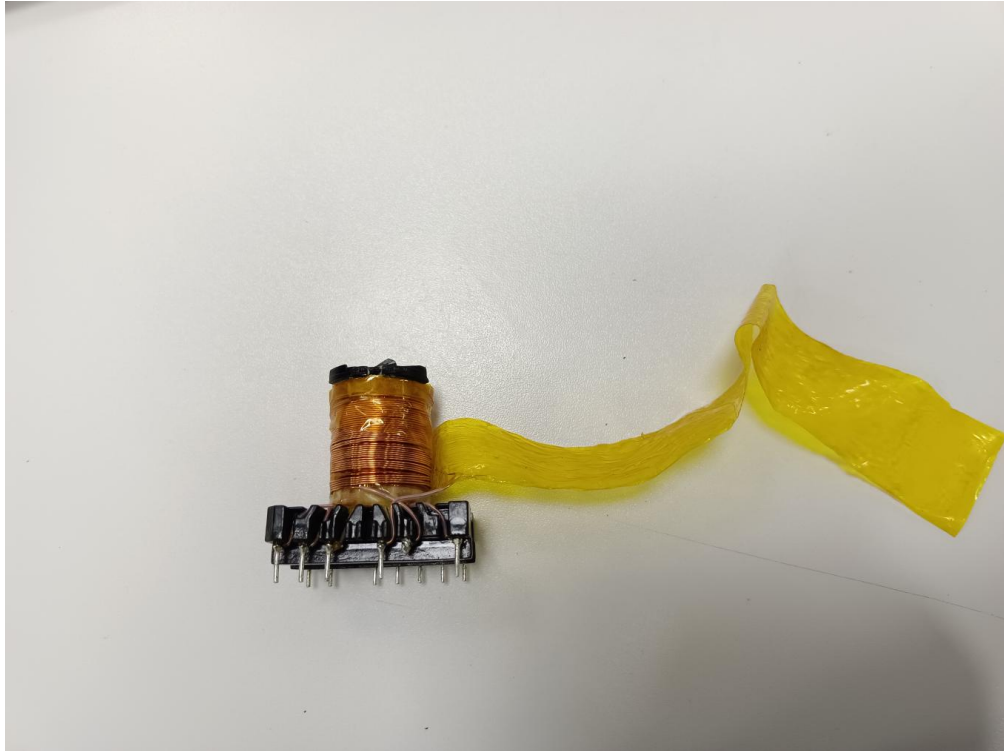

Appendix2-IEC 60529: 1989+A1:1999 +A2:2013			
Clause	Requirement / Test	Result / Remark	Verdict
12	Tests for protection against access to hazardous parts indicated by the first characteristic numeral	No opening on enclosure	P
12.1	Access probes		N/A
	Access probes to test the protection of persons against access to hazardous parts are given in table 6.		N/A
12.2	Test conditions		N/A
12.3	Acceptance conditions		P
12.3.1	For low-voltage equipment (rated voltages not exceeding 1 000 V a.c. and 1 500 V d.c.)		P
	The access probe shall not touch hazardous live parts.		P
12.3.2	For high-voltage equipment (rated voltages exceeding 1 000 V a.c. and 1 500 V d.c.)		N/A
12.3.3	For equipment with hazardous mechanical parts:	No hazardous mechanical part	N/A
	The access probe shall not touch hazardous mechanical parts		N/A
13	Tests for protection against solid foreign objects indicated by the first characteristic numeral	No opening on enclosure	P
13.1	Test means and the main test conditions are given in Table 7		P
13.2	Test conditions for first characteristic numerals 1, 2, 3 and 4.		N/A
13.3	Acceptance conditions for first characteristic numerals 1, 2, 3 and 4.		N/A
13.4	Dust test for first characteristic numerals 5 and 6		P
13.5	Special conditions for first characteristic numeral 5		N/A
13.6	Special conditions for first characteristic numeral 6		P
	Enclosure be deemed category 1		P
	After test, no deposit of dust inside the enclosure	no deposit of dust	P
14	Test for protection against water indicated by the second characteristic numeral		P
14.1	The test means and the main test conditions are given in Table 8		P
14.2	Test conditions		P
	Water temperature not differ by more than 5K form the temperature of the specimen during the tests for IPX1 to IPX6		P
	Pressure balance provided if more than 5K below the temperature of specimen		N/A
14.2.1	Test for second characteristic numeral 1 with the drip box		N/A
14.2.2	Test for second characteristic numeral 2 with the drip box		N/A
14.2.3	Test for second characteristic numeral 3 with oscillating tube or spray nozzle		N/A

Appendix2-IEC 60529: 1989+A1:1999 +A2:2013			
Clause	Requirement / Test	Result / Remark	Verdict
14.2.4	Test for second characteristic numeral 4 with oscillating tube or spray nozzle		N/A
14.2.5	Test for second characteristic numeral 5 with the 6,3mm nozzle		P
	The test is made by spraying the enclosure form all practicable directions with a stream of water from a standard test nozzle under following conditions:		P
	a) Internal diameter of the nozzle: 6,3mm		P
	b) Delivery rate: 12,5l/min \pm 5%		P
	c) Water pressure: adjusted to achieve the specified delivery rate		P
	d) Core of the substantial stream: circle of approximately 40mm diameter at 2,5m distance from nozzle		P
	e) Test duration per square metre of enclosure surface area likely t be sprayed: 1min		P
	f) Minimum test duration: 3min		P
	g) Distance from nozzle to enclosure surface: 2,5-3m		P
14.2.6	Test for second characteristic numeral 6 with the 12,5mm nozzle		N/A
14.2.7	Test for second characteristic numeral 7: temporary immersion between 0,15m and 1m		N/A
14.2.8	Test for second characteristic numeral 8: continuous immersion subject to agreement		N/A
14.3	Acceptance condition	No water entered	P
	If any water has entered, it shall not:	No water entered	N/A
	a) be sufficient to interfere with the correct operation of the equipment or impair safety;		N/A
	b) deposit on insulation parts where it could lead to tracking along the creepage distances;		N/A
	c) reach live parts or windings not designed to operate when wet		N/A
	d) accumulate near the cable end or enter the cable if any		N/A
15	Tests for protection against access to hazardous parts indicated by the additional letter		N/A

Appendix2-IEC 60529

IP6X testing



IPX5 testing



End of Test Report