

EEZ RV PRODUCTS

Tire Pressure & Temperature Monitoring System Tire Sensor Placement Diagram

Handles up to 26 wheels

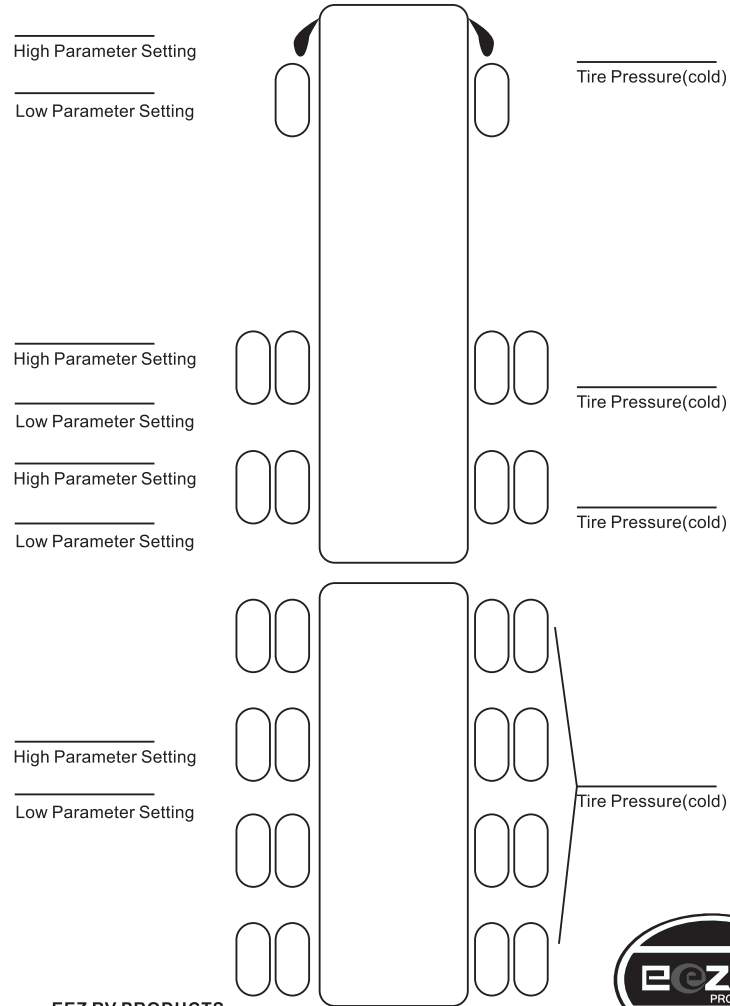

EEZ RV PRODUCTS
www.eezrvproducts.com



www.eezrvproducts.com



E618

TIRE PRESSURE & TEMPERATURE MONITORING SYSTEM

- Increase Fuel Efficiency
- Prolong Tire Life
- Increase Safety
- Reduce Maintenance Costs
- Fits Cars, RVs, Truck, Trailers & More

TABLE OF CONTENTS

SYSTEM COMPONENTS	02
SYSTEM OVERVIEW	01
MONITOR COMPONENTS & ICONS	02
GENREAL INFORMATION	03
PRODUCTS FEATURES	05
START YOUR SET UP HERE	05
SETTING YOUR SYTEMS ALARM PARAMETERS	06
PROGRAMMING SENSORS TO THE MONITOR	09
Programming Sensors (Method 1 - Tabletop Programming)	09
Programming Sensors (Method 2 - Air Activation)	10
Monitor Display in Operating Mode	11
MONITOR INSTALLATION	12
SENSOR INSTALLATION	13
DELETING SENSOR ID	13
OUT OF PARAMETER ALERTS	15
REPLACING ANTI-THEFT SENSOR BATTERY	17
OTHER FUNCTIONS	14
BACKLIGHT and MOTION SENSOR	14
FLOW THROUGH SENSOR BATTERY REPLACEMENT	18
REPEATER / SIGNAL BOOSTER (OPTIONAL PART)	20
Recreational Vehicles, Tow Vehicles & Trailers	21
Placement Instructions	21
Installation Instructions	21
REPEATER / SIGNAL BOOSTER INSTALLATION	21
REPEATER / BOOSTER ALERTS	21
High / Low Pressure & Fast Leakage Alerts	21
High - Temperature Alert	21
SPECIFICATIONS	22~23
Monitor	22~23
Sensors - Anti -Theft	22~23
Sensors - Flow Through	22~23
TROUBLESHOOTING & FREQUENTLY ASKED QUESTIONS	25~29
TIRE SENSOR PLACEMENT DIAGRAM	30

SHOW or HIDE Trailer Axles (E618 Color Monitor) This feature allows you to use more than one trailer with your monitor. Page24

This EEZ RV PRDUCTS EezTire E518 & (E618 color monitor) Tire Pressure and Temperature Monitoring System (TPMS) is a heavy-duty versatile system designed to operate on a variety of vehicles. (i.e. Motor Coach, 5th Wheel, Travel Trailer, Auto, Trailer, Big Rig, Farm and Mining Equipment).

SYSTEM OVERVIEW

The system comes with a monitor that can handle 26 wheels with pressures up to 210 psi. The sensors are lightweight and do not affect the tire balance and have easy to change replaceable CR1632 batteries. The system offers a method of dropping either the towing vehicle or the towed vehicle separately. This allows you to monitor the towing vehicle without a towed or the towed when driving away from the towing vehicle.

Monitor

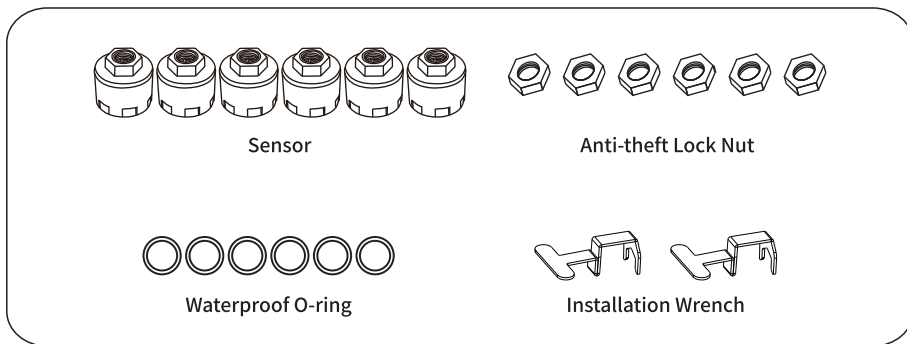
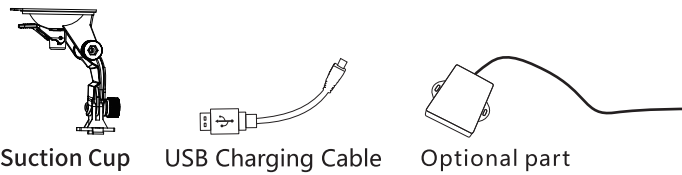
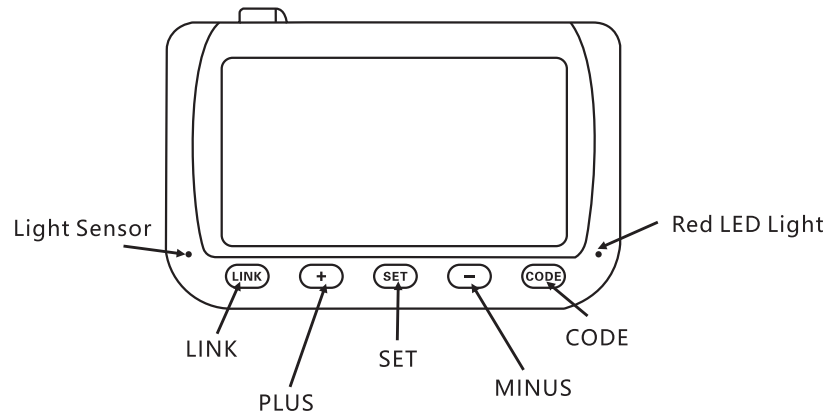

The monitor scrolls automatically through each wheel measuring tire pressure and temperature, displaying it on the monitor. Alarms can be preset by the operator so visible and audible alarms can warn the driver of a catastrophic failure (rapid air pressure loss), high or low pressures and high temperature. The alarms and monitoring are sent wirelessly in real time to the cab allowing the operator to monitor tires that are out of their vision. The audible alarm eliminates the need to watch the monitor continually.

Tire Pressure can be displayed in PSI or Bar and temperature in Fahrenheit (F) or Celsius (C). Pressure alerts can be set to a different pressure setting for each axle, so additional towed trailers or vehicles are no problem. An optional booster can be purchased from your dealer or at www.eezrvproducts.com if you have signal loss due to distance, structural or electronic interference.

The monitor has a rechargeable Lithium Ion battery. Sensors come with either the Anti-Theft security feature or Flow-Through feature, and the monitor comes with both an auxiliary charger and a hard wire cable at no extra charge.

The EEZ RV PRODUCTS Eez Tire E618 TPMS System offers both easy installation and one of the largest LCD monitors on the market.

GENERAL INFORMATION

A tire professional or your vehicle owner's manual should be used to determine the proper tire pressure for your vehicle. Recommended operating tire pressures should be set when the ambient temperature is low or cold.

Dramatic changes in tire pressure can occur because of; increased or decreased ambient temperature, tire contact surface temperature, wheel and axle loads, sun shining on a side, etc. These and other conditions should be taken into consideration when setting initial tire operating pressures.

This system cannot warn you of side wall failures; however, it can supply you with irregular pressures and temperature information that may help to prevent this. If the monitor is shut off overnight simply switch the monitor back on before departure and your real-time tire pressures and temperatures will be updated and typically appear on the screen within 5 to 10 minutes. Even if the monitor is in the sleep mode the system is always monitoring and will alarm should any pressure settings or temperatures be out of your set parameters.

The Schrader Valve (core - inside the valve stem) should be the correct size, be in good condition and be able to be depressed fully to allow the release of air to the sensor so it can operate. Some valve stem extensions may cause inaccurate readings if they do not enable the sensor to work correctly, metal

bodied stems, or T-Valve type is recommended for best performance. Should you have difficulty with a pressure sensor not working properly, we recommend that you contact a tire professional to ensure that the tire stem and Schrader Valve are installed and operating properly. If using internal tire sealants or balancing compounds/beads check with the manufacturer to ensure they are compatible with TPMS systems or that you have filtered valve cores installed. Over a period, tires may lose pressure naturally, through the tire itself or for other reasons such as rim leakage, etc.

After installing the sensors on a tire valve stem, it is recommended to perform a soapy water test using 1/4 dish soap and 3/4 water. Spray the soapy solution on the valve stem and sensor area to ensure the sensor is seated all the way. If air bubbles are seen in any of these areas, the tire may deflate. The wheel sensors are weatherproof and can be run in the rain.

Consult a tire professional if any of these areas prove to be a problem.

Purchasers of this product should not solely rely on this tire pressure monitoring system for safety and should check the condition and pressure of their vehicle's tires on a regular basis as described by the manufacturer of the vehicle or tire manufacturer. Please note, the EEZ RV PRODUCTS EezTire E518 TPMS System operates on an RF system, as with many RF tire systems this system can occasionally suffer from interference depending on the location of the system; thus, causing the system to be inaccurate or not operate at all. Tire pressures and temperatures are not the only things that can affect tire safety; we suggest daily visual inspections and periodic checks by tire professionals.

PRODUCT FEATURES

Monitor Features

- Reliable and easy to install.
- 4 ½-inch for color monitor E618
- Built-in rechargeable lithium ion battery.
- Automatic light sensor and backlight.
- Built in motion sensor.
- Configurable high/low-pressure warnings.
- Configurable high-temperature warnings.
- Visible and audible alerts.
- Select-able pressure units.
- The monitor can display in either standard or metric measurements (psi or bar/°F or °C)
- It monitors up to 26 tires maximum.
- Long range between sensors and monitor.

Sensor Features

- Reliable cap sensors, easy to install.
- Water resistant.
- Replaceable sensor batteries.
- Fast leak alert.
- Individually coded sensors.

Repeater/Booster Features (optional part)

- Maintains signal stability.
- Records sensor ID, and tire pressure and temperature limits.
- Visible and audible alerts.

SYSTEM SETUP

This portion is designed to make the set-up of your new EEZ RV PRODUCTS EezTire E618 TPMS System easier and faster.

Much of the information contained in this manual is found through real life experience using the system and passed on to hopefully make the utilization of the system easier for you.

“Please read through the guide thoroughly before starting. Complete set-up should take approximately 20 minutes.”

EEZ RV PRODUCTS EezTire E618 SYSTEM

START YOUR SET UP HERE - Step by Step Instructions:

1. Unpack all the components of your TPMS System and ensure it is complete.
2. Take the number kit from the accessory pack and number all your sensors as indicated below. (Hint: After affixing the number to the sensor take some clear nail polish and paint over the number. This will help ensure it stays on in

increment weather conditions.)

3. On the diagram on the last page of this manual assign the numbered sensors to each tire as they will be put on your rig and tow vehicle. Also fill in the tire pressures for each axle.

4. Program the alarm parameters using STEP 1 setting your system alarm parameters.

5. Program each sensor to the monitor using METHOD 1 tabletop page 10, programming sensors to the monitor.

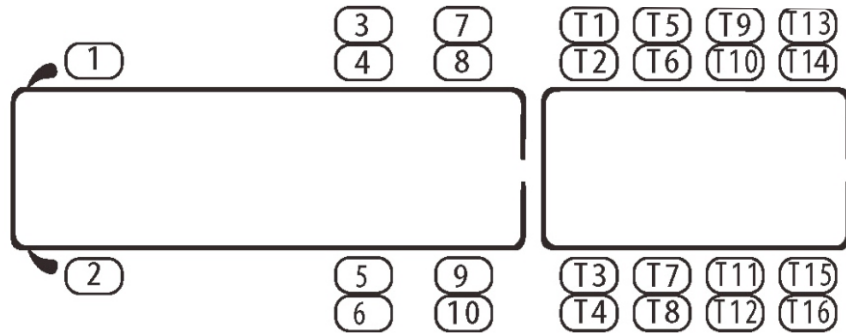

STEP 1: SETTING YOUR SYSTEMS ALARM PARAMETERS

Refer to the diagram on the last page of this manual where you wrote the “HIGH and LOW” pressure for each axle.

1. Next to each axle write down what your tire pressure is by axle and calculate what your alarm setting will be.

2. High-Pressure setting will be (20% above axle tire pressure).

3. Low-Pressure setting will be (10% below axle tire pressure).

Example: Front Axle Tire Pressure is: 100 psi High-Pressure Alarm Setting will be: 120 psi (100 psi x 1.20 (or 20%) = 120 Low-Pressure Alarm Setting will be: 90 psi (100 psi x .9 (or 90%) = 90

These are industry standards for the initial set-up. Some adjustment may be needed on your first trip.

For the temperature, it is recommended leaving it at the factory default of 158 degrees F.

STEP 2: Choosing Pressure and Temperature Unit of Measure:

PRESS and HOLD the SET button until you hear the beep. You will see PSI flashing on the left side of the screen. Press the set button again and you can change to BAR by pressing the + or – key to scroll between the two. When the

one you want to use appears in the screen press and release the SET button. (Pressing and releasing the SET button in this mode is like saying yes to what the screen is showing you.)

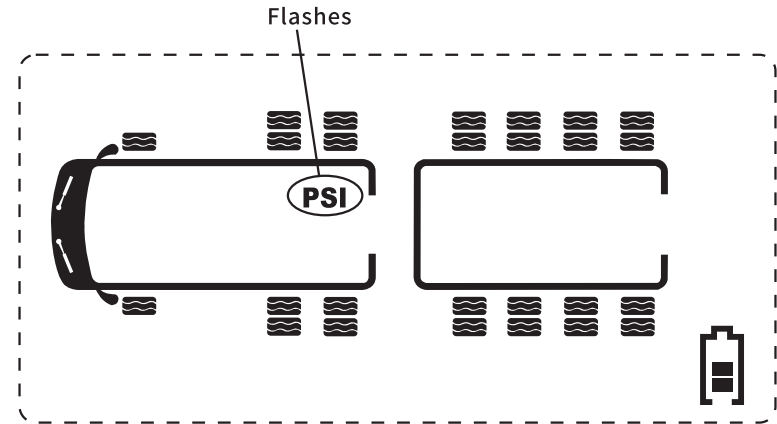

Press the set button again and “F” will be flashing. Press + or – to change to “c” if you like.

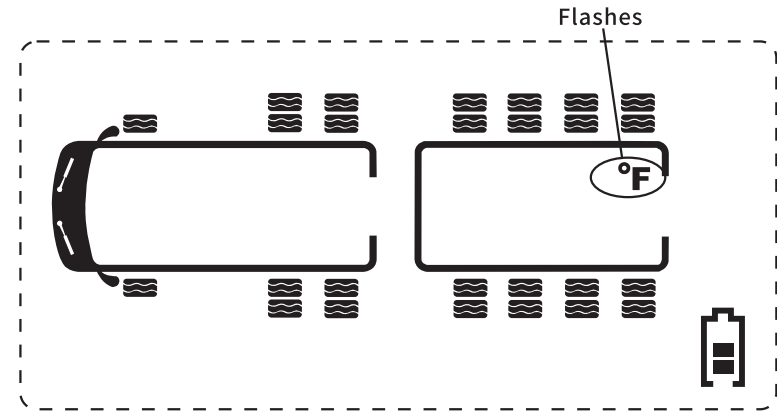

The next time that you press the set button the front axle will be flashing and the words “HIGH PRESSURE” will be displayed. Follow the instructions below.

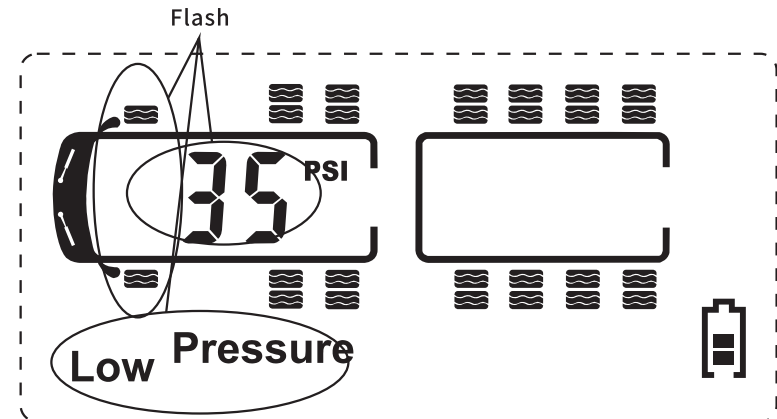
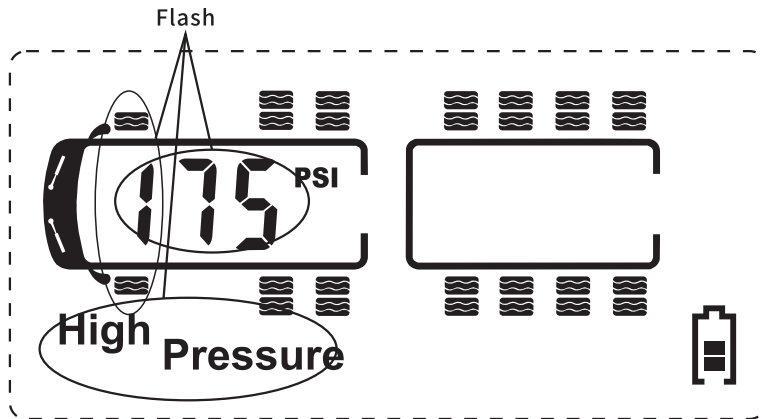

STEP 3: Choosing per Axle High and Low Parameters:

Using the set key scroll to your first axle "HIGH" pressure. Use the plus or minus to set your HIGH PRESSURE. When you reach your desired pressure press and release the "SET" button again and "LOW PRESSURE" will be displayed. Use the plus or minus keys to set your low pressure. Press the set button again and the next axle will flash "HIGH PRESSURE". Make your adjustments the same way as for the first axle. Skip any axles that you are not using and just keep hitting the "SET" button until you get to the axle that you want to set.

When you have finished setting your parameters PRESS and HOLD the SET button until the monitor beeps and you are back to display mode. Keep in mind that the monitor will time out in 40 seconds. So, write down your settings before you start.

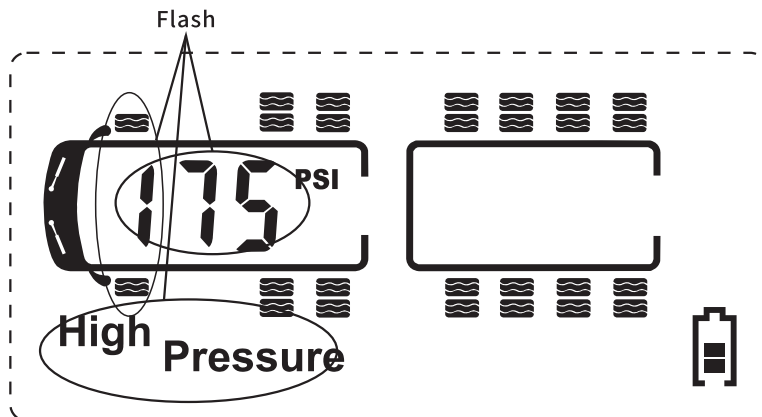

PROGRAMMING SENSORS TO THE MONITOR

METHOD 1 tabletop (this is the easiest way)

1. Using the switch on the left side of the monitor, push it up to turn on the monitor. Place the monitor flat on the table in front of you. Then place your numbered sensors on the table about a foot away from the monitor.
2. Press and hold the CODE button on the lower right side down until you hear the monitor beep and all 26 tires show up with number 1 tire blinking. After programming, only those tires that you program will show on the monitor. Following your diagram on the back of your Manual, place the monitor flat on the table and then place your number 1 sensor on the table making sure that the sensor is touching the base of the monitor next to the SET button. You will see "FFF FFF" on the screen. All F's means that, that sensor is not programmed yet. Then press and release the code button one time quickly. The monitor will beep, and a random code will be displayed. Press the plus button to go to the next tire and do the same for each tire that you have and so on.



3. When you have programmed the last sensor, press the “CODE” button down until the monitor sets off the alarm. Then turn off the monitor then turn it on again to make sure the tires are programmed in the right position.

4. Install your sensors to the valve stems in the order that you programmed them. Give the monitor 5 to 10 minutes depending on the number of sensors that you have. Once the sensors are synced you will not have to resync unless you turn off the monitor. You will not lose any data if you turn off the monitor, but you will have to wait for the system to resync when you turn the monitor back on. You can leave the monitor turned on by the monitor’s battery power. The E618 monitors internal battery will run for about 60 hours or 30 days between charges.

NOTE:

If you get an ID LF ERROR (low frequency), error code, hit the sensor hard on the table to wake it up and repeat. If you still get the ID LF ERROR, press the CODE button and release, pause and then press the CODE button and release again. If it still gives ID LF then check the battery voltage with a voltmeter. The voltage on a fresh battery should be 3.2v. If it is at or below 2.8v replace the battery with a fresh one. Make sure that the battery is installed in the proper orientation as shown in this manual.

We have a video on our website that shows how to program your system at <https://eezrvproducts.com/downloads-%26-videos>

Method 2: AIR ACTIVATION

1. Using the switch on the left side center of the monitor push it up to turn on the monitor.
2. Place the sensors on the tires as numbered on your diagram but not under air pressure yet.
3. Press and hold the “CODE” button on the lower right side down until you hear the monitor beep. At this time, you will see all 26 tires on the monitor screen and the right front (#1 passenger side) tire should be flashing. Use the + or – button to move to the tire that you want to program. Place the monitor within 3 inches of the sensor and screw the sensor all the way on. Wait a few seconds and the monitor will beep and a random code will be displayed. If it does not press and release the “CODE” once. Once coded press the plus button to go to the next tire (#2 drivers’ side) and repeat the steps. Use the plus key to go to the next tire and repeat, skipping any tire that is not on your rig.

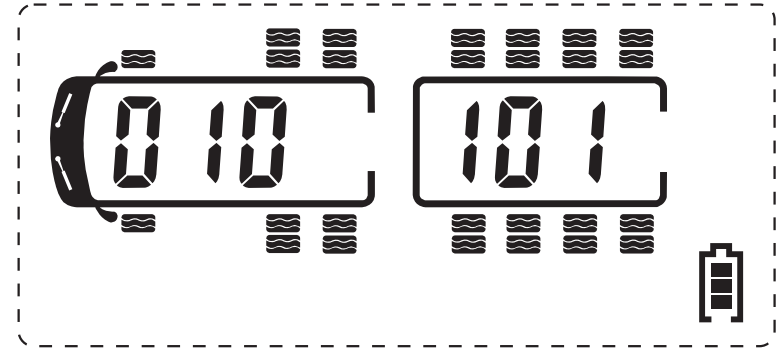

YOUR SYSTEM IS NOW SET-UP AND READY FOR USE

If you have problems, see trouble shooting starting on page 25.

MONITOR DISPLAY IN OPERATING MODE:

After the sensors have all been programmed and the system is in operating mode the display will automatically scroll through each monitored tire one by one. The tire being transmitted will flash on the screen, and the pressure and temperature for that wheel will be displayed on the monitor. When the monitor is initially turned on it may take up to 5 to 10 minutes for the monitor and sensors to sync up before the pressure and temperature will show up on the monitor. Wait for all the tires to read before driving. After this time if you see one sensor is still not transmitting the pressure and temperature you may want to reprogram the sensor. On an initial set up, if the tire still fails to indicate a pressure and temperature remove the sensor and back the Schrader Valve (valve core) out approximately 1/8 to 1/4 turn and re-install the sensor. This will ensure there is enough contact and air pressure to the sensor.

NOTES and RECOMMENDATIONS:

There will be an audible single “chirp,” and the tire will flash if the monitor has not received a reading from that tire after 30 minutes. If you are still receiving PSI and Temp readings from the sensors, then the chirp is an indication of low battery on that sensor. You can also manually scroll through

the tires one by one by pressing the + or - button. If you manually select a tire the monitor will show its readings for 10 seconds. The monitor comes equipped with a light sensor; the backlight will typically come on if the vehicle is in motion and the light level is low enough. You may also wave your hand in front of the monitor to manually activate the backlight or by pressing any button. It can be turned off by pressing the + button for 3 seconds. The light sensor is located on the lower left of the monitor, just left of the "LINK" button. The monitor comes with a built-in motion sensor; it will go to sleep (energy saver mode) if there is no movement of the vehicle detected for approximately 15 minutes and wake up when it detects movement. It is recommended that the monitor is shut off when the system is not in use, or you are staying in the vehicle overnight. When external power is applied to the monitor it will override the manual on/off switch on the left side. If you hard wire your system charger to a "keyed" switch the system will go off when the keyed power is turned off. If you are using the auxiliary charging cord, you will have to unplug the charger manually. You will get a longer service life from your monitor's internal battery, if you disconnect the external power source and allow the battery to deplete through normal operations every couple week's naturally.

Factory Defaults

The factory default settings are as follows:
 High Pressure (175 PSI),
 Low Pressure (35 PSI),
 Temperature (158 degrees).

RESTORE PARAMETERS to FACTORY DEFAULTS:

Turn off the monitor; press the SET button and activate the monitor at the same time. The RED light will flash, and factory settings will be restored. To delete a sensor ID see page 14.
 Pressure Unit: PSI High Pressure: 175 psi (12.1 BAR) Low Pressure: 35 psi (6.9 BAR) Temperature Unit: OF High Temperature: 158 F (70 C)

MONITOR INSTALLATION

Your system comes with two mounting option: a plastic tower with suction cup mount for window or dash, low profile mount for dash. Some people prefer to use Velcro or the small bean bags used for cell phones on their dash.

Mount it onto the windscreen or left side window using the suction cup provided ensuring you do not obstruct the driver's vision of the road. Plug the power adapter into the cigarette lighter or auxiliary power outlet and connect the power cable to the monitor. Ensure the pin is aligned straight when inserting it into the right side of the monitor. When hard wiring it is recommended using a "keyed" power source.

SENSOR INSTALLATION

1. Remove the tire valve cap and mount the corresponding sensor on the valve stem using the wrench provided.
2. wrench provided.
3. Simply screw the wrench clockwise.

NOTE: Please switch on your display before sensor installation.

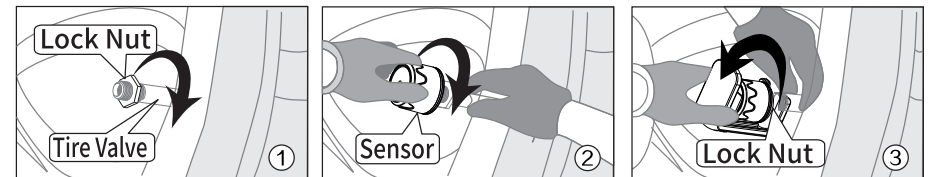

Install the sensor onto tire valve

Tighten the sensor onto tire valve clockwise

Tighten the lock nut onto the sensor anticlockwise

DELETING SENSOR ID

1. In operating mode, press and hold the CODE button until the monitor beeps and all 26 tires are showing. Press the + or - button to select the desired tire.
2. Press and hold the SET button for 3 seconds. A double-beep sound will be issued, and you will see FFF FFF after the sensor code is deleted successfully. Use the + or - key to go to the next tire that you want to delete. To return to operating mode, press and hold the "CODE" button until you hear the monitor beep.

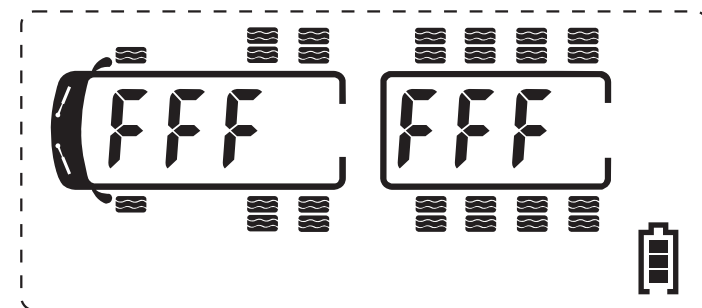

OTHER FUNCTIONS

Typical Scrolling Display During normal operation, the monitor scrolls through and shows the tires one by one for approximately 6 seconds. A single audible chirp will be issued if the monitor does not receive one of the sensors data for more than 30 minutes. You can manually scroll through and select the tire by pressing the + or – button.

Backlight and Motion Sensor

The monitor has a built-in light and motion sensor. The backlight turns on when it detects the vehicle is in motion and when it is dark enough, or you may wave your hand in front of the monitor to activate it. Press any button on the monitor to turn on the backlight manually.

The monitor will enter sleep mode to conserve battery life if the motion sensor does not detect motion for 15 minutes. It will come back to operating mode when it detects the vehicle is moving again or other motion.

Temporarily Remove Towing Vehicle or Towed/

Trailer Image from Screen

To drop the image of the towing vehicle from the screen press and release the LINK and + key at the same time. To display it back on the screen press and release the LINK and + key at the same time again. (This will allow you to use the system in your towed when not connected to the coach.)

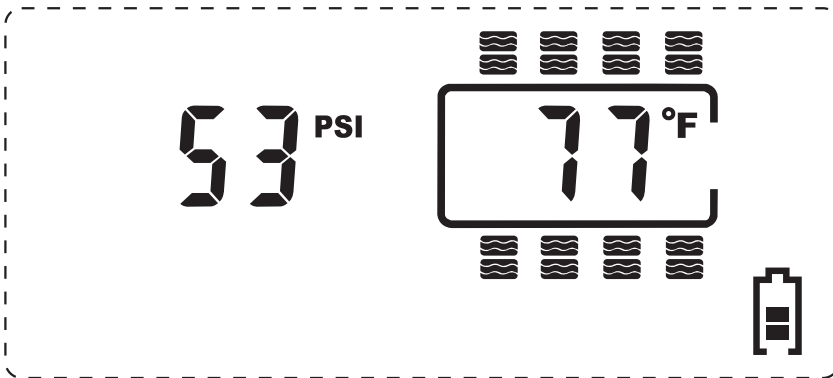

To drop the image of the towed vehicle/trailer from the screen press and release the LINK and - key at the same time. To display it back on the screen press and release the LINK and - key at the same time again.

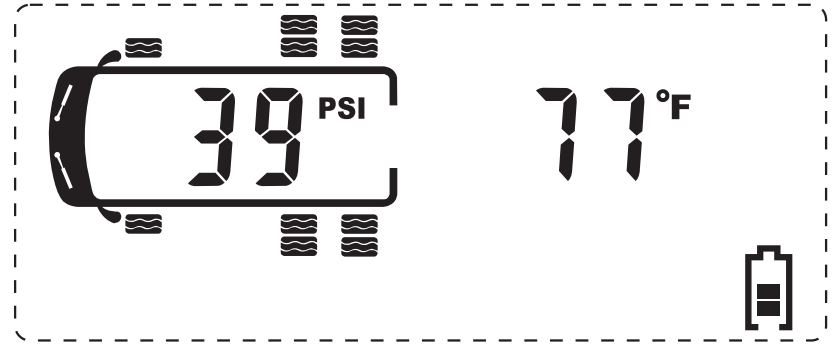

Charging the Monitor

The lithium-ion battery inside the monitor, when fully charged can run for up to 60 hours between charges. When the battery symbol bars are gone, a recharge is required.

OUT OF PARAMETER ALERTS

The system cycles from tire to tire every 6 seconds. If there is a meaningful change in pressure or temperature in this cycle it will transmit it to the monitor. If not, it will maintain the reading and transmit a full update every 5 minutes. This is to conserve the sensor battery. If any reading goes out of the real-time alert; you will notice three things:

1. An audible alarm.
2. The red light on the lower right side will flash.
3. The corresponding tire on the monitor will flash, and a text message of what is wrong will appear on the screen.

Press any button on the display and the alarm will stop. However, the red light will not be turned off until the correct pressure, and temperature settings are restored to within range.

MONITOR ALERTS	
<p>High Pressure Alert</p> <p>When the sensor detects high pressure in a tire, it will send an alert to the monitor immediately. The corresponding tire icon will flash. The audible alarm will be on together with the flashing red light. Press any button to turn off the alarm. However the flashing red light and text will continue until the problem is corrected.</p>	
<p>Low Pressure Alert</p> <p>When the sensor detects high pressure in a tire, it will send an alert to the monitor immediately. Low Pressure will show on the LCD and the corresponding tire icon will flash. The audible alarm will be on together with the flashing red light. Press any button to turn off the alarm. However the flashing red light and text will continue until the problem is corrected.</p>	
<p>High Temperature Alert</p> <p>When the sensor detects high temperature in a tire, it will send an alert to the monitor immediately. High Temperature will show on the LCD and the corresponding tire icon will flash. The audible alarm will be on together with the flashing red light. Press any button to turn off the alarm. However the flashing red light and text will continue until the problem is corrected.</p>	

<p>Fast Leakage</p> <p>When the sensor detects a rapid air loss in a tire, it will send an alert to the monitor immediately. Fast Leakage will show on the LCD and the corresponding tire icon will flash. The audible alarm will be on together with the flashing red light. Press any button to turn off the alarm. However the flashing red light and text will continue until the problem is corrected.</p>	
<p>Sensor Low Battery Alert</p> <p>When the sensor battery becomes low, it will send an alert to the monitor immediately. Sensor Battery Low will show on the LCD and the corresponding tire icon will flash. The audible alarm will be on together with the flashing red light. Press any button to turn off the alarm. However the flashing red light and text will continue until the problem is corrected.</p>	

Replacing Anti-Theft Sensor Battery

When you here the low battery tweet sound coming from the monitor it is time to replace the battery.

Replace with a CR1632 battery, which operates at -40°F to 176°F. These can be purchased at many hardware stores, Radio Shack or large Walmart on-line at either eBay, Amazon.com or on our site

www.eezrvproducts.com.

NOTE FOR ANTI-THEFT SENSORS: If an anti-theft sensor stops transmitting the first thing you want to check is the sensor battery. When you open the sensor note the thin black wire, it is the sensors antenna. Do not break it. Broken antenna wire caused by replacing battery is not covered under

warranty. Remove the battery and check it with a voltmeter, it should read 3.2V. Anything at or below 2.8V should be replaced.

Use the supplied wrench to remove the sensor.

1. Use the wrench provided to put on the sensor valve as below. Then screw off the sensor valve anticlockwise and open the battery cap.

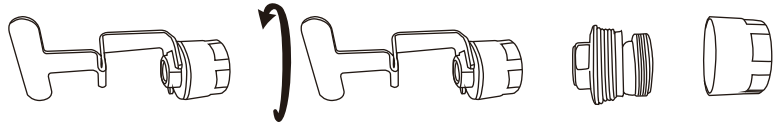

2. Take out the battery from battery pool.



3. Install a new CR1632 battery inside the battery pool, make sure positive pole upside.

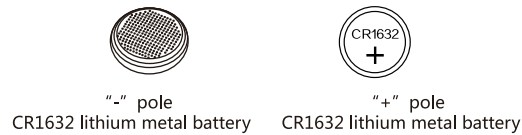

4. Put back the battery cap and tighten the cap with the wrench clockwise.

NOTE: Replace a new waterproof O-ring from the accessory pack if it's broken.

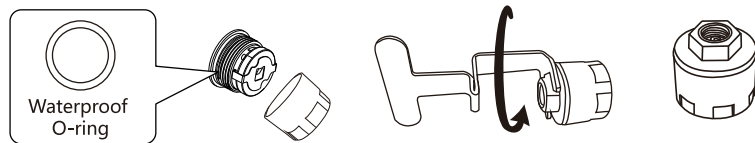

When you open the sensor note the thin black wire, it is the sensors antenna. Do not break it. Broken antenna wire caused by replacing battery is not covered under warranty.

Flow Through Sensor Battery replacement

When you hear the low battery tweet, the next time you park the vehicle watch the monitor. Every time the monitor comes to that sensor the monitor will tweet.

Install CR1632 battery which operates at -40°F to 176°F. These can be purchased at many hardware stores, Home Depot or large Walmart's on-line at eBay, Amazon.com or on our site www.eezrvproducts.com.

Use the hex/Allen wrench provided to remove the anti-theft screw and take off the sensor. Then use a small Philips screw driver to take the cap marked "EasyTire" off. Under the cap is the battery. Remove it and replace it with a new CR1632 battery. Depending on how long the battery was low you may have to reprogram the sensor.

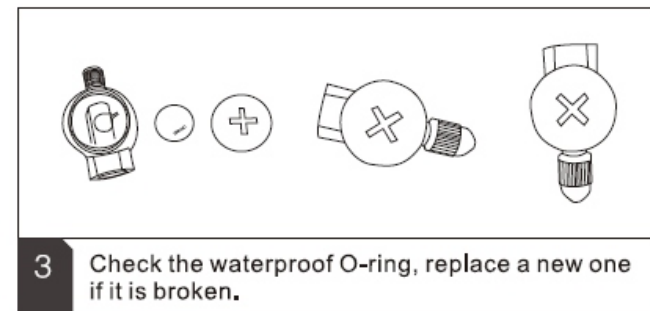
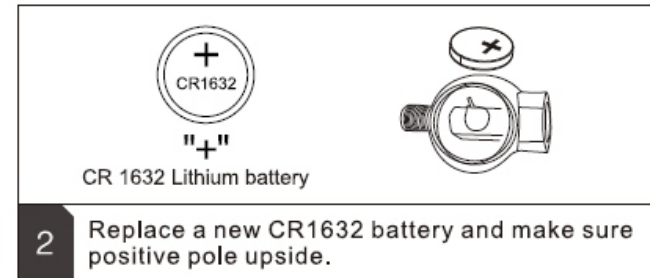
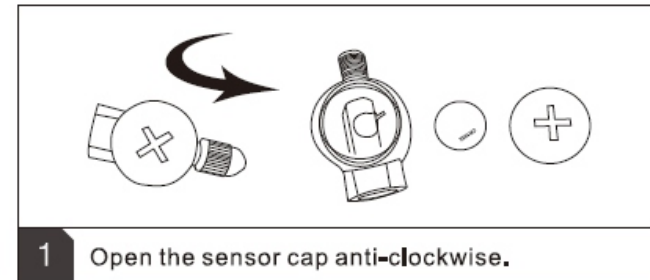

REPEATER/SIGNAL BOOSTER INSTALLATION

Recreational Vehicles, Tow Vehicles, Trailers and Tractor Trailer

The Repeater/Booster is designed to amplify the signal from your TPMS system sensors. In situations where length, structure or electronic interference prevents your monitor from receiving a signal, the Repeater/Booster amplifies the sensors transmitting distance.

Some Diesel Pushers experience difficulties do to the number of electronic components in the engine compartment.

As well as where sensors are shielded by bodywork etc. causing sensor signal strength to be reduced and where extremely cold temperatures may reduce sensor battery power. The optional signal Repeater/ Booster can be ordered separately and is available at www.eezrvproducts.com. The hard-wired booster should have 12V DC power when the vehicle is moving.

PLACEMENT INSTRUCTIONS

Motor Coach Placement: It is recommended to install the Repeater in an outside - aft compartment or in your rear closet.

Fifth Wheel Placement: It is recommended to install the Repeater in an outside compartment under the front bed area.

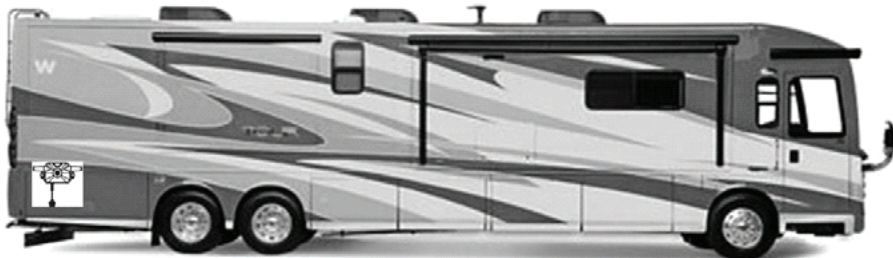

Hint: Most people install them into their aft compartment or closet in the coach and wire it into the compartment or closet light. By placing it on the coach you receive the advantage of the Repeater/Booster even when your tow vehicle is not connected. **INSTALLATION INSTRUCTIONS** Be sure to wire the Repeater into a 12V power source that will be “on” during vehicle operation. The Repeater will be on as soon as it is connected to power. The red light stays on when power is connected.

Button & Red Light

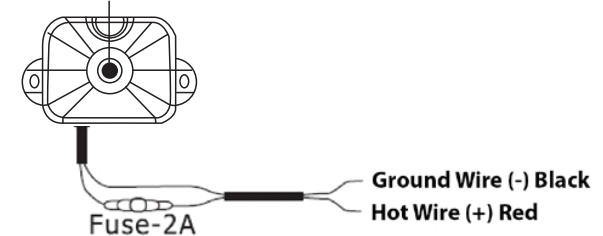

The center button that lights up also serves as a reset button.

INSTALLATION OF THE REPEATER ONLY REQUIRES IT BEING CONNECTED TO A 12V POWER SOURCE AND GROUND - WHEN THE RED LIGHT COMES ON IT IS FUNCTIONING.

REPEATER/BOOSTER ALERTS

High/Low Pressure and Fast Leak Alerts

When the sensor detects high/low-pressure abnormalities and rapid leaks, it will send an alert to the Repeater/Booster immediately. The audible alarm will be on together with the flashing red light. Press any button on the monitor to turn off the alarm. However, the flashing red light will continue until the issue is resolved. The system is set to alarm if you lose more than 7.25 psi in a minute.

High-Temperature Alert

The monitor has a fixed temperature alarm at 158 deg F/70deg C. The sensors send the temperature readings to the monitor. If the temperature is above 158 deg F/70deg c, an audible alarm will be on together with the flashing red light. Press any button to turn off the audible alert. The red light will remain on until the issue is resolved.

Specifications

Monitor

OPERATIONAL TEMPERATURE	-4°F to 176°F
STORAGE TEMPERATURE	-22°F to 185°F
CHARGER INPUT VOLTAGE	DC 8 to 30V
TRANSMISSION FREQUENCY	433.92 MHz
SIZE (in)	5.24x3.67x0.98
Weight (oz)	5.93 oz

Sensors - Standard

OPERATIONAL TEMPERATURE	-4°F to 176°F
STORAGE TEMPERATURE	-40°F to 185°F
PRESSURE RANGE	0 to 13 bar, 0 to 188 psi
PRESSURE ACCURACY	±1.5%
TEMPERATURE ACCURACY	+5 -5 °F
TRANSMISSION POWER	<10dBm
TRANSMISSION FREQUENCY	433.92 MHz
BATTERY LIFE	up to 2yr. (CR1632 -40°F to 176°F)
SIZE (inch)	Diameter 0.9, Height 0.86
WEIGHT	0.45oz

Sensors - Flow Through

OPERATIONAL TEMPERATURE	-4°F to 176°F
STORAGE TEMPERATURE	-40°F to 185°F
PRESSURE RANGE	0 to 13 bar, 0 to 188 psi
PRESSURE ACCURACY	±1.5%
TEMPERATURE ACCURACY	+5 -5 °F
TRANSMISSION POWER	<10dBm
TRANSMISSION FREQUENCY	433.92 MHz
BATTERY LIFE	up to 2yr. (CR1632 -40°F to 176°F)
SIZE (inch)	1.89x0.79x0.91
WEIGHT	0.45 oz

Booster / Signal Repeater (Optional Parts)

OPERATION TEMPERATURE	-4°F to 176°F
STORAGE TEMPERATURE	-22°F to 185°F
WORKING VOLTAGE	DC 8 to 30V
TRANSMISSION POWER	433.92 MHz
TRANSMISSION FREQUENCY	5.24x3.67x0.98
SIZE (Inch)	5.93 oz
WEIGHT	5.93 oz

SHOW or HIDE Trailer Axles (E618 Color Monitor)

This feature is meant to allow you to use more than one trailer with your monitor.

1. Press and hold the LINK and SET button down until the monitor beeps, then release the buttons. The first trailer axle tires will flash with a number “1” on the trailer portion of the display.

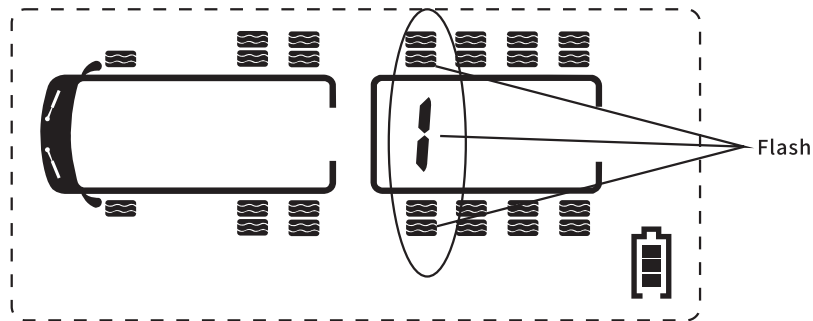

2. Quickly press the minus button “-” and the number “1” will turn to “0” with a beep. Now the first axle is hidden. To show the axle again just quickly press the plus button “+” and the “0” will change back to “1”. Just remember “1” means that the axle is showing and “0” means that it is hidden.

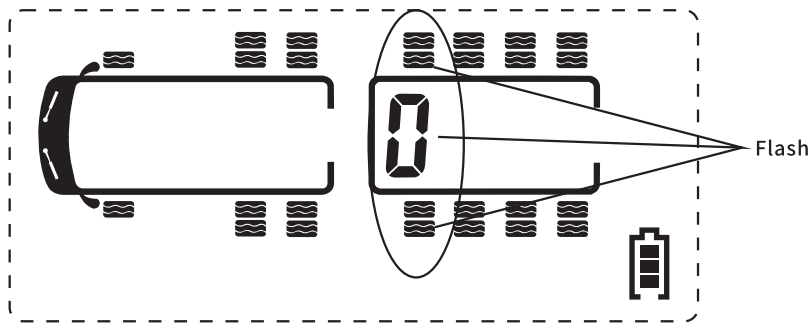

3. Quickly press and release the LINK and SET buttons simultaneously to move to the next axle. Repeat the above steps for any other trailer axle that you want to show or hide.

4. After you have setup the axles the way that you want press and hold the LINK and SET buttons down for about 6 seconds to save changes and return to display mode.

TROUBLESHOOTING & FREQUENTLY ASKED QUESTIONS:

1. What does it do?

Answer: Measures the air pressure and temperature within the tire to ensure your tires are operating within safe parameters.

2. How does it work?

Answer: Tire pressure monitoring systems continuously monitor the pressure in the tires through sensors located on the valve stem. The information collected by the sensors is transmitted to an on-board monitor that displays the tire data and warns the driver when tire pressure or temperature is outside of the preset level.

3. What is the advantage of tire pressure monitoring system?

Answer: Under-inflated tires need more fuel than properly inflated tires. The system will notify you of an impending problem before a blowout. It will save you money while providing peace of mind while driving.

4. Is low tire pressure easily detected by the eye?

Answer: Under-inflated tires are visually difficult to detect. It is recommended that tires are inspected and checked monthly with an accurate gauge. *The TPMS is not intended to be a substitute for regular tire maintenance.*

5. Why does tire pressure change during driving?

Answer: Many factors affect tire pressure including ambient temperature changes, road conditions and tire damage such as punctures. Tire pressure drops about one psi for every 10 degrees F drop in ambient temperature. Additionally, tires lose as much as 1.5 psi per month as air escapes the tire and rim naturally.

6. Why there are no pressure and temperature readings on the LCD, only tire icon flashes?

Answer: The monitor will stop showing the pressure and temperature if it doesn't get the signal from the sensor. During normal operation, the monitor scrolls and displays the tires one by one for approximately 6 seconds. A single audible chirp will sound if the monitor does not receive one of the sensors data for more than 30 minutes or if the sensor has a low battery.

7. What happens if I remove a sensor from a wheel?

Answer: The monitor will set off an audible alarm. It will stop if you put the sensor back on. This is a good way to test the sensor.

8. How do I turn off the “low-pressure or high-pressure” warning on the monitor?

Answer: Press any button will stop the audible alarm, you will need to inflate your tires to the appropriate pressure to stop the red light and text warning.

9. My TPMS warning light comes on when I start my car, but after a few minutes of driving, it turns off.

Answer: The monitor will stop showing the pressure and temperature if it doesn't get the signal from the sensor. During normal operation, the monitor scrolls and displays the tires one by one for approximately 6 seconds. A single audible chirp will sound. Answer: In cold weather, the sensor reads a lower PSI. As you drive, the air within your tires warm up, and thus the pressure is also increased.

10. I just filled my tires with air a few weeks ago, and it is showing me that I have low pressure.

Answer: A change in climate can affect the readings of the sensor because of the change in pressure of the tire. If it has only been a short period, you may want to verify the tire pressure with a gauge to determine if it is a leak or a faulty reading.

11. How is the accuracy of the temperature readings on external sensors?

Answer: There will be some differentiation between the actual inside air temperature and the reading on the outside of the tire. However, it will still be an indicator of a tire heating up due to air loss, soft side wall, a brake drum dragging or a bearing seizing and heating up the rim.

12. If one sensor in a kit stops working, is it possible to replace sensors alone?

Answer: Yes, each sensor has a unique ID CODE; just program the new sensor to the monitor, the new sensor will replace the old sensor automatically.

13. Do I need to re-program the sensors after tire rotation?

Answer: NO. The sensors should be removed from the tires before tire rotation. Then the sensors should be replaced in the position that they were programmed to.

14. Can I combine sensors or boosters from other manufacturers with the EEZ RV TPMS PRODUCTS System?

Answer: It is not recommended to mix and match components from other systems. We cannot guarantee parts from other systems will work properly or at all with each other.

15. Is it possible that sensors interfere with each other?

Answer: No, sensors transmit separately, it takes very little time to transmit signals. So, there is an exceptionally low probability that sensors would interfere with each other.

16. What's the transmitting distance from sensors and monitor?

Answer: It used to be easy to determine if you would need a Repeater/ Booster and at that around 50 ft was a general rule we would look at. Nowadays though the big diesel pushers have so much electronics in the engine compartment and dashboard they can get interference. As well as the structure of the frame, number of slides and the amount metal on many of the new rigs of all styles can also be a factor. So, you can get interference for issues other than distance. Systems will typically read fine sitting still, you won't see the interference until about 20-30 minutes or longer into the trip. It is impossible to predict whether you need a booster.

17. Is signal booster available?

Answer: Yes, we do carry an optional signal booster for vehicles or if it determined you have either electronic or structural interference. You may order an optional Repeater/Booster on our site at www.eezrvproducts.com.

18. Can I reset the perimeters to factory default?

Answer: Yes, to restore perimeters to factory defaults, turn off the monitor, press the set button and turn the monitor on at the same time. The red light will flash, and factory perimeters settings restored. This will not delete the sensors.

19. Do I need a signal booster (transceiver)?

Answer: It used to be easy to determine if you would need one. The general rule was around 50 ft, but nowadays, though most vehicles have so much electronics in the engine compartment and dashboard, they can cause interference. As well as the structure of the frame, the number of slides and the amount of metal on many of the new rigs of all styles can also be a factor. So, you can get interference for reasons other than distance. Systems will typically read fine sitting still; you won't see the interference until about 20-30 minutes into the trip.

20. Does this system measure temperature as well as pressure?

Answer: Yes, unlike some systems from other suppliers that just measure pressure the EEZ RV PRODUCTS EezTire TPMS System measures internal tire air temperature and has an over temperature alarm. This is an advantage on vehicles that are stored for extended periods of time where brake calipers can stick after the first brake application and cause a dragging brake situation

21. I am having AIR ACTIVATION setting issues, what can cause those?

Answer: Coding issues can be due to incorrectly sized or a bent valve core (Schrader valve) or valves torque to tight or too loose in the tire valve stem thus not allowing the sensor to operate. For issues coding sensors on a tire with valve extenders, the sensor should be tested on a tire valve with no extender to help isolate the problem.

22. I have an alarm, what should I do?

Answer: First, pull over safely to the side of the road. Determine which wheel has an alarm, by checking the monitor icons; determine what type of alarm you have. It could be a leaking tire, a tire that has over pressure and too much air in it related to your base pressure setting, this can happen after a long run on a sweltering day, it could be an overheating situation, etc. By checking the operating instructions, you can see the different monitor icons that are associated with each condition, a flashing red light may or may not mean you have a deflation; a message will be displayed telling you what the problem is. You will need to fix the problem before the red light will stop.

23. What is the Sleep Mode?

Answer: If the monitor is motionless for more than 15 minutes (vehicle is stationary) it will go into sleep mode to save the battery. When it detects motion again, it will come to life signifying it has come out of sleep mode. If the monitor is shut off overnight, simply switch the monitor back on and let it sync up with your sensors before your departure and your real-time tire pressure and temperatures will be displayed in about 5 to 15 minutes depending on the number of sensors that you have on the vehicle. Even if your monitor is in the sleep mode the system is always monitoring your tires and will alarm should any pressure or temperature become out of your set parameters.

24. I am getting a Sensor Low Battery alarm, what should I do?

Answer: Eventually all batteries lose power or die. The EEZ RV PRODUCTS sensor has replaceable batteries that can be easily replaced whenever needed. Please see above for detailed directions. The battery is a CR1632 watch type battery available from jewelry stores, electronics stores or on-line. On the road, a Walmart jewelry counter is the cheapest.

25. How can I test the system?

Answer: The system should frequently be tested for fast leak operation. The monitor should be placed in the driver's location, and sensors unscrewed then tightened one at a time. The fast leak alarm should operate and then reset on the monitor after the sensor is screwed back onto the valve stem.

26. Do I need a special tool to install the sensors?

Answer: The EEZ RV PRODUCTS EezTire System comes with a complimentary Anti-Theft System on each sensor. To install a sensor, you will have to use one of the two wrenches provided. You can easily remove the Anti-Theft housing by unscrewing the two halves of the Anti-Theft Housing; this will allow you to install the sensor by hand with no wrench. This can be beneficial when installing a sensor on your inside dual.

27. Can I set different pressures for each axle?

Answer: Yes

28. Can I use tire valve extensions?

Answer: It is common to use extensions, and most tire valve extenders work fine, if you have problems with sensors mounted on extenders, test the sensor on a valve stem without an extension to see if it is a sensor problem or an extension problem. Loose extender connections can sometimes cause alarms. Using extension supports with both braided and straight extensions is critical.

29. How accurate is the system?

Answer: Measurements of 1 psi need a controlled laboratory type system to be accurate. The tire pressure is accurate within +/- 1.5%. Temperature is accurate to within +/- 5-degree F. The pressures and temperatures can vary dramatically from wheel to wheel depending on many factors, such as sun shining on one side, vehicle load, castor/ camber/alignment/brake temps. Even race cars turning left all the time generate higher pressures and temps on one side. Tire gauge accuracy can vary wildly, and their quality is not dependent on their cost. Temperature compensation is a requirement in a good gauge. (Gauges that read the same at -40 & 110 degrees) slide type gauges that rely on friction are often inaccurate.

30. How much air do I put in my tires?

Answer: Always base your HIGH and LOW parameter settings on the recommended cold tire pressure for your vehicle.

31. I get an alarm when I have been stopped for a while?

Answer: In extreme cases it is possible to get a slow leak alarm after the vehicle has

been pushed hard and the tire pressure has dramatically increased and upon stopping the tire cools quickly and the pressure drops simulating semi rapid air loss. This situation is often caused by moisture condensation in the tire.

32. How is my monitor powered?

Answer: The monitor is powered by an internal rechargeable battery which holds a charge up to 10 days before requiring recharging. A cigar lighter cord AND hard wire kit comes with the base system. The battery icon for the monitor is in the lower right corner of the display. 3 bars mean that the monitor is fully charged. Charge when there is only 1 bar.

33. Does the system come with a warranty?

Answer: Yes, it comes with a 3-year limited warranty on defective parts except batteries. Please see warranty section for full details.

34. Do I have to enter special CODEs for each sensor on set-up?

Answer: Each sensor comes pr-programmed with its own unique CODE.

35. Is there anything special I need to do for winter storage?

Answer: It's a good idea to remove the sensors and monitor from your vehicle if parked for an extended time, especially in extremely cold or hot weather. Store the system in a warm location. Mark each sensors wheel position or store them in an egg carton so they can be replaced on the same wheel position to avoid having to do a new set up. Sensors use minimal power when they have no air pressure on them.

36. I have one sensor not reading, I do not have a low battery signal?

Answer: The first thing to do is check the battery with a voltmeter, it should be reading approx. 3.2V. A battery can die when the rig is parked or the monitor off preventing a low battery signal.

CAUTIONS 1. The monitor should be installed the vehicle where it does not affect normal driving.

2. The monitor should be well fixed to avoid falling off during driving.

3. Regular tire inspection and maintenance is still necessary.

4. After the system is installed correctly, the driver does not need to stare at the monitor all the time while driving. Alerts will be issued when abnormal conditions are found in the tires. *Information in this manual is subject to change without notice.

DISCLAIMER OF WARRANTY: The warranty applies to the original purchaser only. The warranty does not carry over nor is it transferable to another party. Neither the seller nor the manufacturer will be liable for any loss damage or injury directly or indirectly arising from the use or inability to determine the use of this product. Before using, the user shall determine the suitability of the product for its intended use, and the user shall assume all responsibility and risk in connection herewith. EEZ RV PRODUCTS, LLC • PO Box 25766 • Yuma, AZ 85367 United States