

Product Brochure



customerrelations@evergreenbattery.com



www.everygreenbattery.com



TABLE OF CONTENTS

PRODUCT OVERVIEW 01 page

BASIC TECHNICAL INFORMATION 01 page

APPLICATION SCENARIOS 02 page

CONNECTION TIPS 03-04 page

CHARGING TIPS 05 page

WARNING 06 page

PRODUCT OVERVIEW

Combination: **12V 400AH**

Dimension (Lx Wx H) : **10.2x 6.9x 9.6 Inch**

ABS Shell Color: **Dark Black**

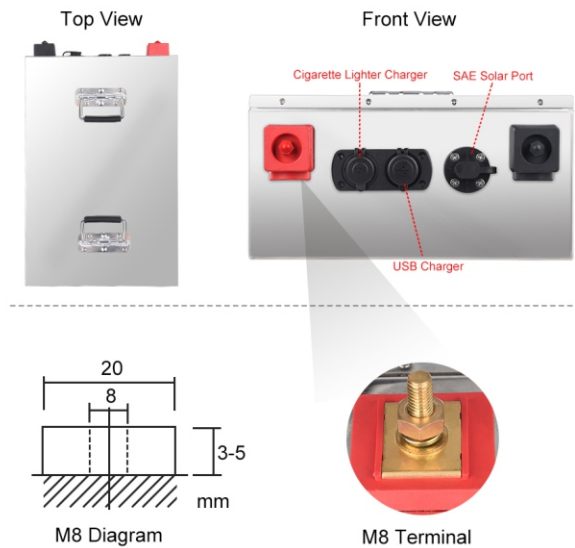











BASIC TECHNICAL INFORMATION

Working Voltage	12.8V
Charging Voltage	14.6±0.2V
Maximum Continuous Load Power	5120W
Maximum Continuous Charging Current	100A
Maximum Continuous Discharge Current	300A
Overcharge Release Voltage	3.45V±0.05V

VARIOUS APPLICATION SCENARIOS

EVERGREEN BATTERY could be your best portable energy supply and could work for years in your daily life if the battery is properly charged and well cared for.

	RVs, Caravans, Campers, Commercial Buses, Trucks, Trailers, etc.
	Wind Power Supply & Solar Power Supply
	Home Energy System
	Boating & Fishing
	Outdoor camping
	Passenger Car Audio System
	Portable Computer & Video Camera
	Electric Equipment & Telemeter Equipment
	Lighting Equipment
	Fire Alarm & Security Systems
	Toys & Consumer Electronics

CONNECTION TIPS

Conditions to connect the battery in series or in parallel:

- * Be the same battery capacity (Ah);
- * Be from the same battery brand;
- * Be newly purchased within one month.

CONNECTION METHOD



Wear rubber **insulation gloves** before connection. Make sure the gloves are dry and pay attention to safety while connecting.

How to Connect Batteries in Series?

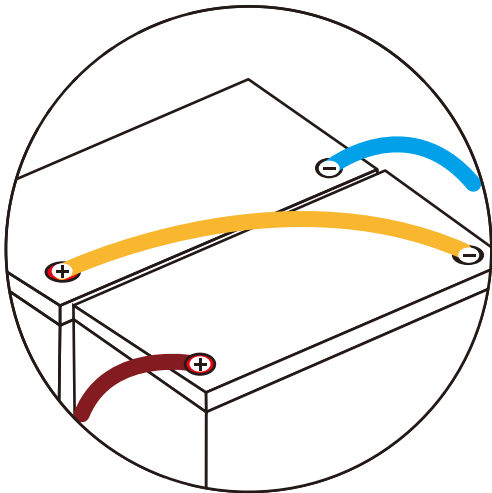

+ to **-**

After series connection, your battery system voltage will be doubled according to the batteries' quantity, you've connected.

E.g.: If you connect 2x 12V 400Ah batteries in series, the battery system will be 24V(25.6V) 400Ah.

How to Connect Batteries in Parallel?

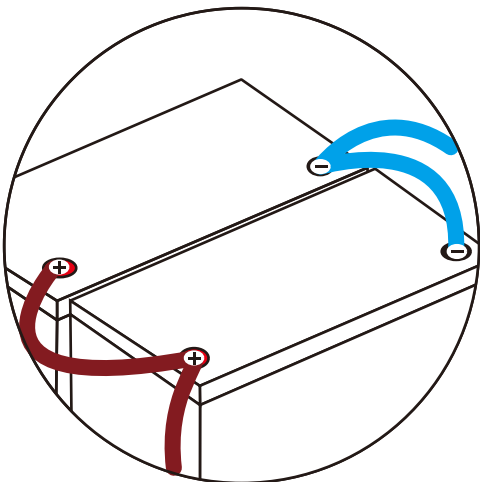

+ to **+** **-** to **-**

After a parallel connection, the battery capacity will be doubled according to the battery quantity you've connected.

E.g.: If you connect 2x 12V 400Ah batteries in parallel, the battery system will be 12V 800Ah.

How to Connect Batteries both in Series & Parallel?

Step 1 :

Connect the batteries in parallel.

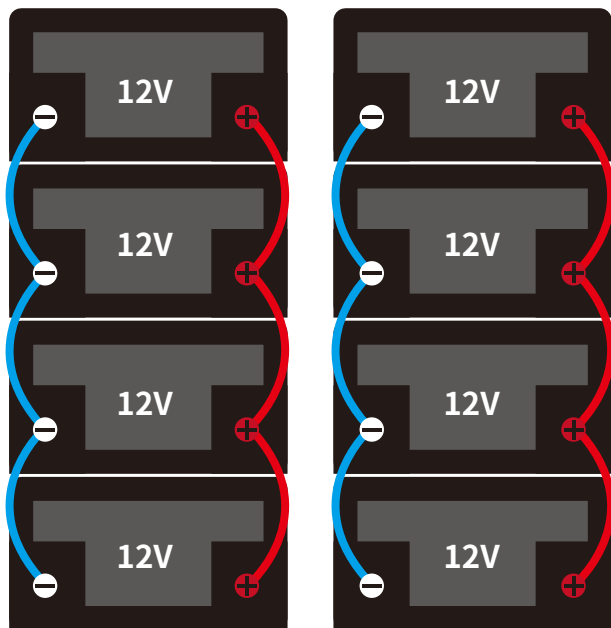

Step 2 :

Connect the paralleled batteries system in series.

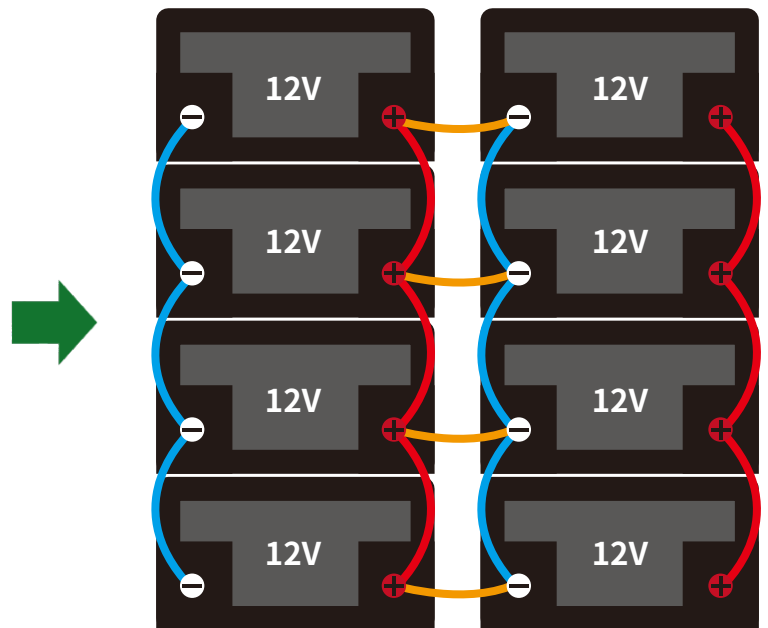

Step 3 :

Connect the battery system to the load.

Connect battery ① negative pole \ominus to the load negative, and positive pole \oplus to battery ⑧ positive pole to the load.

TIPS: To connect battery ② positive pole \oplus with battery ⑦ negative pole \ominus as steps above could achieve the same effect.

NOTE: Please don't connect battery ① positive pole \oplus with the load positive pole. Since battery ① positive pole \oplus is in series connection with battery ②. Battery system failure may occur due to a wrong connection.

Load(-)

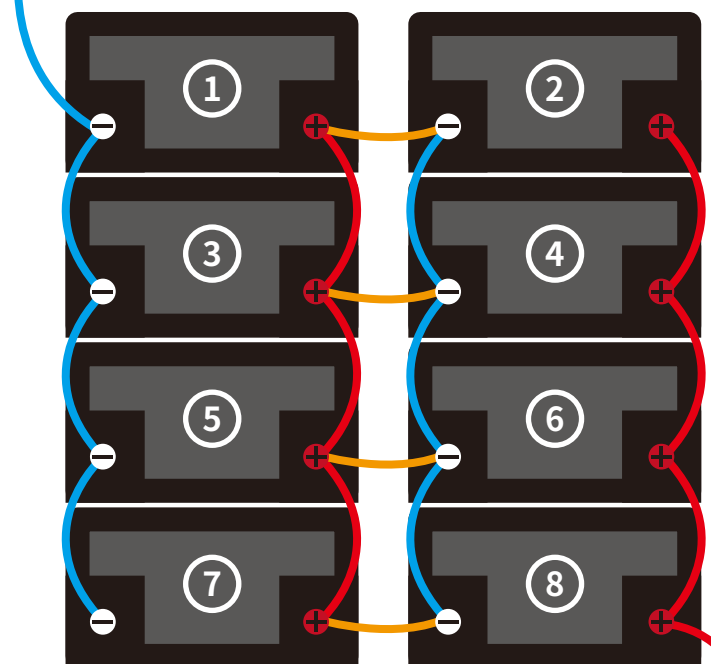

Load(+)

PLEASE DO NOT CONNECT THE BATTERIES IN REVERSE ORDER.

E.g.: Connect 4x 12V 400Ah batteries for a 24V 800Ah battery system.

Step 1: Connect the two batteries separately in parallel for 2x 12V 400Ah battery systems.

Step 2: Connect the 2x 12V 800Ah battery systems in series for a 24V 800Ah battery system.

CHARGING TIPS

* About Charging Voltage

Based on the characteristics of Lithium Iron Phosphate (LiFePO₄) batteries, the voltage measured by all LiFePO₄ batteries during charging is not the real voltage of the batteries. Therefore, the battery voltage will drop gradually to its real voltage after charging and disconnecting from the power source.

If there is remand to measure the battery real voltage, please charge and disconnect the power supply and make the batteries be still for over 15 minutes, then you could start to measure the real voltage.

* Charging the Batteries

Use 14.6V lithium iron phosphate (LiFePO₄) battery charger to maximize the capacity.

Recommended charging voltage: **Between 14.2V to 14.6V**

Recommended charging current:

20A (0.2C) The battery will be fully charged within about 5 hours to 100% capacity.

50A (0.5C) The battery will be fully charged within about 2 hours to 97% capacity.

Inverter / Controller

* Select “12V (14.6V) LI (LiFePO₄) Mode” or

* Select “Use Mode” to enter values according to the below parameters.

CHARGING	Charging Limit Voltage	14.6V
	Over Voltage Disconnect Voltage	15V
	Over Voltage Reconnect Voltage	14.2V
	Equalizer Charging Voltage	14V
	Float Charging Voltage	13.8V
	Boost Charging Voltage	13.8V
DISCHARGING	Boost Reconnect Charging Voltage	13.2V
	Low Voltage Disconnect Voltage	10.8V
	Low Voltage Reconnect Voltage	12.4V
	Under Voltage Warning Voltage	11.6V
	Under Voltage Warning Disconnect Voltage	12V
	Discharging Limit Voltage	10.4V
	Over-Discharge Disconnect Voltage	10.4V
	Over-Discharge Reconnect Voltage	11.6V
Over-Discharge Delay Time	0.8s	

NOTE: Battery will stop charging when the temperature is below 0 centigrade. Meanwhile, the heating function will be turned on automatically. But please don't worry, the charging function will be turned on when the temperature goes over 10 centigrades.

Performance Characteristics

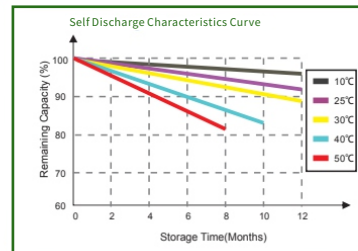
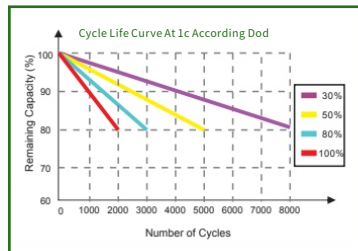
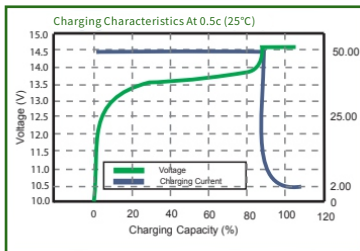
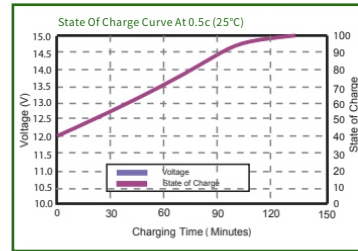
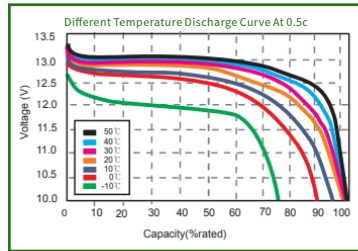
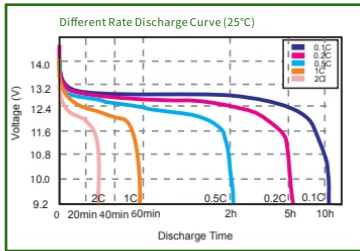

WARNINGS

BATTERY DISPOSAL

The electrodes of the wasted battery should be wrapped in insulation paper to avoid fire and explosion.

PROHIBITION OF DISASSEMBLY

Never disassemble the cells.

The disassembling may generate an internal short circuit in the cell, which may cause gassing, firing, explosion or other problems.

The electrolyte is harmful.

Li-Fe battery should not have liquid from electrolyte flowing, but in case the electrolyte come into contact with the skin, or eyes, physicians shall slut the electrolyte immediatly with fresh water and medical advice is to be sought.

PROHIBITION OF DUMPING OF CELLS INTO LIQUID

Do not soak the battery in the liquid, like water, seawater, non-alcoholic drinks, fruit juice, coffee or other liquid.

PROHIBITION OF USE OF DAMAGE CELLS

If any abnormal features of the cells are found such as damage in a plastic envelope of the cell, deformation of the cell package, smelling of an electrolyte, an electrolyte or leakage and others, the cell shall never be used anymore.

The cells with a smell of the electrolyte or leakage should be placed away from the fire to avoid firing or explosion.

PROHIBITION OF USING IN BELOW ENVIRONMENT

Do not use the batteries in a place with strong static electricity and strong magnetic field, otherwise it is easy to damage the battery safety protection device and bring hidden danger.

NOTE:

This limited warranty does not cover any damage due to:

- (a) transportation;
- (b) storage;
- (c) improper use;
- (d) failure to follow the product instructions or to perform any preventive maintenance;
- (e) modifications;
- (f) unauthorized repair;
- (g) normal wear and tear; or
- (h) external causes such as accidents, abuse, or other actions or events beyond our reasonable control.



Bluetooth Application Download
for IOS System



Bluetooth Application Download
for Android System